



HAL
open science

ONERA test Facilities for Combustion in Aero Gas Turbine Engines, and Associated Optical Diagnostics

A. Cochet, V. Bodoc, C. Brossard, O. Dessornes, C. Guin, R. Lecourt, M. Orain, A. Vincent-Randonnier

► **To cite this version:**

A. Cochet, V. Bodoc, C. Brossard, O. Dessornes, C. Guin, et al.. ONERA test Facilities for Combustion in Aero Gas Turbine Engines, and Associated Optical Diagnostics. Aerospace Lab, 2016, 11, 16 p. 10.12762/2016.AL11-01 . hal-01368208

HAL Id: hal-01368208

<https://hal.science/hal-01368208v1>

Submitted on 19 Sep 2016

HAL is a multi-disciplinary open access archive for the deposit and dissemination of scientific research documents, whether they are published or not. The documents may come from teaching and research institutions in France or abroad, or from public or private research centers.

L'archive ouverte pluridisciplinaire **HAL**, est destinée au dépôt et à la diffusion de documents scientifiques de niveau recherche, publiés ou non, émanant des établissements d'enseignement et de recherche français ou étrangers, des laboratoires publics ou privés.

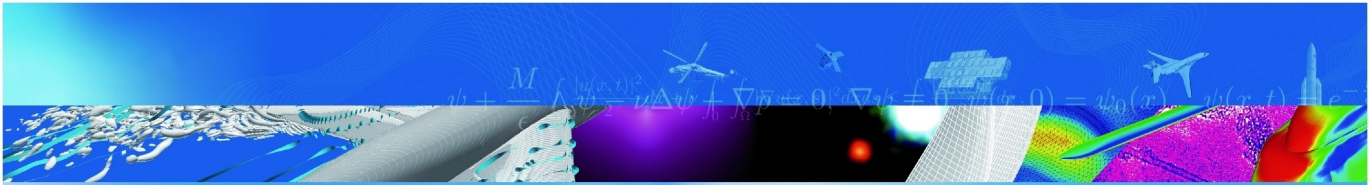

ARTICLE DE REVUE

**ONERA test Facilities for
Combustion in Aero Gas Turbine
Engines, and Associated Optical
Diagnostics**

A. Cochet, V. Bodoc, C. Brossard, O. Dessornes,
C. Guin, R. Lecourt, M. Orain, A. Vincent-Randonnier

AEROSPACELAB JOURNAL

No 11, AL11-01, 16 pages

TP 2016-548

70 2016
ans

ONERA

THE FRENCH AEROSPACE LAB

A. Cochet, V. Bodoc
C. Brossard, O. Dessornes,
C. Guin, R. Lecourt
M. Orain, A. Vincent-Randonnier

(ONERA)

E-mail: alain.cochet@onera.fr

DOI : 10.12762/2016.AL11-01

ONERA test Facilities for Combustion in Aero Gas Turbine Engines, and Associated Optical Diagnostics

The aim of this paper is to provide an overview of the ONERA test facilities devoted to the study of combustion in gas turbine engines. The objectives of the experimental studies performed with these test rigs are very ambitious and extend from building databases for the validation of codes and models used in numerical simulation to applied research for evaluating the performance of advanced aero injection systems in mono-sector, multi-sector or full annular combustion chambers. For more than ten years, aside from standard measurements (i.e., pressure, temperature, mass flow rates, gas analysis sampling), optical diagnostics have been widely associated with the test campaigns carried out in these rigs. Many optical methods are now very commonly used to measure for instance flow velocity fields, size and velocity of droplets, and the location of combustion zones. Other methods that are more difficult to implement, or still under development, are being increasingly used or proposed for measuring physical or chemical parameters, such as temperature, size of soot particles or concentration of combustion products. Examples of the results obtained with the ONERA test facilities and optical diagnostics are given, in order to illustrate the studies presented in this paper.

Introduction

In the coming years, air transport will face societal and environmental challenges requiring cleaner and more efficient aero-engines to be designed. The development of advanced combustors is based on reliable numerical tools and high-class experiments involving a great amount of physical and chemical phenomena, such as combustion in a two-phase flow with complex chemistry, pollutant formation, or heat transfer and radiation. Experiments must thus be performed under thermodynamic conditions representative of those encountered in true engines. Test facilities capable of reproducing these specific operating conditions are available at ONERA and enable subsonic air-breathing reacting flows occurring within gas turbine based aero-engines to be studied.

These combustion test facilities are used to perform tests aimed at tuning the aero-engine injection system and combustor, building experimental databases to validate CFD codes and supporting the development of new diagnostics under harsh conditions.

Research on the injection system and combustor is being carried out in close cooperation with engines manufacturers, mainly within the framework of European projects. Reducing pollutant emissions and specific consumption, or evaluating alternative fuels for aeronautics, are some issues of interest in combustion testing with ONERA facilities.

For code validation, experimental databases must be obtained from experiments carried out in either basic configurations or very close to the true engine design and operation mode (i.e., multi-swirl injectors, multipoint fuel injection, pilot + main fuel injection).

For these experiments, various measurements are applied to characterize non-reacting and reacting flows inside aero-combustors. Aside from standard measurements using, for instance, pressure transducers, thermocouples, a gas sampling probe and an analyzer, optical diagnostics are increasingly being used. Their continuous development made it possible to achieve non-intrusive measurements of a very large set of physical and chemical quantities, such as gas velocities, soot

particle or fuel droplet sizes, gas concentrations, or temperatures. In order to apply these techniques, test models are equipped with optical accesses, the material of the windows being selected depending on the wavelength requirement of the applied diagnostics.

For a long time, many research centers and laboratories, in France and all over the world, have developed test facilities devoted to studies on combustion in gas turbine engines. For instance, many worldwide test facilities are listed in Reference [1] and the example of the French laboratory CORIA, located in Rouen, is detailed in Reference [2]. ONERA facilities are mostly devoted to applied research of interest for aero-engine manufacturers, although some of them are dedicated to fundamental research.

This article is aimed at providing an overview of the experimental test facilities of ONERA at its Palaiseau and Le Fauga-Mauzac centers. Each test facility will be briefly described and examples of fundamental and/or applied research carried out in these various facilities will be given, through the presentation of some past and recent results

obtained. Optical measurements used to perform these studies will be also mentioned.

Test facility general features

Simulation of representative test conditions on test rigs

Aero-combustor testing requires facilities that are capable of simulating aero-thermodynamic conditions at the inlet of the combustion chamber; that is to say, downstream from the compressor. Chamber pressure, inlet temperature and injection system global equivalence ratios are the governing parameters to be respected for a representative simulation of the combustion chemical reactions inside the combustor. The air mass flow rate depends on the size of the combustor to be tested and is directly linked to the Reynolds number to be reproduced in the experiments. In addition, it is essential to obtain a convective Damkhöler number very close to those of real aero-engines.

BOX 1 – Combustor inlet air temperature versus compressor overall pressure ratio

The compressor overall pressure ratio P_2/P_1 and the temperature at the inlet of the combustion chamber are linked by Relation (1) at sea level

$$T_2 = T_1 \times \left[\frac{P_2}{P_1} \right]^{\frac{1}{\eta_p} \left(\frac{\gamma-1}{\gamma} \right)} \quad (1)$$

γ : heat capacity ratio

η_p : polytropic efficiency

T_2 : total temperature at the compressor outlet and at the combustor inlet

T_1 : total temperature at the compressor inlet (here, $T_1 = 288$ K)

P_2 : total pressure at the compressor outlet and at the combustor inlet

P_1 : total pressure at the compressor inlet

Figure B.1 shows the air temperature at the entrance of the combustion chamber vs. the overall pressure ratio under a sea level operating condition.

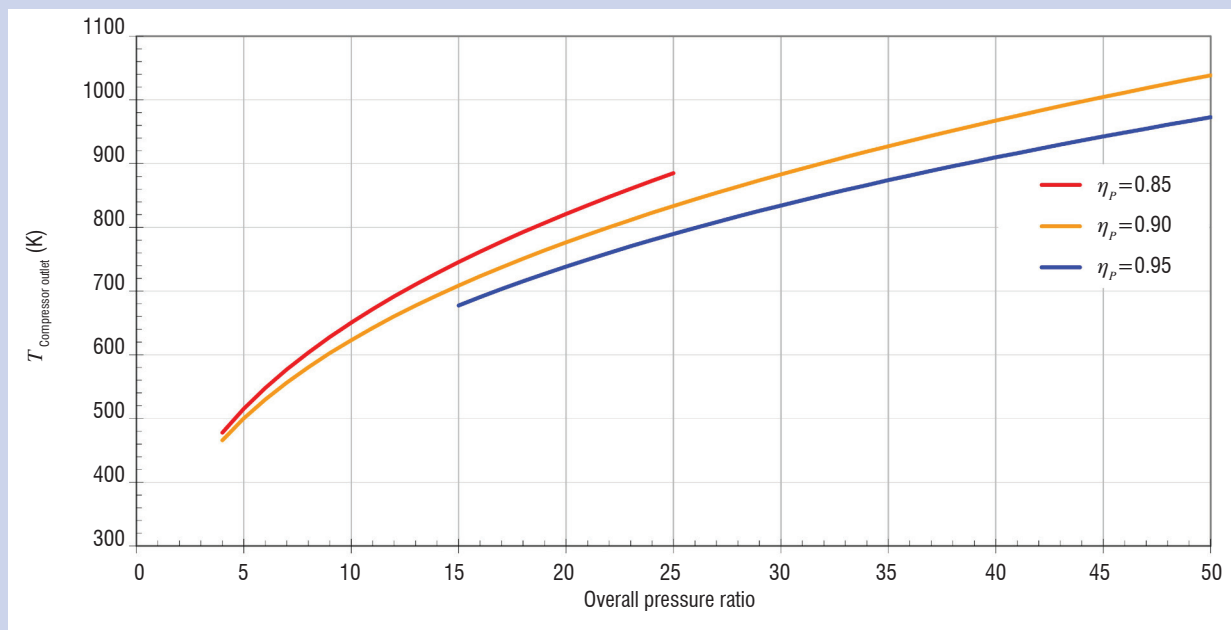

Figure B.1 - Air temperature at the compressor outlet vs. overall pressure ratio under a sea level operating condition for different values of polytropic efficiencies

In addition to the thermodynamic conditions attainable in each test rig, the nature of the phenomena under investigation can make the difference between the purposes of each test facility. For example, the ONERA/Le Fauga-Mauzac test facilities are focused on the characterization of the spray generated from advanced injection systems, whereas the ONERA/Palaiseau test facilities are more devoted to combustion studies with the same injection systems. Experimental data obtained with the facilities of each center are complementary and are both used for code and model validation.

Whatever the purpose of the studies taking place, the various test rigs are operated with connected pipes and in non-vitiated air, in order to investigate combustion in a fully representative chemical environment. One of the challenges to perform this kind of test is to provide the air mass flow rate at the right chamber pressure and inlet temperature (for instance, a pressure combustion chamber of 4.0 MPa corresponds roughly to an inlet temperature of 900 K). Regarding air heating, two technical options are mainly used. The first is a heat exchanger, in which the air mass flow rate is heated through a hot flux generated by air/hydrocarbon combustion inside a slave burner. The second is an electrical heater, in which the mass flow is heated using electric rods immersed in the air that supplies the test rig. In addition, gaseous or liquid fuel distribution lines are available, depending on the purposes of the studies. Some specific tanks can be implemented to operate the combustors with alternative fuels.

ONERA test facilities

As mentioned in the introduction, the test facilities described in this article are located at:

- ONERA/Le Fauga-Mauzac center: MERCATO and LACOM test rigs;
- ONERA/Palaiseau center: micro-combustion laboratory, EPIC-TETE test rig at LAERTE facility, M1 and MICADO (1 and 2) test rigs at the Aerothermodynamics Laboratories.

Test facilities are mainly characterized by the minimum and maximum chamber pressure, inlet temperature and air mass flow rate that they are capable of simulating. The maximum test duration depends on the test conditions (air mass flow and pressure) and air supply capabilities (continuous air flow up to 10 kg/s at 1.0-1.2 MPa and high pressure storage of 21 tons at 25 MPa). Table 1 summarizes the test facilities that are of interest in this paper with their operating condition ranges. They are listed according to increasing thermal power supplied to the test line.

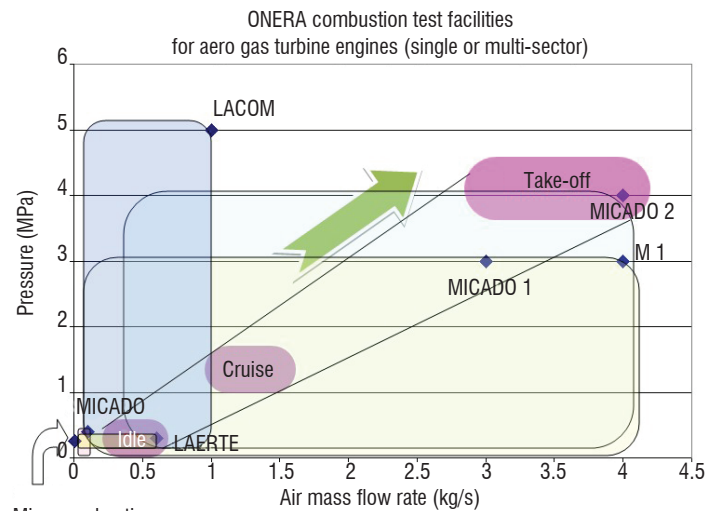

Figure 1 - ONERA test facility operating conditions shown in a pressure-air mass flow rate diagram

Additionally, Figure 1 shows the position of each test facility listed in Table 1 in a Pressure - Mass flow rate diagram. In this diagram, typical pressure domains, corresponding to the operating conditions of an actual aero-engine with mono-sector or multi-sector combustor, are shown. It can be seen that most test facilities are well suited to the high-pressure operating conditions typical of new combustors,

Test bench	Minimum air mass flow rate (kg/s)	Maximum air mass flow rate (kg/s)	Minimum pressure (MPa)	Maximum pressure (MPa)	Minimum air inlet temperature (K)	Maximum air inlet temperature (K)	Maximum air supply power (MW)
Microcombustion test bench*	0.0002	0.005	0.1	4	293	293	0
MERCATO	0.01	0.1	0.05	4	233	473	0.0246
EPIC-TETE test bench (LAERTE facility)	0.08	0.6	0.1	3	293	600	0.194
LACOM	0.1	1	0.1	50	293	900	0.68
MICADO 1 (ATD laboratories)	0.5	3	0.1	30	250	900	2.19
M1 (ATD laboratories)	0.1	4	0.05	30	250	900	2.91
MICADO 2 (ATD laboratories)	0.5	4	0.1	40	250	900	2.91

* No air preheating

Table 1 – Main Characteristics of ONERA test facilities

for either large engines in single sector studies or smaller engines in multi-sector studies. The LACOM test rig is more dedicated to studies in which the influence of very high pressure and temperature on physical phenomena is of interest, such as those of spray characteristics in two-phase flows.

Optical diagnostics applied to combustion studies

Full experimental investigation of the flow inside combustors requires visualizations and measurements of key physical quantities, such as gas velocity, gas temperature, and concentration of major and minor species, as well as droplet size, velocity and temperature in two-phase flows [3]. Due to the fact that they provide access to such quantities, optical diagnostics have become an indispensable tool. They allow a deeper understanding of the inner physical and chemical processes at play, which is required to validate and improve computer-based simulations and to assist applied research in practical combustors.

Over the past decades, optical diagnostics have been intensively used or developed at ONERA and applied to combustion test facilities. The techniques used and their proven applicability range at ONERA are summarized in Table 2.

Observation is often the first step: high-speed digital imaging of spontaneous radiation can be easily implemented on the test rigs and provides some insight into the flame structure and dynamics. In particular, by using an interference filter, OH* or CH* chemiluminescence emission signals can be isolated in order to trace reacting regions of the flow.

A whole range of laser-based techniques can then be used, depending on the quantities of interest and on optical access. Particle Image Velocimetry (PIV) has become one of the most widely used laser tech-

niques in both research institutes and industry [4]. Its major asset is its capacity to deliver a quantitative and instantaneous measurement of the velocity, not only at one point like Laser Doppler Velocimetry (LDV) does, but over a whole plane simultaneously: both visualization and quantification of the 2D flow structure become available. Two or three components of the velocity can be obtained by using one or two cameras (stereoscopic PIV), respectively. Compared to non-reacting flows, the implementation of PIV in reacting flows requires additional technical constraints to be taken into account. The seeding of the flow must be performed with small (in the micron range) solid particles (usually metal oxides, such as MgO or TiO₂). For instance, dispersing systems used to generate such particles are prone to unsteady behavior, and precautions in the operating procedure must be taken in order to limit particle deposits on the windows. Another critical issue is window access: in combustion chambers, it is usually dictated by mechanical and thermal constraints. In particular, in stereoscopic PIV each camera has to view the laser sheet with an angle of approximately 45°: this results in limitations in the measurement plane locations that can be investigated using this technique.

Planar Laser-Induced Fluorescence (PLIF) imaging is species- and quantum state-specific, and is therefore sensitive to species composition, temperature, number density and velocity [5]. The OH radical is the most commonly used flame front indicator. Applied to this radical species, PLIF, like PIV, is able to provide instantaneous information over the whole plane of the flowfield, without the line-of-sight averaging inherent to OH* chemiluminescence imaging. Simultaneous information on fuel and flame spatial distributions can be obtained with two PLIF laser systems probing OH and kerosene vapor simultaneously [6]. Additionally, by seeding the flow with adequate fluorescing tracers or probing tracers naturally present in the flow, the mixture fraction distribution can also be obtained. Recently, PLIF applied to CO molecule has been developed and successfully applied to air-breathing engine flow investigation at ONERA [7].

Optical technique	High pressure applicability limit (as proven at ONERA)(MPa)
Chemiluminescence (OH*, CH*)	6.5
Backlight imaging	6.5
Shadowgraphy	6.5
Laser Doppler Velocimetry	1.0
Phase Doppler Anemometry	1.0
Particle Image Velocimetry	0.4 (0.2 under reacting flow conditions)
Mie Scattering planar imaging	0.2
Planar Laser-Induced Fluorescence	2.3 (OH, kerosene), 0.95 (CO) at a repetition rate of 10 Hz, 0.1 (OH) at a repetition rate of 10 kHz
Rayleigh scattering	0.5
Raman scattering	0.5
Coherent Anti-Stokes Raman Scattering	6.5 (N ₂ , H ₂) at a repetition rate of 15 Hz, 0.1 (N ₂) a repetition rate of 1 kHz
Tunable Diode Laser Absorption Spectroscopy	0.2

Table 2 – Optical techniques applied at ONERA on large-scale combustion rigs

Laser spectroscopy based on nonlinear processes is widely used, from the near IR to the near UV, in order to probe reactive media. Among others, Coherent Anti-Stokes Raman Scattering (CARS) was developed at ONERA and extensively used for temperature measurements in harsh reactive environments of interest in the aerospace field [8]. The basic principle of temperature measurements by CARS is to probe the relative population of the molecular levels, from which the thermodynamic temperature of the molecular system is drawn. Consequently, the concentration of the probed species can also be deduced [9].

When studying two-phase flows, preliminary visualization of the fuel spray structure is usually performed. Instantaneous spatially resolved Mie scattering planar imaging can be obtained by illuminating the spray with a pulsed laser sheet. When using high-speed lasers and cameras, this technique also provides valuable insight into the spray dynamics. It also enables the identification of regions of interest where further measurements should be conducted. Phase Doppler Anemometry (PDA) is a well-known technique that enables a local simultaneous measurement of the droplet size and velocity distribution. ONERA, in cooperation with CNRS, has developed new optical diagnostics in order to characterize the dispersed liquid phase in sprays in terms of droplet temperature, size and velocity. In particular, important work has been done on measuring the mean and local droplet temperature, by coupling Standard Rainbow Refractometry (SRR) and Laser Induced Fluorescence (LIF) for a monodisperse droplet stream [10]. Local characterizations of the discrete phase inside a polydisperse spray have also been carried out by the simultaneous use of the Global Rainbow Refractometry (GRR) method and the PDA technique.

Optical diagnostics have continued to evolve very fast thanks to permanent progress in laser technologies, electronic imaging systems and processing algorithms. In particular, the development of high frequency lasers and cameras have enabled the repetition rates of planar laser imaging techniques, such as PIV or PLIF, to be taken from the hertz to the kilohertz range in the last few years. Some developments are currently in progress at ONERA to increase the performance of laser diagnostics. A new femtosecond CARS system is being developed at the Physics and Instrumentation Department, in order to also increase the repetition rate of this technique from the hertz to the kilohertz range [11]. Through a tight cooperation between the Modeling and Information Processing Department and the Fundamental and Experimental Aerodynamics Department, considerable progress has been made in the development of fast and efficient algorithms for tomographic PIV, thus enabling velocity vectors to be measured simultaneously in an entire volume rather than only in a plane [12]. Even though reliable use of this technique in reacting flows remains challenging, these developments open up new capabilities and perspectives of spatial-temporal experimental measurements never reached so far. The combination of several optical diagnostics on the same test facility should also be examined in the future, in order not only to obtain different physical quantities simultaneously, but also to reduce the number and cost of experiments.

Finally, one of the main challenges will be to adapt or develop optical diagnostics capable of operating under higher temperature and pressure conditions more representative of real industrial combustors. The new MICADO test facility at ONERA will serve that purpose (see the MICADO section in this article). The maximum targeted chamber pressure is 4.0 MPa. At such pressure levels in reacting flows, signi-

ficant light reabsorption or beam steering effects will exist. For PIV, for instance, so far tests under reacting flow conditions have been conducted at ONERA in studies with chamber pressure levels limited to 0.2 MPa [13-15]. One of the main challenges will be to adapt the PIV technique so that it can be used at chamber pressure levels as high as possible. In particular, beam steering is one of the issues that must be addressed. The beam steering effects, generated by optical index gradients in the combustion chamber, result in image blurring and could be very significant in highly turbulent flows at high chamber pressures.

Description of the test facilities

Micro-combustion test rig

This facility has been developed by ONERA in order to study an ultra-micro gas turbine engine that can deal with power between a few tens of watts up to some kilowatts with high specific energy and specific power. The latest portable devices or small drones use Lithium-ion (Li-ion) secondary batteries as power sources. These batteries can have relatively large power densities, but their energy densities hardly reach 200-250 Wh/kg, which limits the endurance. Charging time and very cold external temperatures may also be critical issues. Common hydrocarbon fuels have energy densities around 12 kWh/kg. A system able to convert only a small percentage of this energy density could reach higher energy densities than existing batteries. Therefore, over the past decade, and due to the increase in micro-power requirements, many efforts have been dedicated to building a micro heat engine capable of producing electricity. Micro power generators based on reciprocating engines, thermoelectric devices or thermophotovoltaic devices, Wankel engines, Rankine cycle based engines, Stirling engines, fuel cells and micro-turbines are being or were investigated. In particular, a 400 W electric micro-turbine complete system was demonstrated by IHI. This system can be refueled with simple gas cartridges. The heat management and control of the exhaust gas temperature were also demonstrated by Isomura et al. [16]. Among those systems, fuel cells should have the best efficiency, whereas the micro gas turbine should achieve the highest power density.

This is the reason why ONERA decided to focus on ultra-micro gas turbines [17] and, in this context, designed and built a micro-turbine test rig on which a micro-combustor was firstly tested (Figure 2).

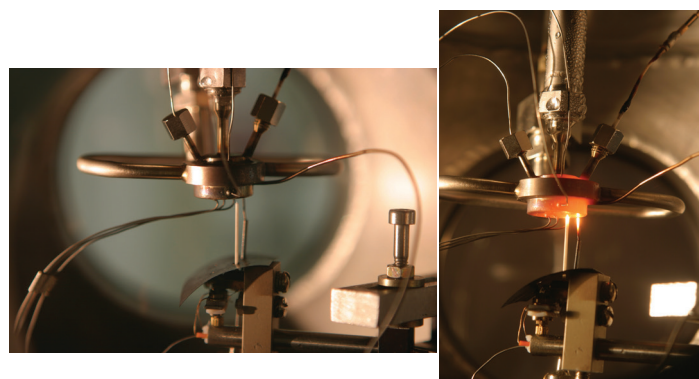

Figure 2 - Photographs of the micro-combustor

This test rig has the capacity of dealing with fuel flow rates of a few mg/s and air flow rates of up to 5 g/s. Fuels such as hydrogen, methane or propane can be used.

For the micro-combustor tests, a special vessel was designed to pressurize the flow at the nominal pressure corresponding to the pressure turbine inflow (Figure 3).

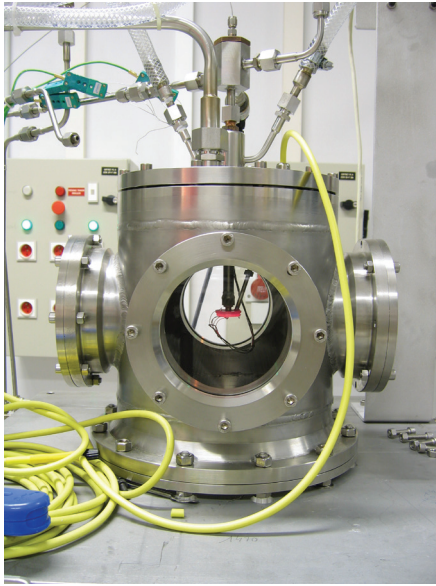

Figure 3 - ONERA micro-combustor in its vessel

Measurements such as outlet wall temperature, exhaust gas temperature and chamber pressure can be made. Special diagnostics such as infra-red thermography (Figure 4) can also be used, as well as spontaneous Raman and Rayleigh scattering (Figure 5), to obtain composition and temperature profiles at the exhaust, respectively.

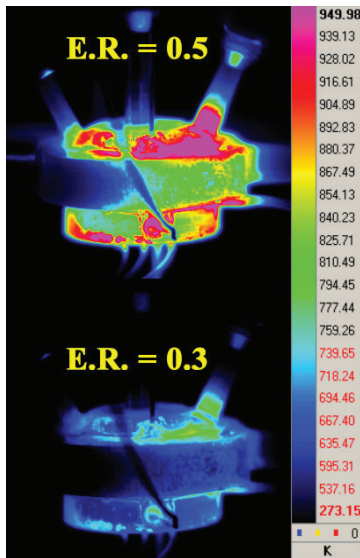

Figure 4 – Infrared thermography image example

A complete micro-turbine designed for around 50 W electric power was machined and tested (see Figure 6, the scale is given by the coin near the micro-turbine test rig) up to 170,000 rpm (2.8 kHz). At this time, its operability was demonstrated for a few watts of electric power output. In this case, in addition to the pressure and temperature measurements mentioned before, the rotation speed is also measured using Philtec optic-fiber devices connected to a high sampling rate oscilloscope. Rotation speeds up to 850,000 rpm can be measured.

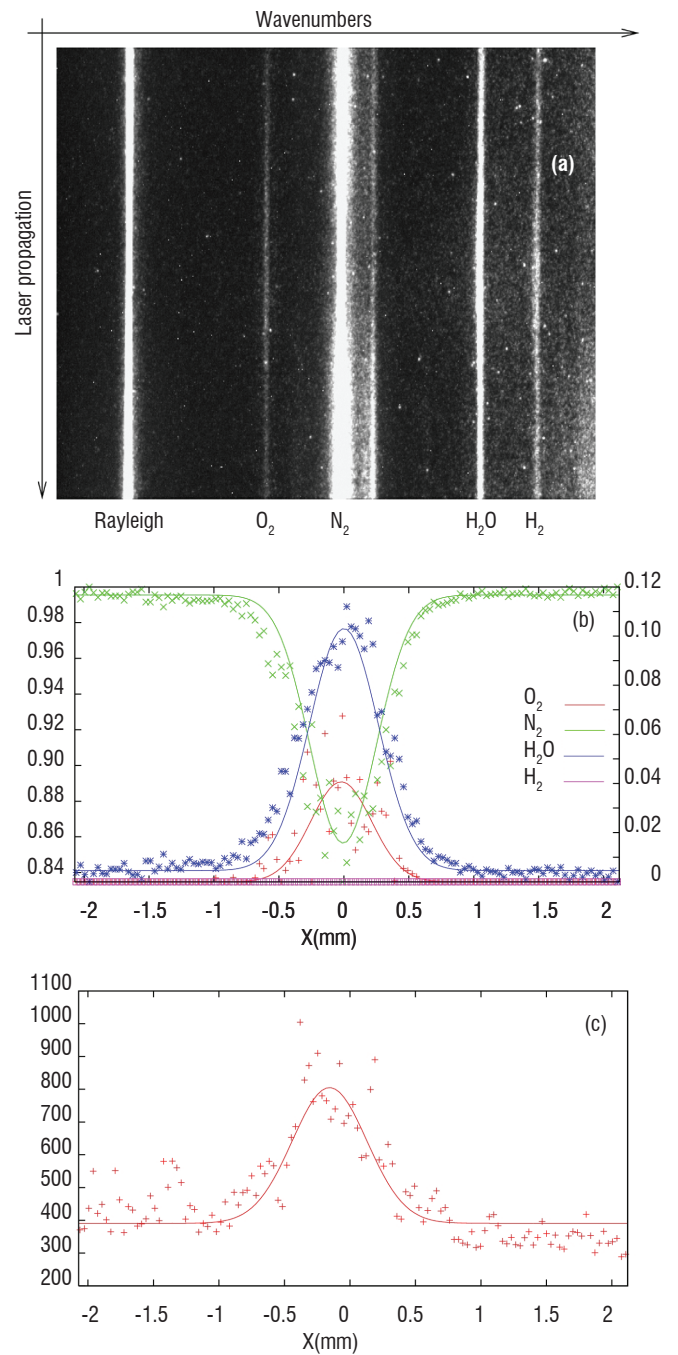

Figure 5 – Example of spontaneous Raman and Rayleigh scattering results: raw signal (a), molar fraction (b) and temperature (c)

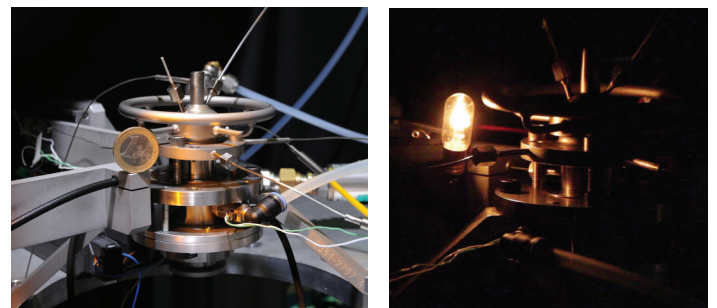

Figure 6 – Complete 50 W micro-turbine tested

MERCATO

The MERCATO (Experimental Means for Research in Air-breathing Combustion by Optical Techniques) test facility, located at ONERA/Le Fauga-Mauzac and shown in Figure 7, is a small air-breathing propulsion research facility. Air and fuel are supplied at low flow rates, up to 100 and 10 g/s respectively, but in a wide range of temperatures from 233 K to 473 K for air and from 233 K to ambient for fuel. Air is cooled through an Air/LN₂ (liquid nitrogen) cooling tower and fuel is cooled through a cooling bath. The pressure in the test chamber can be varied from 0.05 MPa to around 0.4 MPa. This facility has been developed and extensively used to investigate the ignition phenomenon, especially under altitude conditions [18-20], and to build an experimental database of a two-phase flow under non-reacting and reacting conditions [21, 22].

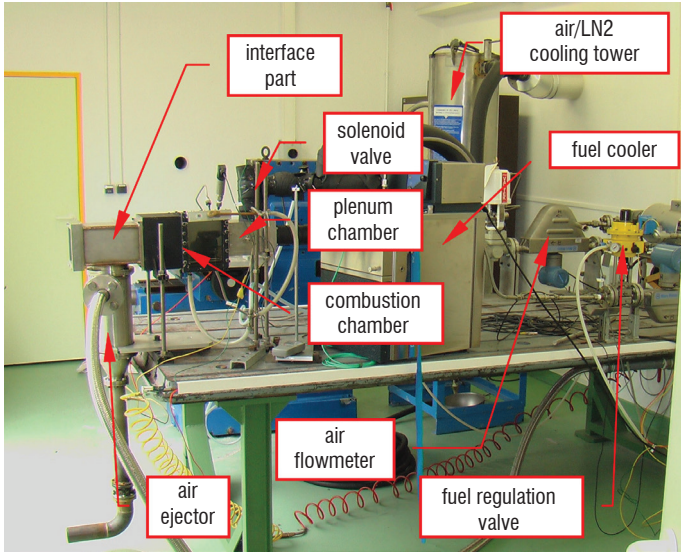

Figure 7 – MERCATO test rig

Concerning the ignition phenomenon in turbojet engines, a recent investigation [20] has been performed on the ignition performances of various alternative fuels according to their aromatic content, given in Table 3. The tests were performed inside the mono-sector combustion chamber shown in the photograph in Figure 7. The experiments were carried out under altitude conditions, at an air pressure of 0.06

MPa and an air temperature of 233 K (-40°C), which corresponds to a cold start at about 4000 m altitude.

The results are summarized in the graph in Figure 8, which shows the global equivalence ratio needed for ignition vs. the fuel blend, designated by its acronym on the horizontal axis. This graph shows how the ignition performance, i.e., the boundary limit (red dash), evolves according to the fuel composition.

FUEL	AROMATICS (%)	ACRONYM
Jet A-1	20.6	JETA
SPK	2.5	SPK
Jet A-1 + SPK	8	SPK08A
SPK + Aromatic cut	20.6	SPK20AC
SPK + Aromatic cut	8	SPK08AC
Aromatic cut	100	AC

Table 3 – Fuel compositions investigated in the ignition performance tests

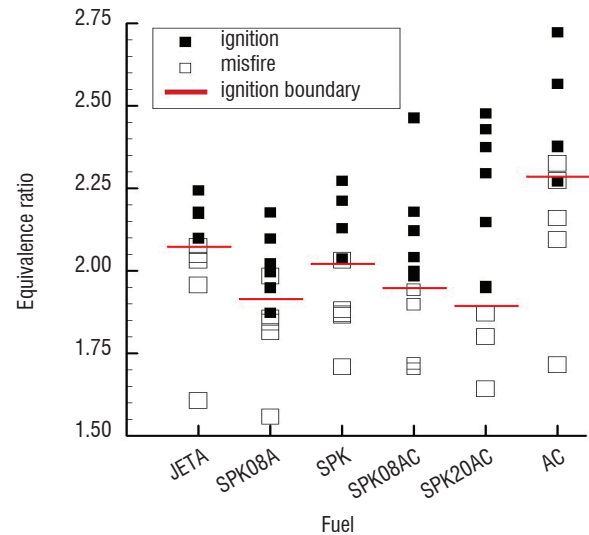

Figure 8 – Ignition performance test results

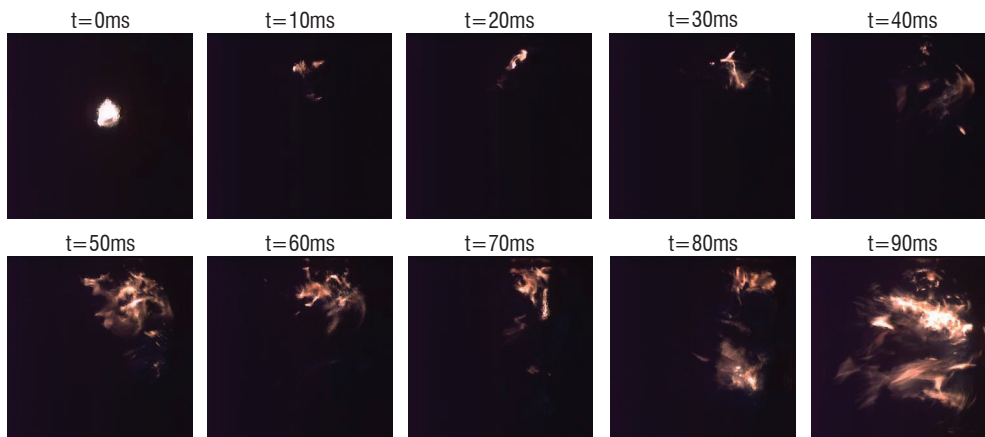

Figure 9 – Ignition sequence recorded with a high speed camera; 1 kHz frame rate, 130x130mm² image size

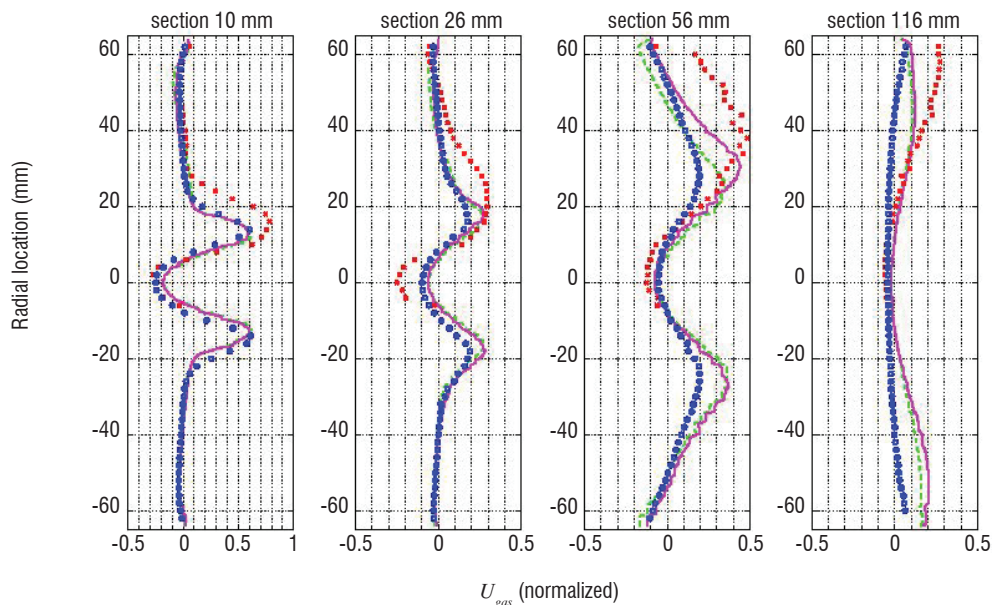

Figure 10 – Gaseous phase mean velocity profiles (axial component)

- experimental non-reacting
- experimental reacting
- numerical reacting Arrhenius scheme
- numerical reacting Cramer scheme

During this kind of experiment, a high-speed camera (1 kHz frame rate) is often used to visualize the ignition occurrence and flame propagation. The images, reported in Figure 9, are then processed in order to measure some characteristics of the ignition: burning kernel trajectory and size evolution.

The need for deeper knowledge on two-phase flow characteristics before, during and after ignition, has motivated the detailed characterization of these flows under non-reacting and reacting conditions, sometimes during short ignition experiments. These flow characterizations were performed by using LDA, PDA and PIV laser diagnostics. A comprehensive database [21,22] was built on the mono-sector configuration, which has been used extensively [23-25] for different section lengths. The comparison, shown in Figure 10, between experimental and numerical results for the gaseous axial velocity component of the stabilized reacting two-phase flow, shows that major improvements are still needed in spray combustion. For example, in 10 and 26-mm long sections (see Figure 10), the numerical results (RANS simulation, green marks and pink line) are closer to the non-reacting experimental results (blue marks) than to the reacting ones (red marks) [26] as they should be. It is planned to increase the database with vapor concentration measurements to be obtained by using LIF laser diagnostics and with drop size and velocity measurements under altitude conditions.

EPICTETE test rig (LAERTE facility)

The LAERTE facility was built in the early 1990s to develop and apply advanced optical diagnostics devoted to combustion studies of gaseous or liquid fuels (methane, Jet-A1) in high turbulence flows [27-29]. It is fed with a preheated air flow ($80 \text{ g}\cdot\text{s}^{-1} \leq \dot{m}_{air} \leq 600 \text{ g}\cdot\text{s}^{-1}$; $300 \text{ K} \leq T_{air} \leq 600 \text{ K}$; $0.10 \text{ MPa} \leq P_{ch} \leq 0.20 \text{ MPa}$) based on a heat exchanger.

The 1.4 m long combustion chamber has a $100 \text{ mm} \times 100 \text{ mm}$ square section. The air mass flow is measured upstream from the combustor inlet using a choked nozzle. The combustor walls are water cooled, thus allowing long duration tests. Large optical accesses ($100 \text{ mm} \times 260 \text{ mm}$ quartz windows) are used to perform optical diagnostics. A flush-mounted spark igniter is inserted through the lower combustor wall. An exit nozzle equipped with a throttling plug is connected downstream from the combustor to control the chamber pressure (moving this plug also modifies the acoustic impedance).

In the EPICTETE configuration of the rig, the combustor is equipped with a single-swirl injector (Turbomeca Makila DLN; roughly the same injector as for PRECCINSTA experiments [30]). Fuel can be injected via the pilot or main fuel supply (non-premixed or premixed conditions, respectively). Various diagnostics were implemented in EPICTETE experiments, most of them with $\dot{m}_{air} = 80 \text{ g}\cdot\text{s}^{-1}$, $T_{air} = 400\text{--}450 \text{ K}$ and $P_{ch} = 0.20 \text{ MPa}$. For these conditions, the reduced mass flow rate almost corresponds to the normal use of this industrial injector ($7\text{--}8 \text{ kg}\cdot\text{s}^{-1}\cdot\text{K}^{0.5}\cdot\text{MPa}^{-1}$).

For methane/air combustion, velocity measurements obtained for both the reacting and non-reacting cases by high-speed PIV (1–10 kHz) have been performed in the median longitudinal plane (3–5 mm thick laser plane; thickness imposed by the large azimuthal speed of the particles and the interframe delay of the camera). 1 kHz measurements were obtained over a $100 \text{ mm} \times 100 \text{ mm}$ field. Selecting a reduced field ($37.5 \text{ mm} \times 30 \text{ mm}$) located in the mixing layer region enabled 10 kHz measurements to be achieved to visualize time-resolved eddy convection, as can be seen in Figure 11. In the mixing region, the flow velocity can reach up to $100 \text{ m}\cdot\text{s}^{-1}$ (averaged velocity field based on 3072 samples at 1 kHz). The related fluctuating velocity is close to $50 \text{ m}\cdot\text{s}^{-1}$.

OH* and CH* chemiluminescence images have also been obtained using a high-speed intensified camera (2 kHz).

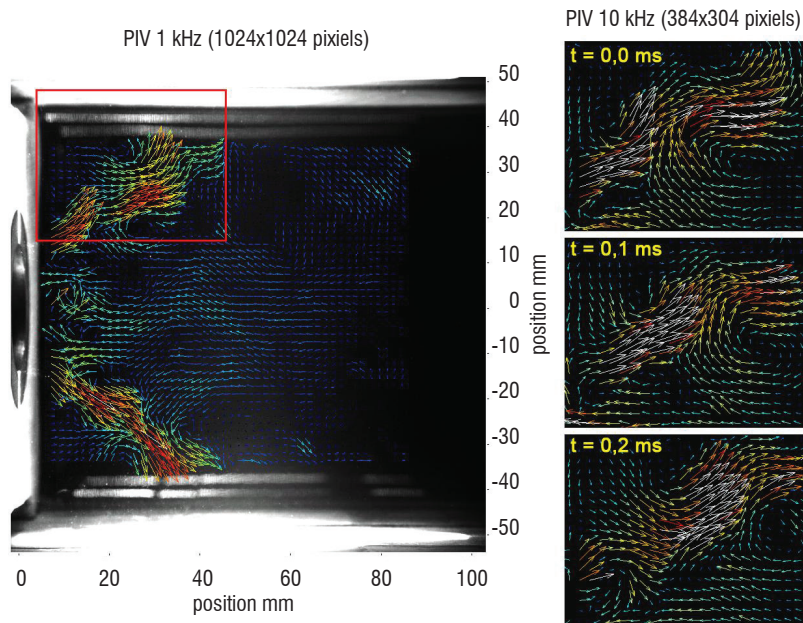

Figure 11 – Instantaneous velocity field measurements obtained with the PIV technique for methane/air combustion ($\dot{m}_{air} = 80 \text{ g}\cdot\text{s}^{-1}$; $T_{air} = 410\text{--}425 \text{ K}$; $P_{ch} = 0.20 \text{ MPa}$; $E.R. = 0.75$)

The combustion of Jet-A1 fuel was also investigated. Figure 12 shows an overview of the Jet-A/air flames for various pressure and global equivalence ratio conditions.

The kerosene spray was characterized by using high-speed Laser-Induced Mie Scattering (4 kHz) and Phase Doppler Interferometry, enabling the determination of the vortex core precession frequency (between 500 Hz and 1200 kHz depending on the test conditions).

For $T_{air} \geq 440\text{--}450 \text{ K}$ ($\dot{m}_{air} = 80 \text{ g}\cdot\text{s}^{-1}$; $P_{ch} = 0.20 \text{ MPa}$), occurrences of a combustion instability behavior have been observed: change of the kerosene spray and flame shapes, strong pressure fluctuation ($\pm 3\%$), sudden shift of the PVC frequency from 830 Hz to 1125 Hz.

Finally, a specific module including thin-layer based fluxmeters was developed at ONERA to estimate the heat flux density at the wall of the combustor (from 70 to 290 $\text{kW}\cdot\text{m}^{-2}$, depending on measurement location and test conditions).

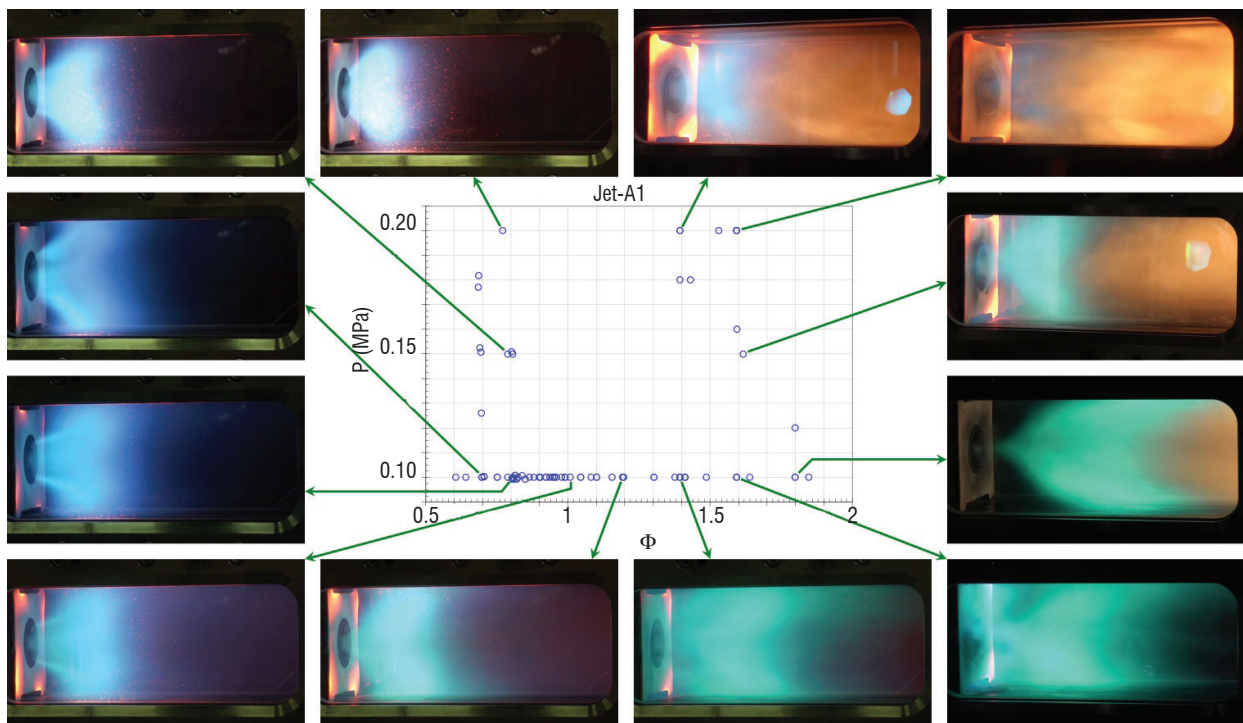

Figure 12 – Overview of the Jet-A/air flame for various pressure and global equivalence ratio conditions ($T_{air} = 400\text{--}450 \text{ K}$; $\dot{m}_{air} = 80 \text{ g}\cdot\text{s}^{-1}$)



Figure 13 – LACOM test facility

The Multiphase Combustion Laboratory (LACOM), shown in Figure 13, was initially designed to study the phenomena associated with the injection of liquid fuels into gas turbines under reacting and non-reacting conditions [31,32]. The test rig was designed to partially recreate the temperature and pressure conditions of a real combustor. On one hand, the experimental characterization of the liquid spray at the exit of a real scale injection system provides a reference database useful for the validation of the model implemented in numerical simulation codes. On the other hand, it finds an immediate application in the characterization of new design injectors under real conditions. The laboratory upgrades (addition of a second air feed line) enable the characterization of effusion cooling systems (i.e., based on multiperforated walls). The main characteristics of the laboratory are now detailed. The air feeding system can deliver a mass flow rate of 1 kg/s for each feed line, which can be heated through two electrical heaters of 1MW/250 kW up to 900 K/450 K, respectively.

The injection test rig consists mainly of a plenum and a test chamber. The plenum is designed to house the injection system. Thermocouples and pressure gauges are used to provide real-time values of the air and fuel temperatures and pressure. The test chamber is equipped with large windows, which allow the use of optical measurement techniques at various wavelengths without light distortion. The test chamber is water-cooled, which enables experiments to be run over long periods of time. A sonic throat, which is also water-cooled, is installed downstream from the test chamber, to allow tests at high pressure (up to 5.0 MPa). The line for the study of wall effusion cooling was designed to work at up to 3.0 MPa and to heat multiperforated material samples up to 1200 K. The cooling efficiency can be evaluated by thermocouple measurements or by infrared thermography.

Finally, the exhaust module limits the rig impact on the environment. Indeed, the air and water mixed with combustion/evaporation products are cleaned before ejection into the atmosphere. Moreover, in order to avoid noise pollution, the main part of the exhaust module is located underground.

Flow description relies on various measurement techniques, mostly based on non-intrusive optical techniques: Mie scattering, Phase

Doppler Interferometry (PDI), Particle Image Velocimetry (PIV), Laser Induced Fluorescence (LIF) and Infrared Thermography.

Research project examples

KIAI/LOTAR (Knowledge for Ignition, Acoustics and Instabilities/ Liquid-fueled ONERA ThermoAcoustic Rig)

Combustion instabilities generally lead to large pressure or velocity fluctuations inside the combustor, which can generate significant heat transfer at the combustor walls or large amplitude vibrations of the combustor structure. This can result in combustor damage, or even in its destruction. The thermo-acoustic instabilities observed in liquid-fueled combustors involve the coupling of various complex phenomena, such as spray atomization, vaporization, combustion, turbulence, chemistry, flow instabilities and acoustics. Due to their interaction, it is very difficult to understand the isolated influence of each of these phenomena. It is thus necessary to perform detailed experimental studies of the phenomenon, in order to improve the knowledge of the underlying physics in combustion instabilities and subsequently improve its modeling.

The LOTAR test rig was developed to enable combustion instabilities to be properly investigated with well-controlled boundary conditions, thanks to detailed acoustic characterization and using laser-based measurements. The experiments, performed within the framework of the European project KIAI, included the characterization of the gas flowfield, spray properties (both liquid and vapor phases), combustor acoustics and flame dynamics (flame transfer function). An example of the time evolution of the kerosene spatial distribution (liquid and vapor phases) is given in Figure 14 (a). Large spatial and temporal variations along the cycle are noticed. Similar results were observed with OH radicals and the post-processing of the images enabled the local Rayleigh index presented in Figure 14 (b) [33] to be derived.

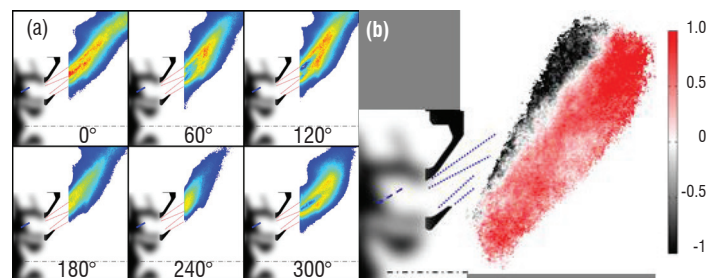

Figure 14 – Temporal evolution of the kerosene spatial distribution (liquid and vapor phases) along the limit cycle (a), Spatial distribution of the local Rayleigh index (b)

SAPHIR

Combustor walls of gas turbines are subjected to very high gas temperatures levels and must be cooled and protected by effusion cooling. The cooling air is injected through small holes, creating a protecting film along the wall. The objective of this project is to study the cooling efficiency of various perforation patterns.

The temperature distribution on the multiperforated material sample is measured by thermocouples and infrared thermography.

M1 (ATD laboratories)

M1 test rig is one of the ONERA test facilities for air-breathing propulsion studies named AeroThermoDynamics Laboratories (ATD labs). The M1 test rig with its three test lines is mainly devoted to aero-engine injection system and combustor testing. From injection system evaluation on a tubular combustor to sector or full annular combustion chamber for small engine characterization, the M1 test rig has a wide range of capabilities.

The maximum test conditions are the following:

- Air mass flow rate $0.1 \leq \dot{m}_{air} \leq 4$ kg/S
- Air temperature $250 \leq T_{air} \leq 900$ K
- Combustion chamber pressure $0.05 \text{ MPa} \leq P_{ch} \leq 3 \text{ MPa}$
- Fuel mass flow rate (kerosene) ≤ 0.25 kg/s

Air preheating is achieved by using 4 heat exchangers operating in parallel connection, each with a capacity of 1 kg/s, 900 K and 3.0 MPa. The fuel supply (kerosene) is provided at a maximum pressure of 8.0 MPa with a separate supply for each test line. Ignition is achieved by a spark igniter or a hydrogen/air torch.

Conditions of altitude relight can be simulated using a supersonic ejector connected to the combustor exit and fed with air from heat exchangers. The combustor pressure can then be decreased down to 0.05 MPa with a cold airflow (down to 250K), directly generated by high pressure storage.

A large set of measurements can be used on this test rig to obtain various physical quantities: static pressure, temperature, mass flow rate, dynamic pressure, burnt gas concentrations by gas analysis (CO , CO_2 , NO_x , HC), smoke measurements (Smoke Number, volume and mass concentrations, as well as number size distributions), and also, inside the combustor, the velocity flowfield using LDV or PIV laser diagnostics, as well as OH radical, kerosene vapor and CO concentration maps by using PLIF laser diagnostics along the axial and radial dimensions of the combustor. The CARS technique can also be used to map gas temperatures with its probability density distributions. Figure 15 shows a photograph of the test facility. This test rig was renovated between 1996 and 2000 and has been used very intensively since 2001.

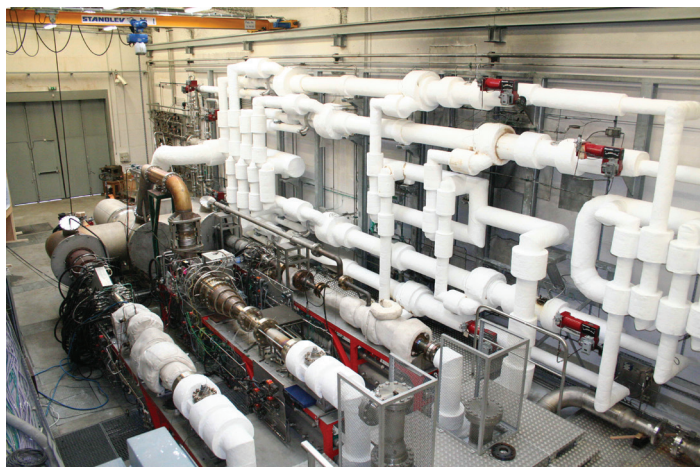

Figure 15 – Photograph of the M1 test facility

It has been involved in numerous European projects on combustion in aeronautical combustors and particularly in the evaluation

of advanced injection systems and new combustor concepts to reduce NOx emissions. For instance, many European projects, such as BRITE-EURAM, LOPOCOTEP and SIA-TEAM (soot formation) in FP5; INTELLECT-DM, TLC, NEWAC and TECC-AE in FP6; and currently LEMCOTEC and IMPACT-AE in FP7; sometimes completed by French programs such as TOSCA, have enabled LPP (Lean-Premixed-Prevaporized), RQL (Rich-Quench-Lean) and, more recently, MSFI (Multi-Stage-Fuel-Injection) technologies to be investigated and optimized for aeronautical gas turbines. Using its M1 test rig, ONERA has largely contributed to the development of these innovative combustors, some aspects of which are described below.

Research project examples

Self-ignition and flashback tests on LPP injectors [34]

LPP (Lean Premixed Prevaporized) combustors are very efficient for reducing NOx emissions, but the concept is penalized by problems of self-ignition and flashback, especially in engines with a high overall pressure ratio. Therefore, within the framework of the BRITE-EURAM program, ONERA developed a special experimental setup, equipped with a water-cooled tubular combustor, for characterizing these phenomena in a LPP injector under realistic operating conditions.

Several concepts developed by the Turbomeca, Volvo, Rolls-Royce and Snecma manufacturers were tested in the facility. The safe operating limits for each concept were determined. The limit on the air-fuel mixture residence time in the injection system to prevent self-ignition was established according to the pressure and air temperature for a global equivalence ratio of between 0.4 and 0.7.

Optical measurements on a single sector combustor equipped with a MSFI injector [35]

The MSFI concept enables two independent flames to be generated from the same injection system. Its configuration features a concentric arrangement of a main fuel stage embedded into a large swirling air stream carrying the largest part of the air mass flow, and a nested pilot injector located in the center. Both flames are swirl-stabilized. The pilot fuel is introduced by a spray nozzle in the injector axis, whereas the main fuel is injected from an annular cavity through multiple holes. The investigated injector versions mainly differed by their pilot zone.

The combustor used for these measurements was developed within the TLC research program. It is presented in Figure 16. This water-cooled visualization sector has a 105 mm × 105 mm square cross section and an 82 mm length. Its section converges upstream from the combustor exit. The volume is the same as the volume of one sector in the real Snecma annular combustor. It is equipped with three optical accesses for laser diagnostics. The thermal protection of optical windows is provided by strong air film cooling, representative of the real annular combustor.

A sonic throat, which can be partly obstructed by a water-cooled needle, enables the control of the pressure inside the combustor. Upstream from this nozzle, a sampling probe collects burnt gas and soot particles for emission measurements. These measurements were used to calibrate the Snecma and ONERA computation codes and some of them are presented in this paper [36].

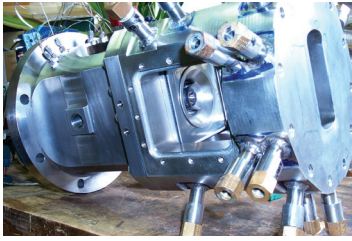

Figure 16 – Photographs of the TLC combustor

They also enabled the discovery of potential correlations between the flame structure, vapor fuel location and emission performances.

Simultaneous measurements of planar laser-induced fluorescence applied to OH and kerosene vapor, and then CARS temperature mapping were performed for various operating conditions up to a pressure of 2.2 MPa.

Optical measurements on the second and third generations of MSFI injector

Two other configurations of MSFI injector were studied within the framework of the TOSCA and TECC programs, and then the LEMCO-TEC and IMPACT-AE programs (based on a different configuration named "D8"). Various fuel distributions between the pilot and main zones have been used over the ICAO certification points. Examples of PLIF-OH, PLIF-kerosene and PLIF-CO are presented in Figure 17 for idle conditions, when only the pilot injector is operated. The main difference between the D8 and TOSCA configuration relates to the location of the pilot fuel injection. With the D8 configuration, the fuel vapor is located in the continuation of the pilot bowl, with a hollow cone-like shape. Its flame front develops on both sides of the fuel cone. With the TOSCA configuration, fuel vapor remains located at the center of the pilot zone. Its flame front develops at the periphery of the fuel zone.

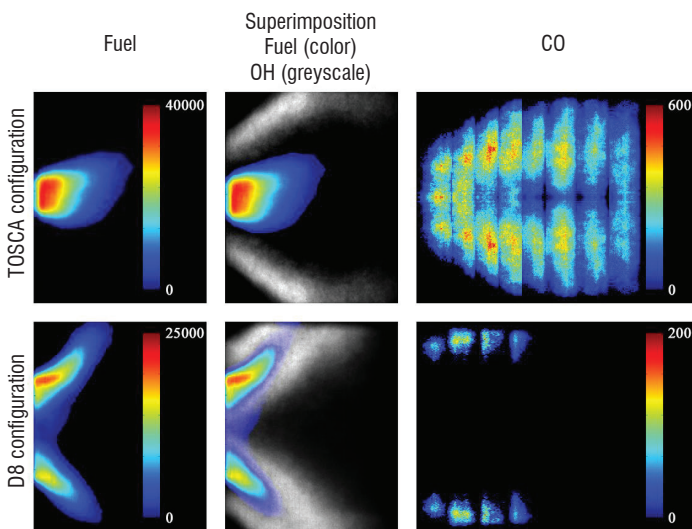

Figure 17 – PLIF mean images (400 laser shots) of OH – kerosene – CO, comparison between TOSCA and D8 configurations under idle conditions

For the D8 configuration, CO is located in the outer zone of the flame front, whereas for the TOSCA configuration it is located closer to the

axis, at the interface between the flame front and the kerosene vapor. With these new injectors, the CO emissions are three times lower than those recorded with the first injector at low power, with identical level of NO_x at high power.

Testing of a multi-sector combustor equipped with 4 MSFI injectors

In order to optimize the fuel split of MSFI injectors and evaluate pollutant emissions in an environment representative of the real engine, a multi-sector combustor was studied by Snecma. This combustion chamber was designed based on the results of the single combustor tests. It included 4 MSFI injectors and represented a 4:18 subscale section of a SAM146 type full-annular combustor (Figure 18). The two side plates of the pressure vessel were fitted with large optical accesses. A gas sampling probe, attached to a metal plate, could be implemented as a dummy window. It consisted of a flat U tube with 6 separate sampling points. A computer-controlled multiplexing system scanned each sampling point and a hydraulic actuator could move the probe through the combustor exit plane.

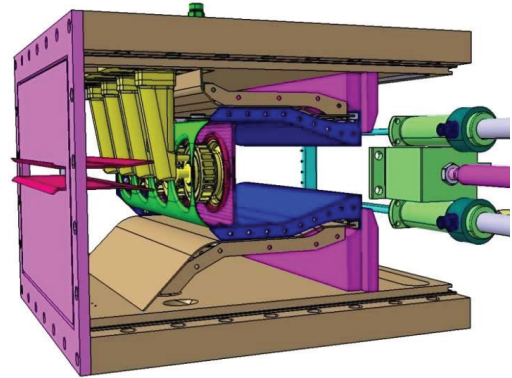
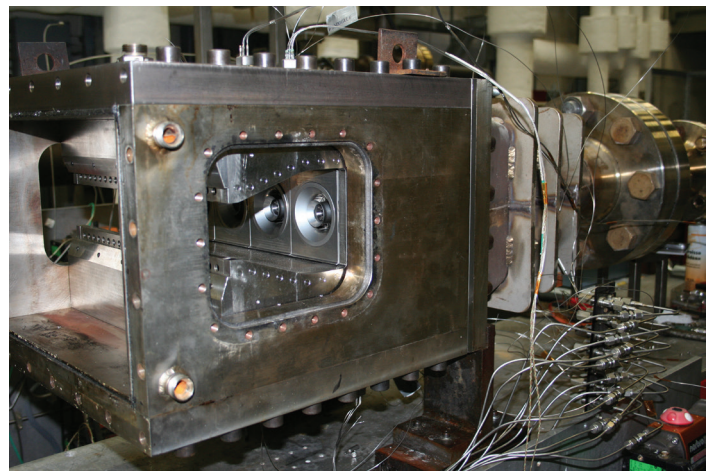

Figure 18 – Multi-sector combustor equipped with its 4 MSFI injectors

Tests on this multi-sector combustor have enabled the following:

- enhancement of the combustion chamber operability and the thermal management, in particular by the improvement of the igniter location and knowledge of the sub-atmospheric relight capability;
- evaluation of the pollutant emissions for various operability conditions and various fuel splits.

Examples of the results are presented in Figure 19 through spatial maps for NO_x indices and flame temperatures under lower take-off operating conditions.

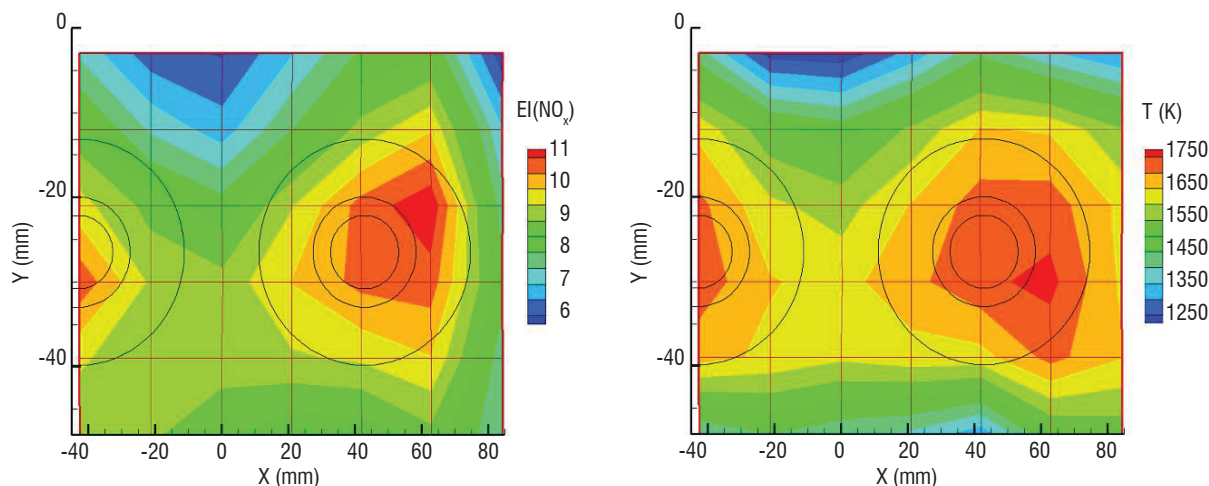

Figure 19 – Maps of local NO_x indices and flame temperatures under lower take off operating conditions

MICADO 1 and 2 (ATD laboratories)

The development of a new test rig, named MICADO, is in progress at the ONERA Palaiseau center (MICADO is a French acronym that stands for “Investigation Means for Air-breathing Combustion using Optical Diagnostics”). The current status can be visualized in Figure 20. This test rig will be dedicated to:

- the study of combustion with test conditions representative of single or multi-sector aeronautical engine combustors;
- the development of the associated advanced diagnostics (a laser control room will be built in 2016 in an adjacent room to host optical diagnostics teams).



Figure 20 – The MICADO test rig under development

The combustor will be fed with a high-pressure and high-temperature (HP-HT) air flow. For the first phase of this project (so-called “MICADO 1”), the maximum air flow conditions will be $\dot{m}_{air} \leq 3.0 \text{ kg}\cdot\text{s}^{-1}$, $T_{air} \leq 900 \text{ K}$; $P_{ch} \leq 3.0 \text{ MPa}$. Early validation tests of the HP-HT air flow delivery began at the end of 2015 with a ramjet combustor. Preliminary tests of the MICADO combustor are planned for the fall of 2016.

Further development of the HP-HT air flow delivery unit (so-called “MICADO 2”) will upgrade testing conditions to $\dot{m}_{air} \leq 4.0 \text{ kg}\cdot\text{s}^{-1}$, $T_{air} \leq 900\text{--}950 \text{ K}$, $P_{ch} \leq 4.0 \text{ MPa}$. Figure 21 shows the test conditions targeted with the MICADO test rig, and covering the aero-engine (i.e., turbojet, turboprop or helicopter turbine) flight envelope.

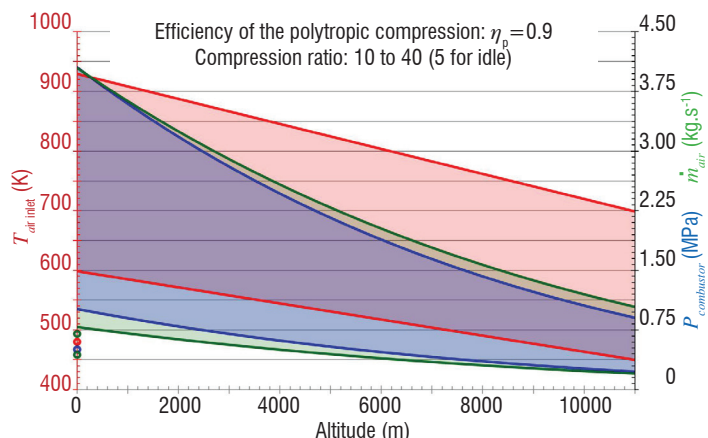

Figure 21 – Flight envelope conditions targeted with the MICADO test rig

The MICADO combustion chamber will have a $100 \text{ mm} \times 100 \text{ mm}$ square section, which almost corresponds to large engine single-sector cross-sections. This will ensure realistic conditions for the Reynolds, Damköhler and Karlowitz numbers in the combustor. The combustor will be water-cooled, thus enabling continuous running conditions. It will be fully equipped with wide optical accesses ($89 \text{ mm} \times 88 \text{ mm}$ on each wall). Air and fuel will enter the combustor through an axial single-swirl injector, fuel being injected through the main (premixed) and/or pilot (non-premixed) supplies. Fuel will either be gaseous or liquid (methane or kerosene) with $\dot{m}_{fuel} \leq 100 \text{ g}\cdot\text{s}^{-1}$ for each injection line. The swirler will be removable, in order to adjust the swirl-number if needed.

A sampling probe will enable online gas and/or soot analysis (sampling location around 140 mm downstream from the combustor dome). The chamber pressure will be adjusted by means of an exit nozzle equipped with a throttling plug.

CONCLUSION

This article provides an overview of the ONERA test facilities, both operational and under development, such as the MICADO test rig. Pressure, temperature and mass flow rates can be varied over a wide range of values and many of the test rigs allow test conditions very close to the real parameters of the aero gas turbine engines investigated. With this set of test rigs, ONERA is capable of studying combustor scales from micro gas turbine engines (0.001 kg/s) up to full annular advanced combustors for helicopter engines (4 kg/s at 2.0 MPa). These test facilities are used to carry out studies not only for industrial purposes but also for more fundamental scientific research aimed at building experimental databases on basic configurations. This last point is crucial for the validation of codes and models used for the numerical simulation of 3D turbulent reacting flows inside aerospace combustors.

Experimental tests are increasingly associated with optical measurements, visualizations (high-speed video, OH* and CH* chemiluminescence) and laser-based optical techniques (LDV, PIV, PDA, PDI, PLIF/OH, PLIF/CO, CARS, etc.). Most of these measurement methods are now developed with a high repetition rate, in order to obtain not only the mean value of the measured quantity, but also some unsteady data that are of interest in unsteady phenomena or transient stages.

Advanced injection systems and combustors, capable of running on various kinds of gaseous or liquid fuels, can be studied in the ONERA test facilities. Pollutant reduction, decrease in specific consumption, improvement of global thermal behavior, mass reduction and unsteady operation are scientific and technical topics of interest at ONERA. French manufacturers in the aerospace propulsion field, Snecma and Turbomeca are the main partners, either in the national programs or through the European Research and Development Framework Programs in which ONERA is often involved ■

References

- [1] C.D. SLABAUGH, A.C. PRATT, R.P. LUCHT, S.E. MEYER, M. BENJAMIN, K. LYLE, M. KELSEY - *The Development of an Optically Accessible, High Power Combustion Test Rig*. Review of scientific Instrument 85 (035105) 2014.
- [2] F. GRISCH, A. BOUKHALFA, G. CABOT, B. RENOU, A. VANDEL - *CORIA Facilities for Aircraft Engine Type Combustion and Associated Optical Diagnostics*. AerospaceLab, Issue 11, 2016.
- [3] F. DUPOIRIEUX - *Optical Diagnostics Used at ONERA to Characterize Turbulent Reactive Flows and to Validate Aero- and Rocket Engine Combustor Modeling*. AerospaceLab, Issue 1, December 2009.
- [4] C. BROSSARD, J.-C. MONNIER, P. BARRICAU, F.-X. VANDERNOOT, Y. LE SANT, F. CHAMPAGNAT, G. LE BESNERAIS - *Principles and Applications of Particle Image Velocimetry*. AerospaceLab, Issue 1, December 2009.
- [5] F. GRISCH, M. ORAIN - *Role of Planar Laser-Induced Fluorescence in Combustion Research*. AerospaceLab, Issue 1, December 2009.
- [6] M. ORAIN, F. GRISCH, E. JOURDANNEAU, B. ROSSOW, C. GUIN, B. TRETOUT - *Simultaneous Equivalence Ratio and Flame Structure Measurements in Multipoint Injector Using PLIF*. Comptes Rendus Mécaniques, Vol. 337, p 373-384 (2009).
- [7] M. ORAIN, C. GUIN, O. CARRIVAIN - *Measurements of Fuel, Hot Gases and Pollutant Spatial Distributions in Aeronautical Multipoint Injectors Using PLIF*. Journal of Propulsion and Power, In preparation (2016).
- [8] B. ATTAL-TRÉTOU, F. GRISCH, D. PACKAN, I. RIBET-MOHAMED, M. LEFEBVRE - *Laser Spectroscopy for in Situ Diagnostics*. AerospaceLab, Issue 1, December 2009.
- [9] M. HABIBALLAH, M. ORAIN, F. GRISCH, L. VINGERT, P. GICQUEL - *Experimental Studies of High-Pressure Cryogenic Flames on the Mascotte Facility*. Combustion Science and Technology, Vol. 178, p 101-128 (2006).
- [10] V. BODOC, C. LAURENT, Y. BISCOS, G. LAVERGNE - *Advanced Measurement Techniques for Spray Investigations*. AerospaceLab, Issue 1, December 2009.
- [11] M. SCHERMAN, M. NAFA, T. SCHMID, A. GODARD, A. BRESSON, B. ATTAL-TRETOUT, P. JOUBERT - *Ro-vibrational Coherent anti-Stokes Raman Scattering Spectroscopy in Hybrid fs/ps Regime Using a Volume Bragg Grating for N2 Thermometry*. Optics Letters, In Press (2015).
- [12] A. CHEMINET, B. LECLAIRE, F. CHAMPAGNAT, A. PLYER, R. YEGAVIAN, G. LE BESNERAIS - *Accuracy Assessment of a Lucas-Kanade Based Correlation Method for 3D PIV*. 17th International Symposium on Applications of Laser Techniques to Fluid Mechanics, Lisbon, Portugal, 7-10 July, 2014.
- [13] V. SABEL'NIKOV, C. BROSSARD, M. ORAIN, F. GRISCH, M. BARAT, A. RISTORI, P. GICQUEL - *Thermo-Acoustic Instabilities in a Backward-Facing Step Stabilized Lean-Premixed Flame in High Turbulence Flow*. 14th International Symposium on Applications of Laser Techniques to Fluid Mechanics, 2008.
- [14] A. RISTORI, G. HEID, C. BROSSARD, S. REICHSTADT - *Detailed Characterization of the Reacting One-phase and Two-phase Flow Inside a Research Ramjet Combustor*. XVIIth ISABE Symposium, Munich, Germany, 2005.
- [15] A. RISTORI, C. BROSSARD, T. LE PICHON - *Caractérisation de l'écoulement instationnaire dans un statoréacteur de recherche par PIV et visualisations OH* à haute cadence simultanées*. 14^{ème} Congrès Francophone de Techniques Laser (CFTL2014), Marseille, France, September, 2014.
- [16] K. ISOMURA - *A Promising Technology for Powering Humanoid Robots? - Development of an Ultra-compact Gas Turbine Capable of Generating Large Amounts of Power Anywhere*. Japan Quality Review 13 (2012) 24-27.
- [17] O. DESSORNES, S. LANDAIS, R. VALLE, A. FOURMAUX, S. BURGUBURU, C. ZWYSSIG, Z. KOZANECKI - *Advances in the Development of Microturbine Engine*. Journal of Engineering for Gas Turbines and Power, July 2014, vol.136, pages 1-9.
- [18] R. LECOURT, F. BISMES, G. HEID - *Experimental Investigation of Ignition of an Air-Kerosene Spray in Altitude Conditions*. ISABE-2009-1235.
- [19] A. LANG, R. LECOURT, F. GIULIANI - *Statistical Evaluation of Ignition Phenomena in Turbojet Engines*. GT2010-23229, ASME Turbo Expo 2010: Power for Land, Sea and Air, June 14-18, 2010, Glasgow, UK.
- [20] R. LECOURT - *Ignition Performances of Alternative Fuels under Altitude Conditions according to their Aromatics Content*. ISSA-2015-046, International Symposium on Sustainable Aviation May 31- June 3, 2015 Istanbul, TURKEY.
- [21] R. LECOURT, G. LINASSIER, G. LAVERGNE - *Detailed Characterisation of a Swirled Air/Kerosene Spray in Reactive and Non-Reactive Conditions Downstream from an Actual Turbojet Injection System*. GT2011-45173, Proceedings of ASME Turbo Expo 2011: Power for Land, Sea and Air, June 6-10, 2011, Vancouver, CANADA.

- [22] R. LECOURT, L. ROSSONI, S. GOYER, G. LINASSIER - *Gas Phase Velocity Measurements in a Swirled Air/Kerosene Burning Spray downstream from an Actual Turbojet Injection System*. AIAA 2014-3659, Propulsion and Energy Forum, 50th AIAA/ASME/SAE/ASEE Joint Propulsion Conference, July 28-30, 2014, Cleveland, OH.
- [23] N. GARCIA ROSA, G. LINASSIER, R. LECOURT, P. VILLEDIEU AND G. LAVERGNE - *Experimental and Numerical Study of High-Altitude Ignition of a Turbojet Combustor*. Heat Transfer Engineering, 32(11-12):949-956, 2011.
- [24] W.P. JONES, C. LETTIERI, A.J. MARQUIS, S. NAVARRO-MARTINEZ - *Large Eddy Simulation of the two-phase flow in an experimental swirl-stabilized burner*. International Journal of Heat and Fluid Flow 38 (2012) 145-158.
- [25] A. EYSSARTIER, B. CUENOT, L. Y. M. GICQUEL, T. POINSOT - *Using LES to Predict Ignition Sequences and Ignition Probability of Turbulent Two-Phase Flames*. Combustion and Flame 160 (2013) 1191-1207.
- [26] G. LINASSIER - *Etude expérimentale et numérique de l'allumage des turboréacteurs en conditions de haute altitude*. PhD thesis (2012).
- [27] P. GICQUEL, C. CLANET, P. MOREAU - *Présentation des travaux expérimentaux réalisés sur le banc A3C*. ONERA technical report RTS 56/7104 EY.
- [28] V. SABELNIKOV, C. BROSSARD, M. ORAIN, F. GRISCH, M. BARAT, A. RISTORI, P. GICQUEL - *Thermo-Acoustic Instabilities in a Backward-Facing Step Stabilized Lean-Premixed Flame in High Turbulence Flow*. 2008, 13th Int. Symp. on Flow Visualization, Nice (France).
- [29] N. FDIDA, C. BROSSARD, A. VINCENT-RANDONNIER, D. GAFFIE - *Characterization of the Kerosene Spray in a Swirl-Stabilized Flame*. 2012, International Symposium on Applications of Laser Techniques to Fluid Mechanics, Lisbon (Portugal).
- [30] W. MEIER, P. WEIGAND, X.R. DUAN, R. GIEZENDANNER-THOBEN - *Detailed Characterization of the Dynamics of Thermoacoustic Pulsations in a Lean Premixed Swirl Flame*. Combustion and Flame, 150 (2007) 2-26.
- [31] V. GUTIERREZ FERNANDEZ, G. LAVERGNE, P. BERTHOUMIEU - *Dynamic Primary Atomization Characteristics in an Airblast Atomizer, High Pressure Conditions*. Atomization and Sprays, Vol.21 - 2011, pages 1-16.
- [32] V. GUTIERREZ FERNANDEZ, G. LAVERGNE, P. BERTHOUMIEU - *Geometric Primary Atomization Characteristics in an Airblast Atomizer, High Pressure Conditions*. Atomization and Sprays, Vol.21 - 2011, pages 17-29.
- [33] J.M. APELOIG, H.X. D'HERBIGNY, F. SIMON, P. GAJAN, M. ORAIN, S. ROUX (2015) - *Liquid-Fuel Behavior in an Aeronautical Injector Submitted to Thermoacoustic Instabilities*. Journal of Propulsion and Power, 31(1), 309-319.
- [34] C. GUIN - *Characterization of Auto-Ignition and Flashback in Premixed Injection Systems*. AVT Symposium on Gas Turbine Engine Combustion, Emissions and Alternative Fuels; Lisbon, October 12-16, 1998.
- [35] F. GRISCH, M. ORAIN, B. ROSSOW, E. JOURDANNEAU, C. GUIN - *Simultaneous Global Equivalence Ratio and Flame Structure Measurements in Multipoint Injector Using PLIF*. AIAA 2008-4868; July 2008, Hartford.
- [36] F. DUPOIRIEUX, N. BERTIER, C. GUIN, K.P. GEIGLE, C. EBERLE, P. GERLINGER - *Methodology for the Numerical Prediction of Pollutant Formation in Gas Turbine Combustors and Associated Validation Experiments*. AerospaceLab, issue 11, 2016.

Acronyms

BRITE-EURAM	(Basic Research in Industrial Technologies for Europe - European Research on Advanced Materials)
CARS	(Coherent Anti-Stokes Raman Scattering)
CFD	(Computational Fluid Dynamics)
DEFA	(Fundamental and Applied Energetics Department)
DLN	(Dry Low NO _x)
DMAE	(Aerodynamics and Energetics Modeling Department)
EPICTETE	(Study Etude des Phénomènes en Combustion Turbulente Et Transferts Energétiques)
GRR	(Global Rainbow Refractometry)
ICAO	(International Civil Aviation Organization)
IHI	(Ishikawajima-Harima Heavy Industries)
IMPACT-AE	(Intelligent design Methodologies for low PollutAnt Combustors for Aero-Engines)
INTELLECT-DM	(INTtegratEd Lean Low Emission Combustor - Design Methodology)
IR	(InfraRed)
KIAI	(Knowledge for Ignition, Acoustics and Instabilities)
LACOM	(Multiphase Combustion Laboratory)
LAERTE	(Laboratory for the study of reacting flows and their investigation techniques)
LDA	(Laser Doppler Anemometry)
LDV	(Laser Doppler Velocimetry)
LEMCOTEC	(Low Emission COre TEchnologies)
LIF	(Laser Induced Fluorescence)
LOPOCOTEP	(Low POLLutant COmbustor TEchnology Program)
LOTAR	(Liquid-fueled ONERA ThermoAcoustic Rig)
LPP	(Lean Premixed Prevaporized)
MERCATO	(Experimental Means for Research in Air-breathing Combustion by Optical Techniques)
MICADO	(Investigation Means for Air-breathing Combustion using Optical Diagnostics)
MSFI	(Multi Stage Fuel Injection)
NEWAC	(NEW Aeroengine Core Concepts)
OPR	(Overall Pressure Ratio)
PDA	(Phase Doppler Anemometry)

PDI	(Phase Doppler Interferometry)
PIV	(Particle Imaging Velocimetry)
PRECCINSTA	(PREdiction and Control of Combustion INSTAbilities for industrial gas turbines)
RANS	(Reynolds Averaged Navier Stokes)
RQL	(Rich Quench Lean)
SIA-TEAM	(Soot In Aeronautics)
SRR	(Standard Rainbow Refractometry)
TECC-AE	(Technology Enhancement for Clean Combustion in Aero-Engines)
TLC	(Towards Lean Combustion)
TOSCA	(Technologies for injection System Operability in Aeronautical Combustors)
UV	(UltraViolet)

AUTHORS



Alain Cochet graduated as an Engineer in 1977 from ENSAM (“Ecole Nationale Supérieure des Arts et métiers”) and in 1978 from ESTA (“Ecole Spéciale des Techniques Aérospatiales”). He joined Onera in 1980 as a research engineer in the Energetics Department. His main activity was in experimental studies related to ducted rocket and ramjet propulsion. In 1990, he was named head of the “Ramjet and Aeronautical Combustor Division”. Then later, in 1998, he was named head of the “Air-breathing Propulsion Research Unit” of the Fundamental and Applied Energetics Department, which is his current position.



Virginel Bodoc graduated from the Military Technical Academy of Bucharest in 2003. Over the following years he worked as a Research Engineer at the Military Equipment and Technology Research Agency of Bucharest. After receiving a Master Degree Diploma from the INP Toulouse in 2007, he joined ONERA as a Marie Curie doctoral fellow and defended his PhD in 2011. Since 2010, he has been involved in various research projects conducted at the LACOM combustion laboratory (Fauga-Mauzac center). Within the research team, his main field of activity is the development and application of optical measurement techniques (PIV, PDA/LDA, LIF, Rainbow Refractometry and Infrared Absorption) to characterize reacting and non-reacting gas/droplet flows. Since 2013, he has been in charge of the LACOM facility technical survey.



Christophe Brossard received his Engineering Degree in Energetics from the “Institut National des Sciences Appliquées” in Rouen, France, in 1991. He received his Doctorate Degree in Energetics from the University of Rouen in 1995. From 1996 to 2001, he worked at the Propulsion Engineering Research Center at Pennsylvania State University, USA. Since 2001, he has worked as a research scientist in the Fundamental and Applied Energetics Department at ONERA, focusing on flow field characterization, in different non-reacting and reacting environments, using optical laser-based diagnostic techniques (PIV, LDV, PDA, PLIF).



Olivier Dessornes graduated from the French engineering school ESTACA in 1990. He joined ONERA in 1990 where he is a research engineer working in the Fundamental and Applied Energetics Department (DEFA). He is mostly involved in experimental activities. His current fields of interest are scramjet propulsion, energy micro sources and hybrid propulsion.



Christian Guin graduated as Engineer in 1980 from CNAM (Conservatoire National des Arts et Métiers). He joined ONERA in 1974 as a technician and, since 1980, has worked as a research engineer in the Energetics Department. He has been involved in experimental combustion studies for ducted rockets and ramjets and then, since 1995, in new turbojet combustor concepts. He developed and has been in charge of the M1 high pressure test facility, devoted to the turbojet combustor studies at ONERA.



Renaud Lecourt graduated as Engineer from the “Ecole Centrale de Lyon” in 1978, and obtained a Masters Degree in Aerospace Sciences from the “Ecole Nationale Supérieure de l’Aéronautique et de l’Espace” in 1979. He has been a research engineer at ONERA for 35 years. He worked in liquid rocket propulsion, on injection and combustion, for 20 years and is now working on the same topics in air-breathing propulsion. He has a vast experience in optical diagnostics (PTV, PIV, LDA/PDA, laser sheet technique) under difficult conditions (high pressure and temperature conditions, burning sprays, vacuum, downstream from actual injectors).



Mikael ORAIN, MSc in Physics (1996), Diploma in Energetics and Fluid Mechanics from Coria (1997), PhD in Mechanical Engineering from the Imperial College London (2001). Research scientist at Onera in charge of developing laser-based techniques for the measurement of temperature and species concentration in reacting and non-reacting multiphase flows, with a specific emphasis on applications to large-scale facilities representative of aircraft or rocket engines. He has been involved in several National (ASTRA, BIOPTIC, EGISTHE, ECLAIR) and European research programs (TLC, NEWAC, KIAI, LEMCOTEC, IMPACT-AE, FACTOR).



Axel Vincent-Randonnier graduated from Université Pierre et Marie Curie where he obtained MSc and PhD degrees in Energetics and Process Engineering in 2002. He joined ONERA in 2004 for post-doctoral activities on plasma assisted combustion. Since 2006, he has been in charge of LAERTE subsonic and supersonic combustion facilities at ONERA – Palaiseau Center. Since 2012, he has been in charge of the MICADO project aimed at developing a new test rig dedicated to the study of high-pressure air-breathing combustion with optical diagnostics.

