



HAL
open science

Design and Control of a DC Series Offshore Wind Farm Based on HVDC-MMC

Haibo Zhang, Francois Gruson, Diana Flórez, Christophe Saudemont

► **To cite this version:**

Haibo Zhang, Francois Gruson, Diana Flórez, Christophe Saudemont. Design and Control of a DC Series Offshore Wind Farm Based on HVDC-MMC. Symposium de Genie Electrique, Jun 2016, Grenoble, France. hal-01361584

HAL Id: hal-01361584

<https://hal.science/hal-01361584>

Submitted on 7 Sep 2016

HAL is a multi-disciplinary open access archive for the deposit and dissemination of scientific research documents, whether they are published or not. The documents may come from teaching and research institutions in France or abroad, or from public or private research centers.

L'archive ouverte pluridisciplinaire **HAL**, est destinée au dépôt et à la diffusion de documents scientifiques de niveau recherche, publiés ou non, émanant des établissements d'enseignement et de recherche français ou étrangers, des laboratoires publics ou privés.

Design and Control of a DC Series Offshore Wind Farm Based on HVDC-MMC

Haibo ZHANG^{1,3}, François GRUSON^{1,2}, Diana FLÓREZ^{1,3}, and Christophe SAUDEMONT^{1,3}

¹Laboratoire d'Électrotechnique et d'Électronique de Puissance de Lille (L2EP),

²Arts et Métiers ParisTech (ENSAM)

³École des Hautes Études d'Ingénieur (HEI)

RESUME – Future offshore wind farms are expected to be placed further away from shore, which will give rise to more employment of HVDC transmission. However, HVDC transmission requires a bulky and expensive power conversion substation at offshore as well as a dedicated supporting platform. Potential elimination of the platform and centralized conversion station leads to great cost savings. Recent proposals of pure dc series offshore wind farms are due to this motivation. The series connection of the wind turbines enables to establish the HVDC transmission voltage level with no extra voltage step-up substation, which makes it attractive for distant large wind farm. However, as series connected in one cluster, wind turbines are not possible to operate independently. Severe wind variation imposes overvoltage on the wind turbines and may provoke a cascade of failures of other series connected units. This paper describes the operating behaviour of dc series offshore wind farm as well as correspondent control strategies in both sound and fault conditions. A simulation of the dc series wind farm is carried out and validates the feasibility of the proposed control strategy. DC series offshore wind farms with proposed control imply competitive economic advantages of future integration of remote energy generation.

Keywords – DC series offshore wind farm, HVDC transmission, MMC, overvoltage limitation.

1. INTRODUCTION

Wind energy is regarded as one of the most promising renewable energy sources. The past few years have witnessed the European wind market shift from onshore towards offshore. Offshore wind source is much more abundant and constant because of the absence of topographic influence, making more productive wind farms possible. As offshore wind parks moving further away from coast and to deeper water environment, the disadvantage of ac transmission becomes obvious since the reactive power generated by the cable shunt capacitance limits the ac transmission capacity. As a result, the replacement by high voltage direct current (HVDC) transmission is unavoidable. HVDC gains technical as well as economic attractions for long distance power transmission and in some cases, even becomes the only feasible solution that gives access to harvest those remote energy resources.

However, using HVDC to bring the generated ac power to shore requires a bulky, expensive ac-dc power conversion system as well as a dedicated offshore platform to support it. As a solution to reduce the wind farm project capital expenditure, innovative dc based offshore wind farm with series-connection of wind turbines was suggested in [1]. Series-connection of dc wind turbines enables the offshore collection grid to establish the HVDC transmission voltage level with neither transformer

nor centralized converter platforms, indicating great savings on wind farm investment. [2][3] show the elimination of centralized conversion system significantly reduce the overall losses. Fig. 1 presents a series offshore wind farm controlled by an onshore Multilevel Modular Converter (MMC), where dc power is converted and fed into the ac grid.

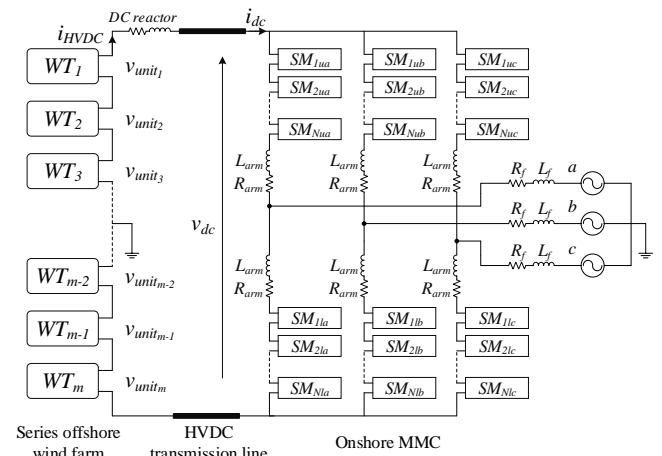

Figure 1: DC Series offshore wind farm and MMC

Despite of the economic attractions, dc series wind farm presents several technical challenges [4]. However, most scientific researches are interested in the topology design of local power conversion system placed inside the wind turbine[5][6], while few of them concerns the overall wind farm design and operation characteristics.

One of the challenges of the wind farm operation is that it suffers from large fluctuation in the output voltage caused by wind speed variation. Normally the HVDC voltage is controlled to be constant, either wind turbines power production disparity or bypass of any faulty unit might impose overvoltage across other operating units. Consequently, converters with wide output voltage variation capacities and coordinated control strategy concerning the whole wind farm system are of great importance to keep a series offshore wind farm operating safely, avoiding cascade failure in the series connection.

This paper proposes a control strategy of a series offshore wind farm in both sound and fault conditions. In sound condition, large unbalance of the power productions in the wind farm may cause several wind turbines to withstand overvoltage in a short period of time. As a result, an overvoltage limitation controller similar to the one proposed in [1] is implemented into

the wind turbine. In the condition of bypassing faulty units, wind turbines output voltage variations are further constrained because the constant HVDC voltage level impose a clamped effect across the wind turbines outputs. This condition may last for several days or weeks until the faulty unit recover to share the HVDC transmission voltage controlled by onshore converter, removing the clamped effect. In this case, a global control strategy then activates, which enables to reduce the HVDC voltage level by the MMC.

This paper firstly gives a detailed description of the series offshore wind farm design, critical components and sizing of the wind turbine converters. Then the wind farm control strategy as well as the control of MMC will be explained. Finally a simulation of the dc series wind farm is carried out to validate the feasibility of the proposed control strategy.

2. DC SERIES OFFSHORE WIND FARM OVERVIEW

Fig.1 shows a series parallel offshore wind generation system. The collector system is composed of m wind turbines connected in series to gain the HVDC transmission voltage without using extra conversion step. Power generated in the wind farm is transmitted to onshore via HVDC transmission cables. The grid faced MMC can provide both voltage control and good power quality at grid connection point.

2.1. Wind Turbine Configuration

Fig.2 shows in details the main components of the dc series offshore wind turbine. The wind turbine employs permanent magnetic synchronous generators. The direct-drive approach which has an increase in reliability is suitable for distant offshore applications. Wind turbine with higher power rating is favorable, since it suggests lower investment on a single foundation. Nowadays the biggest wind turbine rating at 10 MW is available. Each unit owns an individual fully rated converter system which facilitates maximum power point tracking. Voltage step-up from lower generator side to higher cluster collection side is realized by a DC/DC converter. There are several options for DC to DC conversion in the literatures. The most common one features the configuration shown in Fig.2, where a high frequency transformer is inserted between a dc/ac and ac/dc converter to provide both voltage raise as well as galvanic isolation between the generator and the dc collection grid. Indeed, high voltage level at the collection grid side demand the wind turbines of advanced insulation technology to ensure safe operation of power electronics system. However, the huge insulation level against the high potential imposing on the first and the last wind turbine remains a technical challenge.

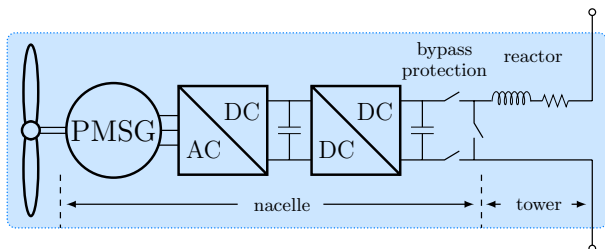

Figure 2: DC Series wind turbine configuration

2.2. Output Capacitor

In ac power systems, the kinetic inertia of rotating power generators characterizes the system dynamics [7][8]. The same behavior

applies to dc link capacitance in the dc power system, where stored electrostatic energy charges or discharges to counteract the dc link voltage variation during power mismatches. As described that the series connection of wind turbines sets up the HVDC transmission voltage, each wind turbine local conversion system can be viewed as a small voltage source converter. Each output capacitor serves as a part of the HVDC link capacitance. Total capacitance corresponds to a stored energy of 30 to 40 kJ/MVA (ms) at nominal power rating as suggested in [9]. The electrostatic constant of capacitor is defined as:

$$H_c = \frac{1}{2} \frac{(C_s V_s^2)}{P_{nominal}} \quad (1)$$

where:

C_s is the converter station capacitor value.
 V_s is the voltage across the DC link.
 $P_{nominal}$ is the power rating of the converter station.

2.3. DC Smoothing Reactor

The smoothing reactor is designed to a value big enough to limit the gradient of current boost di/dt during critical faults. When device detects the current in the HVDC cables increase beyond a preset safety level, protection system will be triggered to stop the whole system. The reactor is to limit the current to increase to this level before activating the protection system. There is no dedicated offshore platform for the smoothing reactor. Therefore, the reactor is separated to m equal parts and thus each part of the reactor is small enough to fit directly inside the wind turbine tower.

2.3.1. Definition of overvoltage

As the wind turbines are connected in series, the output current of each unit shares the same HVDC transmission current i_{HVDC} . In addition, the HVDC transmission voltage equals the sum of the output voltages of the turbines in series, if the voltage drop in the cables and smoothing reactor is neglected, the output voltage of each wind turbine is:

$$v_{unit_i} = v_{dc} \frac{P_{unit_i}}{P_{wf}} \quad (2)$$

For a typical variable speed wind turbine, output power is sensitive to the variation of wind speed between the interval of cut-in and rated wind speed. As a result, wind speed change with time and location creates continuously power production imbalance among units in the same cluster. Therefore, dc series wind turbines are required of wide voltage variation capabilities. When a particular wind turbine power production is higher than the average power production of its cluster, this unit output voltage will increase. If the HVDC voltage is regulated to be m times the wind turbine nominal voltage V_{nom} , this unit output voltage will rise above its nominal value. In this situation, this particular unit is in overvoltage. Bypass protection activates to disconnect faulty units, which puts all rest wind turbines operating in higher voltage level. With a constant HVDC voltage level, it can be perceived that the nominal output voltage of the wind turbines are being clamped to a higher level. To be more general, we define the v_{cmp} as Clamped Nominal Output Voltage, whose value is:

$$v_{cmp} = \frac{1}{m-k} v_{dc} \quad (3)$$

Where k is the number of fault wind turbines.

For above reasons, high voltage sides of the wind turbine dc/dc converters must be overrated in order to provide wind turbines of the adaptabilities of overvoltage. The maximum voltage level which a wind turbine converter can support is its overvoltage capability. As wind speed is not predictable, neither the number of fault units, inaccurate sizing of the wind turbine converter may cause avalanche breakdown of electronic devices. Physically expanding the size of wind turbine converter is not economic nor practical, especially in any weight and space restricted application. For the reason of safety and economy, the control of dc series offshore wind farm should consider overvoltage limitation, whose role is to prevent wind turbine output voltage being lift above its overvoltage capability.

3. OVERVOLTAGE LIMITATION CONTROL STRATEGY

3.1. Local Limitation Control Strategy in Normal Case

The local limitation focuses on power control of wind turbine individually when there is no fault in the wind turbines. Since the overvoltage can be caused by the unbalanced power production in the wind farm, the most straightforward idea is to reduce the power production of the wind turbines with overvoltage possibility to ensure their sound operation within safe limits [1].

As long as the sensor measures the output voltage reaching the predetermined overvoltage limitation, an output voltage controller is triggered to regulate the wind turbine to operate at the overvoltage limitation level V_{limit} . By imposing a reference output voltage V_{limit} and measuring the transmission current i_{HVDC} , the output voltage controller will provide the wind turbine unit j with a reference output power.

Since in this control method the output voltage considered is fixed by the output voltage controller, the wind turbine need to be given another criterion which allows it to switch back to normal operation when the overvoltage threat is released. However, as there is no communication between different wind turbines, it is not possible to compare wind turbine power inputs in order to define the right time to switch back. The criterion considered here is that if the power available in the wind is lower than the power needed to maintain the wind turbine operating at overvoltage limitation level, the wind turbine will switch back to normal operation. This means that if the wind turbine switches back to normal mode, the output voltage is bound to decrease because of lack of wind power to support the wind turbine to operate at such an overvoltage level. This criterion requires the output voltage controller to be active even in normal operation. The classical control flow chart is shown in Fig.3.

3.2. Global Limitation Control Strategy in Fault Case

As mentioned before, bypass imposes clamped effect on the rest sound wind turbines. Due to the clamped effect imposed by the MMC controlled HVDC voltage, even though the wind turbines operating at nominal power, the output voltages are above nominal values. In such cases, the range of wind turbine output voltage is thus further limited. The global limitation control strategy enables the reduction of the wind turbine output voltage by decreasing the HVDC voltage level which is shown in Fig.4.

The global limitation control strategy of the dc series offshore wind farm is executed by the onshore MMC. The dc bus voltage reference of the MMC is given by the offshore operation conditions. The next section recalls the MMC arm average model and gives short introduction of corresponding high level control.

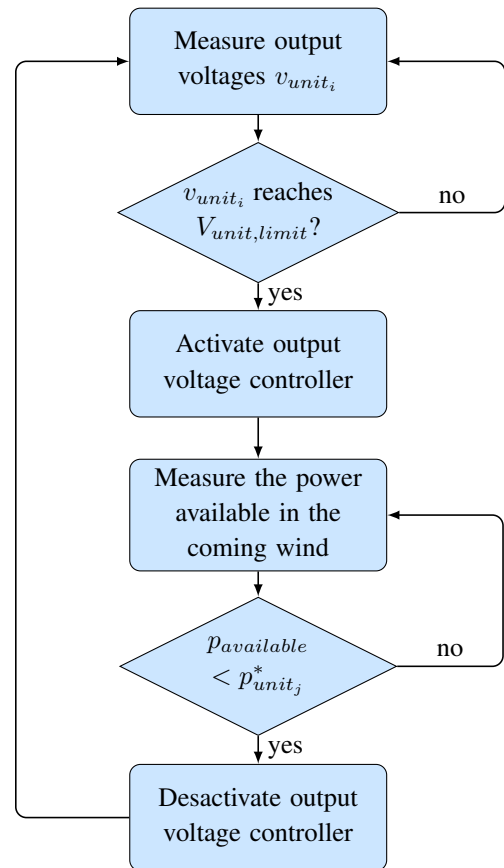

Figure 3: Flowchart of local limitation control strategy

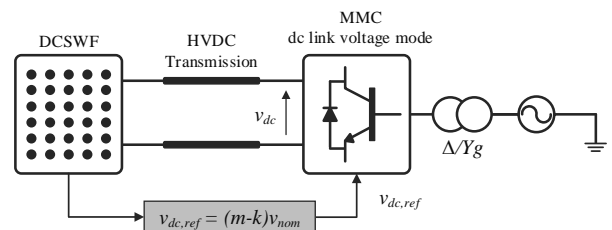

Figure 4: Global limitation control in fault case

4. MODULAR MULTILEVEL CONVERTER

4.1. Arm average model

The MMC topology shown in Fig. 1 consists of N submodules (SMs) per arm and each SM is a half bridge converter. Assuming the low level control functioning properly and then the MMC control system can be decoupled [10].

If voltage balancing of the SM capacitors in the arms is well performed, each capacitor voltage is given in (4),

$$v_{c1} = v_{c2} = \dots = v_{cN} = \frac{v_{ctot,ulj}}{N} \quad (4)$$

Where v_{ci} is the capacitor voltage of SM_i , v_{ctot} is the sum of all capacitor voltages of one arm. The subscripts u , l and j represent the upper arm or the lower arm, and phase a , b , c .

By defining $m = n/N$ with n the number of the active cells in the arm, the new variables are deduced to describe the arm voltages $v_{m,ulj}$ and currents i_{ulj} ,

$$v_{m,ulj} = m_{ulj} v_{ctot,ulj} \quad (5)$$

$$i_{ctot,ulj} = m_{ulj} i_{ulj} \quad (6)$$

Eq.(5) and (6) give the equivalent arm capacitors,

$$i_{ctot,ulj} = C_{tot} \frac{dv_{ctot,ulj}}{dt} \quad (7)$$

C_{tot} equals C/N , with C the capacitance of each SM capacitor. The arm equivalent model of MMC is shown in Fig. 5.

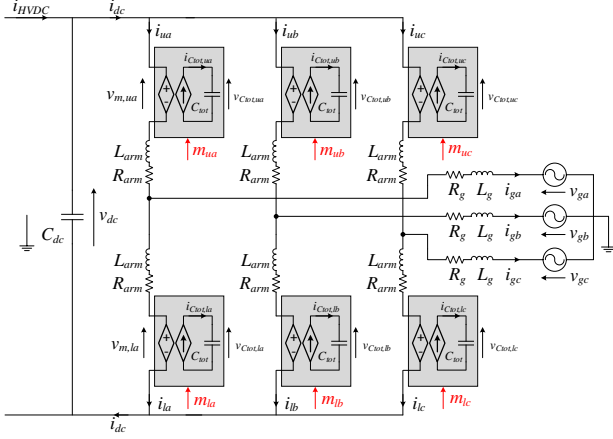

Figure 5: DC voltage control mode of MMC average model

Following the Kirchoff law, the equations describing the MMC system are,

$$-\frac{v_{dc}}{2} + v_{m,u,j} + L_{arm} \frac{di_{uj}}{dt} + R_{arm} i_{uj} + L_g \frac{di_{gj}}{dt} + R_g i_{gj} + v_{gj} = 0 \quad (8)$$

$$\frac{v_{dc}}{2} - v_{m,l,j} - L_{arm} \frac{di_{lj}}{dt} - R_{arm} i_{lj} + L_g \frac{di_{gj}}{dt} + R_g i_{gj} + v_{gj} = 0 \quad (9)$$

Performing the variable changes in (8) and (9),

$$\begin{cases} i_{diff,j} = \frac{i_{uj} + i_{lj}}{2}, \\ v_{diff,j} = \frac{v_{m,u,j} + v_{m,l,j}}{2}, \\ v_{v,j} = \frac{v_{m,l,j} - v_{m,u,j}}{2}. \end{cases} \quad (10)$$

The MMC system can be thus decoupled to a dc part and an ac part,

$$v_{v,j} - v_{g,j} = \left(L_g + \frac{L_{arm}}{2} \right) \frac{di_{g,j}}{dt} + \left(R_g + \frac{R_{arm}}{2} \right) i_{g,j} \quad (11)$$

$$\frac{v_{dc}}{2} - v_{diff,j} = L_{arm} \frac{di_{diff,j}}{dt} + R_{arm} i_{diff,j} \quad (12)$$

Eq. (11) and (12) state that 5 state variables, two independent current variables of the grid currents $i_{g,j}$ and three differential current $i_{diff,j}$ can be controlled.

Neglecting the energy stored in the inductances and the losses, the instantaneous energy change in one phase (upper arm and lower arm) is induced by the power exchange between the dc side and the ac side of the MMC in one phase,

$$\frac{dW_j^\Sigma}{dt} = \frac{1}{2} C_{tot} \left(\frac{dv_{ctot,u,j}^2}{dt} + \frac{dv_{ctot,l,j}^2}{dt} \right) = p_{dc,j} - p_{ac,j} \quad (13)$$

Where $p_{dc,j} = v_{dc} i_{diff,j,ac}$ is dc power transmitted to the ac side. The power unbalance between the upper arm and the lower arm, which is induced by the ac component of differential current $i_{diff,j,ac}$ should be controlled to be 0 [11].

$$\frac{dW_j^\Delta}{dt} = \frac{1}{2} C_{tot} \left(\frac{dv_{ctot,u,j}^2}{dt} - \frac{dv_{ctot,l,j}^2}{dt} \right) = v_{v,j} i_{diff,j,ac} \quad (14)$$

Eq. (11-14) denote all the 11 state variables of the MMC. The last variable in the series offshore wind energy generation system of Fig. 5 is the dc bus voltage. The model of the dc bus can be deduced by the power transmission from the wind farm to the dc side of the MMC. The derivative of the energy stored in the dc bus capacitor is,

$$\frac{1}{2} C_{dc} \frac{dv_{dc}^2}{dt} = p_{wf} - p_{dc} \quad (15)$$

For now, the model of the entire system has been described, which enables the determination the high level control of the MMC for the dc series offshore wind farm.

4.2. High level control of the MMC

4.2.1. Inner loop control

The inner loop control is in charge of the grid currents and the differential currents described by (11) and (12). The control structure is shown in Fig. 6. The inner loop receives references from the outer loop according to desired energy control strategies.

The grid current is controlled by a classical current control in the dq frame. The controllers can be designed by applying park transform on (11).

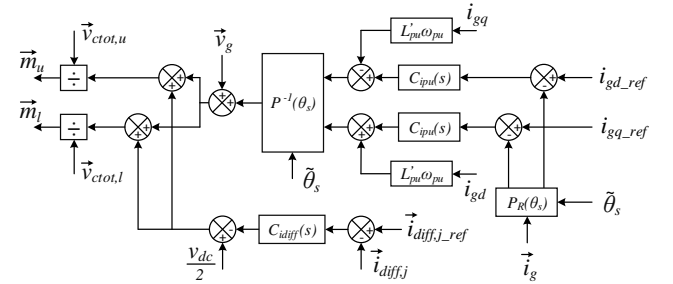

Figure 6: Control block diagram of the MMC grid and differential currents

4.2.2. Outer loop control

In the MMC, the energy stored in the arms is not directly linked to the dc bus voltage. The desired energy stored in one arm of the MMC can be selected to any value. By setting the energy reference of $v_{ctot,ulj}^2$ to the square of the dc bus voltage v_{dc}^2 , the MMC stored energy can be related to the dc bus as studied in [12]. Eq.(13) becomes,

$$\frac{dW_j^\Sigma}{dt} = \frac{1}{2} C_{tot} \left(6 \frac{dv_{dc}^2}{dt} \right) = p_{dc} - p_{ac} \quad (16)$$

Replacing p_{dc} in (16) by (15) gives the corresponding ac side power,

$$p_{ac} = p_{wcf} - \frac{1}{2}(C_{dc} + 6C_{tot}) \frac{dv_{dc}^2}{dt} \quad (17)$$

Fig. 7 shows the MMC outer loop control scheme.

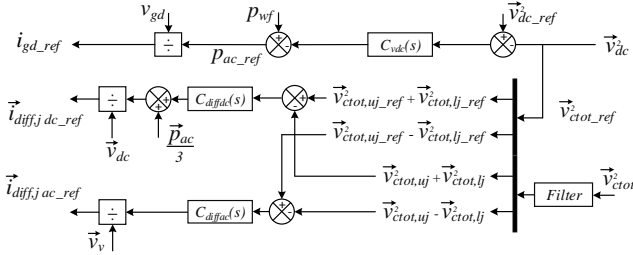

Figure 7: Control block diagram of the MMC stored energy and dc bus voltage

5. SIMULATION

The simulation of a dc series offshore wind farm with the proposed control strategy and corresponding MMC control is implemented in Simulink®. Some simplifications of the wind turbines are adopted. The wind turbines are modeled as variable power sources. The simulated wind farm consists of 20 series connected units with nominal power and output voltage of 10 MW and 32 kV. The overvoltage capacities are selected to be 1.1 p.u. More details of the chosen offshore wind farm and MMC components are listed in Table 1.

Table 1: System parameters

L	60 mH	L_{arm}	50 mH
R	60 m Ω	R_{arm}	50 m Ω
C_{dc}	39 μ F	C/N	25 μ F
V_{unit_nom}	32 kV	V_{dc}	640 kV
V_{unit_limit}	1.1 p.u.	P_{unit_nom}	10 MW
T_{r_ig}	5 ms	T_{r_diff}	10 ms
$T_{r_W\Sigma}$	100 ms	$T_{r_V_{dc}}$	100 ms

Fig.8(a) shows the power variations of different units with time. Unit 1 keeps nominal power production throughout the simulation. At 8 s, one of the wind turbines WT_{20} is bypassed due to fault inside the turbine. In this condition, the output voltage of unit 1, if there is no control strategy imposed, can be calculated according to (2). During 4 to 5.5 s, the output voltage of unit 1 would be above its overvoltage capability which is 1.1 p.u. According to the local control strategy, the wind turbine unit 1 should reduce power production to limit its output voltage at 1.1 p.u.

During 8 to 10 s, the output voltage of unit 1 would be 1.05 p.u even all the wind turbines produce nominal power as shown in Fig. 8(a). According to the global control strategy, the MMC should reduce HVDC voltage to remove the clamped effect imposed on all the operating wind turbines.

Fig.8(b) presents the HVDC voltage changes. It can be seen that at 8 s the transmission voltage decreased to 0.95 p.u following the reference given by the control strategy. During wind farm power variation before 8 s, the HVDC voltage is well controlled and kept at constant level.

There can be observed in 8(e) is reversed during the fault bypass of WT_{20} , power flows from onshore side to offshore wind farm to establish constant HVDC transmission voltage at offshore side. The maximum current variation is within safety limit discussed in section 2.3. Some oscillation in the transmission current during the HVDC voltage regulation. This is caused by the resonance circuit constructed by the wind generation system shown in Fig. 1. This system imposes no direct control on the wind turbines output capacitors and smoothing reactor. Indeed, the resonance could lead to problems when faulty wind turbines are bypassed, resulting in large and fast power reduction in the wind farm. A passive damping solution is to connect a resistor in parallel with the smoothing reactor. However, this leads to power losses. Active solutions for resonance damping need to be further studied.

Fig.8(c) and 8(d) show the output voltage variation of wind turbine units 1 and 2. As a result of a good HVDC voltage control, the output voltage of unit 1 stays below its overvoltage limit. During the failure of WT_{20} , the output voltage of both wind turbine WT_1 and WT_2 are at nominal value, which means the global control strategy succeeded in removing the clamped effect on the wind turbines.

Fig. 8(f) presents in detail the upper and lower equivalent capacitor voltages of one arm. It is clearly shown that the energy inside the MMC is linked to the HVDC bus voltage by setting the energy reference of $v_{tot,ulj}^2$ to the square of the dc bus voltage v_{dc}^2 , which validates the global control strategy of the wind farm as well as the high level control imposed on the MMC.

6. CONCLUSION

This paper proposes an overvoltage limitation control strategy for the dc series offshore wind farm. During overvoltage caused by wind speed variation, the wind turbine has potential overvoltage and has to reduce its power production in order to avoid voltage increasing above its safety level. During overvoltage caused by a fault in the wind farm, the onshore MMC regulates the HVDC voltage level to eliminate the clamped effect on the series wind turbines.

The paper provides a detailed control strategy and the corresponding control of the MMC is also presented. The inner current control loop is achieved by direct inversion of the MMC arm average model and the outer loop is based on a desired energy-based strategy. The control architecture enables control of all the MMC state variables. In addition, the stored energy inside the MMC is linked to the dc voltage bus in order to gain better system performance.

The simulation validates the control strategy by showing a satisfactory operation of a dc series offshore. The wind turbines are protected within their overvoltage capacities through the action of a local voltage limitation controller and the onshore MMC even if the power production is significantly unbalanced. However, resonance in the wind farm transmission system is observed and an active damping method is worthy of further investigation.

7. REFERENCE

- [1] Stefan Lundberg. *Wind farm configuration and energy efficiency studies - series DC versus AC layouts*. PhD thesis, Chalmers University of Technology, Goteborg, Sweden, 2006.
- [2] Pascal Monjean. *Optimisation de l'architecture et des flux énergétiques de centrales à énergies renouvelables offshore et onshore équipées de liaisons*

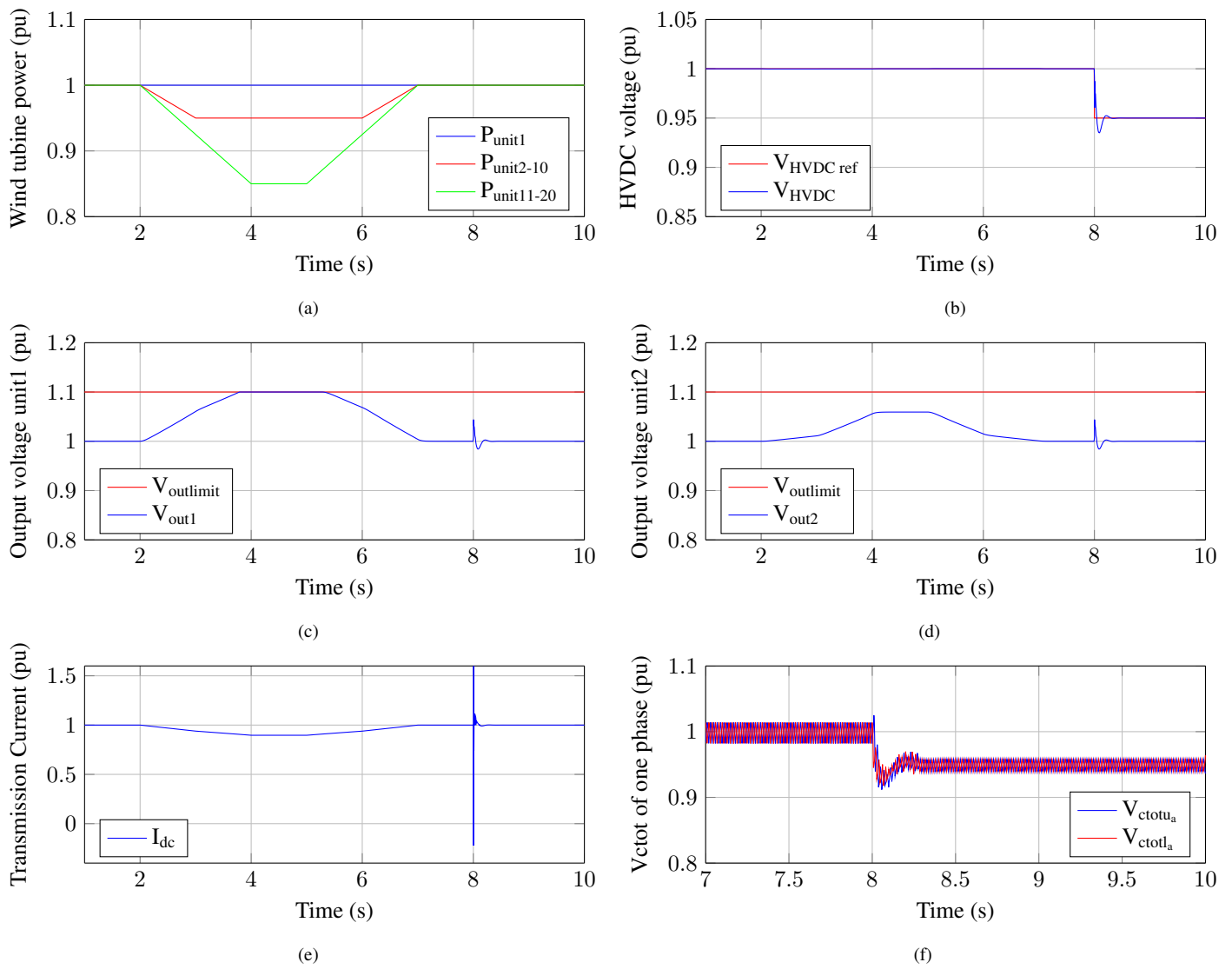

Figure 8: Offshore wind farm simulation results (a) Power productions of the wind turbines, (b) HVDC voltage level, (c) Output voltage of WT unit 1, (d) Output voltage of WT unit 2, (e) Transmission current, (f) upper and lower equivalent capacitor voltages of phase a .

en continu. PhD thesis, l'École Nationale Supérieure d'Arts et Métiers, Lille, France, 2012.

- [3] Pascal Monjean, Jerome Delanoe, Jonathan Sprooten, Christophe Saudemont, and Benoît Robyns. Comparison Methodology of Offshore Wind Farm Architectures. In *Electrimacs 2011, Cergy- Pontoise, France*, 2011.
- [4] Marco Liserre, Roberto Cardenas, Marta Molinas, and José Rodriguez. Overview of Multi-MW Wind Turbines and Wind Parks. *IEEE Transactions on Industrial Electronics*, 58(4):1081–1095, April 2011.
- [5] Nathalie Holtsmark and Marta Molinas. Thermal analysis of matrix and Back-To-Back converters for series-connected wind turbines. In *Industrial Electronics Society, IECON 2013-39th Annual Conference of the IEEE*, pages 4967–4972. IEEE, 2013.
- [6] A. Garcés and M. Molinas. Coordinated control of series-connected offshore wind park based on matrix converters. *Wind Energy*, 15(6):827–845, September 2012.
- [7] Prabha Kundur, Neal Balu, J, and Mark G Lauby. *Power System Stability And Control*. McGraw-Hill, Inc, 1994.
- [8] Jiebei Zhu, C.D. Booth, G.P. Adam, A.J. Roscoe, and C.G. Bright. Inertia Emulation Control Strategy for VSC-HVDC Transmission Systems. *IEEE Transactions on Power Systems*, 28(2):1277–1287, May 2013.
- [9] Bjorn Jacobson, Patrik Karlsson, Gunnar Asplund, Lennart Harnefors, and Tomas Jonsson. VSC-HVDC Transmission with Cascaded Two-Level Converters. *Cigre*, 2010.
- [10] A. Antonopoulos, Lennart Angquist, and H.-P. Nee. On dynamics and voltage control of the Modular Multilevel Converter. In *13th European Conference on Power Electronics and Applications, 2009. EPE '09*, pages 1–10, September 2009.
- [11] H. Saad, X. GUILLAUD, J. Mahseredjian, S. Denetiere, and S. Nguetfeu. MMC Capacitor Voltage Decoupling and Balancing Controls. *IEEE Transactions on Power Delivery*, 30(2):704–712, April 2015.
- [12] S. Samimi, F. Gruson, X. Guillaud, and P. Delarue. Control of DC bus voltage with a Modular Multilevel Converter. In *PowerTech, 2015 IEEE Eindhoven*, pages 1–6, June 2015.