



HAL
open science

Modelling up to 45 GHz of coupling between microvias and PCB cavities considering several boundary conditions

Thierry Le Gougec, Najib Mahdi, S. Cadiou, Cédric Quendo, E. Schlaffer, W Pessl, Alain Lefevre

► To cite this version:

Thierry Le Gougec, Najib Mahdi, S. Cadiou, Cédric Quendo, E. Schlaffer, et al.. Modelling up to 45 GHz of coupling between microvias and PCB cavities considering several boundary conditions. *International Journal of Microwave and Wireless Technologies*, 2016, 8 (3), pp.421-430. 10.1017/S1759078716000192 . hal-01358417

HAL Id: hal-01358417

<https://hal.science/hal-01358417>

Submitted on 1 Sep 2016

HAL is a multi-disciplinary open access archive for the deposit and dissemination of scientific research documents, whether they are published or not. The documents may come from teaching and research institutions in France or abroad, or from public or private research centers.

L'archive ouverte pluridisciplinaire **HAL**, est destinée au dépôt et à la diffusion de documents scientifiques de niveau recherche, publiés ou non, émanant des établissements d'enseignement et de recherche français ou étrangers, des laboratoires publics ou privés.



Distributed under a Creative Commons Attribution - NoDerivatives 4.0 International License

Modelling up to 45 GHz of coupling between microvias and PCB cavities considering several boundary conditions

T. LE GOUGUEC¹, N. MAHDI¹, S. CADIOU¹, C. QUENDO¹, E. SCHLAFFER², W. PESSL², A. LEFEVRE³

¹ Université de Brest (UBO) Lab-STICC 6 Avenue Le Gorgeu CS 93837 BREST Cedex3
France

² ATS AG, Fabriksgasse 13, 87000 Leoben, Austria

³ THALES Communications Security, 4 Avenue des Louvresses, 92622 Gennevilliers Cedex.

The recent developments in electronic cards such as the network equipment are characterized by the miniaturization of the board size and the increasing complexity of the layout. Because of these requirements, multi-layered printed circuit boards (PCBs) are commonly used and vias connecting signal lines on different layers, or integrated circuit devices to power and ground planes, are frequently used and often essential. However, a via is not an ideal transmission line. Besides, it creates discontinuities at high frequencies leading to high insertion loss degradation of signal which limits the performances of integrated circuit and systems.

In this paper, the impacts of coupling between via and parallel-plates cavity on the response of microwave integrated devices are highlighted in the first part. Then, to describe the intrinsic interaction between the via transition and parallel-plate modes, the notion of parallel-plates matrix impedances is presented and new boundary conditions like open or PTHs (plated through holes) shielded boundaries of the cavities are introduced. Then, using this physics-based model, an intuitive equivalent circuit has been developed. Finally the proposed approach and the equivalent circuits were validated by using comparisons with EM simulations and measurements in different scenarios.

Keywords: Authors should not add keywords, as these will be chosen during the submission process (see http://journals.cambridge.org/data/relatedlink/MRF_topics.pdf for the full list)

Corresponding author: T. Le Gouguec; Thierry.legouguec@univ-brest.fr;
phone: +33 2 98 01 72 72

I. INTRODUCTION

3D multi-layers technologies such as LTCC [1] or high density multilayers PCB (HD-PCB) [2] are currently being strongly developed because they offer considerable size reduction as well as the embedded function possibilities. For microwave applications such as filters, couplers, diplexers...[3,4], these 3D structures offer new design possibilities for frequencies up to 100 GHz.

HD-PCB structures consist of several metal layers separated by dielectric substrates. The vias and microvias used in multilayer PCBs allow connecting lines of different metallic levels together or connecting devices to the power and ground plane [5]. The different metal planes can also be connected together with metallic plated through holes (PTH). With the rise of working frequencies, the stacked multilayer PCB structures are subjected to electromagnetic phenomena like standing waves in cavities or like coupling and interaction between neighbouring components.

As example of HD-PCB technology, the AT&S™ (PCB manufacturer) technology used during MIDIMU-HD project funded by the Euripides council is presented in Fig. 1. This HD multilayer consists of eight metallic layers (30 μm thickness) separated by Megtron6 (Panasonic™) substrate of approximately 95 μm thickness (depending on the metal densities of each level) and with a relative permittivity $\epsilon_r=3.3$ and loss tangent $\tan(\delta)=0.0065$ at 40 GHz. A single microvia hole consists of a central cylinder with a diameter of 140 μm , a conductor pad with a diameter of 240 μm and when this via passes through a metallic plane it will also have a clearance hole called anti-pad of diameter of 350 μm . AT&S is able to stack more than three microvias and to realized buried via with diameter of 200 μm . The PTHs connecting the metal level M1 to the metal level M8 are 200 μm of diameter.

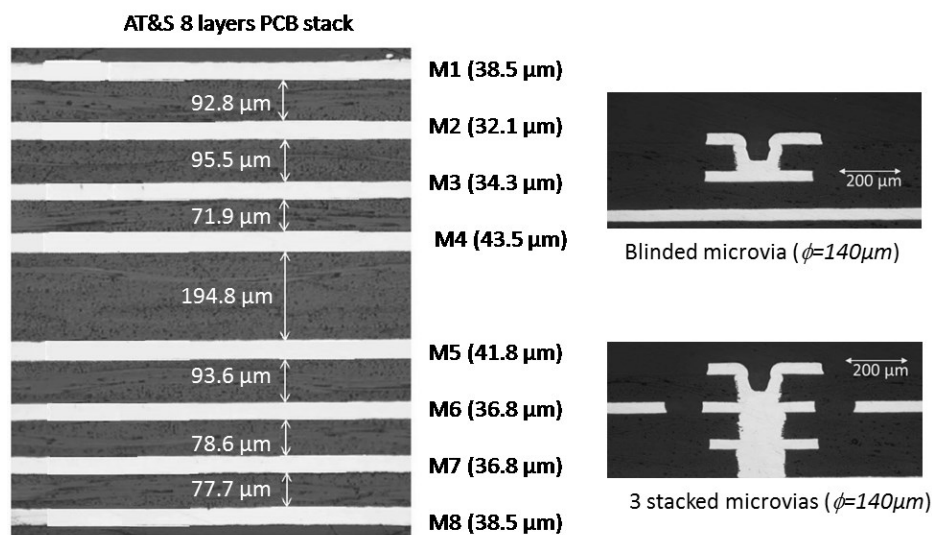

Fig. 1: AT&S: 8 metal layers stack, and microvia realization for MIDIMU-HD project

Obviously, these multilayer structures which involve parallel planes, dielectric layers, pads, and anti-pads are not ideal transmission components at high frequencies. The electrical behaviour of a microvia can be modelled by serial inductance and resistance like is done for a metallic wire [6,7]. The vias and microvias may cause mismatch [7], crosstalk, reflections,

some additional signal delays, and consequently the degradation of signal performance. On the other hand, the coupling between vias, microvias and parallel plates plays also an important role in the electrical performances of the via transition [9,10]. The excitation of the parallel plate modes results in conversion energy between propagation on line and propagation on guided plated structures which implies some transmission zeros.

In this paper the effects of vias crossing a multilayer HD-PCB structure for microwave applications up to 45 GHz are analysed and modelled using simple and intuitive equivalent circuits. For more accuracy, the concept of effective dimensions of the parallel-plates cavity is introduced to take into account the cavity boundary conditions. So, the proposed model is able to translate boundary behaviours like the classical ideal boundaries (perfect electric conductor (PEC) or perfect magnetic conductor (PMC)) [10-12] as well as more realistic ones like open boundaries or PTHs shielded boundaries not really considered before. The proposed equivalent circuits are based on transmission line models, lumped elements (R, L and C) for via modelling, and matrix impedances for the via-cavity couplings. They do not need any current controlled sources or any voltage controlled sources [10-11] and they are quite similar to the physical structures. So the use of these equivalent circuits can facilitate the understanding of physical phenomena and help to overcome dysfunction due to via parallel-plates couplings. They were obtained thanks to using isolation resistances to describe behaviour of floating grounds in circuit simulator software like ADS (Keysight™) and the use of impedance matrix to represent the coupling between vias and the cavities.

This paper is organized as follow. In section II, the effects and the behaviours of microvias crossing a plated structures, are illustrated using EM simulations. Then, a physics-based circuit model associated with effective dimensions to characterize the interaction between the microvias and the parallel-plate modes is proposed in section III. This modelling is implemented in Keysight-ADSTM software and validated by comparison with HFSS (ANSYSTM) FEM simulations and measurements in the 4th part of this paper. In Section V, we give some conclusions and we present some prospects of these studies.

II. Coupling between microvias and parallel plates

The interaction between microvias and parallel-plate cavities is illustrated by the study of the S parameters on a back to back transition using two stacked microvias to connect two microstrip access placed at metal level M1 to an embedded stripline placed at metal level M3 (presented in Fig.1). The microvias go through metallic ground M2 of the microstrip lines. Two boundary condition cases have been considered for the rectangular cavity composed of the metal planes M2 and M4: *i*) the open case (Fig 2) and *ii*) the case where boundaries are realized with PTHs (Fig 3). The S parameters up to 50 GHz obtained using EM HFSS™ simulator for these two structures are presented Fig 2-b and Fig 3-b. The S parameters show transmission zeros and perturbations which appear at different frequencies considering the boundary conditions. For example, the first perturbation appears around 10 GHz for the open boundary condition case, while it occurs within higher frequencies (up to 25 GHz) for PTH shielded cases. These perturbations are due to the coupling between the microvias and the cavity formed

by the metallic plates as confirmed by the mapping of the electric field in the structure at the resonance frequencies where the electric field is distributed overall the cavity.

These examples demonstrate the interest to predict the perturbation risks and so to dispose of good models of interaction between vias and parallel-plate cavities, considering several boundary conditions. To save time during design and to limit the use of time consuming EM-simulators, a circuit model based on an analytical formulation of interaction between vias and parallel-plate cavities has been developed and it will be presented in the next section.

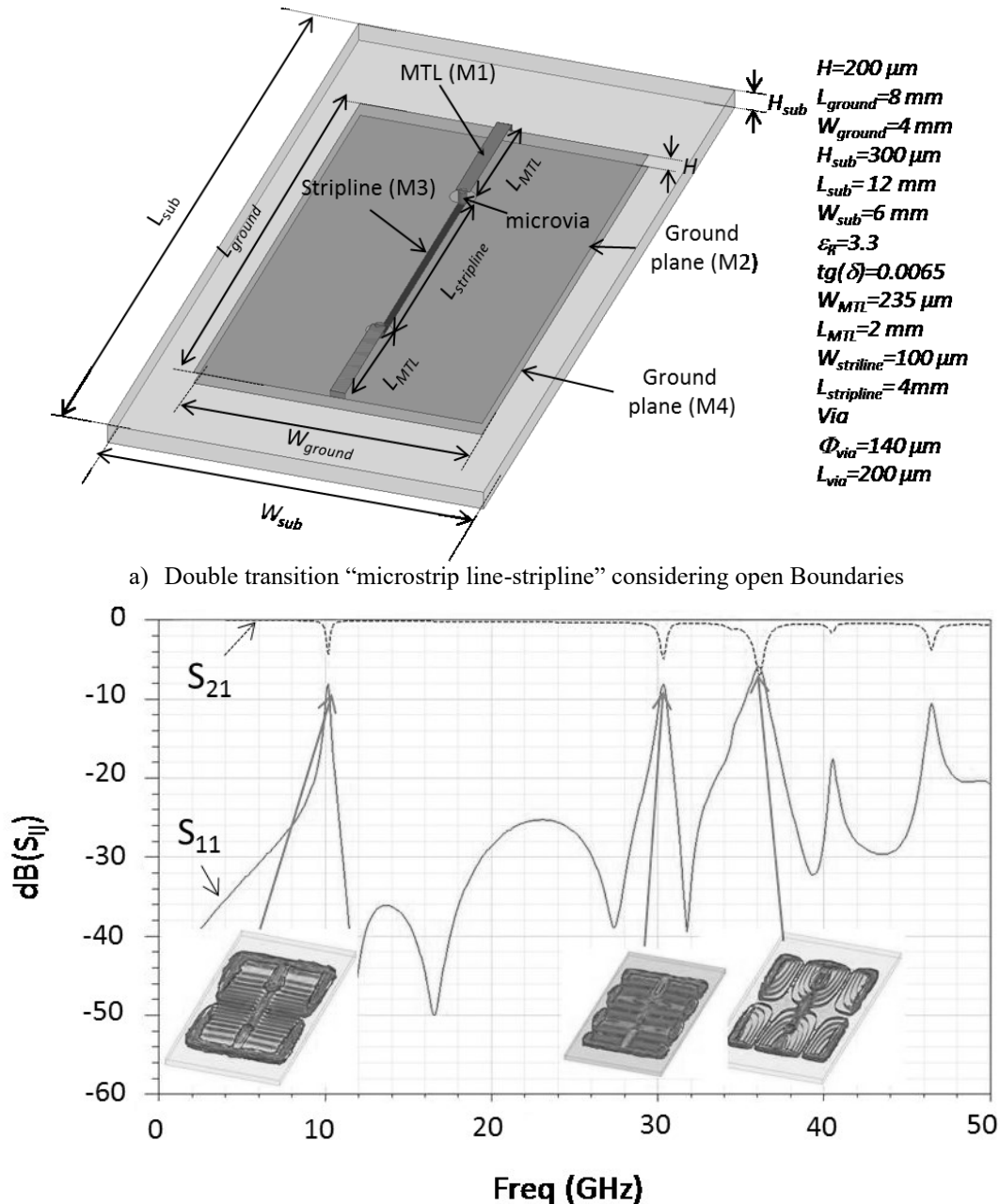

b) EM simulating S parameters results
 Fig. 2: Double microstrip to stripline transition (a) and S parameter measurement results (b) with open boundary conditions

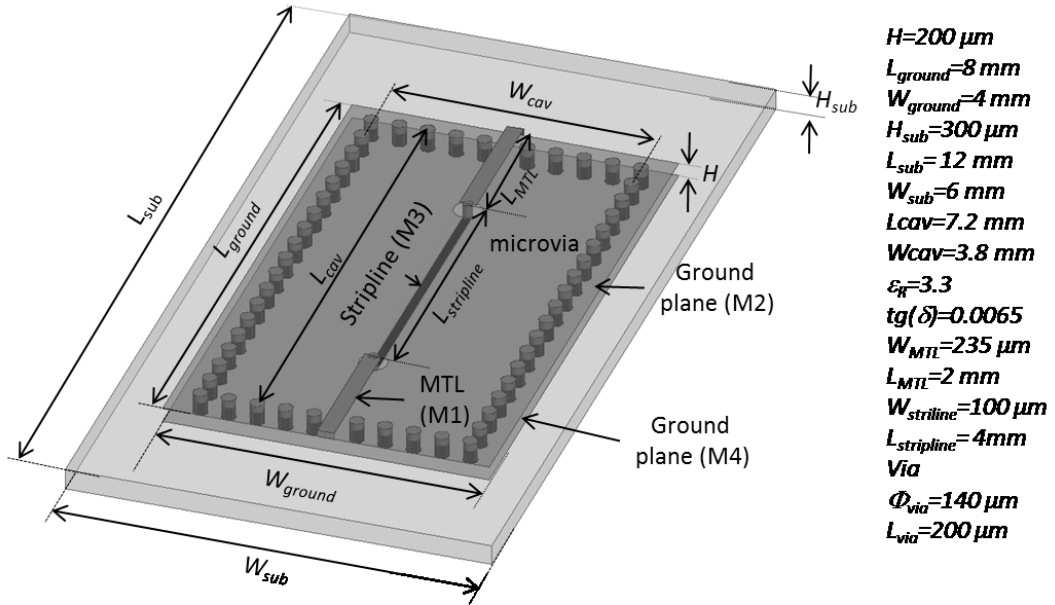

a) Double transition “microstrip line-stripline” considering PTHs shielded boundaries

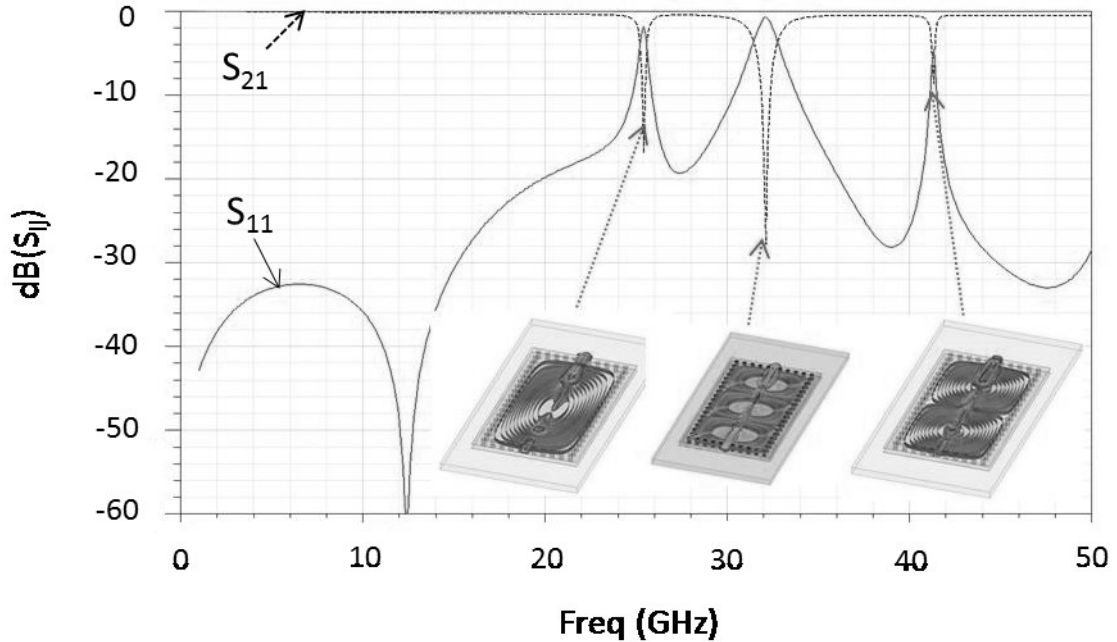

b) EM simulating S parameters results

Fig. 3 : Double microstrip to stripline transition (a) and S parameter measurement results (b) with PTHs Shielded boundary conditions.

III. Interaction modelling between via-holes and parallel metal plates

The modelling of the excitation of the parallel plates modes by a via crossing it, has been previously studied by a few authors [10,11,12]. To illustrate how the coupling is done, let us analyse the current path in a transition by using via hole, between two microstrip lines situated on either side of two metal planes, as shown in Fig. 4-a.

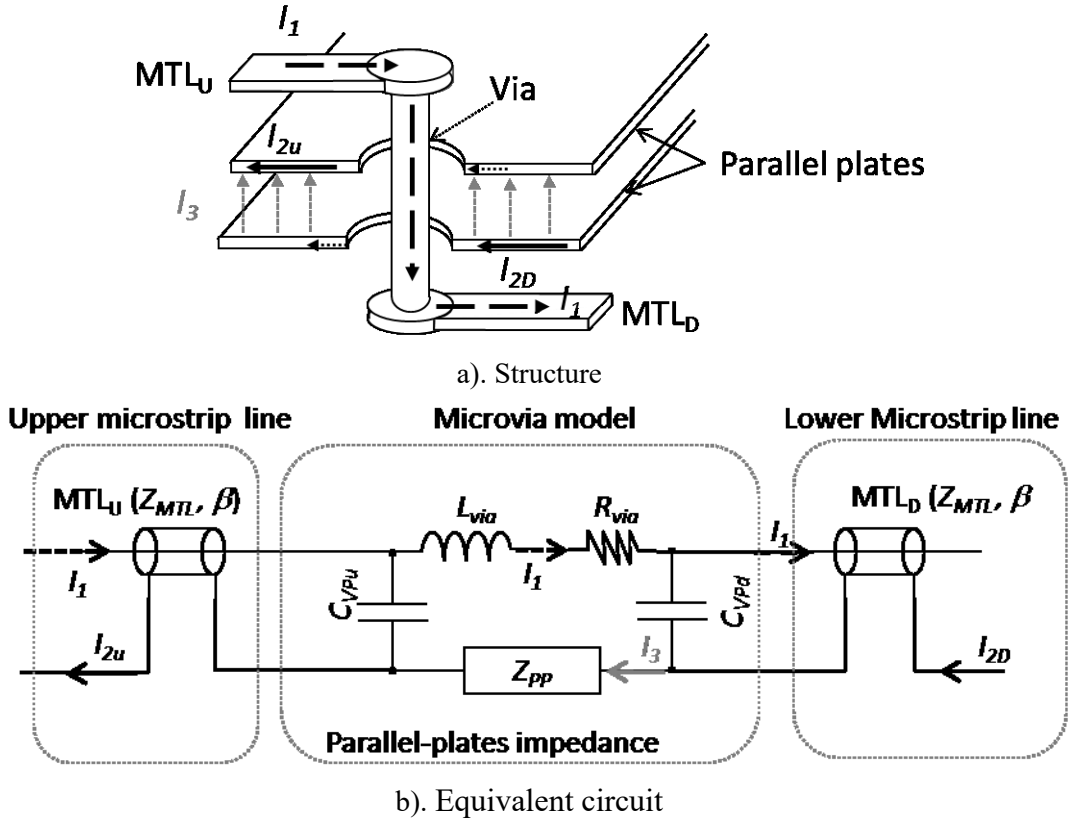

Fig. 4 : Via through two grounded metallic planes and the corresponding equivalent circuit.

The direct current I_1 flows through the upper microstrip line, then goes through the metallic via-hole and finally through the lower line. This current generates a return current I_2 in the two metallic planes which are the ground of the microstrip lines as shown in Fig. 4. To complete the current path, a current I_3 must exist between the upper and lower metallic planes. This current is flowing through the impedance called parallel-plate impedance " Z_{PP} " which is the image of the modes which may exist between the two conductor plates. So this structure can be modelled by the equivalent circuit proposed in Fig 4-b.

In this equivalent electrical schematic (Fig.4-b), " $C_{VPu,d}$ " represents the capacitance between the via-hole and the upper or lower metallic plate respectively [6], " L_{via} " and " R_{via} " are respectively the inductance and the resistance of the via-hole [9]. There are several papers addressing the estimation of these parameters [6,12,13] with the help of analytical formulas. Another way to determine these values is to use static electromagnetic simulation tool like Q3D extractor (ANSYS™). The impedance " Z_{PP} " represents all the modes in the parallel-plate cavities between the two metallic planes and it can be obtained by solving the 2-D Helmholtz equation with appropriate boundary conditions on the periphery of the cavity. " Z_{MTL} " and " β " are the characteristic impedance and the wave number of the microstrip lines [12].

According to a more general case with further ports, the concept of parallel-plates impedance can be extended with use of parallel plate impedances matrix relating all the ports together. Fig. 5 presents a general two ports structure which is composed of two rectangular metallic planes of lateral dimensions $W_x \times W_y$ separate by a substrate of height " H " and permittivity " ϵ_R ". The ports are etched apertures on the upper face presenting a width " $p_{xi} \times p_{yi}$ " and placed at coordinates (x_{pi}, y_{pi}) , where the subscript " i " is the port number. The matrix

impedance $[Z_{PP}]$ which represents the interaction between all ports across parallel-plates when all the propagated modes are taken into account, can be expressed in Cartesian coordinates by [11,15]:

$$Z_{PPij} = \frac{j\omega\mu H}{W_{xeff}W_{yeff}} \sum_{m=0}^{+\infty} \sum_{n=0}^{+\infty} \frac{C_m^2 C_n^2 F_{BCx}^2 F_{BCy}^2 F_{pi} F_{pj}}{k_{xm}^2 + k_{yn}^2 - k^2} \quad (1)$$

Where, $C_m^2, C_n^2 = 1$ for $m, n=0$ and $C_m^2, C_n^2 = 2$ for $m, n \neq 0$. The cut-off wave number according to the x and y axes are given by: $k_{xm} = \frac{m\pi}{W_x}$, $k_{yn} = \frac{n\pi}{W_y}$, and wave number in the homogeneous lossy media:

$$k = \omega\sqrt{\varepsilon\mu} \left(1 - j \left(\frac{\tan(\delta) - (\delta_s/H)}{2} \right) \right) \quad (2)$$

Where $\tan(\delta)$ is the dielectric losses tangent and electric conductor loss are given by $\delta_s = \sqrt{2/\omega\mu_c\sigma_c}$.

For ideal boundaries condition like perfect electrical conductor (PEC) or perfect magnetic conductor (PMC), the boundaries functions $F_{BC\xi}$ (the subscript ξ denote the axis x or y) take into account the boundary lateral border of the parallel planes and they can be expressed by[10]:

$$\begin{cases} F_{BC\xi} = \sin(k_i \xi) & \text{for (PEC)} \\ F_{BC\xi} = \cos(k_i \xi) & \text{for (PMC)} \end{cases} \quad (3)$$

With $i=m$ for x axis direction, or $i=n$ for y axis direction and where $\xi = x_{pi}$ or y_{pi} are the port coordinates. Notice that Eq. 1 allows the $[Z_{PP}]$ determination in all cases, whether the boundaries along the axis "x" or "y" are the same or not.

The function describing the port area influence is given by:

$$F_{pi} = \text{sinc} \left(\frac{k_m \cdot p_x}{2} \right) \cdot \text{sinc} \left(\frac{k_n \cdot p_y}{2} \right) \quad (4)$$

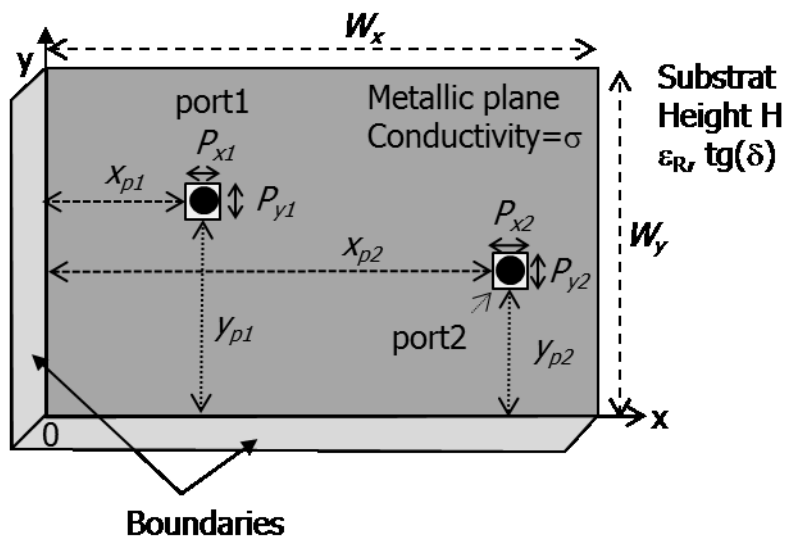

Fig. 5 : Geometry of two parallel-plates

In many applications, the boundaries are not clearly defined as PEC or PMC. For example, if we consider two metallic planes on a larger substrate (like in Fig. 2-a), the boundary conditions cannot be considered as a perfect magnetic conductor because of the fringing effect of electric fields. On the other hand, if we consider parallel plates shielded by using PTHs (like in Fig. 3-a), the cavity boundaries are not a perfect electrical conductor due to electric field configuration on PTHs boundaries. So, to complete previous studies [10-12], the use of effective dimensions W_{effx} and W_{effy} instead of the real physical dimensions W_x and W_y has been introduced. In a general case, the effective cavity dimensions can be expressed as:

$$W_{eff} = W + dW \quad (5)$$

For the open boundaries case (Eg. Fig. 2-a) to take into account the overflowing of the electric field on boundaries, using the well-known microstrip approach [14], the corrective term dW can be expressed by:

$$dW = 0.41 * H \frac{(\epsilon_R+0.3)\left(\frac{W}{H}+0.264\right)}{(\epsilon_R-0.258)\left(\frac{W}{H}+0.8\right)} \quad (6)$$

Where H is the substrate thickness, W represents W_x or W_y according to the considered axis and ϵ_R is the relative permittivity of the substrate. The PMC boundary function can be use with this corrected dimension W_{eff} . This corrective term resulted from a quasi-static approach and must be adapted to express dispersive behaviour for large thickness substrates.

In the case of PTH shielded boundaries (Eg. Fig 3-a), the corrective term dW to take into account the containing of electric-field, can also be estimated using the well-known theory of SIW guides [15] and given by:

$$dW = -1.08 \frac{d^2}{s} + 0.1 \frac{d^2}{W} \quad (7)$$

Where “ d ” is the diameter of the PTH and “ s ” the space between two consecutive via-holes center and W is for W_x or W_y depending of the considered direction. This approach is very accurate until s/d is smaller than three [16]. The PEC boundary function must then be used with the effective dimension W_{eff} .

This approach of effective dimensions can be used considering different boundary conditions along x and y axis. As example, a PTH shielded boundary can be considered along the x axis while an open boundary can be considered along the y axis.

A “Matlab™” program has been developed to determine the frequency dependent impedance matrix $[Z_{PP}]$ whatever the boundary conditions. This impedance matrix is saved in “touchstone” format easily readable by circuit simulators like ADS.

To demonstrate the interest of using effective dimensions in case of non-ideal boundaries, Fig 6 shows the transmission parameters S_{21} determined with EM simulation, of a transition between two microstrip lines through a rectangular parallel plates cavity ($W_x=60$ mm, $W_y=40$ mm, $H=254$ μ m, $\epsilon_R=3.6$). The results obtained by considering open boundaries or PTHs shielded boundaries ($d=200$ μ m and $s=400$ μ m) are compared with those obtained using perfect PMC and PEC boundaries respectively. The results of the simulations of the equivalent circuit of the Fig. 4-b where effective size of the cavity are considered are also plotted in Fig.6. One

should note that there is a difference of about 2% to 5% between frequencies of the apparition of the zeros by considering the real boundary conditions (open or PTH shielded) rather the perfect ones (PMC or PEC). A very good agreement can be observed between EM simulations with open or PTHs shielded boundaries and circuit model results for the both cases. Finally, results in Fig. 6 confirm that the use of effective dimensions leads to more accurate results whatever the boundary conditions. In the next paragraph other validations of the proposed modelling are illustrated.

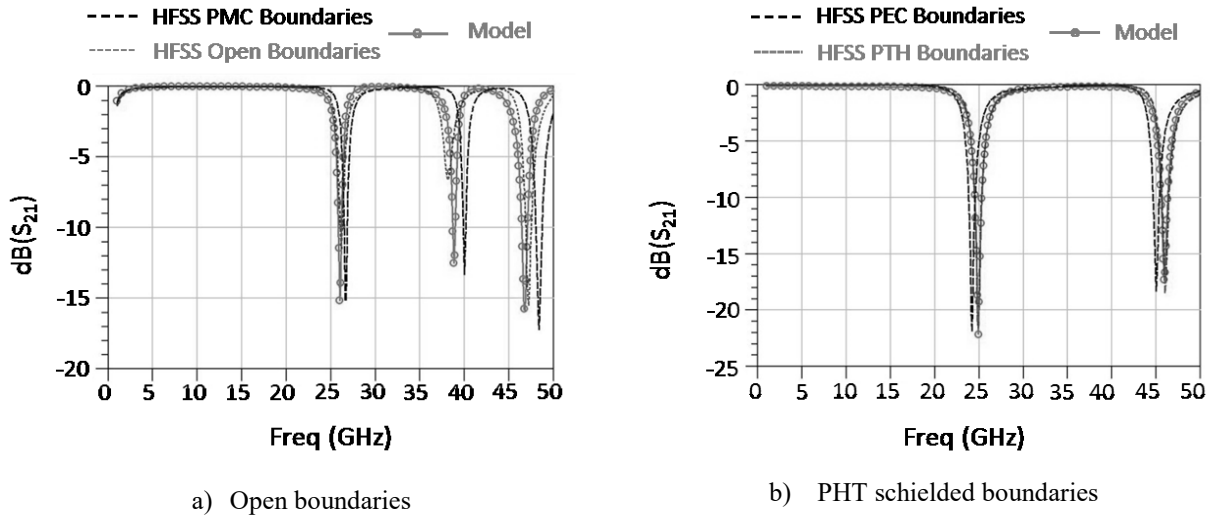

Fig. 6: transmission coefficient of one via crossing a parallel-plates cavity.

IV. Model validation by comparison with full-wave simulations and measurements.

First, the accuracy of the proposed model is illustrated on a double microstrip to stripline transition with two kinds of boundaries: a) with open boundaries (see Fig-2a) and b) with PTH boundaries (see Fig 3-a). The equivalent model valid for both boundary cases is presented in Fig. 7. This equivalent circuit was implanted in ADS© software. In this equivalent model, isolation impedances with great value of $50\text{ G}\Omega$ have been introduced to overcome the problem of ground reference used in circuit simulator software and to be able to express the floating grounds behaviour. The matrix $[Z_{PP}]$ links currents and voltages at these ports which are isolated to the ground reference, so the isolation impedances have not any influence on it. This matrix expresses all the standing waves existing between the two grounds M2 and M4 around the stripline. For both boundary cases the values of microvia model ($L=46\text{ pH}$, $R=0.7\ \Omega$, $C1=16\text{ fF}$ and $C2=20\text{ fF}$) have been obtained using Q3D Extractor© software for a 40 GHz frequency. The inductance model is a lossy inductance model from ADS.

The comparison of S parameters obtained with EM simulation (HFSS) and those obtained by using the circuit model are shown in Fig. 8. For both cases of boundaries a good agreement between our modelling results and those obtained using EM simulations can be observed. For the open boundary case the small shift for higher frequencies is due to the proposed correction dW (eq. 6) which does not take into account the dispersive behaviour.

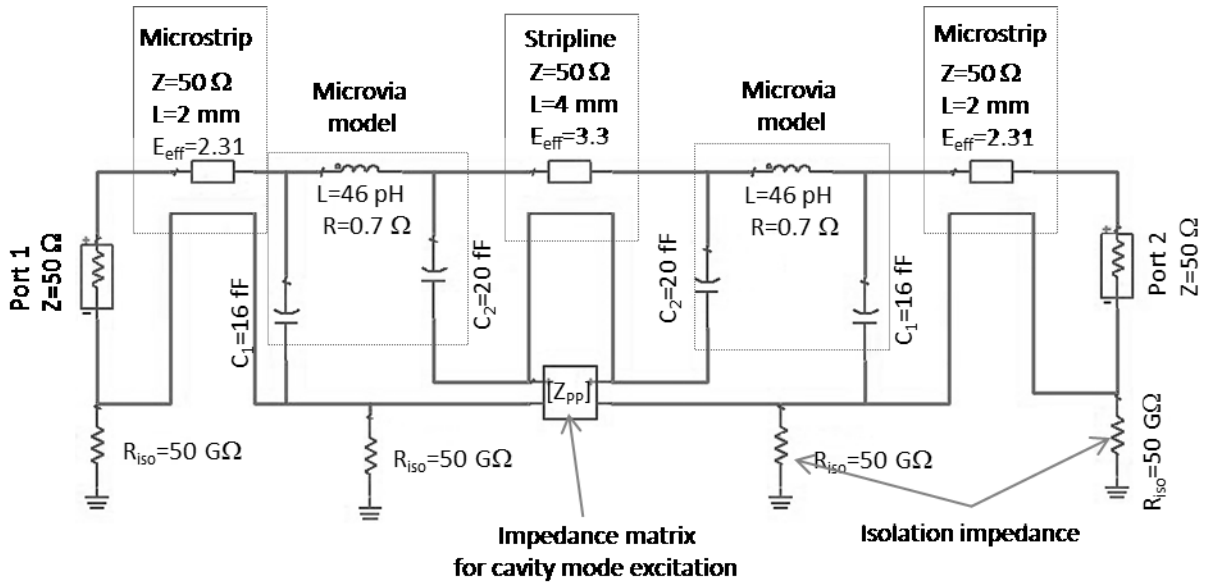

Fig. 7: Circuit model for a double microstrip to stripline transition.

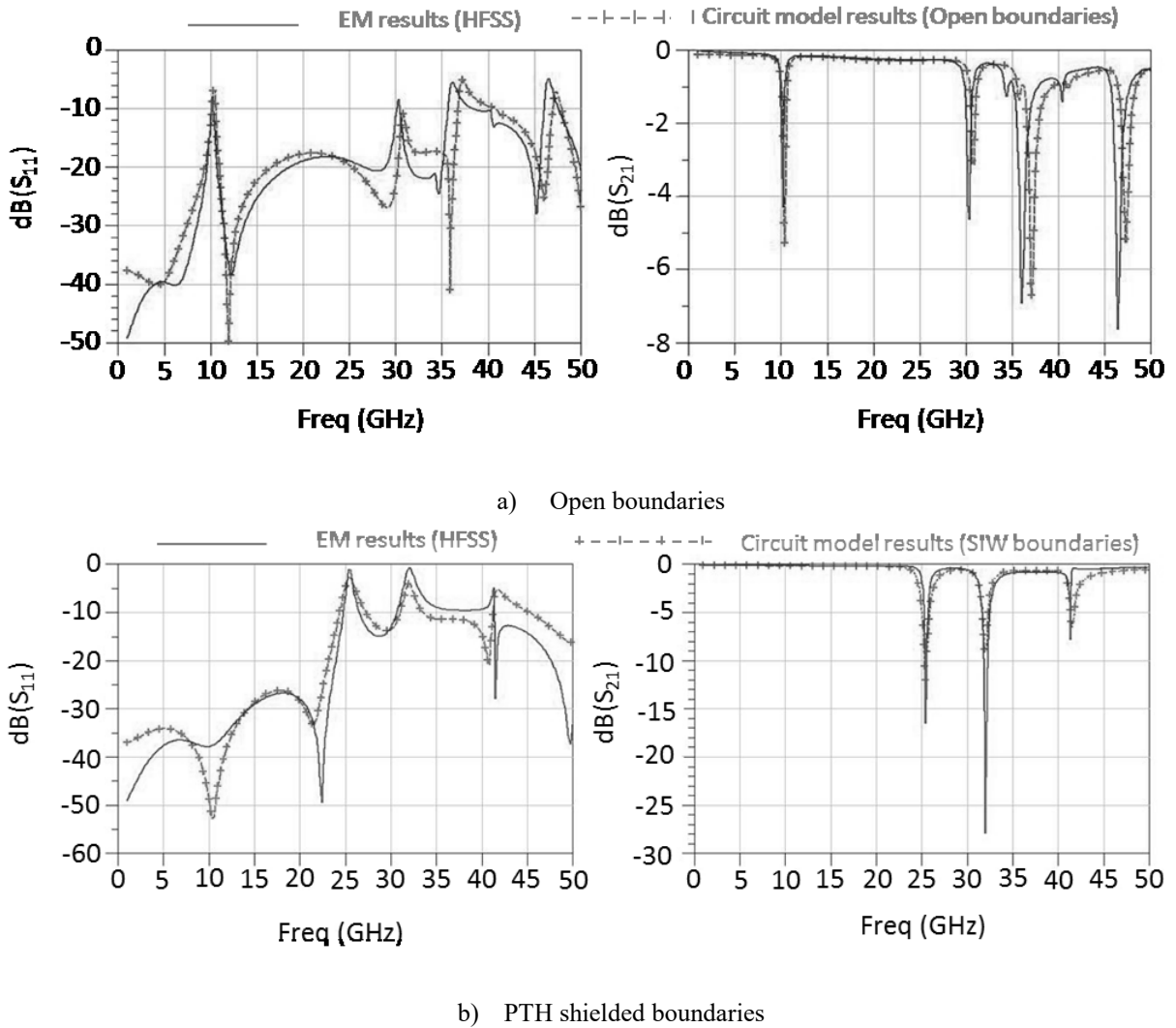

Fig. 8: Modelled S parameters for a double microstrip to stripline transition.

A multilayer structure with different boundary conditions for the parallel-plate cavities has also been studied using EM simulations. It consists in a double microstrip to stripline transition where the microvias are crossing two parallel-plate cavities. The dimensions of the structure are presented in Fig. 9. For the upper cavity, open boundary conditions were taken into account and for the lower cavity, PTHs ($d=200\mu\text{m}$ and $s=400\mu\text{m}$) shielded boundary were considered. The equivalent circuit used to model this structure is shown in Fig. 10. Two parallel-plates matrix impedances ($[Z_{PPU}]$ and $[Z_{PPL}]$) were used to model the interaction between vias and the parallel-plate cavities. For structures with more than one or two layers, an impedance matrix has to be determined for each cavity achieved between two metallic layers. These impedance matrices are then connected to the different ground planes of the different lines as it is done for the case of two cavities in Fig 10. The values of via characteristics were obtained by using Q3D extractor. For this example, the value of the resistive part of via inductance was $R_{VIA}=0.5\ \Omega$ and this value had only small influence on the simulated response.

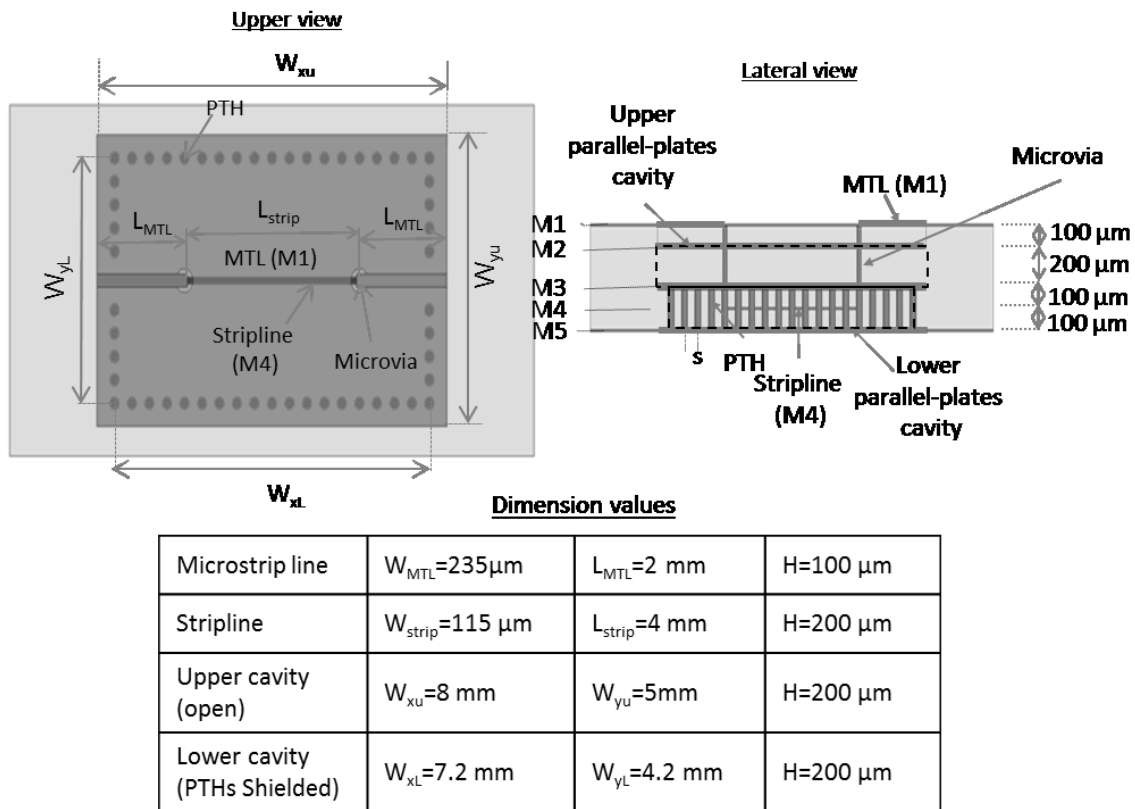

Fig. 9: Double microstrip to stripline transition with via crossing a parallel-plate cavities with different boundary conditions (Open for the upper cavity and PTHs shield for the lower).

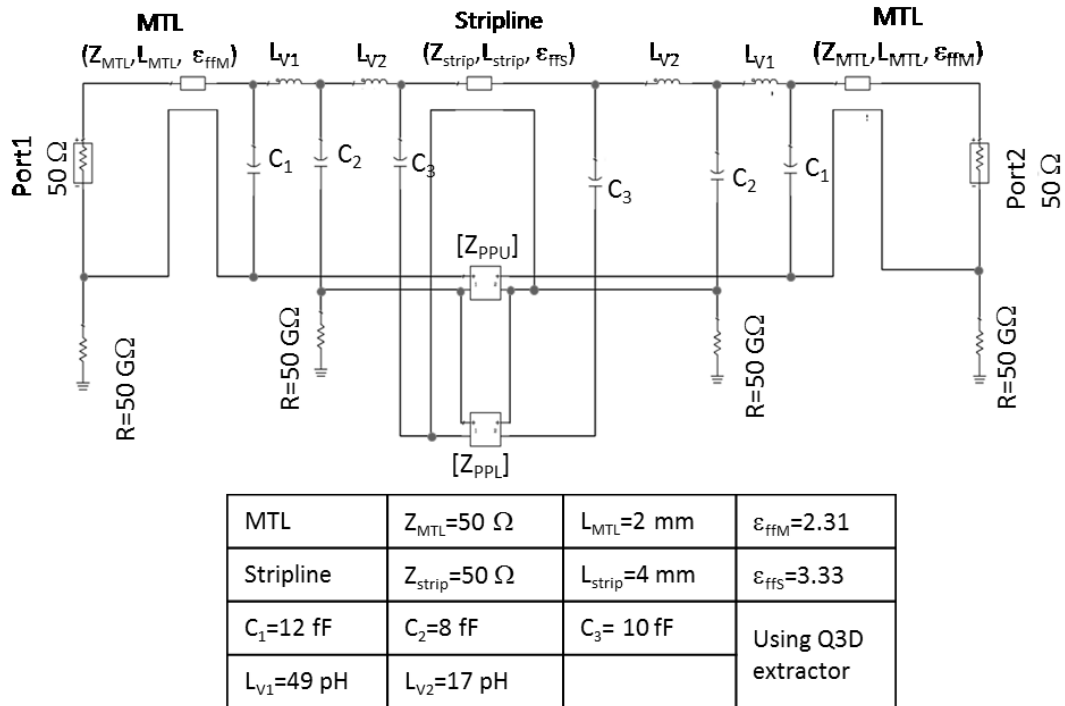

Fig. 10: equivalent circuit of a double microstrip to stripline transition where via crossing two different cavities.

The comparison of EM results and circuit simulation are presented in Fig. 11. A good agreement can be observed despite a small frequency shift for higher frequencies. This frequency shift can be due to non-dispersive model of equivalent dimensions especially for the open cavity case (the upper one). Nevertheless, the proposed model and equivalent circuit are able to well describe the behaviour of a multilayer structure with complex boundary conditions.

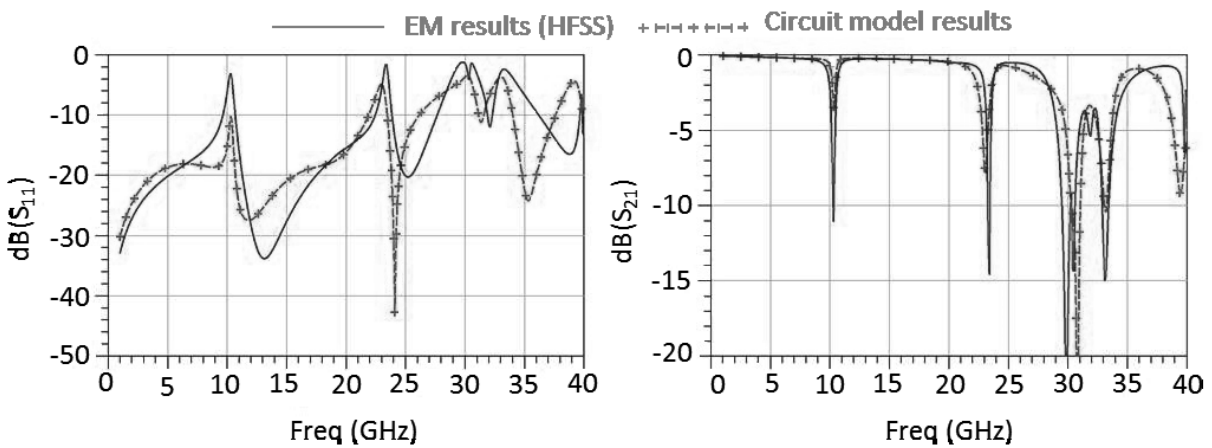

Fig. 11: S parameters of a back to back microstrip to stripline transition where the vias crossing to different cavities.

A last example consists of an embedded stripline stub filter realized using the AT&S technology. The filter was placed at metal level M3 of a 8 layers structure and it is excited by microstrip lines at level M1 and two stacked microvias (diameter $\phi=140 \mu\text{m}$) going through the ground M2 as illustrated in Fig 12-a. The metallic level M4 was a full ground plane and a parallel-plates cavity existed between levels M2 and M4. The cavity was shielded with PTHs

boundaries ($d=200\mu$, $s=400\mu$). The filter was designed to present a 30 GHz central frequency and a 50% relative bandwidth. The equivalent circuit model is shown in Fig 12-b. The use of isolation impedance of $50\ G\Omega$ allows to directly employ the $[Z_{pp}]$ matrix describing the behaviour of cavity formed by M2 and M4 floating ground planes. The value of the parasitic elements depict the microvias influence were obtained using the Q3D extractor. Microvias and transmission line values as well as filter stub characteristics are resumed in table 1.

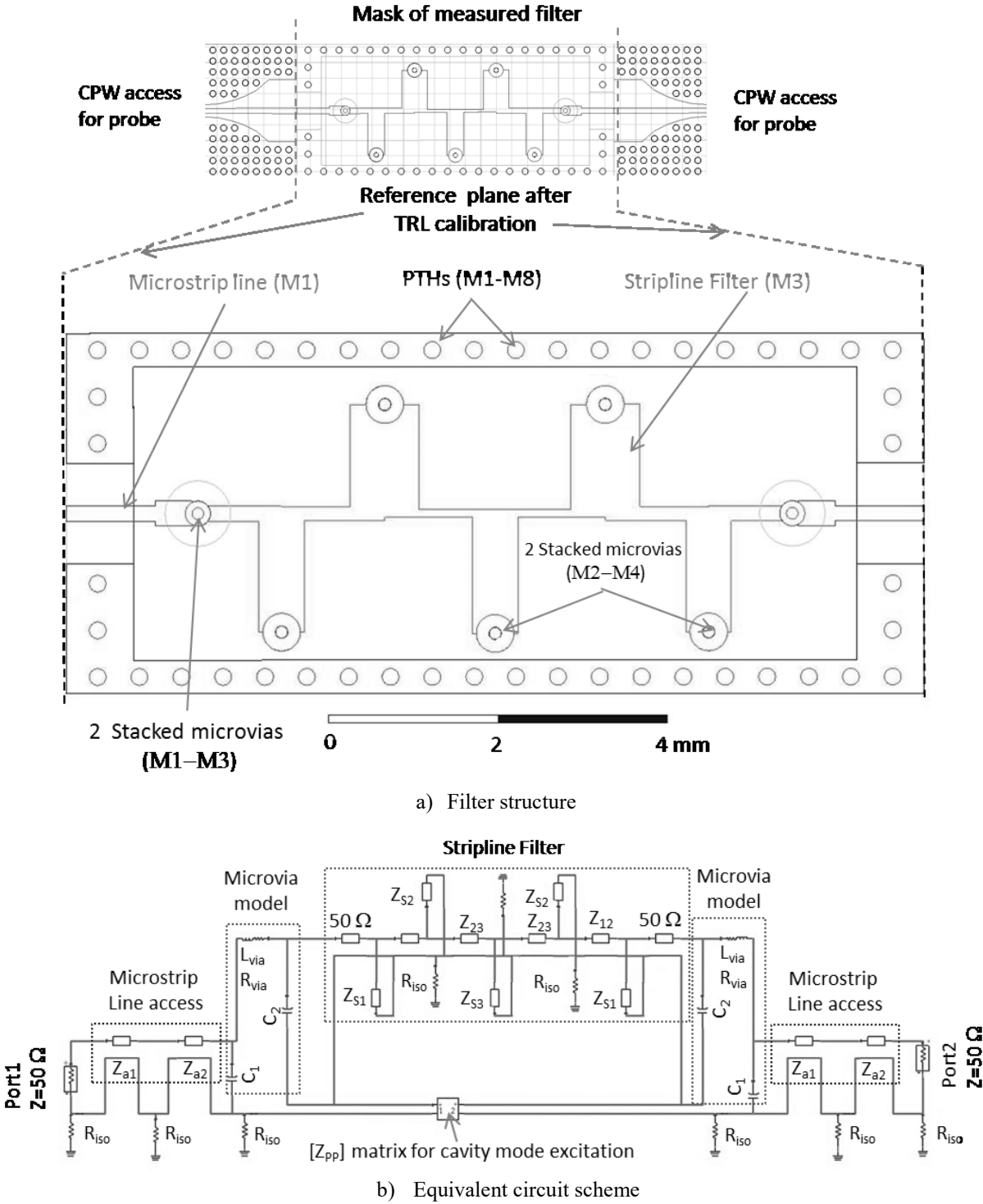

Fig. 12: embedded stripline filter structure and equivalent circuit

Table 1: Characteristics of access lines, filter lines and stubs and microvia model

Microstrip lines access		
$Z_{a1}=79.5 \Omega$	$L_{a1}=1058 \mu\text{m}$	$E_{\text{eff}1}=2.45$
$Z_{a2}=39.5 \Omega$	$L_{a2}=442 \mu\text{m}$	$E_{\text{eff}2}=2.58$
Stripline filter		
$Z_{s1}=25.57 \Omega$	$L_{s1}=1400 \mu\text{m}$	$E_{\text{eff}}=3.3$
$Z_{s2}=18.83 \Omega$	$L_{s2}=1400 \mu\text{m}$	$E_{\text{eff}}=3.3$
$Z_{s3}=18.24 \Omega$	$L_{s3}=1400 \mu\text{m}$	$E_{\text{eff}}=3.3$
$Z_{12}=53.60 \Omega$	$L_{12}=1400 \mu\text{m}$	$E_{\text{eff}}=3.3$
$Z_{23}=63.20 \Omega$	$L_{23}=1400 \mu\text{m}$	$E_{\text{eff}}=3.3$
Via characteristics		
$L_{\text{via}}=46 \text{ pH}$	$R_{\text{via}}=1 \Omega$	Obtained using Q3D extractor
$C_1=16 \text{ fF}$	$C_2=20 \text{ fF}$	

The S parameters of this filter were measured using a probe station and TRL calibration. The reference planes are shown in Fig. 12-a. The comparison between measurement results and circuit modelled responses are presented in Fig. 13. A good agreement between measurement results and circuit simulation ones can be observed over the all frequency bandwidth. The frequency discrepancy observed for the high frequency can be attributed to the manufacturing tolerances, to the simplicity of the available models of lines which do not take into account the dispersive behaviour and to the fact to neglect the vias connecting the stubs to the both grounds M2 and M4 which can perturb the fields in the cavity. Nevertheless the simply circuit model provides good approximations and it is able to predict suitably the transmission zeros in the filter bandwidth.

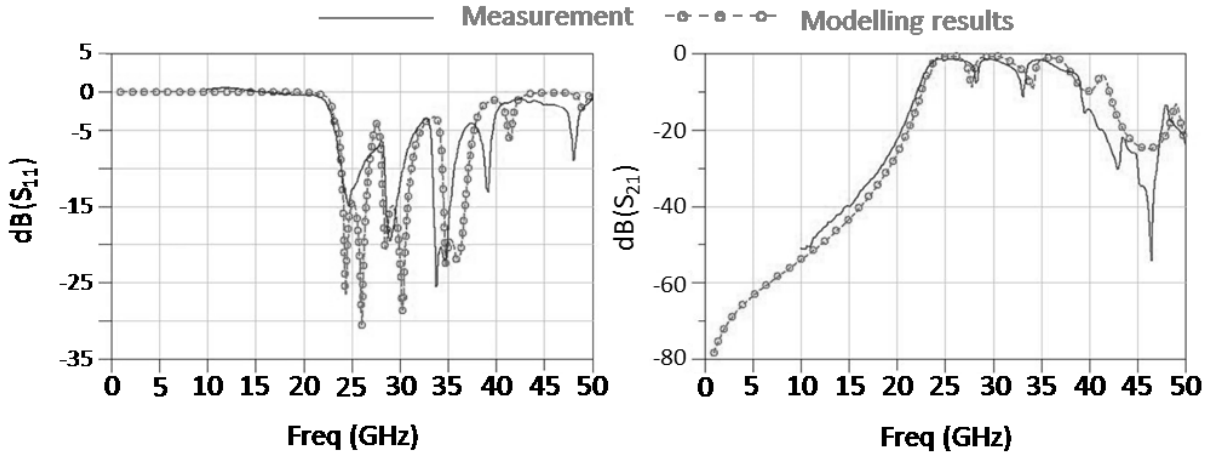

Fig. 13: S parameter responses of the PTH shielded stripline filter.

These three examples prove the usefulness and the accuracy of the proposed model of coupling between vias or microvias and parallel-plates cavities in multilayer structures.

V. Conclusion

In the first part of this paper the effects of the coupling between vias and microvias and cavities created by multi-level metal planes in multilayer structures like LTCC or HD-PCB have been outlined. Then, in order to take into account these parasitic effects, a tool based on the determination of impedance matrix of parallel planes $[Z_{PP}]$ has been proposed. To express the non-ideal character of some boundaries like open or PTHs shielded boundary conditions the

notion of effective dimensions considering the E-field mapping in the cavity have been introduced. The development of simple, intuitive and physical equivalent circuits has been also proposed. These models can be very useful to quickly predict and understand the behaviour of multilayer structures which include many vias, microvias, plated-through holes and parallel-plates. Finally, the parallel-plates impedance matrix associated with the intuitive equivalent circuit has been validated by using several comparisons with results obtained by electromagnetic simulations and measurements. Using this approach, good results have been obtained until 40 GHz for the open boundaries cases and until 50 GHz for PTH shielded boundary cases. As a future prospect, we intend to develop model for more complex shapes of cavities, to be able to simulate a lot of realistic multilayer structures. We will also work to propose a dispersion approach for open boundary to be able better described the behaviour beyond 40 GHz.

VI. References

- [1] H. Jantunen, T. Kangasvieri, J. Vähäkangas, and S. Leppävuori, "Design aspects of microwave components with LTCC technique," *J. Eur. Ceram. Soc.*, vol. 23, no. 14, pp. 2541–2548, Jan. 2003.
- [2] E. Li, X. Wei, A. C. Cangellaris, E. Liu, Y. Zhang, M. D. Amore, J. Kim, and T. Sudo, "Progress Review of Electromagnetic Compatibility Analysis Technologies for Packages , Printed Circuit Boards , and Novel Interconnects," *IEEE Trans. Electromagn. Compat.*, vol. 52, no. 2, pp. 248–265, 2010.
- [3] M. R. Abdul-Gaffoor, H. K. Smith, A. a. Kishk, and A. W. Glisson, "Simple and efficient full-wave modeling of electromagnetic coupling in realistic RF multilayer PCB layouts," *IEEE Trans. Microw. Theory Tech.*, vol. 50, no. 6, pp. 1445–1457, Jun. 2002.
- [4] S. Cadiou, C. Quendo, E. Schlaffer, W. Pessl, A. Le Fevre, M. Brizoux, and D. Baudet, "SIW Q-Band Filters using Advanced Multilayer PCB Technology," in *European Microwave Conference, EuMC 44th 2014 Roma*, 2014, pp. 1052–1055.
- [5] A. W. Mathis, A. F. Peterson, and C. M. Butler, "Rigorous and Simplified Models for the Capacitance of a Circularly Symmetric Via," *IEEE Trans. Microw. Theory Tech.*, vol. 45, no. 10, pp. 1875–1878, 1997.
- [6] J. R. M. T. Wang, R. F. Harrington, "Quasi-Static Analysis of a Microstrip Via Through a Hole in a Ground Plane," *IEEE Trans. Microw. Theory Tech.*, vol. 36, no. 6, pp. 1008–1013, 1988.
- [7] D. Kwon, J. Kim, K. Kim, S. Choi, J. Lim, J. Park, L. Choi, S. Hwang, and S. Lee, "Characterization and Modeling of a New Via Structure in Multilayered Printed Circuit Boards," *IEEE Trans. COMPONENTS Packag. Technol.*, vol. 26, no. 2, pp. 483–489, 2003.
- [8] M. E. Goldfarb and R. A. Pucel, "Modeling Via Hole Grounds in Microstrip," *IEEE Microw. Guid. Wave Lett.*, vol. 1, pp. 135–137, 1991.
- [9] R. Rimolo-donadio, X. Gu, Y. H. Kwark, M. B. Ritter, B. Archambeault, F. De Paulis, Y. Zhang, J. Fan, H. Brüns, and C. Schuster, "Physics-Based Via and Trace Models for Efficient Link Simulation on Multilayer Structures Up to 40 GHz," *IEEE Trans. Microw. Theory Tech.*, vol. 57, no. 8, pp. 2072–2083, 2009.
- [10] C. Schuster, Y. Kwark, G. Selli, and P. Muthana, "Developing a ' Physical ' Model for Vias," in *DesignCon 2006*, 2006.
- [11] I. Ndip, F. Ohnimus, L. Kai, M. Bierwirth, C. Tschoban, S. Guttowski, H. Reichl, K. Lang, and H. Henke, "Modeling , Quantification , and Reduction of the Impact of Uncontrolled Return Currents of Vias Transiting Multilayered Packages and Boards," *IEEE Trans. Electromagn. Compat. VOL. 52, NO. 2, MAY 2010*, vol. 52, no. 2, pp. 421–435, 2010.
- [12] G. Heinrich and S. Dickmann, "Interactions between Vias and the PCB Power-Bus," *2009 20th Int. Zurich Symp. Electromagn. Compat.*, pp. 257–260, Jan. 2009.

- [13] M. M. Pajovic, J. Yu, Z. Potocnik, and A. Bhohe, "Gigahertz-Range Analysis of Impedance Profile and Cavity Resonances in Multilayered PCBs," *IEEE Trans. Electromagn. Compat.*, vol. 52, no. 1, pp. 179–188, Feb. 2010.
- [14] A. Gupta, C. Rames, Gar, G, Inde, R, Bah, L, Prakas, H, Bharti, and A, *Microstrip lines and Slotlines*, 3th editi. BOSTON, LONDON: ARTECH HOUSE.
- [15] Y. Tao, W. Hong, and H. Tang, "Design of A Ka-Band Bandpass Filter Based on High Ordrer Mode SIW Resonator," in *7th International Symposium on Antennas, propagtion & EM Theory 2006 ISAPE*, 2006, no. 2, pp. 2–4.
- [16] F. Xu and K. Wu, "Guided-wave and leakage characteristics of substrate integrated waveguide," *IEEE Trans. Microw. Theory Tech.*, vol. 53, no. 1, pp. 66–73, Jan. 2005.