



HAL
open science

In-Process Tool Wear Monitoring in Internal Broaching

Iñigo Bediaga, Christian Ramirez, Kepa Huerta, Christian Krella, Jokin Munoa

► **To cite this version:**

Iñigo Bediaga, Christian Ramirez, Kepa Huerta, Christian Krella, Jokin Munoa. In-Process Tool Wear Monitoring in Internal Broaching. UMTIK 2016 - 17th International Conference on Machine Design and Production, Jul 2016, Bursa, Turkey. hal-01353881

HAL Id: hal-01353881

<https://hal.science/hal-01353881>

Submitted on 15 Aug 2016

HAL is a multi-disciplinary open access archive for the deposit and dissemination of scientific research documents, whether they are published or not. The documents may come from teaching and research institutions in France or abroad, or from public or private research centers.

L'archive ouverte pluridisciplinaire **HAL**, est destinée au dépôt et à la diffusion de documents scientifiques de niveau recherche, publiés ou non, émanant des établissements d'enseignement et de recherche français ou étrangers, des laboratoires publics ou privés.

IN-PROCESS TOOL WEAR MONITORING IN INTERNAL BROACHING

Iñigo BEDIAGA, *ibediaga@ideko.es* IK4-IDEKO, 20870, Elgoibar, Basque Country, Spain
Christian RAMIREZ, *cramirez@ideko.es* IK4-IDEKO, 20870, Elgoibar, Basque Country, Spain

Kepa HUERTA, *khuerta@ekin.es* EKIN, 48340, Amorebieta, Basque Country, Spain
Christian KRELLA, *C.Krella@wzl.rwth-aachen.de* Laboratory for Machine Tools and Production Engineering (WZL), RWTH Aachen University, 52074, Aachen, Germany
Jokin MUNOA, *jmunoa@ideko.es* IK4-IDEKO, 20870, Elgoibar, Basque Country, Spain.

ABSTRACT

In this work, an “in process” tool wear prediction system for broaching process is presented based on a cutting force analysis. The aim is to link the changes in the measured force with the tool wear. Once the broaching cycles have been performed, different strategies have been analyzed including the evolution of the maximum peak force and the evolution in the used broaching energy per section. Finally, the results of the analysis and the main conclusions are presented.

Keywords: Broaching, monitoring, tool wear.

1. INTRODUCTION

Machining is an essential process in most industrial manufacturing procedures, because it can create a variety of part shapes with tight tolerances over a wide range of materials. However, due to the aggressive nature of metal cutting, the presence of chatter and/or excessive wear on the tool can dramatically impact on the product quality and productivity [Altintas and Weck, 2004; Zatarain et al, 2004; Mancisidor et al, 2014].

There has been a significant amount of research in monitoring of machining processes such as turning, milling and drilling [Dimla, 2000]. However, less effort has been dedicated to the monitoring of broaching and similar special operations. Broaching is a high productivity operation that permits mass production of parts with complex geometries. Considering the significant technical and economic implications of the broaching processes in strategic industrial sectors like aerospace, the aim of this work is to develop a system to monitor the broaching process to maintain the quality of the parts.

Broaching is a shaping process that is used to manufacture massively parts with complex internal and/or external profiles, which are not possible to machine using more flexible metal cutting methods. One of the main challenges is to monitor tool wear, taking into account that

the condition of the tool has crucial importance for the surface quality of the machined components. In broaching, the cost of the tool named broach can be really high compared with other processes. Therefore, it is important to maximize the productivity reducing the tool cost by programming properly the change of the broach, but avoiding tool malfunctions that can damage severely the final component.

Nowadays, the tool is often inspected visually by an expert that determines the situation. The final goal of this research is to implement a continuous and automatic monitoring system to define the condition of the tool including the wear.

2. STATE OF THE ART

Process monitoring is based on the utilization of observable and measurable process and product parameters to evaluate the state of a system including different mechanical elements [Fernandez et al, 2005; Bediaga et al, 2013]. These parameters include product features such as; surface roughness or geometric dimensions and process variables, such as, machine speeds and forces. There is a need to adapt and refine current statistical process monitoring and quality control methods to take full advantage of the available data. In the last years, the monitoring has increased its impact thanks to the introduction of new embedded sensors and the tremendous enhancement in the data storage possibilities. This revolution has open new possibilities for big data treatment by means of smart analytics.

However, broaching processes are not a common target for this new techniques and the state of the art in the monitoring processes for that operations is limited. First of all, it is important to consider the articles related to broaching process modeling. The geometry of the tool is especially important in broaching, therefore, the broaching process models have been applied for tool design and optimization [Konkurk and Budak, 2004; Ozelkan et al, 2010]. Ozlu et al. (2010) simulated broaching operations, proposing analytical approaches for both mathematical and geometrical modeling that result in very fast solution times and accurate predictions. Mandrile et al. (2012) implemented a methodology to simulate cutting forces in fir tree broaching. Recently, Chopaldi and Kuttan (2014) implemented a mechanistic model for the cutting force in rectangular slotting operation, validating this model with experimental test. An energy based analysis of broaching operation was performed by Kishawy et al. (2012), where the cutting force simulation was applied to quantify the contribution of different power components of the cutting system. These efforts reached the market when MAXIMA launched a broaching process simulator named BOSS[®]. Similarly, Klocke et al. (2015) implemented a mathematical model employing successfully the Kienzle-force model to get the cutting force of a non-tested broach [Klocke et al 2015; Munoa et al 2006].

On the other hand, there are some articles related to the experimental monitoring of the broaching process: For instance, Axinte and Gindi (2003) showed that acoustic emission, vibration and cutting force signals were sensitive to tool condition, and a correlation could be made between the broaching tool situation and sensor signals. This paper reveals the high affectivity of cutting forces detecting the tool conditions like chipped edges, broken flute and worn tool. The same research group reports an attempt to use a combination of acoustic emission (AE) and force signals to detect surface anomalies broaching parts made in Ti6-4 alloy [Axinte et al, 2005]. They emphasized that acceleration signals, due to their low sensitivity to material deformation, are not capable to detect surface anomalies, relying this purpose on AE and cutting force signals. The same author continued working in this area, studying the use of probabilistic neural networks for automated classification of tool malfunctions. The aim of this work was to define a strategy to process the output signals acquired during broaching in order to detect and clarify the condition of the teeth of broaching tools [Axinte, 2006]. In this work, Axinte presents a method to automatically detect and clarify tool malfunctions based on specific pattern of the force. He also carried out the monitoring of experimental broaching tests, analyzing simultaneously the acceleration and cutting force signals reporting for the first time aspects related to dynamics of broaching when complex geometries were generated [Axinte, 2007].

Bound and Gilti (2006) monitored broaching process and analyzed the measurement of acoustic emission, cutting force and vibration signal for the identification of surface anomalies and tool condition. Finally, Rathinam (2013) implemented also a methodology for in process monitoring.

The objective of this work is to perform the first step to develop an industrial broaching monitoring system based on smart analytics. In this first step, the life of a broaching tool has been monitored during the life of the tool in industrial conditions by means of different sensors including acceleration and force transducers.

3. DESIGN AND VERIFICATION OF THE EXPERIMENTAL SET-UP

An experimental set-up was prepared to measure the force and the acceleration during the internal broaching process of 2000 parts to capture the evolution of the wear of the broaching tool.

3.1. Experimental set-up

Taking into account the big amount of pieces to be machined, a test layout was designed in order to facilitate the tests. The set-up consists on a Kistler dynamometric plate, a signal amplifier for the plate, an acquisition card and an embedded PC.

The layout is shown in Figure 1 where a Kistler dynamometric plate is connected with the signal amplifier and the acquisition card. The acquisition card records the measured force and sends it to the PC. The start and stop of the measurement is established by the PLC of the machine, which is connected to the PC and signal amplifier (triggering signal).

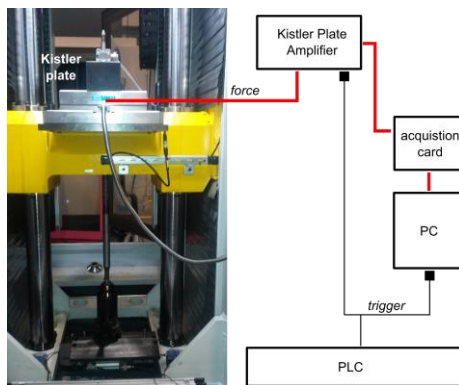

Figure 1. Test layout for multiple signal recording.

3.2. Broaching parameters

The selected tool is a 30-spline broach with 58 teeth with a pitch of 8mm. In Figure 2, the basic geometry of the cutting flutes of the broach is described. The selected tool has a tooth thickness of 2.5mm, a depth of tooth of 2.7mm, a radius of 1.6mm, a rake angle of 15 degrees, and a clearance angle that varies from 0 degree to 2 degrees. The depth of cut per tooth is 0.043mm, and it is maintained constant for each tooth.

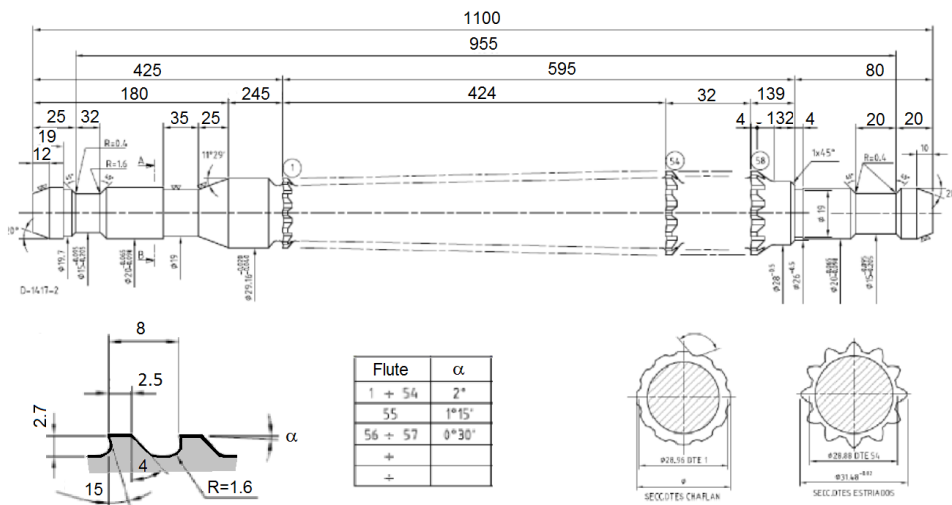

Figure 2. Geometry of the broach.

In this case, the broach has not any coating to accelerate the wear process on it. The cutting speed is fixed on 50m/min without any coolant.

The target parts are made of C45 steel having a height of 40mm and a diameter of 50mm (See Figure 3).



Figure 3. Test workpiece

4. PRELIMINARY EXPERIMENTAL RESULTS

Some preliminary tests were performed using same broaching parameters fixed in the previous chapter to validate the experimental set-up and define the best signal treatment strategy.

Initially, the raw signal (See Figure 4) is acquired with a sampling frequency of 4096 samples per second. If the time domain signal of the axial broaching force is observed, the force measurement looks noisy but it is possible to appreciate a clear trend during the machining process.

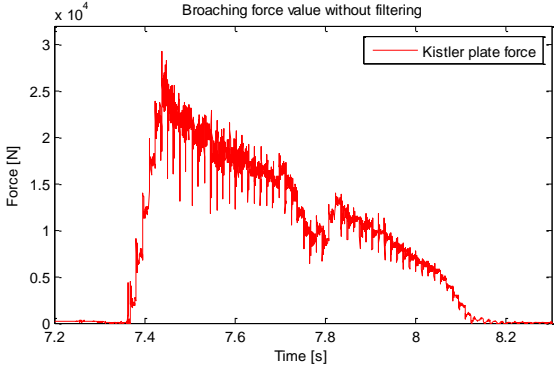

Figure 4. Original force signal

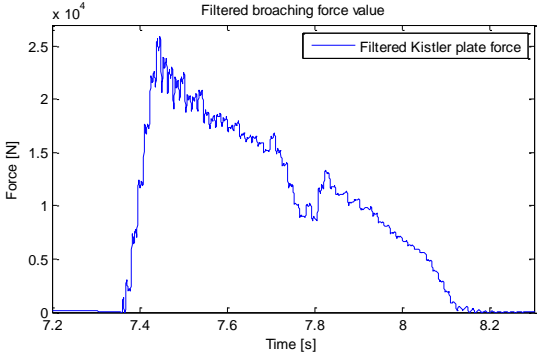

Figure 5. Filtered force signal (180Hz).

However, one of the objectives of the monitoring system is to identify a failure in the broach and to determine the damaged flute. In order to avoid the high frequency components a low pass filter can be applied considering a frequency higher than the tooth passing frequency (see Figure 5). In this case the force signal becomes clearer, and it is easy to distinguishing the force produced by each tooth checking the time domain filtered signal (see Figure 6).

With the objective of analyzing separately the different parts of the broaching process, the force signal was divided in two portions (See Figure 6). The initial portion starts with the force component of the first teeth, while the final portion includes the last teeth. Then, a spectral analysis of the unfiltered or raw force signal was carried out by means of a Fast Fourier Transformation (FTT).

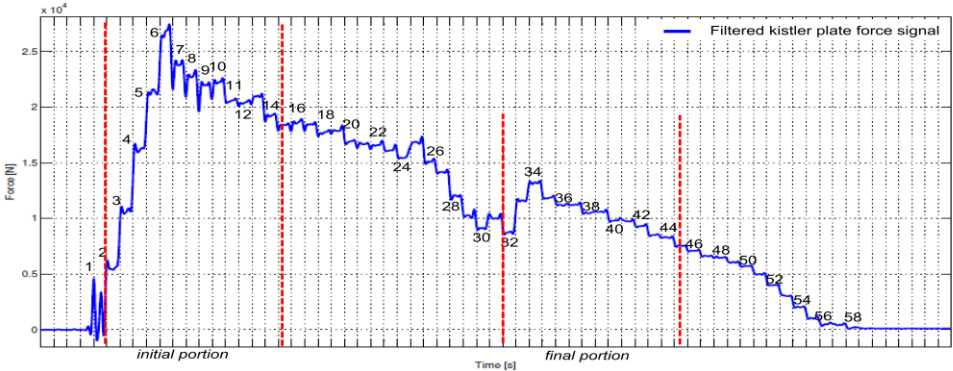

Figure 6. Kistler plate measured force divided in two stretches

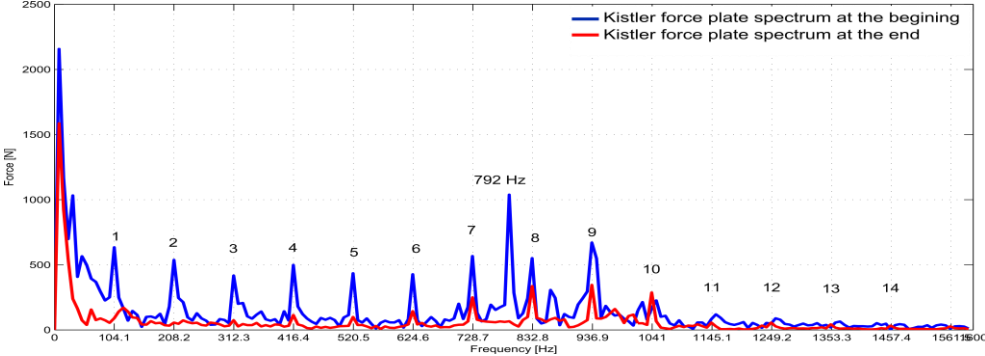

Figure 7. Comparison between the spectrum of the first and the last part

The spectrum of the first portion shows (see Figure 7) the appearance of the maximum peak at 792 Hz, which is not a harmonic of the tooth passing frequency. However, the spectral analysis of the last time portion shows that the previous peak disappears.

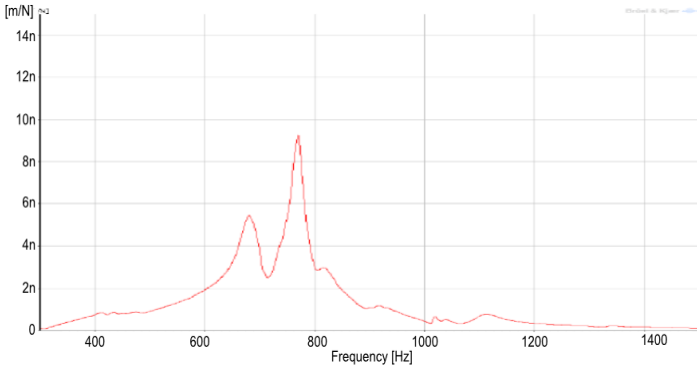
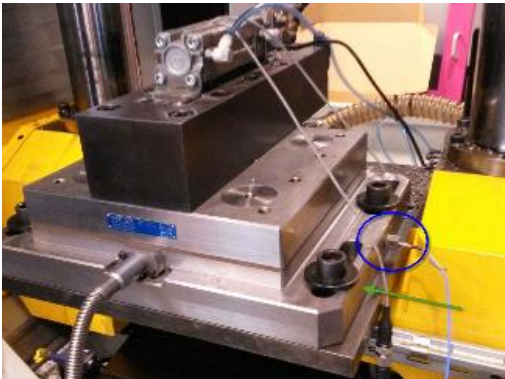

Figure 8. Dynamic analysis of dynamometric plate (excitation point green arrow, and measurement point indicated by a blue circle)

This peak could exist due to different causes, and with the aim of finding the real cause, a dynamic analysis was performed. This analysis consisted in taking frequency response functions (FRF) at different points of the system.

After analyzing all the system, it was found out that the dynamometer plate mounting block (See Figure 8) had a natural frequency close to the peak shown in the spectrum, as is shown in the FRF (See Figure 8). This FRF clearly shows a natural frequency in the same range than the peak mentioned before. Several tests at different cutting speeds were carried out appearing always a peak close to 800 Hz. Therefore, the highest peak was concluded to be chatter, and the source of the chatter problem comes from the flexibility of the torsional mode of the dynamometer plate block.

Finally, the dynamometric plate overhang was reduced and stiffen, getting almost disappeared the torsional mode as result and removing chatter vibrations from the broaching cycle.

5. BROACHING FORCE EVOLUTION CONSIDERING WEAR

A procedure has been developed to monitor tool wear by means of different indicators in every broaching cycle. The filtered time domain signal is divided in three sections and different thresholds are defined. The main parameters are described in Figure 9.

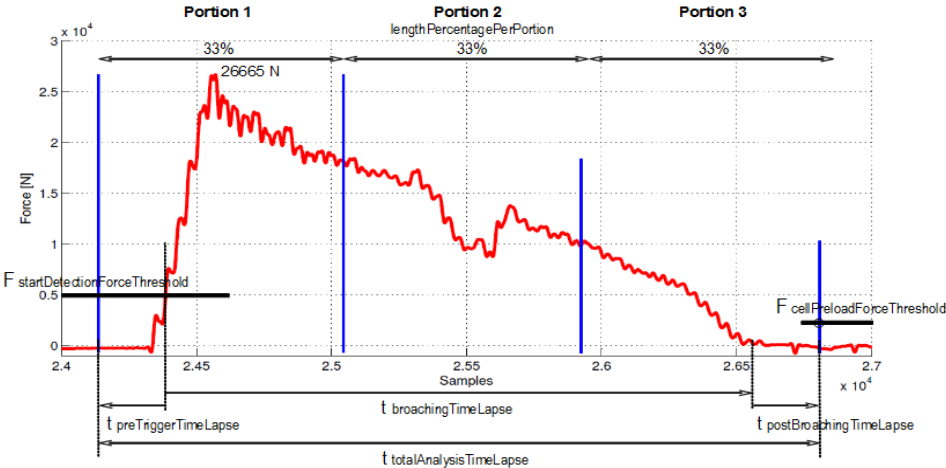

Figure 9. Presentation of the parameters and indicators used for describing the broaching force.

The analysis of the complete life of the broach requires the monitoring of a large number of parts. Therefore, it is important to automatize the measuring process of the broaching process. The designed program incorporates several thresholds and time lapses to ensure that force signal is adequate, and is completely acquired. There is a threshold fixed at the beginning of the signal warning when the broaching force starts. When this threshold is

achieved a pre trigger time lapse is also activated that permits to capture a portion of the signal before the trigger.

On the other hand, there is another threshold at the last part of the signal that is in charge of defining the end of the measurement. This threshold is used to corroborate that the machining is finished, and to fix post broaching time lapse that adds final data to consider the entire signal.

More than 2000 broaching tests were carried out, and different indicators were obtained for each part including the maximum force peak, the energy consumption and the average force value per tooth. Finally the real tool wear was checked visually every 500 test.

5.1 Evolution of the maximum force peak:

The first indicator is the maximum value of the filtered signal of the measured broaching force. The maximum force peaks fluctuate from one measurement to another, but it shows a clear trend. Logically, the maximum force rises with the wear of the flutes. In order to obtain the mentioned trend a linear regression is applied.

The trend of the maximum force peak values is increasing from an initial value of 27230 N to a final value of 32520 N (See Figure 2).

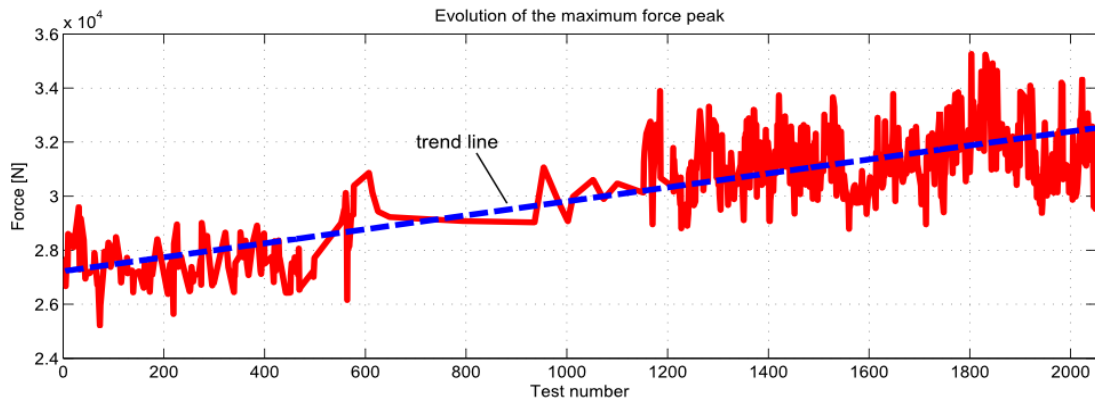

Figure 2. Evolution of the force peak

5.2 Evolution of the expended energy per section:

The mathematical principle used to calculate the energy (N*m or J) consists in multiplying the force (N) by the cutting speed (m/min) and by the sampling period (s).

$$e_i = -\frac{f}{120 \cdot F_s} \sum_{K=1}^{N_j} \{F_{K+1} + F_K\} \quad (\text{Equation 1})$$

Where, e : energy in the i^{th} test number [J], f : cutting speed [m/min], F_s : sampling frequency [Hz], i : test number, K : sample, N_j : number of samples in the j^{th} portion.

The broaching tool is composed by a high number of flutes, and it is important to identify where the wear is growing more. Therefore, the whole process is divided in three sections to calculate the evolution of the consumed energy. Each section considers 33% of the broach longitude. With this discretization is possible to appreciate the energy consumed by the initial, the middle side or the final part of the broach giving the opportunity to reveal what of the teeth are wearing faster. The trend line is also calculated fitting the energy values to a first order polynomial for each section.

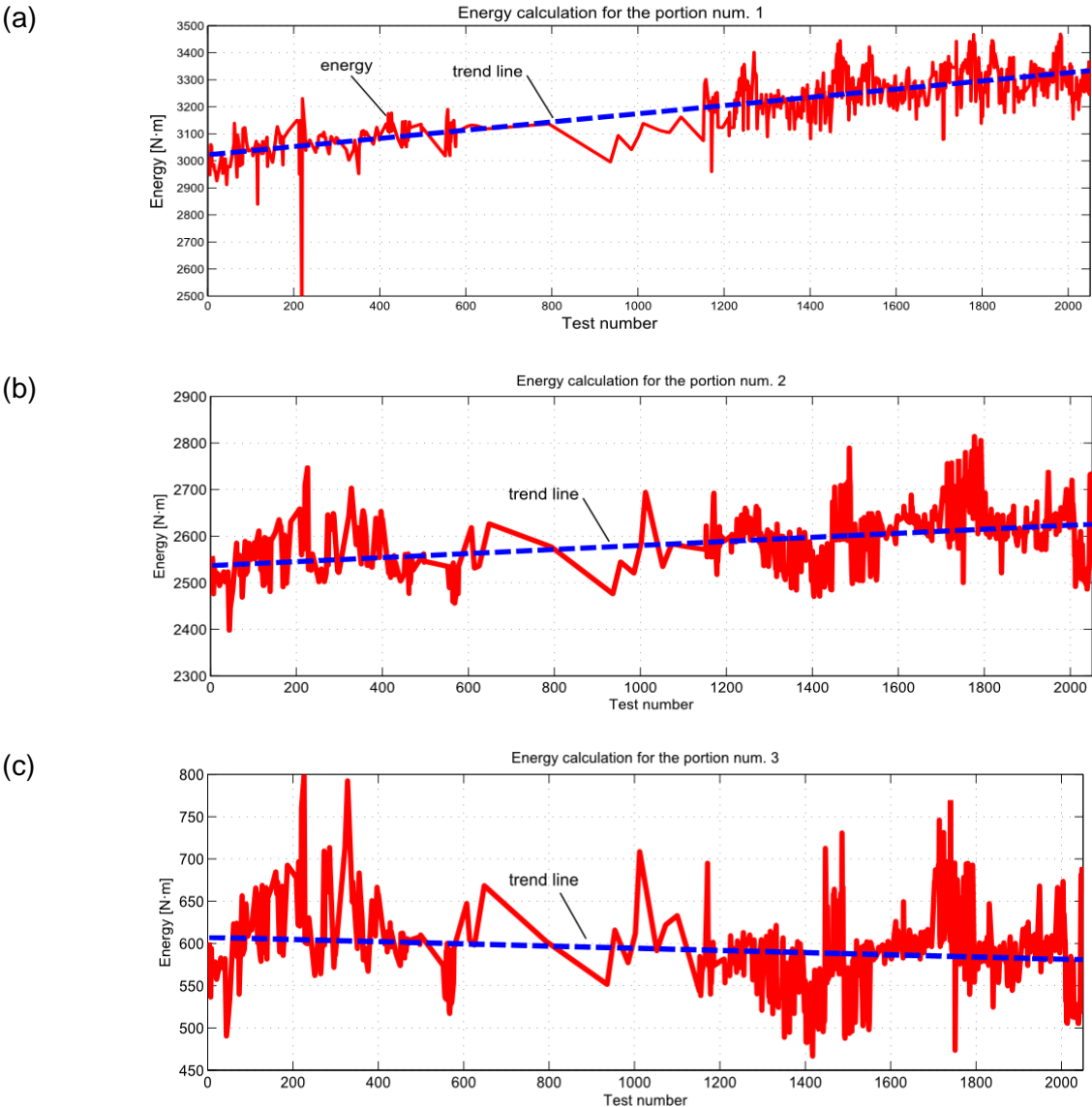

Figure 11. Evolution of the energy expended in the first (a), second (b) and third (c) sections.

In this particular case, the trend of the energy value in the first portion is increasing from an initial value of 3023J to a final value of 3334J. The increase can be established in a 9.3% (See Figure 11(a)). In the second portion the energy increase is lower during these 2000 broaching operations reaching a 3.4% of increase from 2537 Nm to 2626 Nm (See Figure 11(b)). The trend for the third period maintains almost constant, even is slightly decreasing (See Figure 11(c)). According to this indicator, wear grows basically in the first section of the broaching tool.

5.3 Evolution of mean value of each tooth:

This analysis gives the chance to know the situation of each tooth. The previous indicator showed that the first teeth suffer more wear, and therefore, this analysis was focused on the first flutes (See Figure 12). The analysis of the average value of the force determined that the bigger difference in absolute values was appreciated in the fifth tooth (See Table 1).

Table 1. Difference per tooth

Nº Tooth	1º	2º	3º	4º	5º	6º	7º	8º	9º	10º	11º
Difference (N)	2540	2480	5230	8580	8870	2820	4210	3520	1530	1590	1370
Difference (%)	49,29	29,51	33,30	25,73	30,20	9,41	14,47	12,83	6,16	6,28	5,83

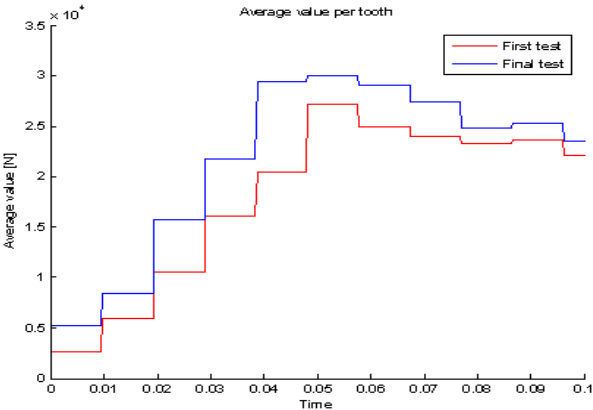

Figure 12. Average value per tooth

5.3 Broach wear analysis:

The wear of the 5th, 20th, 35th and 55th have been analyzed visually by means of pictures obtained after every 500 parts. These figures are in line with indicators obtained from the analysis of the force measurement, presenting the bigger wear in the fifth tooth, and decreasing the wear in the subsequent flutes.

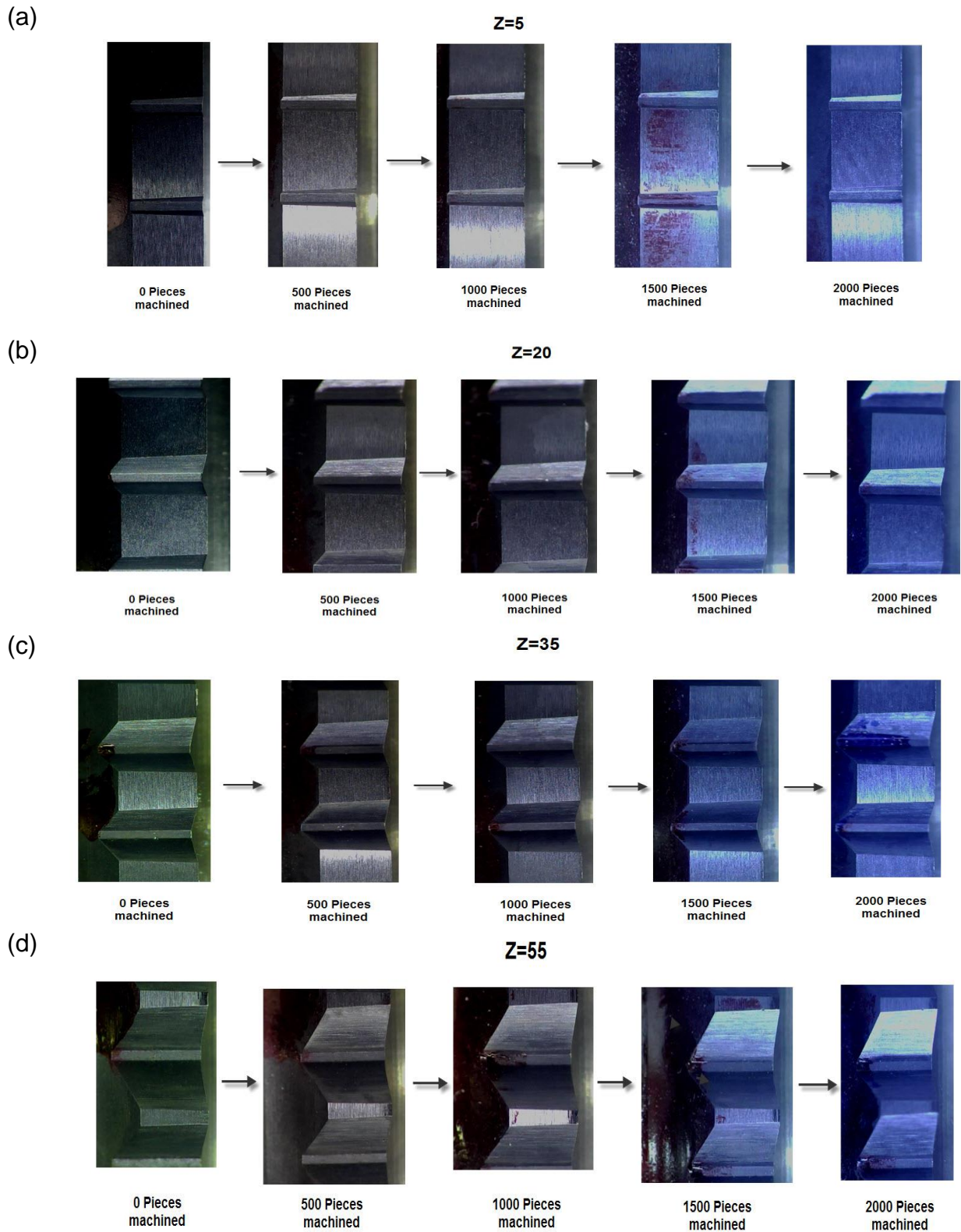

Figure 13. Pictures of the 5th, 20th, 35th and 55th for every 500 tests

6. CONCLUSIONS

This paper presents a force analysis of the broaching process during whole life of the broaching tool. This analysis has been made using different indicators including the evolution

of the maximum peak force, the evolution of the consumed energy and the average value of the force per flute. A general conclusion of the research is that the axial force peak increases with the wear, and that the wear of the broach does not evolve constantly through all the surface of the broach because of a non-linear distribution of the broaching forces that are higher on the first 10 teeth.

The first section of the broach shows clearly an increasing trend for the consumed energy. This fact is validated by the conventional analysis performed taking pictures of every 500 tests.

ACKNOWLEDGEMENT

The authors would like to acknowledge the support of the European Commission under research activities carried out inside FoF.NMP.2013-8 EASE-R3 project (grant number 608771).

6. REFERENCES

- 1. Altintas, Y., Weck, M. (2004)**, "Chatter stability of metal cutting and grinding" CIRP Annals-Manufacturing technology, Vol. 53, No. 2, pp 619-642.
- 2. Axinte, D., (2006)**, "Approach into the use of probabilistic neural networks for automated classification of tool malfunctions in broaching", International Journal of Machine Tools and Manufacture, Vol. 46, No. 12–13, pp 1445–1448.
- 3. Axinte, D., (2007)**, "An experimental analysis of damped coupled vibrations in broaching", International Journal of Machine Tools & Manufacture, Vol. 47, No. 14, pp 2182–2188.
- 4. Axinte, D., Boud, F., Penny, J., Gindy, N., (2005)**, "Detection of Workpiece Surface Anomalies on Dovetail Slots through Process Monitoring", CIRP Annals - Manufacturing Technology, Vol. 54, No. 1, pp 87–90.
- 5. Axinte, D. Gindy, N., (2003)**, "Tool condition monitoring in broaching", Wear, Vol. 254, No. 3–4, pp 370–382.
- 6. Bediaga, I., Mendizabal, X. Arnaiz, A., Munoa, J., (2013)**, "Ball bearing damage detection using traditional signal processing algorithms", IEEE Instrumentation & Measurement Magazine, Vol. 16, No. 2, pp 20-25.

- 7. Bediaga, I., Mendizabal, X. Etxaniz, I., Munoa, J., (2013),** “An integrated system for machine tool spindle head ball bearing fault detection and diagnosis”, IEEE Instrumentation & Measurement Magazine, Vol. 16, No. 2, pp 42-47.
- 8. Bound, F., Gindy, N., (2008),** “Application of multi-sensor signals for monitoring tool/workpiece condition in broaching”, International Journal of Computer Integrated Manufacturing. Vol. 21, No. 6, pp 715-729.
- 9. Dimla, E., (2000),** “Sensor signals for tool-wear monitoring in metal cutting operations—a review of methods”, International Journal of Machine Tools and Manufacture, Vol. 40, No. 8, pp 1073-1098.
- 10. Chopaldy, R.K., Kuttan, A., (2014),** “Mechanistic Force Modeling for Broaching Process”, International Journal of Manufacturing Engineering, Vol. 2014, Article ID 485712.
- 11. Fernandez, A., Bilbao, J. Bediaga, I., Gaston, A., Hernandez, J., (2005),** “Feasibility study on diagnostic methods for detection of bearing faults at an early stage”, Proceeding of WSEAS International Conference, pp 2-4.
- 12. Kishawy, H.A., Hosseini, A., Moetakef-Imani, B., Astakhov, V.P., (2012),** "An energy based analysis of broaching operation: Cutting forces and resultant surface integrity", CIRP Annals – Manufacturing Technology, Vol. 61, No. 1, pp 107–110.
- 13. Klocke, F., Adams, O., Auerbach, T., Gierlings, S., Kamps, S., Rekers, S., Veselovac, D., Eckstein, M., Kirchheim, A., Blattner, M., Thiel, R., Kohler, D., (2015),** "New concepts of force measurement systems for specific machining processes in aeronautic industry", CIRP Journal of Manufacturing Science and Technology, Vol. 1, pp 552–557.
- 14. Kokturk, U., Budak, E. (2004),** “Optimization of broaching tool design”, Proceeding of the 4th CIRP International Seminar on Intelligent Computation in Manufacturing Engineering Conference (ICME) Sorrento, Italy.
- 15. Mancisidor, I., Urkiola, A., Barcena, R., Munoa, J., Dombovari, Z., Zatarain, M., (2014),** “Receptance coupling for tool point dynamic prediction by fixed boundaries approach”, International Journal of Machine Tools and Manufacture, Vol. 78, pp 18-29.
- 16. Mandrile, S., Cazenave-Larroche, G., Vernault, C., Dessein, G., Denape, J., Paris, J.Y., (2012),** "Development of an in-house cutting forces simulation for fir tree broaching process", MUGV 2012, Saint-Etienne, France, October 2012.
- 17. Munoa, J., Zatarain, M., Bediaga, I., Peigne, G. (2006),** “Stability study of the milling process using an exponential force model in frequency domain”, Proceedings of CIRP-2nd International High Performance Cutting (HPC) Conference, Vancouver, Canada.

- 18. Ozelkan E.C., Ozturk O., Budak E. (2011)**, "Identifying parameters of a broaching design using non-linear optimization", International Journal of Modeling, Identification and Control, Vol. 12, No. 3, pp 244-252.
- 19. Ozlu, E., Engin, S., Cook, C., El-Wardany, T., Budak, E., (2010)**, "Simulation of Broaching Operations", 2nd International CIRP Conference on Process Machine Interactions (PMI 2010), Vancouver, Canada.
- 20. Rathinam, A.C., (2013)**, "Design, Implementation and Use of In-Process Sensor Data for Monitoring Broaching and Turning Processes: A Multi-Sensor Approach", M. Sc. Thesis, Virginia Polytechnic Institute, USA.
- 21. Zatarain, M. Munoa, J. Villasante, C., Sedano, A. (2004)**, "Estudio comparativo de los modelos matemáticos de chatter en fresado: monofrecuencia, multifrecuencia y simulación en el tiempo", XV Congreso de Máquinas-Herramienta y Tecnologías de Fabricación, pp 179-192.