



**HAL**  
open science

## Development of a catalyst for highly concentrated hydrogen peroxide

Jean-Yves Lestrade, Pierre Prévot, Jérôme Messineo, Jérôme Anthoine, Santiago Casu, Bastian Geiger

► **To cite this version:**

Jean-Yves Lestrade, Pierre Prévot, Jérôme Messineo, Jérôme Anthoine, Santiago Casu, et al.. Development of a catalyst for highly concentrated hydrogen peroxide. Space Propulsion 2016, May 2016, Rome, Italy. hal-01353568

**HAL Id: hal-01353568**

**<https://hal.science/hal-01353568>**

Submitted on 12 Aug 2016

**HAL** is a multi-disciplinary open access archive for the deposit and dissemination of scientific research documents, whether they are published or not. The documents may come from teaching and research institutions in France or abroad, or from public or private research centers.

L'archive ouverte pluridisciplinaire **HAL**, est destinée au dépôt et à la diffusion de documents scientifiques de niveau recherche, publiés ou non, émanant des établissements d'enseignement et de recherche français ou étrangers, des laboratoires publics ou privés.

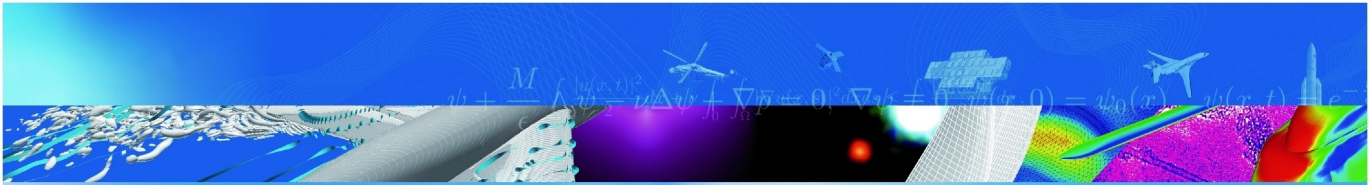

COMMUNICATION A CONGRES

## Development of a catalyst for highly concentrated hydrogen peroxide

J.-Y. Lestrade (ONERA), P. Prévot (ONERA),  
J. Messineo (ONERA), J. Anthoine (ONERA),  
S. Casu, B. Geiger (Heraeus Deutschland GmbH)

Space Propulsion 2016

ROME, ITALIE

2-6 mai 2016

TP 2016-467

**70** 2016  
ans

**ONERA**

THE FRENCH AEROSPACE LAB

# DEVELOPMENT OF A CATALYST FOR HIGHLY CONCENTRATED HYDROGEN PEROXIDE

J-Y. Lestrade<sup>(1)</sup>, P. Prévot<sup>(2)</sup>, J. Messineo<sup>(3)</sup>, J. Anthoine<sup>(4)</sup>, S. Casu<sup>(5)</sup> and B. Geiger<sup>(6)</sup>

<sup>(1)</sup> ONERA - The French Aerospace Lab, 31410 Mazzac, France, [jean-yves.lestrade@onera.fr](mailto:jean-yves.lestrade@onera.fr)

<sup>(2)</sup> ONERA - The French Aerospace Lab, 31410 Mazzac, France, [pierre.prevot@onera.fr](mailto:pierre.prevot@onera.fr)

<sup>(3)</sup> ONERA - The French Aerospace Lab, 31410 Mazzac, France, [jerome.messineo@onera.fr](mailto:jerome.messineo@onera.fr)

<sup>(4)</sup> ONERA - The French Aerospace Lab, 31410 Mazzac, France, [jerome.anthoine@onera.fr](mailto:jerome.anthoine@onera.fr)

<sup>(5)</sup> Heraeus Deutschland GmbH & CO KG., 63450 Hanau, Germany, [santiago.casu@heraeus.com](mailto:santiago.casu@heraeus.com)

<sup>(6)</sup> Heraeus Deutschland GmbH & CO KG., 63450 Hanau, Germany, [bastian.geiger@heraeus.com](mailto:bastian.geiger@heraeus.com)

**KEYWORDS:** hybrid rocket engine, spatial grade hydrogen peroxide, catalytic decomposition, swirl injection, high combustion efficiency

## ABSTRACT

Hybrid propulsion technology suffers from low propulsive performances generally due to low combustion efficiency in regards to the other chemical propulsion systems. When hydrogen peroxide is used as oxidizer, one of the most promising ways to increase this efficiency combines a catalyst and a swirl injector in order to have an oxidizing gaseous stream and an improved mixing between the two propellants. A complementary solution to directly increase the propulsive performance consists of using hydrogen peroxide at higher concentration than the spatial grade (87.5%) which improves the theoretical specific impulse up to 12s for 98% H<sub>2</sub>O<sub>2</sub>.

This paper presents the development of a catalyst compatible with very high concentrated hydrogen peroxide (98%) and the firing tests performed with this catalyst coupled to a hybrid engine in order to highlight the increase in combustion efficiency.

## 1. INTRODUCTION

Hybrid rocket could be considered half-way from solid and liquid technologies since this chemical propulsion system stores the oxidizer and the fuel in two distinguished states. The most often employed configuration considers a liquid or a gaseous oxidizer which flows through a solid fuel channel and burns with the pyrolysis gases coming from the solid fuel regression. In this case, the fuel grain acts as a combustion chamber referring to solid propulsion whereas the oxidizer stored in a separated tank, and the injection system refer to liquid technology. This technology is associated to simplified, low cost, faster and thrust modulated

operations with a high level of performance, reliability and availability. However, one of the factors limiting the development of this technology is the low propulsive performances resulting from low combustion efficiency in regards to the other chemical propulsion systems.

Several studies were conducted in order to increase the low combustion efficiency: addition of obstacles inside the combustion chamber [1,2,3,4], the use of swirl injectors [5,6,7,8,9], etc. These solutions are based on the enhancement of the gaseous flow mixing improving the combustion quality inside hybrid rocket combustion chamber which is generally incomplete. However, these solutions don't provide combustion efficiencies as higher than solid and liquid engines and may cause issues such as combustion instabilities, unburn fuel at the end of the firing, etc.

When hydrogen peroxide (H<sub>2</sub>O<sub>2</sub>) is used as oxidizer, one of the most promising ways to improve this efficiency combines a catalyst bed and a swirl injector. This combination enables to directly inject a gaseous oxidizer stream under high temperature which improves the mixing between the two propellants as the residence time and turbulence level within the flow field are increased. Experimental firing tests were performed with this solution and showed combustion efficiencies between 95% and 98% [10,11,12] compared of literature values ranging from 80% to 90% for comparable hybrid rocket engines without catalytic decomposition that directly leads to higher propulsive performances.

A complementary solution to improve these performances consists of using more energetic propellants. Regarding the fuel, several studies were conducted to evaluate the benefit of adding metallic particles in the grain [13,14,15,16]. However, since the raw materials of such fuel grains remain unchanged (HTPB, HDPE, etc.), the addition of metallic particles as no major impact on

the characteristic velocity and the specific impulse. Regarding the oxidizer, when firing tests are performed with hydrogen peroxide, the concentration is generally 87.5% which is the current spatial grade. Nevertheless, according to theoretical computation performed with thermochemical equilibrium code such as RPA (Rocket Propulsion Analysis) or CEA (Chemical Equilibrium with Applications), specific impulse is improved up to 12s when hydrogen peroxide at higher concentration than spatial grade (98%) reacts with the fuel grain. However, the decomposition temperature of  $H_2O_2$  at concentration up to 98% is not compatible with the catalyst material.

In order to combine very high concentrated hydrogen peroxide with a catalytic bed, a catalyst which withstands the decomposition temperature of 98%  $H_2O_2$  has to be developed. This article presents the first steps of this process which consists of characterising the catalytic bed for spatial grade hydrogen peroxide for monopropellant tests. Several hybrid firing tests have been performed with this catalyst and will be described in the second part of this paper.

## 2. MONOPROPELLANT TEST CAMPAIGN

When a catalytic bed is coupled to a hybrid engine, the ignition of this engine doesn't require pyrotechnic device any more. The ignition is achieved thanks to the energy supply coming from the hot oxidizer stream. Consequently, the catalytic bed has to have a very good efficiency associated to a short transient duration. The objective of the monopropellant test campaign was to select among different catalysts, the one which fills the most these requirements.

### 2.1. Catalyst preparation

The catalysts were developed and produced by ONERA's Partner Heraeus, a technology group headquartered in Hanau and focused on themes such as environment, energy, health, mobility and industrial applications. Heraeus Deutschland GmbH & Co. KG is part of the leading international family-owned company with more than 30 years expertise in catalysts development for space applications.

The four catalysts presented in this paper have been selected after a preliminary screening of their catalytic activity with low concentration hydrogen peroxide. Catalysts A, B and C are Pt based catalysts supported on the flight proven  $Al_2O_3$

granules used for the Heraeus hydrazine decomposition catalysts H-KC12GA. They were prepared with different alumina particle sizes, A being supported on the largest one (14-10 mesh) and C on the smallest one (30-25 mesh). Catalyst D is also a Pt based catalyst but supported on an alternative  $Al_2O_3$  material having the same particle size as the one used for catalyst A.

### 2.2. Description of the monopropellant test facility

The monopropellant test facility, designed to be compatible with the hybrid engine used for the second part of these tests, consists of three main components: the inlet manifold connected to the  $H_2O_2$  feed line, an injector plate and the decomposition chamber containing the catalyst particles (Fig. 1). The injector plate was designed in order to spread the liquid hydrogen all over the cross section of the decomposition chamber. This chamber consists of an Inconel cylinder closed by refractory steel meshed in order to maintain the catalyst particle inside the decomposition chamber.



Figure 1. Monopropellant test facility

This chamber is connected to a measurement module measuring the decomposition temperature at the outlet of the catalytic bed thanks to three thermocouples and the decomposition chamber pressure. This last measurement enables to obtain the characteristic curve (oxidizer mass flow rate as a function of the pressure differential) of this decomposition chamber in order to precisely control the operating conditions of the monopropellant tests and of the hybrid firing tests. However, to determine this curve, tests under pressure are needed which require the use of a nozzle at the outlet of the decomposition chamber.

The instrumentation of this facility also includes a Coriolis oxidizer mass flow measurement and temperature and pressure measurements of the liquid oxidizer upstream the manifold.

### 2.3. Test results

For this test campaign, each test lasted 10 s under the same oxidizer mass flow rate (90 g/s). Indeed, it was important to keep this parameter constant in order to ease the comparison between the four particle samples since the transient phase duration depends on the oxidizer mass flow rate. A lower oxidizer mass flow rate leads to a higher transient phase duration and vice-versa.

Thanks to a constant tank pressure during the monopropellant test, the oxidizer mass flow rate is stable during the second part of the test due to steady temperature at the outside of the decomposition chamber (Fig. 2). During the first part of this test (up to 5 s), the decomposition temperature increases continuously which conducts to a slight decreases of the oxidizer mass flow rate. Before going up to about 910 K, the decomposition temperature evolutions present a short step around 360 K which corresponds to the water decomposition temperature.

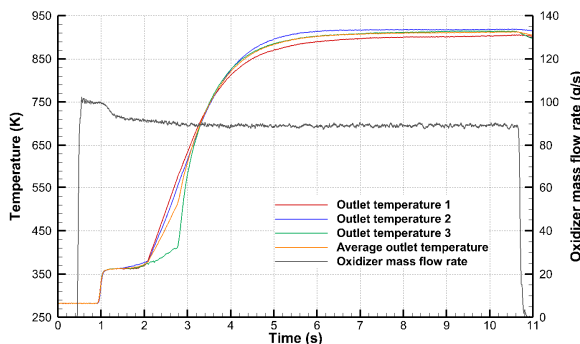

Figure 2. Results of a test performed with the catalyst sample A

The transient phase of the decomposition temperature evolution seems quite long for the test presented on Figure 2 since this catalyst sample reaches 95% of its maximum decomposition temperature value in 3.6 s. However, the catalyst samples were not warm up before the tests performed during the monopropellant test campaign. To have a look on the impact of catalyst sample heating, some tests of this campaign came one after another with a delay of 3 minutes and showed the more the catalyst sample is heated, the lower is the transient phase duration (Fig. 3).

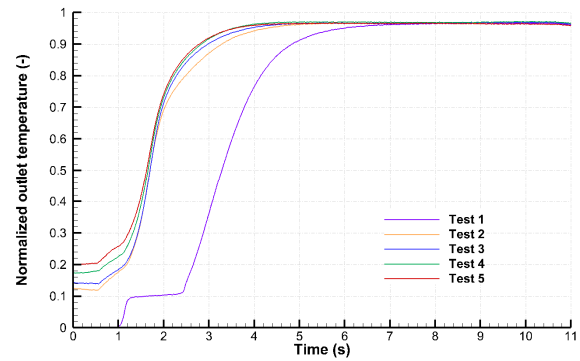

Figure 3. Test performed one after another on catalyst sample A

As presented on Figure 3, the decomposition temperature evolutions of were normalized according to Eq. 1.

$$T_{norm} = \frac{T_{dec} - T_{inj}}{T_{ad} - T_{inj}} \quad (1)$$

with  $T_{norm}$  the normalized temperature,  $T_{dec}$  the measured decomposition temperature,  $T_{inj}$  the injection temperature of the liquid oxidizer and  $T_{ad}$  the adiabatic decomposition temperature. The last temperature, which is equal to 968 K for 87.5%  $H_2O_2$ , was obtained thanks to a thermochemical equilibrium code.

This normalization enables to overcome the liquid injection temperature difference and to compensate the adiabatic decomposition temperature due to slight difference in the hydrogen peroxide concentration between each test.

Before comparing the four particle samples, four tests were performed with each sample to oxidize the catalyst sample in order to have a good reproducibility in the results (Fig. 4). As presented on this figure, the temperature evolutions match very well for the three last monopropellant tests and reached an efficiency based on the normalized temperature of 97.4%.

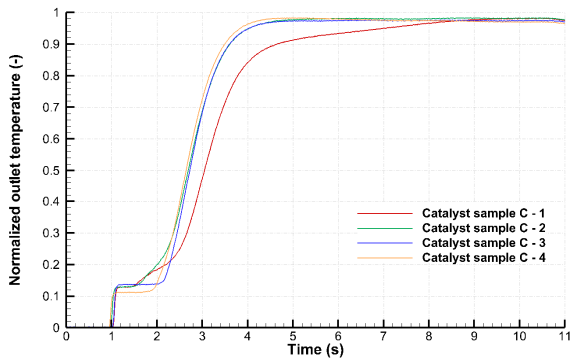

Figure 4. Decomposition temperature evolution of catalyst sample C for the four tests

Finally, Figure 5 provides the comparison between the decomposition temperatures of the four catalyst samples. It can be noticed that the lower the catalyst particles are, the lower is the transient phase duration and the higher is the efficiency based on the normalized temperature. Then the catalyst sample D provides better results than the catalyst sample A for both the transient phase duration and the efficiency. The support of particles D is consequently better regarding these two parameters than the particles A one.

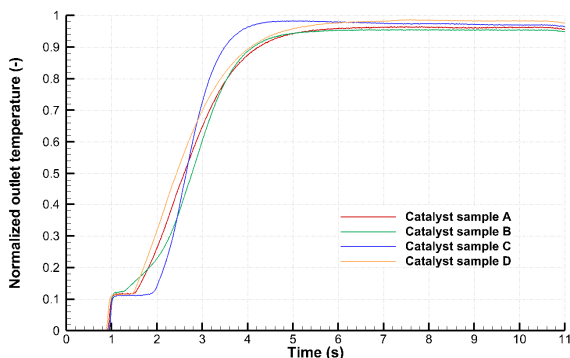

Figure 5. Comparison between the decomposition temperatures of the four catalyst samples

The selection of the best particle samples was consequently performed between samples C and D. Sample C has a better response time than sample D (2.5 s against 3.2 s) but has a lower efficiency based on the decomposition temperature (respectively 97.4% and 98.5%). However, sample C showed formation of bigger particles after the tests performed due to the very small size of the virgin material. So longer cumulative test durations could lead to big particle formation which could decrease the performances of the catalyst. Consequently, catalyst sample D was selected for the hybrid firing tests.

### 3. HYBRID TEST CAMPAIGN

#### 3.1. Description of the test facility

The hybrid test campaign was performed on the HYCOM facility [17] (Fig. 6). Like most hybrid engine, the HYCOM engine is composed of five parts: a forward end plate including the injector, a pre-chamber including the igniter, a combustion chamber, a post-chamber and a nozzle. The modular design of this facility enables to easily modify and adapt this engine and consequently, in order to plug the catalyst bed on the combustion chamber, the forward end plate and the pre-chamber were replaced by an intermediate flange which is also the seat of a gaseous injector.

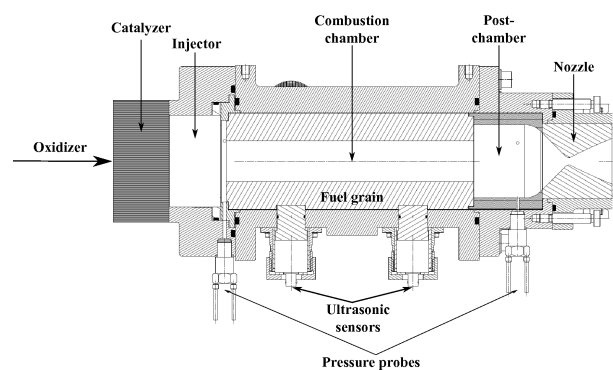

Figure 6. Drawing of the HYCOM hybrid engine

In addition to the instrumentation located upstream the decomposition chamber and previously described, the HYCOM facility is instrumented with four unsteady pressure probes, two located in the intermediate flange and two in the post-chamber, and with three ultrasonic sensors, one placed at the head-end of the fuel grain and two at the rear-end. The ultrasonic sensors coupled to a dedicated electronic system enables to track the instantaneous travel time of ultrasonic waves within the fuel grain and to deduce its instantaneous regression rate. The HYCOM engine was also placed on a thrust bench to measure the propulsive performances (Fig. 7). Finally, three thermocouples were also placed in the intermediate flange in order to measure the temperature of the oxidizer stream at the outlet of the decomposition chamber.

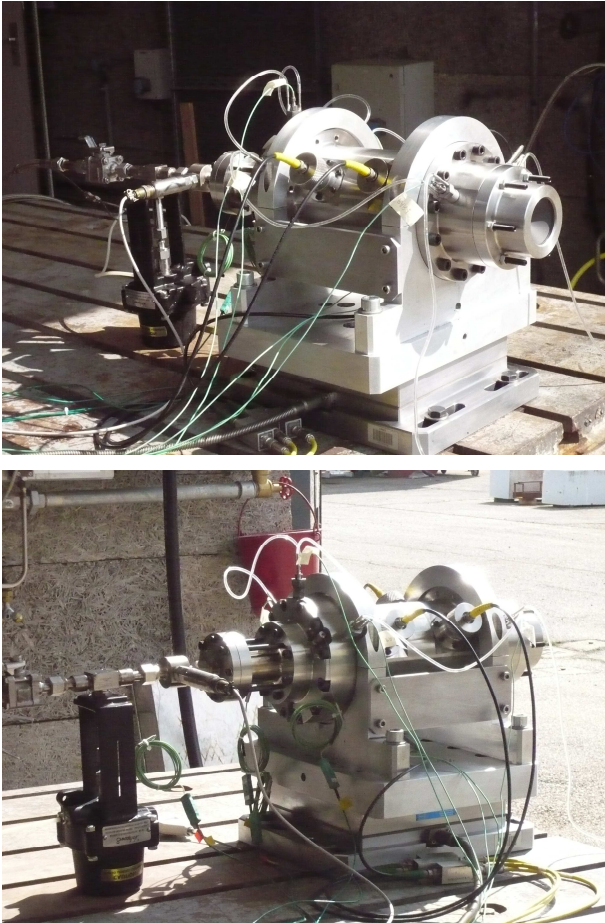

Figure 7. Photographs of the HYCOM lab-scale hybrid engine before the firing test

The hybrid firing tests were performed with spatial grade hydrogen peroxide combined with a high density polyethylene (HDPE) fuel grain. The fuel grain had a 25 mm diameter single-circular port and a 240 mm length and a conical nozzle with a 7 mm throat diameter and a 6.3 expansion ratio was used in order to pressurize the engine. A summary of the geometrical parameters is provided in Table 1.

Table 1. Geometrical parameters of the hybrid firing tests

Initial fuel port diameter	25.0	[mm]
Fuel grain length	240	[mm]
Nozzle throat diameter	7.0	[mm]
Nozzle expansion ratio	6.3	[-]

### 3.2. Test results

The first test on the HYCOM facility was performed with an axial gaseous injector. Under

the operating conditions previously described, the firing test provided a mono-propellant phase of 1.3 s which preceded a hybrid mode of more than 5.5 s (Fig. 5). Thanks to a pressurization system, the tank pressure (not illustrated) was constant during the firing test. Therefore, the oxidizer mass flow rate was quite constant and very close to 115 g/s during the hybrid mode which provided a chamber pressure of 4.0 MPa and a thrust of about 228 N.

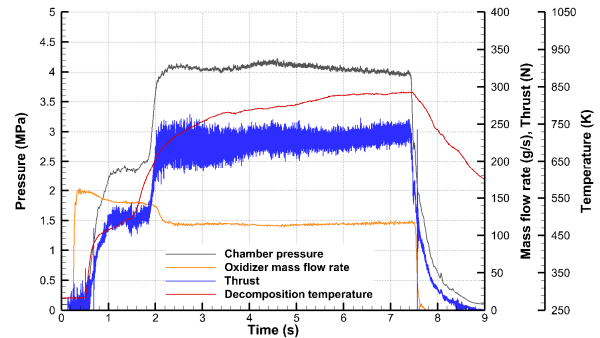

Figure 8. Results of the test performed with the axial gaseous injector on the HYCOM facility

These results were then averaged over the hybrid mode duration in order to deduce the oxidizer to fuel ratio, the propulsive performances and the efficiencies. As presented in Table 2, the averaged experimental oxidizer to fuel ratio was 12.4, value away from the optimal one (7.3) for which the specific impulse is maximal. For such mixing ratio, it is easier to have good combustion efficiencies since there is not enough fuel to complete the combustion process. However, the combustion efficiency, ratio between experimental and theoretical characteristic velocities, reached only 89.1% while the engine efficiency, ratio between experimental and theoretical specific impulses, reached 82.7%.

Although the low engine efficiency can be explained by the use of a non-optimized nozzle which supplied a low efficiency (92.8%), the combustion efficiency was also very low. The use of a catalytic bed to directly inject a hot gaseous oxidizer stream in the combustion chamber is consequently not enough to increase the propulsive performances of hybrid engines.

*Table 2. Averaged results of the hybrid test performed with the axial gaseous injector*

Monopropellant phase duration (s)	1.3
Hybrid mode duration (s)	5.5
Oxidizer mass flow rate (g/s)	115.0
Fuel mass flow rate (g/s)*	9.3
Chamber pressure (MPa)	3.97
Thrust (N)	228.1
Oxidizer to fuel ratio (-)	12.4
Characteristic velocity (m/s)	1301
Specific impulse (s)	187
Combustion efficiency (%)	89.1
Nozzle efficiency (%)	92.8
Engine efficiency (%)	82.7

\*The averaged mass fuel rate was calculated based on the mass measurements before and after the firing test.

The axial injector was replaced by a swirl gaseous injector for the second firing test on the HYCOM facility. As presented on Figure 9, the monopropellant phase duration lasted 1.6 s and was followed by a 5.1 s duration hybrid mode. The measurements recorded during this firing test provided an oxidizer mass flow rate of 102 g/s, a chamber pressure of 4.7 MPa and a thrust of 261 N.

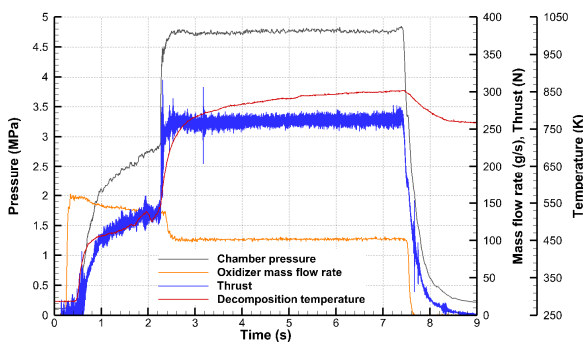

*Figure 9. Results of the test performed with the swirl gaseous injector on the HYCOM facility*

The averaged combustion efficiency reached 97.7% averaged during the hybrid mode (Tab. 3) while it was only 89.1% in the previous firing test. The engine efficiency (90.7%) was consequently improved from the axial injector test but was still quite low because of the use of the same non optimized nozzle providing an efficiency of only 92.8%. Moreover, it has to be noted that the

oxidizer to fuel ratio (6.3) is closer to the optimal value for this firing test.

*Table 3. Averaged results of the hybrid test performed with the swirl gaseous injector*

Monopropellant phase duration (s)	1.6
Hybrid mode duration (s)	5.1
Oxidizer mass flow rate (g/s)	101.7
Fuel mass flow rate (g/s)*	16.1
Chamber pressure (MPa)	4.72
Thrust (N)	260.8
Oxidizer to fuel ratio (-)	6.3
Characteristic velocity (m/s)	1542
Specific impulse (s)	226
Combustion efficiency (%)	97.7
Nozzle efficiency (%)	92.8
Engine efficiency (%)	90.7

The use of swirl injection also enabled to reduce hydrodynamic instabilities in the combustion chamber (Fig. 10). An axial injection provokes the formation of large scale vortices at the end of the fuel grain due to a strong shear stress. However, a swirl injection for which the nature of the flow and the turbulence level are different, limits the formation of such vortices [18].

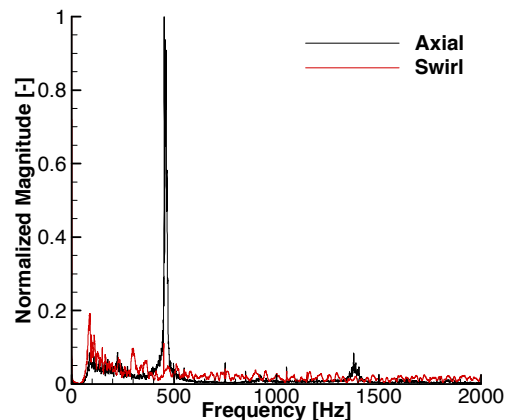

*Figure 10. FFT of the two experimental pressure signals*

#### 4. CONCLUSION

This paper presented the first step of the development of a catalyst for very high concentrated hydrogen peroxide for hybrid engine applications. The first phase of this development



consisted on the selection of the best catalyst particles among four, based on transient phase duration and on the decomposition temperature efficiency. Two firing tests on the HYCOM facility, a lab-scale hybrid engine, were performed with spatial grade hydrogen peroxide and with two gaseous injectors.

These firing tests enabled to highlight that the use of a decomposition chamber with an axial injector is not enough to increase hybrid engine efficiencies since the test performed under these operating conditions only reached a 89.1% efficiency. However, when a decomposition chamber associated to a gaseous swirl injector is combined with a hybrid engine, the combustion efficiency jumps up to 97.7%. This value is closer to the one obtained for solid and liquid rocket engine.

The next step of the development consequently consists in the testing of the selected catalyst particles with very high concentrated hydrogen peroxide (98%). The use of this oxidizer will enable to improve the theoretical propulsive performances of hybrid rocket engines, and consequently, the experimental one. The expected benefit corresponds to an increase for the specific impulse of 12 s.

## 5. REFERENCES

1. Kim, H., Kim, S., Woo, K., Lee, J., Moon, H., Sung, H. & Kim, J. (2011). Investigation on the Effect of Liquefying Diaphragm in Hybrid Rocket Motors using Paraffin-Based Fuel. 47th AIAA/ASME/SAE/ASEE Joint Propulsion Conference & Exhibit, Joint Propulsion Conferences. San Diego, California. AIAA Paper 2011-5824.
2. Grosse, M. (2009). Effect of a Diaphragm on Performance and Regression of a Laboratory Scale Hybrid rocket Motor Using Nitrous Oxide and Paraffin. 45th AIAA/ASME/SAE/ASEE Joint Propulsion Conference & Exhibit, Joint Propulsion Conferences. Denver, Colorado. AIAA Paper 209-5113.
3. Lazzarin, M., Bellomo, N. Faenza, M., Barato, F., Bettella, A. & Pavarin, D. (2013). Analysis of fluid-dynamic system to increase combustion efficiency in hybrid rockets. 5th European Conference for AeroSpace Sciences (EUCASS). Munich, Germany.
4. Bellome, N., Lazzarin, M., Barato, F., Bettella, A., Pavarin, D. & Grosse, M. (2014). Investigation of Effect of diaphragms on the Efficiency of Hybrid Rockets. *Journal of Propulsion and Power* **30**(1), 175-185.
5. Knuth, W.H., Chiaverini, M.J., Sauer, J.A. & Gramer, D.J. (2002). Solid-Fuel Regression Rate Behavior of Vortex Hybrid Rocket Engines. *Journal of Propulsion and Power* **18**(3), 600-609.
6. Yuasa, S., Yamamoto, K., Hachiya, H., Kitagawa, K. & Oowada, Y. (2001). Development of Small Sounding Hybrid Rocket with a Swirling-Oxidizer-Type Engine. 37th Joint Propulsion Conference and Exhibit, Joint Propulsion Conferences. Salt Lake City, Utah. AIAA Paper 2001-3537.
7. Masugi, M., Ide, T., Yuasa, S., Sakurai, T., Shiraishi, N & Shimada, T. (2010). Visualization of Flames in Combustion Chamber of Swirling-Oxidizer-Flow-Type Hybrid Rocket Engines. 46th AIAA/ASME/SAE/ASEE Joint Propulsion Conference & Exhibit, Joint Propulsion Conferences. Nashville, Tennessee. AIAA Paper 2010-6546.
8. Myre, D., Canton, P., Cowart, J.S. & Jones, C.C. (2010). Exhaust Gas Analysis of a Vortex Oxidizer Injection Hybrid Rocket Motor. 46th AIAA/ASME/SAE/ASEE Joint Propulsion Conference & Exhibit, Joint Propulsion Conferences. Nashville, Tennessee. AIAA Paper 2010-6548.
9. Gomes, S.R., Rocco, L.J., Rocco, J.A.F.F. & Iha, K. (2010). Gaseous Oxygen Injection Effects in Hybrid Labscale Rocket Motor Operations. 46th AIAA/ASME/SAE/ASEE Joint Propulsion Conference & Exhibit, Joint Propulsion Conferences. Nashville, Tennessee. AIAA Paper 2010-6545.
10. Ronningen, J-E., & Husdal, J. (2012). Test results from small-scale hybrid rocket testing. 4th International Symposium on Propulsion for Space Transportation, Space Propulsion. Bordeaux, France.
11. Ronningen, J-E., & Husdal, J. (2012). Nammo hybrid rocket propulsion TRL improvement program. 48th AIAA/ASME/SAE/ASEE Joint Propulsion Conference & Exhibit, Joint Propulsion Conferences. Atlanta, Georgia. AIAA Paper 2012-4311.

12. Anthoine, J., Lestrade, J-Y., Verberne, C.J., Boiron, A.J., Figus, C. & Khimeche, G. (2014). Experimental Demonstration of the Vacuum Specific Impulse of a Hybrid Rocket Engine. 50th AIAA/ASME/SAE/ASEE Joint Propulsion Conference, Propulsion and Energy Forum. Cleveland, Ohio. AIAA Paper 2014-3951.
13. Calabro, M., De Luca, L.T., Galfetti, L., Raina, H. & Perut, C. (2007). Advanced hybrid solid fuels. 58th International Astronautical Congress. Hyderabad, India. IAC-07-C4.2.09.
14. Evans, B., Favorito, N., Risha, G., Boyer, E., Wehrman, R. & Kuo, K.K. (2004). Characterization of Nano-Sized Energetic Particle Enhancement of Solid-Fuel Burning Rates in an X-Ray Transparent Hybrid Rocket Engine, 40th AIAA/ASME/SAE/ASEE Joint Propulsion Conference and Exhibit, Joint Propulsion Conferences. Fort Lauderdale, Florida. AIAA Paper 2004-3821.
15. Maggi, F., Gariani, G., Galfetti L. & DeLuca, L.T. (2012). Theoretical analysis of hydrides in solid and hybrid rocket propulsion. *International Journal of Hydrogen Energy* **37**(2). 1760-1769.
16. Risha, G., Ulas, A., Boyer, E., Kumar, S. & Kuo, K.K. (2001). Combustion of HTPB-based solid fuels containing nano-sized energetic powder in a hybrid rocket motor. 37th Joint Propulsion Conference and Exhibit, Joint Propulsion Conferences. Salt Lake City, Utah. AIAA Paper 2001-3535.
17. Lestrade, J-Y., Anthoine, A. & Lavergne, G. (2015). Liquefying fuel regression rate modeling in hybrid propulsion. *Aerospace Science and Technology* **42**. 80-87.
18. Messineo, J., Lestrade, J-Y., Hijlkema, J. & Anthoine, J. (2016). 3D Miles simulation of a hybrid rockets with swirl injection. 6th International Symposium on Propulsion for Space Transportation, Space Propulsion. Roma, Italy.



# Development of a Catalyst for Highly Concentrated Hydrogen Peroxide

*5<sup>th</sup> Space Propulsion Conference  
02-06 May 2016, Roma, Italy*

J-Y. Lestrade<sup>1</sup>, P. Prevot<sup>1</sup>, J. Messineo<sup>1</sup>, J. Anthoine<sup>1</sup>, S. Casu<sup>2</sup> and B. Geiger<sup>2</sup>

<sup>1</sup> ONERA – The French Aerospace Lab

<sup>2</sup> Heraeus Deutschland GmbH & CO KG.



return on innovation

**Heraeus**

# Contents

- **Context of the study**
  - Presentation of hybrid propulsion
  - How to increase the propulsive performances?
  - Objective and methodology
- **Catalyst preparation**
- **Monopropellant test campaign**
  - Description of the test facility
  - Test results
- **Hybrid test campaign**
  - Description of the test facility
  - Test results
- **Conclusion & perspective**

# Context of the study – Presentation of hybrid propulsion

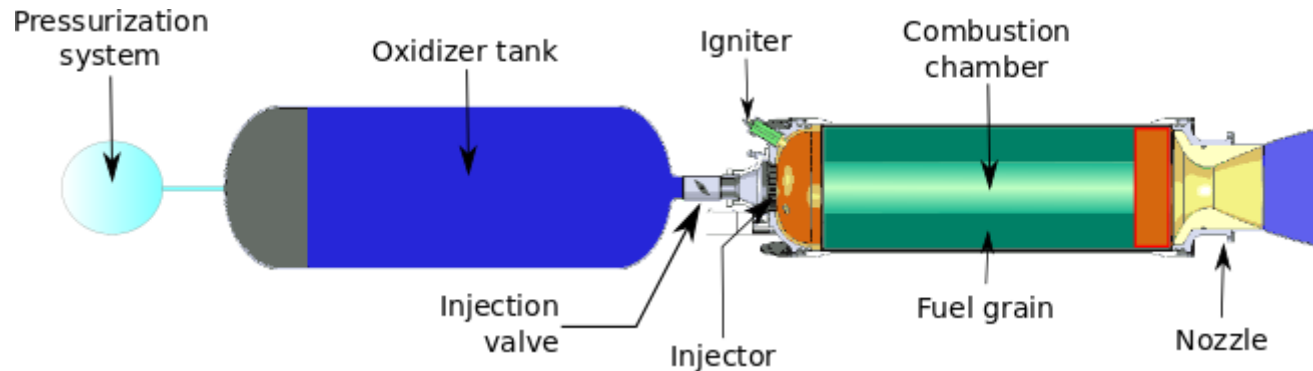

- ✓ Good theoretical propulsive performances
- ✓ Throttle, stop and restart capabilities
- ✓ Safety thanks to separated propellants and inert fuel grain
  
- ✗ Oxidizer to fuel ratio shift for long-time operating engines
  - ⇒ Propulsive performances variation
- ✗ Low combustion efficiency
  - ⇒ Low experimental propulsive performances

# Context of the study – How to increase the propulsive performances?

## ■ Increase the combustion efficiency

⇒ Improve the mixing between the propellants

■ Use of obstacles in the combustion chamber

⇒ Combustion efficiency still low compared to other chemical propulsion systems

⇒ Combustion instabilities

⇒ Unburnt fuel

■ Use of swirl injector

⇒ Liquid oxidizer: combustion efficiency still low compared to other chemical propulsion systems

⇒ Gaseous oxidizer (use of a catalyser): experimental combustion efficiency between 95 and 98%

# Context of the study – How to increase the propulsive performances?

## ■ Use of more energetic propellants

### ■ Solid fuel

- Addition of metallic particles inside the fuel grain

⇒ Negligible impact because of the use of the same raw materials

### ■ Liquid oxidizer

- Difficulty to find very energetic oxidizer since they generally are very toxic

- Case of hydrogen peroxide

⇒ Improvement of 12s for the specific impulse with  $\text{H}_2\text{O}_2$ -wt98%

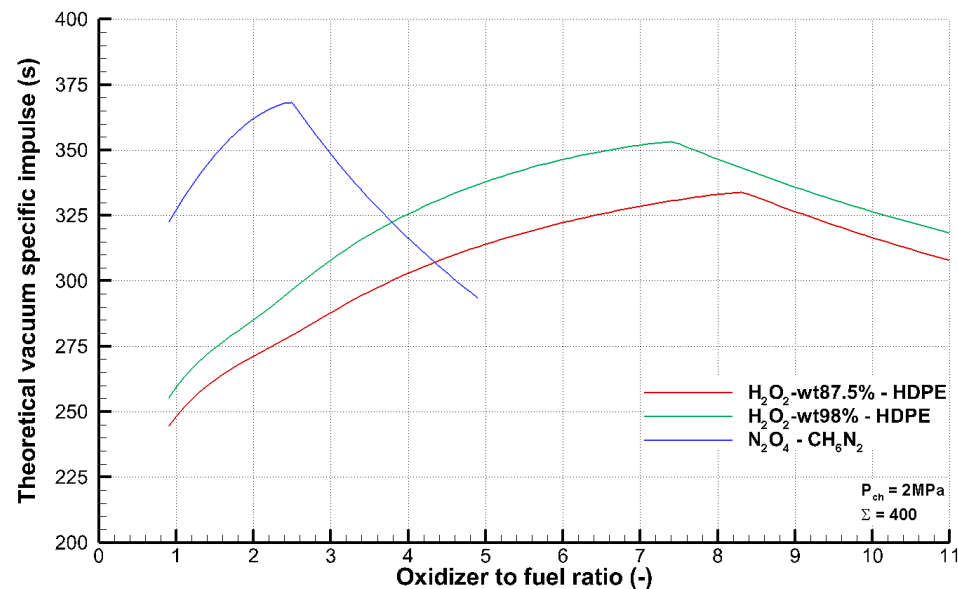

# Context of the study – Objective and methodology

- **Best solution to increase the experimental propulsive performances**

- ⇒ Inject 98%-H<sub>2</sub>O<sub>2</sub> through a catalytic bed combined to a swirl injector

- **Objective**

- ⇒ Develop a catalytic bed compatible with 98%-H<sub>2</sub>O<sub>2</sub>

- **Methodology**

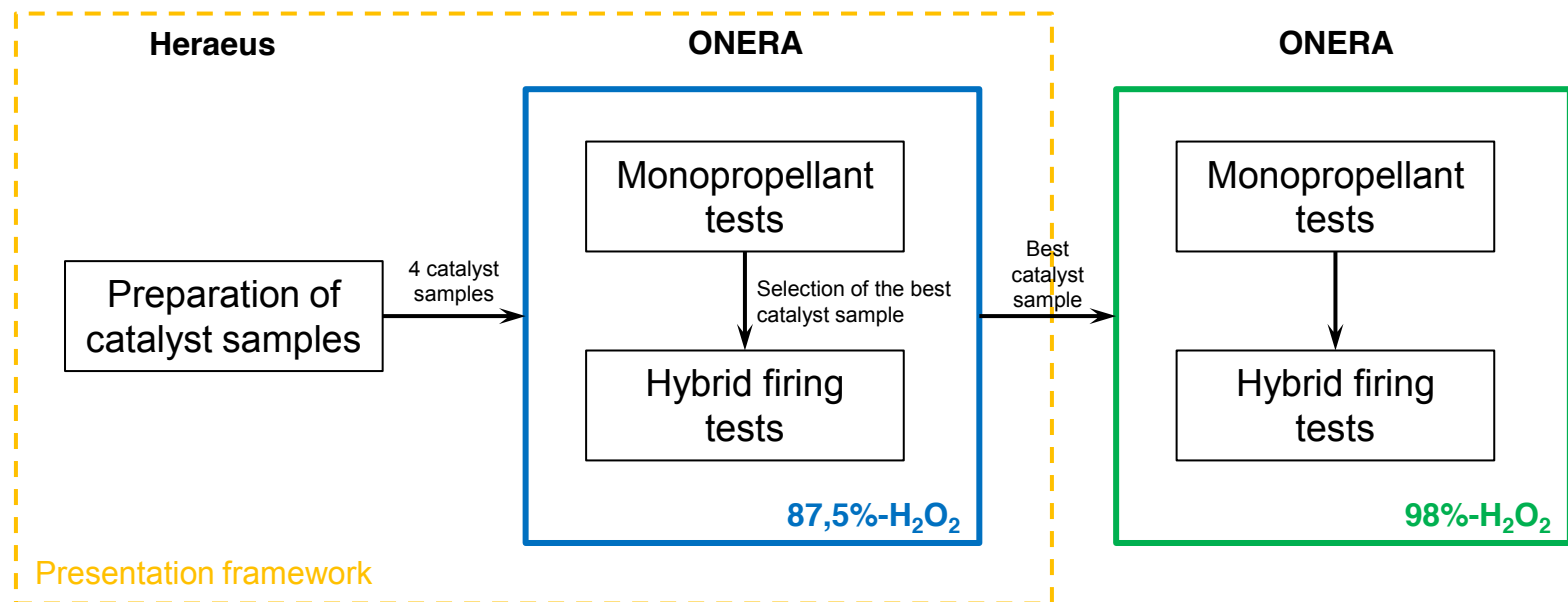



# Catalyst preparation

- Platinum based catalyst samples supported on  $\text{Al}_2\text{O}_3$  granules

Catalyst sample	$\text{Al}_2\text{O}_3$ support	Particle size
A	Hydrazine decomposition catalysts	14-10 mesh
B	Hydrazine decomposition catalysts	20-18 mesh
C	Hydrazine decomposition catalysts	30-25 mesh
D	Alternative support	14-10 mesh

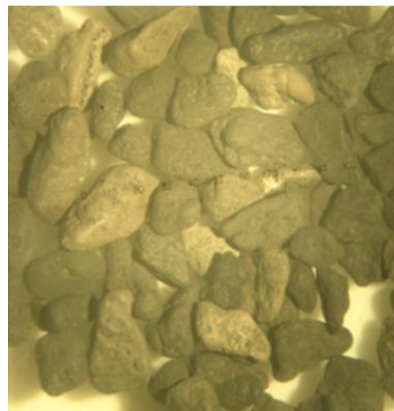

# Monopropellant test campaign – Description of the test facility

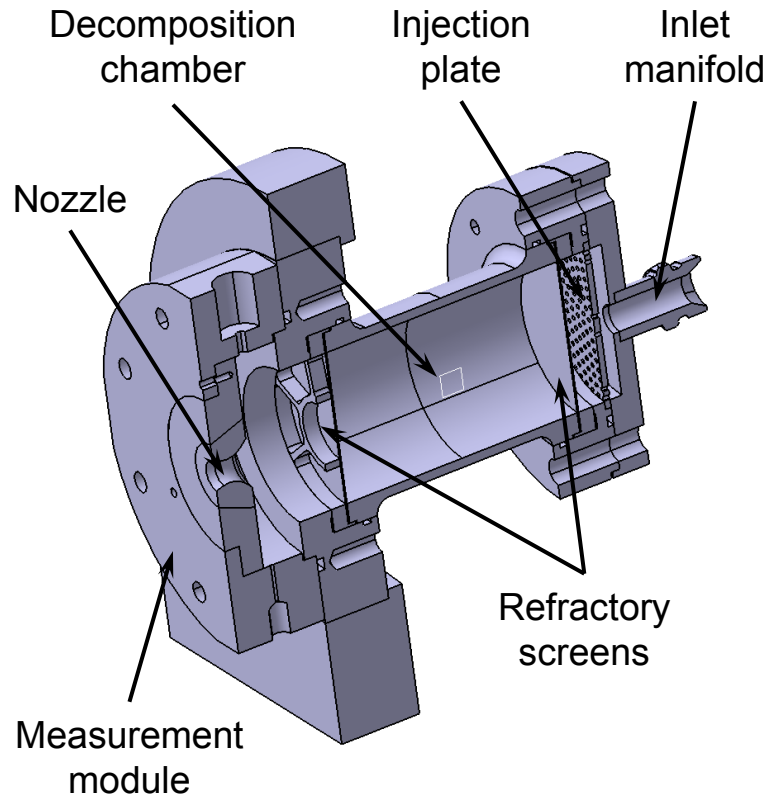

## ■ Measurement

- Oxidizer mass flow rate
- Temperature and pressure of inlet liquid  $\text{H}_2\text{O}_2$
- Outlet temperature and pressure of the decomposed gases

# Monopropellant test campaign – Test results

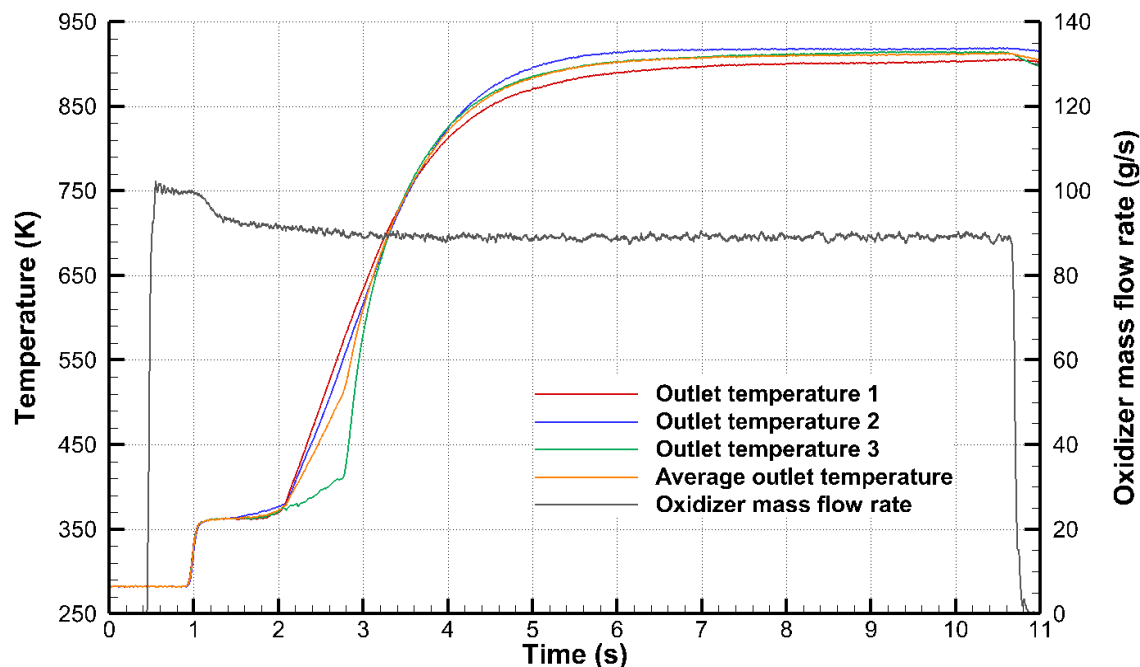
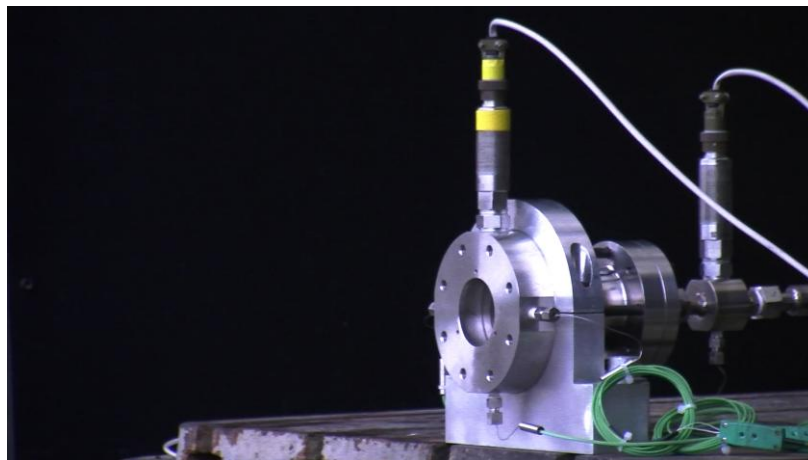

# Monopropellant test campaign – Test results

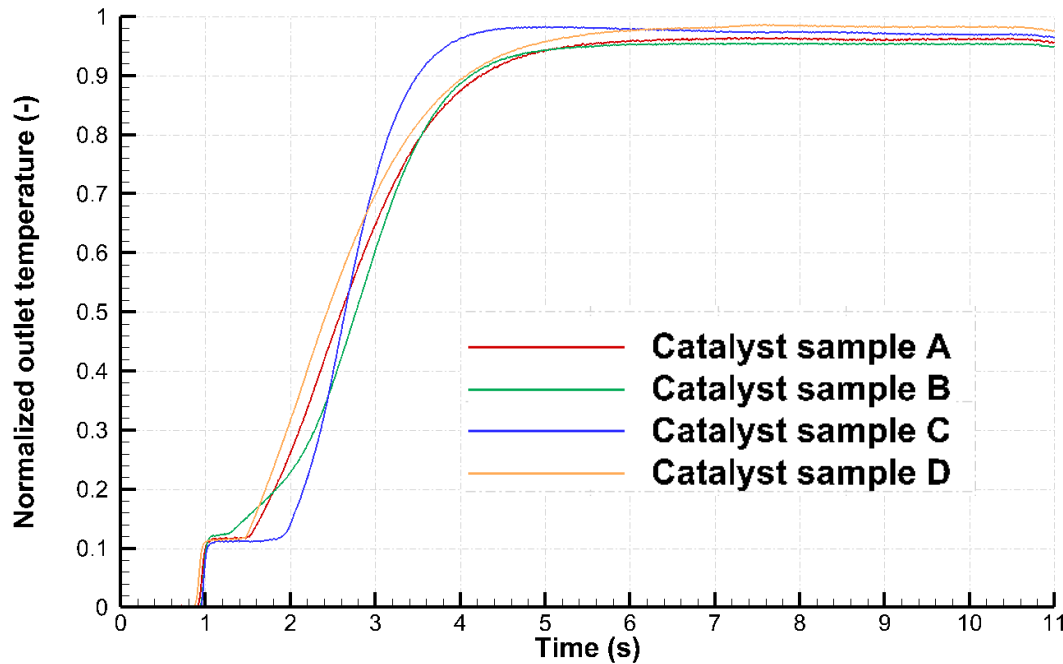

Catalyst sample	Efficiency	Transient duration*
C	97.4%	2.5s
D	98.5%	3.2s

\* To reach 95% of its maximal temperature

$$T_{norm} = \frac{T_{dec} - T_{inj}}{T_{ad} - T_{inj}}$$

- $T_{norm}$  normalized temperature
- $T_{dec}$  outlet temperature (gaseous phase)
- $T_{inj}$  injection temperature (liquid phase)
- $T_{ad}$  adiabatic decomposition temperature

# Hybrid test campaign – Description of the test facility

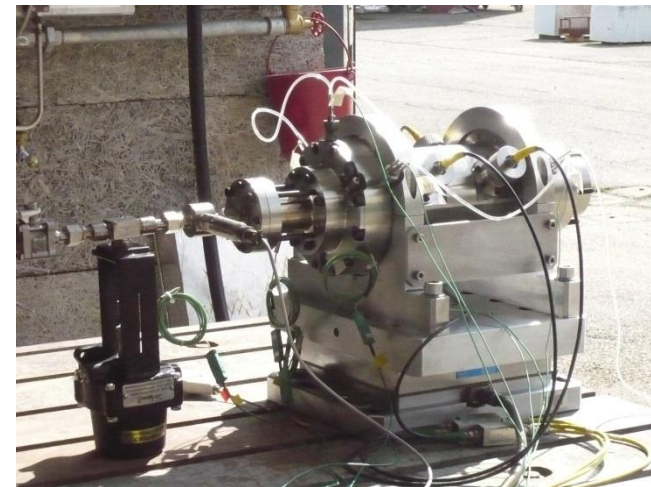
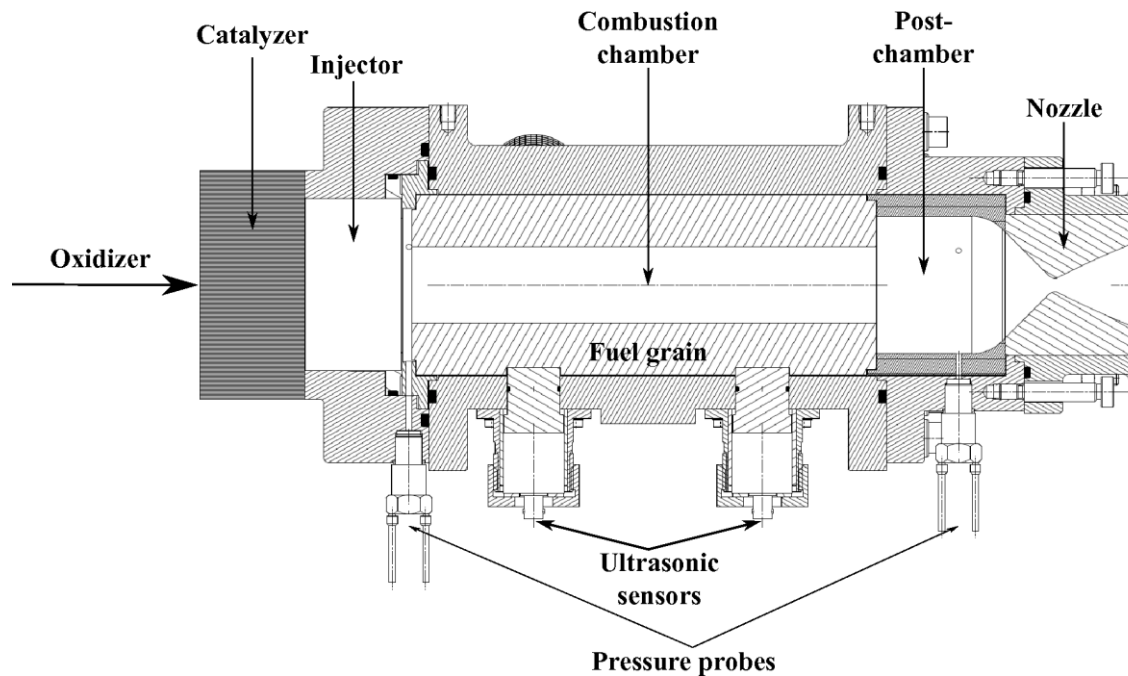

## ■ Measurement

- Oxidizer mass flow rate
- Temperature and pressure of inlet liquid  $H_2O_2$
- Outlet temperature decomposed gases
- Combustion chamber pressure
- Fuel regression rate
- Thrust

[Video](#)

# Hybrid test campaign – Test results

## ■ Axial gaseous injector

### Geometrical parameters

Initial fuel port diameter	25.0	mm
Fuel length	240.0	mm
Nozzle throat diameter	7.0	mm
Nozzle expansion ratio	6.3	-

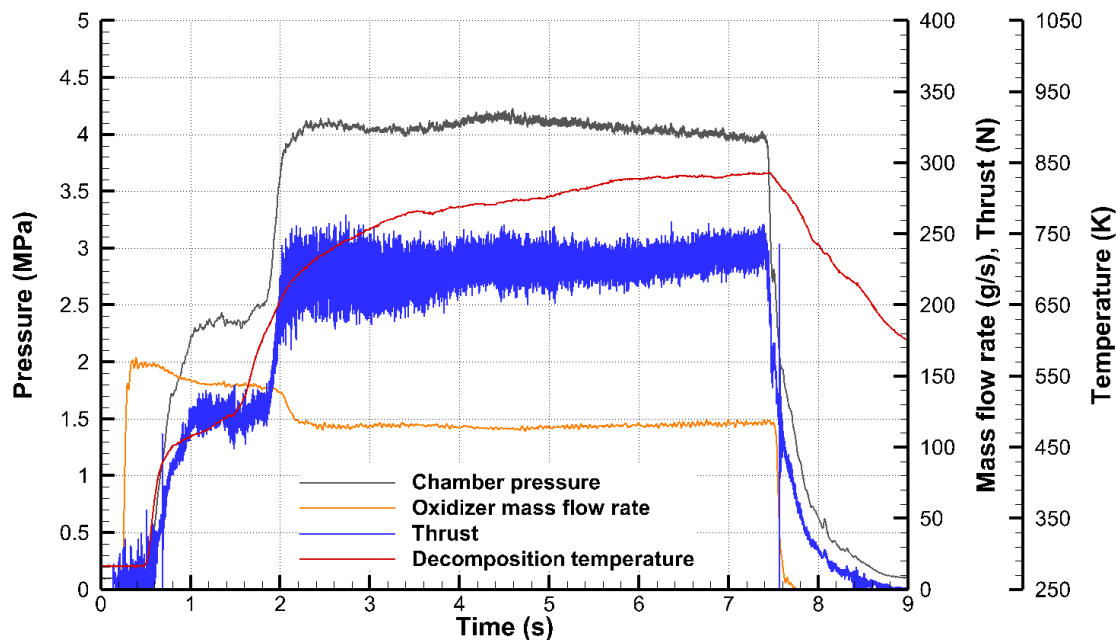

### Averaged results

Monopropellant phase duration	1.3	s
Hybrid mode duration	5.5	s
Oxidizer mass flow rate	115.0	g/s
Fuel mass flow rate	9.3	g/s
Chamber pressure	3.97	MPa
Thrust	228.1	N

### Averaged propulsive performances

Oxidizer to fuel ratio	12.4	-
Characteristic velocity	1301	m/s
Specific impulse	187	s
<b>Combustion efficiency</b>	<b>89.1</b>	<b>%</b>
Nozzle efficiency	92.8	%
Engine efficiency	82.7	%

# Hybrid test campaign – Test results

## ■ Swirl gaseous injector

### Geometrical parameters

Initial fuel port diameter	25.0	mm
Fuel length	240.0	mm
Nozzle throat diameter	7.0	mm
Nozzle expansion ratio	6.3	-

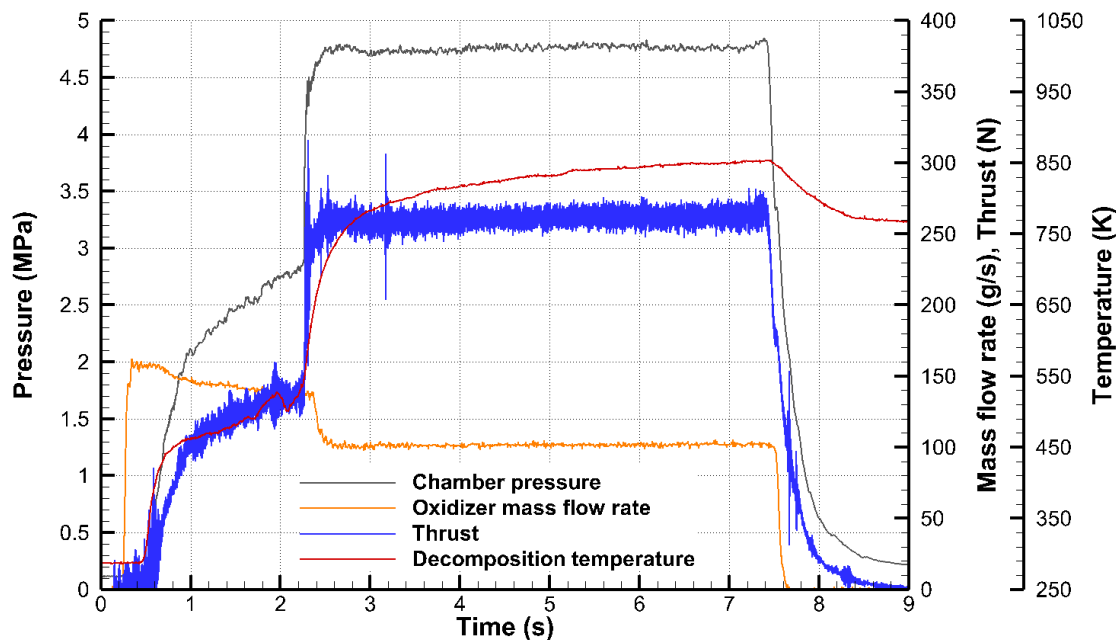

### Averaged results

Monopropellant phase duration	1.6	s
Hybrid mode duration	5.1	s
Oxidizer mass flow rate	101.7	g/s
Fuel mass flow rate	16.1	g/s
Chamber pressure	4.72	MPa
Thrust	260.8	N

### Averaged propulsive performances

Oxidizer to fuel ratio	6.3	-
Characteristic velocity	1542	m/s
Specific impulse	226	s
Combustion efficiency	97.7	%
Nozzle efficiency	92.8	%
Engine efficiency	90.7	%

# Conclusion & perspective

## ■ Conclusion

- Development of a catalyst bed compatible with 98% H<sub>2</sub>O<sub>2</sub>
- Two firing tests performed on a hybrid engine combined with a catalyst bed and axial and swirl gaseous injectors
- Improvement of the hybrid engine combustion efficiency to 98%
  - Combination of the gaseous injection thanks to the catalyst bed and the swirl injection

## ■ Perspective

- Perform monopropellant and hybrid firing tests with 98%-H<sub>2</sub>O<sub>2</sub>



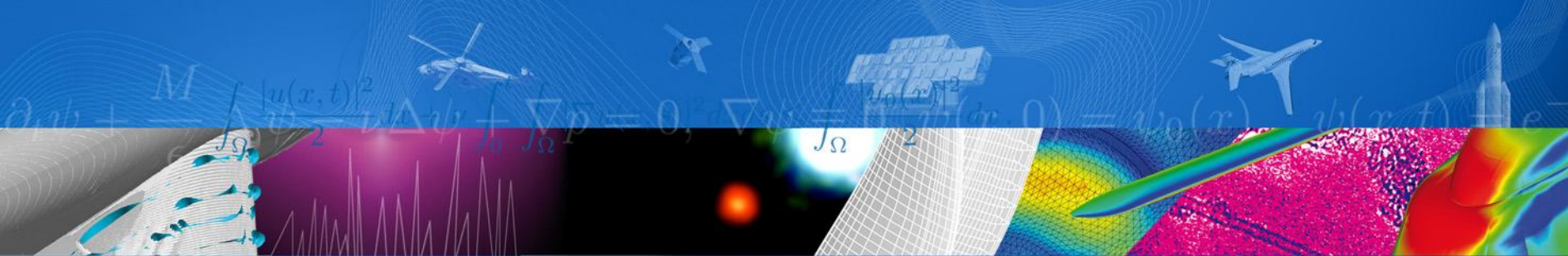

**Thank you for your attention**

Contact: [jean-yves.lestrade@onera.fr](mailto:jean-yves.lestrade@onera.fr)



return on innovation

**Heraeus**