



HAL
open science

Dynamics and bifurcations of nonsmooth systems: A survey

Oleg Makarenkov, Jeroen Lamb

► **To cite this version:**

Oleg Makarenkov, Jeroen Lamb. Dynamics and bifurcations of nonsmooth systems: A survey. *Physica D: Nonlinear Phenomena*, 2012, 241 (22), pp.1826-1844. 10.1016/j.physd.2012.08.002 . hal-01350541

HAL Id: hal-01350541

<https://hal.science/hal-01350541v1>

Submitted on 4 Aug 2016

HAL is a multi-disciplinary open access archive for the deposit and dissemination of scientific research documents, whether they are published or not. The documents may come from teaching and research institutions in France or abroad, or from public or private research centers.

L'archive ouverte pluridisciplinaire **HAL**, est destinée au dépôt et à la diffusion de documents scientifiques de niveau recherche, publiés ou non, émanant des établissements d'enseignement et de recherche français ou étrangers, des laboratoires publics ou privés.



Distributed under a Creative Commons Attribution 4.0 International License

Dynamics and bifurcations of nonsmooth systems: a survey

Oleg Makarenkov, Jeroen S.W. Lamb

Department of Mathematics, Imperial College London, 180 Queen's Gate, London SW7 2AZ, UK.

Abstract

In this survey we discuss current directions of research in the dynamics of nonsmooth systems, with emphasis on bifurcation theory. An introduction to the state-of-the-art (also for non-specialists) is complemented by a presentation of main open problems. We illustrate the theory by means of elementary examples. The main focus is on piecewise smooth systems, that have recently attracted a lot of attention, but we also briefly discuss other important classes of nonsmooth systems such as nowhere differentiable ones and differential variational inequalities. This extended framework allows us to put the diverse range of papers and surveys in this special issue in a common context. A dedicated section is devoted to concrete applications that stimulate the development of the field. This survey is concluded by an extensive bibliography.

Keywords: Nonsmooth system, piecewise smooth dynamical system, switching system, discontinuous switching manifold, nonuniqueness of solutions, uniqueness of solutions, complementarity condition, regularisation, piecewise smooth map, tent map, grazing bifurcation, border-collision bifurcation, nonsmooth perturbation theory, car braking system, static indeterminacy, stick-slip oscillations, Kolmogorov model of turbulence, piecewise analytic global bifurcation theory

1. Introduction

Nonsmooth dynamical systems have received increased attention in recent years, motivated in particular by engineering applications, and this survey aims to present a compact introduction to this subject as a background for the other articles in this special issue of *Physica D*.

In the field of *smooth* dynamical systems many results rely on (or have been derived under) certain smoothness assumptions. In this context the question arises to what extent nonsmooth dynamical systems have (or don't have) different dynamical behaviour than their smooth counterparts. As nonsmooth dynamical systems naturally arise in the context of many applications, this question is not merely academic.

One may be tempted to argue that nonsmoothness is a modelling issue that can be circumvented by a suitable regularisation procedure, but there are some fundamental and practical obstructions. Firstly, regularisation is not always possible. For instance, Kolmogorov's classical theory of incompressible fluids [200] asserts that the dependence of the velocity vector $v(x)$ as a function of the spatial coordinate x is of order $\frac{1}{3}$, leaving no sensible way to smoothen the continuous map $x \mapsto v(x)$ in order to render it differentiable everywhere [362]. Secondly, even if regularisation is possible, it may yield a smooth dynamical system that is very difficult to analyse (both numerically and analytically), obscuring certain important dynamical properties (often referred to as *discontinuity-induced phenomena*) that may feature more naturally in the nonsmooth model, see eg [168, 233]. Finally, mechanical systems with dry friction

display nonuniqueness of the limit when the stiffnesses of the regularisation springs approach infinity. Regularisation in mechanical models with friction is often accomplished by introducing virtual springs of large stiffnesses at the points of contact [364, 331, 261]. The specific configuration of the springs is assumed to be unknown, which accounts for the nonsmoothness of the original (rigid) system. Also, nonuniqueness in some control models can not be suppressed (known as *reverse-Zeno* phenomenon) and needs a theory to deal with, see Stewart [335]. For more on these, and other applications that require nonsmooth modelling, see Section 5.

Elementary stability theory for nonsmooth systems was first motivated by the need to establish stability for nonsmooth engineering devices see for instance Barbashin [25], Leine-Van-de-Wouw [227], and Brogliato [57]. A significant growth in the subject has been due to the understanding that nonsmooth systems display a wealth of complex dynamical phenomena, that must not be disregarded in applications. Some applications that illustrate the relevance of nonsmooth dynamics include the squealing noise in car brakes [20, 177] (linked to regimes that stick to the switching manifold determined by the discontinuous dry friction characteristics), loss of image quality in atomic force microscopy [357, 382, 263, 293] (caused by new transitions that an oscillator can undergo under perturbations when it just touches an elastic obstacle), and, on a more microscopic scale, the absence of a thermal equilibrium in gases modelled by scattering billiards [360, 197, 198] (whose ergodicity can be broken by a small perturbation as soon as the unperturbed system possesses a closed orbit that touches the boundary of the billiard).

The main focus of this survey is on aspects of dynamics in-

volving bifurcations (transitions between different types of dynamical behaviour). In Section 2 we review general (generic) bifurcation scenarios, while in Section 3 we review the literature on bifurcation problems posed in the context of explicit perturbations to (simple) nonsmooth systems with known solutions. Section 4 is devoted to nonsmooth systems that include a variational inequality and do not readily appear as a dynamical system. This very important class of nonsmooth systems (also known as differential variational inequalities) originates from optimisation [287] and nonsmooth mechanics [57]. In order to access the dynamics of differential variational inequalities the questions of the existence, uniqueness and dependence of solutions on initial conditions have been actively investigated in the literature. The engineering applications that stimulated the interest in analysis the dynamics of nonsmooth systems are discussed in Section 5. An extensive bibliography concludes this survey.

Despite our best efforts to present a balanced overview, this survey is of course not without bias, and we apologise to colleagues that will find their interests and results perhaps under-represented.

2. Bifurcation theory

A precise analysis of the dynamics of an arbitrary chosen dynamical system is rarely possible. A common approach to the study of dynamical systems is to divide the majority of the dynamical systems into equivalence classes so that the dynamics of any two systems from each such a class are similar (with respect to specific criteria). Usually (but not always) the equivalence classes are chosen to be open in a suitably defined space of dynamical systems. Bifurcation theory concerns the study of transitions between these classes (as one varies parameters, for instance), and the transition points are often referred to as singularities. For an elementary non-technical introduction to bifurcation theory, see Mees [262]. Many technical books on bifurcation theory have appeared over the years, see for instance [222].

We present an elementary example to illustrate the concept of bifurcation. Consider a ball in a pipe that is attached by a spring to one end of the pipe and subject to gravitation and a viscous friction. If the ends of the pipe are bent upwards the system has a unique stable equilibrium. However, if the ends of the pipe are bent down the pipe-ball system may exhibit three, one unstable and two stable, equilibria (see Fig. 1). There is a transition where the unique stable equilibrium splits into three co-existing equilibria (see Fig. 2). It can be shown rigorously that this *pitchfork* bifurcation is typical (and robust) in this type of model, and also that generically the equilibrium generically cannot admit a Hopf bifurcation (where stability is transferred to a limit cycle).

2.1. Border-collision bifurcations

If the friction characteristic in the above mentioned example has a discontinuity along the pipe, the oscillator may exhibit new dynamical behaviour. For example, a stable equilibrium

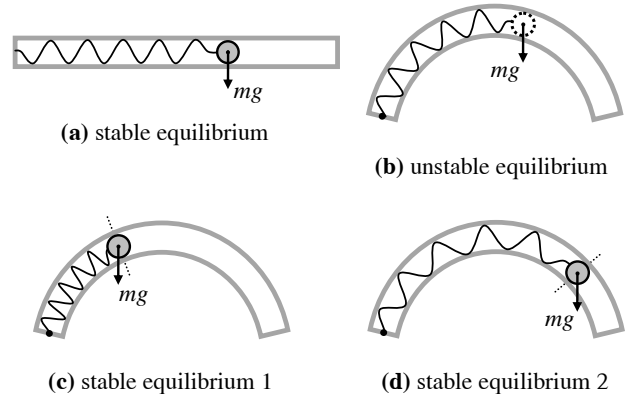

Figure 1: A ball attached to one end of a pipe subject to gravitation (directed downwards) and viscous friction.

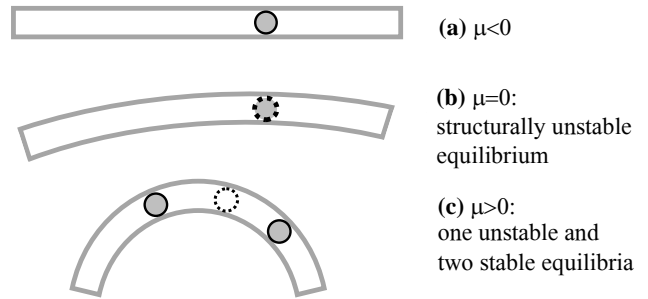

Figure 2: Illustration of how the pipe is being bent.

can lose stability under emission of a stable limit cycle (Hopf bifurcation) when the position of the discontinuity in the friction law moves (as a function of a changing parameter) past the equilibrium (see Fig. 3). This situation is modelled by the following equation of motion

$$\ddot{x} + x + c_1 \dot{x} - c_2 \dot{x}(\text{sign}(x - \mu) - 1) = 0. \quad (1)$$

When $\mu < 0$ there is one stable equilibrium $(x, \dot{x}) = (\mu, 0)$ that persists until $\mu = 0$. As μ increases further and becomes positive, the equilibrium loses its stability and a stable limit cycle arises from $(0, 0)$ (see Fig. 4). This bifurcation is characterised by the collision of the equilibrium with the *switching manifold* (defined by the discontinuity as $x = \mu$) $\{\mu\} \times \mathbb{R}$, and is known as a *border-collision bifurcation* of the equilibrium. Meiss and Simpson in [326] have proposed sufficient conditions for border-collision bifurcations where an equilibrium of \mathbb{R}^n transforms into a limit cycle. Some other scenarios have been investigated in di Bernardo-Nordmark-Oliver [47] and the paper by Rossa-Dercole [307] in this special issue. The paper by Hosham-Kuepper-Weiss [373] of this special issue provides conditions that guarantee the dynamics near an equilibrium on the border to develop along so-called *invariant cones*, providing a possible framework for further analysis of border-collision of an equilibrium in \mathbb{R}^n . From a mechanical point of view, we note that negative friction plays a crucial role in example (1). Another example of a border-collision bifurcation, where negative friction is essential, can be found in a paper by Kuepper [403].

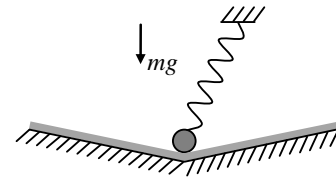

Figure 5: A ball attached through a spring to an immovable wall, resting in a corner of a piecewise flat surface.

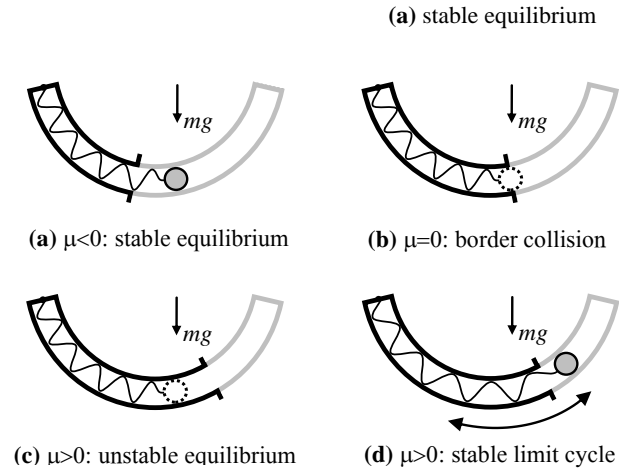

Figure 3: The pipe-ball system where the friction characteristic of the boundary changes discontinuously. The two parts where the friction characteristics is smooth are coloured in black and grey respectively. The distance between the friction discontinuity and the equilibrium of the ball is denoted by μ . The two figures in the bottom illustrate the co-existence of an unstable equilibrium and a stable limit cycle.

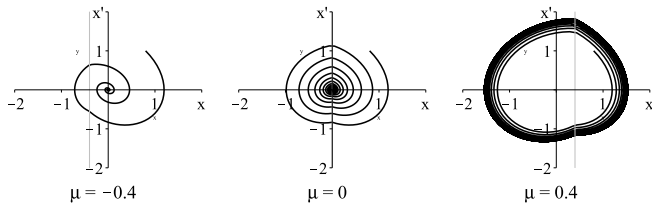

Figure 4: Trajectories of equations (1) at various values of the parameter μ . The gray line indicates the discontinuity in the vector field (this line is located to the left or to the right from $x = 0$ according to whether $\mu < 0$ or $\mu > 0$). The trajectories converge to a point if $\mu \leq 0$ and to a cycle if $\mu > 0$.

Although not standard, negative parts in the friction characteristics can appear in real mechanical devices because of the so-called *Stribeck effect* (see [227, §4.2]). Border-collision bifurcation caused by negative friction are also discussed in Leine-Brogliato-Nijmeijer [229].

Classifications of bifurcations from an equilibrium on a switching manifold of a discontinuous system have been derived by Guardia-Seara-Teixeira [154] and Kuznetsov-Rinaldi-Gragnani [223]. They show that the possible scenarios include homoclinic solutions and non-local transitions, e.g. a stable equilibrium can bifurcate to a cycle that doesn't lie in the neighbourhood of this equilibrium. In the case where the differential equations are nonsmooth but continuous along the switching manifold some non-standard border-collision bifurcations have been reported in Leine [233] and Leine-Van Campen [228]. Properties of the Clarke generalised Jacobian (versus the classical Fréchet derivative) proved to be conclusive here.

A point on the discontinuity (i.e. switching) manifold between two smooth systems can attract solutions while not being an equilibrium of any of these systems. An elementary illustration of this arises in

$$\ddot{x} + c\dot{x} + x = -2\text{sign}(x), \text{ with } c > 0. \quad (2)$$

Equation (2) comes from an analogue of the pipe-ball system whose boundary is straight, but undergoes a discontinuity at

a point (see Fig. 5). This point is the position of an asymptotically stable equilibrium as the mechanical setup suggests (a proof can be found in Barbashin [25], Leine-Van-de-Wouw [227]). In particular, small perturbations of the second-order differential equation (2) do not lead to bifurcations. This equation, therefore, serves as an example of the situation where a point on the switching manifold is an attractive equilibrium while not an equilibrium of any of the two smooth components

$$\ddot{x} + c\dot{x} + x = -2 \text{ and } \ddot{x} + c\dot{x} + x = 2, \text{ with } c > 0.$$

This example also highlights that not all bifurcations that are generic from the point of view of bifurcation theory are physically possible. In fact, the point $(0, 0)$ of the two-dimensional version of (2)

$$\begin{aligned} \dot{x} &= y + \mu \text{sign}(x), \\ \dot{y} &= -cy - y - 2\text{sign}(x) \end{aligned} \quad (3)$$

is attractive when $\mu = 0$. However, the phase portraits for $\mu < 0$ and $\mu > 0$ are drastically different, see Fig. 6. We thus see that

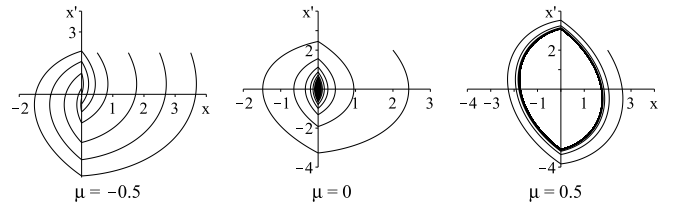

Figure 6: Trajectories of system (4) versus different values of the parameter μ . All the trajectories converge to an interval of $x = 0$, to the point $(0,0)$ or to a cycle according to where $\mu < 0$, $\mu = 0$ or $\mu > 0$.

only particular perturbations of system (3) with $\mu = 0$ preserve the attractive properties of the point $(0,0)$. What those particular perturbations are, has not yet been understood. Perhaps symmetry plays an important role here as the perturbations of equation (2) always lead to a symmetric (in \dot{x} coordinate) two-dimensional system. A result in this direction is presented by Jacquemard and Teixeira in this special issue [186].

Example (3) also illustrates the phenomenon of *sticking* in nonsmooth systems. Fig. 6 suggests that all the solutions of (3) with μ negative approach the interval $[-|\mu|, |\mu|]$ of the vertical axis and do not leave it in the future. The definition of how trajectories of (4) behave within this interval is usually taken by the *Filippov convention* [125], which recently has been further developed by Broucke-Pugh-Simic [59]. The Filippov convention and corresponding Filippov systems are discussed in several papers in this special issue. Biemond, Van de Wouw and

Nijmeijer [51] introduces the classes of perturbations that preserve an interval of equilibria lying on the discontinuity threshold and discuss the situations where such perturbations lead to bifurcations coming from the end points of the interval. Another approach disregards the dynamics inside $[-|\mu|, |\mu|]$ and treats this interval as an *attractive equilibrium set* of the differential inclusion

$$\begin{aligned} \dot{x} - y &\in \mu \text{Sign}(x), \\ \dot{y} + cy + y &\in -2\text{Sign}(x), \end{aligned} \quad (4)$$

where

$$\text{Sign}(x) = \begin{cases} -1, & x < 0, \\ [-1, 1], & x = 0, \\ 1, & x > 0. \end{cases}$$

For more on the latter approach, we refer the reader to the book by Leine and Van de Wouw [227] and references therein.

An attractive point on the discontinuity threshold can also be structurally stable. We refer the reader to the aforementioned papers Guardia-Seara-Teixeira [154] and Kuznetsov-Rinaldi-Gragnani [223] for classification of these points in \mathbb{R}^2 . As for the higher-dimensional studies, much attention has recently been given to the analysis of the dynamics near a point in \mathbb{R}^3 , where the smooth vector fields on the two sides of the switching manifold are tangent to this manifold simultaneously. Such equilibria were first described by Teixeira [353] and Filippov [125] and are known as *Teixeira singularities* or *U-singularities*. Teixeira [353] gave conditions where such a singularity is asymptotically stable. Colombo and Jeffrey showed [92, 189] that the Teixeira singularity can be a simultaneous attractor and repeller of local and global dynamics, where the orbits flow into the singularity from one side and out from the other. Chillingworth [84] analyses scenarios in which a Teixeira singularity loses and gains stability following the sketch in Fig. 7. An example of the occurrence of the Teixeira singularity in the context of an application has been discussed by Colombo, di Bernardo, Fossas and Jeffrey [90].

Nonsmooth systems with switching manifolds causing trajectories to jump, according to a so-called *impact law*, have become known as *impact systems*. Border-collision bifurcations of an equilibrium lying on a switching manifold of an impact system are classified in [47], but little has been done yet towards applications of these results. An equilibrium crossing the switching manifold is not the only transition that causes qualitatively changes to the dynamics near the equilibrium. Motivated by applications in control, the next Section discusses transitions that occur when a switching manifold (with an equilibrium on it) splits into several sheets. The Teixeira singularity may be no longer structurally stable under this type of perturbation that we refer to as *border-splitting*.

2.2. Border-splitting bifurcations

This type of bifurcation allows to prove the existence of limit cycles in so-called *switching systems* studied in the context of control theory. The illustration in Fig. 8 provides a simple example of a switching system. Two contacts are built into a pipe with a metal ball inside. These contacts are connected with

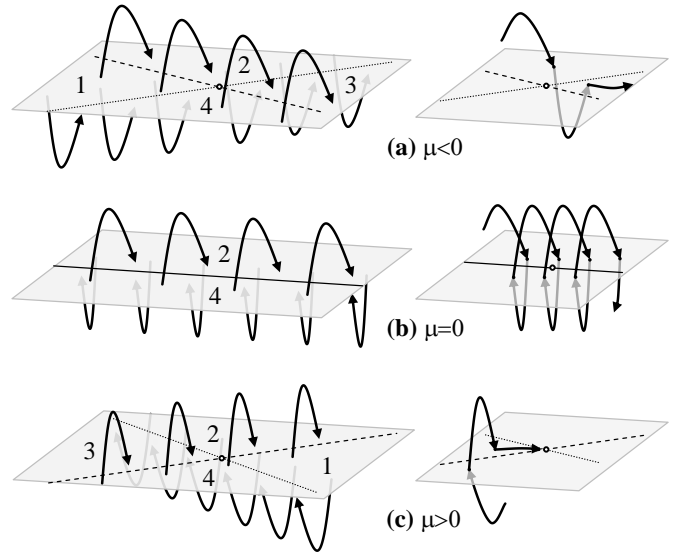

Figure 7: Teixeira singularity and its possible transformation when μ changes through a structurally unstable situation $\mu = 0$. The gray surface here is the switching hyperplane and the curves on the two sides of this hyperplane are the trajectories of two different vector fields, both of which is however tangent to the hyperplane at the point “•”.

magnets on either side that can attract the metal ball to the left or to the right. If the ball touches the black contact the left magnet deactivates and the right one activates. The opposite happens if the ball touches the white contact.

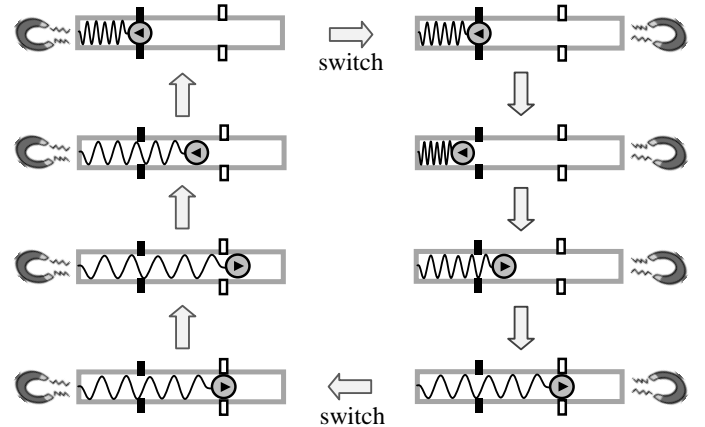

Figure 8: Illustration of a simple switching system. The right magnet activates and left magnet deactivates when the ball passes the the black contact. The opposite happens when the ball passes the white contact.

The following differential equation models this setup, where μ is the coordinate of the position of the white contact point, and $-\mu$ the coordinate of the black contact point,

$$\begin{aligned} \ddot{x} + c\dot{x} + x + k &= 0, \\ k &:= d, \quad \text{if } x(t) = \mu, \\ k &:= -d, \quad \text{if } x(t) = -\mu, \end{aligned} \quad (5)$$

i. e. $k = \pm d$ depending on whether the right or left magnet is activated. The existence of limit cycles in systems of this form

is known since Barbashin [25], but the fact that this cycle can be seen as a bifurcation from $(0,0)$ as a parameter indicating the distance of the black and white contact points from the centre crosses zero (see Fig. 9), hasn't been yet been pointed out in the literature. In some situations the aforementioned switching law can be replaced by a more general switching manifold (see the bold curve at the right graph of Fig. 9) that is non-smooth. This point of view has been proposed by Barbashin [25] for switching systems involving second-order differential equations, but no general results about its validity are available.

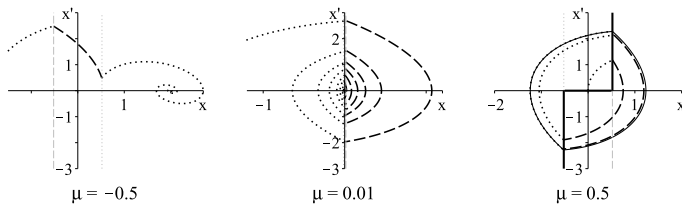

Figure 9: Trajectories of system (5) versus different values of the parameter μ . The constant k takes the values $-d$ and d when the trajectory crosses the dotted and the dashed lines correspondingly. These two lines can be viewed as analogues of the black and white contacts in the mechanical setup of Fig. 8. The trajectories escape from the local neighbourhood of $(0,0)$ and converge to one of the two stable equilibria, if $\mu < 0$ (left graph), converge to a limit cycle, if $\mu > 0$ (right graph). The middle graph illustrates that the radius of the limit cycle approaches 0 when $\mu \rightarrow 0$. The right graph also features the Barbashin's discontinuity surface, which is drawn in bold.

The interest in switching systems has been increasing by new applications in control, where switching is used to achieve closed-loop control strategies. For instance, Tanelli et al. [347] designed a switching system to achieve a closed-loop control for anti-lock braking systems (ABS). This example exhibits a nontrivial cycle and four switching thresholds. The classification of bifurcations in switching systems that are induced by changes in the switching threshold (splitting or the braking of smoothness) is a largely open question that has not yet been systematically addressed in the literature. Studying a natural 3-dimensional extension of system (5) leads to the problem of the response to the splitting of the switching manifold in a Teixeira singularity (see Fig. 10).

Where the switching manifold does not just cause a discontinuity in the vector field of the ODE under consideration, but introduces jumps into the solutions of these ODEs, the non-smooth system is called a *nonsmooth system with impacts* or *impact system*. No paper about border-collision of equilibria in such systems is available in the literature. The paper by Leine and Heimsch [226] in this special issue discusses sufficient conditions for stability of such an equilibrium (absence of bifurcation). This paper may play the same instructive role in the development of the theory of border-collision bifurcation of equilibrium in impact systems as the result about the structural stability of an equilibrium in second-order discontinuous ODEs, as sketched in Fig. 5.

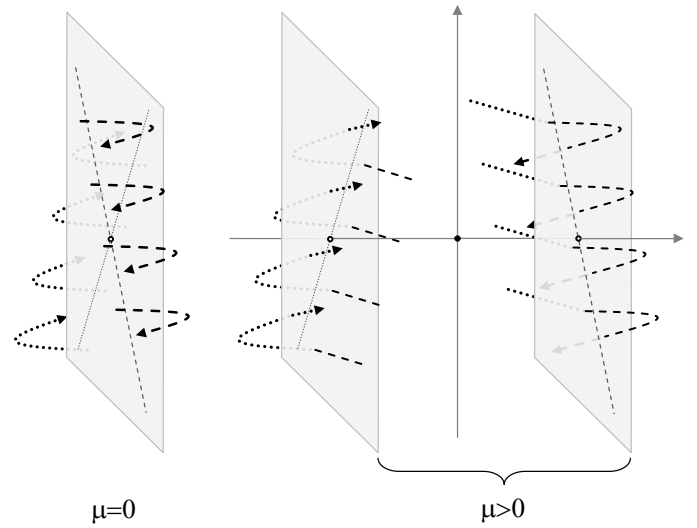

Figure 10: A partial sketch of trajectories of a 3-dimensional switching system (right graph). The limit of this sketch when the distance between the switching thresholds approach 0 (left graph).

2.3. Grazing bifurcations

It appears that only smooth bifurcations¹ can happen to a closed orbit that intersects the switching manifold transversally although the proof is not always straightforward, e.g. in the case of a homoclinic orbit as discussed by Battelli and Feckan [29] in this special issue. The intrinsically nonsmooth transitions occurring near closed orbits (or tori) that touch the switching manifold (nontransversally) are known as *grazing bifurcations* [49] or *C-bifurcations* [121]. This type of bifurcation is very common in applications. It for instance takes place when a mechanical system transits from a smooth regime to one that allows for collisions.

A simple example is that of a church bell rocked by a periodic external force. A grazing bifurcation occurs when the amplitude of the driving increases to the point where the clapper hits the bell, see Fig. 11. Somewhat surprisingly, the dynamical behaviour close to the grazing bifurcation associated with a low velocity chime appears to be chaotic, following Whiston [377], Nordmark [275] and, more recently, Budd-Piironen [64].

The simplest model of the bell-clapper systems has the bell in fixed position with only the clapper moving. Shaw and Holmes [317] pioneered the modelling of this situation by a single-degree-of-freedom *impact oscillator* (Fig. 12) with a linear restitution law:

$$\begin{aligned} \ddot{u} &= f(t, u, \dot{u}, \mu), \\ \dot{u}(t+0) &= -k\dot{u}(t-0), \quad \text{if } u(t) = c. \end{aligned} \quad (6)$$

The impact rule on the second line is such that the magnitude of the velocity of each trajectory changes instantaneously from $\dot{u}(t-0)$ to $-k\dot{u}(t+0)$ when $u(t) = c$. Though realistic restitution

¹The bifurcations or bifurcation scenarios that are solely possible in smooth dynamical systems are said to be *smooth bifurcations*.

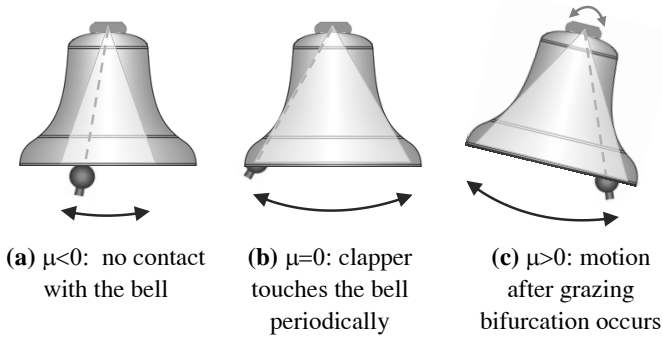

Figure 11: 3 different types of relative oscillations of the bell upon the clapper: clapper doesn't touch the bell; clapper touches the bell; clapper hits the bell

laws are known to be nonlinear (see e.g. Davis-Virgin [102]), Piiroinen, Virgin and Champneys [297] conclude that (6) models the actual dynamics of a constrained pendulum reasonably well. A more general mathematical model of the impact oscillator of Fig. 12 can be found in Schatzman [314].

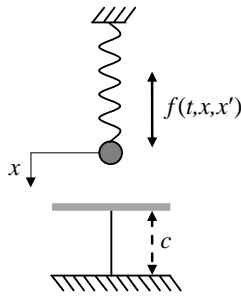

Figure 12: Impact oscillator, i.e. a ball attached to an immovable beam via a spring that oscillates upon an obstacle and subject to a vertical force $f(t, u, \dot{u})$.

We now consider the natural grazing bifurcation in this model. We start considering the system (in the parameter regime $\mu < 0$) with a (stable) periodic cycle that does not impact the $u = c$ line. By increasing μ smoothly we envisage that the amplitude of the periodic cycle changes smoothly to touch $u = c$ precisely at $\mu = 0$. This implies that in the phase space the trajectory is tangent to the line $u = c$ since the orbit has zero velocity at the external point of the cycle at $u = c$.

We now present a simple argument to explain the at first sight somewhat surprising fact that the tangent (also known as *grazing*) periodic trajectories of generic impact oscillators (6) are unstable. Indeed, fix an arbitrary $\tau \in \mathbb{R}$ and consider the trajectory of system (6) with the initial condition $(u(\tau-0), \dot{u}(\tau-0)) = (c, \dot{u}_0(\tau))$, where $u_0(t)$ denotes the grazing orbit, see Fig. 13. If $f(t_0, c, 0, 0) \neq 0$, it is a consequence of the fact that the grazing orbit impacts with zero velocity ($\dot{u}_0(t_0) = 0$, where t_0 denotes

the time of grazing impact) that²

$$\frac{\|(u_0, \dot{u}_0)(\tau) - (u, \dot{u})(\tau+0)\|}{\|(u_0, \dot{u}_0)(\tau) - (u, \dot{u})(\tau-0)\|} \rightarrow \infty \quad \text{as } \tau \rightarrow t_0.$$

This implies that there is always a trajectory that escapes from an arbitrary small neighbourhood of the grazing trajectory u_0 . For a complete proof of the instability see Nordmark [275].

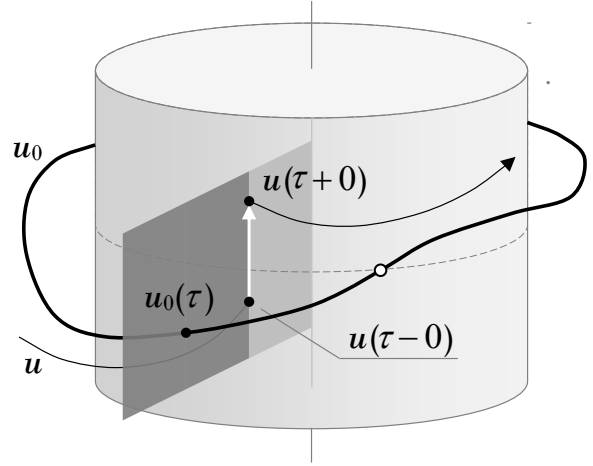

Figure 13: Periodic trajectory u_0 (bold curve) of system (6) in cylindrical coordinates, i.e. a point ζ is assigned to $u_0(t)$ in such a way that $u_0(t)$ is the distance from ζ to the vertical axis of the cylinder, $\dot{u}_0(t)$ is the vertical coordinate of ζ and t is the angle measured from a fixed hyperplane containing the axis of the cylinder. The surface of the cylinder is given by $u = c$, so that the trajectory u_0 grazes the cylinder at the point "o". The curve u is a part of the trajectory that originates from ζ .

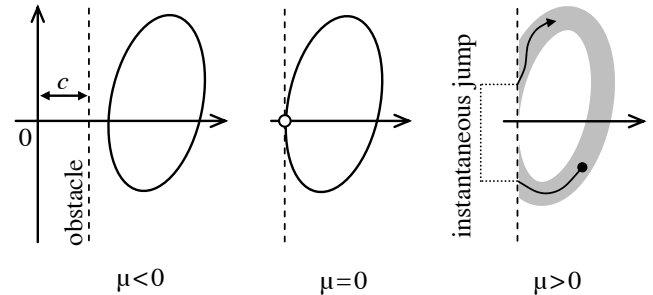

Figure 14: A stable periodic solution that exists for $\mu < 0$ collides with the obstacle when $\mu = 0$. A grazing bifurcation occurs at this point, leading to the appearance of a trapping region (drawn in gray) for small $\mu > 0$. This trapping region may contain stable periodic orbits.

It has been noticed by Nordmark [275] that shortly after grazing, there remains to be a trapping region R in its (former) neighbourhood, so that all the trajectories that originate in R

²It is sufficient to observe that

$$\frac{\|(u_0, \dot{u}_0)(\tau) - (u, \dot{u})(\tau+0)\|^2}{\|(u_0, \dot{u}_0)(\tau) - (u, \dot{u})(\tau-0)\|^2} = \frac{(u_0(\tau) - c)^2 + ((1+k)\dot{u}_0(\tau))^2}{(u_0(\tau) - c)^2},$$

where $\dot{u}_0(\tau) / (u_0(\tau) - c) \rightarrow \infty$ by l'Hopital's rule (as $\ddot{u}_0(t_0) = f(t_0, c, 0, 0)$ and $\dot{u}_0(t_0) = 0$).

don't leave this region. An important step in studying the response of the dynamics in R to varying μ and c is due to Chillingworth [85], who introduced a so-called *impact surface*. The work [82] by Chillingworth, Nordmark and Piiroinen relates the Morse transitions of this surface (investigated in [85]) to possible global bifurcations. Insightful numerical simulations in relation to the dynamics on this impact surface have been carried out by Humphries-Piiroinen [173] in this special issue. Kryzhevich [213] has studied topological features of the attractor in R . Luo and colleagues [242, 243] have published many numerical results about the dynamics in R when the ODE in (6) is a linear oscillator.

Nordmark has introduced a general notion of a *discontinuity mapping* which is a method for deriving an asymptotic description of the Poincaré map at a grazing point of any piecewise smooth system. This method enables a generalisation of these concepts to study which periodic orbits exist and their stability types in a neighbourhood of a grazing bifurcation in arbitrary N -dimensional dynamical systems [278]. Using this approach, it can be shown [277] that the leading-order expression for the Poincaré map at a grazing bifurcation in an impacting system contains a square-root singularity and can be written in the form [275, p. 290]

$$\begin{pmatrix} \bar{\xi} \\ \bar{\eta} \end{pmatrix} = \begin{pmatrix} \sqrt{\mu - \xi} + \eta + (\lambda_1 + \lambda_2)\mu \\ -\lambda_1\lambda_2\mu + \lambda_1\lambda_2k^2(\mu - \xi) \end{pmatrix}, \quad \text{if } \xi - \mu \leq 0, \\ \begin{pmatrix} \bar{\xi} \\ \bar{\eta} \end{pmatrix} = \begin{pmatrix} \eta + (\lambda_1 + \lambda_2)\xi \\ -\lambda_1\lambda_2\mu + \lambda_1\lambda_2(\mu - \xi) \end{pmatrix}, \quad \text{if } \xi - \mu \geq 0, \quad (7)$$

where λ_1 and λ_2 are constants representing details of f . For $\mu < 0$ the point $(0, 0)$ is a fixed point of the map (7), reflecting the fact that the oscillator (6) has a T -periodic solution that doesn't collide with the obstacle. When μ increases through zero this fixed point and complicated dynamics emerges. This intrinsically nonsmooth bifurcation is known as a *border-collision of a fixed point*. Many have investigated border-collision bifurcations through two-dimensional maps of the form (7), see e.g. Nordmark [275, 278], Chin-Ott-Nusse-Grebogi [88], Feigin [121], Dutta-Dea-Banerjee-Roy [112], and Di Bernardo-Budd-Champneys-Kowalczyk [49]. One of the central conclusions of this collaborative effort is the assertion that the impact oscillator (6) typically has no stable near- T -periodic solutions near u_0 after the occurrence of grazing. In addition, Nordmark [278] gives conditions for the existence of periodic solutions which do not only have arbitrary large periods, but which also have a prescribed symbolic binary representation (a 0 representing a revolution after which the orbit "does not hit the cylinder", and 1 when it "hits the cylinder"). A geometric impact surface approach [85] is used in Chillingworth-Nordmark [83] to reveal the geometry behind the bifurcation of impacting periodic orbits from u_0 . The map (7) can be viewed as a generalization of a piecewise smooth *Lozi-map*, but the results known for the Lozi-map are normally formulated in terms of one-sided derivatives [140, 384] that doesn't exist for (7) at $(0, 0)$. Several papers (e.g. Thota-Dankowicz [357], Dankowicz-Jerrelind [100], Thota-Zhao-Dankowicz [358], Rom-Kedar-Turaev [360, 306], Janin-Lamarque [187]) discuss non-generic situations (with

more structure), where a stable T -periodic solution is not destroyed and keeps its stability after grazing. The first result in this direction is due to Ivanov [181] who related the phenomenon of the persistence of a periodic solution under grazing to a resonance between the periodic force and the eigenfrequency of the oscillator in (6). Budd and Dux [62] relate intermittent chaotic behaviour after grazing bifurcations to resonance conditions.

The map (7) is derived by truncation from a certain Taylor series. In fact, arbitrary higher-order terms in such maps can be derived using Nordmark's discontinuity mapping approach [274]. The need for higher-order terms to detect certain bifurcation scenarios is discussed in Molenaar-De Weger-Van de Water [269], see also Zhao [389].

According to [49, §1.4.2] certain aspects of the dynamics of the 2-dimensional map (7) can be learned from studying the following simpler map of dimension 1

$$\xi \mapsto g(\xi), \quad g(\xi) = \begin{cases} \sqrt{\mu - \xi} + \lambda\mu, & \text{if } \xi - \mu \leq 0, \\ \lambda\xi, & \text{if } \xi - \mu \geq 0. \end{cases} \quad (8)$$

When μ increases through zero the fixed point 0 undergoes a border-collision bifurcation, see Fig. 15. This phenomenon has been a subject of investigation in Nusse-Ott-Yorke [283], di Bernardo-Budd-Champneys-Kowalczyk [49], Fredriksson-Nordmark [128], Nordmark [277], Avrutin-Dutta-Schanz-Banerjee [6], and Casas-Chin-Grebogi-Ott [78].

The system (8) can be viewed as a generalized version of the familiar *tent map* (see e.g. the book [146] by Glendinning), but with a fixed point in its corner (when $\mu = 0$). Based on

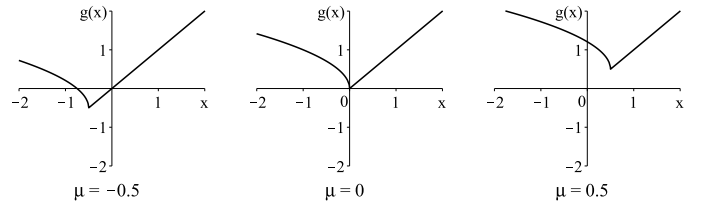

Figure 15: The map (8) at different values of the parameter μ .

Lagrangian equations of motion, Nordmark [128] shows that the map of (8) can model the dynamics of several-degrees-of-freedom impact oscillators. In particular, by using a suitable one-dimensional map of the form (8), Nordmark [128] recaptures the bifurcation scenarios that he found earlier in the two-dimensional map (7) [275]. However, the validity of the proposed reduction of the two-dimensional dynamics of maps of the form (7) to one-dimensional maps of the form (8) is a largely open question. This dimension reduction issue is also discussed in the survey by Simpson and Meiss [325] in this special issue. That the aforementioned reduction is not always possible, even for piecewise linear two-dimensional maps, follows from the fact that the attractors of similar (7) two dimensional piecewise linear maps (i.e. when a linear term appears in the place of the square-root one in (7)) are sometimes truly two-dimensional, see Glendinning-Wong [143].

Another intrinsically nonsmooth phenomenon happens when the function $(t, x, \dot{x}) \mapsto f(t, x, \dot{x}, 0)$ takes 0 value at the point

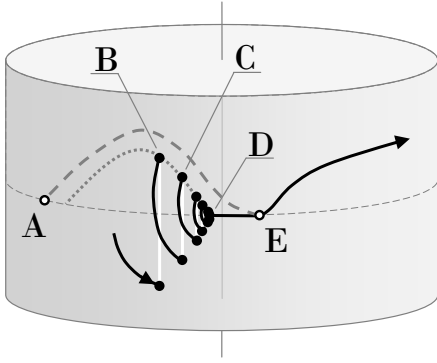

Figure 16: Sketch of a chattering trajectory (black solid curve) of the impact oscillator (6). After the first collision with the cylinder this trajectory lands on its stable manifold (dotted curve) and keeps hitting the cylinder until it accumulates at $\dot{x} = 0$. The trajectory gets released after it approaches the discontinuity arc (dashed bold curve), where $t \mapsto f(t, c, 0, \mu)$ changes sign from negative to positive.

where a closed orbit u_0 grazes the switching manifold. Increasing $\mu > 0$ can here lead to bifurcation of orbits with *chattering*, where an infinite number of impacts occur in a finite time interval, see Fig. 16. Chillingworth [86] was the first to establish a precise understanding of the local dynamics near such a grazing bifurcation with chattering, asserting that all the chattering trajectories from a neighbourhood of the original grazing orbit u_0 hit the switching manifold along their own stable manifolds (one such manifold is represented by a dotted curve in Fig. 16) which all are bounded by a stable manifold that is tangent to $\dot{x} = 0$ (represented by a dashed bold curve in Fig. 16). Any trajectory that hits the switching manifold (cylinder) within the region surrounded by the dashed curves (stable manifold that approaches $\dot{x} = 0$ at E and $\dot{x} = 0$ itself) leads to chattering that accumulates on $\dot{x} = 0$ (in the same way as the sample trajectory of Fig. 16 accumulates to the point D). The trajectory stays quiescent then until it gets released when reaching the discontinuity arc (the point E). This (*Chillingworth-Budd-Dux*) region shrinks to a point (i.e. the two white points A and E converge to one point where u_0 grazes) as μ approaches 0. A formula for the map g that maps one collision on the dotted curve into another one (e.g. point B into point C) was proposed by Budd and Dux in [63] and revised by Chillingworth [86]. To optimize numerical simulations, Nordmark and Piironen [280] derive a map that takes the points of a stable manifold (say B, or C) to the point D. A similar map has been earlier derived by Bautin [32] for a pendulum model of a clock, see also a relevant discussion in Feigin [121, §8.2]. At the same time, little is known about how the local dynamics near grazing interplays with the global dynamics near u_0 .

If the obstacle in the impact oscillator Fig. 12 is not absolutely elastic, two model situations are often studied. In the first one, the obstacle is another spring attached to an immovable wall that constrains the motion of the mass from one side (Fig. 17a). This obstacle determines a switching manifold where the right-hand sides of the equations of motion

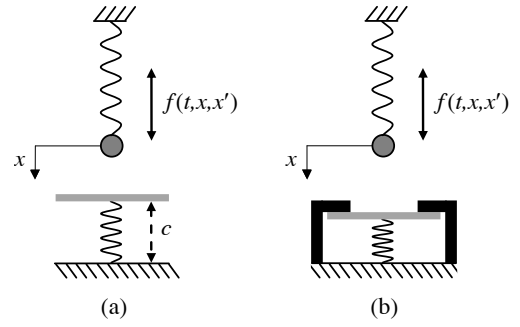

Figure 17: (a) An oscillator with one-sided spring, (b) an oscillator with one-sided preloaded spring

are continuous but have discontinuous derivatives.³ In contrast to absolutely elastic obstacles, the asymptotic stability of a closed orbit is not generically destroyed under collision with an unstressed spring (see [225, Lemma 2.2]) and additional assumptions are necessary to guarantee that grazing of a periodic orbit in the context of Fig. 17a leads to a bifurcation, see di Bernardo-Budd-Champneys [46], He-Feng-Zhang [162], Dankowicz-Zhao-Misra [101], Hu [172], Misra-Dankowicz [266] for analytic and [292] for numerical results.

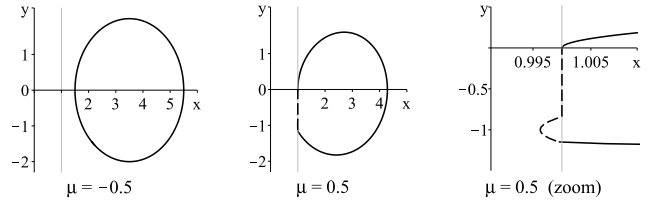

Figure 18: Stable periodic trajectories of (10) at different values of μ . Here $c = 1$, $k = 0.5$, $A = 1$, $B = 4$.

Much attention has recently been devoted to grazing bifurcations in oscillators with a so-called *preloaded* or *prestressed* spring⁴. Fig. 17b contains an illustration. A preloaded spring doesn't create impacts, but defines a switching manifold where the equations of motion are discontinuous, see Duan-Singh [111]. Also in this context, grazing doesn't necessary imply bifurcation. However, in numerical simulations, Ma-Agarwal-Banerjee [253] have found that grazing of a periodic orbit in the prototypical preloaded oscillator of the form

$$\ddot{u} + k\dot{u} + \text{sign}(u - c) + u = A \sin(\omega t) + B \quad (9)$$

leads to bifurcation for a large set of parameters. The same paper [253] also suggests that a grazing bifurcation of a periodic solution of (9) can be modelled by a border-collision bifurcation

³The equations of motion for the oscillator in Fig. 17a often include a discontinuity caused by viscous friction characteristics, see Babin [19] or Krukov [214]. However, this discontinuity is only formal as Levinson's change of variables [234] always transforms them to ones with continuous right-hand sides.

⁴The term "preloaded oscillator" is sometimes also used in a different context, see Peterka [294] and Whiston [378].

of a fixed point in a suitable two-dimensional piecewise linear continuous map: (the map (7) where the square-root $\sqrt{\mu - \xi}$ is replaced with $\mu - \xi$). A theoretical justification of this assertion can be found in Di Bernardo-Budd-Champneys [46] under the assumption that system (9) does not possess *sliding solutions* (i.e. solutions that stick to the switching manifold for positive time intervals, see Fig. 6 for an illustration). Numerical confirmation can be found in Leine-Van Campen [228, p. 606].

Border-collision bifurcations of a fixed point in piecewise linear continuous maps is an actively developing branch within the theory of nonsmooth dynamical systems, see Nusse-Yorke [284], Zhusubaliyev-Mosekilde-Maity-Mohanan-Banerjee [396], Zhusubaliyev-Mosekilde [397], Hassouneh-Abed-Nusse [161], Elhadj [115], Ma et al. [254], (transitions to higher periods and chaos observed numerically), Banerjee-Grebogi [23], [203], Sushko-Gardini [341, 342], Avrutin-Schanz-Gardini [7], Simpson-Meiss [327] (analytic approach to classification), Ganguli-Banerjee [137] Do-Baek [107] (dangerous bifurcations), Glendinning-Wong [143, 145], Gardini-Tramontana [140] (snap-back repellers), and Glendinning [144] (Markov partitions). Not all conclusions achieved for the piecewise linear category remain valid for nearby piecewise smooth nonlinear maps, see e.g. Simpson-Meiss [328].

The question whether equation (9) has sliding solutions has not yet been rigorously answered, and only assumed to be true in [253]. An important role here might be played by the symmetry in \dot{u} . Indeed, a non-symmetric perturbation of (9) of the form

$$\begin{aligned} \dot{x} &= y - \mu (\text{sign}(x - c) - 1), \\ \dot{y} &= -ky - \text{sign}(x - c) - x + A \sin(\omega t) + B + \mu \end{aligned} \quad (10)$$

does evidently have sliding solutions. Specifically, Fig. 18 illustrates that a non-sliding periodic solution in system (10) transforms to a sliding one (through grazing) as μ changes sign from negative to positive.

Although absent in the second-order differential equation modelling the preloaded oscillator of Fig. 17, grazing bifurcations of solutions with a sliding component (also known as *grazing-sliding bifurcations*) play a very important role in many other applications in mechanics and control. A prototypical example is a dry friction oscillator where the switching manifold is horizontal and where the occurrence of periodic solutions with sliding is a well known phenomenon (due to the pioneering work of Den Hartog [158], it is sometimes referred to as the *Den Hartog problem*). For further studying grazing-sliding bifurcations in dry friction oscillators and general discontinuous systems (Fillipov systems, see previous section) we refer the reader to Luo-Gegg [247, 248, 249, 250], Kowalczyk-Piironen [204], Kowalczyk-di Bernardo [205], Galvanetto [132, 133, 134], Nordmark-Kowalczyk [279], di Bernardo-Kowalczyk-Nordmark [43], Svahn-Dankowicz [344, 345], di Bernardo-Hogan [45], Guardia-Hogan-Seara [155], [190], Kuznetsov-Rinaldi-Gragnani [223], Szalai-Osinga [346], Teixeira [352], Benmerzouk-Barbot [35], and to Jeffrey-Hogan [191] and Colombo-di Bernardo-Hogan-Jeffrey [89] in this volume for a review of sliding bifurcations. More numerical results can

be found in Sieber-Krauskopf [318], Cone-Zadoks [93], and Dercole-Gragnani-Kuznetsov-Rinaldi [105].

In addition to the two types of nonlinear springs that are depicted in Fig. 17 the spring characteristic may include so-called *hysteresis loops*. In the simplest case the stiffness of the spring depends not only on its extension, but also on whether it is stretched or compressed. More generally, hysteresis may refer to various types of memory, see Krasnoselski-Pokrovski [207]. We refer the reader to Babitsky [19] for a discussion of mechanical models. Grazing bifurcations in systems with hysteresis have been investigated in Dankowicz-Paul [99] and in this special issue Dankowicz-Katzenbach [98] introduce a general framework for studying grazing bifurcations in nonsmooth systems that can contain, in particular, hysteretic nonlinearities.

The dynamics of a system of two coupled pendulums (similar to that of the bell-clapper system of Fig. 11) reveals an essential novelty. It was reported already in 1875, see Veltmann [365, 366], that the famous Emperoris bell in the Cathedral of Cologne incidentally failed to chime as the clapper stuck to the bell. It appears that in contrast with individual oscillators, chattering becomes generic and even intrinsic for grazing bifurcations in coupled impact oscillators. In one of the scenarios for this bifurcation there is an emergence of periodic orbits with chattering followed by a sticking phase, see Wang [371, 372], Luo-Xie-Zhu-Zhang [252] for linear restitution law and Davis-Virgin [102] for a more realistic restitution law derived from experiments.

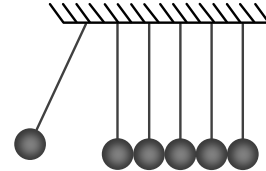

Figure 19: A typical Newton cradle, a system of n balls suspended to an immovable beam.

A familiar realization of higher-dimensional impact oscillators is known as *Newton cradle*, see Fig. 19. The discrete dynamical system that arises from the analysis of grazing bifurcations in the model of Fig. 19 with a linear restitution law resembles that of a so-called *billiard flow*, whose border-collision bifurcations are investigated in papers by Rom-Kedar and Turaev [360, 306]. However, various studies (see e.g. [77, 147]) suggest that the nonlinear nature of the restitution law in the real mechanical setup of Fig. 19 is crucial for understanding the phenomena that the Newton cradle exhibits. Little is known about the consequences of grazing bifurcations in these nonlinear settings. One of the open conjectures is: for almost all initial data and whatever the dissipation, the Newton cradle converges asymptotically towards a rocking collective motion with all the balls in contact (Brogliato, personal communications).

3. Specific perturbative results

Perturbative results are inherent to the methodology of bifurcation theory, when used to gain insight into the generic unfolding of all possible responses of a given trajectory to perturbations, often with focus on a particular type of dynamics, e.g. on periodic solutions of a certain period. Sometimes, perturbative results may yield local results in the sense that they yield all the dynamics in a (sufficiently small) neighbourhood of an original trajectory. If we consider small perturbations of a dynamical system whose solutions are known in the whole phase space, then perturbation theory may provide more global information into the dynamics of the perturbed system (e.g. it can help to determine how fast the convergence of the trajectories to a periodic solution of the perturbed system is). An introductory discussion on perturbation theory can be found in Guckenheimer-Holmes [153, Ch. 4].

In simple mechanical systems, exact solutions are often known if the friction or the magnitude of some excitatory forces are neglected. The latter type of effects may then be modelled as small perturbations. For example, the existence of the limit cycle for equation (1) that has been identified in the previous Section by increasing μ through zero (see Fig. 4) can be detected for any fixed μ by varying the friction coefficients c_1 and c_2 through zero. An added benefit of this kind of perturbative approach is that it yields information about the domain of attraction of the aforementioned limit cycle. All this can be achieved in principle along the classical lines of the proof of the existence of limit cycles of Van der Pol oscillators, by averaging, and does not necessarily require any specific nonsmooth theory (see Andronov-Vitt-Khaikin [1, Ch. IX]).

A new type of problem arises if one attempts to apply the perturbation approach and analyse the asymptotic behaviour of switching systems. Indeed, the solutions of (5) are known completely when $k = 0$, but their norms approach infinity, if time goes to infinity. Consequently, the limit cycle that is displayed in Fig. 9 can be seen for any fixed μ as a bifurcation from infinity when k crosses zero (see Fig. 20). The global attractivity properties of the latter cycle can be understood by a suitable modification of standard perturbative approaches for studying perturbations of infinity. Although this problem is essentially a smooth one, the class of switching systems serves as a rich source of open problems.

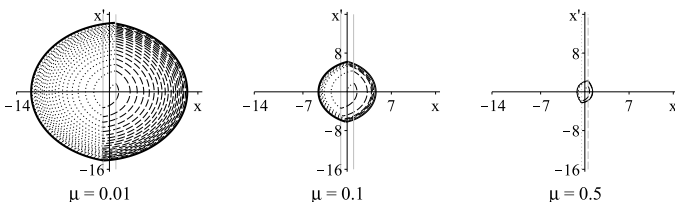

Figure 20: Stable periodic solutions of system (5) versus different values of the parameter μ , i.e. the stable limit cycle of (5) bifurcates from infinity as the damping coefficient k deviates from 0 in the positive direction.

The development of intrinsically nonsmooth perturbation methods is required for the analysis of grazing bifurcations.

The continuous differentiability of the solutions in linear or Hamiltonian systems with impacts has been largely unexplored. This property stands in contrast with that of generic impact systems with square-root type singularities, but provides an opportunity for the development of a perturbation theory for trajectories that graze an impact manifold.

To illustrate this, let us consider the following elementary example of an impact oscillator, cf. (6),

$$\begin{aligned} \ddot{x} + \varepsilon k \dot{x} + x &= A \varepsilon \cos(\omega t), \\ \dot{x}(t+0) &= -(1 - \varepsilon r) \dot{x}(t-0), \quad \text{if } x(t) = c, \end{aligned} \quad (11)$$

The solutions of the unperturbed system (with $\varepsilon = 0$)

$$\begin{aligned} \ddot{x} + x &= 0, \\ \dot{x}(t+0) &= -\dot{x}(t-0), \quad \text{if } x(t) = c, \end{aligned} \quad (12)$$

form a family of closed orbits (see Fig. 21). Perturbations of these orbits can be studied via natural adaptations (accounting for the switching manifold of impacts) of the classical Bogolyubov and Melnikov perturbation methods, developed in Li-Du-Zhang [236], Samoilenko-Samoilenko-Sobchuk [312], Burd-Krupenin [72], and Burd [71, §15.4]. Zhuravlev-Klimov [391, §27-§28], Thomsen-Fidlin [354], Fidlin [123], and Philipchuk [296] used a so-called *method of discontinuous transformation* to remove the impacts and transform equations of the form (11) into nonsmooth differential equations where the switching manifold causes discontinuities only.

Perturbation methods for differential equations with discontinuous right-hand sides have been developed in Fidlin [122, 124], Li-Du-Zhang [109] and, more recently, Granados-Hogan-Seara [152]. Where the obstacle in the impact oscillator is not absolutely elastic (Fig. 17) the perturbation methods by Samoilenko [309], Samoilenko-Perestyuk [310, 311] (for prestressed oscillators with small jumps in the stiffness characteristics) and X. Liu, M. Han [238], and Lazer-Glover-McKenna [148] (for piecewise smooth continuous stiffness characteristics) can be employed. However, none of these methods apply to the unperturbed trajectory that touches the line $x = c$ (bold cycle in Fig. 21). Again, the theory of discontinuity mappings due to Nordmark (see [49, Ch. 2, Ch. 6-8] for more details) can be fruitful here.

In contrast with the generic impact situation grazing periodic solutions in linear or Hamiltonian systems may well gain stability under perturbations. Fig. 21 illustrates this assertion for the particular example (11). The significantly better stability properties of grazing induced resonance solutions with respect to the unperturbed ones are not seen in the smooth perturbation theory. Numerical results in Leine-van Campen [230, 231, 232] and Kahraman-Blankenship [192] suggest that the grazing induced resonances may also have nonsmooth scenarios (jump of multipliers) in non-impacting discontinuous and even in non-differentiable continuous differential equations (see an earlier footnote about Levinson's change of variables).

Theoretical and experimental evidence of non-standard resonances in coupled nonsmooth oscillators is discussed in the paper by Casini-Giannini-Vestroni [79] in this special issue. Another new class of problems relates to perturbations of a

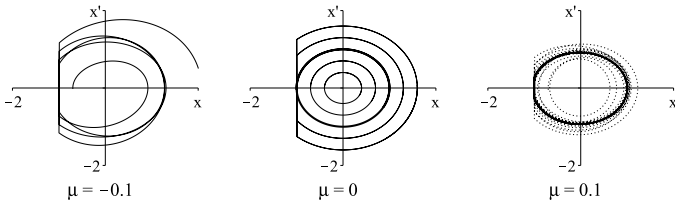

Figure 21: Trajectories of system (11) versus different values of the parameter μ . The leftmost figure depicts an orbit that escapes from any bounded region. The middle figure shows the closed orbits of the unperturbed system (12) and the rightmost figure suggests the existence of a stable periodic solution to (11) for small positive μ . Here $k = 1$, $A = 1$, $r = 0$, $c = -1$.

closed orbit in the case where this orbit transits into a (resonance) solution that intersects the switching manifold an infinite number of times. One important example is the development of Melnikov perturbation theory for homoclinic orbits by Batelli-Feckan [30, 31] (see also their paper in this special issue), Du-Zhang [108], Xu-Feng-Rong [380], Kukucka [218]. Another example is the analysis of the response of periodic orbits to almost periodic perturbations initiated by Burd [71] (see also his paper [70] in this volume). A common ingredient of these studies is an ability to control the aforementioned infinite number of intersections, that has been only achieved for non-grazing situations so far.

One of the central approaches within the theory of perturbations is the study of the contraction properties of finite-dimensional or integral operators associated to the perturbed system based on contraction properties of a so-called bifurcation function. The particular choice of the operator depends on the type of the dynamics one wants to access (periodic, almost periodic, chaotic). This approach has been initiated by the classical Second Bogolyubov's theorem ([55],[153, Theorem 4.1.1(ii)]) that recently started to be developed for grazing situations by Feckan [119] (discontinuous ODEs) and Buica-Llibre-Makarenkov [67, 68, 69] (continuous nondifferentiable ODEs). Though the development of the second Bogolyubov's theorem for single-degree-of-freedom impact oscillators of form (11) near grazing solutions looks manageable, accessing higher dimensional prototypic mechanical systems may be challenging. Indeed, coupling of even linear impact oscillators leads to complex behaviour where chattering trajectories may occupy a non-zero measure set of the phase space, see Valente-McClamroch-Mezic [361].

Another approach that has its roots in the First Bogolyubov's theorem ([55],[153, Theorem 4.1.1(i)]) discusses the dynamics on a finite time interval of the order of the amplitude of the perturbation. This approach has been extended to differential inclusions in papers by Plotnikov, Filatov, Samoylenko, Perstyuk and the survey by Skripnik [199] in this special issue provides an overview of this research direction. Resonances in impact oscillators formulated in the form of differential inclusions are investigated by Paoli and Schatzman in [288].

Versions of the first Bogolyubov's theorem for differential equations with bounded variation right-hand-sides are developed in Iannelli-Johansson-Jonsson-Vasca [174, 175, 176] in

the context of control systems subject to a dither noise. The response of a piecewise-linear FitzHugh-Nagumo model to a white noise is investigated in Simpson-Kuske [320]. However, the research on the response of nonsmooth systems to random perturbations has the potential for a great deal of strengthening.

The part of perturbation theory that is based on versions of the first and the second Bogolyubov's theorems is commonly known as *averaging principle*. Though differential inclusions form a very broad class of nonsmooth dynamical systems and even includes a class of switching systems (if the Barbashin switching manifold is used, see previous section), some important problems in nonsmooth mechanics are most conveniently formulated in terms of even more general equations called *measure differential inclusions* (see the books by Moreau [271], Monteiro Marques [270], and Leine-Van-de-Wouw [227]). An averaging principle for measure differential inclusions appears within reach, but has not yet been developed.

As for nonsmooth systems with hysteresis we refer the reader to the book by Babitsky [19] and the survey by Brokate-Pokrovskii-Rachinskii-Rasskazov [58] for the perturbation theory that is currently available for this class of systems.

A largely open question within the theory of perturbations of nonsmooth systems is the persistence of KAM-tori in nonsmooth Hamiltonian systems under perturbations. Numerical simulations by Nordmark [276] suggest that KAM-tori in Hamiltonian systems with impacts are destroyed under grazing incidents. However, a theoretical clarification is unknown for even the simplest examples of the form (11) (with $k = 0$). Adiabatic perturbation theory for Hamiltonian systems with impacts is developed in Gorelyshev-Neishtadt [149, 150], who introduced an adiabatic invariant that preserves the required accuracy near grazing orbits as well.

Pioneered by Mawhin [260], while working with linear unperturbed systems, topological degree theory is often used in the literature to relate the topological degree of various operators associated with the perturbed system to the topological degree of the averaging function. Several advances have been made in this direction since then. For example, Feckan [119] (see also his book [120]) generalised the Mawhin's concept for nonlinear unperturbed systems, while focusing the evaluation of the topological degree on neighbourhoods of certain points. Working in \mathbb{R}^2 , Henrard-Zanolin [385], Makarenkov-Nistri [258] and Makarenkov [257] developed similar results in more global settings (these methods can be eventually used to evaluate the topological degree of the Poincare map of (11) with respect to the interior of the circle of radius c).

Though topological degree theory has the reputation of being capable to work with nonsmooth system, the grazing of an orbit possesses challenging questions also here. One such a question is how to evaluate the topological degree of the 2π -return map of the unperturbed system (12) with respect to the neighborhood of the interior of the disk of radius c (which grazes the switching manifold), see Fig. 22, and the analogues of the Krasnoselskii [206, Lemma 6.1] and Capietto-Mawhin-Zanolin [75] results known in the non-grazing situation. Another question is whether the topological index of a grazing periodic solution of a generic impact system is always 0. Answers to these questions

should lead to topological degree based conditions of grazing bifurcations of periodic solutions that do not rely on any genericity (and e.g. apply in the case of zero acceleration at grazing).

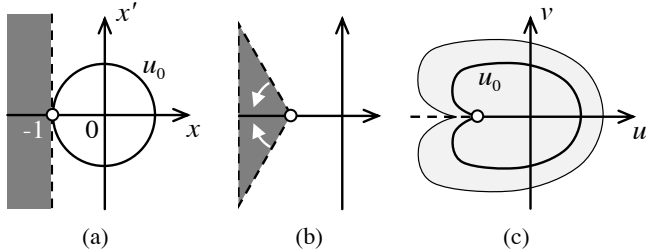

Figure 22: Statement of the problem about the topological degree of the Poincaré map \mathcal{P} over period 2π of (12). (a) Consider the cycle u_0 of the unperturbed system (12) that grazes the obstacle $c = -1$. (b) Introduce the change of variables and bend the phase space to finally identify the positive and negative parts of the obstacle $x = c$. (c) The Poincaré map \mathcal{P} is now continuous in the gray region, which is a small neighbourhood of the cycle u_0 transformed according to the change of variables introduced. The problem is about evaluating the topological degree of \mathcal{P} with respect to this gray region.

The work by Kamenski-Makarenkov-Nistri [194] initiates the development of perturbation theory in the settings where the only available knowledge about the perturbation is continuity. This problem falls into a different class of systems rather than piecewise smooth ones as the perturbation is allowed to be differentiable nowhere. The interest in considering nowhere smooth dynamical systems comes from applications in fluid dynamics, where Kolmogorov's conjecture [200] states that the order of the dependence of the velocity vector $v(x)$ of a wide class of fluids on the coordinate x does not exceed 1, so that the continuous map $x \mapsto v(x)$ cannot be differentiable anywhere. The solutions of the initial-value problems of relevant differential equations are nonunique and form so-called *integral funnels* (see E-Vanden-Eijden [362] and Pugh [302]). To cope with the problem of nonuniqueness the authors of [194] operate with integral operators and prove bifurcations of sets that are mapped into themselves under the action of these operators. Further discussion on the mathematical methods available for the Kolmogorov's fluid model can be found in the recent survey by Falkovich-Gawedzki-Vergassola [116].

4. Differential variational inequalities

Important classes of nonsmooth systems are not readily formulated as dynamical systems and mere existence, uniqueness and dependence of solutions on initial conditions represent one of the active directions of research within the nonsmooth community. One of the most general classes of these nonsmooth systems is that of differential variational inequalities, formulated as

$$\begin{aligned} \dot{x}(t) &= f(t, x(t), u(t)), \\ (\xi - u(t))^T F(t, x(t), u(t)) &\geq 0, \quad \text{for any } \xi \in K, \end{aligned} \quad (13)$$

where $f \in C^0(\mathbb{R}^n \times \mathbb{R}^m, \mathbb{R}^n)$, $F \in C^0(\mathbb{R}^n \times \mathbb{R}^m, \mathbb{R}^m)$ and $K \subset \mathbb{R}^m$ is a nonempty closed convex set. Where K is a cone,

the inequality in (13) is called a *complementarity condition*. Differential variational inequalities provide a convenient formalism for optimal control problems (see Pang-Stewart [287], Kwon-Friesz-Mookherjee-Yao-Feng [224]) and frictional contact problems (see Brogliato [57], Pang [286]). Various other formalisms (coming from control, mechanics and biology) and their relationship are discussed in the survey by Georgescu, Brogliato and Acary [141] in this special issue. The central framework to deal with (13) lies in transforming (13) (using so-called *convex analysis*) to differential inclusions where the properties of the solutions are well understood. The details of this transformation can be found in the aforementioned papers [286, 57] and the current state-of-the-art of the corresponding results on the existence of solutions (in sense of Caratheodory) for both initial-values and boundary-value problems for (13) has been developed in Pang-Stewart [287]. However, there are important situations where the differential inclusions approach doesn't offer the uniqueness of solutions and direct analysis of the DVIs is needed, see Stewart [334, 335]. We refer the reader to the book [336] by Stewart for further reading on differential variational inequalities and their applications.

Where the inequality in (13) models a mechanical contact one can approximately investigate the solutions of (13) by replacing one of the surfaces of the contact by an array of springs. This approach, called *regularization* in the mechanics literature, takes the differential variational inequality (13) to a system of ODEs. Several experiments suggest that the true dynamical behaviour is that of the regularized ODEs, that can deviate from the dynamics of the original differential variational inequality, see e.g. Hinrichs-Oestreich-Popp [164] and Liang-Feeny [237] (yet, other experiments show also that nonsmooth models compare very well with experiments). We refer the reader to the pioneering paper [364] by Vielsack and to the more recent development [331] by Stamm and Fidlin. A mathematical theory to study the dynamics of the regularised systems in the infinite-stiffness limit of the springs has been recently developed in Nordmark-Dankowicz-Champneys [272]. In addition, nonuniqueness of solutions of the initial-value problem for (13) is a common phenomenon in contact mechanics (called *static indeterminacy*, see e.g. [261]). The aforementioned paper [272] identifies the situations where the regularised ODEs resolve the ambiguity and where they do not. Sufficient conditions for robustness of regularisation of piecewise smooth ODEs are discussed in Fridman [130] and in the survey by Teixeira and da Silva [351] in this special issue. The paper [319] by Sieber and Kowalczyk suggests that the class of systems of piecewise smooth ODEs where this robustness takes place is rather limited. Regularisation of impact oscillators is discussed in Ivanov [182, 183]. Bastien and Schatzman [26] discuss the differential inclusions that occur in the limit of the regularisation processes for dry friction oscillators and analyse the size of integral funnels of these inclusions.

Another class of nonsmooth systems where the properties of the solutions arises as a major problem is the class of systems with hysteresis. In the most general form these systems can be

described as

$$\dot{u} = f(t, u, Pu) \quad \text{or} \quad \frac{d(Pu)}{dt} = f(t, u, Pu), \quad (14)$$

where P is a so-called *hysteresis operator*, see the pioneering work by Krasnoselski-Pokrovski [207]. A survey by Krejci-O’Kane-Pokrovskii-Rachinskii [208] in this special issue discusses the existence, uniqueness, dependence on initial conditions and other properties of solutions of systems with hysteresis of the aforementioned general form, focusing on the rightmost equation of (14).

5. Applications

In this section we discuss applications that have stimulated the development of mathematical methods for the analysis of nonsmooth systems. We focus on the mathematical problems around applications and highlight the place of these in the theory of nonsmooth systems, as just presented.

Border-collision of an equilibrium with a smooth switching manifold of discontinuous systems has been used in Leine-Brogliato-Nijmeijer [229] to explain fundamental paradoxes in mechanical devices with friction. The situation where the switching manifold is discontinuous has received much attention in the closed-loop control of car braking systems.

Car braking systems. Tanelli, Osorio, di Bernardo, Savaresi and Astolfi [347] use a two-dimensional switching system with four switching manifolds (that switch the actions of charging and discharging valves in the hydraulic actuator) to design closed-loop control strategies in anti-lock braking systems (ABS). The dynamics of this model exhibits a border-splitting bifurcation: if one first squeezes the parallel thresholds together and then observes how the dynamics responds to the increase of the gap between these thresholds. As for the dynamics of brakes this can be adequately described by a dry friction oscillator, i.e. a second-order differential equation involving a sign function. The time periods that stable regimes spend sticking to the switching manifold appear to be in direct relation to the break squeal level, see Badertscher-Cunefare-Ferri [20] and Ibrahim [177]. Studying grazing bifurcations in dry friction oscillators is a possible way to understand the properties of such sticking phases. This direction of research is explored in Zhang-Yang-Hu [387] and Luo-Thapa [244]. When the viscous friction is small, sticking phases can be investigated by a suitable perturbation approach as the paper by Hetzler-Schwarzer-Seemann [163] asserts. However, the recent survey Cantoni-Cesarini-Mastinu-Rocca-Sicigliano [73] suggests that more work is necessary to completely understand the connection of the brake squeal with sliding solutions of an appropriate mathematical model.

Periodic solutions with sliding phases also play a pivotal role in the Burridge-Knopoff mathematical model of earthquakes, see Xu-Knopoff [381], Mitsui-Hirahara [268], Ryabov-Ito [308], Galvanetto [135], Galvanetto-Bishop [136]. But grazing-sliding bifurcations of these solutions have not been yet addressed in the literature. Grazing-sliding bifurcations in a superconducting resonator are discussed in the paper by Jeffrey [190] in this special issue.

Atomic force microscopy. According to Hansma-Elings-Marti-Bracker [157] the AFM cantilever-sample interaction can be modelled by a piecewise linear continuous spring (see also Sebastian-Salapaka-Chen [315]). The switch from one linear stiffness characteristics to another happens at the moment when the cantilever enters into contact with the sample. As the cantilever is designed to oscillate (*cantilever tapping mode* that prevents damaging the sample), the free motions of the cantilever are separated from those touching the sample by a periodic solution that grazes the switching manifold. The corresponding grazing bifurcations turn out to be related to loss of image quality, as shown in the analysis of Misra-Dankowicz-Paul [267], Dankowicz-Zhao-Misra [101], and Van de Water-Molenaar [369]. Under certain typical circumstances and away from the grazing regimes the occurrence of subharmonic and chaotic solutions has been investigated using perturbation theory by Yagasaki [382, 383] and Ashhab-Salapaka-Dahleh-Mezic [4, 5].

Systems of oscillators with piecewise smooth springs and the related grazing bifurcations find applications in many other engineering systems, e.g. gear pairs (Mason-Piironen [259], Parker-Vijayakar-Imajo [289], Luo-O’Connor [246]) vibrating screens and crushers (Krukov [214], Wen [376]), vibro-impact absorbers and impact dampers (Ibrahim [178]), ships interacting with icebergs (see Ibrahim [151, 178]), offshore structures (see Thompson-Stewart [355]), suspension bridges (Glover-Lazer-McKenna [148], de Freitas-Viana-Grebogi [129]), and pressure relief valves (see the paper by Hos-Champneys [171] in this special issue⁵). Similar differential equations with nonsmooth continuous right-hand sides describe the so-called *Chua circuit*, for which border-collision and grazing bifurcations are discussed in Yu. Maistrenko-V. Maistrenko-Vikul-Chua [256] and Luo-Xue [245]. In biology, piecewise linear continuous terms appear in predator-prey models with limits on resources (see Loladze-Kuang-Elser [241]), whose nonsmooth phenomena are discussed in Li-Wang-Kuang [235].

Drilling. Mass-spring oscillators with piecewise linear stiffness characteristics play an important role in the modelling of drilling. Similar to AFM, the switch in the stiffness coefficient corresponds to the moment where the drill enters the sample. A difference with respect to the AFM model is that the position of the whole system moves over time due to a periodic (percussive) forcing from a periodically excited slider (reflecting the fact that the drill penetrates into the sample). Dry friction resists penetration of the drill into the sample. The model can be therefore seen as a combination of a dry friction oscillator with a soft impact one. Progressive motions with repeating sticking phases is the most useful regime of this setup. Analytic results about the properties of the sticking phases have been obtained in Besslink-van de Wouw-Nijmeijer [50],

⁵The flow rate through the valve in [171] is proportional to the square-root of the flow pressure. To have uniqueness of solutions the authors work under the natural assumption that the reservoir pressure is above the ambient pressure. The situation where these two pressures are equal is related to another nonsmooth problem known as the non-uniqueness of solutions in a leaking water container, see Driver [110].

Germa-van de Wouw-Nijmeijer-Sepulchre [142], and Cao-Wiercigroch-Pavlovskaja-Yang [74] by averaging methods under the assumption that the generating solution do not graze the switching manifolds. A numerical approach to the bifurcation analysis was followed in Luo-Lv [251]. In similarity to the modelling of drilling, Zimmermann-Zeidis-Bolotnik-Pivovarov [401] discuss how a two-module vibration-driven system moving along a rough horizontal plane describes the behaviour of biomimetic systems.

Neuron models. Predominantly unexplored challenges in nonsmooth bifurcation theory can be found in neuroscience applications, where the switching manifold sends any trajectory of integrate-and-fire or resonate-and-fire models to the same point of the phase space. Grazing bifurcation here corresponds to the transition from a sub-threshold to firing oscillations. This special volume contains a survey by Coombes-Thul-Wedgwood [94] of the new phenomena and open problems that stem from the presence of nonsmoothness in neuron models. New perturbation methods applicable near grazing solutions can be useful to reduce the dimension of networks of coupled neurons of integrate-and-fire or resonate-and-fire type. Such an approach has been employed in a series of recent papers by Holmes (see e.g. [363]) to investigate the dynamics of weakly coupled FitzHugh-Nagumo, Hindmarsh-Rose, Morris-Lecar and other smooth neuron models.

Hard ball gas. Rom-Kedar and Turaev [360, 306] have recently shown that grazing periodic trajectories of scattering billiards (two-degree-of-freedom Hamiltonian systems with impacts) can transform into an island of asymptotically stable periodic solutions under perturbations that regularise the nonsmooth impact into a smooth one. Though a higher-dimensional generalization of this observation is still an open problem, this result may potentially help to examine the boundaries of applicability of the Boltzman ergodic hypothesis (asserting that the hard ball gas is ergodic). These islands of stability have been later seen in experiments with an atom-optic system by Kaplan-Friedman-Andersen-Davidson [197]. A similar phenomenon known as absence of thermal equilibrium has been experimentally observed in one-dimensional Bose gases by Kinoshita-Wenger-Weiss [198].

Periodic orbits that graze the boundary of focusing billiards play an important role in the context of *Tethered Satellite Systems*, see Beletsky [33] and Beletsky-Pankova [34].

Electrochemical waves in the heart. Employing the mathematical modelling from Sun-Amellal-Glass-Billette [337], an unfolded border-collision bifurcation in a tent-like piecewise linear continuous map has been used to explain the transition from long to short periods (alternans) in electrochemical waves in the heart (linked to ventricular fibrillation and sudden cardiac death), see Zhao-Schaeffer [390], Berger-Zhao-Schaeffer-Dobrovolny-Krassowska-Gauthier [36], Hassounh-Abed [159, 160], and Chen-Wang-Chin [81]. However, only particular forms of perturbations have been analysed and the question of a complete unfolding of the dynamics of this map is explicitly posed in [390].

As a possible root to chaos in propagation of light in a circular *laser-diaphragm-prism system*, the border-collision bi-

furcation in a nonsmooth logistic map was discussed in the pioneering paper [165]. The book by Banerjee-Vergheze [23] and papers by Zhusubaliyev-Mosekilde [398, 399], and Zhusubaliyev-Soukhoterina-Mosekilde [400] discuss the role of border-collision bifurcations in tent-like maps in the context of power electronic circuits such as *boost converters* and *buck converters*. Collision of a fixed point with a border in more general piecewise smooth maps appears in the analysis of inverse problems (Ayon-Beato, Garcia, Mansilla, Terrero-Escalante [18]), forest fire competition model (Dercole-Maggi [106], Colombo-Dercole [91]), and mutualistic interactions (see Dercole [104]).

Incompressible fluids. The classical theory by Kolmogorov [200] asserts that the order of the dependence of the velocity vector $v(x)$ of incompressible fluids on the coordinate x does not exceed 1 at any point x of the phase space. The relevant differential equations are, therefore, not piecewise smooth and in fact nowhere differentiable. This implies non-uniqueness of the flow starting from any point of the phase space. Kolmogorov's fluid model challenges the development of bifurcation and perturbation theory to study transitions of the funnels of flows. Despite potential novel insights towards the understanding of the nature of turbulence, little has been developed in this direction and the approach commonly used so far is based on embedding (known as *stochastic approximation*) the given deterministic ODEs into a more general class of stochastic differential equations, see e.g. Falkovich-Gawedzki-Vergassola [116], and E-Vanden-Eijden [362].

Disk clutches. Static indeterminacy is the phenomenon caused by the presence of dry friction in mechanical devices, where the static equations of forces do not lead to a unique solution. This phenomenon represents one of the main motivating problems behind the field of *Nonsmooth Mechanics* (see Brogliato [57]). One of the methods to cope with the non-uniqueness of solutions is known as regularization [364], the development of which has recently been reinforced by applications to disk clutches by Stamm-Fidlin [331, 332]. This method is based on the approximation of rough surfaces by springs and leads to a singularly perturbed system where the so-called reduced system turns out to be degenerate. This concept is ideologically similar to smoothening (or softening) the given nonsmooth problem and challenges further development of the Fenichel's singular perturbation theory [379]. One of the problems in relation to the disk clutches is how well the regularised system approximates the moment of time (known as *cut-off*) when the initially motionless clutch's disk starts moving versus the parameters of the applied torque. A theory for a similar phenomenon in wave front propagation has been developed in a paper by Popovic [299] in this special issue. A regularization procedure has also been proposed in McNamara [261] to resolve the nonuniqueness problem in the context of granular material.

Wave propagation through the Earth. The need to gain a deeper understanding of the topological properties of grazing orbits (in particular, the topological index of grazing orbits) has been recently underlined by the problem of geophysical wave propagation. According to De Hoop-Hormann-Oberguggenberger [170], this process is modelled by hyper-

bolic PDEs with piecewise smooth coefficients (the switching manifold corresponds to the lowermost mantle layer). Attempts to apply Buffoni-Dancer-Toland global analytic bifurcation theory (see Dancer [95] and Buffoni-Toland [65]) proved to be effective for studying the existence of steady waves of the Euler equation (see Buffoni-Dancer-Toland [66]) and construct solutions of these partial differential equations, starting from convenient ordinary differential equations. The challenge of extending global analytic bifurcation theory to piecewise analytic differential equations is relevant in this context.

6. Discussion

This survey aims to sketch the central directions of research concerning the dynamics of nonsmooth systems. In this final section we briefly summarise our conclusions.

The need to develop new mathematical methods to study the dynamics of nonsmooth systems is motivated by real world applications. For example, existing smooth methods do not provide a mechanism for the understanding of how the switching manifolds generate cycles or chattering in control. In mechanics, new methods have been required to understand bifurcations initiated by oscillations that touch elastic limiters at zero speed (e.g. when a cantilever of an atomic force microscope or a drill starts to penetrate into a sample). A similar grazing problem appears in neuroscience when subthreshold oscillations transit into firing ones. In hydrodynamics, the Kolmogorov model of turbulence leads to differential equations that are non-Lipschitz everywhere (thus not piecewise smooth) and smooth methods cannot be applied because of the non-uniqueness of solutions. Finally, the mere existence, uniqueness and dependence of initial conditions is a challenge for nonsmooth systems coming from optimisation theory and nonsmooth mechanics.

For nonsmooth systems given in the form of differential equations with piecewise smooth right-hand sides and impacts (that cause trajectories to jump according to an impact law upon approaching a switching manifold) the new phenomena can be identified and understood by a local analysis of the consequences of the collision of a simple invariant object (like an equilibrium, a periodic solution or a torus) with switching manifolds. Here a collision for periodic solutions and tori is meant in a broader sense and stands for a non-transversal intersection with a switching manifold. Despite of useful applications of the recently discovered classifications of a border-collision bifurcation of an equilibrium in control (see e.g. [347]), the role of these phenomena in other applied sciences is in our view still largely underestimated. For example, it hasn't yet been explained which of the discovered scenarios of border-collision bifurcations can be realised in dry friction or impact mechanical oscillators. A significantly greater number of papers has been published on applications of the scenarios of grazing bifurcations of closed orbits (i.e. phenomena coming from collisions of closed orbits with the switching manifold). Yet, the role of this fundamental phenomenon remains unexplored in many important applied problems (e.g. in integrate-and-fire and resonate-and-fire neuron models and atom billiards). The available knowledge about bifurcations of trajectories with chat-

tering have not yet found common points with control where these trajectories correspond to so-called *Zenoness* (we refer the reader to Sussmann [343] and Zhang-Johansson-Lygeros-Sastry [386] for known alternative results).

The analysis of the collision of an invariant object with a switching manifold in piecewise smooth systems often leads to the study of the collision of a fixed point with a switching manifold in maps, otherwise known as border-collision in maps. Because of applications in medicine and electrical engineering (as discussed in Section 5) border-collision bifurcations in maps have received an independent interest in the literature. The two most fundamental maps of this type are tent and square-root ones. Some examples show that the dynamics of a skew product of two such maps is non-reducible to one dimension, but general results have not been obtained. Much less is known about nonsmooth systems that are not piecewise smooth. Partial results are available in the case a nowhere Lipschitz continuous system is smooth for some value of the parameter. These results suggest that studying bifurcations of trapping regions versus bifurcations of solutions is a potentially fruitful approach to access the dynamics.

As for more general nonsmooth systems like differential variational inequalities, a complete understanding of the dynamics has been achieved only in the case where this nonsmooth system is reducible to a convergent differential inclusion. Though the classes of differential variational inequalities that lead to piecewise smooth differential equations have been well identified in the literature, the piecewise smooth bifurcation and perturbation theories haven't been applied yet in this context. Also, the possibilities to relax the requirement for convergence of the aforementioned differential inclusions based on perturbation theory (which is partially developed for these systems already) have not yet been explored.

We hope this survey, and this special volume of *Physica D*, will facilitate the joining of efforts of researchers interested in different aspects of the dynamics of nonsmooth systems.

Acknowledgements

OM was partially supported by an EU-FP7 International Incoming Research Fellowship, RFBR grants 10-01-93112, 09-01-92429, 09-01-00468 and by the President of Russian Federation young researcher grant MK-1530.2010.1. OM and JSWL are grateful to the hospitality of IMECC UNICAMP, during visits in which part of this survey was written, with financial support of FAPESP, CAPES and EU-FP7 IRSES grant DynEur-Braz.

7. References

- [1] A. A. Andronov, A. A. Vitt, S. E. Khaikin, Theory of oscillators. Translated from the Russian by F. Immirzi; translation edited and abridged by W. Fishwick Pergamon Press, Oxford-New York-Toronto, Ont. 1966.
- [2] F. Angulo, M. di Bernardo, E. Fossas, G. Olivar, Feedback control of limit cycles: A switching control strategy based on nonsmooth bifurcation theory, IEEE Transactions on Circuits and Systems I-Regular Papers 52 (2005), no. 2, 366–378.

- [3] V. I. Arnold, Geometrical methods in the theory of ordinary differential equations. *Fundamental Principles of Mathematical Sciences*, 250. Springer-Verlag, New York, 1988.
- [4] M. Ashhab, M.V. Salapaka, M. Dahleh, I. Mezic, Dynamical analysis and control of microcantilevers, *Automatica* 35 (1999) 1663–1670.
- [5] M. Ashhab, M.V. Salapaka, M. Dahleh, I. Mezic, Melnikov-Based Dynamical Analysis of Microcantilevers in Scanning Probe Microscopy, *Nonlinear Dynamics* 20 (1999) 197–220.
- [6] V. Avrutin, P. S. Dutta, M. Schanz, S. Banerjee, Influence of a square-root singularity on the behaviour of piecewise smooth maps, *Nonlinearity* 23 (2010) 445–463.
- [7] V. Avrutin, M. Schanz, L. Gardini, On a special type of border-collision bifurcations occurring at infinity, *Physica D* 239 (2010), no. 13, 1083–1094.
- [8] V. Avrutin, A. Granados, M. Schanz, Sufficient conditions for a period incrementing big bang bifurcation in one-dimensional maps, *Nonlinearity* 24 (2011), no. 9, 2575–2598.
- [9] V. Avrutin, E. Fossas, A. Granados, Virtual orbits and two-parameter bifurcation analysis in a ZAD-controlled buck converter. *Nonlinear Dynam.* 63 (2011), no. 1–2, 19–33.
- [10] V. Avrutin, M. Schanz, L. Gardini, Calculation of bifurcation curves by map replacement, *Internat. J. Bifur. Chaos Appl. Sci. Engrg.* 20 (2010), no. 10, 3105–3135.
- [11] V. Avrutin, M. Schanz, L. Gardini, On a special type of border-collision bifurcations occurring at infinity *Physica D* 239 (2010), no. 13, 1083–1094.
- [12] V. Avrutin, P. S. Dutta, M. Schanz, S. Banerjee, Influence of a square-root singularity on the behaviour of piecewise smooth maps, *Nonlinearity* 23 (2010), no. 2, 445–463.
- [13] V. Avrutin, B. Eckstein, M. Schanz, The bandcount increment scenario. I. Basic structures. *Proc. R. Soc. Lond. Ser. A Math. Phys. Eng. Sci.* 464 (2008), no. 2095, 1867–1883.
- [14] V. Avrutin, M. Schanz, On the fully developed bandcount adding scenario, *Nonlinearity* 21 (2008), no. 5, 1077–1103.
- [15] V. Avrutin, M. Schanz, S. Banerjee, Multi-parametric bifurcations in a piecewise-linear discontinuous map, *Nonlinearity* 19 (2006), no. 8, 1875–1906.
- [16] V. Avrutin, M. Schanz, On multi-parametric bifurcations in a scalar piecewise-linear map, *Nonlinearity* 19 (2006), no. 3, 531–552.
- [17] J. Awrejcewicz, Jan; Lamarque, Claude-Henri *Bifurcation and chaos in nonsmooth mechanical systems*. World Scientific Series on Nonlinear Science. Series A: Monographs and Treatises, 45. World Scientific Publishing Co., Inc., River Edge, NJ, 2003. xviii+543 pp.
- [18] E. Ayon-Beato, A. Garcia, R. Mansilla, C. A. Terrero-Escalante, Stewart-Lyth inverse problem, *Physical Review D* 62 (2000) 103513-1–9.
- [19] V. I. Babitsky, *Theory of vibro-impact systems and applications*. Foundations of Engineering Mechanics. Springer-Verlag, Berlin, 1998.
- [20] J. Badertscher K. A. Cunefare, A. A. Ferri, Braking impact of normal dither signals, *Journal of Vibration and Acoustics*, 129 (2007), issue 1, 17–23.
- [21] S. Banerjee, J. Ing, E. Pavlovskaja, M. Wiercigroch, R. K. Reddy, Invisible grazings and dangerous bifurcations in impacting systems: The problem of narrow-band chaos, *Physical Review E* 79 (2009), no. 3, 037201.
- [22] S. Banerjee, P. Ranjan, C. Grebogi, Bifurcations in two-dimensional piecewise smooth maps - Theory and applications in switching circuits, *IEEE Transactions on Circuits and Systems I-Regular papers* 47 (2000), no. 5, 633–643.
- [23] S. Banerjee, G. Verghese (2001) *Nonlinear Phenomena in Power Electronics: Bifurcations, Chaos, Control, and Applications*, Wiley-IEEE Press.
- [24] S. Banerjee, C. Grebogi, Border collision bifurcations in two-dimensional piecewise smooth maps, *Physical Review E* 59 (1999), no. 4, 4052–4061.
- [25] E. A. Barbashin, *Introduction to the theory of stability*. Translated from the Russian by Transcripta Service, London. Edited by T. Lukes Wolters-Noordhoff Publishing, Groningen 1970 223 pp.
- [26] J. Bastien, M. Schatzman, Indeterminacy of a dry friction problem with viscous damping involving stiction, *ZAMM* 88 (2008), no. 4, 243–255.
- [27] F. Battelli, M. Feckan, Bifurcation and chaos near sliding homoclinics, *J. Differential Equations* 248 (2010), no. 9, 2227–2262.
- [28] F. Battelli, M. Feckan, Homoclinic trajectories in discontinuous systems, *J. Dynam. Differential Equations* 20 (2008), no. 2, 337–376.
- [29] F. Battelli, M. Feckan, Nonsmooth homoclinic orbits, Melnikov functions and chaos in discontinuous systems, *Physica D* ?? (????) ???-???
- (special issue "Dynamics and bifurcations of nonsmooth systems" of *Physica D*).
- [30] F. Battelli, M. Feckan, On the Chaotic Behaviour of Discontinuous Systems, *J Dyn Diff Equat* 23 (2011), no. 3, 495–540.
- [31] F. Battelli, M. Feckan Homoclinic trajectories in discontinuous systems, *J. Dynam. Differential Equations* 20 (2008), no. 2, 337–376.
- [32] N. N. Bautin, A dynamic model of a watch movement without a characteristic period, *Akad. Nauk SSSR. Inzeneryi Sbornik* 16, (1953). 3–12.
- [33] V. V. Beletsky, *Regular and chaotic motion of rigid bodies*, Teubner Mechanics Textbooks, B. G. Teubner, Stuttgart, 1995. iv+148 pp. (in German)
- [34] V. V. Beletsky, D. V. Pankova, Connected bodies in the orbit as dynamic billiard, *Regul. Khaoticheskaya Din.* 1 (1996), no. 1, 87–103.
- [35] D. Benmerzouk, J. P. Barbot, *Nonlinear Analysis: Hybrid Systems 4* (2010) 503–512.
- [36] C. M. Berger, X. Zhao, D. G. Schaeffer, H. M. Dobrovolny, W. Krasowska, D. J. Gauthier, Period-Doubling Bifurcation to Alternans in Paced Cardiac Tissue: Crossover from Smooth to Border-Collision Characteristics, *Physical Review Letters* 99 (2007) 058101-1–4.
- [37] M. di Bernardo, C. J. Budd, A. R. Champneys, P. Kowalczyk, A. B. Nordmark, G. Olivar, P. T. Piironen, Bifurcations in nonsmooth dynamical systems. *SIAM Rev.* 50 (2008), no. 4, 629–701.
- [38] M. di Bernardo, D. J. Pagano, E. Ponce, Nonhyperbolic boundary equilibrium bifurcations in planar Filippov systems: a case study approach, *Internat. J. Bifur. Chaos Appl. Sci. Engrg.* 18 (2008), no. 5, 1377–1392.
- [39] M. di Bernardo, P. Kowalczyk, A. Nordmark, Bifurcations of dynamical systems with sliding: derivation of normal-form mappings, *Phys. D* 170 (2002), no. 3–4, 175–205.
- [40] M. di Bernardo, C. J. Budd, A. R. Champneys, Corner collision implies border-collision bifurcation, *Phys. D* 154 (2001), no. 3–4, 171–194.
- [41] M. di Bernardo, C. J. Budd, A. R. Champneys, Grazing and border-collision in piecewise-smooth systems: A unified analytical framework, *Physical Review Letters* 86 (2001), no. 12, 2553–2556.
- [42] M. di Bernardo, C. Budd, A. Champneys, Grazing, skipping and sliding: analysis of the non-smooth dynamics of the DC/DC buck converter, *Nonlinearity* 11 (1998), no. 4, 859–890.
- [43] M. di Bernardo, P. Kowalczyk, A. Nordmark, Sliding bifurcations: a novel mechanism for the sudden onset of chaos in dry friction oscillators, *International Journal of Bifurcation and Chaos in Applied Sciences and Engineering* 13 (2003), no. 10, 2935–2948.
- [44] M. di Bernardo, A. Champneys, M. Homer, Non-smooth dynamical systems, theory and applications - Preface, *Dynamical Systems* 17 (2002), no. 4, 297–297.
- [45] M. di Bernardo, S. J. Hogan, Discontinuity-induced bifurcations of piecewise-smooth and impacting dynamical systems, *Philosophical Transactions of the Royal Society A: Mathematical, Physical and Engineering Sciences* 368 (2010), no. 1930, 4915–4935.
- [46] M. di Bernardo, C. J. Budd, A. R. Champneys, Normal form maps for grazing bifurcations in n-dimensional piecewise-smooth dynamical systems, *Physica D* 160 (2001) 222–254.
- [47] M. di Bernardo, A. Nordmark, & G. Olivar, 2008c Discontinuity-induced bifurcations of equilibria in piecewise-smooth dynamical systems. *Physica D* 237, 119–136.
- [48] M. di Bernardo, M. I. Feigin, S. J. Hogan, and M. E. Homer (1999) *Local Analysis of C-bifurcations in n-dimensional piecewise smooth dynamical systems*. *Chaos, Solitons and Fractals*, 10:1881-1908.
- [49] M. di Bernardo, C. J. Budd, A. R. Champneys, P. Kowalczyk, *Piecewise-smooth dynamical systems. Theory and applications*. Applied Mathematical Sciences, 163. Springer-Verlag London, Ltd., London, 2008.
- [50] B. Besselink, N. van de Wouw, H. Nijmeijer, A Semi-Analytical Study of Stick-Slip Oscillations in Drilling Systems, *Journal of Computational and Nonlinear Dynamics* 6 (2011), no. 2, 021006-1–9.
- [51] J. J. B. Biemond, N. van de Wouw, H. Nijmeijer, Bifurcations of equilibrium sets in mechanical systems with dry friction, *Physica D* ?? (????) ???-???
- (special issue "Dynamics and bifurcations of nonsmooth systems" of *Physica D*).

- [52] B. Blazejczyk-Okolewska, K. Czolczynski, T. Kapitaniak, Dynamics of a two-degree-of-freedom cantilever beam with impacts, *Chaos Solitons Fractals* 40 (2009), no. 4, 1991–2006.
- [53] B. Blazejczyk-Okolewska, K. Czolczynski, T. Kapitaniak, Classification principles of types of mechanical systems with impacts - fundamental assumptions and rules, *European Journal of Mechanics A-Solids* 23 (2004), no. 3, 517–537.
- [54] B. Blazejczyk-Okolewska, T. Kapitaniak, Dynamics of impact oscillator with dry friction, *Chaos Solitons Fractals* 7 (1996), no. 9, 1455–1459.
- [55] N. N. Bogolyubov, *On Some Statistical Methods in Mathematical Physics, 1945, Akademiya Nauk Ukrainskoi SSR. (Russian)*.
- [56] S. Brianzoni, E. Michetti, I. Sushko, Border collision bifurcations of superstable cycles in a one-dimensional piecewise smooth map, *Mathematics and Computers in Simulation* 81 (2010), no. 1, 52–61.
- [57] B. Brogliato, *Nonsmooth Mechanics*, Springer, New York, Heidelberg, Berlin, 1999.
- [58] M. Brokate, A. Pokrovskii, D. Rachinskii and O. Rasskazov, Differential equations with hysteresis via a canonical example. In: I. Mayergoyz and G. Bertotti, Editors, *The Science of Hysteresis*, Academic Press, New York (2003), pp. 125–292.
- [59] M. Broucke, C. Pugh, S. Simić, Structural stability of piecewise smooth systems, *Comput. Appl. Math.* 20 (2001), no. 1-2, 51–89.
- [60] C. J. Budd, P. T. Piiroinen, Corner bifurcations in non-smoothly forced impact oscillators, *Phys. D* 220 (2006), no. 2, 127–145.
- [61] C. J. Budd, A. G. Lee, Double impact orbits of periodically forced impact oscillators, *Proc. R. Soc. Lond. A* 452(1996), 2719–2750
- [62] C. Budd, F. Dux, Intermittency in impact oscillators close to resonance, *Nonlinearity* 7 (1994), no. 4, 1191–1224.
- [63] C. J. Budd, F. J. Dux, Chattering and related behaviour in impact oscillators, *Phil. Trans. R. Soc. Lond. A* 347 (1994) 365–389.
- [64] C. J. Budd, P. T. Piiroinen, Corner bifurcations in non-smoothly forced impact oscillators, *Physica D* 220 (2006) 127–145.
- [65] B. Buffoni, J. Toland, *Analytic theory of global bifurcation. An introduction. Princeton Series in Applied Mathematics*. Princeton University Press, Princeton, NJ, 2003.
- [66] B. Buffoni, N. Dancer, J. Toland, The regularity and local bifurcation of steady periodic water waves. *Arch. Rat. Mech. Anal.* 152 (2000) 207–240.
- [67] A. Buica, J. Llibre, O. Makarenkov, Bifurcations from nondegenerate families of periodic solutions in Lipschitz systems, *Journal of Differential Equations* 252 (2012), no. 6, 3899–3919.
- [68] A. Buica, J. Llibre, O. Makarenkov, Asymptotic stability of periodic solutions for nonsmooth differential equations with application to the nonsmooth van der Pol oscillator. *SIAM J. Math. Anal.* 40 (2009), no. 6, 2478–2495.
- [69] A. Buika, Zh. Libre, O. Yu. Makarenkov, On Yu. A. Mitropol'skii's theorem on periodic solutions of systems of nonlinear differential equations with nondifferentiable right-hand sides. (Russian) *Dokl. Akad. Nauk* 421 (2008), no. 3, 302–304; translation in *Dokl. Math.* 78 (2008), no. 1, 525–527.
- [70] V. Sh. Burd, Resonance vibration of impact oscillator with biharmonic excitation, *Physica D* ?? (???) ??-??? (special issue "Dynamics and bifurcations of nonsmooth systems" of Physica D).
- [71] V. Burd, *Method of Averaging for Differential Equations on an Infinite Interval: Theory and Applications*, Lecture Notes in Pure and Applied Mathematics 255, Chapman & Hall/CRC, 2007.
- [72] V. Sh. Burd, V. L. Krupenin, On the calculation of resonance oscillations of the vibro-impact systems by the averaging technique, *Dynamics of Vibro-Impact Systems, Proceedings of the Euromech Colloquium 15–18 September 1998*, Springer, 1999, 127–135.
- [73] C. Cantonia, R. Cesarini, G. Mastinu, G. Rocca, R. Sicigliano, Brake comfort – a review, *Vehicle System Dynamics* 47 (2009), no. 8, 901–947.
- [74] Q.-J. Cao, M. Wiercigroch, E. Pavlovskaja, S.-P. Yang, Bifurcations and the penetrating rate analysis of a model for percussive drilling, *Acta Mech Sin* 26 (2010) 467–475.
- [75] A. Capietto, J. Mawhin, F. Zanolin, Continuation theorems for periodic perturbations of autonomous systems. *Trans. Amer. Math. Soc.* 329 (1992), no. 1, 41–72.
- [76] F. Casas, C. Grebogi, Control of chaotic impacts, *Int J Bifurcat Chaos* 7 (1997), no. 4, 951–955.
- [77] V. Ceanga V, Y. Hurmuzlu, A new look at an old problem: Newton's cradle, *Journal of Applied Mechanics – Transactions of the ASME* 68 (2001), no. 4, 575–583.
- [78] F. Casas, W. Chin, C. Grebogi, E. Ott, Universal grazing bifurcations in impact oscillators, *Physical review E* 50 (1996), no. 1, 134–139.
- [79] P. Casini, O. Giannini, F. Vestroni, Persistent and Ghost Nonlinear Normal Modes in the forced response of non-smooth systems, *Physica D* ?? (???) ??-??? (special issue "Dynamics and bifurcations of nonsmooth systems" of Physica D).
- [80] S. P. Chard, M. J. Damzen, Compact architecture for power scaling bounce geometry lasers, *Optics Express* 17 (2009), no. 4, 2218–2223.
- [81] D. Chen, H. O. Wang, W. Chin, Suppressing cardiac alternans: Analysis and control of a border-collision bifurcation in a cardiac conduction model, *Proceedings - IEEE International Symposium on Circuits and Systems* 3 (1998) 635–638.
- [82] D. Chillingworth, A. Nordmark, P. T. Piiroinen, Global analysis of impacting systems, in preparation.
- [83] D. R. J. Chillingworth, A. B. Nordmark, Periodic orbits close to grazing for an impact oscillator, to appear in A. Johann, H.-P. Kruse, F. Rupp and S. Schmitz (eds.), *Recent Trends in Dynamical Systems: Proceedings of a Conference in Honor of Jurgen Scheurle*, Springer Proceedings in Mathematics.
- [84] D. R. J. Chillingworth, The Teixeira singularity or: Stability and Bifurcation for a discontinuous vector field in \mathbb{R}^3 at a double-fold point: DRAFT, unpublished.
- [85] D. R. J. Chillingworth, Discontinuity geometry for an impact oscillator. Special issue: Non-smooth dynamical systems, theory and applications. *Dyn. Syst.* 17 (2002), no. 4, 389–420.
- [86] D. R. J. Chillingworth, Dynamics of an impact oscillator near a degenerate graze, *Nonlinearity* 23 (2010), no. 11, 2723–2748.
- [87] W. Chin, E. Ott, H. E. Nusse, C. Grebogi, Universal behavior of impact oscillators near grazing incidence, *Phys. Lett. A* 201 (1995), no. 2-3, 197–204.
- [88] W. Chin, E. Ott, H. E. Nusse, C. Grebogi, Grazing bifurcations in impact oscillators, *Physical Review E* 50 (1994), no. 6, 4427–4444.
- [89] A. Colombo, M. di Bernardo, S. J. Hogan, M. R. Jeffrey, Bifurcations of piecewise smooth flows: perspectives, methodologies and open problems, *Physica D* ?? (???) ??-??? (special issue "Dynamics and bifurcations of nonsmooth systems" of Physica D).
- [90] A. Colombo, M. di Bernardo, E. Fossas, M. R. Jeffrey, Teixeira singularities in 3D switched feedback control systems. *Systems & Control Letters* 59 (2009), no. 10, 615–622.
- [91] A. Colombo, F. Dercole, Discontinuity induced bifurcations of non-hyperbolic cycles in nonsmooth systems, *SIAM J. Appl. Dyn. Syst.* 9 (2010), no. 1, 62–83.
- [92] A. Colombo, M. R. Jeffrey, Non-deterministic chaos, and the two-fold singularity of piecewise smooth flows, *SIAM Journal on Applied Dynamical Systems* 10 (2011) 423–451.
- [93] K. M. Cone, R. I. Zadoks, A numerical study of an impact oscillator with the addition of dry friction, *Journal of Sound and Vibration* 188 (1995), no. 5, 659–683.
- [94] S. Coombes, R. Thul, K. C. A. Wedgwood, Nonsmooth dynamics in spiking neuron models, *Physica D* ?? (???) ??-??? (special issue "Dynamics and bifurcations of nonsmooth systems" of Physica D).
- [95] N. Dancer, Bifurcation theory for analytic operators. *Proc. Lond. Math. Soc.* 26 (1973) 359–384.
- [96] H. Dankowicz, F. Svahn, On the stabilizability of near-grazing dynamics in impact oscillators, *Internat. J. Robust Nonlinear Control* 17 (2007), no. 15, 1405–1429.
- [97] H. Dankowicz, A. B. Nordmark, On the origin and bifurcations of stick-slip oscillations, *Physica D* 136 (2000), no. 3-4, 280–302.
- [98] H. Dankowicz, M. Katzenbach, Discontinuity-induced bifurcations in models of mechanical contact, capillary adhesion, and cell division: a common framework, *Physica D* ?? (???) ??-??? (special issue "Dynamics and bifurcations of nonsmooth systems" of Physica D).
- [99] H. Dankowicz, M. R. Paul, Discontinuity-Induced Bifurcations in Systems With Hysteretic Force Interactions, *J. Comput. Nonlinear Dynam.* 4 (2009), no. 4, 041009-1–6.
- [100] H. Dankowicz, J. Jerrelind, Control of near-grazing dynamics in impact oscillators, *Proceedings of the Royal Society A: Mathematical, Physical and Engineering Sciences* 461 (2005), no. 2063, 3365–3380.

- [101] H. Dankowicz, X. Zhao, S. Misra, Near-Grazing dynamics in tapping mode atomic-force microscopy, *International Journal of Non-Linear Mechanics* 42 (2007) 697-709.
- [102] R. B. Davis, L. N. Virgin, Non-linear behavior in a discretely forced oscillator, *International Journal of Non-Linear Mechanics* 42 (2007) 744-753.
- [103] S. De, P. S. Dutta, S. Banerjee, A. R. Roy, Local and Global Bifurcations in Three-Dimensional, Continuous, Piecewise Smooth Maps, *International Journal of Bifurcation and Chaos* 21 (2011), no. 6, 1617-1636
- [104] F. Dercole, Border collision bifurcations in the evolution of mutualistic interactions, *Internat. J. Bifur. Chaos Appl. Sci. Engrg.* 15 (2005), no. 7, 2179-2190.
- [105] F. Dercole, A. Gagnani, Yu. A. Kuznetsov, S. Rinaldi, Numerical sliding bifurcation analysis: An application to a relay control system, *IEEE Transactions on Circuits and Systems I: Fundamental Theory and Applications* 50 (2003), no. 8, 1058-1063.
- [106] F. Dercole, S. Maggi, Detection and continuation of a border collision bifurcation in a forest fire model, *Appl. Math. Comput.* 168 (2005), no. 1, 623-635.
- [107] Y. Do, H. K. Baek, Dangerous border-collision bifurcations of a piecewise-smooth map, *Communications on Pure and Applied Analysis* 5 (2006), no. 3, 493-503.
- [108] Z. Du, W. Zhang: Melnikov method for homoclinic bifurcation in nonlinear impact oscillators, *Computers and Mathematics with Applications* 50 (2005), 445-458.
- [109] Z. Du, Y. Li, W. Zhang, Bifurcation of periodic orbits in a class of planar Filippov systems, *Nonlinear Analysis* 69 (2008) 3610-3628.
- [110] R. D. Driver, Torricelli's law - an ideal example of an elementary ODE. *Amer. Math. Monthly* 105 (1998), no. 5, 453-455.
- [111] C. Duan, R. Singh, Dynamic analysis of preload nonlinearity in a mechanical oscillator, *Journal of Sound and Vibration* 301 (2007) 963-978.
- [112] P. S. Dutta, S. Dea, S. Banerjee, A. R. Roy, Torus destruction via global bifurcations in a piecewise-smooth, continuous map with square-root nonlinearity, *Physics Letters A* 373 (2009) 4426-4433.
- [113] P. S. Dutta, S. Banerjee, Period increment cascades in a discontinuous map with square-root singularity, *Discrete Contin. Dyn. Syst. Ser. B* 14 (2010), no. 3, 961-976.
- [114] P. S. Dutta, B. Routroy, S. Banerjee, S. S. Alam, On the existence of low-period orbits in n -dimensional piecewise linear discontinuous maps, *Nonlinear Dynam.* 53 (2008), no. 4, 369-380.
- [115] Z. Elhadj, A new chaotic attractor from 2D discrete mapping via border-collision period-doubling scenario, *Discrete Dynamics in Nature and Society* 2005 (2005), no. 3, 235-238.
- [116] G. Falkovich, K. Gawedzki, M. Vergassola, Particles and fields in fluid turbulence, *Reviews of Modern Physics* 73 (2001) 913-975.
- [117] M. Feckan, Differential inclusions at resonance, *Bull. Belg. Math. Soc. Simon Stevin* 5 (1998), no. 4, 483-495.
- [118] M. Feckan, Bifurcation from homoclinic to periodic solutions in ordinary differential equations with multivalued perturbations, *J. Differential Equations* 130 (1996), no. 2, 415-450.
- [119] M. Feckan, Bifurcation of periodic solutions in differential inclusions. *Appl. Math.* 42 (1997), no. 5, 369-393.
- [120] M. Feckan, Topological degree approach to bifurcation problems, *Topological Fixed Point Theory and Its Applications*, 5. Springer, New York, 2008.
- [121] M. I. Feigin, Forced oscillations in systems with discontinuous nonlinearities, *Fizmatlit, "Nauka", Moscow*, 1994. 288 pp. (in Russian)
- [122] A. Fidlin, *Nonlinear Oscillations in Mechanical Engineering*, Springer, Berlin, Heidelberg, 2005.
- [123] A. Fidlin, Oscillator in a Clearance: Asymptotic Approaches and Nonlinear Effects, *ASME 2005 International Design Engineering Technical Conferences and Computers and Information in Engineering Conference (IDETC/CIE2005)*, Proceedings of the ASME International Design Engineering Technical Conferences and Computers and Information in Engineering Conference, Parts A-C, vol. 6 (2005) 1949-1957.
- [124] A. Fidlin, On the asymptotic analysis of discontinuous systems, *ZAMM Z. Angew. Math. Mech.* 82 (2002), no. 2, 75-88.
- [125] A. F. Filippov, *Differential equations with discontinuous righthand sides. Translated from the Russian. Mathematics and its Applications (Soviet Series)*, 18. Kluwer Academic Publishers Group, Dordrecht, 1988. x+304 pp.
- [126] D. Fournier-Prunaret, P. Chargé, L. Gardini, Border collision bifurcations and chaotic sets in a two-dimensional piecewise linear map, *Commun. Nonlinear Sci. Numer. Simul.* 16 (2011), no. 2, 916-927.
- [127] M. H. Fredriksson, A. B. Nordmark, On normal form calculations in impact oscillators, *R. Soc. Lond. Proc. Ser. A Math. Phys. Eng. Sci.* 456 (2000), no. 1994, 315-329.
- [128] M. Fredriksson, A. Nordmark, Bifurcations caused by grazing incidence in many degrees of freedom impact oscillators, *Proc. Roy. Soc. London Ser. A* 453 (1997), no. 1961, 1261-1276.
- [129] M. S. T. de Freitas, R. L. Viana, C. Grebogi, Multistability, basin boundary structure, and chaotic behavior in a suspension bridge model, *Internat. J. Bifur. Chaos Appl. Sci. Engrg.* 14 (2004), no. 3, 927-950.
- [130] L. M. Fridman, Slow periodic motions with internal sliding modes in variable structure systems, *Internat. J. Control* 75 (2002), no. 7, 524-537.
- [131] U. Galvanetto, An example of a non-smooth fold bifurcation, *Meccanica* 36 (2001), no. 2, 229-233.
- [132] U. Galvanetto, Sliding bifurcations in the dynamics of mechanical systems with dry friction - Remarks for engineers and applied scientists, *Journal of Sound and Vibration* 276 (2004), no. 1-2, 121-139.
- [133] U. Galvanetto, Some discontinuous bifurcations in a two-block stick-slip system, *Journal of Sound and Vibration* 248 (2001), no. 4, 653-659.
- [134] U. Galvanetto, Discontinuous bifurcations in stick-slip mechanical systems, *Proceedings of the ASME Design Engineering Technical Conference* 6 (2001) 1315-1322.
- [135] U. Galvanetto, Some remarks on the two-block symmetric Burridge-Knopoff model, *Physics Letters A* 293 (2002), no. 5-6, 251-259.
- [136] U. Galvanetto, S. R. Bishop, Stick-slip vibrations of a two degree-of-freedom geophysical fault model, *International Journal of Mechanical Sciences* 36 (1994), no. 8, 683-698.
- [137] A. Ganguli, S. Banerjee, Dangerous bifurcation at border collision: When does it occur?, *Physical Review E* 71 (2005), no. 5, 057202.
- [138] L. Gardini, F. Tramontana, Border collision bifurcation curves and their classification in a family of 1D discontinuous maps, *Chaos Solitons Fractals* 44 (2011), no. 4-5, 248-259.
- [139] L. Gardini, F. Tramontana, I. Sushko, Border collision bifurcations in one-dimensional linear-hyperbolic maps, *Math. Comput. Simulation* 81 (2010), no. 4, 899-914.
- [140] L. Gardini, F. Tramontana, Snap-back Repellers in Non-smooth Functions, *Regular and Chaotic Dynamics* 15 (2010), no. 2-3, 237-245.
- [141] C. Georgescu, B. Brogliato, V. Acary, Switching, relay and complementarity systems: a tutorial on their well-posedness and relationships, *Physica D ?? (????) ???-???* (special issue "Dynamics and bifurcations of nonsmooth systems" of *Physica D*).
- [142] C. Gernay, N. Van de Wouw, H. Nijmeijer, R. Sepulchre, *Nonlinear Drillstring Dynamics Analysis*, *SIAM J. Applied Dynamical Systems* 8 (2009), no. 2, 572-553.
- [143] P. Glendinning, C. H. Wong, Border collision bifurcations, snap-back repellers, and chaos, *Phys. Rev. E* 79 (2009) 025202.
- [144] P. Glendinning, C. H. Wong, Two-dimensional attractors in the border-collision normal form. *Nonlinearity* 24 (2011), no. 4, 995-1010.
- [145] P. Glendinning, Bifurcations of Snap-back Repellers with application to Border-Collision Bifurcations, *International Journal of Bifurcation and Chaos* 20 (2010), no. 2, 479-489.
- [146] P. Glendinning, *Stability, Instability and Chaos: An Introduction to the Theory of Nonlinear Differential Equations*, Cambridge University Press, New York, 1999.
- [147] Ch. Glocker, U. Aeberhard, *The Geometry of Newtons Cradle*, In: *Non-smooth Mechanics and Analysis: Theoretical and Numerical Advances*. AMMA 12 (eds. Alart P., Maisonneuve O., Rockafellar R.T.) 185-194, Springer, 2006.
- [148] J. Glover, A. C. Lazer, P. J. McKenna, Existence and stability of large scale nonlinear oscillations in suspension bridges, *Z. Angew. Math. Phys.* 40 (1989), no. 2, 172-200.
- [149] I. V. Gorelyshev, A. I. Neishtadt, On the adiabatic theory of perturbations for systems with elastic reflections. (Russian) *Prikl. Mat. Mekh.* 70 (2006), no. 1, 6-19; translation in *J. Appl. Math. Mech.* 70 (2006), no. 1, 4-7.
- [150] I. V. Gorelyshev, A. I. Neishtadt, Jump in adiabatic invariant at a transition between modes of motion for systems with impacts. *Nonlinearity* 21 (2008), no. 4, 661-676.

- [151] I. F. Grace, R. A. Ibrahim, Modelling and analysis of ship roll oscillations interacting with stationary icebergs, *Proceedings of the Institution of Mechanical Engineers, Part C: Journal of Mechanical Engineering Science* 222 (2008), no. 10, 1873–1884.
- [152] A. Granados, S. J. Hogan, T. M. Seara, The Melnikov method and subharmonic orbits in a piecewise smooth system, *SIAM J. Applied Dynamical Systems*, to appear.
- [153] J. Guckenheimer, P. Holmes, *Nonlinear oscillations, dynamical systems, and bifurcations of vector fields*. Applied Mathematical Sciences, 42. Springer-Verlag, New York, 1990.
- [154] M. Guardia, T. M. Seara, M. A. Teixeira, Generic bifurcations of low codimension of planar Filippov systems. *J. Differential Equations* 250 (2011), no. 4, 1967–2023.
- [155] M. Guardia, S. J. Hogan, T. M. Seara, An analytical approach to codimension-2 sliding bifurcations in the dry-friction oscillator, *SIAM Journal on Applied Dynamical Systems* 9 (2010), no. 3, 769–798.
- [156] C. Halse, M. Homer, M. di Bernardo, C-bifurcations and period-adding in one-dimensional piecewise-smooth maps, *Chaos Solitons Fractals* 18 (2003), no. 5, 953–976.
- [157] P. Hansma, V. Elings, O. Marti, C. Bracker, Scanning tunneling microscopy and atomic force microscopy: application to biology and technology. *Science* 242, (1988), 209–216.
- [158] D. Hartog, Forced vibrations with combined Coulomb and viscous friction, *American Society of Mechanical Engineers – Advance Papers* (1931), 9p.
- [159] M. A. Hassouneh, E. H. Abed, Feedback control of border collision bifurcations. New trends in nonlinear dynamics and control, and their applications, 49–64, *Lecture Notes in Control and Inform. Sci.*, 295, Springer, Berlin, 2003.
- [160] M. A. Hassouneh, E. H. Abed, Border collision bifurcation control of cardiac alternans. *Internat. J. Bifur. Chaos Appl. Sci. Engrg.* 14 (2004), no. 9, 3303–3315.
- [161] M. A. Hassouneh, E. H. Abed, H. E. Nusse, Robust dangerous border-collision bifurcations in piecewise smooth systems, *Physical review letters* 92 (2004), no. 7, 070201.
- [162] Q. He, S. Feng, J. Zhang, Study on Main Resonance Bifurcations and Grazing Bifurcations of SDOF Bilinear System, 2nd IEEE International conference on advanced computer control (ICACC 2010) 4 (2010) 75–78.
- [163] H. Hetzler, D. Schwarzer, W. Seemann, Analytical investigation of steady-state stability and Hopf-bifurcations occurring in sliding friction oscillators with application to low-frequency disc brake noise, *Communications in Nonlinear Science and Numerical Simulation* 12 (2007) 83–99.
- [164] N. Hinrichs, M. Oestreich, K. Popp, On the modelling of friction oscillators, *Journal of Sound and Vibration* 216 (1998), no. 24, 435–459.
- [165] A. A. Hnilo, Chaotic (as the logistic map) laser cavity, *Optics Communications* 53 (1985), no. 3, 194–196.
- [166] S. J. Hogan, L. Higham, T. C. L. Griffin, Dynamics of a piecewise linear map with a gap, *Proc. R. Soc. Lond. Ser. A Math. Phys. Eng. Sci.* 463 (2007), no. 2077, 49–65.
- [167] S. J. Hogan, M. E. Homer, Graph theory and piecewise smooth dynamical systems of arbitrary dimension. *Chaos Solitons Fractals* 10 (1999), no. 11, 1869–1880.
- [168] S. J. Hogan, Nonsmooth systems: synchronization, sliding and other open problems, *International Workshop on Resonance Oscillations and Stability of Nonsmooth Systems*, Imperial College London, 16-25 June 2009, www2.imperial.ac.uk/omakaren/rosns2009/Presentations/Hogan.pdf.
- [169] M. E. Homer, S. J. Hogan, Impact dynamics of large dimensional systems, *Internat. J. Bifur. Chaos Appl. Sci. Engrg.* 17 (2007), no. 2, 561–573.
- [170] M. de Hoop, G. Hormann, M. Oberguggenberger, Evolution systems for paraxial wave equations of Schrodinger-type with non-smooth coefficients, *J. Differential Equations* 245 (2008) 1413–1432.
- [171] C. Hos, A. R. Champneys, Grazing bifurcations and chatter in a pressure relief valve model, *Physica D ?? (????) ???-???* (special issue "Dynamics and bifurcations of nonsmooth systems" of Physica D).
- [172] H. Y. Hu, Detection of grazing orbits and incident bifurcations of a forced continuous, piecewise-linear oscillator, *Journal of Sound and Vibration* 187 (1995), no. 3, 485–493.
- [173] N. Humphries, P. T. Piironen, A discontinuity-geometry view of the relationship between saddle-node and grazing bifurcations, *Physica D ?? (????) ???-???* (special issue "Dynamics and bifurcations of nonsmooth systems" of Physica D).
- [174] L. Iannelli, K. H. Johansson, U. T. Jonsson, F. Vasca, Averaging of non-smooth systems using dither, *Automatica* 42 (2006) 669–676.
- [175] L. Iannelli, K. H. Johansson, U. T. Jonsson, F. Vasca, Subtleties in the averaging of a class of hybrid systems with applications to power converters, *Control Engineering Practice* 16 (2008), no. 8, 961–975.
- [176] L. Iannelli, K. H. Johansson, U. T. Jonsson, F. Vasca, On the averaging of a class of hybrid systems, *IEEE 43rd Conference on Decision and Control – Proceedings, 1-5 (2004) 1400–1405*.
- [177] R. A. Ibrahim, Friction-Induced Vibration, Chatter, Squeal, and Chaos – Part II: Dynamics and Modeling, *ASME Applied Mechanics Reviews* 47 (1994), no. 7, 227–253.
- [178] R. A. Ibrahim, Vibro-impact dynamics. Modeling, mapping and applications. *Lecture Notes in Applied and Computational Mechanics*, 43. Springer-Verlag, Berlin, 2009.
- [179] J. Ing, E. Pavlovskaia, M. Wiercigroch, S. Banerjee, Bifurcation analysis of an impact oscillator with a one-sided elastic constraint near grazing, *Physica D* 239 (2010), no. 6, 312–321.
- [180] J. Ing, E. Pavlovskaia, M. Wiercigroch, Dynamics of a nearly symmetrical piecewise linear oscillator close to grazing incidence: Modelling and experimental verification, *Nonlinear Dynamics* 46 (2006), no. 3, 225–238.
- [181] A. P. Ivanov, Stabilization Of An Impact Oscillator Near Grazing Incidence Owing To Resonance, *Journal of Sound and Vibration* 162 (1993), no. 3, 562–565.
- [182] A. P. Ivanov, Impact Oscillations: Linear Theory Of Stability And Bifurcations, *Journal of Sound and Vibration* 178 (1994), no. 3, 361–378.
- [183] A. P. Ivanov, Bifurcations in impact systems, *Chaos, Solitons & Fractals* 7 (1996), no. 10, 1615–1634.
- [184] A. Jacquemard, W. F. Pereira, M. A. Teixeira, Generic singularities of relay systems, *Journal of Dynamical and Control Systems* 13 (2007), no. 4, 503–530.
- [185] A. Jacquemard, M. A. Teixeira, On singularities of discontinuous vector fields, *Bulletin des Sciences Mathematiques* 127 (2003), no. 7, 611–633.
- [186] A. Jacquemard, M. A. Teixeira, Periodic solutions of a class of non-autonomous second order differential equations with discontinuous right-hand side, *Physica D ?? (????) ???-???* (special issue "Dynamics and bifurcations of nonsmooth systems" of Physica D).
- [187] O. Janin, C. H. Lamarque, Stability of Singular Periodic Motions in a Vibro-Impact Oscillator, *Nonlinear Dynamics* 28 (2002) 231–241.
- [188] M. R. Jeffrey, Three discontinuity-induced bifurcations to destroy self-sustained oscillations in a superconducting resonator, *Physica D ?? (????) ???-???* (special issue "Dynamics and bifurcations of nonsmooth systems" of Physica D).
- [189] M. R. Jeffrey, A. Colombo, The two-fold singularity of discontinuous vector fields, *SIAM J. Appl. Dyn. Syst.* 8 (2009) 624–640.
- [190] M. R. Jeffrey, Nondeterminism in the limit of nonsmooth dynamics, *Physical Review Letters* 106 (2011), no. 25, 254103.
- [191] M. R. Jeffrey, S. J. Hogan, The Geometry of Generic Sliding Bifurcations, *SIAM Review* 53 (2011), no. 3, 505–525.
- [192] A. Kahraman, G. W. Blankenship, Experiments on Nonlinear Dynamic Behavior of an Oscillator With Clearance and Periodically Time-Varying Parameters, *Journal of Applied Mechanics* 64 (1997), pp. 217–226.
- [193] A. Kahraman, On the response of a preloaded mechanical oscillator with a clearance: Period-doubling and chaos, *Nonlinear Dynamics* 3 (1992) 183–198.
- [194] M. Kamenskii, O. Makarenkov, P. Nistri, A continuation principle for a class of periodically perturbed autonomous systems. *Math. Nachr.* 281 (2008), no. 1, 42–61.
- [195] T. Kapitaniak, M. Wiercigroch, Dynamics of impact systems, *Chaos Solitons Fractals* 11 (2000), no. 15, 2411–2580.
- [196] T. Kapitaniak, Y. Maistrenko, Riddling bifurcations in coupled piecewise linear maps, *Phys. D* 126 (1999), no. 1-2, 18–26.
- [197] A. Kaplan, N. Friedman, M. Andersen, N. Davidson, Observation of Islands of Stability in SoftWall Atom-Optics Billiards, *Physical Review Letters* 87 (2001), no. 27, 274101–1–4.
- [198] T. Kinoshita, T. Wenger, D. S. Weiss, A quantum Newton’s cradle, *Nature* 440 (2006) 900–903.

- [199] S. Klymchuk, A. Plotnikov, N. Skripnik, Overview of V.A. Plotnikov's research on averaging of differential inclusions, *Physica D ?? (????) ???-???* (special issue "Dynamics and bifurcations of nonsmooth systems" of *Physica D*).
- [200] A. N. Kolmogorov, On degeneration of isotropic turbulence in an incompressible viscous liquid, C. R. (Doklady) Acad. Sci. URSS (N. S.) 31 (1941), 538–540. English translation: Dissipation of energy in the locally isotropic turbulence. Turbulence and stochastic processes: Kolmogorov's ideas 50 years on. *Proc. Roy. Soc. London Ser. A* 434 (1991), no. 1890, 15–17.
- [201] P. Kowalczyk, P. Glendinning, Boundary-equilibrium bifurcations in piecewise-smooth slow-fast systems, *Chaos* 21 (2011), no. 2, 023126.
- [202] P. Kowalczyk, M. di Bernardo, A. R. Champneys, S. J. Hogan, M. Homer, Yu. A. Kuznetsov and P. T. Piironen, Two-parameter nonsmooth bifurcations of limit cycles: classification and open problems, *International Journal of Bifurcation and Chaos* 16 (2006), no. 3, 601–629.
- [203] P. Kowalczyk, Robust chaos and border-collision bifurcations in non-invertible piecewise-linear maps, *Nonlinearity* 18 (2005), no. 2, 485–504.
- [204] P. Kowalczyk, P. T. Piironen, Two-parameter sliding bifurcations of periodic solutions in a dry-friction oscillator, *Physica D* 237 (2008), no. 8, 1053–1073.
- [205] P. Kowalczyk, M. di Bernardo, Two-parameter degenerate sliding bifurcations in Filippov systems, *Physica D* 204 (2005), no. 3–4, 204–229.
- [206] M. A. Krasnoselskii, The operator of translation along the trajectories of differential equations. *Translations of Mathematical Monographs*, Vol. 19. Translated from the Russian by Scripta Technica. American Mathematical Society, Providence, R.I. 1968.
- [207] M. A. Krasnosel'skii, A. V. Pokrovskii, *Systems with Hysteresis*, Springer, Berlin, Heidelberg, New York (1989).
- [208] P. Krejci, J. P. O'Kane, A. Pokrovskii, D. Rachinskii, Properties of solutions to a class of differential models incorporating Preisach hysteresis operator, *Physica D ?? (????) ???-???* (special issue "Dynamics and bifurcations of nonsmooth systems" of *Physica D*).
- [209] S. G. Kryzhevich, Chaos in Vibroimpact Systems with One Degree of Freedom in a Neighborhood of Chatter Generation: II, *Differential Equations* 47 (2011), no. 1, 29–37.
- [210] S. G. Kryzhevich, Chaos in vibroimpact systems with one degree of freedom in a neighborhood of chatter generation: I, *Differential Equations* 46 (2010), no. 10, 1409–1414.
- [211] S. G. Kryzhevich, V. A. Pliss, Chaotic modes of oscillations of a vibro-impact system, *Prikl. Mat. Mekh.* 69 (2005), no. 1, 15–29; translation in *J. Appl. Math. Mech.* 69 (2005), no. 1, 13–26.
- [212] S. G. Kryzhevich, Topology of Vibro-Impact Systems in the Neighborhood of Grazing, *Physica D ?? (????) ???-???* (special issue "Dynamics and bifurcations of nonsmooth systems" of *Physica D*).
- [213] S. G. Kryzhevich, Grazing bifurcation and chaotic oscillations of vibro-impact systems with one degree of freedom, *Journal of Applied Mathematics and Mechanics* 72 (2008) 383–390.
- [214] B. I. Kryukov, Dynamics of Resonance-Type Vibration Machines [in Russian], *Naukova Dumka*, Kiev (1967).
- [215] T. Kuepper, S. Moritz, Generalized Hopf bifurcation for non-smooth planar systems, *Non-smooth mechanics*, R. Soc. Lond. Philos. Trans. Ser. A Math. Phys. Eng. Sci. 359 (2001), no. 1789, 2483–2496.
- [216] T. Kuepper, H. A. Hosham, Reduction to invariant cones for non-smooth systems, *Mathematics and Computers in Simulation* 81 (2011), no. 5, 980–995.
- [217] T. Kuepper, Invariant cones for non-smooth dynamical systems, *Mathematics and Computers in Simulation* 79 (2008), no. 4, 1396–1408.
- [218] P. Kukucka, Melnikov method for discontinuous planar systems, *Nonlinear Analysis, Th. Meth. Appl.* 66 (2007), 2698–2719.
- [219] M. Kunze, T. Kuepper, Non-smooth dynamical systems: an overview, *Ergodic theory, analysis, and efficient simulation of dynamical systems*, 431–452, Springer, Berlin, 2001.
- [220] M. Kunz, T. Kupper, J. You, On the application of KAM theory to discontinuous dynamical systems, *J. Differential Equations* 139 (1997), no. 1, 1–21.
- [221] M. Kunze, T. Kuepper, Qualitative bifurcation analysis of a non-smooth friction-oscillator model, *Z. Angew. Math. Phys.* 48 (1997), no. 1, 87–101.
- [222] Y. Kuznetsov, *Elements of applied bifurcation theory*. Third edition. Applied Mathematical Sciences, 112. Springer-Verlag, New York, 2004. xxii+631 pp.
- [223] Yu. A. Kuznetsov, S. Rinaldi, A. Gragnani, One-parameter bifurcations in planar Filippov systems, *Internat. J. Bifur. Chaos Appl. Sci. Engrg.* 13 (2003), no. 8, 2157–2188.
- [224] C. Kwon, T. L. Friesz, R. Mookherjee, T. Yao, B. Feng, Non-cooperative competition among revenue maximizing service providers with demand learning, *European Journal of Operational Research* 197 (2009), no. 3, 981–996.
- [225] A. C. Lazer, P. J. McKenna, Existence, uniqueness, and stability of oscillations in differential equations with asymmetric nonlinearities, *Trans. Amer. Math. Soc.* 315 (1989), no. 2, 721–739.
- [226] R. I. Leine, T. F. Heimsch, Global Uniform Symptotic Attractive Stability of the Non-Autonomous Bouncing Ball System, *Physica D ?? (????) ???-???* (special issue "Dynamics and bifurcations of nonsmooth systems" of *Physica D*).
- [227] R. I. Leine, N. van de Wouw, Stability and convergence of mechanical systems with unilateral constraints. *Lecture Notes in Applied and Computational Mechanics*, 36. Springer-Verlag, Berlin, 2008. xiv+236 pp.
- [228] R. I. Leine, D. H. van Campen, Bifurcation phenomena in non-smooth dynamical systems, *Eur. J. Mech. A Solids* 25 (2006), no. 4, 595–616.
- [229] R. I. Leine, B. Brogliato, H. Nijmeijer, Periodic motion and bifurcations induced by the Painlevé paradox, *Eur. J. Mech. A Solids* 21 (2002), no. 5, 869–896.
- [230] R. I. Leine, D. H. van Campen, Discontinuous bifurcations of periodic solutions, *Mathematical and Computer Modelling* 36 (2002) 259–273.
- [231] R. I. Leine, D. H. van Campen, Discontinuous fold bifurcations, *Systems Analysis Modelling Simulation* 43 (2003), no. 3, 321–332.
- [232] R. I. Leine, D. H. van Campen, Discontinuous fold bifurcations in mechanical systems, *Archive of Applied Mechanics* 72 (2003), no. 3, 321–332.
- [233] R. I. Leine, Bifurcations of equilibria in non-smooth continuous systems, *Physica D* 223 (2006) 121–137.
- [234] N. Levinson, A second order differential equation with singular solutions. *Ann. of Math.* 50 (1949), no. 2, 127–153.
- [235] X. Li, H. Wang, Y. Kuang, Global analysis of a stoichiometric producer-grazer model with Holling type functional responses, *J. Math. Biol.* 63 (2011), no. 5, 901–932.
- [236] Y. Li, Z. Du, W. Zhang, Asymmetric type II periodic motions for nonlinear impact oscillators, *Nonlinear Analysis* 68 (2008) 2681–2696.
- [237] J. W. Liang, B. F. Feeny, Dynamical friction behavior in a forced oscillator with a compliant contact, *Journal of Applied Mechanics – Transactions of the ASME* 65 (1998), no. 1, 250–257.
- [238] X. Liu, M. Han, Bifurcation of limit cycles by perturbing piecewise hamiltonian systems, *International Journal of Bifurcation and Chaos* 20 (2010), no. 5, 1379–1390.
- [239] J. Llibre, P. R. da Silva, M. A. Teixeira, Sliding vector fields via slow-fast systems, *Bull. Belg. Math. Soc. Simon Stevin* 15 (2008), no. 5, Dynamics in perturbations, 851–869.
- [240] J. Llibre, P. R. da Silva, M. A. Teixeira, Regularization of discontinuous vector fields on \mathbb{R}^3 via singular perturbation, *J. Dynam. Differential Equations* 19 (2007), no. 2, 309–331.
- [241] I. Loladze, Y. Kuang, J. J. Elser, Stoichiometry in producer-grazer systems: Linking energy flow with element cycling, *Bulletin of Mathematical Biology* 62 (2000), no. 6, 1137–1162.
- [242] A. C. J. Luo, Singularity and dynamics on discontinuous vector fields. *Monograph Series on Nonlinear Science and Complexity*, 3. Elsevier B. V., Amsterdam, 2006.
- [243] A. C. J. Luo, Discontinuous dynamical systems on time-varying domains. *Nonlinear Physical Science*. Higher Education Press, Beijing; Springer, Berlin, 2009.
- [244] A. C. J. Luo, S. Thapa, Periodic motions in a simplified brake system with a periodic excitation, *Commun Nonlinear Sci Numer Simulat* 14 (2009) 2389–2414.
- [245] A. C. J. Luo, B. Xue, An analytical prediction of periodic flows in the chua circuit system, *International Journal of Bifurcation and Chaos* 19 (2009), no. 7 2165–2180.
- [246] A. C. J. Luo, D. O'Connor, Periodic motions and chaos with impacting chatter and stick in a gear transmission system, *International journal of bifurcation and chaos in applied sciences and engineering* 19 (2009), no. 6, 1975–1994.

- [247] A. C. J. Luo, B. C. Gegg, Periodic Motions in a Periodically Forced Oscillator Moving on an Oscillating Belt With Dry Friction, *J. Comput. Nonlinear Dynam.* 1 (2006), no. 3, 212–220.
- [248] A. C. J. Luo, B. C. Gegg, Grazing phenomena in a periodically forced, friction-induced, linear oscillator, *Communications in Nonlinear Science and Numerical Simulation* 11 (2006), no. 7, 777–802.
- [249] A. C. J. Luo, B. C. Gegg, Stick and non-stick periodic motions in periodically forced oscillators with dry friction, *Journal of Sound and Vibration* 291 (2006) 132–168.
- [250] A. C. J. Luo, B. C. Gegg, Dynamics of a harmonically excited oscillator with dry-friction on a sinusoidally time-varying, traveling surface *International Journal of Bifurcation and Chaos* 16 (2006), no. 12, 3539–3566.
- [251] G. Luo, X. Lv, Dynamics of a plastic-impact system with oscillatory and progressive motions, *International Journal of Non-Linear Mechanics* 43 (2008) 100–110.
- [252] G. Luo, J. Xie, X. Zhu, J. Zhang, Periodic motions and bifurcations of a vibro-impact system, *Chaos, Solitons and Fractals* 36 (2008) 1340–1347.
- [253] Y. Ma, M. Agarwal, S. Banerjee, Border collision bifurcations in a soft impact system, *Physics Letters A* 354 (2006) 281–287.
- [254] Y. Ma, C. K. Tse, T. Kousaka, H. Kawakami, Connecting Border Collision With Saddle-Node Bifurcation in Switched Dynamical Systems, *IEEE Transaction on Circuits and Systems* 52 (2005), no. 9, 581–585.
- [255] Y. Ma, J. Ing, S. Banerjee, M. Wiercigroch, E. E. Pavlovskaja, The nature of the normal form map for soft impacting systems, *International Journal of Non-Linear Mechanics* 43 (2008), no. 6, 504–513.
- [256] Yu. L. Maistrenko, V. L. Maistrenko, S. I. Vikul, L. O. Chua, Bifurcations of attracting cycles from time-delayed Chua’s circuit, *International Journal of Bifurcation and Chaos in Applied Sciences and Engineering* 5 (1995), no. 3, 653–671.
- [257] O. Yu. Makarenkov, The Poincaré index and periodic solutions of perturbed autonomous systems. (Russian) *Tr. Mosk. Mat. Obs.* 70 (2009), 4–45; translation in *Trans. Moscow Math. Soc.* 2009, 1–30.
- [258] O. Makarenkov, P. Nistri, Periodic solutions for planar autonomous systems with nonsmooth periodic perturbations. *J. Math. Anal. Appl.* 338 (2008), no. 2, 1401–1417.
- [259] J. F. Mason, P. T. Piiroinen, The Effect of Codimension-Two Bifurcations on the Global Dynamics of a Gear Model, *SIAM J. Applied Dynamical Systems* 8 (2009), no. 4, 1694–1711.
- [260] J. Mawhin, Degré topologique et solutions périodiques des systèmes différentiels non linéaires, *Bull. Soc. Roy. Sci. Liège* 38 (1969) 308–398.
- [261] S. McNamara, Rigid and quasi-rigid theories of granular media, *IUTAM Bookseries*, Vol. 1 (2007) 163–172.
- [262] A. I. Mees, A plain mans guide to bifurcations, *IEEE Transactions on Circuits and Systems*, v CAS-30, n 8, p 512-17, 1983.
- [263] J. Melcher, X. Xu, A. Raman, Multiple impact regimes in liquid environment dynamic atomic force microscopy, *Applied Physics Letters* 93 (2008), no. 9, 093111.
- [264] A. Minassian, B. Thompson, M. J. Damzen, High-power TEM00 grazing-incidence Nd : YVO4 oscillators in single and multiple bounce configurations, *Optics Communications* 245 (2005), no. 1-6, 295–300.
- [265] C. Mira, C. Rauzy, Y. Maistrenko, I. Sushko, Some properties of a two-dimensional piecewise-linear noninvertible map, *Internat. J. Bifur. Chaos Appl. Sci. Engrg.* 6 (1996), no. 12A, 2299–2319.
- [266] S. Misra, H. Dankowicz, Control of near-grazing dynamics and discontinuity-induced bifurcations in piecewise-smooth dynamical systems, *International journal of robust and nonlinear control* 20 (2010), no. 16, 1836–1851.
- [267] S. Misra, H. Dankowicz, M. R. Paul, Degenerate discontinuity-induced bifurcations in tapping-mode atomic-force microscopy, *Physica D* 239 (2010) 33–43.
- [268] N. Mitsui, K. Hirahara, Simple Spring-mass Model Simulation of Earthquake Cycle along the Nankai Trough in Southwest Japan, *Pure appl. geophys.* 161 (2004) 2433–2450.
- [269] J. Molenaar, J. G. de Weger, W. van de Water, Mappings of grazing-impact oscillators, *Nonlinearity* 14 (2001) 301–321.
- [270] M. D. P. Monteiro Marques, Differential inclusions in nonsmooth mechanical problems. Shocks and dry friction. *Progress in Nonlinear Differential Equations and their Applications*, 9. Birkhauser Verlag, Basel, 1993. x+179 pp.
- [271] J.-J. Moreau, Bounded variation in time. *Topics in nonsmooth mechanics*, 1–74, Birkhauser, Basel, 1988.
- [272] A. Nordmark, H. Dankowicz, A. Champneys, Friction-induced reverse chatter in rigid-body mechanisms with impacts, *IMA Journal of Applied Mathematics* 76 (2011), no. 1, 85–119.
- [273] A. Nordmark, H. Dankowicz, A. Champneys, Discontinuity-induced bifurcations in systems with impacts and friction: Discontinuities in the impact law, *International journal of non-linear mechanics* 44 (2009), no. 10, 1011–1023.
- [274] A. B. Nordmark, Discontinuity mappings for vector fields with higher order continuity, *Dynamical Systems* 17 (2002), no. 4, 359–376.
- [275] A. B. Nordmark, Non-periodic motion caused by grazing incidence in impact oscillators, *J. Sound Vibration* 2 (1991) 279–297.
- [276] A. B. Nordmark, Effects due to low velocity impact in mechanical oscillators, *Internat. J. Bifur. Chaos Appl. Sci. Engrg.* 2 (1992), no. 3, 597–605.
- [277] A. B. Nordmark, Universal limit mapping in grazing bifurcations, *Physical Review E* 55 (1997), no. 1, 266–270.
- [278] A. B. Nordmark, Existence of periodic orbits in grazing bifurcations of impacting mechanical oscillators, *Nonlinearity* 14 (2001) 1517–1542.
- [279] A. B. Nordmark, P. Kowalczyk, A codimension-two scenario of sliding solutions in grazing-sliding bifurcations, *Nonlinearity* 19 (2006), no. 1, 1–26.
- [280] A. B. Nordmark, P. T. Piiroinen, Simulation and stability analysis of impacting systems with complete chattering, *Nonlinear Dynamics* 58 (2009), no. 1, 85–106.
- [281] A. B. Nordmark and P. Kowalczyk, A codimension-two scenario of sliding solutions in grazing-sliding bifurcations, *Nonlinearity* 19 (2006) 1–26.
- [282] H. E. Nusse, J. A. Yorke, Border-collision bifurcations for piecewise smooth one-dimensional maps, *Internat. J. Bifur. Chaos Appl. Sci. Engrg.* 5 (1995), no. 1, 189–207.
- [283] H. E. Nusse, E. Ott, J. A. Yorke, Border-collision bifurcations: An explanation for observed bifurcation phenomena, *Physical Review E* 49 (1994), no. 2, 1073–1076.
- [284] H. Nusse, J. Yorke, Border-collision bifurcations including “period two to period three” for piecewise smooth systems, *Phys. D* 57 (1992), no. 1-2, 39–57.
- [285] M. Oestreich, N. Hinrichs, K. Popp, Bifurcation and stability analysis for a non-smooth friction oscillator, *Archive of Applied Mechanics* 66 (1996) 301-314.
- [286] J.-S. Pang, Frictional contact models with local compliance: semismooth formulation, *ZAMM* 88 (2008), no. 6, 454–471.
- [287] J.-S. Pang, D. E. Stewart, Differential variational inequalities, *Mathematical programming*, 113 (2008), no. 2, 345–424.
- [288] L. Paoli, M. Schatzman, Resonance in impact problems, *Math. Comput. Modelling* 28 (1998) 293–306.
- [289] R. G. Parker, S. M. Vijayakar, T. Imajo, Non-linear dynamic response of a spur gear pair: Modeling and experimental comparisons, *Journal of Sound and Vibration* 237 (2000), no. 3, 435–455.
- [290] E. Pavlovskaja, M. Wiercigroch, Low-dimensional maps for piecewise smooth oscillators, *Journal of Sound and Vibration* 305 (2007), no. 4-5, 750–771.
- [291] E. Pavlovskaja, J. Ing, M. Wiercigroch, S. Banerjee, Complex dynamics of bilinear oscillator close to grazing, *Internat. J. Bifur. Chaos Appl. Sci. Engrg.* 20 (2010), no. 11, 3801–3817.
- [292] E. E. Pavlovskaja, J. Ing, M. Wiercigroch, S. Banerjee, Complex dynamics of bilinear oscillator close to grazing, *International Journal of Bifurcation and Chaos* 20 (2010), no. 11, 3801–3817.
- [293] O. Payton, A. R. Champneys, M. E. Homer, L. Picco, M. J. Miles, Feedback-induced instability in tapping mode atomic force microscopy: theory and experiment, *Proceedings of the Royal Society A-Mathematical, Physical and Engineering Sciences* 467 (2011), no. 2130, 1801-1822.
- [294] F. Peterka, Dynamics of Mechanical Systems with Soft Impacts, *IUTAM Symposium on Chaotic Dynamics and Control of Systems and Processes in Mechanics, Solid Mechanics and Its Applications*, 122 (2005) 313–322.
- [295] F. Peterka, Behaviour of impact oscillator with soft and preloaded stop, *Chaos, Solitons and Fractals* 18 (2003) 79–88.

- [296] V. N. Philipchuk, Strongly nonlinear vibrations of damped oscillators with two nonsmooth limits, *Journal of Sound and Vibration* 302 (2007) 398–402.
- [297] P. T. Piironen, L. N. Virgin, A. R. Champneys, Chaos and Period-Adding: Experimental and Numerical Verification of the Grazing Bifurcation, *J. Nonlinear Sci.* 14 (2004) 383–404.
- [298] A. Polynikis, M. di Bernardo, S. J. Hogan, Synchronizability of coupled PWL maps, *Chaos Solitons Fractals* 41 (2009), no. 3, 1353–1367.
- [299] N. Popovic, A geometric analysis of front propagation in an integrable Nagumo equation with a linear cut-off, *Physica D* ?? (????) ???-??? (special issue "Dynamics and bifurcations of nonsmooth systems" of *Physica D*).
- [300] S. R. Pring, C. J. Budd, The dynamics of a simplified pinball machine, *IMA J. Appl. Math.* 76 (2011), no. 1, 67–84.
- [301] S. R. Pring, C. J. Budd, The dynamics of regularized discontinuous maps with applications to impacting systems, *SIAM J. Appl. Dyn. Syst.* 9 (2010), no. 1, 188–219.
- [302] C. C. Pugh, Funnel sections, *J. Differential Equations* 19 (1975), no. 2, 270–295.
- [303] Z. Qin, J. Yang, S. Banerjee, G. Jiang, Border-collision bifurcations in a generalized piecewise linear-power map, *Discrete Contin. Dyn. Syst. Ser. B* 16 (2011), no. 2, 547–567.
- [304] B. Rakshit, M. Apratim, S. Banerjee, Bifurcation phenomena in two-dimensional piecewise smooth discontinuous maps, *Chaos* 20 (2010), no. 3, 033101, 12 pp.
- [305] B. Rakshit, S. Banerjee, Existence of chaos in a piecewise smooth two-dimensional contractive map, *Phys. Lett. A* 373 (2009), no. 33, 2922–2926.
- [306] V. Rom-Kedar, D. Turaev, Big islands in dispersing billiard-like potentials, *Phys. D* 130 (1999), no. 3–4, 187–210.
- [307] F. D. Rossa, F. Dercole, Generalized boundary equilibria in n -dimensional Filippov systems: The transition between persistence and nonsmooth-fold scenarios, *Physica D* ?? (????) ???-??? (special issue "Dynamics and bifurcations of nonsmooth systems" of *Physica D*).
- [308] V. B. Ryabov, K. Ito, Intermittent phase transitions in a slider-block model as a mechanism for earthquakes, *Pure and Applied Geophysics* 158 (2001), no. 5–6, 919–930.
- [309] A. M. Samoilenko, The method of averaging in intermittent systems. (Russian) *Mathematical physics*, No. 9 (Russian), pp. 101–117. *Naukova Dumka*, Kiev, 1971.
- [310] A. M. Samoilenko, N. A. Perestjuk, Invariant sets of systems with instantaneous change in standard form. *Ukrainian Mathematical Journal* 25 (1973), no. 1, 111–115.
- [311] A. M. Samoilenko, N. A. Perestjuk, The averaging method in systems with impulsive action. *Ukrainian Mathematical Journal* 26 (1974), no. 3, 342–347.
- [312] A. M. Samoilenko, V. G. Samoilenko and V. V. Sobchuk, On periodic solutions of the equation of a nonlinear oscillator with pulse influence, *Ukrainian Mathematical Journal* 51 (1999), no. 6, 926–933.
- [313] D. Sauder, A. Minassian, M. J. Damzen, High efficiency laser operation of 2 at.% doped crystalline Nd : YAG in a bounce geometry, *Optics Express* 14 (2006), no. 3, 1079–1085.
- [314] M. Schatzman, Uniqueness and Continuous Dependence on Data for One-Dimensional Impact Problems, *Mathematical and Computer Modelling* 28 (1998), no. 4–8, 1–18.
- [315] A. Sebastian, M. V. Salapaka, D. J. Chen, Harmonic and power balance tools for tapping-mode atomic force microscope, *Journal of Applied Physics* 89 (2001), no. 11, 6473–6480.
- [316] S. W. Shaw, P. Holmes, Periodically forced linear oscillator with impacts: chaos and long-period motions. *Phys. Rev. Lett.* 51 (1983), no. 8, 623–626.
- [317] S. W. Shaw, P. J. Holmes, A periodically forced piecewise linear oscillator. *J. Sound Vibration* 90 (1983), no. 1, 129–155.
- [318] J. Sieber, B. Krauskopf, Control based bifurcation analysis for experiments, *Nonlinear Dynamics* 51 (2008), no. 3, 365–377.
- [319] J. Sieber, P. Kowalczyk, Small-scale instabilities in dynamical systems with sliding, *Physica D* 239 (2010), no. 1–2, 44–57.
- [320] D. J. W. Simpson, R. Kuske, Mixed-Mode Oscillations in a Stochastic Piecewise-Linear System, *Phys. D* 240 (2011) 1189–1198.
- [321] D. Simpson, Bifurcations in piecewise-smooth continuous systems, *World Scientific*, 2010, 238 p.
- [322] D. J. W. Simpson, J. D. Meiss, Neimark-Sacker bifurcations in planar, piecewise-smooth, continuous maps. *SIAM J. Appl. Dyn. Syst.* 7 (2008), no. 3, 795–824.
- [323] D. J. W. Simpson, J. D. Meiss, Unfolding a codimension-two, discontinuous, Andronov-Hopf bifurcation. *Chaos* 18 (2008), no. 3, 033125, 10 pp.
- [324] D. J. W. Simpson, J. D. Meiss, Shrinking point bifurcations of resonance tongues for piecewise-smooth, continuous maps. *Nonlinearity* 22 (2009), no. 5, 1123–1144.
- [325] D. J. W. Simpson, J. D. Meiss, Aspects of Bifurcation Theory for Piecewise-Smooth, Continuous Systems, *Physica D* ?? (????) ???-??? (special issue "Dynamics and bifurcations of nonsmooth systems" of *Physica D*).
- [326] D. J. W. Simpson, J. D. Meiss, Andronov-Hopf bifurcations in planar, piecewise-smooth, continuous flows. *Phys. Lett. A* 371 (2007), no. 3, 213–220.
- [327] D. J. W. Simpson, J. D. Meiss, Simultaneous border-collision and period-doubling bifurcations, *Chaos* 19 (2009), no. 3, 033146.
- [328] D. J. W. Simpson, J. D. Meiss, Resonance near border-collision bifurcations in piecewise-smooth, continuous maps, *Nonlinearity* 23 (2010), no. 12, 3091–3118.
- [329] E. Sitnikova, E. E. Pavlovskaya, M. Wiercigroch, Dynamics of an impact oscillator with SMA constraint, *European Physical Journal - Special Topics* 165 (2008), no. 1, 229–238.
- [330] J. Sotomayor, M. A. Teixeira, Vector fields near the boundary of a 3-manifold. *Dynamical systems, Valparaiso 1986*, 169–195, *Lecture Notes in Math.*, 1331, Springer, Berlin, 1988.
- [331] W. Stamm, A. Fidlin, Regularization of 2D frictional contacts for rigid body dynamics, *IUTAM Bookseries*, Vol. 1 (2007) 291–300.
- [332] W. Stamm, A. Fidlin, Radial dynamics of rigid friction disks with alternating sticking and sliding, in: *EUROMECH 2008 Nonlinear Dynamics Conference* (<http://lib.physcon.ru/?item=20>).
- [333] A. Stensson, B. Nordmark, Experimental investigation of some consequences of low velocity impacts on the chaotic dynamics of a mechanical system, *Philosophical Transactions of the Royal Society of London A* 347 (1994) 439–448.
- [334] D. Stewart, Uniqueness for index-one differential variational inequalities, *Nonlinear Anal. Hybrid Syst.* 2 (2008), no. 3, 812–818.
- [335] D. Stewart, Uniqueness for solutions of differential complementarity problems, *Math. Program.* 118 (2009), no. 2, Ser. A, 327–345.
- [336] D. E. Stewart, Dynamics with inequalities. Impacts and hard constraints. *Society for Industrial and Applied Mathematics (SIAM)*, Philadelphia, PA, 2011. xiv+387 pp.
- [337] J. Sun, F. Amellal, L. Glass, J. Billette, Alternans and Period-doubling Bifurcations in Atrioventricular Nodal Conduction, *J. theor. Biol.* 173 (1995) 79–91.
- [338] I. Sushko, A. Agliari, L. Gardini, Bifurcation structure of parameter plane for a family of unimodal piecewise smooth maps: border-collision bifurcation curves, *Chaos Solitons Fractals* 29 (2006), no. 3, 756–770.
- [339] I. Sushko, A. Agliari, L. Gardini, Bistability and border-collision bifurcations for a family of unimodal piecewise smooth maps, *Discrete Contin. Dyn. Syst. Ser. B* 5 (2005), no. 3, 881–897.
- [340] I. Sushko, G. B. Laura, T. Puu, Tongues of periodicity in a family of two-dimensional discontinuous maps of real Mobius type, *Chaos Solitons Fractals* 21 (2004), no. 2, 403–412.
- [341] I. Sushko, L. Gardini, Center bifurcation for two-dimensional border-collision normal form, *International Journal of Bifurcation and Chaos* 18 (2008), no. 4, 1029–1050.
- [342] I. Sushko, L. Gardini, Degenerate Bifurcations and Border Collisions in Piecewise Smooth 1D and 2D Maps, *International Journal of Bifurcation and Chaos* 20 (2010), no. 7, 2045–2070.
- [343] Sussmann, Héctor J. Bounds on the number of switchings for trajectories of piecewise analytic vector fields. *J. Differential Equations* 43 (1982), no. 3, 399–418.
- [344] F. Svahn, H. Dankowicz, Controlled onset of low-velocity collisions in a vibro-impacting system with friction, *Proceedings of the Royal Society of London, Series A (Mathematical, Physical and Engineering Sciences)* 465 (2009), no. 2112, 3647–3665.
- [345] F. Svahn, H. Dankowicz, Energy transfer in vibratory systems with friction exhibiting low-velocity collisions, *Journal of Vibration and Control* 14 (2008), no. 1–2, 255–284.

- [346] R. Szalai, H. M. Osinga, Arnol'd tongues arising from a grazing-sliding bifurcation, *SIAM Journal on Applied Dynamical Systems* 8 (2009), no. 4, 1434–1461.
- [347] M. Tanelli, G. Osorio, M. di Bernardo, S. M. Savaresi, A. Astolfi, Existence, stability and robustness analysis of limit cycles in hybrid anti-lock braking systems. *Internat. J. Control* 82 (2009), no. 4, 659–678.
- [348] M. A. Teixeira, Codimension two singularities of sliding vector fields, *Bulletin of the Belgian Mathematical Society-Simon Stevin* 6 (1999), no. 3, 369–381.
- [349] M. A. Teixeira, Generic singularities of discontinuous vector fields, *An. Acad. Brasil. Cienc.* 53 (1981), no. 2, 257–260.
- [350] M. A. Teixeira, Perturbation Theory for Non-smooth Systems. In: *Encyclopedia of Complexity and Systems Science* Springer (2009) 6697–6709.
- [351] M. A. Teixeira, P. R. da Silva, Regularization and singular perturbation techniques for non-smooth systems, *Physica D ?? (????) ???-???* (special issue "Dynamics and bifurcations of nonsmooth systems" of *Physica D*).
- [352] M. A. Teixeira, Generic bifurcation of sliding vector fields, *J. Math. Anal. Appl.*, 176 (1993) 436–457.
- [353] M. A. Teixeira, Stability conditions for discontinuous vector fields. *J. Differential Equations* 88 (1990), no. 1, 15–29.
- [354] J. J. Thomsen, A. Fidler, Near-elastic vibro-impact analysis by discontinuous transformations and averaging, *Journal of Sound and Vibration* 311 (2008), no. 1-2, 386–407.
- [355] J.M.T. Thompson, H.B. Stewart, *Nonlinear Dynamics and Chaos: Geometrical Methods for Engineers and Scientists*, Wiley, Chichester, 1986.
- [356] P. Thota, H. Dankowicz, Analysis of grazing bifurcations of quasiperiodic system attractors, *Physica D* 220 (2006), no. 2, 163–174.
- [357] P. Thota, H. Dankowicz, Continuous and discontinuous grazing bifurcations in impacting oscillators, *Physica D* 214 (2006) 187–197.
- [358] P. Thota, X. Zhao, H. Dankowicz, Co-dimension-two Grazing Bifurcations in Single-degree-of-freedom Impact Oscillators, *ASME Journal of Computational and Nonlinear Dynamics* 1 (2006), no. 4, 328–335.
- [359] F. Tramontana, L. Gardini, Border collision bifurcations in discontinuous one-dimensional linear-hyperbolic maps, *Commun. Nonlinear Sci. Numer. Simul.* 16 (2011), no. 3, 1414–1423.
- [360] D. Turaev, Rom-Kedar, Vered Elliptic islands appearing in near-ergodic flows. *Nonlinearity* 11 (1998), no. 3, 575–600.
- [361] A. X. C. N. Valente, N. H. McClamroch, I. Mezic, Hybrid dynamics of two coupled oscillators that can impact a fixed stop. *Internat. J. Non-Linear Mech.* 38 (2003), no. 5, 677–689.
- [362] W. E. E. Vanden-Eijnden, A note on generalized flows, *Phys. D* 183 (2003), no. 3-4, 159–174.
- [363] P. Várkonyi, P. Holmes, On Synchronization and Traveling Waves in Chains of Relaxation Oscillators with an Application to Lamprey CPG, *SIAM J. Applied Dynamical Systems* 7 (2008), no. 3, 766–794.
- [364] P. Vielsack, Regularization of the state of adhesion in the case of Coulomb friction, *ZAMM* 76 (1996), no. 8, 439–446.
- [365] W. Veltmann, Ueber die Bewegung einer Glocke. *Dinglers Polytechnisches Journal* 22 (1876) 481–494.
- [366] W. Veltmann, Die Kolner Kaiserglocke. Enthullungen uber die Art und Weise wie der Kolner Dom zu meiner mitreibenden Glocke gekommen ist. Bonn. 1880.
- [367] L. N. Virgin, R. H. Plaut, Some Non-smooth Dynamical Systems in Off-shore Mechanics, *Vibro-Impact Dynamics of Ocean Systems and Related Problems: Lecture Notes in Applied and Computational Mechanics* 44 (2009) 259–268.
- [368] L. N. Virgin, C. J. Begley, Grazing bifurcations and basins of attraction in an impact-friction oscillator, *Physica D* 130 (1999), no. 1-2, 43–57.
- [369] W. van de Water, J. Molenaar, Dynamics of vibrating atomic force microscopy, *Nanotechnology* 11 (2000) 192–199.
- [370] D. J. Wagg, S. R. Bishop, Chatter, sticking and chaotic impacting motion in a two-degree of freedom impact oscillator, *International Journal of Bifurcation and Chaos* 11 (2001), no. 1, 57–71.
- [371] D. J. Wagg, Periodic sticking motion in a two-degree-of-freedom impact oscillator, *International Journal of Non-Linear Mechanics* 40 (2005) 1076–1087.
- [372] D. J. Wagg, Rising phenomena and the multi-sliding bifurcation in a two-degree of freedom impact oscillator, *Chaos, Solitons and Fractals* 22 (2004) 541–548.
- [373] D. Weiss, T. Kuepper and H. A. Hosham, Invariant manifolds for nonsmooth systems, *Physica D ?? (????) ???-???* (special issue "Dynamics and bifurcations of nonsmooth systems" of *Physica D*).
- [374] J. de Weger, W. van de Water, J. Molenaar, Grazing impact oscillations, *Physical Review E* 62 (2000), no. 2, 2030–2041.
- [375] J. de Weger, D. Binks, J. Molenaar, W. vande Water, Generic behavior of grazing impact oscillators, *Physical Review Letters* 76 (1996), no. 21, 3951–3954.
- [376] B. Wen, Recent development of vibration utilization engineering, *Frontiers of Mechanical Engineering in China* 3 (2008), no. 1, 1–9.
- [377] G. S. Whiston, Global dynamics of a vibro-impacting linear oscillator. *J. Sound Vibration* 118 (1987), no. 3, 395–424.
- [378] G. S. Whiston, The vibro-impact response of a harmonically excited and preloaded one-dimensional linear oscillator, *Journal of Sound and Vibration* 115 (1987), no. 2, 303–319.
- [379] S. Wiggins, Normally hyperbolic invariant manifolds in dynamical systems. With the assistance of Gyorgy Haller and Igor Mezic. *Applied Mathematical Sciences*, 105. Springer-Verlag, New York, 1994.
- [380] W. Xu, J. Feng, H. Rong: Melnikov's method for a general nonlinear vibro-impact oscillator, *Nonlinear Analysis* 71 (2009) 418–426.
- [381] H.-J. Xu, L. Knopoff, Periodicity and chaos in a one-dimensional dynamical model of earthquakes, *Physical Review E* 50 (1994), no. 5, 3577–3581.
- [382] K. Yagasaki, Nonlinear dynamics of vibrating microcantilevers in tapping-mode atomic force microscopy, *Phys. Rev. B* 70, 245419 (2004).
- [383] K. Yagasaki, Bifurcations and chaos in vibrating microcantilevers of tapping mode atomic force microscopy, *International Journal of Non-Linear Mechanics* 42 (2007) 658–672.
- [384] L. S. Young, Bowen-Ruelle measures for certain piecewise hyperbolic maps, *Trans. Amer. Math. Soc.* 287 (1985) 41–48.
- [385] M. Henrard, F. Zanolin, Bifurcation from a periodic orbit in perturbed planar Hamiltonian systems. *J. Math. Anal. Appl.* 277 (2003), no. 1, 79–103.
- [386] J. Zhang, K. H. Johansson, J. Lygeros, S. Sastry, Zeno hybrid systems. Hybrid systems in control. *Internat. J. Robust Nonlinear Control* 11 (2001), no. 5, 435–451.
- [387] W. Zhang, F.-H. Yang, B. Hu, Sliding bifurcations and chaos in a braking system, 2007 Proceedings of the ASME International Design Engineering Technical Conferences and Computers and Information in Engineering Conference, DETC2007 (2008) 183–191.
- [388] X. Zhao, H. Dankowicz, Unfolding degenerate grazing dynamics in impact actuators, *Nonlinearity* 19 (2006), no. 2, 399–418.
- [389] X. Zhao, Discontinuity Mapping for Near-Grazing Dynamics in Vibro-Impact Oscillators, in "Vibro-impact dynamics of ocean systems and related problems", ed. R. A. Ibrahim, V. I. Babitsky, M. Okuma, Springer-Verlag, Berlin, 2009, 275–285.
- [390] X. Zhao, D. G. Schaeffer, Alternate Pacing of Border-Collision Period-Doubling Bifurcations, *Nonlinear Dynamics* 50 (2007), no. 3, 733–742.
- [391] V. F. Zhuravlev, D. M. Klimov, Applied methods in the theory of oscillations (in Russian), "Nauka", Moscow, 1988.
- [392] Z. T. Zhusubaliyev, E. A. Soukhoterov, E. Mosekilde, Border-Collision Bifurcations and Chaotic Oscillations in a Piecewise-Smooth Dynamical System, *International Journal of Bifurcation and Chaos* 11 (2001), no. 12, 2977–3001.
- [393] Z. T. Zhusubaliyev, E. A. Soukhoterov, E. Mosekilde, Border-collision bifurcations on a two-dimensional torus, *Chaos, Solitons and Fractals* 13 (2002) 1889–1915.
- [394] Zh. T. Zhusubaliyev, E. Mosekilde, S. Banerjee, Multiple-attractor bifurcations and quasiperiodicity in piecewise-smooth maps, *Internat. J. Bifur. Chaos Appl. Sci. Engrg.* 18 (2008), no. 6, 1775–1789.
- [395] Zh. T. Zhusubaliyev, E. Mosekilde, S. De, S. Banerjee, Transitions from phase-locked dynamics to chaos in a piecewise-linear map, *Phys. Rev. E* (3) 77 (2008), no. 2, 026206, 9 pp.
- [396] Z. T. Zhusubaliyev, E. Mosekilde, S. Maity, S. Mohanan, S. Banerjee, Border collision route to quasiperiodicity: numerical investigation and experimental confirmation, *Chaos* 16 (2006), no. 2, 23122-1–11.
- [397] Z. T. Zhusubaliyev, E. Mosekilde, Novel routes to chaos through torus breakdown in non-invertible maps, *Physica D* 238 (2009) 589–602.
- [398] Z. T. Zhusubaliyev, E. Mosekilde, Torus birth bifurcations in a DC/DC converter, *IEEE Transaction on Circuits and Systems I-Regular Papers* 53 (2006), no. 8, 1839–1850.

- [399] Z. T. Zhusubaliyev, E. Mosekilde, Birth of bilayered torus and torus breakdown in a piecewise-smooth dynamical system, *Physics Letters A* 351 (2006), no. 3, 167–174.
- [400] Z. T. Zhusubaliyev, E. A. Soukhoterin, E. Mosekilde, Quasi-periodicity and border-collision bifurcations in a DC-DC converter with pulsewidth modulation, *IEEE Transactions on Circuits and Systems I-Fundamental Theory and Applications* 50 (2003), no. 8, 1047–1057.
- [401] K. Zimmermann, I. Zeidis, N. Bolotnik, M. Pivovarov, Dynamics of a two-module vibration-driven system moving along a rough horizontal plane, *Multibody Syst Dyn* 22 (2009) 199–219.
- [402] Y. K. Zou, T. Kupper, Generalized Hopf bifurcation emanated from a corner for piecewise smooth planar systems, *Nonlinear Analysis - Theory Methods & Applications* 62 (2005), no. 1, 1–17.
- [403] Y. Zou, T. Kupper, W.-J. Beyn, Generalized Hopf bifurcation for planar Filippov systems continuous at the origin. *J. Nonlinear Sci.* 16 (2006), no. 2, 159–177.