



**HAL**  
open science

# Impact of Component Losses on the Efficiency of a New Quasi-Z-Source-Based Dual Active Bridge

Viktor Beldjajev, Indrek Roasto, Janis Zakis

► **To cite this version:**

Viktor Beldjajev, Indrek Roasto, Janis Zakis. Impact of Component Losses on the Efficiency of a New Quasi-Z-Source-Based Dual Active Bridge. 4th Doctoral Conference on Computing, Electrical and Industrial Systems (DoCEIS), Apr 2013, Costa de Caparica, Portugal. pp.485-492, 10.1007/978-3-642-37291-9\_52 . hal-01348794

**HAL Id: hal-01348794**

**<https://hal.science/hal-01348794>**

Submitted on 25 Jul 2016

**HAL** is a multi-disciplinary open access archive for the deposit and dissemination of scientific research documents, whether they are published or not. The documents may come from teaching and research institutions in France or abroad, or from public or private research centers.

L'archive ouverte pluridisciplinaire **HAL**, est destinée au dépôt et à la diffusion de documents scientifiques de niveau recherche, publiés ou non, émanant des établissements d'enseignement et de recherche français ou étrangers, des laboratoires publics ou privés.



Distributed under a Creative Commons Attribution 4.0 International License

# Impact of Component Losses on the Efficiency of a New Quasi-Z-source-based Dual Active Bridge

Viktor Beldjajev<sup>1</sup>, IndrekRoasto<sup>1</sup>, JanisZakis<sup>1</sup>

<sup>1</sup>Tallinn University of Technology, Tallinn, Estonia  
{vbeldjajev@gmail.com, Indrek.Roasto@ieee.org, Janis.Zakis@ieee.org}

**Abstract.** The paper analyzes the impact of the component losses on the efficiency of the novel DC/DC converter. The converter is a combination of the quasi-Z-source (qZS) network and dual active bridge (DAB). In the analysis the mathematical loss models of the proposed DC/DC converter are derived and efficiency is estimated. Eventually the efficiency is verified experimentally.

**Keywords.** quasi-Z-source inverter, dual active bridge, power electronic transformer.

## 1 Introduction

During the last decades the bi-directional DC/DC converters have become key components in alternative energy systems. The aim of such converters is to control the electric power flow between the sources and loads, keeping the output voltage on the required level. This paper proposes a novel bi-directional DC/DC converter topology that consists of the quasi-Z-source network, dual active bridge and a high frequency transformer. A possible application of such converter is the isolation stage of the new power electronic transformer (PET) topology where the power flow control capability between two different voltage buses and high efficiency are the major requirements [1-3]. In general, the power flow through the transformer can be controlled by means of voltage elevation on one side or by applying a phase shift control of the inverter bridges on both sides of the transformer. The phase shift control of DAB allows the zero voltage switching to be achieved, that results in reduced switching losses and higher efficiency. In addition, the voltage boost properties of the qZS network allows the voltage on the DC bus to be kept on the constant level that results in lower current stress on the switches. This paper analyzes the converter operation under such conditions when the power flow is controlled only by the phase shift technique. First the loss models are presented according to the waveforms and steady state analysis. Also the impact of the conduction losses of the components on the efficiency characteristics is presented. The obtained efficiency is verified experimentally.

## 2 Relationship to Internet of Things

Nowadays, the global power system can be described by steadily growing number of renewable energy resources and emerging DC loads on the residential level. Continuously developing semi-conductor technology and information internet has inspired the idea of the “Energy Internet” concept that may change energy industry from the centralized system to the client-based distributed infrastructure, improving this way the efficiency of the power grid through optimal management of the energy routers. Energy router, a PET-based device that exchanges the energy between the sources, storage devices, DC loads and end-users, is one of the most critical elements of the Energy Internet. The PET is expected to have a bi-directional power flow, high power conversion and power quality enhancement capabilities, plug and play interface and optimal energy management [4]. The paper contributes to the development of the energy router, by analyzing the suitable DC/DC converter for the power conversion.

## 3 Operating Principle of the Converter

The circuit of the proposed converter, including the conduction losses in the components is shown in Fig.1. Following conduction losses are considered: the collector-to-emitter voltage drop of the IGBT ( $U_{CE}$ ), diode voltage drop ( $U_D$ ) and the winding resistance of the inductors  $L_1$  and  $L_2$  ( $r_l$ ). The converter can operate in both directions, in the forward and in the reverse operating mode. In the forward operating mode the energy is transferred from the HV side towards the LV side. The transistors  $T_5...T_8$  on the HV side and  $T_1...T_4$  on the LV side are switched in pairs using the positive phase shift angle  $\varphi$ . In the forward operating mode the diode  $D$  in the qZS network must be shunted with a switch  $S$  in order to allow the power flow to the LV side. In the reverse operating mode the energy is transferred from the LV side towards the HV side. The transistors  $T_1...T_4$  on the LV side and transistors  $T_5...T_8$  on the HV side are switched in pairs using the negative phase shift angle  $\varphi$  as shown in Fig.2a. The switch  $S$  must be in the opened state. The voltage on the LV side DC link can be elevated by the qZS network. Therefore a shoot-through switching state of the inverter switches is introduced, when both switches on one leg (or all 4 switches) conduct simultaneously [5]. During the shoot-through state the energy is stored in the inductors  $L_1$  and  $L_2$  and transferred to the DC link during the active state. The research in [6] stated that adding additional phase shift angle  $\varphi$  to the HV side bridge gate signals during the shoot-through state on LV side allows the power of the converter to be adjusted. Proposed technique is shown in Fig.2b. Moreover, the additional phase shift can reduce the conduction losses in the transformer that are caused by the circulating current during the shoot through state of the low voltage side inverter (transformer is short circuited). Considering  $N_{TR}$  as the transformer’s turns ratio, the best performance of the phase shift control and the lowest current stress on the switches is achieved if the converter is designed according to the requirement

$$U_{DC} = N_{TR} U_{HV} \quad (1)$$

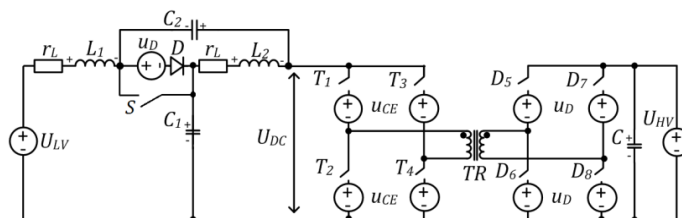

Fig.1. Circuit of qZS-DAB converter with the losses in the components

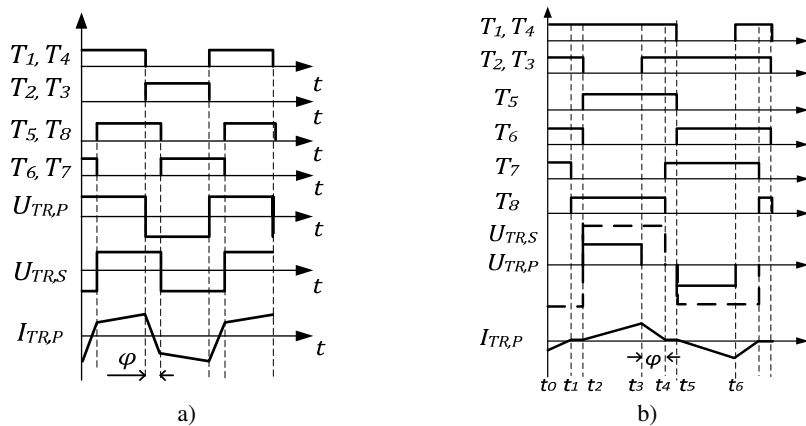

Fig.2. Waveforms of the qZS-DAB converter in the reverse operating modes: a) operation under normal conditions, b) voltage boost mode.

#### 4 Impact of the Component Losses on the Output Power

In order to facilitate the impact of the component losses on the output power of the qZS based DAB, the mathematical models were derived based on the steady state analysis of the qZS inverter [7] and DAB [8]. Selected circuit parameters are shown in Table 1.

Table 1. The circuit parameters of the qZS-DAB converter

Parameter	Value
HV side voltage $U_{HV}$	90 V
LV side voltage $U_{LV}$	30 V
Switching frequency $f_s$	20 kHz
MF transformer turns ratio $N_{TR}$	1/3
Leakage inductance of MF transformer $L_{TR}$	10 $\mu$ H
Resistance of the inductors $L_1$ and $L_2 r_L$	150 m $\Omega$
IGBT saturation voltage $U_{CE}$	1.8 V
Diode voltage drop $U_D$	1.1 V

### 4.1 Normal Mode

In the normal mode the voltage on the DC link is at the desired level and conventional phase-shift control method is used to transfer the power. The operating period  $T$  consist of the active state of the transformer and power transferred from the low voltage side to the high voltage side can be evaluated as follows

$$P_{loss} = \frac{N_{TR}(U_{HV} - 2U_D) \cdot (U_{LV} - 2U_{CE})D_\varphi(1 - |D_\varphi|)}{2f_S L_{TR}}, -1 \leq D_\varphi \leq 1. \quad (2)$$

where  $D_\varphi$  is the phase shift duration,  $f_S$  is the switching frequency and  $L_{TR}$  is the leak-age inductance of the medium frequency (MF) transformer.

### 4.2 Voltage Boost Mode

In the voltage boost mode the voltage on the DC link can be elevated to match the desired level. The operating period  $T$  of the MF transformer consists of an active state  $t_A$  and a shoot through state  $t_S$  that can also be represented with the duty cycles

$$\frac{t_A}{T} + \frac{t_S}{T} = D_A + D_S = 1. \quad (3)$$

A phase shift  $D_\varphi$  is added to gate signals to adjust the power level of the converter as shown in Fig 2b. The power transferred from the LV side to the HV side can be evaluated as follows

$$P_{loss} = \frac{(U_{DC} - 2U_{CE})(2N_{TR}(U_{HV} - 2U_D) - (U_{DC} - 2U_{CE}))D_\varphi(1 - D_S)}{4f_S L_{TR}}. \quad (4)$$

In order to estimate the DC link voltage and thus the output and input power of the converter the equation system (5) can be composed based on the shoot-through (see Fig. 3a) and active (see Fig. 3b) switching states.

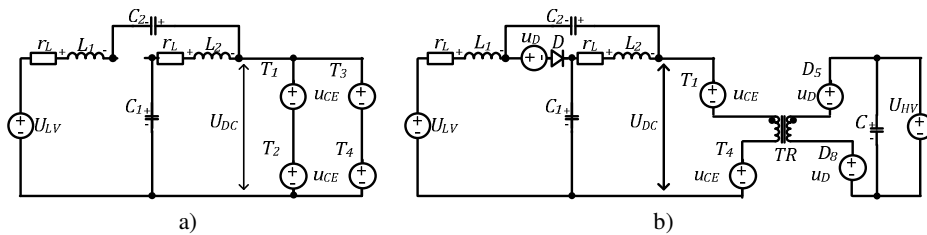

**Fig.3.** Switching states of qZS in voltage boost mode: a) shoot through state, b) active state

$$\begin{cases} u_{L1} = (U_{C2} + U_{LV} - U_{CE} - I_L r_L) D_S + (U_{LV} - U_{C1} - U_D - I_L r_L)(1 - D_S) = 0 \\ u_{L2} = (U_{C1} - U_{CE} - I_L r_L) D_S + (-U_{C2} - U_D + I_L r_L)(1 - D_S) = 0 \\ U_{C1} + U_{C2} + U_D - U_{DC} = 0 \\ i_{C2} = I_L D_S + (I_{TR} - I_L)(1 - D_S) = 0 \end{cases} \quad (5)$$

Solving the equation system the DC link voltage can be obtained as follows

$$U_{DC} = \frac{U_{LV} - 2I_{TR} r_L D_S (1 - D_S) - U_D - 2U_{CE} D_S}{1 - 2D_S}, \quad (6)$$

where the  $I_{TR}$  is the average transformer current during half-period and it can be obtained from (4) and (5) in a following way

$$I_{TR} = \frac{P_{loss}}{U_{DC} - 2U_{CE}}. \quad (7)$$

As can be seen from (6) the impact of component losses on the  $U_{DC}$  depends on the shoot-through duty cycle duration. According to (7) the transformer average current depends on the transferred power and is inversely proportional to the voltage value on the DC link and voltage drop of the IGBT.

Typically a drawback of the DAB is the increase of the current stress due to the voltage variation on the DC buses, however the DAB extended with the additional qZS network allows the current stress on the switches to be reduced. The current stress on the switches  $T_1$  and  $T_5$ , obtained with the simulation results for determined circuit parameters, is presented in Table 2. According to the simulation results, the current stress on the LV side switches can be reduced from 29 A in case of the DAB to 22 A when the qZS-DAB operates in the voltage boost mode. Moreover, in the voltage boost mode the current on the HV side switches can be reduced from 3A to 0.5A that in turn results in smaller conduction and switching losses.

**Table 2.** Current stress in the switches

	$I(T_1)$	$I(T_5)$
Conventional DAB	29.3 A	3.07 A
qZS-DAB (normal mode)	27.6 A	3.4 A
qZS-DAB (boost mode)	22 A	0.5 A

## 5 Impact of the Component Losses on the Efficiency

In order to facilitate the influence of the component losses on the efficiency of the qZS based DAB the derived mathematical models were analyzed for different com-

ponent values at varying phase shift duty cycles. The output and input power was estimated and the efficiency was obtained according to the following equation

$$\eta = \frac{P_{OUT}}{P_{IN}} \cdot 100\% . \tag{11}$$

The Fig.4 depicts the influence of the  $U_{CE}$  on the efficiency of the converter for different phase shift values. It can be seen that the increase of the  $U_{CE}$  from 0...3 V decreases the efficiency from 0.95...0.73. Increasing the input voltage would result in a higher efficiency and relatively smaller impact of the  $U_{CE}$ . The influence of the active resistance of the inductors is shown in the Fig.5. For the given circuit parameters the increase of the  $r_L$  from 0...1 reduces the converter efficiency from 0.85...0.61 for normal mode and from 0.82...0.77 for the voltage boost mode. The influence of the diode voltage drop on the efficiency is shown in the Fig.6. It can be seen that the increasing the diode voltage drop  $U_D$  the efficiency decreases from 0.86...0.73.

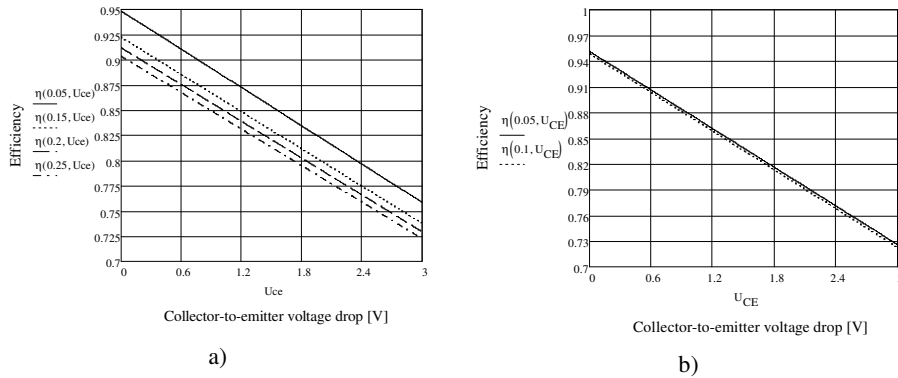

**Fig.4.** Impact of the collector-to-emitter voltage drop on the efficiency: a) normal mode; b) voltage boost mode.

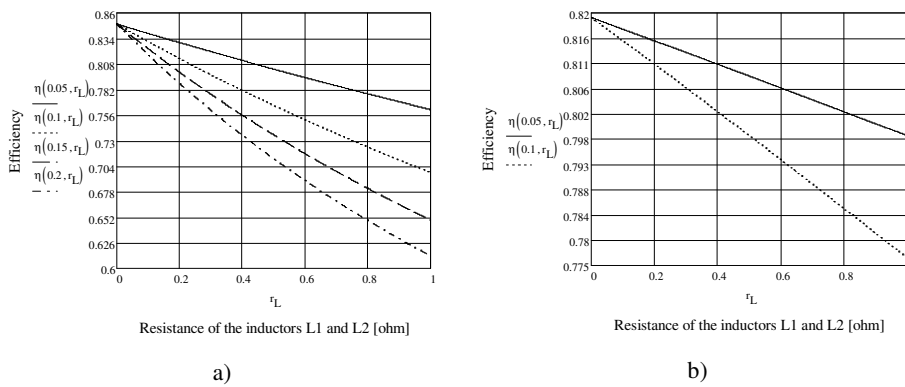

**Fig.5.** Impact of the inductor resistance on the efficiency: a) normal mode; b) voltage boost mode.

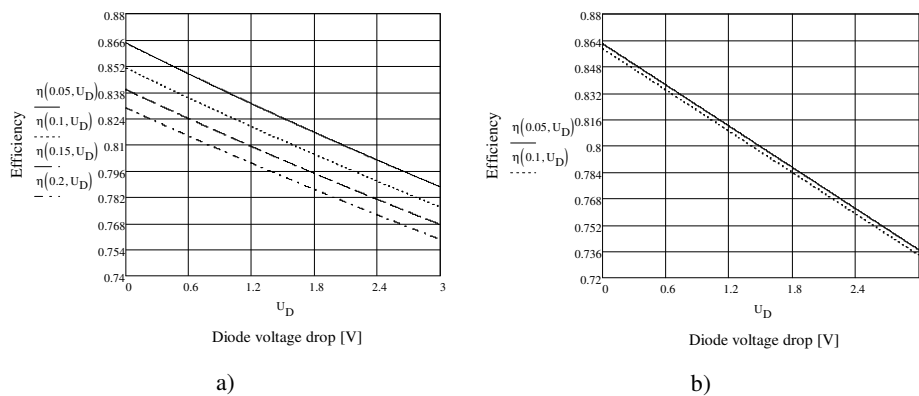

Fig.6. Impact of the diode voltage drop on the efficiency: a) normal mode; b) voltage boost mode.

## 6 Experimental Results

The experimental results were carried out on the experimental prototype for the normal and voltage boost modes. The IGBT switches IRG7Ph42ud1pbf were used in the DAB. For the normal mode, the phase shift angle of  $\varphi = 10^\circ$  was used. For the voltage boost mode the gate signals with duty cycle  $D = 0.6$  were applied on the switches, that resulted in the shoot-through duty cycle  $D_S = 0.1$ . The phase shift in this case was maximal  $D_\varphi = D_S$ . The voltage and current measurement results for  $P = 250 \text{ W}$  are shown in Fig. 7. According to the parameters listed in Table 1. and the dependency shown in chapter 5, the estimated efficiency of the converter in both modes is roughly 83 %. Measurements have shown 78 % efficiency of the converter with given parameters. Obviously the measured efficiency is lower since the switching losses and core losses were not taken into account in the analysis. Also on the background of the low input voltage the  $U_{CE}$  has relatively bigger impact than for the higher voltages.

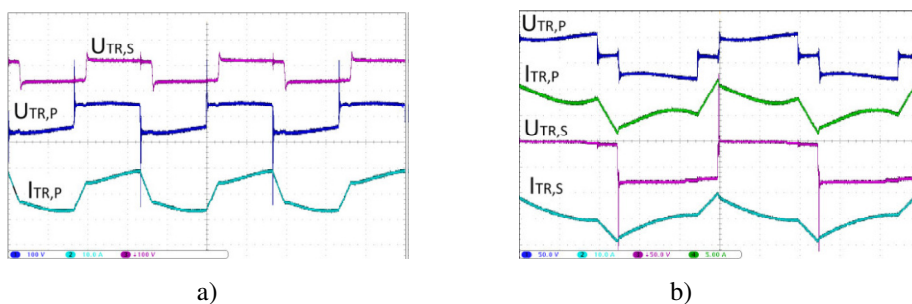

Fig.7. Waveforms showing input voltage ( $U_{LV}$ ) and current ( $I_{LV}$ ) as well as output voltage ( $U_{HV}$ ) and current ( $I_{HV}$ ) in normal mode (a) and voltage boost mode (b).



## 7 Conclusion

The paper presented a loss analysis of the new qZS based DAB. The mathematical loss models of the converter were derived for normal operating mode, using conventional DAB control, and voltage boost mode, when the shoot-through switching state was used to step up the voltage on the DC link. The mathematical models were analyzed for different circuit parameters. The results have shown that  $U_{CE}$  and  $U_D$  have significant impact on the efficiency of the converter. For this reason the components with as low values should be selected, for example MOSFET switches if the converter operates with low voltage. Moreover, the simulation results verified the decrease of the current stress on the switches. The estimated efficiency for the selected circuit parameters was roughly 83%. The experimental results in the nominal operating point showed the 78% efficiency, which is smaller in comparison with obtained efficiency, since the analysis did not consider the switching and core losses.

**Acknowledgment.** This research and work has been supported by Estonian Ministry of Education and Research (Project SF0140016s11) and Estonian Science Foundation (Grant ETF8687).

## References

1. Beldjajev, V.; Roasto, I.; Lehtla T.; , "Intelligent Transformer: Possibilities and Challenges" RTU, 2011. , pp . 14 Okt 2011
2. Heinemann, L.; Mauthe, G.; , "The universal power electronics based distribution transformer, an unified approach," *Power Electronics Specialists Conference, 2001. PESC. 2001 IEEE 32nd Annual* , vol.2, no., pp.504-509 vol.2, 2001.
3. Roasto, I.; Romero-Cadaval, E.; Martins, J.; Smolenski, R.; , " State of the Art of Active Power Electronic Transformers for Smart Grids," *Industrial Electronics, 2012. IECON '12. 38th Annual Conference of IEEE* , 25-28 Okt. 2012
4. Jianhua Zhang; Wenye Wang; Bhattacharya, S.; , "Architecture of solid state transformer-based energy router and models of energy traffic," *Innovative Smart Grid Technologies (ISGT), 2012 IEEE PES* , vol., no., pp.1-8, 16-20 Jan. 2012
5. Vinnikov, D.; Roasto, I.; Strzelecki, R.; Adamowicz, M.; , "Step-Up DC/DC Converters With Cascaded Quasi-Z-Source Network," *Industrial Electronics, IEEE Transactions on* , vol.59, no.10, pp.3727-3736, Oct. 2012
6. Krismer, Florian. Modeling and optimization of bidirectional dual active bridge DC-DC converter topologies. ETH(2010).
7. Vinnikov, D.; Roasto, I.; , "Impact of component losses on the voltage boost properties and efficiency of the qZS-converter family," *Compatibility and Power Electronics (CPE), 2011 7th International Conference-Workshop* , vol., no., pp.303-308, 1-3 June 2011
8. Mi, C.; Bai, H.; Wang, C.; Gargies, S.; , "Operation, design and control of dual H-bridge-based isolated bidirectional DC-DC converter," *Power Electronics, IET* , vol.1, no.4, pp.507-517, December 2008