



HAL
open science

An Advanced LMI-Based-LQR Design for Load Frequency Control of an Autonomous Hybrid Generation System

S. K. Pandey, S. R. Mohanty, N. Kishor, J. S. Catalão

► **To cite this version:**

S. K. Pandey, S. R. Mohanty, N. Kishor, J. S. Catalão. An Advanced LMI-Based-LQR Design for Load Frequency Control of an Autonomous Hybrid Generation System. 4th Doctoral Conference on Computing, Electrical and Industrial Systems (DoCEIS), Apr 2013, Costa de Caparica, Portugal. pp.371-381, <10.1007/978-3-642-37291-9_40>. <hal-01348775>

HAL Id: hal-01348775

<https://hal.science/hal-01348775v1>

Submitted on 25 Jul 2016

HAL is a multi-disciplinary open access archive for the deposit and dissemination of scientific research documents, whether they are published or not. The documents may come from teaching and research institutions in France or abroad, or from public or private research centers.

L'archive ouverte pluridisciplinaire **HAL**, est destinée au dépôt et à la diffusion de documents scientifiques de niveau recherche, publiés ou non, émanant des établissements d'enseignement et de recherche français ou étrangers, des laboratoires publics ou privés.



Distributed under a Creative Commons CC BY 4.0 - Attribution - International License

An Advanced LMI-based-LQR Design for Load Frequency Control of an Autonomous Hybrid Generation System

S.K. Pandey¹, S.R. Mohanty^{1,2}, N. Kishor^{1,3}, J.P.S. Catalão^{2,4}

¹ Motilal Nehru National Institute of Technology, Allahabad, India, skp1111.1969@rediffmail.com; soumyaigit@gmail.com

² University of Beira Interior, Covilhã, Portugal, catalao@ubi.pt

³ Aalto University, Finland, nand_research@yahoo.co.in

⁴ CIEEE, Instituto Superior Técnico, Tech. Univ. Lisbon, Portugal

Abstract. This paper proposes a load frequency control scheme for an autonomous hybrid generation system consisting of wind turbine generator (WTG), diesel engine generator (DEG), fuel cell (FC), aquaelectrolyzer (AE) and battery energy storage system (BESS). In wind power generation systems, operating conditions are changing continually due to wind speed and load changes, having an effect on system frequency. Therefore, a robust controller is required for load frequency control. The control scheme is based on Linear Matrix Inequality (LMI)-Linear Quadratic Regulator (LQR). The control optimization problem is obtained in terms of a system of LMI constraints and matrix equations that are simultaneously solved. The proposed load frequency control scheme with the advanced LMI-based-LQR (ALQR) design is applied for the autonomous hybrid generation system. The effectiveness and robustness of the proposed controller is demonstrated for different load and wind power perturbations. The results suggest superior performance of the proposed ALQR controller against an optimal output state feedback controller. The integrated control could be realized through the web by applying Internet of Things technologies within the future smart grid.

Keywords: Load frequency control, distribution generation, optimal control, linear matrix inequalities, Internet of Things.

1 Introduction

In remote areas around the world an autonomous hybrid generation system is useful to supply the demand of electrical energy. A hybrid power system consists of a combination of two or more power generation technologies to enhance their operating characteristics and efficiencies than that could be obtained from a single power source [1]. To meet increasing load demands for an isolated community, expansion of the distributed generation systems is required. The resulting power system may provide good quality service to the consumer load, which depends mostly on the type and action of the generation controller.

The aim of load frequency control (LFC) is to maintain the power balance in the system such that the frequency deviates from its nominal value within specified bounds and according to practically acceptable dynamic performance of the system.

Several controllers have been presented for LFC problems in order to achieve a better dynamic performance, where the most employed one is the conventional fixed gain controller like proportional-integral (PI) and proportional-integral-derivative (PID) controllers, because of their functional simplicity and simple structure, being widely used in industrial applications. However, their parameters are often tuned using experiences or trial and error methods and may no longer be suitable in all operating conditions. Different methods of tuning of PI/PID controllers are given in [2]. The use of optimal control theory to power systems has shown that an optimal load frequency controller can improve the dynamic stability of a power system. Calovic [3] used output feedback techniques to design a decentralized controller.

Usually a linear model around a nominal operating point is used in the load frequency controller design. However, power system components are inherently nonlinear, so the operating conditions of power systems are continuously changing. Accordingly, the real plant usually differs from the model. Therefore robustness becomes a main issue in the attempt to design a controller to satisfy the basic requirements for zero steady state and acceptable transient frequency deviations.

Various robust control approaches have been used in LFC, such as Riccati equation approach [4], H_∞ -control [5], μ -synthesis approach [6], robust pole assignment approach [7], Linear Matrix Inequality (LMI) based H_∞ -loop shaping control [8], loop shaping control [9] and inverse additive perturbation [10]. The LMI approach based LFC has been mostly applied in conventional power systems, being very less used yet in hybrid energy systems for LFC.

In this paper, the formulation of LFC problem is based on LMI-Linear Quadratic Regulator (LQR). The basics of LMI-based-LQR control scheme are illustrated in [11]. The control optimization problem is obtained in terms of a system of LMI constraints and matrix equations that are simultaneously solved. The proposed LFC scheme with the advanced LMI-based-LQR (ALQR) is applied for an autonomous hybrid generation system. Results show that the robustness of the proposed controller is much superior to that of the optimal output state feedback controller, called as simple closed-LQR (CLQR), for different load and wind power perturbations.

2 Relationship to Internet of Things

The smart grids are expected to spread the intelligence of the energy distribution and control system from some central core to many peripheral nodes, thus enabling more precise control and adaptation. The concept and objectives of such intelligent nodes are similar to those of the Internet of Things (IoT).

IoT means extending the web paradigm to the connection, monitoring, and control of the objects of everyday life. IoT technologies can provide a viable solution toward a web-enabled smart grid system [12].

The future developments of the IoT related to energy-aware systems and distributed decision will be especially relevant for autonomous hybrid generation systems, making their control ubiquitous. Decision makers will be able to base their actions on real-world, real-time data [13]. IoT will make it possible for future energy systems to be self-managing, self-sustaining and robust. Therefore, the IoT based infrastructure will be tightly coupled with the energy domain [14].

3 System Configuration and Description

The interconnected conventional power source and distributed generation (DG) system is shown in Fig. 1. The power-frequency balance is maintained by a proper control of the different power generation resources. In actual systems, WT, DEG, FC generator, AE and BESS are high order models and have nonlinearity. The controller design for higher order non-linear system would be complicated. Thus, the first order linearized model is taken into consideration for frequency control. The first order representation for the LFC is sufficient without sacrificing accuracy as the frequency control loop acts very fast.

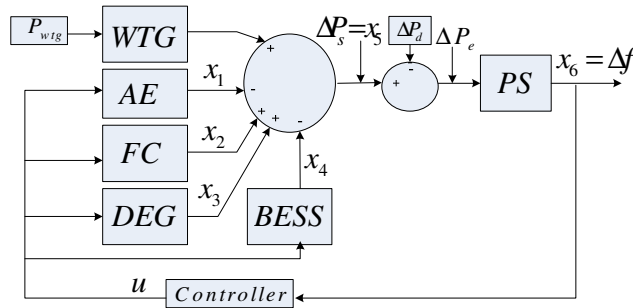

Fig. 1. Block diagram of the hybrid power system.

The generated power of the WTG depends upon the wind speed. The transfer function of the WTG is represented by a first-order lag [15], as:

$$G_{WTG}(s) = \frac{K_{wtg}}{1 + sT_{wtg}} \tag{1}$$

Part of the wind power generation is to be used by the AE for hydrogen production. The transfer function model of the AE [15] can be expressed by:

$$G_{AE} = \frac{K_{ae}}{1 + sT_{ae}} \tag{2}$$

The FC converts the chemical energy of the fuel (hydrogen) into electrical energy. The FC is represented by a first-order lag transfer function model [15], given as:

$$G_{FC}(s) = \frac{K_{fc}}{1 + sT_{fc}} \tag{3}$$

The DEG works autonomously to supply the deficit power to the hybrid system in order to meet the supply-demand balance condition. The DEG is modeled by a first-order transfer function [15], given by:

$$G_{DEG}(s) = \frac{K_{deg}}{1 + sT_{deg}} \tag{4}$$

The BESS can be utilized to provide additional damping to power system swings, improving both transient and dynamic stability. The transfer function model of BESS is expressed by first-order [15], as:

$$G_{BESS}(s) = \frac{K_{bess}}{1 + sT_{bess}} \quad (5)$$

The power balance is achieved by the equation:

$$\Delta P_e = \Delta P_s - \Delta P_d \quad (6)$$

where ΔP_e is the error in supply power and ΔP_d is the load change.

The transfer function for the system variation to p.u. deviation in power is expressed by:

$$G_{sys} = \frac{\Delta f}{\Delta P_e} = \frac{1}{K_{sys}(1 + sT_{sys})} = \frac{1}{D + sM} \quad (7)$$

where K_{sys} is the system frequency characteristic constant of the system and T_{sys} is gain of the system.

The parameters of proposed hybrid system [15] are given in Table 1.

Table 1. Parameters of the proposed hybrid system.

Components	Gains (p.u.)	Time constants (sec)
Wind turbine generator	$K_{WTG} = 1.0$	$T_{WTG} = 1.5$
Aqua-electrolizer	$K_{AE} = 0.002$	$T_{AE} = 0.5$
Fuel cell	$K_{FC} = 0.01$	$T_{FC} = 4.0$
Diesel generator	$K_{DEG} = 0.003$	$T_{DEG} = 2.0$
Battery energy storage system	$K_{BESS} = -0.003$	$T_{BESS} = 0.1$
Damping constant of the hybrid system	$D = 0.012$	
Inertia constant of the hybrid system	$M = 0.2$	

4 LMI Representation of LQR

For a linear and robust control framework, the following linear time invariant multiple systems are considered:

$$\dot{x} = Ax + By + \Gamma w \quad (8)$$

$$y = Cx + Du + \eta \quad (9)$$

where A is a $n \times n$ state matrix, B is a $n \times p$ control matrix, Γ is a $m \times n$ output matrix, x is a $n \times 1$ state vector, u is $p \times 1$ control signal vector, y is a $m \times 1$ output vector, w is a noisy signal vector, assumed to be white.

Using the H_2 representation of the LQR problem [16], [17], we obtain the state-feedback gain matrix k that minimizes the following cost function in terms of output \tilde{y} as:

$$J = \min_{(k)} \{ E [\tilde{y}^T \tilde{y}] \} \quad (10)$$

subject to:

$$(A - Bk)^T P + P(A - Bk) + Q + k^T R k < 0 \tag{11}$$

where $P \in \Re^{n \times n} > 0$ is a common Lyapunov matrix.

The advanced LMI representation of H_2 LQR optimization problem can be obtained as the minimization of the cost function:

$$\tilde{J} = \min_{(\Lambda, Y, \hat{X})} [tr(QY + \hat{X}) - tr(N\Lambda + \Lambda^T N^T)] \tag{12}$$

subject to:

$$\hat{X} - (R^{1/2} \Lambda) Y^{-1} (\Lambda^{-1} R^{1/2}) > 0 = \begin{bmatrix} \hat{X} & R^{1/2} \Lambda \\ \Lambda^T R^{1/2} & Y \end{bmatrix} > 0 \tag{13}$$

$$\begin{bmatrix} (AY + Y^T A^T - B\Lambda - \Lambda^T B^T) & \Lambda^T & Y^T \\ \Lambda & -R^{-1} & 0 \\ Y & 0 & -Q^{-1} \end{bmatrix} < 0 \tag{14}$$

5 Control Formulation

Consider a linear time invariant model for the proposed hybrid power system with the following state space model:

$$\dot{x} = Ax + Bu + \Gamma d \tag{15}$$

$$y = Cx \tag{16}$$

$$u = -Kx \tag{17}$$

where A is system matrix, B is the input distribution matrix, Γ is the disturbance distribution matrix, C is the control output distribution matrix, x is the state vector, u is the control vector and d is the disturbance vector consisting of load change and wind power change.

The state and other variables of the proposed hybrid power system are $x = [x_1 \ x_2 \ x_3 \ x_4 \ x_5 \ x_6]^T$ and $y = x_6$. The design of the optimal controller based on output feedback control approach is discussed in detail in [3].

6 Results

6.1 Load Changes

The proposed controllers were applied to the hybrid power system shown in Fig. 1. The parameters of the hybrid power system are considered to be the same as in [15]. In this section, the performance of the ALQR controller is compared with the CLQR controller for different load scenarios.

Case 1: Step load change

In this case, a load disturbance of $\Delta P_d = 0.01 pu$ and wind power variation of $\Delta P_{wig} = 0.5 pu$ is applied to the system.

The frequency deviation is shown in Fig. 2 for ALQR and CLQR. It can be seen that using the ALQR controller the frequency deviation of the system is quickly driven back to zero with a smaller overshoot.

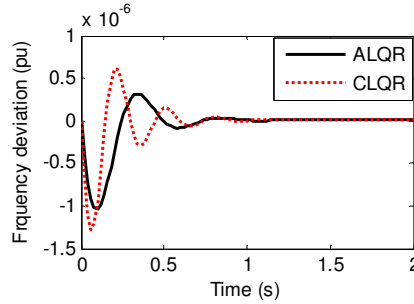

Fig. 2. Frequency deviation for case 1.

Fig. 3(a) and 3(b) show the frequency deviation with different load disturbances for ALQR and CLQR controllers, respectively.

It can be seen that the robustness of the ALQR controller is superior comparatively to the CLQR controller.

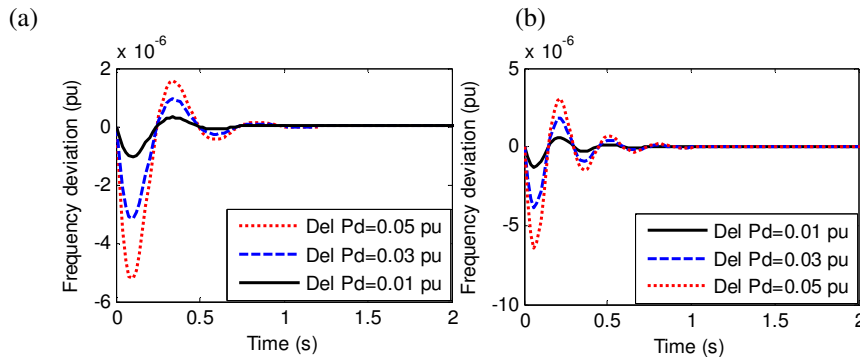

Fig. 3. Frequency deviation for ALQR (a) and CLQR (b) with load disturbances.

Case 2: Random step load change

In this case, it is considered that the load disturbance varies with time in step form, as shown in Fig. 4, and $P_{wg} = 0.5 pu$ is also applied to the system.

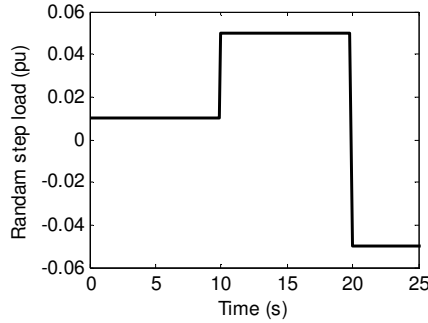

Fig. 4. Random load change in step form.

The frequency deviation is shown in Fig. 5(a). The control effect of ALQR is better than CLQR. For clarity, Figs. 5(b) to 5(d) show the frequency deviation for the random step load change considering different time durations.

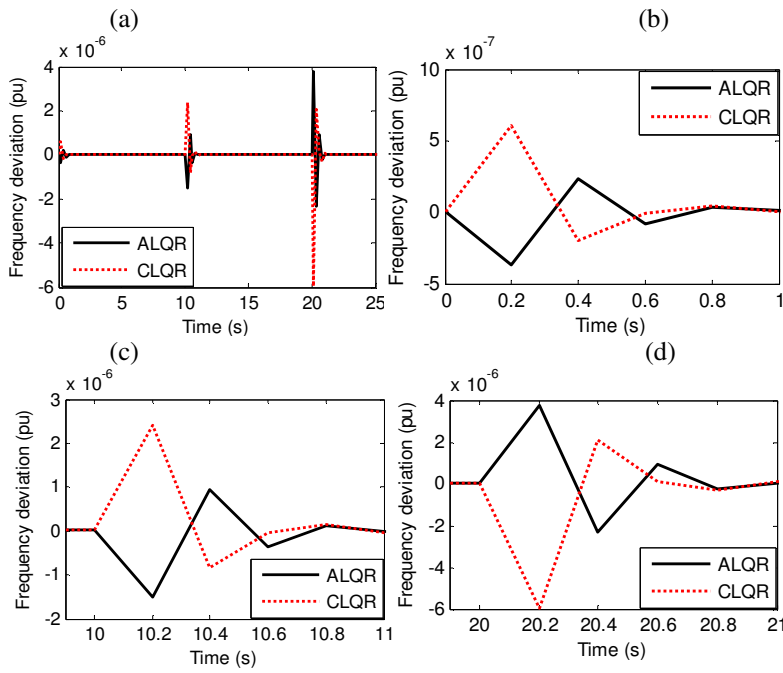

Fig. 5. Frequency deviation for case 2 (a); frequency deviation for case 2 from t=0s to 1s (b); frequency deviation for case 2 from t=9s to 11s (c); frequency deviation for case 2 from t=19s to 21s.

Case 3: Random Load change

In this case, the random load change shown in Fig. 6 (a) is applied to the system, also with $P_{wig} = 0.5 pu$.

Fig. 6 (b) shows the response of frequency deviation under the random load change. It can be seen that the response with the ALQRcontroller is better than with CLQR.

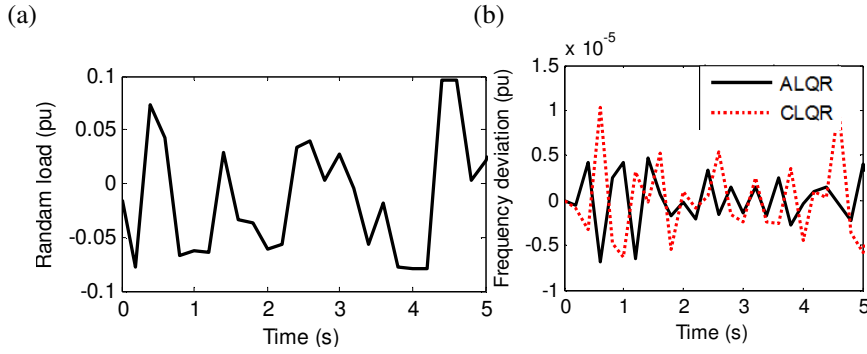

Fig. 6. Random load change (a) frequency deviation for case 3 (b).

6.2 Random Wind Power Input

In this case, the random wind power input shown in Fig. 7(a) is applied to the system, alongside a load disturbance of $\Delta P_d = 0.01 pu$. Fig. 7(b) shows the frequency deviation for this case.

It can be seen that the response with the ALQRcontroller is again better than with CLQR.

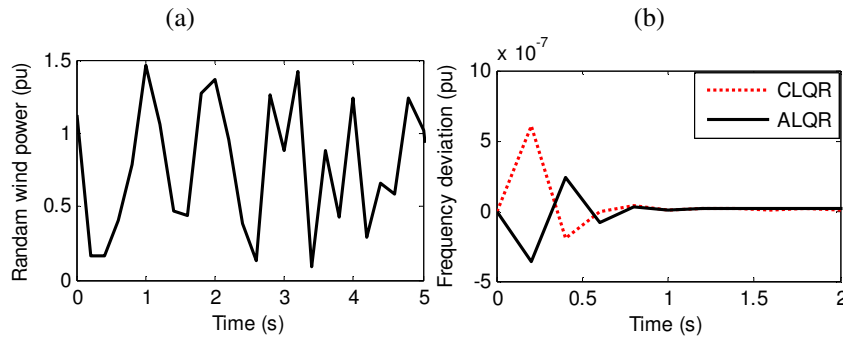

Fig. 7. Random wind power input signal (a); frequency deviation with random wind power from $t=0s$ to $2s$ (b).

6.3 Robustness with Parameter Variations

Any controller designed for fixed plant parameter or tuned to nominal conditions may not perform satisfactorily on variation in their values. Also, in some cases, the value of these parameters is not accurately determined, either experimentally or mathematically. Thus, they are said to belong in an interval range.

A controller design is desired to be robust enough against parameter variations of the system model.

The robustness of the CLQR and ALQR controllers is evaluated by computation of a quantitative performance index, integral square error (ISE) under variation in system parameters.

In order to be realistic, the simulations were done for a limited time. Moreover, the integral values are multiplied by some suitable constants, so that the outcomes of the performance indices attain comparable values.

This index is modified as:

$$\Delta f_{ISE} = 10^5 \int_0^{25} (\Delta f)^2 dt \tag{18}$$

The values of ISE against parameter changes for the CLQR and ALQR controllers are shown in Fig. 8.

As can be observed with the parameters change over a large percentage range, the corresponding value of ISE varies significantly and increasingly in the case of the CLQR controller. However, the value of ISE with ALQR controller is much lower and change slightly.

These results confirm the high robustness of the ALQR controller against the random load change, and system parameter variations.

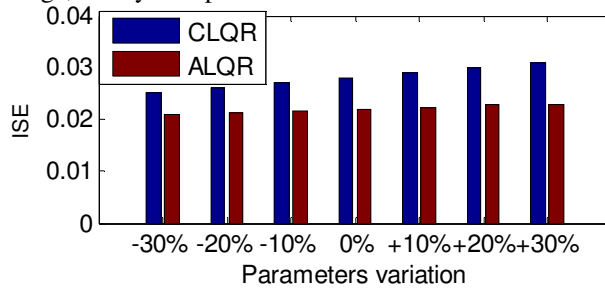

Fig.8. Robustness evaluation by computing performance index ISE for all parameters variation.

7 Conclusions

This paper presented a robust control design technique based on LMI-LQR approach. The proposed ALQR controller is applied for an autonomous hybrid generation system. A comparative study between the proposed ALQR controller and optimal output state feedback controller, called as CLQR controller, is provided in study. Simulation results using Matlab 2009b version demonstrated that the proposed controller is capable to guarantee robust stability and robust performance, such as precise reference frequency tracking and disturbance attenuation. The results suggest superior performance of ALQR against optimal output state feedback controller, in the case of load changes, parameter variations and random wind power input. The incorporation of IoT technologies will foster the web-enabled smart grid concept, where all devices will be interconnected and able to interact through the internet, leading to the deployment of a ubiquitous energy control system.

Acknowledgment. This work was supported by FEDER funds (European Union) through the Operational Program for Competitiveness Factors—COMPETE, and by Portuguese funds through the Fundação para a Ciência e a Tecnologia (FCT), under Project FCOMP-01-0124-FEDER-020282 (Ref. FCT PTDC/EEAEEL/118519/2010).

References

1. Ahmad, N.A., Miyarake, M., Al-Othman, A.K.: Power fluctuation suppression of stand-alone hybrid generation combining solar photovoltaic/wind turbine and fuel cell systems, *Energy Conversion Manage* 49, 2711-2119 (2008).
2. Cominos, P., Munro, N.: PID controllers: Recent tuning methods and design to specification, *IEE Proc. Control Theory Appl* 149, 46-53 (2002).
3. Calovic, M.S.: Automatic generation control: Decentralized area-wise optimal solution, *Electric Power Systems Research* 7, 115-139 (1984).
4. Wang, Y., Zhou, R., Wen, C.: Robust load-frequency controller design for power systems, *IEE Proc. Part C* 140, 11-16 (1993).
5. Rerkpreedapong, D., Hasanovic, A., Feliachi, A.: Robust load frequency control using genetic algorithms and linear matrix inequalities, *IEEE Trans. on Power Systems* 18, 855-861 (2003).
6. Wang, Z.Q., Sznaier, M.: Robust control design for load frequency control using μ -synthesis, *Southco/94, Conference Record, Orlando, FL, USA*, 186-190 (1994).
7. Azzam, M.: Robust automatic generation control, *Energy Conversion and Management*, 40, 1413-1421 (1999).
8. Patra, S., Sen, S., Ray, G.: Design of static H_∞ loop shaping controller in four-block framework using LMI approach, *Automatica* 44, 2214-2120 (2008).
9. Majumder, R., Chaudhuri, B., El-Zobaidi, H., Pal, B.C., Jaimoukha, I.M.: LMI approach to normalized H_∞ loop-shaping design of power system damping controllers, *IEEE Proceedings-Generation, Transmission and Distribution* 152, 952-960, (2005).
10. Cuk Supriyadi, A.N., Ngamroo, I., Kunakorn, A., Dechanupaprittha, S., Watanabe, M., Mitani, Y., Hashiguchi, T., Goda T.: Inverse additive perturbation-based optimization of robust PSS in an interconnected power system with wind farms, *Proceedings of SICE Annual Conference 2008, Tokyo, Japan*, 237-240 (2008).
11. Ko, Hee-Sang, Jatskevich, Juri, Dumont, Guy, Yoon, Gi-Gap: An advanced LMI-based-LQR design for voltage control of grid-connected wind farm, *Electric Power Systems Research* 78, 539-546 (2008).
12. Bui, N., Castellani, A.P., Casari, P., Zorzi, M.: The internet of energy: a web-enabled smart grid system, *IEEE Network*, 39-45 (2012).
13. Karnouskos, S., Terzidis, O.: Towards an information infrastructure for the future Internet of energy, *ITG-GI Conference, Germany* (2007).
14. Yu, X., Cecati, C., Dillon T., Simões, M.G.: The new frontier of smart grids, *Industrial Electronics Magazine*, 49-63 (2011).
15. Das, D.C., Roy, A.K., Sinha, N.: GA based frequency controller for solar thermal-diesel-wind hybrid energy generation/energy storage system, *Electrical Power and Energy Systems* 43, 262-279 (2012).
16. Anderson, B.D.O., Moor, J.B.: *Optimal Control: Linear Quadratic Methods*, Prentice-Hall, New Jersey (1998).
17. Boyd, S., Ghaoui, L.E., Feron, E., Balakrishnan, V.: *Linear Matrix Inequalities in system and control theory*, *SIAM Studies in Applied Mathematics* 15, Philadelphia (1994).