



**HAL**  
open science

## The rotating normal form is regular

Jean Fromentin

► **To cite this version:**

| Jean Fromentin. The rotating normal form is regular. 2016. hal-01337636v2

**HAL Id: hal-01337636**

**<https://hal.science/hal-01337636v2>**

Preprint submitted on 29 Jun 2016 (v2), last revised 11 Oct 2024 (v4)

**HAL** is a multi-disciplinary open access archive for the deposit and dissemination of scientific research documents, whether they are published or not. The documents may come from teaching and research institutions in France or abroad, or from public or private research centers.

L'archive ouverte pluridisciplinaire **HAL**, est destinée au dépôt et à la diffusion de documents scientifiques de niveau recherche, publiés ou non, émanant des établissements d'enseignement et de recherche français ou étrangers, des laboratoires publics ou privés.

# THE ROTATING NORMAL FORM IS REGULAR

JEAN FROMENTIN

ABSTRACT. Defined on Birman–Ko–Lee monoids, the rotating normal form has strong connections with the Dehornoy’s braid ordering. It can be seen as a process for selecting between all the representative words of a Birman–Ko–Lee braid a particular one, called *rotating* word. In this paper we construct, for all  $n \geq 2$ , a finite state automaton which recognizes the rotating words on  $n$  strands. As a consequence the language of rotating words on  $n$  strands is proved to be regular for any  $n \geq 2$ .

## 1. INTRODUCTION

Originally, the group  $B_n$  of  $n$ -strand braids was defined as the group of isotopy classes of  $n$ -strand geometric braids. An algebraic presentation of  $B_n$  was given by E. Artin in [1]

$$\left\langle \sigma_1, \dots, \sigma_{n-1} \mid \begin{array}{l} \sigma_i \sigma_j = \sigma_j \sigma_i \quad \text{for } |i - j| \geq 2 \\ \sigma_i \sigma_j \sigma_i = \sigma_j \sigma_i \sigma_j \quad \text{for } |i - j| = 1 \end{array} \right\rangle. \quad (1)$$

An  $n$ -strand braid is an equivalence class consisting of (infinitely many) words in the letters  $\sigma_i^{\pm 1}$ . The standard correspondence between elements of the presented group  $B_n$  and geometric braids consists in using  $\sigma_i$  as a code for the geometric braid where only the  $i$ th and the  $(i + 1)$ st strands cross, with the strands originally at position  $(i + 1)$  in front of the other.

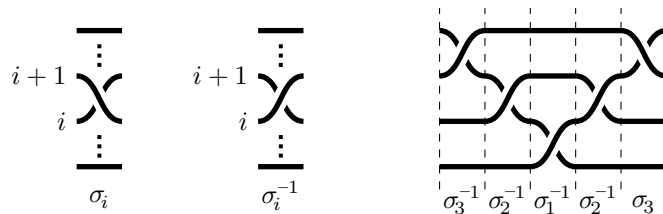

FIGURE 1. Interpretation of a word in the letters  $\sigma_i^{\pm 1}$  as a geometric braid diagram.

---

2010 *Mathematics Subject Classification.* 20F36, 20M35, 20F10.

*Key words and phrases.* dual braid monoid, rotating normal form, regular language, automata.

In 1998, J.S. Birman, K.H. Ko, and S.J. Lee [3] introduced and investigated for each  $n$  a submonoid  $B_n^{+*}$  of  $B_n$ , which is known as the *Birman–Ko–Lee monoid*. The name “*dual braid monoid*” was subsequently proposed because several numerical parameters obtain symmetric values when they are evaluated on the positive braid monoid  $B_n^+$  and on  $B_n^{+*}$ , a correspondence that was extended to the more general context of Artin–Tits groups by D. Bessis [2] in 2003. The dual braid monoid  $B_n^{+*}$  is the submonoid of  $B_n$  generated by the braids  $a_{i,j}$  with  $1 \leq i < j \leq n$ , where  $a_{i,j}$  is defined by  $a_{i,j} = \sigma_i \dots \sigma_{j-1} \sigma_j \sigma_{j-1}^{-1} \dots \sigma_i^{-1}$ . In geometrical terms, the braid  $a_{i,j}$  corresponds to a crossing of the  $i$ th and  $j$ th strands, both passing behind the (possible) intermediate strands.

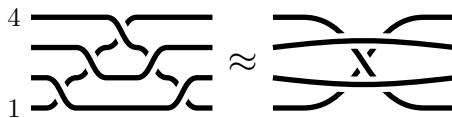

FIGURE 2. In the geometric braid  $a_{1,4}$ , the strands 1 and 4 cross under the strands 2 and 3.

By definition,  $\sigma_i$  equals  $a_{i,i+1}$  and, therefore, the positive braid monoid  $B_n^+$  is included in the monoid  $B_n^{+*}$ , a proper inclusion for  $n \geq 3$  since the braid  $a_{1,3}$  does not belong to the monoid  $B_3^+$ .

We denote by  $A_n$  the set  $\{a_{p,q} \mid 1 \leq p < q \leq n\}$ . The following presentation of the monoid  $B_n^{+*}$  is given in [3].

**Proposition 1.1.** *The monoid  $B_n^{+*}$  is presented by generators  $A_n$  and relations*

$$a_{p,q}a_{r,s} = a_{r,s}a_{p,q} \quad \text{for } [p,q] \text{ and } [r,s] \text{ disjoint or nested,} \quad (2)$$

$$a_{p,q}a_{q,r} = a_{q,r}a_{p,r} = a_{p,r}a_{p,q} \quad \text{for } 1 \leq p < q < r \leq n. \quad (3)$$

The interval  $[p,q]$  is said to be *nested* in  $[r,s]$  if the relation  $r < p < q < s$  holds.

Since [2] and [3] it is known that the dual braid monoid  $B_n^{+*}$  admits a Garside structure whose simple elements are in bijection with the non-crossing partitions of  $n$ . In particular, there exists a normal form associated with this Garside structure, the so-called greedy normal form.

The rotating normal form is another normal form on  $B_n^{+*}$ , it was introduced in [8, 9]. Roughly speaking, for every braid  $\beta \in B_n^{+*}$  the rotating normal form picks up a unique representative word on the letters  $A_n$  among all of these representing  $\beta$ . It can be seen as a map  $r_n$  from the dual braid monoid  $B_n^{+*}$  to the set of words  $A_n^*$ . The language of all  $n$ -rotating words, denoted by  $R_n$  is then the image of  $B_n^{+*}$  under the map  $r_n$ .

The aim of this paper is to construct for all  $n \geq 2$  an explicit finite state automaton which recognizes the language  $R_n$ . As a consequence we obtain that the language  $R_n$  of  $n$ -rotating words is regular.

The paper is divided as follow. In section 2 we recall briefly the construction of the rotating normal form and its useful already known properties. In third section we describe the left reversing process on dual braid monoids. In section 4 we give a syntactical characterization of  $n$ -rotating normal words. In fifth section we construct, for each  $n \geq 2$ , a finite state automaton which recognizes the language  $R_n$  of  $n$ -rotating normal words.

## 2. THE ROTATING NORMAL FORM

The main ingredient to define the rotating normal form is the Garside automorphism  $\phi_n$  of  $B_n^{+*}$  defined by  $\phi_n(\beta) = \delta_n \beta \delta_n^{-1}$  where  $\delta_n = a_{1,2} a_{2,3} \dots a_{n-1,n}$  is the Garside braid of  $B_n^{+*}$ . In terms of Birman–Ko–Lee generators, the map  $\phi_n$  can be defined by

$$\phi_n(a_{p,q}) = \begin{cases} a_{p+1,q+1} & \text{for } q \leq n-1, \\ a_{1,p+1} & \text{for } q = n. \end{cases} \quad (4)$$

Geometrically,  $\phi_n$  should be viewed as a rotation, which makes sense provided braid diagrams are drawn on a cylinder rather than on a plane rectangle.

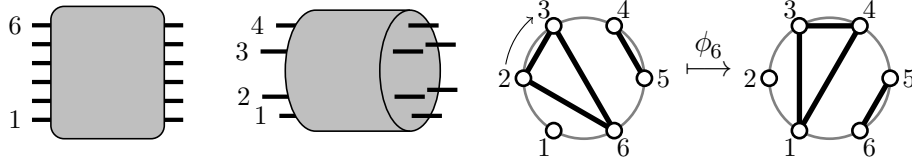

FIGURE 3. Rolling up the usual braid diagram helps us to visualize the symmetries of the braids  $a_{p,q}$ . On the resulting cylinder,  $a_{p,q}$  naturally corresponds to the chord connecting vertices  $p$  and  $q$ . With this representation,  $\phi_n$  acts as a clockwise rotation of the marked circles by  $2\pi/n$ .

For  $\beta$  and  $\gamma$  in  $B_n^{+*}$ , we say that  $\gamma$  is a *right-divisor* of  $\beta$ , if there exists a dual braid  $\beta'$  of  $B_n^{+*}$  satisfying  $\beta = \beta' \gamma$ .

**Definition 2.1.** For  $n \geq 3$  and  $\beta$  a braid of  $B_n^{+*}$ , the maximal braid  $\beta_1$  lying in  $B_{n-1}^{+*}$  that right divides the braid  $\beta$  is called the  $B_{n-1}^{+*}$ -tail of  $\beta$ .

Using basic Garside properties of the monoid  $B_n^{+*}$  we obtain the following result (Proposition 2.5 of [9]) which allow us to express each braid of  $B_n^{+*}$  as a unique finite sequence of braids lying in  $B_{n-1}^{+*}$ .

**Proposition 2.2.** Assume  $n \geq 3$ . For each nontrivial braid  $\beta$  of  $B_n^{+*}$  there exists a unique sequence  $(\beta_b, \dots, \beta_1)$  of braids of  $B_{n-1}^{+*}$  satisfying  $\beta_b \neq 1$  and

$$\beta = \phi_n^{b-1}(\beta_b) \cdot \dots \cdot \phi_n(\beta_2) \cdot \beta_1, \quad (5)$$

for each  $k \geq 1$ , the  $B_{n-1}^{+*}$ -tail of  $\phi_n^{b-k}(\beta_b) \cdot \dots \cdot \phi_n(\beta_{k+1})$  is trivial. (6)

Under the above hypotheses, the sequence  $(\beta_b, \dots, \beta_1)$  is called the  $\phi_n$ -splitting of the braid  $\beta$ . It is shown in [9] that Condition (6) can be replaced by

$$\text{for each } k \leq 1, \beta_k \text{ is the } B_{n-1}^{+*}\text{-tail of } \phi_n^{b-k}(\beta_b) \cdot \dots \cdot \phi_n(\beta_{k-1}) \cdot \beta_k. \quad (7)$$

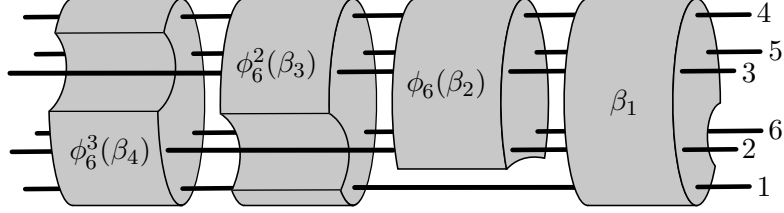

FIGURE 4. The  $\phi_6$ -splitting of a braid of  $B_6^{+*}$ . Starting from the right, we extract the maximal right-divisor that keeps the sixth strand unbraided, then extract the maximal right-divisor that keeps the first strand unbraided, etc.

**Example 2.3.** Consider the braid  $\beta = a_{1,2}a_{2,3}a_{1,2}a_{2,3}$  of  $B_3^{+*}$ . Using relations (3) on the underlined factors we obtain

$$\beta = a_{1,2}a_{2,3}\underline{a_{1,2}a_{2,3}} = a_{1,2}\underline{a_{2,3}a_{1,3}}a_{1,2} = a_{1,2}a_{1,3}a_{1,2}a_{1,2}$$

We decompose  $\beta$  as  $\phi_3(\gamma_1) \cdot \beta_1$  with  $\gamma_1 = \phi_3^{-1}(a_{1,2}a_{1,3}) = a_{1,3}a_{2,3}$  and  $\beta_1 = a_{1,2}a_{1,2}$ . The braid  $\phi_3(\gamma_1) = a_{1,2}a_{2,3}$  is exactly the one of (6) for  $n = 3$  and  $k = 1$ . As the word  $a_{1,3}a_{2,3}$  is alone in its equivalence class the braid  $\phi_3(\gamma_1)$  is not right divisible by  $a_{1,2}$  and so its  $B_2^{+*}$ -tail is trivial. Considering  $\gamma_1$  instead of  $\beta$  we obtain  $\gamma_1 = \phi_3(\gamma_2) \cdot \beta_2$  with  $\gamma_2 = \phi_3^{-1}(a_{1,3}a_{2,3}) = a_{2,3}a_{1,2}$  and  $\beta_2 = 1$ . The braid  $\phi_3(\gamma_2) = a_{1,3}a_{2,3}$  is the braid of (6) for  $n = 3$  and  $k = 2$  and it is always alone in its equivalence class, implying that its  $B_2^{+*}$ -tail is trivial. We express  $\gamma_2$  as  $\phi_3(\gamma_3) \cdot \beta_3$  with  $\gamma_3 = \phi_3^{-1}(a_{2,3}) = a_{1,2}$  and  $\beta_3 = a_{1,2}$ . Since  $\gamma_3$  equals  $a_{1,2}$  we obtain  $\gamma_4 = 1$  and  $\beta_4 = a_{1,2}$ . We conclude that the  $\phi_3$ -splitting of  $\beta$  is  $(a_{1,2}, a_{1,2}, 1, a_{1,2}^2)$ .

Before giving the definition of the rotating normal we fix some definitions about words.

**Definition 2.4.** A word on the alphabet  $A_n$  is an  $A_n$ -word. A word on the alphabet  $A_n^\pm = A_n \sqcup A_n^{-1}$  is an  $A_n^\pm$ -word. The braid represented by the  $A_n^\pm$ -word  $w$  is denoted by  $\overline{w}$ . For  $w, w'$  two  $A_n^\pm$ -word, we say that  $w$  is equivalent to  $w'$ , denoted by  $w \equiv w'$  if  $\overline{w} = \overline{w'}$  holds. The empty word is denoted by  $\varepsilon$ .

The  $n$ -rotating normal form is an injective map  $r_n$  from  $B_n^{+*}$  to the set of  $A_n$ -words defined inductively using the  $\phi_n$ -splitting.

**Definition 2.5.** For  $\beta \in B_2^{+*}$ , we define  $r_2(\beta)$  to be the unique word  $a_{1,2}^k$  representing  $\beta$ . The rotating normal form of a braid  $\beta \in B_n^{+*}$  with  $n \geq 3$  is

$$r_n(\beta) = \phi_n^{b-1}(r_{n-1}(\beta_b)) \cdot \dots \cdot \phi_n(r_{n-1}(\beta_2)) \cdot r_{n-1}(\beta_1),$$

where  $(\beta_b, \dots, \beta_1)$  is the  $\phi_n$ -splitting of  $\beta$ . A word  $w$  is said to be  $n$ -rotating if it is the  $n$ -rotating normal form of a braid of  $B_n^{+*}$ .

As the  $n$ -rotating normal form of a braid of  $B_{n-1}^{+*}$  is equal to its  $(n-1)$ -rotating normal form we can talk without ambiguities of the *rotating normal form* about a dual braid.

**Example 2.6.** We reconsider the braid  $\beta$  of Example 2.3. We know that the  $\phi_3$ -splitting of  $\beta$  is  $(a_{1,2}, a_{1,2}, 1, a_{1,2}^2)$ . Since  $r_2(1) = \varepsilon$ ,  $r_2(a_{1,2}) = a_{1,2}$  and  $r_2(a_{1,2}^2) = a_{1,2}^2$  we obtain

$$r_3(\beta) = \phi_3^3(a_{1,2}) \cdot \phi_3^2(a_{1,2}) \cdot \phi_3(\varepsilon) \cdot a_{1,2}^2 = a_{1,2}a_{1,3}a_{1,2}a_{1,2}.$$

Some properties of the rotating normal form have been established in [9]. Connections, established in [8] and [9], between the rotating normal form and the braid's ordering introduced by P. Dehornoy are based on these properties.

We finish this section with some already known or immediate properties about  $\phi_n$ -splittings and  $n$ -rotating words.

**Definition 2.7.** For every nonempty word  $w$ , the last letter of  $w$  is denoted by  $w^\#$ . For each nontrivial braid  $\beta$  in  $B_n^{+*}$ , we define the *last letter* of  $\beta$ , denoted  $\beta^\#$ , to be the last letter in the rotating normal form of  $\beta$ .

**Lemma 2.8** (Lemma 3.2 of [9]). *Assume  $n \geq 3$  and let  $(\beta_b, \dots, \beta_1)$  be a  $\phi_n$ -splitting*

- (i) *For  $k \geq 2$ , the letter  $\beta_k^\#$  is of type  $a_{\dots, n-1}$  unless  $\beta_k = 1$ .*
- (ii) *For  $k \geq 3$  and  $k = b$ , we have  $\beta_k \neq 1$ .*

The fact that  $\beta_b$  is not trivial is a direct consequence of the definition of  $\phi_n$ -splitting. As, for  $k \geq 2$ , the braid  $\beta' = \phi_n(\beta_{k+1}^\#)\beta_k$  is a right-divisor of  $\phi_n^{b-k}(\beta_b) \cdot \dots \cdot \beta_k$ , it must satisfy some properties. In particular, if  $\beta_{k+1}^\# = a_{p-1, n-1}$  holds then the  $B_{n-1}^{+*}$ -tail of  $\phi_n(a_{p,n}\beta_k)$  is trivial by (6).

**Definition 2.9.** We say that a letter  $a_{r,s}$  is an  $a_{p,n}$ -barrier if  $1 \leq r < p < s \leq n-1$  holds.

There exist no  $a_{p,n}$ -barrier with  $n \leq 3$  and the only  $a_{p,4}$ -barrier is  $a_{1,3}$ , which is an  $a_{2,4}$ -barrier. By definition, if the letter  $x$  is an  $a_{p,n}$ -barrier, then in the presentation of  $B_n^{+*}$  there exists no relation of the form  $a_{p,n} \cdot x = y \cdot a_{p,n}$  allowing one to push the letter  $a_{p,n}$  to the right through the letter  $x$ : so, in some sense,  $x$  acts as a barrier.

**Lemma 2.10** (Lemma 3.4 of [9]). *Assume that  $n \geq 3$ ,  $\beta$  is a braid of  $B_{n-1}^{+*}$  and the  $B_{n-1}^{+*}$ -tail of  $\phi_n(a_{p,n}\beta)$  is trivial for  $2 \leq p \leq n-2$ . Then the rotating normal form of  $\beta$  is not the empty word and it contains an  $a_{p,n}$ -barrier.*

**Lemma 2.11** (Lemma 3.5 of [9]). *Let  $(\beta_b, \dots, \beta_1)$  be a  $\phi_n$ -splitting of some braid of  $B_n^{+*}$  with  $n \geq 3$ . Then for each  $k \in [2, b-1]$  such that  $\beta_{k+1}^\#$  is not  $a_{n-2, n-1}$  (if any), the rotating normal form of  $\beta_k$  contains an  $\phi_n(\beta_{k+1}^\#)$ -barrier.*

### 3. LEFT REVERSING FOR DUAL BRAID MONOID

Left reversing process was introduced by P. Dehornoy in [5]. It is a powerful tool for the investigation of division properties in some monoids as stated by Proposition 3.6.

**Definition 3.1.** A monoid  $M$  defined by a presentation  $\langle S | R \rangle^+$  is *left complemented* if there exists a map  $f : S \times S \rightarrow S^*$  satisfying

$$R = \{f(x, y)x = f(y, x)y \mid (x, y) \in S^2\}$$

and if  $f(x, x) = \varepsilon$  holds for all  $x \in S$ .

As the relation  $x = x$  is always true for  $x \in S$  we say that  $M$  is left complemented even if  $x = x$  does not occur in  $R$  for  $x \in S$ .

The monoid  $B_3^{+*}$  with presentation of Proposition 1.1 is left complemented with respect to the map  $f$  given by

$$f(a_{1,2}, a_{2,3}) = f(a_{1,2}, a_{1,3}) = a_{1,3}$$

$$f(a_{2,3}, a_{1,2}) = f(a_{2,3}, a_{1,3}) = a_{1,2}$$

$$f(a_{1,3}, a_{1,2}) = f(a_{1,3}, a_{2,3}) = a_{2,3}$$

However the monoid  $B_4^{+*}$  with presentation of Proposition 1.1 is not left complemented. Indeed there is no relation of the form  $\dots a_{1,3} = \dots a_{2,4}$ . Hence the words  $f(a_{1,3}, a_{2,4})$  and  $f(a_{2,4}, a_{1,3})$  are not well defined.

In general for  $1 \leq p < r < q < s \leq n$ , the word  $f(a_{p,q}, a_{r,s})$  and  $f(a_{r,s}, a_{p,q})$  are not defined for the presentation of  $B_n^{+*}$  given in Proposition 1.1. In order to obtain a left complemented presentation of  $B_n^{+*}$  we must exhibit some extra relations from these given in Proposition 1.1.

By example, the relation  $a_{2,3}a_{1,4}a_{1,3} \equiv a_{3,4}a_{1,2}a_{2,4}$  holds and so we can consider  $f(a_{1,3}, a_{2,4})$  to be  $a_{2,3}a_{1,4}$ . However the relation  $a_{1,4}a_{2,3}a_{1,3} \equiv a_{3,4}a_{1,2}a_{2,4}$  is also satisfied and so  $f(a_{1,3}, a_{2,4}) = a_{2,3}a_{1,4}$  is an other valid choice.

**Lemma 3.2.** *For  $n \geq 2$ , the map  $f_n : A_n \times A_n \rightarrow A_n^*$  defined by*

$$f_n(a_{p,q}, a_{r,s}) = \begin{cases} \varepsilon & \text{for } a_{p,q} = a_{r,s}, \\ a_{p,s} & \text{for } q = r, \\ a_{s,q} & \text{for } p = r \text{ and } q > s, \\ a_{r,p} & \text{for } q = s \text{ and } p > r, \\ a_{r,q}a_{p,s} & \text{for } p < r < q < s, \\ a_{s,q}a_{r,p} & \text{for } r < p < s < q, \\ a_{r,s} & \text{otherwise.} \end{cases}$$

provides a structure of left complemented monoid to  $B_n^{+*}$ .

*Proof.* Direct computations using Proposition 1.1 establish  $f_n(x, y) \cdot x \equiv f_n(y, x) \cdot y$  for all  $(x, y) \in A_n^2$ .  $\square$

Our choice for  $f_n(a_{p,q}, a_{r,s})$  with  $p < r < q < s$  is well suited for the sequel and some proof would be invalid if we made an other one.

**Definition 3.3.** For  $w$  and  $w'$  two  $A_n^\pm$ -words, we say that  $w$  *left reverses in one step* to  $w'$ , denoted  $w \curvearrowright^1 w'$ , if we can obtain  $w'$  from  $w$  substituting a factor  $xy^{-1}$  (with  $x, y \in A_n$ ) by  $f_n(x, y)^{-1}f_n(y, x)$ . We say that  $w$  *left reverses* to  $w'$ , denoted by  $w \curvearrowright w'$ , if there exists a sequence  $w = w_1, \dots, w_\ell = w'$  of  $A_n^\pm$ -words such that  $w_k \curvearrowright^1 w_{k+1}$  for  $k \in [1, \ell - 1]$ .

**Example 3.4.** The word  $u = a_{1,2}a_{2,3}a_{1,2}a_{1,3}^{-1}$  left reverses to  $a_{2,3}a_{2,3}$  as the following left reversing sequence shows (left reversed factor are underlined)

$$a_{1,2}a_{2,3}\underline{a_{1,2}a_{1,3}^{-1}} \curvearrowright^1 a_{1,2}\underline{a_{2,3}a_{1,3}^{-1}}a_{2,3} \curvearrowright^1 \underline{a_{1,2}a_{1,2}^{-1}}a_{2,3}a_{2,3} \curvearrowright^1 a_{2,3}a_{2,3},$$

which is denoted by  $a_{1,2}a_{2,3}a_{1,2}a_{1,3}^{-1} \curvearrowright a_{2,3}a_{1,2}$ .

**Definition 3.5.** For  $w$  an  $A_n^\pm$ -word, we denote by  $D(w)$  and  $N(w)$  the unique  $A_n$ -word, if there exist, such that  $w \curvearrowright D(w)^{-1}N(w)$ . The word  $N(w)$  is the *left numerator* of  $w$  while the word  $D(w)$  is its *left denominator*.

Reconsidering Example 3.4, we obtain that the left denominator of  $u$  is  $D(u) = \varepsilon$  and that is left numerator its  $N(u) = a_{2,3}a_{2,3}$ .

A consequence of Example 8 and Proposition 3.5 of [6] based on [5] and [3] is that  $N(w)$  and  $D(w)$  exists for any  $A_n^\pm$ -word  $w$ . We obtain also the following result:

**Proposition 3.6.** *Let  $w$  be an  $A_n$ -word and  $a_{p,q}$  be in  $A_n$ . The braid  $\bar{w}$  is right divisible by  $a_{p,q}$  if and only if  $D(w \cdot a_{p,q}^{-1})$  is empty.*

Since the denominator of  $a_{1,2}a_{2,3}a_{1,2}a_{1,3}^{-1}$  is empty, the braid  $a_{1,3}$  right divides the braid  $a_{1,2}a_{2,3}a_{1,2}$ .

#### 4. CHARACTERIZATION OF ROTATING NORMAL WORDS

The aim of this section is to give a syntactical characterization of  $n$ -rotating words among  $A_n$ -words.

**Lemma 4.1.** *For  $\beta$  in  $B_n^{+*}$  there is equivalence between*

- (i) *an  $A_n$ -word representing  $\beta$  contains an  $a_{p,n}$ -barrier,*
- (ii) *every  $A_n$ -word representing  $\beta$  contains an  $a_{p,n}$ -barrier.*

*Proof.* Clearly (ii) implies (i). For (i)  $\Rightarrow$  (ii) it is sufficient to prove that relations of Proposition 1.1 preserve  $a_{p,n}$ -barriers. For relation (2) this is immediate since it conserves involved letters. If one of the three words  $a_{r,s}a_{s,t}$ ,  $a_{s,t}a_{r,s}$  and  $a_{r,t}a_{r,s}$  of relations (3) contains an  $a_{p,n}$ -barrier then the two others also, as illustrated by the following chord diagram (the chord of an  $a_{p,n}$ -barrier intersects properly the chord of the letter  $a_{p,n}$ .)



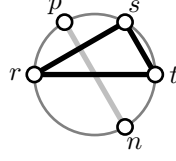

□

As a consequence, containing an  $a_{p,n}$ -barrier is not a word property but a braid one.

**Lemma 4.2.** *Assume that  $n \geq 3$ ,  $\beta$  belongs to  $B_{n-1}^{+*}$  and that the  $B_{n-1}^{+*}$ -tail of  $\phi_n(\beta)$  is trivial. Then every  $A_{n-1}$ -word representing  $\beta$  ends with  $\beta^\#$ .*

*Proof.* Let  $u$  be an  $A_{n-1}$ -word representing  $\beta$ . As the  $B_{n-1}^{+*}$ -tail of  $\phi_n(\beta)$  is trivial, the last letter  $u^\#$  of  $u$  not belongs to  $A_{n-2}$  and so  $u^\#$  is  $a_{p,n-1}$  for some integer  $p < n - 1$ . Assume now  $v$  is another  $A_{n-1}$ -word representing  $\beta$ . For the same reason as  $u$ , we have  $v^\# = a_{q,n-1}$  for some  $q < n - 1$ . Since the two braids  $a_{p,n-1}$  and  $a_{q,n-1}$  are right divisors of  $\beta$ , their left lcm is also a right divisor of  $\beta$ . Assume for a contradiction that  $p$  and  $q$  are different. The braid  $\beta$  is then right divisible by  $a_{p,q}a_{q,n-1}$ , which is the left lcm of  $a_{p,n-1}$  and  $a_{q,n-1}$ . Since  $a_{p,q}a_{q,n-1}$  is equivalent to  $a_{p,n-1}a_{p,q}$ , the braid  $a_{p,q}$  is also a right divisor of  $\beta$ . In particular  $a_{p+1,q+1}$ , with  $q + 1 < n$ , is a right divisor of  $\phi_n(\beta)$ , which is impossible since the  $B_{n-1}^{+*}$ -tail of  $\phi_n(\beta)$  is supposed to be trivial. Therefore, every  $A_{n-1}$ -word representing  $\beta$  ends with the same letter, namely  $\beta^\#$ . □

We conclude that, under some hypotheses, the last letter of a word is a braid invariant.

**Definition 4.3.** For  $n \geq 3$  and  $2 \leq p \leq n - 1$ , we say that an  $n$ -rotating word  $w$  is an  $a_{p,n}$ -ladder if there exist a decomposition

$$w = v_0 x_1 v_1 \dots v_{h-1} x_h v_h,$$

a sequence  $p = j(0) < j(1) < \dots < j(h) = n - 1$  and a sequence  $i$  such that

- (i) for each  $k \leq h$ , the letter  $x_k$  is  $a_{i(k),j(k)}$  with  $i(k) < j(k-1) < j(k)$ ,
- (ii) for each  $k < h$ , the word  $v_k$  contains no  $a_{j(k),n}$ -barrier,

Condition (ii) is equivalent to: for each  $k \leq h$ , the letter  $x_k$  is an  $a_{j(k-1),n}$ -barrier of type  $a_{\dots,j(k)}$ .

An immediate adaptation of Proposition 3.9 of [9] is :

**Lemma 4.4.** *Assume that  $n \geq 3$ ,  $\beta$  belongs to  $B_{n-1}^{+*}$ , the  $B_{n-1}^{+*}$ -tail of  $\phi_n(\beta)$  is trivial and  $\beta$  contains an  $a_{p,n}$ -barrier for some  $2 \leq p \leq n - 2$ . Then the normal form of  $\beta$  is an  $a_{p,n}$ -ladder.*

In order to obtain a syntactical characterization of  $n$ -rotating words we want a local version of condition (6) characterizing a  $\phi_n$ -splitting. The following result is the first one in this way.

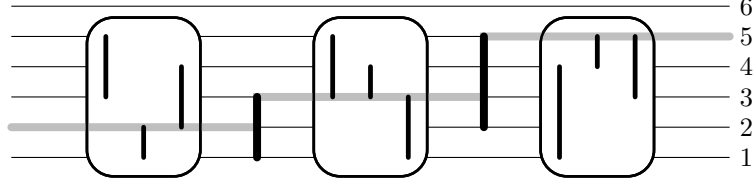

FIGURE 5. An  $a_{2,6}$ -ladder. The gray line starts at position 1 and goes up to position 5 using the bar of the ladder. The empty spaces between bars in the ladder are represented by a framed box. In such boxes the vertical line representing the letter  $a_{i,j}$  does not cross the gray line. The bar of the ladder are represented by black thick vertical lines.

**Proposition 4.5.** For  $\beta \in B_{n-1}^{+*}$  and  $p$  an integer satisfying  $2 \leq p \leq n-2$  there is equivalence between

- (i) the  $B_{n-1}^{+*}$ -tail of  $\phi_n(a_{p,n}\beta)$  is trivial,
- (ii) the  $B_{n-1}^{+*}$ -tail of  $\phi_n(\beta)$  is trivial and  $\beta$  contains an  $a_{p,n}$ -barrier,
- (iii) the only  $A_n$ -letter that right divides  $a_{p,n}\beta$  is  $\beta^\#$ , which is of type  $a_{\dots,n-1}$ .

Our proof of Proposition 4.5 rests on the following Lemma.

**Lemma 4.6.** For  $n \geq 3$ ,  $u$  an  $A_{n-1}$ -word and  $p \in [1, n-1]$ , the left denominator  $D(ua_{p,n}^{-1})$  is not empty. More precisely,  $D(ua_{p,n}^{-1})^{-1}$  begins with  $a_{q,n}^{-1}$  satisfying  $q \leq p$ .

*Proof.* Assume that  $w_1, \dots, w_\ell$  is a reversing sequence from the word  $w_1 = ua_{p,n}^{-1}$  to the word  $D(w_1)^{-1}N(w_1)$ . For  $k \in [1, \ell]$  we denote by  $y_k$  the leftmost negative letter in  $w_k$ . Each reversing step consists in replacing a factor  $xy^{-1}$  of  $w_k$  by  $f_n(x, y)^{-1}f_n(y, x)$ . If for  $k \in [1, \ell]$  the reversed factor of  $w_k$  does not contains  $y_k^{-1}$  then  $y_{k+1}$  equals  $y_k$ . Assume now that the reversed factor is  $xy_k^{-1}$  with  $y_k = a_{r,n}$ . Lemma 3.2 implies

$$f_n(x, y_k) = f_n(a_{i,j}, a_{r,n}) = \begin{cases} a_{i,n} & \text{for } j = r, \\ a_{r,j}a_{i,n} & \text{for } i < r < j, \\ a_{r,n} & \text{otherwise,} \end{cases}$$

which gives in particular

$$xy_k^{-1} = a_{i,j}a_{r,n}^{-1} \curvearrowright \begin{cases} a_{i,n}^{-1}\dots & \text{for } i < r \leq j, \\ a_{r,n}^{-1}\dots & \text{otherwise.} \end{cases} \quad (8)$$

It follows that  $y_{k+1}$  is equal to  $a_{s,n}$  for some  $s \leq r$ . Eventually we obtain that  $ua_{p,n}^{-1}$  left reverses to  $a_{q,n}^{-1}\dots$  with the relation  $q \leq p$  and so the desired property on  $D(ua_{p,n})$  holds.  $\square$

*Proof of Proposition 4.5.* Assume (i). As the the  $B_{n-1}^{+*}$ -tail of  $\phi_n(\beta)$  is also a right divisor of  $\phi_n(a_{p,n}\beta)$  the first statement of (ii) holds. The second statement is Lemma 2.10. Let us prove that (iii) implies (i). By hypothesis

the last letter of  $\beta$  is  $a_{q-1,n-1}$  for some  $q$ . As the only  $A_n$ -letter that right divides  $\phi_n(a_{p,n}\beta)$  is  $\phi_n(a_{q-1,n-1}) = a_{q,n}$ , the  $B_{n-1}^{+*}$ -tail of  $\phi_n(a_{p,n}\beta)$  must be trivial.

We now prove (ii)  $\Rightarrow$  (iii). Since the  $B_{n-1}^{+*}$ -tail of  $\phi_n(\beta)$  is trivial, the letter  $\beta^\#$  must be of type  $a_{\dots,n-1}$ . We denote by  $w$  the rotating normal from of  $\beta$ . Let  $a_{r,s}$  be an  $A_n$ -letter different from  $\beta^\#$ . We will show that  $a_{r,s}$  cannot be a right divisor of  $a_{p,n}\beta$ . Assume first  $s \leq n-1$ . By Lemma 4.2,  $a_{r,s}$  is not a right divisor of  $\beta$ . Proposition 3.6 implies that the word  $D(w a_{r,s}^{-1})$  must be non empty. As the reversing of an  $A_{n-1}^\pm$ -word is also an  $A_{n-1}^\pm$ -word, there exists a letter  $a_{t,t'}$  with  $t' < n$  such that

$$a_{p,n} w a_{r,s}^{-1} \curvearrowright a_{p,n} a_{t,t'}^{-1} \dots,$$

holds. Clearly, the braid  $a_{t,t'}$  is not a right divisor of  $a_{p,n}$  (since we have  $t' < n$ ). Therefore, by Proposition 3.6, the left denominator of  $a_{p,n} w a_{r,s}^{-1}$  is not empty, and we conclude that  $a_{r,s}$  is not a right divisor of  $a_{p,n}\beta$ .

Assume now  $s = n$ . Hypotheses on  $\beta$  plus Lemma 4.4 imply that  $w$  is an  $a_{p,n}$ -ladder. Following Definition 4.3, we write

$$w = v_0 x_1 v_1 \dots v_{h-1} x_h v_h.$$

By Lemma 4.6, there exist two maps  $\eta$  and  $\mu$  from  $\mathbb{N}$  to itself such that

$$w a_{r,n}^{-1} = w_h a_{\eta(h),n}^{-1} \curvearrowright w'_h a_{\mu(h),n}^{-1} \dots \curvearrowright \dots \curvearrowright w_0 a_{\eta(0),n}^{-1} \dots \curvearrowright w'_0 a_{\mu(0),n}^{-1},$$

where for all  $k \in [0, h]$ ,

$$\begin{aligned} w_k &= v_0 x_1 v_1 \dots v_{k-1} x_k v_k, \\ w'_k &= v_0 x_1 v_1 \dots v_{k-1} x_k. \end{aligned}$$

By construction  $w_0$  is  $v_0$  while  $w'_0$  is the empty word. Lemma 4.6 implies

$$\mu(0) \leq \eta(0) \leq \mu(1) \leq \dots \leq \mu(h) \leq \eta(h) = r. \quad (9)$$

Following Definition 4.3 we write  $x_k = a_{i(k),j(k)}$ . We will now prove by induction

$$\text{for all } k \in [0, h-1], \mu(k+1) \leq j(k+1) \Rightarrow \eta(k) < j(k) \quad (10)$$

Let  $k \in [0, h-1]$  and assume  $\mu(k+1) \leq j(k+1)$ . Definition 4.3 (i) guarantees the relation  $i(k+1) < j(k) < j(k+1)$ . For  $\mu(k+1) \leq i(k+1)$  we have

$$\eta(k) \leq \mu(k+1) \leq i(k+1) < j(k),$$

and we are done in this case. The remaining case is  $\mu(k+1) > i(k+1)$ . By relation (8), with  $i = i(k+1)$ ,  $j = j(k+1)$  and  $r = \eta(k+1)$  we obtain

$$x_{k+1} a_{\mu(k+1),n}^{-1} = a_{i(k+1),j(k+1)} a_{\mu(k+1),n}^{-1} \curvearrowright a_{i(k+1),n}^{-1} v$$

with some  $A_n^\pm$ -word  $v$ . In particular, we have  $\eta(k) = i(k+1) < j(k)$  and (10) is established. For  $k = h-1$  the left hand member of (10) is satisfied since  $j(h)$  is equal to  $n-1$  and  $r \leq n-1$  holds by definition of  $r$ . Properties (9) and (10) imply  $\mu(k) < j(k)$  for all  $k \in [0, h-2]$ . In particular

we have  $\mu(0) < j(0) = p$  together with  $wa_{r,n}^{-1} \curvearrowright a_{\mu(0),n}^{-1} \cdots$ . As  $a_{\mu(0),n}$  can not be a right divisor of  $a_{p,n}$  it follows that the left denominator of  $a_{p,n} w a_{r,n}^{-1}$  is also non empty and so that  $a_{r,n}$  is not a right divisor of  $a_{p,n}\beta$ .  $\square$

As the reader can see, the case  $p = n - 1$  is excluded from Proposition 4.5. It is the aim of the following result.

**Proposition 4.7.** *For  $\beta$  a non-trivial braid of  $B_{n-1}^{+*}$  there is equivalence between*

- (i) *the  $B_{n-1}^{+*}$ -tail of  $\phi_n(a_{n-1,n}\beta)$  is trivial,*
- (ii) *the only  $A_n$ -letter right dividing  $a_{n-1,n}\beta$  is  $\beta^\#$  which is of type  $a_{\dots,n-1}$ .*

*Proof.* (ii)  $\Rightarrow$  (i) is similar as (iii)  $\Rightarrow$  (i) of Proposition 4.7. We now show that (i) implies (ii). Condition (i) implies in particular that the  $B_{n-1}^{+*}$ -tail of  $\phi_n(\beta)$  is trivial. It follows that the last letter of  $\beta$  is of type  $a_{\dots,n-1}$ . Let  $w$  be the rotating normal form of  $\beta$  and  $a_{r,s}$  be an  $A_n$ -letter different from  $\beta^\#$ . For  $s \leq n - 1$  we follow proof of Proposition 4.7 to obtain that  $a_{r,s}$  is not a right divisor or the braid  $a_{n-1,n}$ . Assume now  $s = n$ . By Lemma 4.6 there exists  $q \leq r$  such that  $wa_{r,n}^{-1} \curvearrowright a_{q,n}^{-1} \cdots$  holds and so we obtain  $a_{n-1,n}wa_{r,n}^{-1} \curvearrowright a_{n-1,n}a_{q,n}^{-1} \cdots$ . As, for  $q \neq n - 1$  the braid  $a_{q,n-1}$  is not a right divisor of  $a_{n-1,n}$  it is sufficient to show  $q \neq n - 1$  for concluding that  $a_{r,n}$  not right divides  $a_{n-1,n}\beta$ . For  $r \leq n - 2$  it is obvious since  $q \leq r$  holds. Assume finally  $r = n - 1$ . We denote by  $a_{p,n-1}$  the last letter of  $\beta$ . By (8) we have  $a_{p,n-1}a_{n-1,n}^{-1} \curvearrowright a_{p,n}^{-1} \cdots$  and then Lemma 4.6 implies  $q \leq p < n - 1$ , as expected.  $\square$

**Theorem 4.8.** *A finite sequence  $(\beta_b, \dots, \beta_1)$  of braids in  $B_{n-1}^{+*}$  is the  $\phi_n$ -splitting of a braid of  $B_n^{+*}$  if and only if*

- (i) *for  $k \geq 3$  and  $k = b$ , the braid  $\beta_k$  is not trivial,*
- (ii) *for  $k \geq 2$ , the  $B_{n-1}^{+*}$ -tail of  $\phi_n(\beta_k)$  is trivial,*
- (iii) *if, for  $k \geq 3$ , we have  $\beta_k^\# \neq a_{n-2,n-1}$  then  $\beta_{k-1}$  contains an  $\phi_n(\beta_k^\#)$ -barrier.*

*Proof.* Let  $(\beta_b, \dots, \beta_1)$  be the  $\phi_n$ -splitting of some braid of  $B_{n-1}^{+*}$ . Condition (i) is a consequence of Lemma 2.8.(ii). Condition (6) implies that the  $B_{n-1}^{+*}$ -tail of

$$\phi_n^{b-k}(\beta_b) \cdot \dots \cdot \phi_n(\beta_{k+1})$$

is trivial for  $k \geq 1$ . In particular the  $B_{n-1}^{+*}$ -tail of  $\phi_n(\beta_{k+1})$  must be trivial for  $k \geq 1$ , which implies (ii). Condition (iii) is Lemma 2.11.

Conversely, let us prove that a sequence  $(\beta_b, \dots, \beta_1)$  of braids of  $B_{n-1}^{+*}$  satisfying (i), (ii) and (iii) is the  $\phi_n$ -splitting of some braid of  $B_n^{+*}$ . Condition (i) implies that  $\beta_b$  is not trivial. For  $k \geq 2$  we denote by  $\gamma_k$  the braid  $\phi_n^{b-k}(\beta_b) \cdot \dots \cdot \phi_n(\beta_{k+1}) \cdot \beta_k$ . For  $k \geq 3$  and  $k \geq 2$  whenever  $\beta_2 \neq 1$ , we first prove

$$\beta_k^\# \text{ is the only } A_n\text{-letter that right divides } \gamma_k. \quad (11)$$

We note that Condition (i) guarantees the existence of  $\beta_k^\#$  for  $k \geq 3$ . For  $k = b$ , Condition (ii) implies that the  $B_{n-1}^{+*}$ -tail of  $\phi_n(\beta_b)$  is trivial. Hence,

by Lemma 4.2 the only  $A_{n-1}$ -letter that right divides  $\beta_b$  is  $\beta_b^\#$ . Since any right divisors of a braid of  $B_{n-1}^{+*}$  lie in  $B_{n-1}^{+*}$ , we have established (11) for  $k = b$ . Assume (11) holds for  $k \geq 4$  or  $k \geq 3$  whenever  $\beta_2 \neq 1$  and let us prove it for  $k - 1$ . By Condition (ii) there exists  $p$  such that  $\beta_k^\#$  is  $a_{p-1, n-1}$ . We denote by  $ua_{p-1, n-1}$  and  $v$  two  $A_n$ -words representing  $\gamma_k$  and  $\beta_{k-1}$  respectively. The braid  $\gamma_{k-1}$  is then represented by  $\phi_n(u)a_{p, n}v$ . Let  $y$  be an  $A_n$ -letter different from  $\beta_{k-1}^\#$ . Proposition 4.5 with Condition (iii) and Proposition 4.7 imply that  $y$  is not a right divisor of  $a_{p, n}\beta_{k-1}$ . Therefore, by Proposition 3.6 there exists an  $A_n$ -letter  $x$  different from  $a_{p, n}$  such that  $\phi_n(u)a_{p, n}vy^{-1} \curvearrowright \phi_n(u)a_{p, n}x^{-1} \dots$ . The word  $\phi_n(u)a_{p, n}$  represents  $\phi_n(\gamma_k)$ . By induction hypothesis  $x$  is not a right divisor of  $\phi_n(\gamma_k)$ . Then Proposition 3.6 implies that  $D(\phi_n(u)a_{p, n}x^{-1})$  is not empty. It follows  $D(\phi_n(u)a_{p, n}vy^{-1}) \neq \varepsilon$  and so always by Proposition 3.6, the letter  $y$  is not a right divisor of  $\gamma_{k-1}$ . Eventually we have established (11) for  $k \geq 3$ .

A direct consequence of (11) and Condition (ii) is that the only  $A_n$ -letter right dividing  $\phi_n(\gamma_k)$  is of type  $a_{\dots, n}$  and so the  $B_{n-1}^{+*}$ -tail of the braid  $\gamma_k$  is trivial for  $k \geq 3$  and for  $k = 2$  whenever  $\beta_k \neq 1$ . It remains to establish that the  $B_{n-1}^{+*}$  tail of  $\phi_n(\gamma_2)$  is also trivial whenever  $\beta_2$  is trivial. Assume  $\beta_2 = 1$ . Condition (iii) implies  $\beta_3^\# = a_{n-2, n-1}$ . By (11),  $a_{n-2, n-1}$  is the only  $A_n$ -letter that right divides the braid  $\gamma_3$ . Since  $\gamma_2 = \phi_n(\gamma_3)$ , the letter  $\phi_n^2(a_{n-2, n-1}) = a_{1, n}$  is the only letter right dividing  $\phi_n(\gamma_2)$ . In particular the  $B_{n-1}^{+*}$ -tail of  $\phi_n(\gamma_2)$  is trivial.  $\square$

Conditions (i), (ii) and (iii) are easy to check if the braids  $\beta_1, \dots, \beta_b$  are given by their rotating normal forms.

**Corollary 4.9.** *Let  $(w_b, \dots, w_1)$  be a finite sequence of  $A_{n-1}$ -words, then the word*

$$\phi_n^{b-1}(w_b) \cdot \dots \cdot \phi_n(w_2) \cdot w_1, \quad (12)$$

*is  $n$ -rotating if the following conditions are satisfied*

- (i) for  $k \geq 1$ , the word  $w_k$  is  $(n - 1)$ -rotating,
- (ii) for  $k \geq 3$ , the word  $w_k$  ends by  $a_{p-1, n-1}$  for some  $p$ ,
- (iii) the word  $w_2$  is either empty (except for  $b = 2$ ) or ends by  $a_{p-1, n-1}$  for some  $p$ ,
- (iv) if, for  $k \geq 3$ , the word  $w_k$  ends by  $a_{p-1, n-1}$  with  $p \neq n - 1$  then the word  $w_{k-1}$  contains an  $a_{p, n}$ -barrier.

*Proof.* Assume that  $(w_b, \dots, w_1)$  satisfies Conditions (i)-(iv) and let us prove that the word  $w$  defined at (12) is rotating.

We denote by  $\beta_i$  (resp.  $\beta$ ) the braid represented by  $w_i$  (resp.  $w$ ). By Condition (i) and Definition 2.5, the word  $w$  is rotating if and only if  $(\beta_b, \dots, \beta_1)$  is a  $\phi_n$ -splitting. Conditions (ii) and (iii) imply Condition (i) of Theorem 4.8. Theorem 4.8.(iii) is a consequence of (ii) and (iv). We remark that the  $B_{n-1}^{+*}$ -tail of a braid  $\gamma$  is represented by a suffix of the rotating word of  $\gamma$ . If the  $B_{n-1}^{+*}$ -tail of  $\phi_n(\beta_k)$  is not trivial, then there exists  $a_{p, q}$  with  $1 \leq p < q < n$  that right divides  $\phi_n(\beta_k)$ . As  $\beta_k$  lies in  $B_{n-1}^{+*}$ , we have  $p \neq 1$

and therefore  $\beta_k$  is right divisible by  $a_{p-1,q-1}$  with  $q-1 \leq n-2$ . Assume the  $B_{n-1}^{+*}$ -tail of  $w_k$  is not trivial for  $k \geq 2$ . The previous remark implies that  $w_k$  must end with a letter  $a_{i,j}$  satisfying  $j \leq n-2$ , which is in contradiction with Conditions (ii) and (iii).  $\square$

It is not true that any decomposition of an  $n$ -rotating word as in (12) satisfies Conditions (i)–(iv) of Corollary 12. However we have the following result.

**Proposition 4.10.** *For every  $n$ -rotating word  $w$  with  $n \geq 3$  there exists a unique sequence  $(w_b, \dots, w_1)$  of  $(n-1)$ -rotating words such that  $w$  decompose as in (12) and Conditions (ii)–(iv) of 4.9 hold.*

*Proof.* By definition of a rotating normal word and by Lemma 2.8 such a sequence exists. Let us prove now the unicity. Assume  $w$  is a  $n$ -rotating normal word and that  $(w_b, \dots, w_1)$  and  $(w'_c, \dots, w'_1)$  are two different sequences of  $(n-1)$ -rotating normal words satisfying Conditions (ii) and (iii) of Corollary 4.9. Let  $k$  be the minimal integer satisfying  $w_k \neq w'_k$ . Since the sum of the word lengths of the two sequences are the same, we have  $k \leq \min\{b, c\}$ . Without loss of generality, we may assume that  $w'_k$  is a proper suffix of  $w_k$ , i.e.,  $w_k = u \cdot w'_k$ . By Conditions (ii) and (iii) of Corollary 4.9, the last letter  $x$  of  $u$  comes from the last letter of  $w'_{k+1}$  or  $w'_{k+2}$ . Hence the letter  $x$  is equal to  $a_{p-1,n-1}$  for some  $p$  and  $w_k$  admits either  $\phi_n(a_{p-1,n-1})w'_k = a_{p,n}w'_k$  or  $\phi_n^2(a_{p-1,n-1})w'_k = a_{1,p+1}w'_k$  as suffix. The first case is impossible since  $w_k$  is an  $A_{n-1}$ -word. The second case may occur only for  $k=1$  and  $w'_2 = \varepsilon$ . As  $w'_2$  is empty, the last letter of  $w'_3$ , which is  $x$ , is equal to  $a_{n-2,n-1}$ . This implies that  $w_k$  admits  $a_{1,n}u$  as suffix which is also impossible since it is an  $A_{n-1}$ -word.  $\square$

A direct consequence of Corollary 4.9 and Proposition 4.10 is

**Theorem 4.11.** *An  $A_n$ -word  $w$  is rotating if and only if it can be expressed as in (12) subject to Conditions (i)–(iv) of Corollary 4.9.*

## 5. REGULARITY

In this section we will show that the language of  $n$ -rotating words, denoted by  $R_n$  is regular, i.e., there exists a finite state automaton recognizing the  $n$ -rotating words. As the rotating normal form is defined using right division it is more natural for an automaton to read word from the right. For  $w = x_0 \dots x_k$  an  $A_n$ -word we will denote by  $\Pi(w)$  the word  $x_k \dots x_0$ . By Theorem 1.2.8 of [7] the language  $R_n$  is regular if and only if the language  $\Pi(R_n)$  is. In this section we will construct an automaton recognizing  $\Pi(R_n)$ .

For us a *finite state automaton* is a quintuplet  $(S \cup \{\otimes\}, A, \mu, Y, i)$  where  $S$  is the finite set of *states*,  $A$  is a finite *alphabet*,  $\mu : S \times A \rightarrow S$  is the *transition function*,  $Y \subseteq S$  is *accepting states* and  $i$  is the *initial state*. In this paper each automaton is equipped with an undraw dead state  $\otimes$  and all states except the dead one is accepting, i.e.,  $Y = S$  always holds.

Therefore an automaton will be briefly denoted by  $\mathcal{A} = (S, A, \mu, i)$ . To describe  $\mathcal{A}$  it is enough to describe  $\mu$  on  $(s, x) \in S \times A$  where  $\mu(s, x) \neq \otimes$  and  $s \neq \otimes$ . By example an automaton recognizing the language  $R_2$  is  $\mathcal{A}_2 = (\{1\}, \{a_{1,2}\}, \mu_2, 1)$  with  $\mu_2(1, a_{1,2}) = 1$ . The corresponding automaton diagram is :

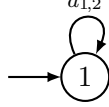

The horizontal arrow points to the initial state.

**Proposition 5.1.** *An  $A_3$ -word  $x_b^{e_b} \cdot \dots \cdot a_{1,3}^{e_3} a_{2,3}^{e_2} a_{1,2}^{e_1}$  where*

$$x_b = \begin{cases} a_{1,2} & \text{if } b \equiv 1 \pmod{3}, \\ a_{2,3} & \text{if } b \equiv 2 \pmod{3}, \\ a_{1,3} & \text{if } b \equiv 3 \pmod{3}. \end{cases}$$

*is rotating if and only if  $e_k \neq 0$  for all  $k \geq 3$ .*

*Proof.* The 2-rotating words are powers of  $a_{1,2}$ . Let  $w$  be the word of the statement. Defining  $w_k$  to be  $a_{1,2}^{e_k}$ , we obtain

$$w = \phi_n^{b-1}(w_b) \cdot \dots \cdot \phi_n(w_2) \cdot w_1.$$

As there is no barrier in  $B_3^{+*}$ , the word  $w$  is rotating if and only if it satisfies Conditions (ii) and (iii) of Corollary 4.9, *i.e.*, the exponent  $e_k$  is not 0 for  $k \geq 3$ .  $\square$

As a consequence the following automaton recognizes the language  $\Pi(R_3)$ :

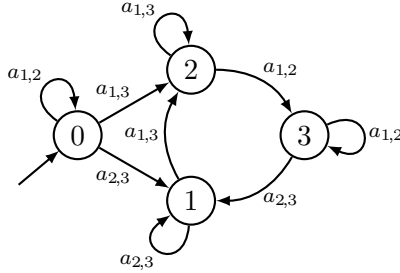

Unfortunately, for  $n \geq 4$  there is no so simple characterization of  $n$ -rotating words. We will describe an inductive construction for an automaton recognizing language  $\Pi(R_n)$ . The process will be illustrated on  $n = 4$ . The first step is to focus on  $n$ -rotating words ending with a letter of type  $a_{\dots n}$ .

**Definition 5.2.** We denote by  $R_n^*$  the language of  $n$ -rotating words which are empty or ends with a letter of type  $a_{p,n}$  for some  $p$ .

Before constructing an automaton  $\mathcal{A}_n$  recognizing the language  $\Pi(R_n)$ , we construct by induction on  $n \geq 3$  an automaton  $\mathcal{A}_n^*$  for the language  $\Pi(R_n^*)$ .

**Definition 5.3.** A *partial automaton* is a quadruplet  $P = (S, A, \mu, I)$  where  $S$ ,  $A$  and  $\mu$  are defined as for an automaton and  $I : A \rightarrow S$  is a map. The closure of a partial automaton  $P$  is the automaton  $\mathcal{A}(P) = (S \cup \{\circ\}, A, \mu^c, \circ)$  given by

$$\mu^c(s, x) = \begin{cases} I(x) & \text{if } s = \circ, \\ \mu(s, x) & \text{otherwise.} \end{cases}$$

A partial automaton is represented as an automaton excepted for the function  $I$ . For each  $x \in A$  we draw an arrow attached to state  $I(x)$  and labelled  $x$ . We say that a partial automaton recognizes a given language if its closure does.

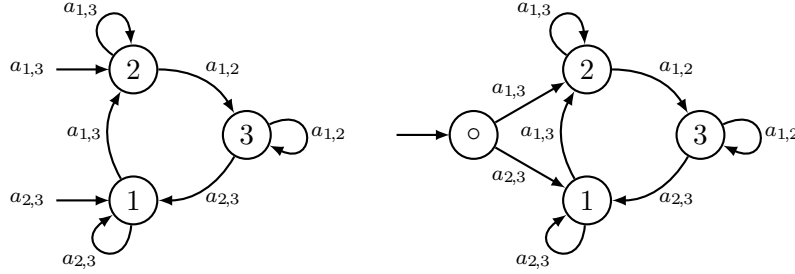

FIGURE 6. The partial automaton  $P_3$  and the corresponding closure which recognizes the language  $\Pi(R_3^*)$ .

We will now show how to construct by induction a partial automaton  $P_n$  recognizing  $\Pi(R_n^*)$  for  $n \geq 3$ . For  $n = 3$  this is already done by Figure 6. For the sequel we assume  $n \geq 4$  and that  $P_{n-1} = (S_{n-1}, A_{n-1}, \mu_{n-1}, I_{n-1})$  is a given partial automaton which recognizes the language  $\Pi(R_{n-1})$ .

We define  $S_n^0$  to be the set

$$S_n^0 = \{0\} \times (S_{n-1} \setminus \{\otimes\}) \times \mathcal{P}(\{a_{2,n}, \dots, a_{n-2,n}\}).$$

A state in  $S_n^0$  is then written  $(0, s, m)$ . For  $x = a_{i,j} \in A_{n-1}$  we denote by  $\text{bar}(x)$  the set  $\{a_{p,n} \mid i < p < j\}$ .

**Definition 5.4.** We define  $P_n^0 = (S_n^0 \cup \{\otimes\}, A_{n-1}, \mu_n^0, I_n^0)$  to be the partial automaton where for all  $x \in A_{n-1}$ ,

$$I_n^0(x) = \begin{cases} (0, I_{n-1}(x), \text{bar}(x)) & \text{if } I_{n-1}(x) \neq \otimes, \\ \otimes & \text{if } I_{n-1}(x) = \otimes. \end{cases}$$

and for all  $(0, s, m) \in S_n^0$  and for all  $x \in A_{n-1}$ ,

$$\mu_n^0((0, s, m), x) = \begin{cases} (0, \mu_{n-1}(s, x), m \cup \text{bar}(x)) & \text{if } \mu_{n-1}(s, x) \neq \otimes, \\ \otimes & \text{if } \mu_{n-1}(s, x) = \otimes. \end{cases}$$



**Proposition 5.5.** *The partial automaton  $P_n^0$  recognizes the language  $\Pi(R_{n-1}^*)$ . Moreover an accepted  $A_n$ -word  $\Pi(w)$  contains an  $a_{p,n}$ -barrier if and only if  $P_{n,0}$  has state  $(s, m)$  with  $a_{p,n} \in m$  after reading  $\Pi(w)$ .*

*Proof.* Let  $w$  be an  $A_n$ -word of length  $\ell$ ,  $\mathcal{A}$  and  $\mathcal{A}'$  be the closure of  $P_{n-1}$  and  $P_n^0$  respectively. We denote by  $s_k$  (resp.  $(s'_k, m_k)$ ) the state of automaton  $\mathcal{A}$  (resp.  $\mathcal{A}'$ ) after reading the  $k$ -th letter of  $\Pi(w)$ . If  $w$  does not contains an  $a_{p,n}$ -barrier then  $(s'_k, m_k)$  is equal to  $(s_k, \emptyset)$  for all  $k \in [1, \ell]$ . Hence  $\Pi(w)$  is accepted or not by the two automata and in particular  $m_\ell$  is the empty set. Assume now  $w$  contains an  $a_{p,n}$ -barrier. Let  $\ell'$  be the first occurrence on such a barrier in  $\Pi(w)$ . By construction of  $\mu_n$  we have  $(s'_k, m_k)$  with  $a_{p,n} \in m_k$  for  $k \geq \ell'$  except if  $s_k = \otimes$ . As  $\mathcal{A}$  (resp.  $\mathcal{A}'$ ) recognizes the word  $\Pi(w)$  if and only if  $s_\ell$  (resp.  $s'_\ell$ ) is different from  $\otimes$ , the word  $w$  is recognized or not by both automata. Moreover, in this case  $m_\ell$  contains  $a_{p,n}$ .  $\square$

As the only  $a_{p,4}$ -barrier in  $A_4$  is  $a_{1,3}$ , the partial automaton  $P_4^0$  is obtained from  $P_3$  by connecting edges labelled  $a_{1,3}$  to a copy of  $P_3$ , as illustrated on figure 5

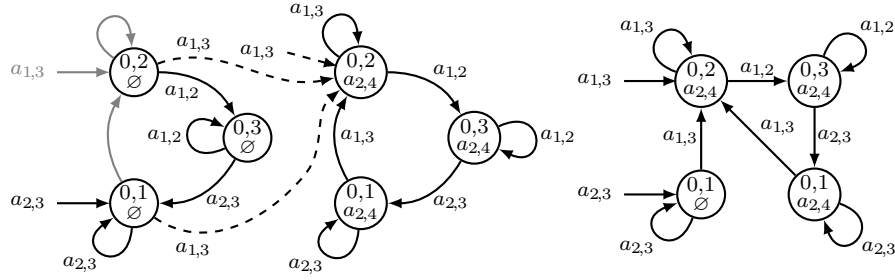

FIGURE 7. The partial automaton  $P_4^0$ . Obsolete transitions from  $P_3$  are in gray. New added transitions are dashed. The right partial automaton is  $P_4^0$  without inaccessible states.

For  $t = (0, s, m) \in S_n^0$  we define  $\phi_n^k(t)$  to be  $(k, s, m)$ . We also define  $S_n^k$  to be  $\phi_n^k(S_n^0)$  and

$$P_n^k = \left( S_n^k, \phi_n^k(A_{n-1}), \mu_n^k, I_n^k \right)$$

to be the partial automaton given by  $I_n^k(\phi_n^k(x)) = \phi_n^k(I_n^0(x))$  and

$$\mu_n^k((k, s, m), \phi_n^k(x)) = \phi_n^k(\mu_n^0((0, s, m), x))$$

with the convention  $\phi_n^k(\otimes) = \otimes$ . In other words,  $P_n^k$  is obtained from  $P_n^0$  by replacing the letter  $x$  by  $\phi_n^k(x)$  and state  $(0, s, m)$  by  $(k, s, m)$ . We obtain immediately that  $P_n^k$  recognizes the word  $\phi_n^k(\Pi(w))$  if and only if  $P_n^0$  recognizes  $\Pi(w)$ .

We can now construct the partial automaton  $P_n$  by plugging together  $n$  partial automaton  $P_n^k$  for  $k \in [0, n-1]$  together.

**Definition 5.6.** We define  $P_n = (S_n^* \cup \{\otimes\}, A_n, \mu_n^*, I_n)$ , with  $S_n^* = S_n^0 \sqcup \dots \sqcup S_n^k$  to be the partial automaton given by

$$I_n(x) = \begin{cases} I_n^1(a_{p-1,n-1}) & \text{if } x = a_{p,n} \text{ with } p \neq 1, \\ I_n^2(a_{n-2,n-1}) & \text{if } x = a_{1,n}, \\ \otimes & \text{otherwise.} \end{cases}$$

and with transition function

$$\mu_n^*((k, s, m), \phi_n^k(x)) = \begin{cases} \mu_n^k((k, s, m), \phi_n^k(x)) & \text{if } x \in A_{n-1}, \\ I_n^{k+1}(\phi_n^k(x)) & \text{if } x = a_{n-1,n} \\ I_n^{k+1}(\phi_n^k(x)) & \text{if } x = a_{p,n} \text{ with } 2 \leq p \leq n-2 \\ & \text{and } a_{p,n} \in m, \\ \otimes & \text{otherwise} \end{cases}$$

with the convention  $I_n^n = I_n^0$ .

We summarize the construction of the partial automaton  $P_n$  on the following diagram.

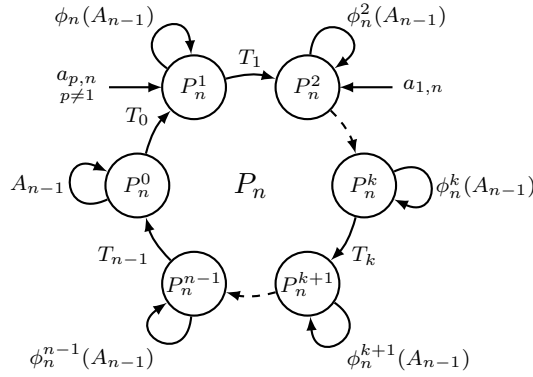

An arrow labelled  $T_k$  represents the set of transitions  $\mu_n^*((k, s, m), \phi_n^k(a_{p,n}))$ .

**Lemma 5.7.** *The partial automaton  $P_n$  recognizes the language  $\Pi(R_n^*)$ .*

*Proof.* Let  $\mathcal{A}$  be the closure of  $P_n$  and  $w$  be a non empty  $A_n$ -word. There exists a unique sequence  $(w_b, \dots, w_1)$  of  $A_{n-1}$ -words such that  $w_b \neq \varepsilon$ ,  $w$  is equal to

$$\phi_n^{b-1}(w_b) \cdot \dots \cdot \phi_n(w_2) \cdot w_1$$

and for all  $i$ , the word  $\phi_n^i(w_i)$  is the maximal suffix of  $\phi_n^{i-1}(w_i) \cdot \dots \cdot \phi_n^1(w_i)$  belonging to  $\phi_n^i(A_{n-1})$ . By definition of  $I_n$ , the word  $\Pi(w)$  is accepted by  $P_n$  only if  $w$  ends by a letter  $a_{p,n}$  for some  $p$ . We assume now that  $w$  is such a word. Thus the first integer  $j$  such that  $w_j$  is non empty is 2 or 3. More precisely, we have  $j = 2$  if  $p > 1$  and  $j = 3$  if  $p = 1$  holds. In both cases, the reading of  $\Pi(w)$  starts by a state coming from  $P_n^j$ . The automaton reaches a state different from one of  $P_n^j$  if it goes to the state  $\otimes$  or if it reads a letter

outside of  $\phi_n^{j-1}(A_n)$ , *i.e.*, a letter of  $\phi_n^j(w_{j+1})$ . This is a general principle : after reading a letter of  $\phi_n^{i-1}(w_i)$  the automaton  $\mathcal{A}$  is in state  $(t, s, m)$  with  $t = i \bmod n$ . By construction of  $P_n^t$ , the word  $\phi_n^{i-1}(w_i)$  provides an accepted state if and only if  $w_i$  is a word of  $\Pi(R_{n-1})$ . At this point we have shown that  $\Pi(w)$  is accepted by  $\mathcal{A}$  only if  $w$  is empty or if  $w$  satisfies  $w^{\#} = a_{p,n}$  together with Conditions (i), (ii) and (iii) of Corollary 4.9. Let  $i$  be in  $[j, k-1]$ , and assume that  $\mathcal{A}$  is in an acceptable state  $(t, s, m)$  with  $t = i \bmod n$  after reading the word  $\Pi(\phi_n^{i-1}(w_i) \cdots \phi_n(w_2) \cdot w_1)$ . We denote by  $x$  the letter  $w_{i+1}^{\#}$ . By construction of  $w_{i+1}$  we have  $x \notin \phi_n^{i-1}(A_{n-1})$  and so  $x = \phi_n^i(a_{p,n})$  for some  $p$ . By definition of  $\mu_n^*$  we have  $\mu_n^*((t, s, m), \phi_n^i(a_{p,n})) \neq \otimes$  if and only if  $p = n-1$  or  $p \in [2, n-2]$  and  $a_{p,n} \in m$ . By construction of  $P_n^t$ , we have  $a_{p,n} \in m$  if and only if  $w_i$  contains an  $a_{p,n}$ , which corresponds to Condition (iv) of Corollary 4.9. Eventually, by Corollary 4.9, the word  $\Pi(w)$  is accepted by  $\mathcal{A}$  if and only if  $w \in R_n^*$ .  $\square$

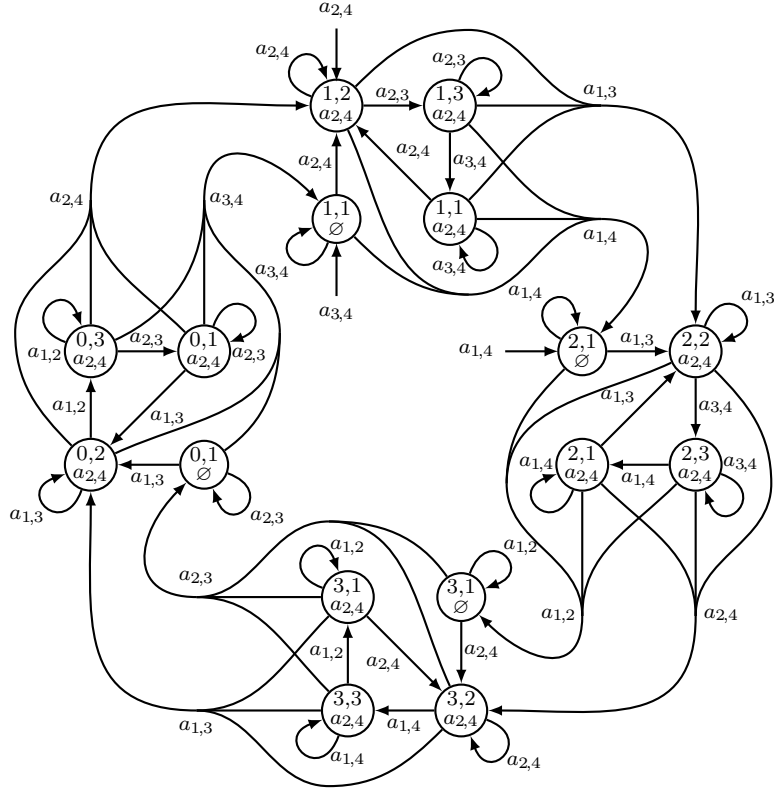

FIGURE 8. Partial automaton recognizing the language  $\Pi(R_4^*)$ .

Assume that an automaton  $\mathcal{A}_{n-1} = (S_{n-1} \cup \{\otimes\}, A_{n-1}, \mu_{n-1}, i)$  recognizing the language  $\Pi(R_{n-1})$  for  $n \geq 4$  is given. Using the partial automaton  $P_n = (S_n^* \cup \{\otimes\}, A_n, \mu_n^*, I_n)$  we construct the automaton  $\mathcal{A}_n = (S_n \cup \{\otimes\}, A_n, \mu_n, i)$

defined by  $S_n = S_{n-1} \sqcup S_n^*$  and

$$\mu_n(s, x) = \begin{cases} \mu_{n-1}(s, x) & \text{if } s \in S_{n-1} \text{ and } x \in A_{n-1}, \\ I_n(x) & \text{if } s \in S_{n-1} \text{ and } x \in A_n \setminus A_{n-1}, \\ \mu_n^*(s, x) & \text{if } s \in S_n^*. \end{cases}$$

**Proposition 5.8.** *If  $\mathcal{A}_{n-1}$  recognizes  $\Pi(R_{n-1})$ , the automaton  $\mathcal{A}_n$  recognizes the language  $\Pi(R_n)$ .*

*Proof.* Let  $w$  be an  $A_n$ -word,  $w_1$  be the maximal suffix of  $w$  which is an  $A_{n-1}$ -word and  $w'$  be the corresponding prefix. By Corollary 4.9, the word  $w$  is rotating if and only if  $w_1$  and  $w'$  are. By construction of  $\mathcal{A}_n$ , the automaton is in acceptable state after reading  $\Pi(w_1)$  if and only if  $w_1$  is an  $(n-1)$ -rotating word. Hence  $w$  is accepted only if  $w_1$  is rotating. Assume that it is the case. By Lemma 5.7 the automaton  $\mathcal{A}_n$  is always in an acceptable state after reading  $\Pi(w')$  if and only if the word  $w'$  is rotating. Eventually the word  $\Pi(w)$  is accepted by  $\mathcal{A}$  if and only if  $w_1$  and  $w'$  are both rotating, which is equivalent to  $w$  is rotating.  $\square$

By Proposition 5.8, the language  $\Pi(R_n)$  is regular and so we obtain:

**Theorem 5.9.** *The language of  $n$ -rotating words  $R_n$  is regular.*

#### FURTHER WORK

Using syntactical characterization of rotating words we have proved that the language of  $n$ -rotating words is regular. For  $W$  a finite state automaton, we denote by  $L(W)$  the language recognized by  $W$ . Following [4] and [7] we have the following definition:

**Definition 5.10.** Let  $M$  be a monoid. A *right automatic structure*, resp. *left automatic structure*, on  $M$  consists of a set  $A$  of generators of  $M$ , a finite state automaton  $W$  over  $A$ , and finite state automata  $M_x$  over  $(A, A)$ , for  $x \in A \cup \{\varepsilon\}$ , satisfying the following conditions:

- (i) the map  $\pi : L(W) \rightarrow M$  is surjective.
- (ii) for  $x \in A \cup \{\varepsilon\}$ , we have  $(u, v) \in L(M_x)$  if and only if  $\overline{ux} = \overline{y}$ , resp.  $\overline{xu} = \overline{y}$ , and both  $u$  and  $v$  are elements of  $L(W)$ .

Naturally we can ask if the rotating normal form provides an left or right automatic structure for the dual braid monoid  $B_n^{+*}$ . Such a result may needs to obtain some syntactical properties on the word  $xw$  or  $wx$  where  $w$  is an  $n$ -rotating word and  $x$  is an  $A_n$ -generator. At this time no result have been obtained in this direction.

#### REFERENCES

- [1] E. Artin, *Theorie der Zöpfe*, Abh. Math. Sem. Univ. Hanburg **4** (1925), 47–72.
- [2] D. Bessis, *The dual braid monoid*, Ann. Sci. École Norm. Sup. (4) **36** (2003), no. 5, 647–683.

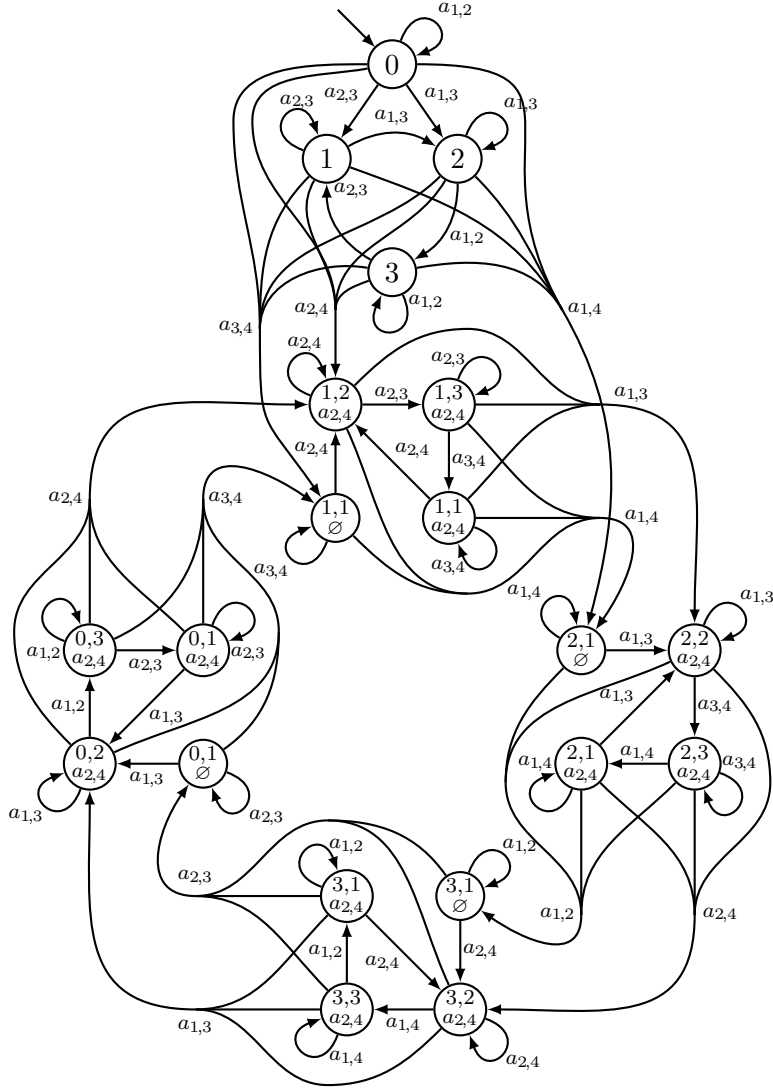
FIGURE 9. Automaton  $\mathcal{A}_4$  for the language  $\Pi(R_4)$ .

- [3] J. S. Birman, K. H. Ko, and S. J. Lee, *A new approach to the word and conjugacy problems in the braid groups*, Adv. Math. **139** (1998), no. 2, 322–353.
- [4] C. M. Campbell, E. F. Robertson, N. Ruškuc, and R. M. Thomas, *Automatic semi-groups*, Theoretical Computer Science **250** (2001), no. 1-2, 365–391.
- [5] P. Dehornoy, *Groups with a complemented presentation*, J. Pure Appl. Algebra **116** (1997), 115–137, Special volume on the occasion of the 60th birthday of Professor Peter J. Freyd.
- [6] P. Dehornoy and L. Paris, *Gaussian groups and Garside groups, two generalisations of Artin groups*, Proc. London Math. Soc. (3) **79** (1999), no. 3, 569–604.

- [7] D. B. A. Epstein, J. W. Cannon, D. F. Holt, S. V. F. Levy, M. S. Paterson, and W. P. Thurston, *Word processing in groups*, Jones and Bartlett Publishers, Boston, MA, 1992.
- [8] J. Fromentin, *A well-ordering of dual braid monoids*, C. R. Math. Acad. Sci. Paris **346** (2008), 729–734.
- [9] ———, *Every braid admits a short sigma-definite expression*, Journal of the European Mathematical Society (JEMS) **13** (2011), no. 6, 1591–1631.