



HAL
open science

The rotating normal form is regular

Jean Fromentin

► **To cite this version:**

| Jean Fromentin. The rotating normal form is regular. 2016. hal-01337636v1

HAL Id: hal-01337636

<https://hal.science/hal-01337636v1>

Preprint submitted on 27 Jun 2016 (v1), last revised 11 Oct 2024 (v4)

HAL is a multi-disciplinary open access archive for the deposit and dissemination of scientific research documents, whether they are published or not. The documents may come from teaching and research institutions in France or abroad, or from public or private research centers.

L'archive ouverte pluridisciplinaire **HAL**, est destinée au dépôt et à la diffusion de documents scientifiques de niveau recherche, publiés ou non, émanant des établissements d'enseignement et de recherche français ou étrangers, des laboratoires publics ou privés.

THE ROTATING NORMAL FORM IS REGULAR

JEAN FROMENTIN

ABSTRACT. Defined on Birman–Ko–Lee monoids, the rotating normal form has strong connections with the Dehornoy’s braid ordering. It can be seen as a process for selecting between all the representative words of a Birman–Ko–Lee braid a particular one, called *rotating* word. In this paper we construct, for all $n \geq 2$, a finite state automata which recognize the rotating words on n strands. As a consequence the language of rotating words on n strands is proved to be regular for any $n \geq 2$.

1. INTRODUCTION

Originally, the group B_n of n -strand braids was defined as the group of isotopy classes of n -strand geometric braids. An algebraic presentation of B_n was given by E. Artin in [1]

$$\left\langle \sigma_1, \dots, \sigma_{n-1} \mid \begin{array}{l} \sigma_i \sigma_j = \sigma_j \sigma_i \quad \text{for } |i - j| \geq 2 \\ \sigma_i \sigma_j \sigma_i = \sigma_j \sigma_i \sigma_j \quad \text{for } |i - j| = 1 \end{array} \right\rangle. \quad (1)$$

An n -strand braid is the equivalence class consisting of (infinitely many) words in the letter $\sigma_i^{\pm 1}$. The standard correspondence between elements of the presented group B_n and geometric braids consists in using σ_i as a code for the geometric braid where the i th and the $(i + 1)$ st strands cross, with the strands originally at position $(i + 1)$ in front of the other.

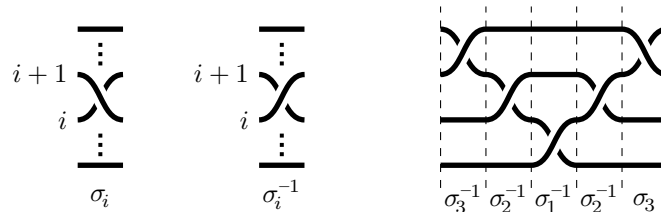

FIGURE 1. Interpretation of a word in the letters $\sigma_i^{\pm 1}$ as a geometric braid diagram.

In 1998, J.S. Birman, K.H. Ko, and S.J. Lee [3] introduced and investigated for each n a submonoid B_n^{+*} of B_n , which is known as the *Birman–Ko–Lee monoid*. The name “*dual braid monoid*” was subsequently proposed

2010 *Mathematics Subject Classification.* 20F36, 20M35, 20F10.

Key words and phrases. dual braid monoid, rotating normal form, regular language, automata.

because several numerical parameters obtain symmetric values when they are evaluated in the positive braid monoid B_n^+ and in B_n^{+*} , a correspondence that was extended to the more general context of Artin–Tits groups by D. Bessis [2] in 2003. The dual braid monoid B_n^{+*} is the submonoid of B_n generated by the braids $a_{i,j}$ with $1 \leq i < j \leq n$, where $a_{i,j}$ is defined by $a_{i,j} = \sigma_i \dots \sigma_{j-1} \sigma_j \sigma_{j-1}^{-1} \dots \sigma_i^{-1}$. In geometrical terms, the braid $a_{i,j}$ corresponds to a crossing of the i th and j th strands, both passing behind the (possible) intermediate strands.

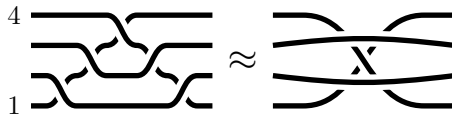

FIGURE 2. In the geometric braid $a_{1,4}$, the strands 1 and 4 cross under the strands 2 and 3.

By definition, σ_i equals $a_{i,i+1}$ and, therefore, the positive braid monoid B_n^+ is included in the monoid B_n^{+*} , a proper inclusion for $n \geq 3$ since the braid $a_{1,3}$ does not belong to the monoid B_3^+ .

We denote by A_n the set $\{a_{p,q} \mid 1 \leq p < q \leq n\}$. The following presentation of the monoid B_n^{+*} is given in [3].

Proposition 1.1. *The monoid B_n^{+*} is presented by generators A_n and relations*

$$a_{p,q}a_{r,s} = a_{r,s}a_{p,q} \quad \text{for } [p,q] \text{ and } [r,s] \text{ disjoint or nested,} \quad (2)$$

$$a_{p,q}a_{q,r} = a_{q,r}a_{p,r} = a_{p,r}a_{p,q} \quad \text{for } 1 \leq p < q < r \leq n. \quad (3)$$

The integral interval $[p,q]$ is said to be *nested* in $[r,s]$ if the relation $r < p < q < s$ holds.

Since [2] and [3] it is known that the dual braid monoid B_n^{+*} admits a Garside structure where simple elements are in bijection with the non-crossing partitions of n . In particular, there exists a normal form associated with this Garside structure, the so-called greedy normal form.

The rotating normal form is another normal form on B_n^{+*} that has been introduced in [9, 10]. It is a counterpart of the alternating normal form defined in [6] by P. Dehornoy on the positive braid monoid to the dual context. Roughly speaking, for every braid $\beta \in B_n^{+*}$ the rotating normal form pick up a unique representative word on the letters A_n among all of this representing β . It be see as a map r_n from the dual braid monoid B_n^{+*} to the set of words A_n^* . The language of all n -rotating words, denoted by R_n is then the image of B_n^{+*} under the map r_n .

The aim of this paper is to construct for all $n \geq 2$ an explicit finite state automata which recognizes the language R_n , implying in particular that the language R_n of n -rotating words is regular.

The paper is divided as follow. In section 2 we recall briefly the construction of the rotating normal form and its useful already known properties. In third section we describe the left reversing process on dual braid monoid. In section 4 we give a syntactical characterization of n -rotating normal words. In fifth section we construct, for each $n \geq 2$, a finite state automata which recognizes the language R_n of n -rotating normal words.

2. THE ROTATING NORMAL FORM

The main ingredient to define the rotating normal form is the Garside automorphism ϕ_n of B_n^{+*} defined by $\phi_n(\beta) = \delta_n \beta \delta_n^{-1}$ where $\delta_n = a_{1,2} a_{2,3} \dots a_{n-1,n}$ is the Garside braid of B_n^{+*} . In terms of Birman–Ko–Lee generators, the map ϕ_n can be defined by

$$\phi_n(a_{p,q}) = \begin{cases} a_{p+1,q+1} & \text{for } q \leq n-1 \\ a_{1,p+1} & \text{for } q = n. \end{cases} \quad (4)$$

Geometrically, ϕ_n should be viewed as a rotation, which makes sense provided braid diagrams are drawn on a cylinder rather than on a plane rectangle.

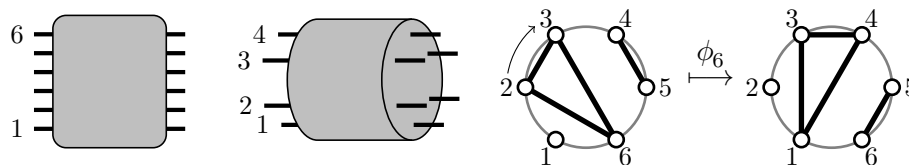

FIGURE 3. Rolling up the usual braid diagram helps us to visualize the symmetries of the braids $a_{p,q}$. On the resulting cylinder, $a_{p,q}$ naturally corresponds to the chord connecting the vertices p and q . With this representation, ϕ_n acts as a clockwise rotation of the marked circle by $2\pi/n$.

For β and γ in B_n^{+*} , we say that γ is a *right-divisor* of β , if there exists a dual braid β' of B_n^{+*} satisfying $\beta = \beta' \gamma$.

Definition 2.1. For $n \geq 3$ and β a braid of B_n^{+*} , the maximal braid β_1 lying in B_{n-1}^{+*} that right divides the braid β is called the B_{n-1}^{+*} -tail of β .

Using basic Garside properties of the monoid B_n^{+*} we obtain the following result (Proposition 2.5 of [10]) which allow us to express each braid of B_n^{+*} as a unique finite sequence of braids lying in B_{n-1}^{+*} .

Proposition 2.2. Assume $n \geq 3$. For each nontrivial braid β of B_n^{+*} there exists a unique sequence $(\beta_b, \dots, \beta_1)$ of braids of B_{n-1}^{+*} satisfying $\beta_b \neq 1$ and

$$\beta = \phi_n^{b-1}(\beta_b) \cdot \dots \cdot \phi_n(\beta_2) \cdot \beta_1, \quad (5)$$

for each $k \geq 1$, the B_{n-1}^{+*} -tail of $\phi_n^{b-k}(\beta_b) \cdot \dots \cdot \phi_n(\beta_{k+1})$ is trivial. (6)

Under the above hypotheses, the sequence $(\beta_b, \dots, \beta_1)$ is called the ϕ_n -splitting of the braid β . It is shown in [10] that Condition (6) can be replaced by

$$\text{for each } k \leq 1, \beta_k \text{ is the } B_{n-1}^{+*}\text{-tail of } \phi_n^{b-k}(\beta_b) \cdot \dots \cdot \phi_n(\beta_{k-1}) \cdot \beta_k. \quad (7)$$

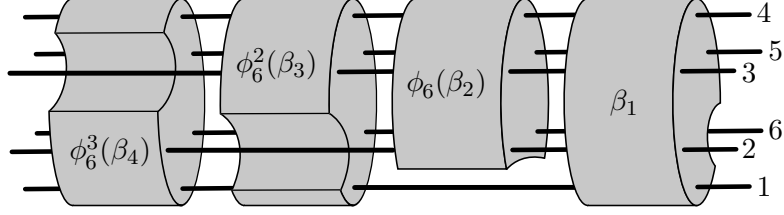

FIGURE 4. The ϕ_6 -splitting of a braid of B_6^{+*} . Starting from the right, we extract the maximal right-divisor that keeps the sixth strand unbraided, then extract the maximal right-divisor that keeps the first strand unbraided, etc.

Example 2.3. Consider the braid $\beta = a_{1,2}a_{2,3}a_{1,2}a_{2,3}$ of B_3^{+*} . Using relations (3) on the underlined factors we obtain

$$\beta = a_{1,2}a_{2,3}\underline{a_{1,2}a_{2,3}} = a_{1,2}\underline{a_{2,3}a_{1,3}}a_{1,2} = a_{1,2}a_{1,3}a_{1,2}a_{1,2}$$

We decompose β as $\phi_3(\gamma_1) \cdot \beta_1$ with $\gamma_1 = \phi_3^{-1}(a_{1,2}a_{1,3}) = a_{1,3}a_{2,3}$ and $\beta_1 = a_{1,2}a_{1,2}$. The braid $\phi_3(\gamma_1) = a_{1,2}a_{2,3}$ is exactly the one of (6) for $n = 3$ and $k = 1$. As the word $a_{1,3}a_{2,3}$ is alone in its equivalency class the braid $\phi_3(\gamma_1)$ is not right divisible by $a_{1,2}$ and so its B_2^{+*} -tail is trivial. Considering γ_1 instead of β we obtain $\gamma_1 = \phi_3(\gamma_2) \cdot \beta_2$ with $\gamma_2 = \phi_3^{-1}(a_{1,3}a_{2,3}) = a_{2,3}a_{1,2}$ and $\beta_2 = 1$. The braid $\phi_3(\gamma_2) = a_{1,3}a_{2,3}$ is the braid of (6) for $n = 3$ and $k = 2$ and it is always alone in its equivalency class, implying that its B_2^{+*} -tail is trivial. We express γ_2 as $\phi_3(\gamma_3) \cdot \beta_3$ with $\gamma_3 = \phi_3^{-1}(a_{2,3}) = a_{1,2}$ and $\beta_3 = a_{1,2}$. Since γ_3 equals $a_{1,2}$ we obtain $\gamma_4 = 1$ and $\beta_4 = a_{1,2}$. We conclude that the ϕ_3 -splitting of β is $(a_{1,2}, a_{1,2}, 1, a_{1,2}^2)$.

Before giving the the definition of the rotating normal we fix some definitions about words.

Definition 2.4. A word on the alphabet A_n is called an A_n -word. A word on the alphabet $A_n^\pm = A_n \sqcup A_n^{-1}$ is called an A_n^\pm -word. The braid represented by an A_n^\pm -word w is denoted by \overline{w} . For w, w' two A_n^\pm -word, we say that w is equivalent to w' , denoted by $w \equiv w'$ if $\overline{w} = \overline{w'}$ holds. The empty word is denoted by ε .

The n -rotating normal form is an injective map r_n from B_n^{+*} to the set of A_n -word defined inductively using the ϕ_n -splitting.

Definition 2.5. For $\beta \in B_2^{+*}$, we define $r_2(\beta)$ to be the unique word $a_{1,2}^k$ representing β . The rotating normal form of a braid $\beta \in B_n^{+*}$ with $n \geq 3$ is

$$r_n(\beta) = \phi_n^{b-1}(r_{n-1}(\beta_b)) \cdot \dots \cdot \phi_n(r_{n-1}(\beta_2)) \cdot r_{n-1}(\beta_1),$$

where $(\beta_b, \dots, \beta_1)$ is the ϕ_n -splitting of β . A word w is said to be n -rotating if it is the n -rotating normal form of a braid of B_n^{+*} .

As the n -rotating normal form of a braid of B_{n-1}^{+*} is equal to its $(n-1)$ -rotating normal form we can talk without ambiguities of the *rotating normal form* of a dual braid.

Example 2.6. We reconsider the braid β of Example 2.3. We know that the ϕ_3 -splitting of β is $(a_{1,2}, a_{1,2}, 1, a_{1,2}^2)$. Since $r_2(1) = \varepsilon$, $r_2(a_{1,2}) = a_{1,2}$ and $r_2(a_{1,2}^2) = a_{1,2}^2$ we obtain

$$r_3(\beta) = \phi_3^3(a_{1,2}) \cdot \phi_3^2(a_{1,2}) \cdot \phi_3(\varepsilon) \cdot a_{1,2}^2 = a_{1,2}a_{1,3}a_{1,2}a_{1,2}.$$

Some properties of the rotating normal form have been established in [10]. The connections, established in [9] and [10], between the rotating normal form and the braid's ordering introduced by P. Dehornoy are based on these properties.

We finish this section with some already known or immediate properties about ϕ_n -splittings and n -rotating words.

Definition 2.7. For every nonempty word w , the last letter of w is denoted by $w^\#$. For each nontrivial braid β in B_n^{+*} , we define the *last letter* of β , denoted $\beta^\#$, to be the last letter in the rotating normal form of β .

Lemma 2.8 (Lemma 3.2 of [10]). *Assume $n \geq 3$ and let $(\beta_b, \dots, \beta_1)$ be a ϕ_n -splitting*

- (i) *For $k \geq 2$, the letter $\beta_k^\#$ is of type $a_{\dots, n-1}$ unless $\beta_k = 1$.*
- (ii) *For $k \geq 3$ and $k = b$, we have $\beta_k \neq 1$.*

The fact that β_b is not trivial is a direct consequence of the definition of ϕ_n -splitting. As, for $k \geq 2$, the braid $\beta' = \phi_n(\beta_{k+1}^\#)\beta_k$ is a right-divisor of $\phi_n^{b-k}(\beta_b) \cdot \dots \cdot \beta_k$, it must satisfy some properties. In particular, if $\beta_{k+1}^\# = a_{p-1, n-1}$ holds then the B_{n-1}^{+*} -tail of $\phi_n(a_{p,n}\beta_k)$ is trivial by (6).

Definition 2.9. We say that a letter $a_{r,s}$ is an $a_{p,n}$ -barrier if $1 \leq r < p < s \leq n-1$ holds.

There exist no $a_{p,n}$ -barrier with $n \leq 3$ and the only $a_{p,4}$ -barrier is $a_{1,3}$, which is an $a_{2,4}$ -barrier. By definition, if the letter x is an $a_{p,n}$ -barrier, then in the presentation of B_n^{+*} there exists no relation of the form $a_{p,n} \cdot x = y \cdot a_{p,n}$ allowing one to push the letter $a_{p,n}$ to the right through the letter x : so, in some sense, x acts as a barrier.

Lemma 2.10 (Lemma 3.4 of [10]). *Assume that $n \geq 3$, β is a braid of B_{n-1}^{+*} and the B_{n-1}^{+*} -tail of $\phi_n(a_{p,n}\beta)$ is trivial for $2 \leq p \leq n-2$. Then the rotating normal form of β is not the empty word and it contains an $a_{p,n}$ -barrier.*

Lemma 2.11 (Lemma 3.5 of [10]). *Let $(\beta_b, \dots, \beta_1)$ be a ϕ_n -splitting of some braid of B_n^{+*} with $n \geq 3$. Then for each $k \in [2, b-1]$ such that $\beta_{k+1}^\#$ is not $a_{n-2, n-1}$ (if any), the rotating normal form of β_k contains an $\phi_n(\beta_{k+1}^\#)$ -barrier.*

3. LEFT REVERSING FOR DUAL BRAID MONOID

Left reversing process was introduced by P. Dehornoy in [5]. It can be useful to investigate division property in some monoids as stated by Proposition 3.6.

Definition 3.1. A monoid M defined by a presentation $\langle S | R \rangle^+$ is *left complemented* if there exists a map $f : S \times S \rightarrow S^*$ satisfying

$$R = \{f(x, y)x = f(y, x)y \mid (x, y) \in S^2\}$$

and if $f(x, x) = \varepsilon$ holds for all $x \in S$.

As the relation $x = x$ is always true for $x \in S$ we will say that M is left complemented even if $x = x$ does not occur in R for $x \in S$.

The monoid B_3^{+*} with presentation of Proposition 1.1 is left complemented by

$$\begin{aligned} f(a_{1,2}, a_{2,3}) &= f(a_{1,2}, a_{1,3}) = a_{1,3} \\ f(a_{2,3}, a_{1,2}) &= f(a_{2,3}, a_{1,3}) = a_{1,2} \\ f(a_{1,3}, a_{1,2}) &= f(a_{1,3}, a_{2,3}) = a_{2,3} \end{aligned}$$

However the monoid B_4^{+*} with presentation of Proposition 1.1 is not left complemented. Indeed there is no relation of the form $\dots a_{1,3} = \dots a_{2,4}$. Hence the words $f(a_{1,3}, a_{2,4})$ and $f(a_{2,4}, a_{1,3})$ are not defined.

In general for $1 \leq p < r < q < s \leq n$, the word $f(a_{p,q}, a_{r,s})$ and $f(a_{r,s}, a_{p,q})$ are not defined for the presentation of B_n^{+*} given in Proposition 1.1. In order to obtain a left complemented presentation of B_n^{+*} we must exhibit some extra relations from these given in Proposition 1.1.

By example, the relation $a_{2,3}a_{1,4}a_{1,3} \equiv a_{3,4}a_{1,2}a_{2,4}$ holds and so we can consider $f(a_{1,3}, a_{2,4})$ to be $a_{2,3}a_{1,4}$. However the relation $a_{1,4}a_{2,3}a_{1,3} \equiv a_{3,4}a_{1,2}a_{2,4}$ is also satisfied and so $f(a_{1,3}, a_{2,4}) = a_{2,3}a_{1,4}$ is an other valid choice.

Lemma 3.2. *For $n \geq 2$, the map $f_n : A_n \times A_n \rightarrow A_n^*$ defined by*

$$f_n(a_{p,q}, a_{r,s}) = \begin{cases} \varepsilon & \text{for } a_{p,q} = a_{r,s}, \\ a_{p,s} & \text{for } q = r, \\ a_{s,q} & \text{for } p = r \text{ and } q > s, \\ a_{r,p} & \text{for } q = s \text{ and } p > r, \\ a_{r,q}a_{p,s} & \text{for } p < r < q < s, \\ a_{s,q}a_{r,p} & \text{for } r < p < s < q, \\ a_{r,s} & \text{otherwise.} \end{cases}$$

provides a structure of left complemented monoid to B_n^{+*} .

Proof. Direct computations using Proposition 1.1 establish $f_n(x, y) \cdot x \equiv f_n(y, x) \cdot y$ for all $(x, y) \in A_n^2$. \square

Our choice for $f_n(a_{p,q}, a_{r,s})$ with $p < r < q < s$ is well suited for the sequel and some proof would be invalid if we have made an other one.

Definition 3.3. For w and w' two A_n^\pm -words, we say that w *left reverses in one step* to w' , denoted $w \curvearrowright^1 w'$, if we can obtain w' from w substituting a factor xy^{-1} (with $x, y \in A_n$) by $f_n(x, y)^{-1}f_n(y, x)$. We say that w *left reverses* to w' , denoted by $w \curvearrowright w'$, if there exists a sequence $w = w_1, \dots, w_\ell = w'$ of A_n^\pm -words such that $w_k \curvearrowright^1 w_{k+1}$ for $k \in [1, \ell - 1]$.

Example 3.4. The word $u = a_{1,2}a_{2,3}a_{1,2}a_{1,3}^{-1}$ left reverses to $a_{2,3}a_{2,3}$ as the following left reversing sequence shows (left reversed factor are underlined)

$$a_{1,2}a_{2,3}\underline{a_{1,2}a_{1,3}^{-1}} \curvearrowright^1 a_{1,2}\underline{a_{2,3}a_{1,3}^{-1}}a_{2,3} \curvearrowright^1 \underline{a_{1,2}a_{1,2}^{-1}}a_{2,3}a_{2,3} \curvearrowright^1 a_{2,3}a_{2,3},$$

which is denoted by $a_{1,2}a_{2,3}a_{1,2}a_{1,3}^{-1} \curvearrowright a_{2,3}a_{1,2}$.

Definition 3.5. For w an A_n^\pm -word, we denote by $D(w)$ and $N(w)$ the unique A_n -words, if it exist, such that $w \curvearrowright D(w)^{-1}N(w)$. The word $N(w)$ is the *left numerator* of w while the word $D(w)$ is its *left denominator*.

Reconsidering Example 3.4, we obtain that the left denominator of u is $D(u) = \varepsilon$ and that its left numerator is $N(u) = a_{2,3}a_{2,3}$.

A consequence of Example 8 and Proposition 3.5 of [7] based on [5] and [3] is that $N(w)$ and $D(w)$ exists for any A_n^\pm -word w together with the following result:

Proposition 3.6. *Let w be a A_n word and $a_{p,q} \in A_n$. The braid \bar{w} is right divisible by $a_{p,q}$ if and only if $D(w \cdot a_{p,q}^{-1})$ is empty.*

Since the denominator of $a_{1,2}a_{2,3}a_{1,2}a_{1,3}^{-1}$ is empty, the braid $a_{1,3}$ right divides the braid $a_{1,2}a_{2,3}a_{1,2}$.

4. CHARACTERIZATION OF ROTATING NORMAL WORDS

The aim of this section is to give a syntactical characterization of n -rotating words among A_n -words.

Lemma 4.1. *For β in B_n^{+*} there is equivalence between*

- (i) *an A_n -word representing β contains an $a_{p,n}$ -barrier,*
- (ii) *every A_n -word representing β contains an $a_{p,n}$ -barrier.*

Proof. Clearly (ii) implies (i). For (i) \Rightarrow (ii) it is sufficient to prove that relations of Proposition 1.1 preserve $a_{p,n}$ -barriers. For relation (2) this is immediate since it conserves involved letters. If one of the three words $a_{r,s}a_{s,t}$, $a_{s,t}a_{r,s}$ and $a_{r,t}a_{r,s}$ of relation (3) contains one $a_{p,n}$ -barrier then the two others also, as illustrated by the following chord diagram (the chord of an $a_{p,n}$ -barrier intersects properly the chord of the letter $a_{p,n}$.)

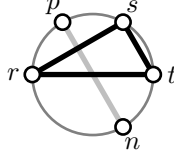

□

As a consequence, containing an $a_{p,n}$ -barrier is not a word property but a braid one.

Lemma 4.2. *Assume that $n \geq 3$, β belongs to B_{n-1}^{+*} and that the B_{n-1}^{+*} -tail of $\phi_n(\beta)$ is trivial. Then every A_{n-1} representing β ends with $\beta^\#$.*

Proof. Let u be an A_{n-1} -word representing β . As the B_{n-1}^{+*} -tail of $\phi_n(\beta)$ is trivial, the last letter $u^\#$ of u not belongs to A_{n-2} and so $u^\#$ is $a_{p,n-1}$ for some integer $p < n - 1$. Assume now v is another A_{n-1} -word representing β . For the same reason as u , we have $v^\# = a_{q,n-1}$ for some $q < n - 1$. Since the two braids $a_{p,n-1}$ and $a_{q,n-1}$ are right divisors of β , their left lcm is also a right divisor of β . Assume for a contradiction that p and q are different. The braid β is then right divisible by $a_{p,q}a_{q,n-1}$, which is the left lcm of $a_{p,n-1}$ and $a_{q,n-1}$. Since $a_{p,q}a_{q,n-1}$ is equivalent to $a_{p,n-1}a_{p,q}$, the braid $a_{p,q}$ is also a right divisor of β . In particular $a_{p+1,q+1}$, with $q + 1 < n$, is a right divisor of $\phi_n(\beta)$, which is impossible since the B_{n-1}^{+*} -tail of $\phi_n(\beta)$ is supposed to be trivial. Therefore, every A_{n-1} -word representing β ends with the same letter, namely $\beta^\#$. □

We conclude that, under some hypotheses, the last letter of a word is a braid invariant.

Definition 4.3. For $n \geq 3$ and $2 \leq p \leq n - 1$, we say that an n -rotating word w is an $a_{p,n}$ -ladder if there exist a decomposition

$$w = v_0 x_1 v_1 \dots v_{h-1} x_h v_h,$$

a sequence $p = j(0) < j(1) < \dots < j(h) = n - 1$ and a sequence i such that

- (i) for each $k \leq h$, the letter x_k is $a_{i(k),j(k)}$ with $i(k) < j(k-1) < j(k)$,
- (ii) for each $k < h$, the word v_k contains no $a_{j(k),n}$ -barrier,

Condition (ii) is equivalent to: for each $k \leq h$, the letter x_k is an $a_{j(k-1),n}$ -barrier of type $a_{\dots,j(k)}$.

An immediate adaptation of Proposition 3.9 of [10] is :

Lemma 4.4. *Assume that $n \geq 3$, β belongs to B_{n-1}^{+*} , the B_{n-1}^{+*} -tail of $\phi_n(\beta)$ is trivial and β contains an $a_{p,n}$ -barrier for some $2 \leq p \leq n - 2$. Then the normal form of β is an $a_{p,n}$ -ladder.*

In order to obtain a syntactical characterization of n -rotating words we want a local version of condition (6) characterizing a ϕ_n -splitting. The following result is the first one in this way.

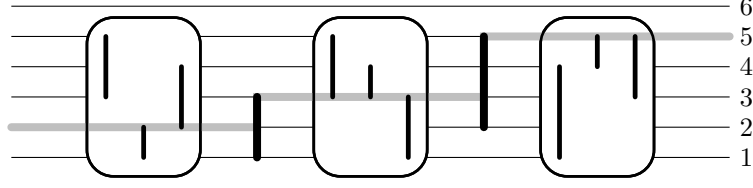

FIGURE 5. An $a_{2,6}$ -ladder. The gray line starts at position 1 and goes up to position 5 using the bar of the ladder. The empty spaces between bars in the ladder are represented by a framed box. In such boxes the vertical line representing the letter $a_{i,j}$ does not cross the gray line. The bar of the ladder are represented by black thick vertical lines.

Proposition 4.5. For $\beta \in B_{n-1}^{+*}$ and p an integer satisfying $2 \leq p \leq n-2$ there is equivalence between

- (i) the B_{n-1}^{+*} -tail of $\phi_n(a_{p,n}\beta)$ is trivial,
- (ii) the B_{n-1}^{+*} -tail of $\phi_n(\beta)$ is trivial and β contains an $a_{p,n}$ -barrier,
- (iii) the only A_n -letter that right divides $a_{p,n}\beta$ is $\beta^\#$, which is of type $a_{\dots,n-1}$.

Our proof of Proposition 4.5 rests on the following Lemma.

Lemma 4.6. For $n \geq 3$, u an A_{n-1} -word and $p \in [1, n-1]$, the left denominator $D(ua_{p,n}^{-1})$ is not empty. More precisely, $D(ua_{p,n}^{-1})^{-1}$ begins with $a_{q,n}^{-1}$ satisfying $q \leq p$.

Proof. Assume that w_1, \dots, w_ℓ is a reversing sequence from the word $w_1 = ua_{p,n}^{-1}$ to the word $D(w_1)^{-1}N(w_1)$. For $k \in [1, \ell]$ we denote by y_k the leftmost negative letter in w_k . Each reversing step consists in replacing a factor xy^{-1} of w_k by $f_n(x, y)^{-1}f_n(y, x)$. If for $k \in [1, \ell]$ the reversed factor of w_k does not contains y_k^{-1} then y_{k+1} equals y_k . Assume now that the reversed factor is xy_k^{-1} with $y_k = a_{r,n}$. Lemma 3.2 implies

$$f_n(x, y_k) = f_n(a_{i,j}, a_{r,n}) = \begin{cases} a_{i,n} & \text{for } j = r, \\ a_{r,j}a_{i,n} & \text{for } i < r < j, \\ a_{r,n} & \text{otherwise,} \end{cases}$$

which gives in particular

$$xy_k^{-1} = a_{i,j}a_{r,n}^{-1} \curvearrowright \begin{cases} a_{i,n}^{-1}\dots & \text{for } i < r \leq j, \\ a_{r,n}^{-1}\dots & \text{otherwise.} \end{cases} \quad (8)$$

It follows that y_{k+1} is equal to $a_{s,n}$ for some $s \leq r$. Eventually we obtain that $ua_{p,n}^{-1}$ left reverse to $a_{q,n}^{-1}\dots$ with the relation $q \leq p$ and so the desired property on $D(ua_{p,n})$ holds. \square

Proof of Proposition 4.5. Assume (i). As the the B_{n-1}^{+*} -tail of $\phi_n(\beta)$ is also a right divisor of $\phi_n(a_{p,n}\beta)$ the first statement of (ii) holds. The second statement is Lemma 2.10. Let us prove that (iii) implies (i). By hypothesis

the last letter of β is $a_{q-1,n-1}$ for some q . As the only A_n -letter that right divides $\phi_n(a_{p,n}\beta)$ is $\phi_n(a_{q-1,n-1}) = a_{q,n}$, the B_{n-1}^{+*} -tail of $\phi_n(a_{p,n}\beta)$ must be trivial.

We now prove (ii) \Rightarrow (iii). Since the B_{n-1}^{+*} -tail of $\phi_n(\beta)$ is trivial, the letter $\beta^\#$ must be of type $a_{\dots,n-1}$. We denote by w the rotating normal from of β . Let $a_{r,s}$ be an A_n -letter different from $\beta^\#$. We will show that $a_{r,s}$ cannot be a right divisor of $a_{p,n}\beta$. Assume first $s \leq n-1$. By Lemma 4.2, $a_{r,s}$ is not a right divisor of β . Proposition 3.6 implies that the word $D(w a_{r,s}^{-1})$ must be non empty. As the reversing of an A_{n-1}^\pm -word is an A_{n-1}^\pm -word, there exists a letter $a_{t,t'}$ with $t' < n$ such that

$$a_{p,n} w a_{r,s}^{-1} \curvearrowright a_{p,n} a_{t,t'}^{-1} \dots$$

Clearly, the braid $a_{t,t'}$ is not a right divisor of $a_{p,n}$ (since $t' < n$ holds). Therefore, by Proposition 3.6, the left denominator of $a_{p,n} w a_{r,s}^{-1}$ is not empty, and we conclude that $a_{r,s}$ is not a right divisor of $a_{p,n}\beta$.

Assume now $s = n$. Hypotheses on β plus Lemma 4.4 implies that w is an $a_{p,n}$ -ladder. Following Definition 4.3, we write

$$w = v_0 x_1 v_1 \dots v_{h-1} x_h v_h.$$

By Lemma 4.6, there exist two maps η and μ from \mathbb{N} to itself such that

$$w a_{r,n}^{-1} = w_h a_{\eta(h),n}^{-1} \curvearrowright w'_h a_{\mu(h),n}^{-1} \cdots \curvearrowright \dots \curvearrowright w_0 a_{\eta(0),n}^{-1} \cdots \curvearrowright w'_0 a_{\mu(0),n}^{-1},$$

where for all $k \in [0, h]$,

$$\begin{aligned} w_k &= v_0 x_1 v_1 \dots v_{k-1} x_k v_k, \\ w'_k &= v_0 x_1 v_1 \dots v_{k-1} x_k. \end{aligned}$$

By construction w_0 is v_0 while w'_0 is the empty word. Lemma 4.6 implies

$$\mu(0) \leq \eta(0) \leq \mu(1) \leq \dots \leq \mu(h) \leq \eta(h) = r. \quad (9)$$

Following Definition 4.3 we write $x_k = a_{i(k),j(k)}$. We will now prove by induction

$$\text{for all } k \in [0, h-1], \mu(k+1) \leq j(k+1) \Rightarrow \eta(k) < j(k) \quad (10)$$

Let $k \in [0, h-1]$ and assume $\mu(k+1) \leq j(k+1)$. Definition 4.3 (i) guarantees the relation $i(k+1) < j(k) < j(k+1)$. For $\mu(k+1) \leq i(k+1)$ we have

$$\eta(k) \leq \mu(k+1) \leq i(k+1) < j(k),$$

and we are done in this case. The remaining case is $\mu(k+1) > i(k+1)$. By relation (8), with $i = i(k+1)$, $j = j(k+1)$ and $r = \eta(k+1)$ we obtain

$$x_{k+1} a_{\mu(k+1),n}^{-1} = a_{i(k+1),j(k+1)} a_{\mu(k+1),n}^{-1} \curvearrowright a_{i(k+1),n}^{-1} v$$

with some A_n^\pm -word v . In particular, we have $\eta(k) = i(k+1) < j(k)$ and (10) is established. For $k = h-1$ the left hand member of (10) is satisfied since $j(h)$ is equal to $n-1$ and $r \leq n-1$ holds by definition of r . Properties (9) and (10) imply $\mu(k) < j(k)$ for all $k \in [0, h-2]$. In particular

we have $\mu(0) < j(0) = p$ together with $wa_{r,n}^{-1} \curvearrowright a_{\mu(0),n}^{-1} \cdots$. As $a_{\mu(0),n}$ can not be a right divisor of $a_{p,n}$ it follows that the left denominator of $a_{p,n} w a_{r,n}^{-1}$ is also non empty and so that $a_{r,n}$ is not a right divisor of $a_{p,n}\beta$. \square

As the reader can see, the case $p = n - 1$ is excluded from Proposition 4.5. It is the aim of the following result.

Proposition 4.7. *For β a non-trivial braid of B_{n-1}^{+*} there is equivalence between*

- (i) *the B_{n-1}^{+*} -tail of $\phi_n(a_{n-1,n}\beta)$ is trivial,*
- (ii) *the only A_n^\pm -letter right dividing $a_{n-1,n}\beta$ is $\beta^\#$ which is of type $a_{\dots,n-1}$.*

Proof. (ii) \Rightarrow (i) is similar as (iii) \Rightarrow (i) of Proposition 4.7. We now show that (i) implies (ii). Condition (i) implies in particular that the B_{n-1}^{+*} -tail of $\phi_n(\beta)$ is trivial. It follows that the last letter of β is of type $a_{\dots,n-1}$. Let w be the rotating normal form of β and $a_{r,s}$ be an A_n^\pm -letter different from $\beta^\#$. For $s \leq n - 1$ we follow proof of Proposition 4.7 to obtain that $a_{r,s}$ is not a right divisor or the braid $a_{n-1,n}$. Assume now $s = n$. By Lemma 4.6 it exists $q \leq r$ such that $wa_{r,n}^{-1} \curvearrowright a_{q,n}^{-1} \cdots$ and so $a_{n-1,n}wa_{r,n}^{-1} \curvearrowright a_{n-1,n}a_{q,n}^{-1} \cdots$. As, for $q \neq n - 1$ the braid $a_{q,n-1}$ is not a right divisor of $a_{n-1,n}$ it is sufficient to show $q \neq n - 1$ to conclude that $a_{r,n}$ not right divides $a_{n-1,n}\beta$. For $r \leq n - 2$ it is obvious since $q \leq r$ holds. Assume finally $r = n - 1$. We denote by $a_{p,n-1}$ the last letter of β . By (8) we have $a_{p,n-1}a_{n-1,n}^{-1} \curvearrowright a_{p,n}^{-1} \cdots$ and then Lemma 4.6 implies $q \leq p < n - 1$, as expected. \square

Theorem 4.8. *A finite sequence $(\beta_b, \dots, \beta_1)$ of braids in B_{n-1}^{+*} is the ϕ_n -splitting of a braid of B_n^{+*} if and only if*

- (i) *for $k \geq 3$ and $k = b$, the braid β_k is not trivial,*
- (ii) *for $k \geq 2$, the B_{n-1}^{+*} -tail of $\phi_n(\beta_k)$ is trivial,*
- (iii) *if, for $k \geq 3$, we have $\beta_k^\# \neq a_{n-2,n-1}$ then β_{k-1} contains an $\phi_n(\beta_k^\#)$ -barrier.*

Proof. Let $(\beta_b, \dots, \beta_1)$ be the ϕ_n -splitting of some braid of B_{n-1}^{+*} . Condition (i) is a consequence of Lemma 2.8.(ii). Condition (6) implies that the B_{n-1}^{+*} -tail of

$$\phi_n^{b-k}(\beta_b) \cdot \dots \cdot \phi_n(\beta_{k+1})$$

is trivial for $k \geq 1$. In particular the B_{n-1}^{+*} -tail of $\phi_n(\beta_{k+1})$ must be trivial for $k \geq 1$, which implies (ii). Condition (iii) is Lemma 2.11.

Conversely, let us prove that a sequence $(\beta_b, \dots, \beta_1)$ of braids of B_{n-1}^{+*} satisfying (i), (ii) and (iii) is the ϕ_n -splitting of a braid of B_n^{+*} . Condition (i) implies that β_b is not trivial. For $k \geq 2$ we denote by γ_k the braid $\phi_n^{b-k}(\beta_b) \cdot \dots \cdot \phi_n(\beta_{k+1}) \cdot \beta_k$. For $k \geq 3$ and $k \geq 2$ whenever $\beta_2 \neq 1$, we first prove

$$\beta_k^\# \text{ is the only } A_n\text{-letter that right divides } \gamma_k. \quad (11)$$

We note that Condition (i) guarantees the existence of $\beta_k^\#$ for $k \geq 3$. For $k = b$, Condition (ii) implies that the B_{n-1}^{+*} -tail of $\phi_n(\beta_b)$ is trivial. Hence, by Lemma 4.2 the only A_{n-1} -letter that right divides β_b is $\beta_b^\#$.

Since any right divisors of a braid of B_{n-1}^{+*} lies in B_{n-1}^{+*} , we have established (11) for $k = b$. Assume (11) holds for $k \geq 4$ or $k \geq 3$ whenever $\beta_2 \neq 1$ and let us prove it for $k - 1$. By Condition (ii) it exists p such that $\beta_k^\#$ is $a_{p-1, n-1}$. We denote by $ua_{p-1, n-1}$ and by v two A_n -words representing γ_k and β_{k-1} respectively. The braid γ_{k-1} is then represented by $\phi_n(u)a_{p, n}v$. Let y be an A_n -letter different from $\beta_{k-1}^\#$. Proposition 4.5 with Condition (iii) and Proposition 4.7 imply that y is not a right divisor of $a_{p, n}\beta_{k-1}$. Therefore, by Proposition 3.6 it exist an A_n -letter x different from $a_{p, n}$ such that $\phi_n(u)a_{p, n}vy^{-1} \curvearrowright \phi_n(u)a_{p, n}x^{-1} \dots$. The word $\phi_n(u)a_{p, n}$ represents $\phi_n(\gamma_k)$. By induction hypothesis x is not a right divisor of $\phi_n(\gamma_k)$. Then Proposition 3.6 implies $D(\phi_n(u)a_{p, n}x^{-1})$ is not empty. It follows $D(\phi_n(u)a_{p, n}vy^{-1}) \neq \varepsilon$ and so always by Proposition 3.6, the letter y is not a right divisor of γ_{k-1} . Eventually we have established (11) for $k \geq 3$.

A direct consequence of (11) and Condition (ii) is that the only A_n -letter right dividing $\phi_n(\gamma_k)$ is of type $a_{\dots, n}$ and so the B_{n-1}^{+*} -tail of the braid γ_k is trivial for $k \geq 3$ and for $k = 2$ whenever $\beta_k \neq 1$. It remains to establish that the B_{n-1}^{+*} tail of $\phi_n(\gamma_2)$ is also trivial whenever β_2 is trivial. Assume $\beta_2 = 1$. Condition (iii) implies $\beta_3^\# = a_{n-2, n-1}$. By (11), $a_{n-2, n-1}$ is the only A_n -letter that right divides the braid γ_3 . Since $\gamma_2 = \phi_n(\gamma_3)$, the letter $\phi_n^2(a_{n-2, n-1}) = a_{1, n}$ is the only letter right dividing $\phi_n(\gamma_2)$. In particular the B_{n-1}^{+*} -tail of $\phi_n(\gamma_2)$ is trivial. \square

Conditions (i), (ii) and (iii) are easy to check if the braids β_1, \dots, β_b are given by their rotating normal forms.

Corollary 4.9. *Let (w_b, \dots, w_1) be a finite sequence of A_{n-1} -words, then the word*

$$\phi_n^{b-1}(w_b) \cdot \dots \cdot \phi_n(w_2) \cdot w_1, \quad (12)$$

is n -rotating if the following conditions are satisfied

- (i) for $k \geq 1$, the word w_k is $(n - 1)$ -rotating,
- (ii) for $k \geq 3$, the word w_k ends by $a_{p-1, n-1}$ for some p ,
- (iii) the word w_2 is either empty (except for $b = 2$) or ends by $a_{p-1, n-1}$

for some p ,

(iv) *if, for $k \geq 3$, the word w_k ends by $a_{p-1, n-1}$ with $p \neq n - 1$ then the word w_{k-1} contains an $a_{p, n}$ -barrier.*

Proof. Assume that (w_b, \dots, w_1) satisfies Conditions (i)-(iv) and let us prove that the word w defined at (12) is rotating.

We denote by β_i (resp. β) the braid represented by w_i (resp. w). By Condition (i) and Definition 2.5, the word w is rotating if and only if $(\beta_b, \dots, \beta_1)$ is a ϕ_n -splitting. Conditions (ii) and (iii) imply Condition (i) of Theorem 4.8. Theorem 4.8.(iii) is a consequence of (ii) and (iv). We remark that the B_{n-1}^{+*} -tail of a braid γ is represented by a suffix of the rotating word of γ . If the B_{n-1}^{+*} -tail of $\phi_n(\beta_k)$ is not trivial, then there exists $a_{p, q}$ with $1 \leq p < q < n$ that right divides $\phi_n(\beta_k)$. As β_k lies in B_{n-1}^{+*} , we have $p \neq 1$ and therefore β_k is right divisible by $a_{p-1, q-1}$ with $q - 1 \leq n - 2$. Assume

the B_{n-1}^{+*} -tail of w_k is not trivial for $k \geq 2$. The previous remark implies that w_k must end with a letter $a_{i,j}$ satisfying $j \leq n - 2$, which is in contradiction with conditions (ii) and (iii). \square

It is not true that any decomposition of an n -rotating word as in (12) satisfies conditions (i) – (iv) of Corollary 12. However we have the following result.

Proposition 4.10. *For every n -rotating word w with $n \geq 3$ there exists a unique sequence (w_b, \dots, w_1) of $(n - 1)$ -rotating words such that w decompose as in (12) and conditions (ii) – (iv) of 4.9 hold.*

Proof. By definition of a rotating normal word and by Lemma 2.8 such a sequence exists. Let us prove now the unicity. Assume w is a n -rotating normal word and that (w_b, \dots, w_1) and (w'_c, \dots, w'_1) are two different sequences of $(n - 1)$ -rotating normal words satisfying condition (ii) and (iii) of Corollary 4.9. Let k be the minimal integer satisfying $w_k \neq w'_k$. Since the sum of word lengths of the two sequences are the same, we have $k \leq \min\{b, c\}$. Without loss of generality, we may assume that w'_k is a proper suffix of w_k , i.e., $w_k = u \cdot w'_k$. By conditions (ii) and (iii) of Corollary 4.9, the last letter x of u comes from the last letter of w'_{k+1} or w'_{k+2} . Hence the letter x is equal to $a_{p-1, n-1}$ for some p and w_k admits either $\phi_n(a_{p-1, n-1})w'_k = a_{p, n}w'_k$ or $\phi_n^2(a_{p-1, n-1})w'_k = a_{1, p+1}w'_k$ as suffix. The first case is impossible since w_k is an A_{n-1} -word. The second case may occur only for $k = 1$ and $w'_2 = \varepsilon$. As w'_2 is empty, the last letter of w'_3 , which is x , is equal to $a_{n-2, n-1}$. This implies that w_k admits $a_{1, n}u$ as suffix which is also impossible since it is an A_{n-1} -word. \square

A direct consequence of Corollary 4.9 and Proposition 4.10 is

Theorem 4.11. *An A_n -word w is rotating if and only if it can be expressed as in (12) subject to conditions (i) – (iv) of Corollary 4.9.*

5. REGULARITY

In this section we will show that the language of n -rotating words, denoted R_n is regular, i.e., it exists a finite state automata recognizing the n -rotating words. As the rotating normal form is defined using right division it is more natural for an automata to read word from the right. For $w = x_0 \cdot \dots \cdot x_k$ an A_n -word we will denote by $\Pi(w)$ the word $x_k \cdot \dots \cdot x_0$. By Theorem 1.2.8 of [8] the language R_n is regular if and only if the language $\Pi(R_n)$ is. In this section we will construct an automata recognizing $\Pi(R_n)$.

For us a *finite state automata* is a quintuplet $(S \cup \{\otimes\}, A, \mu, Y, i)$ where S is a finite set of *states*, A is a finite *alphabet*, $\mu : S \times A \rightarrow S$ is the *transition function*, $Y \subseteq S$ is *acceptating states* and i is the *initial state*. In this paper each automata is equipped with an undraw dead state \otimes and all states except the dead one is acceptating, i.e., $Y = S$ always hold. Therefore an automata will be briefly denoted by $\mathcal{A} = (S, A, \mu, i)$. To describe \mathcal{A} it is enough to

describe μ on $(s, x) \in S \times A$ where $\mu(s, x) \neq \otimes$ and $s \neq \otimes$. By example an automata recognizing the language R_2 is $\mathcal{A}_2 = (\{1\}, \{a_{1,2}\}, \mu_2, 1)$ with $\mu_2(1, a_{1,2}) = 1$. The corresponding automata diagram is :

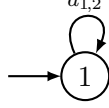

The horizontal arrow points to the initial state.

Proposition 5.1. An A_3 -word $x_b^{e_b} \cdot \dots \cdot a_{1,3}^{e_3} a_{2,3}^{e_2} a_{1,2}^{e_1}$ where

$$x_b = \begin{cases} a_{1,2} & \text{if } b \equiv 1 \pmod{3}, \\ a_{2,3} & \text{if } b \equiv 2 \pmod{3}, \\ a_{1,3} & \text{if } b \equiv 3 \pmod{3}. \end{cases}$$

is rotating if and only if $e_k \neq 0$ for all $k \geq 3$.

Proof. The 2-rotating words are powers of $a_{1,2}$. Let w be the word of the statement. Defining w_k to be $a_{1,2}^{e_k}$, we obtain

$$w = \phi_n^{b-1}(w_b) \cdot \dots \cdot \phi_n(w_2) \cdot w_1.$$

As there is no barrier in B_3^{+*} , the word w is rotating if and only if it satisfies conditions (ii) and (iii) of Corollary 4.9, i.e., the exponent e_k is not 0 for $k \geq 3$. \square

As a consequence the following automata recognize the language $\Pi(R_3)$:

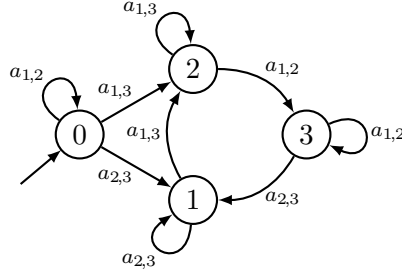

Unfortunately, for $n \geq 4$ there is no so simple characterization of n -rotating words. We will describe an inductive construction for an automata recognizing language $\Pi(R_n)$. The process will be illustrated on $n = 4$. The first step is to focus on n -rotating words ending with a letter of type $a_{\dots n}$.

Definition 5.2. We denote by R_n^* the language of n -rotating words which are empty or ends with a letter of the form $a_{p,n}$ for some p .

Before constructing an automata \mathcal{A}_n recognizing the language $\Pi(R_n)$, we construct by induction on $n \geq 3$ an automata \mathcal{A}_n^* for the language $\Pi(R_n^*)$.

Definition 5.3. A *partial automata* is a quadruplet $P = (S, A, \mu, I)$ where S , A and μ are defined as for an automata and $I : A \rightarrow S$ is a map. The closure of a partial automata P is the automata $\mathcal{A}(P) = (S \cup \{\circ\}, A, \mu^c, \circ)$ given by

$$\mu^c(s, x) = \begin{cases} I(x) & \text{if } s = \circ, \\ \mu(s, x) & \text{otherwise.} \end{cases}$$

A partial automata is represented as an automata excepted for the function I . For each $x \in A$ we draw an arrow attached to state $I(x)$ and labelled x . We say that a partial automata recognizes a given language if its closure does.

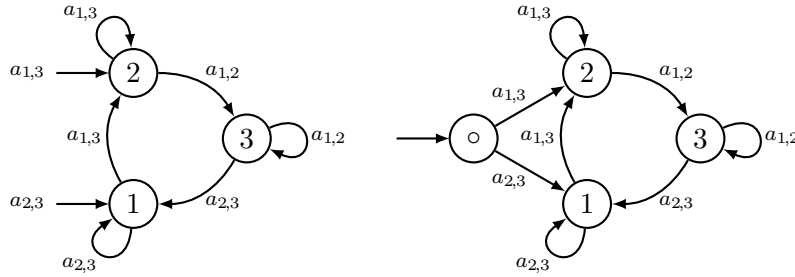

FIGURE 6. The partial automata P_3 and the corresponding closure which recognize the language $\Pi(R_3^*)$.

We will now show how to construct by induction a partial automata P_n recognizing $\Pi(R_n^*)$ for $n \geq 3$. For $n = 3$ this is already done by Figure 6. For the sequel we assume $n \geq 4$ and that $P_{n-1} = (S_{n-1}, A_{n-1}, \mu_{n-1}, I_{n-1})$ is a given partial automata that recognizes the language $\Pi(R_{n-1})$.

We define S_n^0 to be the set

$$S_n^0 = \{0\} \times (S_{n-1} \setminus \{\otimes\}) \times \mathcal{P}(\{a_{2,n}, \dots, a_{n-2,n}\}).$$

A state in S_n^0 is then written $(0, s, m)$. For $x = a_{i,j} \in A_{n-1}$ we denote by $\text{bar}(x)$ the set $\{a_{p,n} \mid i < p < j\}$.

Definition 5.4. We define $P_n^0 = (S_n^0 \cup \{\otimes\}, A_{n-1}, \mu_n^0, I_n^0)$ to be the partial automata where for all $x \in A_{n-1}$,

$$I_n^0(x) = \begin{cases} (0, I_{n-1}(x), \text{bar}(x)) & \text{if } I_{n-1}(x) \neq \otimes, \\ \otimes & \text{if } I_{n-1}(x) = \otimes. \end{cases}$$

and for all $(0, s, m) \in S_n^0$ and for all $x \in A_{n-1}$,

$$\mu_n^0((0, s, m), x) = \begin{cases} (0, \mu_{n-1}(s, x), m \cup \text{bar}(x)) & \text{if } \mu_{n-1}(s, x) \neq \otimes, \\ \otimes & \text{if } \mu_{n-1}(s, x) = \otimes. \end{cases}$$

Proposition 5.5. *The partial automata P_n^0 recognizes the language $\Pi(R_{n-1}^*)$. Moreover an accepted A_n -word $\Pi(w)$ contains an $a_{p,n}$ -barrier if and only if $P_{n,0}$ has state (s, m) with $a_{p,n} \in m$ after reading $\Pi(w)$.*

Proof. Let w be an A_n -word of length ℓ , \mathcal{A} and \mathcal{A}' be the closure of P_{n-1} and P_n^0 respectively. We denote by s_k (resp. (s'_k, m_k)) the state of automata \mathcal{A} (resp. \mathcal{A}') after reading the k -th letter of $\Pi(w)$. If w does not contains $a_{p,n}$ -barrier then (s'_k, m_k) is equal to (s_k, \emptyset) for all $k \in [1, \ell]$. Hence $\Pi(w)$ is accepted or not by the two automaton and in particular m_ℓ is the empty set. Assume now w contains an $a_{p,n}$ -barrier. Let ℓ' be the first occurrence on such a barrier in $\Pi(w)$. By construction of μ_n we have (s'_k, m_k) with $a_{p,n} \in m_k$ for $k \geq \ell'$ except if $s_k = \otimes$. As \mathcal{A} (resp. \mathcal{A}') recognizes the word $\Pi(w)$ if and only if s_ℓ (resp. s'_ℓ) is different from \otimes , the word w is recognized or not by both automaton. Moreover, in this case m_ℓ contains $a_{p,n}$. \square

As the only $a_{p,4}$ -barrier in A_4 is $a_{1,3}$, the partial automata P_4^0 is obtained from P_3 by connecting the edge labelled $a_{1,3}$ to a copy of P_3 , as illustrated on figure 5

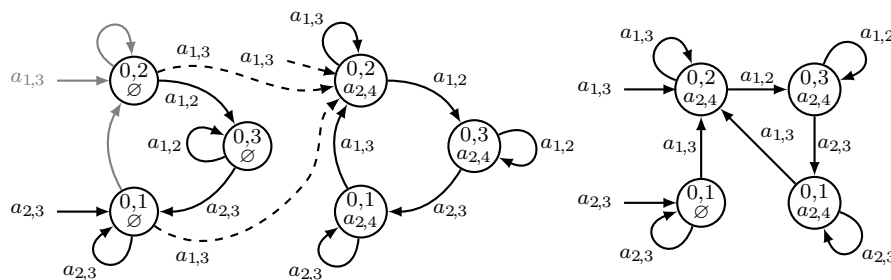

FIGURE 7. The partial automata P_4^0 . Obsolete transitions from P_3 are in gray. New added transitions are dashed. The right partial automata is P_4^0 without inaccessible states.

For $t = (0, s, m) \in S_n^0$ we define $\phi_n^k(t)$ to be (k, s, m) . We also define S_n^k to be $\phi_n^k(S_n^0)$ and

$$P_n^k = \left(S_n^k, \phi_n^k(A_{n-1}), \mu_n^k, I_n^k \right)$$

to be the partial automata given by $I_n^k(\phi_n^k(x)) = \phi_n^k(I_n^0(x))$ and

$$\mu_n^k((k, s, m), \phi_n^k(x)) = \phi_n^k(\mu_n^0((0, s, m), x))$$

with the convention $\phi_n^k(\otimes) = \otimes$. In other words, P_n^k is a obtained from P_n^0 by replacing letter x by $\phi_n^k(x)$ and state $(0, s, m)$ by (k, s, m) . We obtain immediately that P_n^k recognizes the word $\phi_n^k(\Pi(w))$ if and only if P_n^0 recognizes $\Pi(w)$.

We can now construct the partial automata P_n by plugging together n partial automaton P_n^k for $k \in [0, n-1]$ together.

Definition 5.6. We define $P_n = (S_n^* \cup \{\otimes\}, A_n, \mu_n^*, I_n)$, with $S_n^* = S_n^0 \sqcup \dots \sqcup S_n^k$ to be the partial automata given by

$$I_n(x) = \begin{cases} I_n^1(a_{p-1,n-1}) & \text{if } x = a_{p,n} \text{ with } p \neq 1, \\ I_n^2(a_{n-2,n-1}) & \text{if } x = a_{1,n}, \\ \otimes & \text{otherwise.} \end{cases}$$

and with transition function

$$\mu_n^*((k, s, m), \phi_n^k(x)) = \begin{cases} \mu_n^k((k, s, m), \phi_n^k(x)) & \text{if } x \in A_{n-1}, \\ I_n^{k+1}(\phi_n^k(x)) & \text{if } x = a_{n-1,n} \\ I_n^{k+1}(\phi_n^k(x)) & \text{if } x = a_{p,n} \text{ with } 2 \leq p \leq n-2 \\ & \text{and } a_{p,n} \in m, \\ \otimes & \text{otherwise} \end{cases}$$

with the convention $I_n^n = I_n^0$.

We can summarize the construction of the partial automata P_n on a diagram.

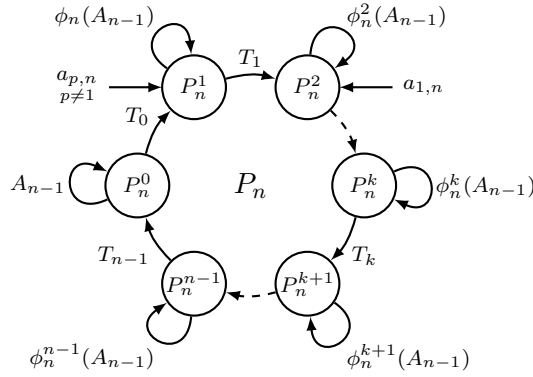

An arrow labelled T_k represents the set of transitions $\mu_n^*((k, s, m), \phi_n^k(a_{p,n}))$.

Lemma 5.7. *The partial automata P_n recognizes the language $\Pi(R_n^*)$.*

Proof. Let \mathcal{A} be the closure of P_n and w be a non empty A_n -word. There exists a unique sequence (w_b, \dots, w_1) of A_{n-1} -words such that $w_b \neq \varepsilon$, w is equal to

$$\phi_n^{b-1}(w_k) \cdot \dots \cdot \phi_n(w_2) \cdot w_1$$

and for all i , the word $\phi_n^i(w_i)$ is the maximal suffix of $\phi_n^{k-1}(w_k) \cdot \dots \cdot \phi_n^i(w_i)$ belonging to $\phi_n^i(A_{n-1})$. By definition of I_n , the word $\Pi(w)$ is accepted by P_n only if w ends by a letter $a_{p,n}$ for some i . We assume now that w is such a word. Thus the first integer j such that w_j is non empty is 2 or 3. More precisely, we have $j = 2$ if $p > 1$ and $j = 3$ if $p = 1$ holds. In both cases, the reading of $\Pi(w)$ starts by a state coming from P_n^j . The automata reach a state different from one of P_n^j if it go to the state \otimes or if it reads a letter

outside of $\phi_n^{j-1}(A_n)$, *i.e.*, a letter of $\phi_n^j(w_{j+1})$. This is a general principle : after reading a letter of $\phi_n^{i-1}(w_i)$ the automata \mathcal{A} is in state (t, s, m) with $t = i \bmod n$. By construction of P_n^t , the word $\phi_n^{i-1}(w_i)$ provides an accepted state if and only if w_i is a word of $\Pi(R_{n-1})$. At this point we have shown that $\Pi(w)$ is accepted by \mathcal{A} only if w is empty or if w satisfies $w^{\#} = a_{p,n}$ together with condition (i), (ii) and (iii) of Corollary 4.9. Let i be in $[j, k - 1]$, and assume that \mathcal{A} is in an acceptable state (t, s, m) with $t = i \bmod n$ after reading the word $\Pi(\phi_n^{i-1}(w_i) \cdots \phi_n(w_2) \cdot w_1)$. We denote by x the letter $w_{i+1}^{\#}$. By construction of w_{i+1} we have $x \notin \phi_n^{i-1}(A_{n-1})$ and so $x = \phi_n^i(a_{p,n})$ with for some p . By definition of μ_n^* we have $\mu_n^*((t, s, m), \phi_n^i(a_{p,n})) \neq \otimes$ if and only if $p = n - 1$ or $p \in [2, n - 2]$ and $a_{p,n} \in m$. By construction of P_n^t , we have $a_{p,n} \in m$ if and only if w_i contains an $a_{p,n}$, which corresponds to Condition (iv) of Corollary 4.9. Eventually, by Corollary 4.9, the word $\Pi(w)$ is accepted by \mathcal{A} if and only if $w \in R_n^*$. \square

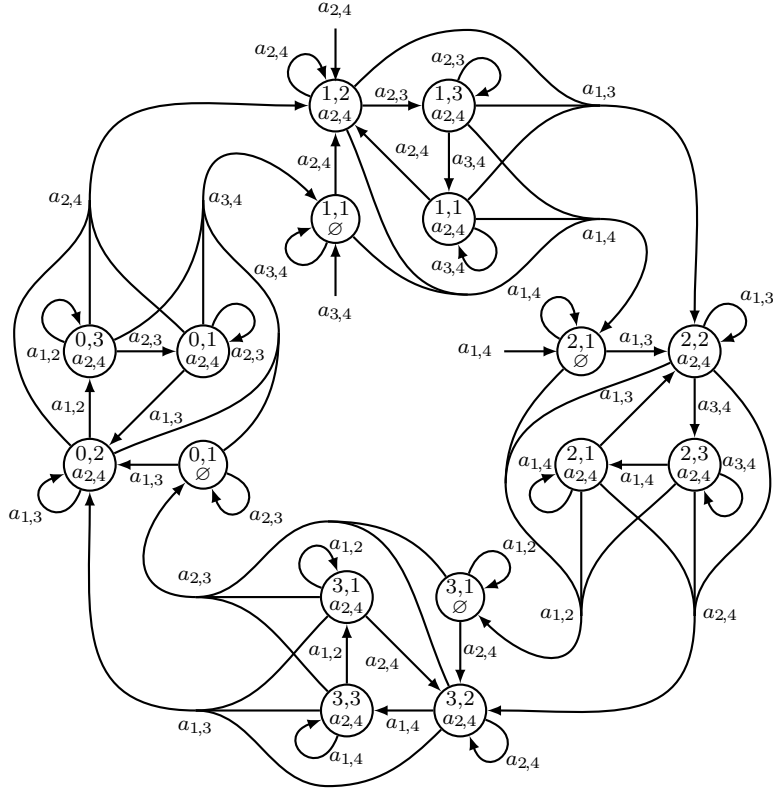

FIGURE 8. Automata fragment P_4 for the language $\Pi(R_4^*)$.

Assume that an automata $\mathcal{A}_{n-1} = (S_{n-1} \cup \{\otimes\}, A_{n-1}, \mu_{n-1}, i)$ recognizing $\Pi(R_{n-1})$ for $n \geq 4$ is given. Using the partial automata $P_n = (S_n^* \cup \{\otimes\}, A_n, \mu_n^*, I_n)$ we construct the automata $\mathcal{A}_n = (S_n \cup \{\otimes\}, A_n, \mu_n, i)$

defined by $S_n = S_{n-1} \sqcup S_n^*$ and

$$\mu_n(s, x) = \begin{cases} \mu_{n-1}(s, x) & \text{if } s \in S_{n-1} \text{ and } x \in A_{n-1}, \\ I_n(x) & \text{if } s \in S_{n-1} \text{ and } x \in A_n \setminus A_{n-1}, \\ \mu_n^*(s, x) & \text{if } s \in S_n^*. \end{cases}$$

Proposition 5.8. *If \mathcal{A}_{n-1} recognizes $\Pi(R_{n-1})$ the automata \mathcal{A}_n recognizes the language $\Pi(R_n)$.*

Proof. Let w be an A_n -word, w_1 be the maximal suffix of w which is an A_{n-1} -word and w' be the corresponding prefix. By Corollary 4.9, the word w is rotating if and only if w_1 and w' are. By construction of \mathcal{A}_n , the automata is in acceptable state after reading $\Pi(w_1)$ if and only if w_1 is an $(n-1)$ -rotating word. Hence w is accepted only if w_1 is rotating. Assume that it is the case. By Lemma 5.7 the automata \mathcal{A}_n is always in an acceptable state after reading $\Pi(w')$ if and only if the word w' is rotating. Eventually the word $\Pi(w)$ is accepted by \mathcal{A} if and only if w_1 and w' are both rotating, which is equivalent to w is rotating. \square

By Proposition 5.8, the language $\Pi(R_n)$ is regular and so we obtain:

Theorem 5.9. *The language of n -rotating words R_n is regular.*

FURTHER WORK

Using syntactical characterization of rotating words we have proved that the language of n -rotating words is regular. For W a finite state automata, we denote by $L(W)$ the language recognized by W . Following [4] and [8] we have the following definition:

Definition 5.10. Let M be a semigroup. An *right automatic structure*, resp. *left automatic structure*, on M consists of a set A of semigroup generators of M , a finite state automata W over A , and finite state automata M_x over (A, A) , for $x \in A \cup \{\varepsilon\}$, satisfying the following conditions:

- (i) The map $\pi : L(W) \rightarrow M$ is surjective.
- (ii) For $x \in A \cup \{\varepsilon\}$, we have $(u, v) \in L(M_x)$ if and only if $\overline{ux} = \overline{y}$, resp. $\overline{xu} = \overline{y}$, and both u and v are elements of $L(W)$.

Naturally we can ask if the rotating normal form provides an left or right automatic structure for the dual braid monoid B_n^{+*} . Such a result may needs to obtain some syntactical properties on the word xw or wx where w is an n -rotating word and x is an A_n -generator. At this time no result have been obtained in this direction.

REFERENCES

- [1] E. Artin, *Theorie der Zöpfe*, Abh. Math. Sem. Univ. Hamburg **4** (1925), 47–72.
- [2] D. Bessis, *The dual braid monoid*, Ann. Sci. École Norm. Sup. (4) **36** (2003), no. 5, 647–683.

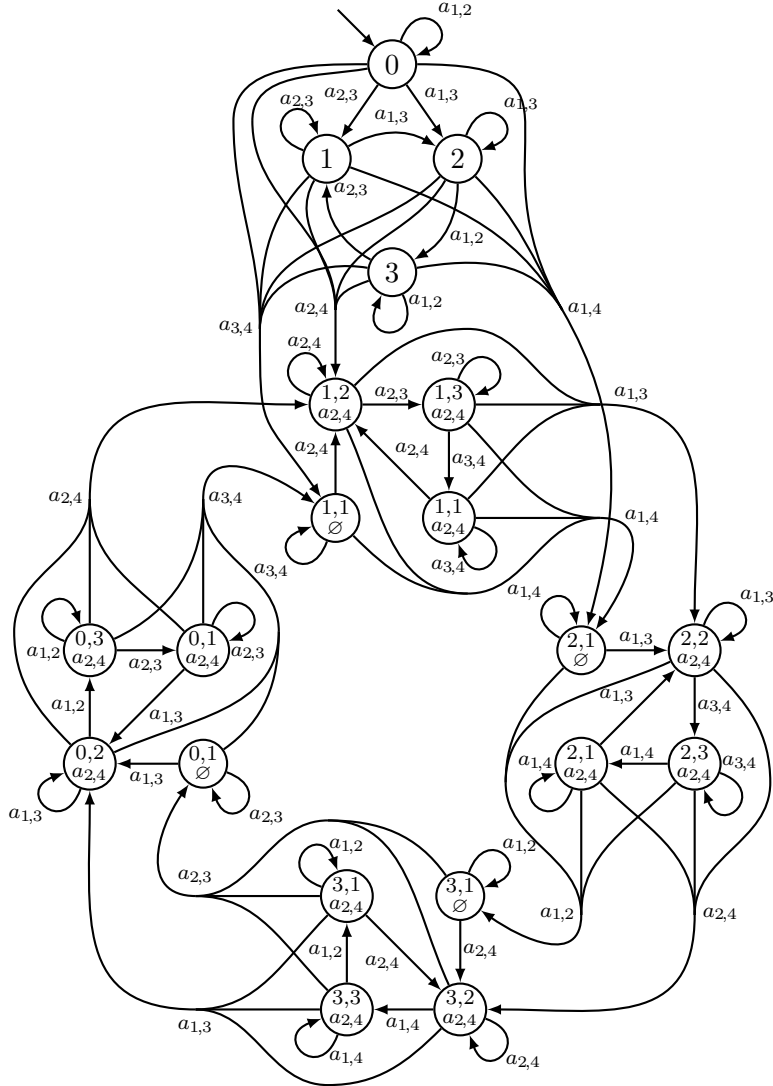
FIGURE 9. Automata \mathcal{A}_4 for the language $\Pi(R_4)$.

- [3] J. S. Birman, K. H. Ko, and S. J. Lee, *A new approach to the word and conjugacy problems in the braid groups*, Adv. Math. **139** (1998), no. 2, 322–353.
- [4] C. M. Campbell, E. F. Robertson, N. Ruškuc, and R. M. Thomas, *Automatic semi-groups*, Theoretical Computer Science **250** (2001), no. 1-2, 365–391.
- [5] P. Dehornoy, *Groups with a complemented presentation*, J. Pure Appl. Algebra **116** (1997), 115–137, Special volume on the occasion of the 60th birthday of Professor Peter J. Freyd.
- [6] P. Dehornoy, I. Dynnikov, D. Rolfsen, and B. Wiest, *Why are braids orderable?*, Panoramas et Synthèses [Panoramas and Syntheses], vol. 14, Société Mathématique de France, Paris, 2002.

- [7] P. Dehornoy and L. Paris, *Gaussian groups and Garside groups, two generalisations of Artin groups*, Proc. London Math. Soc. (3) **79** (1999), no. 3, 569–604.
- [8] D. B. A. Epstein, J. W. Cannon, D. F. Holt, S. V. F. Levy, M. S. Paterson, and W. P. Thurston, *Word processing in groups*, Jones and Bartlett Publishers, Boston, MA, 1992.
- [9] J. Fromentin, *A well-ordering of dual braid monoids*, C. R. Math. Acad. Sci. Paris **346** (2008), 729–734.
- [10] ———, *Every braid admits a short sigma-definite expression*, Journal of the European Mathematical Society (JEMS) **13** (2011), no. 6, 1591–1631.