



**HAL**  
open science

## When innovation supported by Fab Labs becomes a tool for territorial economic development: example of the first mobile Fab Lab in France.

Laure Morel, Laurent Dupont, Pascal Lhoste

### ► To cite this version:

Laure Morel, Laurent Dupont, Pascal Lhoste. When innovation supported by Fab Labs becomes a tool for territorial economic development: example of the first mobile Fab Lab in France.. IAMOT 2015 The 24th International Conference for the International Association of Management of Technology, Jun 2015, Cape town, South Africa. hal-01333488

**HAL Id: hal-01333488**

**<https://hal.science/hal-01333488v1>**

Submitted on 6 Nov 2016

**HAL** is a multi-disciplinary open access archive for the deposit and dissemination of scientific research documents, whether they are published or not. The documents may come from teaching and research institutions in France or abroad, or from public or private research centers.

L'archive ouverte pluridisciplinaire **HAL**, est destinée au dépôt et à la diffusion de documents scientifiques de niveau recherche, publiés ou non, émanant des établissements d'enseignement et de recherche français ou étrangers, des laboratoires publics ou privés.

## **WHEN INNOVATION SUPPORTED BY FAB LABS BECOMES A TOOL FOR THE TERRITORIAL ECONOMIC DEVELOPMENT: EXAMPLE OF THE FIRST MOBILE FAB LAB IN FRANCE.**

LAURE MOREL

Université de Lorraine, Laboratoire ERPI, France  
laure.morel@univ-lorraine.fr

LAURENT DUPONT

Université de Lorraine, Laboratoire ERPI, France  
l.dupont@univ-lorraine.fr

PASCAL LHOSTE

Université de Lorraine, Laboratoire ERPI, France  
pascal.lhoste@univ-lorraine.fr

### **ABSTRACT**

The popularity of the spaces dedicated to the Do-It-Yourself design as a support to the innovation process is widely demonstrated and described in literature. The proliferation of this new type of spaces in the countries, whether in public institutions (universities, engineering schools, local authorities, etc.) or private organizations (big companies, SMEs) is a fact. Their invention is consubstantial to the democratisation of digital tools like 3D printers and the spread of Internet. Following this wave, the University of Lorraine has set up a Fab Lab in 2011 as defined by Neil Gershenfeld from the MIT. However, even if these spaces are doing a good job in their functions of accelerating collaborative innovation, it is clear that they are mostly located in cities, serving a privileged type of users and very often not SMEs.

At the same time, there is also an exponential increase in the offer of seminars of creativity, of innovation support, or conferences on the piloting of the innovation process but still in these same urban settings. In fact, a whole pan of companies, especially rural SMEs, is forgotten in the offer of services to improve their ability to create and innovate.

Based on these two observations and on a survey on 36 SMEs' needs regarding the definition of a dynamic of innovation, a school of engineers located in a French city has set up a "mobile Fab Lab" in 2014. The present paper will show how this device can allow rural SMEs to access to 3D technologies to support their creative and innovative processes. Indeed, this innovative truck can deploy a surface of 20 m<sup>2</sup> in which creativity software, tactile tables, 3D printers, scanners and lasers cutting are available to these entrepreneurs and industrials that are located very far from the urban centres and from the research centres.

We will comment our experiences after the first months of experimentation of functioning and will propose some improvements and challenges to address.

**Key words:** Mobile Fab Lab, Rural SMEs/SMIs, smart rurality, innovative devices, Additive manufacturing

## INTRODUCTION

As a laboratory dedicated to the evaluation of innovative processes, the ERPI team observes the spread of innovation as a factor of economic and social development for SMEs in the area where the laboratory is located, the Region of Lorraine but also in France and at the international level. The team research's experience seems to indicate that there is an exponential increase in the offer of seminars of creativity, of innovation support, or conferences on the piloting of the innovation process. These observations suggest to better understand this phenomenon with qualitative and quantitative elements, in order to, more particularly, evaluate the limits for SMEs' development in the studied Region: "La Lorraine", located in the east of France. On an economic dimension, the purpose is to measure the relevance of this "visible trend" of the support for the innovation or the creativity. On social and territorial dimension, the main objective is to realize if the distribution of this offer is fair on the regional territory.

This intuition, ignited from academic research and industrial experiences, is in accordance with current global requirements. For example, as explain in the annual report on European SMEs 2013/2014 (Muller et al., 2014), "skills & innovation" is one the five foundations of the Small Business Act developed in 2008 by European Commission and the 28 National Governments of European Union. And this is one of the major challenges chosen by 46% of the respondents of the "SME Performance Review 2013/2014 – Survey", 66% of the respondents chose Access to finance, and next in importance are Entrepreneurship (49%) and Responsive administration (46%). This European study encourages developing the adapted policy, especially as shown by (Back et al., 2014), researches claim that a better institutional environment may result in better innovation performance for companies even if institutional development level reduces Firms' R&D spending. From another angle, institutional hindrance to competition equity, access to financing, and support systems prevent companies from enhancing their innovation performance.

This institutional dynamic can be connected with private sector or societal initiative. To illustrate the parallelism between the (European) institutional tendency exposed above and the creation of specific activities, we use the Kompass classification system that allows us to target the interesting organisations with a good precision. We choose this global B2B database company, because it is one of the international supports to collect very detailed data on the activity of the company, the products and the services which it makes and/or distributes. Kompass covers 66 countries worldwide. Each country locally collects, maintains and enhances the international database presented with closer, precise and homogeneous information (Kompass, 2014).

We focus our observation on the year of creation of each organisation (companies, associations, private schools, etc.), still working in one of the 66 countries and classified as Science parks (technological and innovation centre), Innovation management services and Change management consultants. Our researches give us three sets of data gather in Figure 1. For each group of data, we underline the part of French companies. These three topics were chosen because the term "innovation" is automatically linked to Science parks and Innovation management services in the database and because "innovation" can be technological, managerial or organisational thus we also selected "Change management consultants" companies which assist companies in their new strategy.

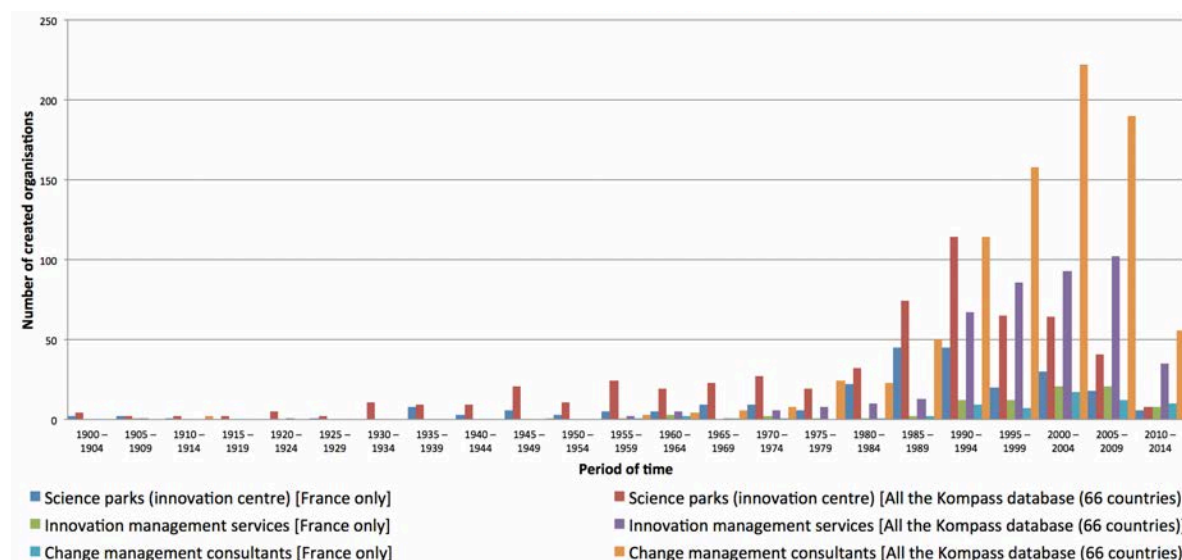

Figure 1 : Number of three different kinds of organisations created to support innovation (by period of five years), source: data from Kompass database, 2014

The Figure 1 is an international illustration of the strong development of organisations specialized in the support for the innovation, essentially after the recession that followed the first oil crisis. Furthermore, this graphic shows that the initial economic answer was the creation of “science parks” (as elements for technologic innovation) after 1945, with a prosperous development from the end of 80’s until the middle of 2000 and a peak at the beginning of 90’s. After the technological approach, the creation of “Innovation management services”, and the very high and fast apparition of “change management consultants” represent another answer to support managerial and organisational innovation. From 80’s until the end of the first decade of the twenty-first century, it seems that entrepreneurs have understood the market demand and created the offer with the creation of dedicated structure to support innovation processes. From 2010, the creation of the three kinds of observed firms slows down. All these organisations, and certainly many unconsidered by this study, are currently active. The number of actors can generate an important potential offer to support innovation. As a result, the “creativity or innovation support” may involve the adoption of a “push strategy”. Srinivasan (2014) strengthens this hypothesis. The author, who describes management consulting as an industry, shows that this activity is currently mature. Firms from this sector cannot only provide strategy advice, they have also to take responsibility for implementation in order to provide significant value creation that outweigh the costs of engagement.

However, the companies’ decision, especially in SMEs/SMIs, to use professional management consulting services should be made carefully because its effectiveness (attempt more innovation) depends on the country and the firm level situation (Back et al., 2014). Thus, according to Back et al. (2014), SMEs should evaluate the institutional environments of the territory (countries, regions) in which they operate.

Nevertheless, the institutional context is not sufficient to generate innovative SMEs/SMIs. (Lau & Lo, 2015) empirically explore the impact of Regional Innovative System on the innovation performance of a firm, using the dimensions defined on the Absorptive Capacity concept (acquisition, assimilation, transformation and exploitation). One of the findings of this study shows that no Regional Innovative System elements can enhance a firm's ability to apply knowledge to its

operations. The application of knowledge seems mainly driven by strategic decision-makers and enterprise strategies than by policymakers. Furthermore, their study proposes that the efficiency of Regional Innovative System may depend on the development of a company's Absorptive Capacity.

The focus on French data (Figure 2) shows that private sector and social initiative develop a strong response to support innovation at the beginning of 80's. From the 90's, "innovation management services" and "change management consultants" complete the offer of technological innovation support (science parks).

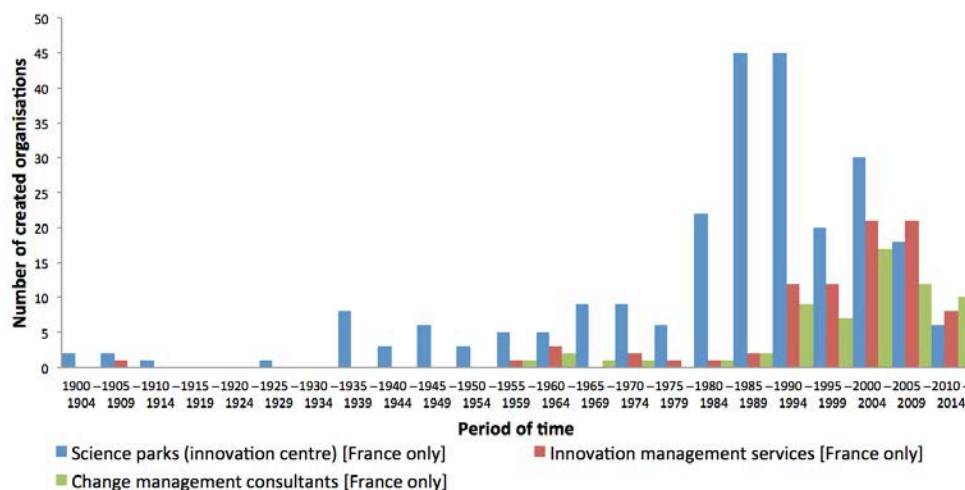

Figure 2 : Number of three different kinds of organisations created to support innovation in France (by period of 5 years), Source: data from Kompas database, 2014

Furthermore, always in France, APCE (Association for enterprise creation) shows on its website (APCE, 2014) a list of 30 resources centres for innovative projects classified by: Supports of the project leaders (9), Technical supports (7), Access to finance (8), specific training (3), new spaces or environments (3). Most of the cited organisations are public or support by subsidy. It is essentially networks, alliance of networks or regional agencies or platforms. Thus, hundreds of organisations are potentially identifiable and could be sought by entrepreneurs or experimented SMEs. All these structures, given by APCE, are located in the urbanized region of the French capital or in the main urban areas of each French region. As a consequence, there is an exponential increase in the offer of seminars of creativity or innovation support, of conferences on the piloting of the innovation process but still in these same urban settings. In fact, a whole pan of companies, especially rural SMEs, is forgotten in the offer of services to improve their ability to create and innovate. Moreover, Lau & Lo (2015) claim that "copying successful initiatives from other regions is not an effective way to improve innovation performance because different firms have different levels of learning capabilities." Despite the increase of offers for SMIs/SMEs to manage their innovation by outside organisations, it seems necessary to imagine and study new solutions for rural SMIs/SMEs. Empirical researches should help to experiment and strengthen relevant answers to this social and economic issue.

In this paper, we report on our experience in the development of a new mobile device to develop and support creativity and innovation in the rural spaces by connecting them to the urban areas and city centre, where are gathered knowledge, platforms, networks, and new experimentations. This

project needs to adopt a specific “territory point a view”. The region of Lorraine was chosen as experimental territory. In the next section, we evaluate the societal and economic dimensions of this region and we draw the foresight.

## **METHODOLOGY**

Our methodology follows three steps. The first one is a local survey to highlight the level of innovation of regional SMEs/SMIs: an initiative driven by the CGPME (Cluster of SMEs/SMIs) in the region of Lorraine allowed us to evaluate the capability to innovate of several companies.

The second step explores the more global and institutional vision to support innovation in companies. Indeed, we focus on the impacts and opportunities generated by the “third wave Do-It-Yourself” (Fox, 2014) as analogy to the three waves of societies describe by Toffler (1980) as agricultural, industrial, and post-industrial (or informational). More specifically, we focus on Fab Labs movement.

Finally, based on the observations issued from the two first steps, we propose an original solution to reduce the gap between the regional situation and the global trends to foster economic development.

### **1<sup>st</sup> step: local vision to support the innovation**

In this subsection, we summarise the local vision from managers of SMIs / SMEs of the Region of Lorraine.

In 2009, a guide for enabling an auto-diagnosis of a company’s capability to innovate was sent to 750 SMIs/SMEs located in one of the four departments of the Region of Lorraine: “les Vosges”. Ten days after, the companies (mainly in wood and furnishing, textile, metal and plastics processing industries) were contacted by phone to schedule a face-to-face interview with the manager. The objective was to show him that in one hour, it is possible to have an in depth diagnosis of the company to ignite or pilot projects of innovation. Thirty-six enterprises accepted the proposal.

At a global level, the analyse (Lhoste, 2009) shows that the managers are conscious that innovation is a key factor of survival. By Innovation, they include creation of new products and/or services, optimization of the organization of the company, the business intelligence, the search for new markets, for industrial protection, etc. Furthermore, they concretely highlight some strategic needs such as: a better definition of the strategy of the company, improvement of its positioning, its communication (internal and external), and sometimes, of its partnerships, and some human resources needs such as: renewal of the internal skills of the company both by the training and by the recruitment of new collaborators (commercial, project managers). Surprisingly, the search for financing is not in the first concerns of the SMIs/SMEs studied. Finally, some enterprises express the desire to develop their capacity of exportation.

The survey gave other interesting findings: 30 % among the 714 SMEs/SMIs contacted was not interested by the approach and approximately 30 % leaved an opening for a possible call or meeting later and/or after sending of further information and/or by their initiative.

Finally, almost five per cent of the SMIs/SMEs were available after the first phone contact (36 companies), but with potentially a third of the group (214 Companies) interested to do it latter.

The SMIs/SMEs audit led to the necessity to set up an actors' network specialized in the support of the SMIs/SMEs on the various quoted domains as well as in the coordination and in the follow-up of the actions (Lhoste, 2009). Initially developed in 2009 and still active in 2014, the network called "Appui PME-PMI" (SMEs/SMI support) (see: <http://www.appuipmepmi.com/>) gives access to a platform for technological cooperation (schools, university, training) and to a platform for experts 'consultation (actors specialized in specific domains: finance, human resource, export, etc.) to the SMEs/SMIs involved in the project. But, despite of increase the satisfaction of the panel, we faced an unpredictable result. The companies have indicated some frustrations. Indeed, professional networks, links with academics, institutional initiatives raise awareness of innovation among these companies. Nevertheless, they estimate that the priority is give to SMIs / SMEs located in urban areas because both regional and national innovation initiatives (university, technical platforms, consulting firms, etc.) are located in these same urban areas, or city centres. As Urban SMIs / SMEs, rural SMIs / SMEs want optimise their working time. They hesitate to take time for a business trip for one or several places while the outcome is uncertain. This feeling is increase by time of economic crisis.

This new posture of the companies seems to be an interesting signal to consider differently the piloting of the innovative processes, particularly with the context of the "third wave Do-It-Yourself" as presented in the next step.

## **2<sup>nd</sup> step: identification of the new trends that support the innovation and regional involvement**

In this part, three resources are used: scientific literature review, institutional reports and press review, and academic experience.

The popularity of spaces with specific digital equipment (software, 3D print, Laser cutter, CNC, digitising machine, etc.) as a support to the innovation process is widely demonstrated and describe (Anderson, 2012; De Bruijn, 2010; Clapaud, 2013; De Jong & De Bruijn, 2013). The proliferation of "digital fabrication" in the countries, whether in public institutions (universities, engineering schools, local governments, etc.) or private organizations (big companies, SMEs) is a fact (Eychenne, 2012; Fox, 2014). One of the most famous demonstrations of this global phenomenon is the Fab Lab movement, or "fabrication laboratory". Since the emergence of this concept by Neil Gershenfeld from the Massachusetts Institute of Technology (MIT) in the 2000, Fab Labs were created all around the world, in very different contexts: Norway, The Nederland, France, Afghanistan, India, South Africa, etc. The community still grow up, as shows the process to join the Fab lab Foundation: The MIT original Fab Lab team decided to stop to analyse project from candidate who wants to be recognised as Fab Lab. They accredited some historic Fab Lab abroad for doing the job to recommend and accept (or not) new Fab Lab project.

A Fab Lab is a kind of associative factory dedicated to "handmade digital fabrication". The purpose concept integrates in one space all the resources to go from idea to prototype. Digital fabrication allows to create and develop (unique or a few number of) complex objects (e.g.: technical or mechanical items) through accelerated manufacturing process from conception to production into

one single chain (De Jong & De Bruijn, 2013; Ghilassene, 2014). Industrial level is not necessary. The principles are to make, repair, distort, hack, assemble, take apart (almost) anything.

These spaces and organisations aim at giving access to manufacturing processes to the general public (unprofessional people, amateur, enthusiast, etc.), that allow to democratise access to the tools for personal expression and invention. This context should stimulate “bottom-up innovation”. They are a good alternative for the entrepreneurs who want to accelerate the transition from concept to prototype; for the designers and for the artists; for the students motivated to experiment and to enrich their knowledge and Know-how in electronics, in CAD-CAM, in design; for the handymen of the 21th century. Fab Lab dynamic participates in the appropriation of the technologies by the citizens and the users, by modifying the functioning or suggesting new way of uses. It spreads the capacity of the digital technology to widen the participation and intervention of the citizens on their everyday life, their immediate environment, and their living space. Fablas are vectors of empowerment and skills development. It is also seen as the place where will be invented objects and places of tomorrow, more certainly than in large companies and laboratories (Clapaud, 2013; Cuny, 2013).

The context of creation of each Fab Lab gives them a unique function, atmosphere, dimension according to the objectives and local resources. There are educational Fab Labs, Fab Labs to do humanitarian works, other for the artistic development and the design, Fab Labs which complete and extend campus. In the third wave Do-It-Yourself logic, these spaces allow to resolve local problems with local innovation based on open innovation, social proximity, culture of the collaboration and sharing, the open source culture (from Web 2.0), or the learning by doing (Eychenne, 2012; Fox, 2014; Shearmur, 2012).

The various Fab Labs in the world combine, with different levels of intensity, five functions corresponding to five publics: 1) the simple discovery of the power to create, to make for the children or the handymen; 2) the learning by doing for schools and universities; 3) the accelerated design of prototype for the entrepreneurs and the creators; 4) the local production, which meets the needs in particular of developing country, but also to those of artists, designers or handymen who do not look for the big series; 5) experimentations, even (economic, technological, social) innovations for academics and researchers. Indeed, Fab Labs fit into information age or third wave Do-It-Yourself and allow to experiment, observe and analyse new kind of processes, potential new ways for the invention of objects, spaces, forms of tomorrow. If we look at one of the technology used in Fab Lab: the 3D printing, it is not a new technology. What is new, it is the access to this technology in the general public because of the arrival on the market of printers small-sized and sold to affordable prices (Ghilassene, 2014). A strong impact on the society is observed (De Bruijn, 2010; Cuny, 2013; Clapaud, 2013; De Jong & De Bruijn, 2013; Fox, 2014). For example, the 3D printing knows a big mediatization of the exploit realized in the medical domain by its use (Groopman, 2014; 3DPrintingNewsletter, 2015).

Some key characteristics create an enabling environment that can be call a Fab Lab. Due to the empowerment philosophy public access is essential. The second key is to support and subscribe to the Fab Charter (<http://fab.cba.mit.edu/about/charter/>). Then Fab Labs must share a common set of tools and processes, the critical list of machines and materials is also available on Internet. Finally, it is necessary to contribute to the global knowledge-sharing community. In fact, it is a collective experience: an object can be designed in a Fab Lab, made in another one, and improved in the third.



From 2009, in France, young engineers, researchers, students, designers and "handymen" gather to establish Fab Labs. 50 are already recognised by the Fab Labs Fondation but another group of 50 organisations claim to be a Fab Lab or in a Fab Labs dynamic without having asked for the recognition to the MIT or having obtained (Figure 3).



Figure 3: Localisation of French Fab Labs, Source:

[http://fablabo.net/wiki/Cartographie\\_des\\_fablabs\\_francais](http://fablabo.net/wiki/Cartographie_des_fablabs_francais), 15<sup>th</sup> december 2014

Following this international wave, the University of Lorraine has set up a Fab Lab in 2011, named GSI Lab. The objective is to allow the engineers to make prototypes more quickly than before and at a lower cost their ideas, to test them and to enrich them. This technology can be seen as an "accelerator of the process of innovation". Other students of the university punctually come to use the GSI Lab (Students in Architecture, Geology, Food-processing industry, etc.)

But, even if these spaces are doing a good job in their functions of accelerating collaborative innovation, it is clear that they are mostly located in cities, serving a privileged type of users (academics, students, firms closer to university) and very often not distant (or rural) SMEs.

### 3<sup>rd</sup> steps: understand the gap between the local situation and the global trends, the Lorraine case

For the last observation, researches are based on data from national institutes as INSEE (French demographic statistical institute), CCI Lorraine (the regional Chamber of Commerce and Industry), and General Commissariat for Strategy and Forecasts (Linked to the French Prime minister).

In urban areas of Lorraine, economic development is supported by big companies or public organisation (like University Hospital Centre, University, Administration, etc.), whereas SMEs ensure the strongest part of the employment (Figure 4 and Figure 5). SMEs are proportionally more numerous in the South and the East of the Region of Lorraine (Auzet et al., 2006; INSEE, 2006) and currently these territories have among the highest share of unemployment (DIRECCTE-Lorraine, 2014).

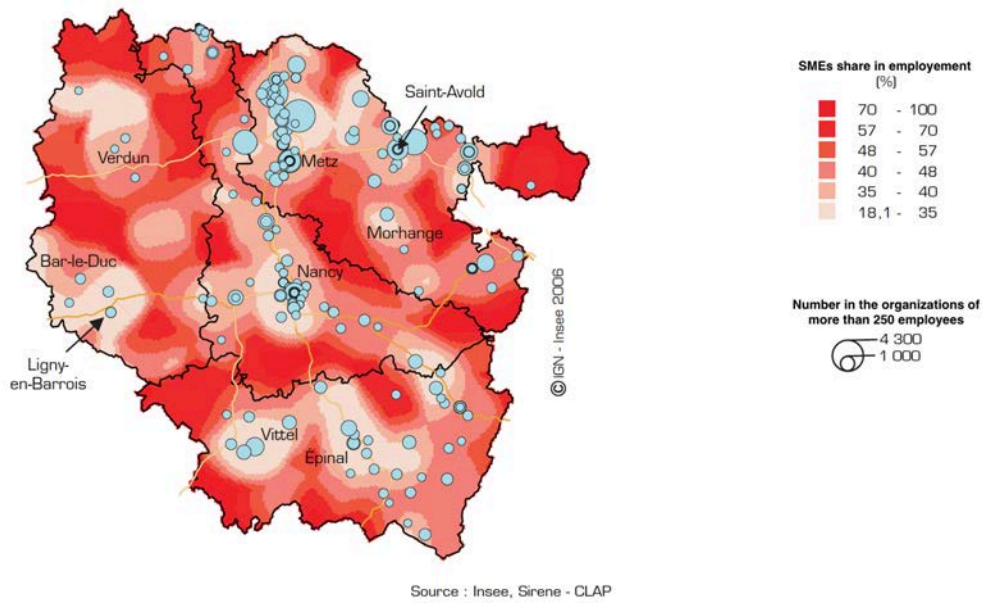

Figure 4: SMEs, the support of the employment in the rural areas, Source: (Auzet et al., 2006)

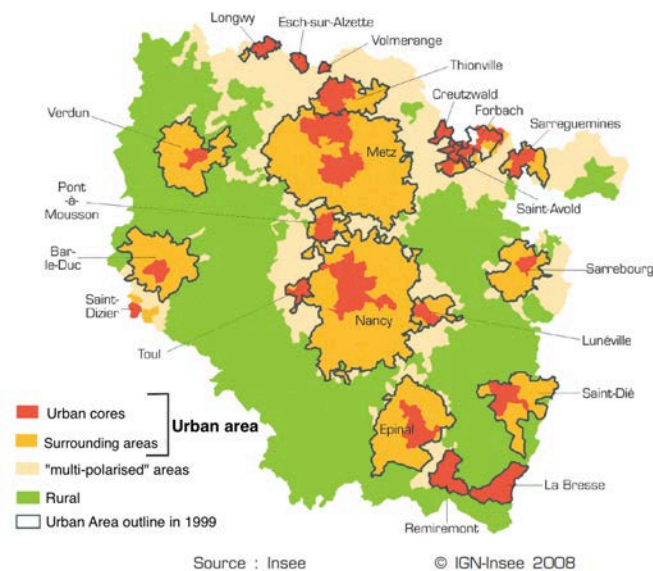

Figure 5: rural and urban areas of Lorraine, Source: (Bischoff, 2008)

INSEE specialists, Deltour & Kauffmann (2014) explain that in the Region of Lorraine, the big urban cores generate a dynamics that favour essentially the circumjacent territories (surrounding and “multi-polarised” areas). This region underwent a delay on the resumption of employment due to the over-representation of the industrial activity, and also the international crisis since 2008. Furthermore, employment in the region is more and more in service sectors. The industrial employment loses ground in the North and the East of the Lorraine.

Thus, it is important to support the rural SMEs / SMIS in the South of the region. To develop a relevant strategy for these specific companies, it is necessary to understand the potential evolution of the employment. Quintin et al. (2011), from the French Centre of Strategic Analysis, propose a forecast vision of the employment and the type of job in 2035. The authors explain in particular that,





Can Fab Labs create working communities somewhere else than in cities? Literature shows that creativity, innovative process and open innovation need densities (social, cognitive, economic, creative people, etc.) and interactions with academic environments (De Bruijn, 2010; Fox, 2014; Shearmur, 2012). But in Lorraine, as seen above, both resource centres for innovative projects and University sites are concentrated in urban areas (Figure 6). So, they are geographically distant from rural spaces, excepted two Fab Labs that are located in rural areas: one associative and one part of a training centre dedicated to Glass industry.

The weak density of SMEs/SMIs, in the South of the Lorraine, questions about the reliability and the sustainability of a “fixed Fab Lab”. However, the identification of the key factors facilitating the success of innovative projects in rural areas show that networks are essential, fortunately in rural areas, networks are already strong and it is often sufficient for the early stage of rural innovative project. But, when the idea needs to be implemented, the key support may be provided by external actors, which contribute for example with technical and scientific support, especially when they belong to public universities or research centres attached to regional governments (Esparcia, 2014). At this stage, Fab Lab could be very useful. Indeed, we observe a double distributed phenomenon: a geographical distribution of the companies, and a temporal distribution of the innovative projects. In this context, how to meet, more easily and with reduce investment for SMEs / SMIs, communities of practice, companies, external and internal knowledge, projects, technologies, networks, etc.?

## 5. Findings:

The weak distribution of centres for the acceleration of innovation, the despondency of the interviewed SMEs/SMIs actors, the need to innovate to invent new solutions to support social and economic development in the territory, motivated us to realize a session of creativity with academics, Managers of SMEs / SMIs, local firms’ networks, institutional. From there emerged the idea of a mobile device to have mobile spaces which could be set up everywhere on the territory, where are the future users of this scientific and technological device. The objective is to be able to go as near as possible to rural SMEs/SMIs. As described below, our researches show examples with advantages and limits. With these elements, we developed “handmade” projects.

When this research started, Mobile Fab Labs already existed in other countries. Thus, the first Mobile Fab Lab was built in August 2007 by the Centre for Bits and Atoms at the MIT. It is a computer-controlled design and machining fab lab housed in a trailer (see Figure 7 and [http://en.wikipedia.org/wiki/Mobile\\_fab\\_lab](http://en.wikipedia.org/wiki/Mobile_fab_lab)).



Figure 7: First Mobile Fab Lab, source: amys at MIT, 2007

After this first experience, other Mobile Fab Labs were created in the world. From 2009, in South Africa, the Council for Scientific and Industrial Research (CSIR) used a Mobile Fab Lab in Pretoria. From 2010, MC2 STEM High School, part of the Cleveland Metropolitan School District (USA, Ohio), used a Mobile Fab Lab in the region of Midwest USA. In 2010, in The Nederland, the Amersfoort FabLab created the first European Mobile Fab Lab. The FabLabTruck moved in the Nederland and went to Germany or Scotland for different events. In 2011, the design studio Unfold, develop the Kiosk project (Figure 8) in which digital fabricators appear on street corners and are able quickly to materialize (almost) everything (in a cube of 20cms aside).

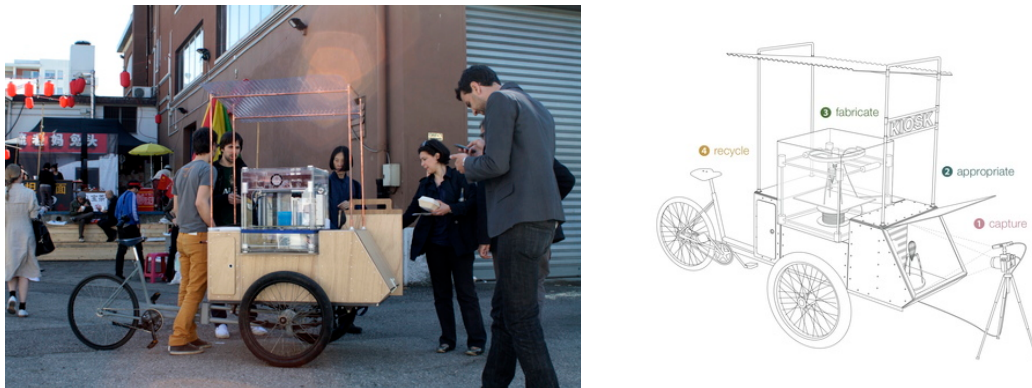

Figure 8: Kiosk project, source: <http://unfold.be/pages/projects/items/kiosk-design-sampler>, 2011

If France reduces its delay with regard to these countries for the development of fixed Fab lab, the setting-up of mobile vectors is very new. As a result, the Nomad Lab, designed by the ENSGSI School in 2012-2013 is the first one in France. ENSGSI students generated CAD and model (Figure 9 and Figure 10) in order to help decision makers to choose the best configuration for this project. In fine, they decided that a small custom-made van is the best solution (20 m<sup>3</sup>, as the van used on outdoor market) to meet users and to help them to develop their creative project using the 3D technologies. The Nomad Lab is thus a device to answer the gap between the needs of creativity and innovation supports of rural SMEs / SMIs and their desire to be considered as important as urban ones.

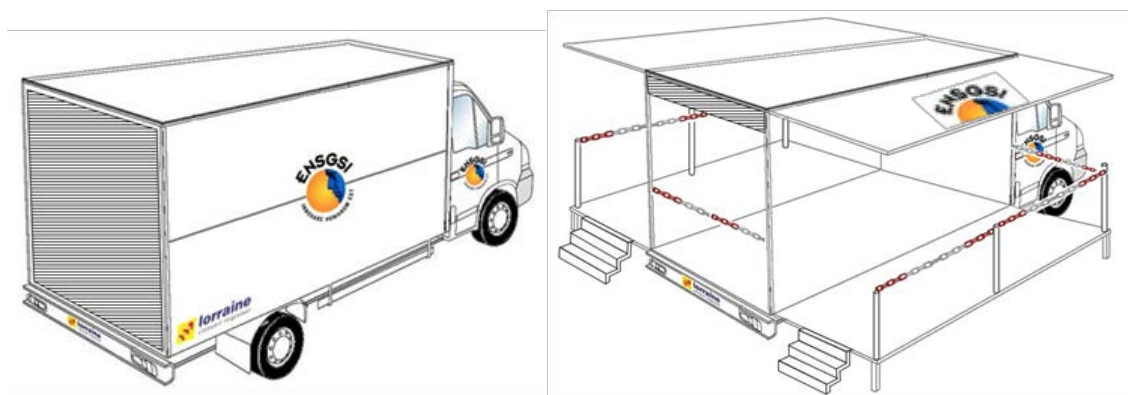

Figure 9: Seen ¾ back, vehicle in mobile position and Seen ¾ back, vehicle in deployed position,  
Source: ENSGSI, 2013

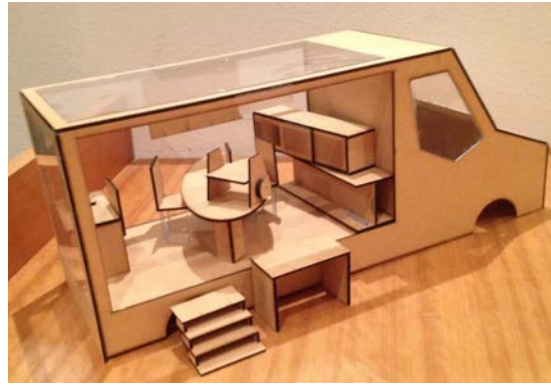

Figure 10: Model in wood and transparent plastic, Source: photographie at ENSGSI, 2014

After one year of functioning, we can assume that the objectives we address are completed. The companies confirm their interest and the pertinence of the Nomad Lab. (Figure 11).

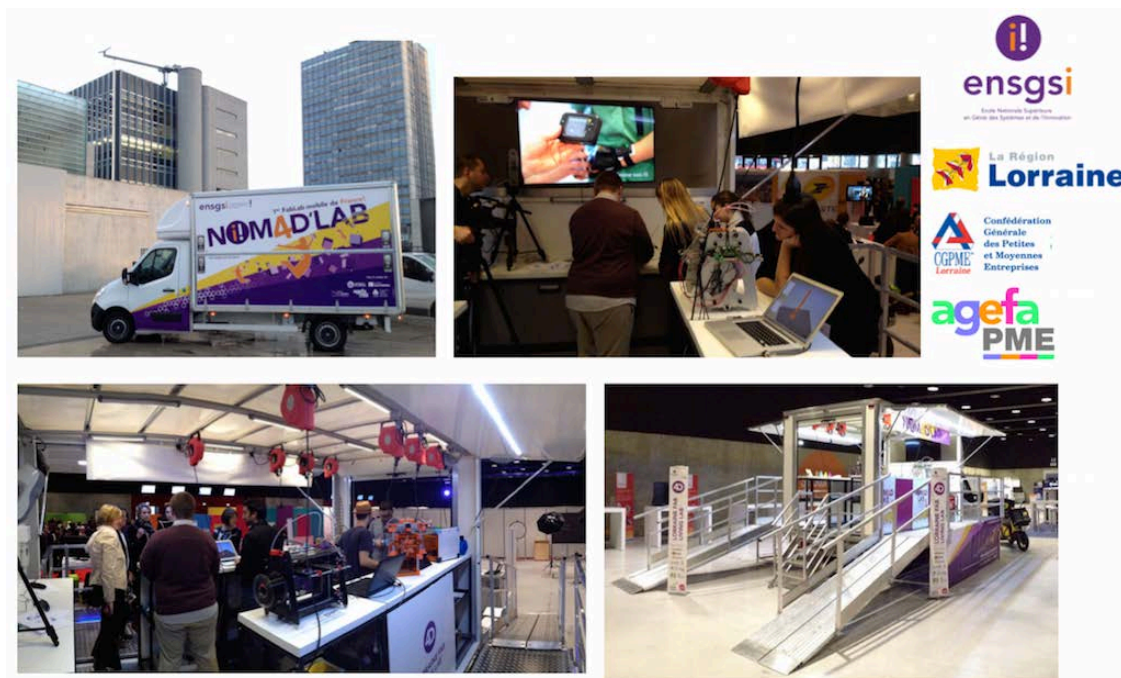

Figure 11: pictures of the Nomad'lab in a regional conference dedicated to the economy of tomorrow, source: our photographs.

Furthermore, the fact that the investments to acquire the Nomad Lab become from private (CGPME, a professional network) and public funding (the Regional Council of Lorraine and the University of Lorraine) is a key factor of success. Indeed, the CGPME can recommend us and in general, the university have a good reputation in Lorraine. In order facilitate the access to this innovation, the Nomad Lab van, a website ([www.lf2l.fr](http://www.lf2l.fr)) was developed both to show the technological capabilities and the services provided and to manage appointments with users.

## CONCLUSION

Fab Labs dynamic, third wave Do-It-Yourself revolution and the global evolution of the work and processes of manufacturing, can give big hopes for future. Notwithstanding these positive visions, it

is necessary to assure a sustainable development for our territories. In the region of Lorraine, a device that inverts the relation of the offer and the demand between urban and rural areas was developed. The university is now able to go closely to the rural companies to help them to increase their innovative processes. Of course, the services provided are limited, but this is for us the first way to win the trust of the companies. Then, we hope that this will lead to long-term relationships between the SMEs/SMIs and the university for a more complete offer. Indeed, the purpose is not only to democratise the technology but also to evaluate the potential of new activities development for rural enterprises. For example, the Sculpteo company concluded a contract with La Poste (the French postal group set up in all cities and villages of France) to train its employees in the use of the 3D printers. In three big French cities, the employees of La Poste help its customers in the discovery of this technology and indeed they especially support BtoB processes (Cuny, 2014). In fact, to develop answers to support innovative project for rural SMEs / SMIs still remain a big challenge. It is necessary to create a new model business, and subsidies would be the only long-lasting solution (Fox, 2014). From its experience and from its scientific studies, the University can propose new technologic and flexible solutions. However, it seems necessary to build a protocol of observation and evaluation to measure the efficiency of this new mobile device. A new issue appears: “plug and play” units of conceptualisation as mobile Fab labs are they more adapted than the fixed spaces to support innovation in urban or rural SMEs / SMEs? In other words, how mobile devices and fixed spaces are complementary on a territory?

## ACKNOWLEDGEMENTS

The authors would like to thank all the persons that answered to their survey or were involved in the session of creativity to design the Nomad Lab. Public and private funding allowed the development and the management of this project: Université de Lorraine, Conseil Regional de Lorraine, CGPME Lorraine and AGEFA PME.

## REFERENCES

3DPrintingNewsletter, 2015. 3D Printing Newsletter - Archives for Medical. *3D Printing Newsletter*. Available at: <http://3dprinting.com/products/medical/>.

Anderson, C., 2012. *Makers: The New Industrial Revolution: Chris Anderson: 9780307720962: Amazon.com: Books* C. Business, ed., New York: crownpublishing.

APCE, 2012. Les centres de ressource pour les projets innovants. , pp.1–4. Available at: <http://www.apce.com/pid14117/les-projets-innovants.html?espace=1&tp=1> [Accessed December 15, 2014].

Auzet, L. (Insee) et al., 2006. TPE - PME : un tissu en fort renouvellement qui soutien l’emploi sur l’ensemble des territoires. *INSEE Economie Lorraine*, (68), pp.1–8. Available at: [http://www.insee.fr/fr/themes/document.asp?reg\\_id=17&ref\\_id=10698](http://www.insee.fr/fr/themes/document.asp?reg_id=17&ref_id=10698).

Back, Y., Praveen Parboteeah, K. & Nam, D., 2014. Innovation in Emerging Markets: The Role of Management Consulting Firms. *Journal of International Management*, 20(4), pp.390–405.

- Bischoff, J., 2008. Démographie des établissements lorrains : une dynamique contrastée urbain-rural. *INSEE Economie Lorraine*, (128), pp.1–4. Available at: [http://insee.fr/fr/themes/document.asp?ref\\_id=12668&reg\\_id=17](http://insee.fr/fr/themes/document.asp?ref_id=12668&reg_id=17).
- De Bruijn, E., 2010. *On the Viability of the Open Source Development Model For the Design of Physical Objects*. University of Tilburg, The Netherlands. Available at: <http://thesis.erikdebruijn.nl/master/Latex/thesis.pdf> [Accessed November 30, 2014].
- Clapaud, A., 2013. Les industries de demain naissent au coeur des Fab Labs. *01 Business*. Available at: <http://pro.01net.com/editorial/607382/les-industries-de-demain-naissent-au-c-and-339-ur-des-fab-labs/> [Accessed December 1, 2014].
- Cuny, D., 2014. Impression 3D : Sculpteo fait le deuil de la révolution grand public. *La Tribune*. Available at: <http://www.latribune.fr/technos-medias/20140521trib000831157/impression-3d-sculpteo-fait-le-deuil-de-la-revolution-grand-public.html> [Accessed December 15, 2014].
- Cuny, D., 2013. Imprimante 3D, la 3ème révolution industrielle. *La Tribune*, pp.4–6.
- Deltour, A. (INSEE) & Kauffmann, B., 2014. Des territoires périurbains lorrains moins touchés par la crise. *INSEE*, pp.1–10. Available at: <http://meridianes.org/2014/07/01/des-territoires-periurbains-lorrains-moins-touchees-par-la-crise/> [Accessed November 30, 2014].
- DIRECCTE-Lorraine, 2014. *Portrait Socio-Economique Lorraine*, Metz.
- Esparcia, J., 2014. Innovation and networks in rural areas. An analysis from European innovative projects. *Journal of Rural Studies*, 34, pp.1–14.
- Eychenne, F. (FING), 2012. *Fab Labs overview*, Paris. Available at: <http://fing.org/?Fab-Labs-overview> [Accessed November 30, 2014].
- Fox, S., 2014. Third Wave Do-It-Yourself (DIY): Potential for prosumption, innovation, and entrepreneurship by local populations in regions without industrial manufacturing infrastructure. *Technology in Society*, 39, pp.18–30.
- Ghilassene, F. (INPI), 2014. *L' impression 3D. Impacts économiques et enjeux juridiques*, Lille.
- Groopman, J., 2014. Print Thyself - How 3-D Printing is revolutionizing medicine. *The New Yorker*. Available at: <http://www.newyorker.com/magazine/2014/11/24/print-thyself> [Accessed January 1, 2015].
- INSEE, 2006. Les TPE-PME et le territoire. In Ministère de l'Économie des Finances et de L'Industrie, ed. *Regards sur les TPE - PME en Lorraine*. INSEE, pp. 21–24. Available at: [http://www.insee.fr/fr/themes/document.asp?reg\\_id=17&ref\\_id=14529](http://www.insee.fr/fr/themes/document.asp?reg_id=17&ref_id=14529).
- De Jong, J.P.J. & De Bruijn, E., 2013. Innovation Lessons From 3-D Printing | MIT Sloan Management Review. *MIT Sloan Management Review*, 54(2), pp.44–52. Available at: <http://sloanreview.mit.edu/article/innovation-lessons-from-3-d-printing/> [Accessed November 30, 2014].
- Kompass, 2014. Savoir-Faire Kompass. Available at: <http://www.kompass-international.com/DigitalFactory/sites/kompass/home/savoir-faire-kompass.html> [Accessed December 15, 2014].
- Lau, A.K.W. & Lo, W., 2015. Regional innovation system, absorptive capacity and innovation performance: An empirical study. *Technological Forecasting and Social Change*, 92, pp.99–114.



Lhoste, P. (ERPI), 2009. Partageons nos competences pour mieux developper vos innovations ! In *Le grand livre de l'économie PME*. lextenso editions.

Muller, P. et al., 2014. *Annual Report on European SMEs 2013 / 2014 – A Partial and Fragile Recovery Final Report -July 2014 SME Performance Review 2013 / 2014*, Brussel.

Quintin, O. (Centre d'Analyse S. et al., 2011. *Le Travail et l'emploi dans vingt ans*, Paris. Available at: [www.strategie.gouv.fr](http://www.strategie.gouv.fr).

Shearmur, R., 2012. Are cities the font of innovation? A critical review of the literature on cities and innovation. *Cities*, 29, pp.S9–S18.

Srinivasan, R., 2014. The management consulting industry. *IIMB Management Review*, 26(4), pp.257–270.

Toffler, A., 1980. *The third wave* William Mo., New York.