



HAL
open science

Modelling of Station of Pumping by Variable Speed

A. Benretem

► **To cite this version:**

A. Benretem. Modelling of Station of Pumping by Variable Speed. Mechanics, Materials Science & Engineering Journal, 2016, 10.13140/RG.2.1.4707.0324 . hal-01325252

HAL Id: hal-01325252

<https://hal.science/hal-01325252>

Submitted on 7 Jul 2016

HAL is a multi-disciplinary open access archive for the deposit and dissemination of scientific research documents, whether they are published or not. The documents may come from teaching and research institutions in France or abroad, or from public or private research centers.

L'archive ouverte pluridisciplinaire **HAL**, est destinée au dépôt et à la diffusion de documents scientifiques de niveau recherche, publiés ou non, émanant des établissements d'enseignement et de recherche français ou étrangers, des laboratoires publics ou privés.



Distributed under a Creative Commons Attribution 4.0 International License

Modelling of Station of Pumping by Variable Speed

Benretem A. ¹

1 – Electromechanical Engineering Laboratory, Badji-Mokhtar Annaba University P.O. Box12, 23000, Annaba, Algeria



DOI 10.13140/RG.2.1.4707.0324

Keywords: energetic efficiency, centrifugal pump, motor, variable speed drive, inverters, modelisation, simulation.

ABSTRACT. An increased energetic efficiency will make it possible to decrease the factory operating costs and hence to increase productivity. The centrifugal pumps are largely used because of their relatively simple operation and of their purchase price. One analyses thorough requirements imposed by the pumping plants is decisive. It is important to keep in mind the fact that the pumps consume approximately 20% of energy in the world. They constitute the possibility for the most significant efficiency improvement. They can reach their maximum effectiveness only with one pressure and a given flow. The approach suggested makes it possible to adapt with accuracy and effectiveness of system output of the industrial process requirements. The variable speed drive is one of best and effective techniques studied to reach this objective.

The appearance of this technique comes only after the evolution obtained in the field of power electronics systems precisely static inverters as well as the efforts made by the researchers in the field of electric drive systems. This work suggested is the result of an in-depth study on the effectiveness of this new technique applied for the centrifugal pumps.

1. Introduction. Due to their operating closer to the optimum, variable speed pumping plants are reliable: energy saving, maintenance intervals saving and hence stop costs reduction. According to the structure of the user, it is also possible, by the intermediary of a speed regulation, to reduce the number of the pumps size. The complexity of a centrifugal pump drive makes its study and design difficult as well as during its normal operation. To overcome this difficulty, one generally carries out simplifications: linearization of some characteristics, addition of inertias of all the moving parts to that of the engine, etc. in function of the objectives of modelling, these simplifications can give satisfactory results[3]. With the aim of reducing the costs and risks of bad operations in the evaluation phase and training of complex systems, the use of data-processing tools for digital simulation seems a justifiable intermediate stage between the theoretical study and the tests on real installations. Pump centrifuges P-102.b P-102.a several tools (specialized or not) for simulation are used in the field of the machines electric and of the power electronics [4] [5]: AT0SEC5, EMTP, SPICE, SIMNON, MATLAB, etc. [3]. **2. Modelisation of the System of Pumping.** Figure 1 presents prone pumping plant the "of study»; unit of ammonia NH₃ of the Asmidal factory - Annaba - Algeria and more precise the centrifugal pumps P-102 intended for fed the units of nitric acid, acid nitrate and of acid phosphates in product ammonia "to see figure 1".

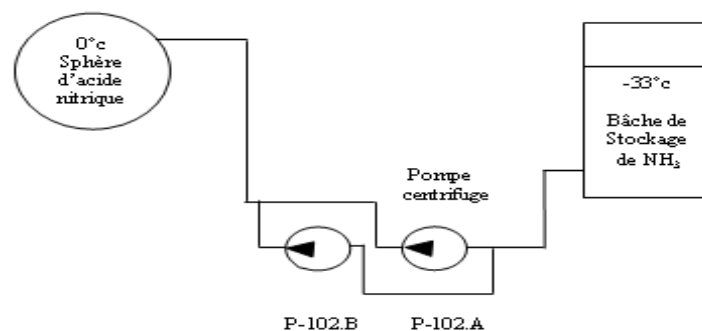

Fig. 1. diagram of the pumping plant of ammonia.

2.1 Mathematical modelling of the centrifugal pump.

Generally, the manufacturers do not give the characteristics of the pumps physical parameters performances $H = F(Q)$ is offered. Thus; knowing speed, the load height, and reference flow; it is possible to determine the system characteristics; the following relations can be used:

$$N_{sq} = \frac{1000 \left(\frac{N}{60} \right) \sqrt{Q}}{\left(\frac{gH}{N_{ep}} \right)^{3/4}}$$

$$Q = K_{sp} N (D_f)^3$$

$C_r = 0.3 + 3.9 \times 10^{-4} (\omega)^{1.8}$ The modelling characteristic diagram of the centrifugal pump equations system is presented in figure 2.[8]

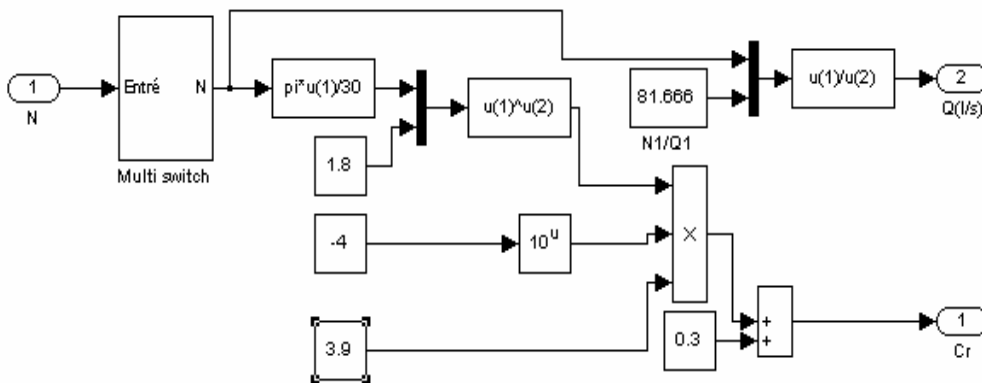

Fig. 2. Structure of the centrifugal pump unit.

2.2 Modeling of the squirrel cage induction motor. The drive is designed as an integrated block of which the goal is the optimal conversion of the electric power into mechanical energy and hydraulics by taking into account the performance criterion defined in the specifications. The modelling of the principal parts of the suggested pumping system (converter - engine - pump) are gathered and presented in figure 3.

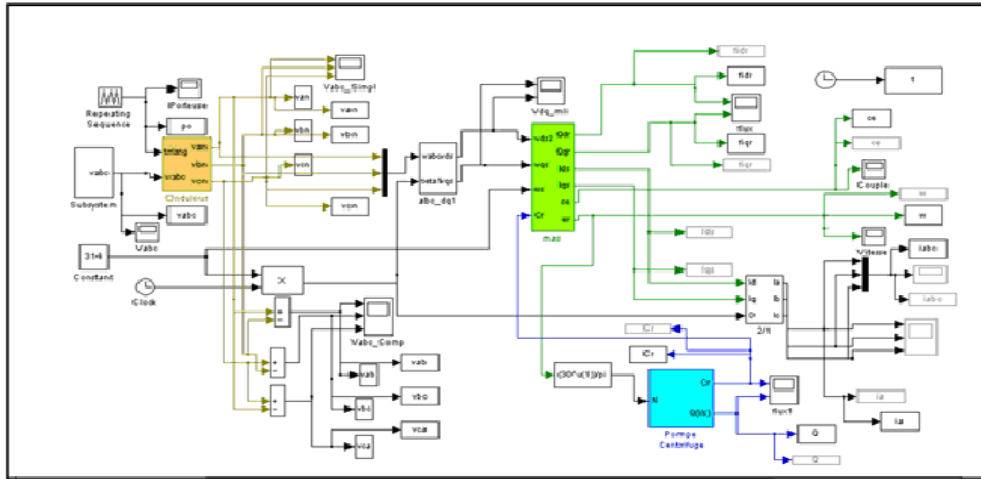

Fig. 3. Model of the pumping system.

3. Results of the system simulation.

3.1 Simulation of the system with constant speed. The figure.4 takes the stator current curve in transient state and permanent modes as well as the magnetic flux of the centrifugal pump drive motor with load and with no-load in the d- q plan. During the no-load, it can be noticed that flow is inversely proportional to the stator current; the introduction of the load "pumps centrifuges" does not present any remarkable evolution, always flow is inversely proportional to the stator current.

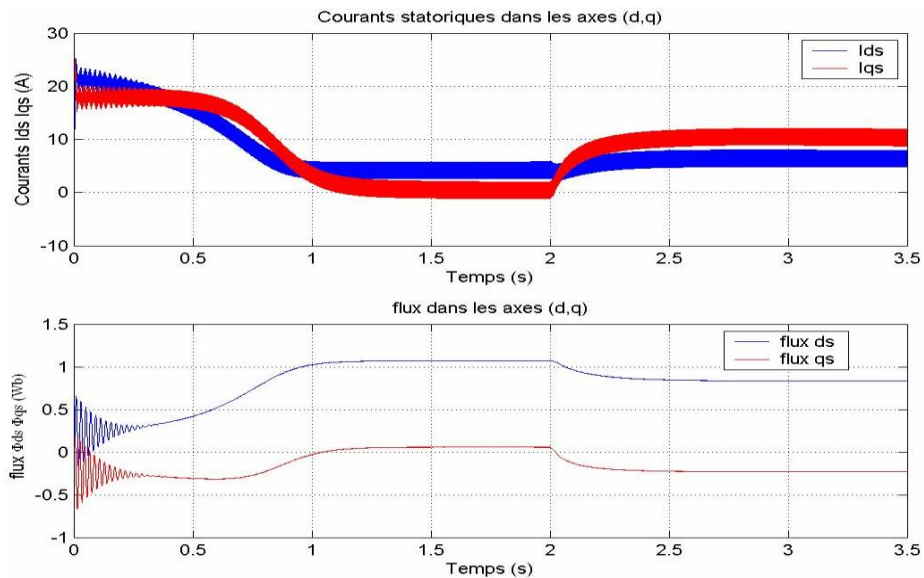

Fig. 4. Current stator and magnetic flux according to axes' (D, Q) in no-load and load (load applied at the moment $T = 2s$).

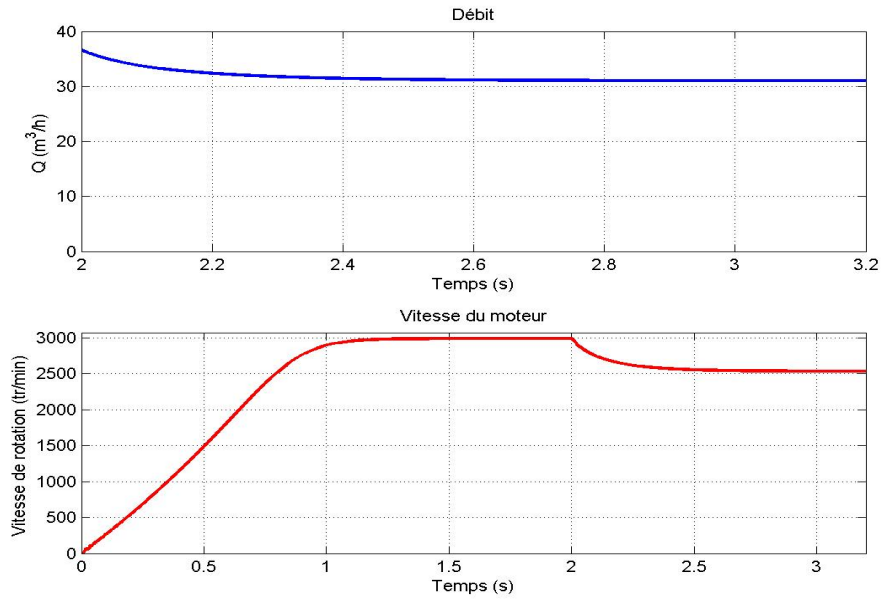

Fig. 5. Variation the motor speed: pump Flow corresponds at a speed of 2500 rev/min.

Figure.5 illustrates the variation of the pump revolutions number according to the flow. For a flow equal to $31 \text{ m}^3/\text{h}$, the number of revolutions takes a value equal to 2500 rev/min., at the time "t = 2 s" time of introduction of the load "the centrifugal pump" generates a reduction in the number of revolutions of the drive motor. On the other hand one records an increase in the values of the motor torque (electromagnetic torque) for the same time "t=2 S" as it is shown in figure.6.

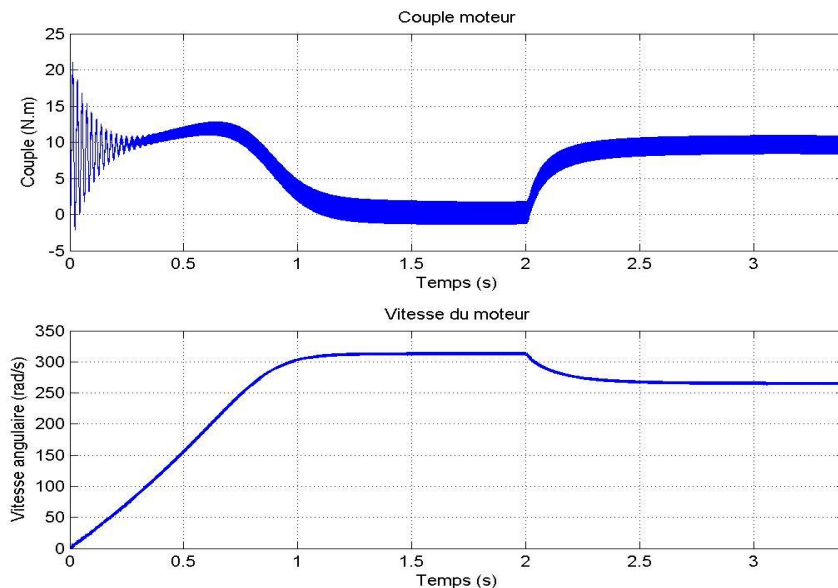

Fig. 6. Motor torque and angular velocity of the engine in a no-load and load (load applied at the time $T = 2\text{s}$).

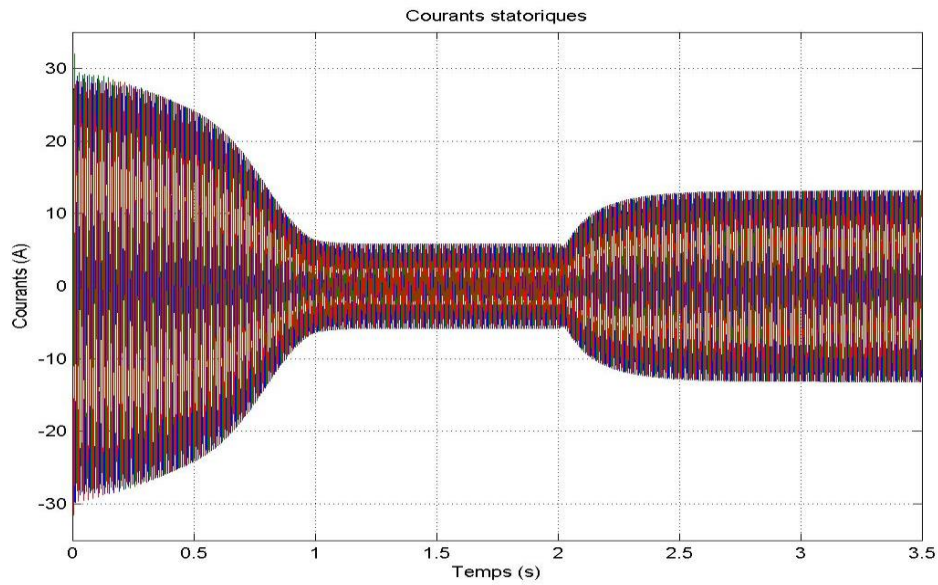

Fig. 7. Motor stator current with no-load and load (load applied at the time $T = 2s$).

Figure 7 shows that the motor torque is inversely proportional to the motor revolutions number; whereas the above mentioned torque is proportional to the motor stator current as shown in the figure 8.d' where the two curves take the same form except that one records an increase in the current amplitude of line beyond that time " $t = 2s$ ".

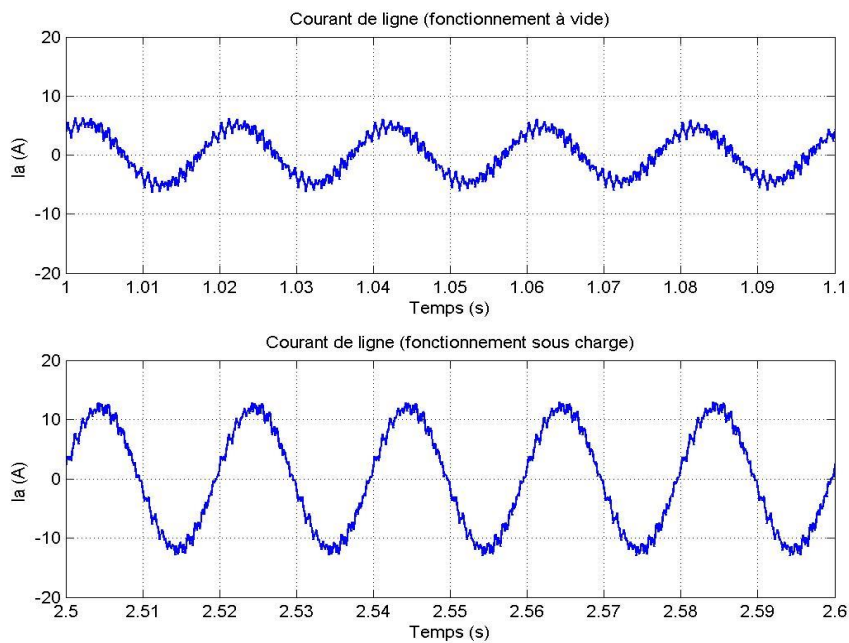

Fig. 8. Current of line (no-load and load).

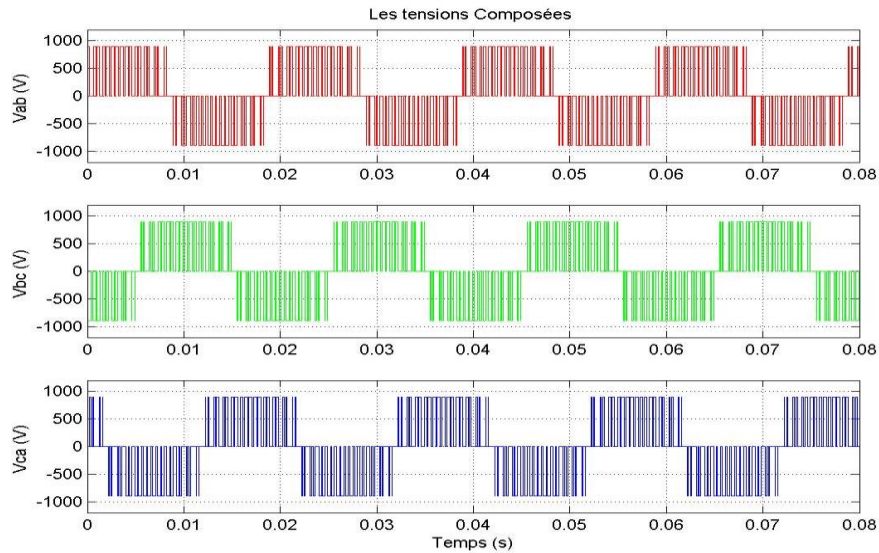

Fig. 9. Voltage made up of the 3 phases (operation under load).

Both figures.9 and 10 respectively represent the voltage waveform made up and simple of the three phases of the motor operating in load.

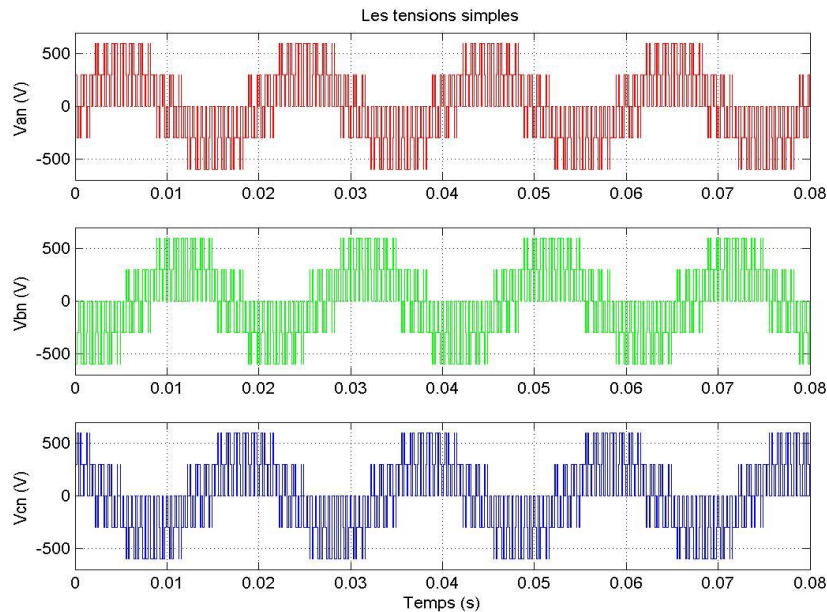

Fig.10. Simple voltage of the 3 phases (operation under load).

3.2 Simulation of a variable speed systemThe second part of simulation includes a new system because of the introduction of a variable speed control system; this technique can offer substantial cost saving in the electric power system when necessary flows or pressures variations were done in the system. Figure 11 shows that the flow and the number of revolutions take the same form according to time; in which the increase in flow causes the increase in the motor speed and its reduction generates the reduction of the latter (figure 11).

It can be noticed that there is a great improvement in the parameters compared to figure 5

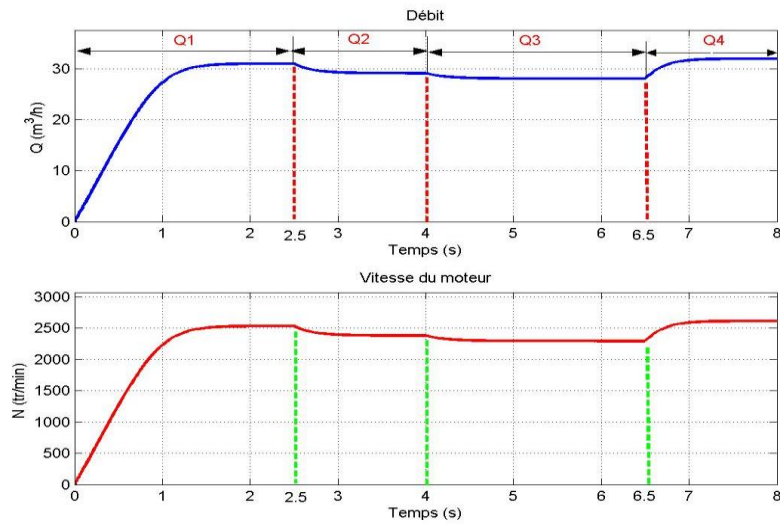

Fig. 11. Motor speed variation and the pump flow against time.

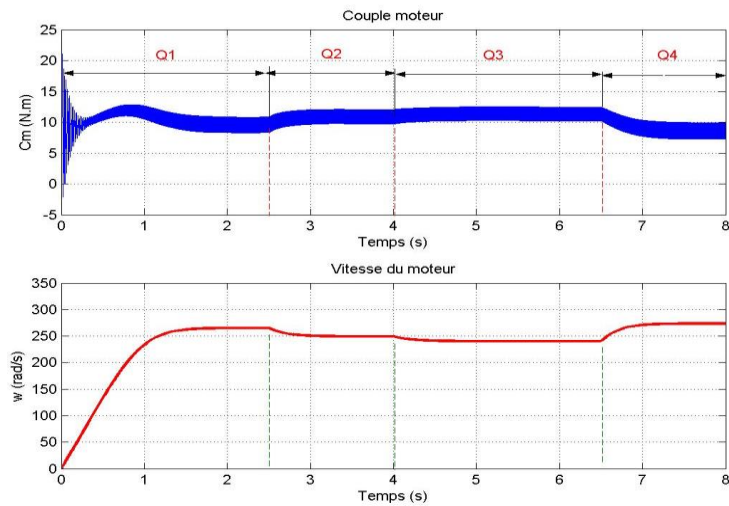

Fig. 12. Motor torque operating with load in function of speed variation.

Figure 12 shows that the torque is always inversely proportional to the motor speed

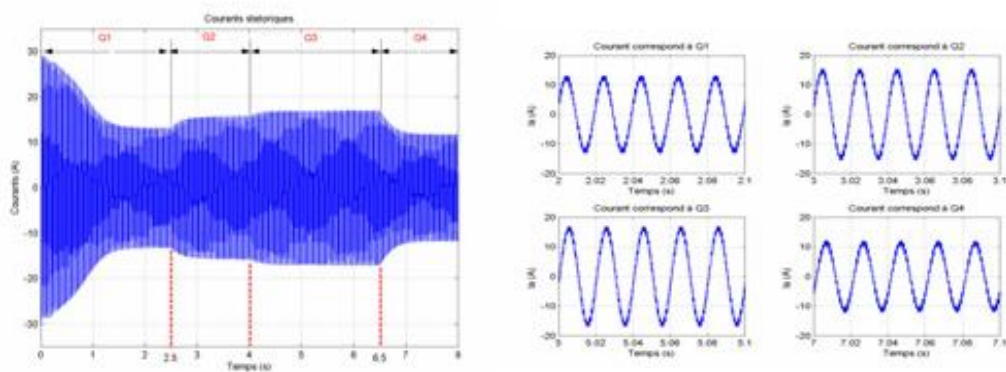

Fig. 13. The motor Stator current operating under load with speed variation.

The stator current results from this variation speed is shown in Figure 13; this current is proportional to the motor torque evolving with the variation of the pump flow. This proves that this technique is likely to improve the energy effectiveness of the centrifugal pump and to reduce the energy losses, as illustrated by this load profile of Figure.14

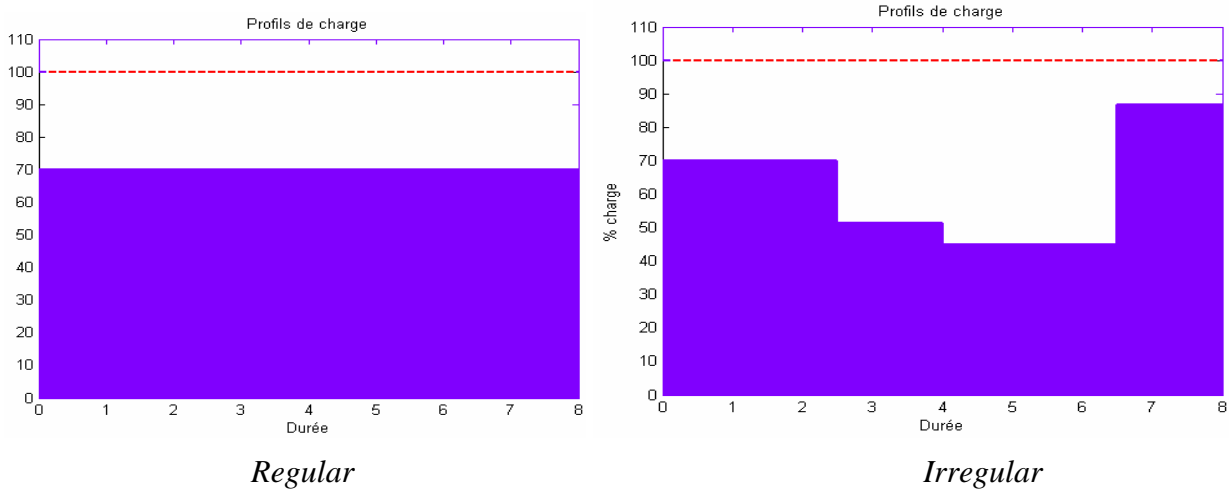

Fig. 14. Load profile of the pump operating at variable speed.

Summary. From an economic point of view, it is often more judicious to adapt the flows desired by the implementation of a variable speed drive. With a continuous speed variation, the consumption of energy is adapted to the needs and there is no energy dissipation.

The wear of the pumps, the bodies of throttling and the installation decreases, since the installation functions only in the necessary operation. The motor is definitely under loaded; and the pump has the possibility of starting smoothly and of the unfavourable hydraulic reactions is avoided. This intelligent method makes it possible to prolong the lifespan of the pump and the installation as a whole and increases the availability of the installations.

In general, the results obtained confirms the reliability of modelling carried out, the possibility of optimization of the system and minimization of the energy losses.

These satisfactory and clear results show that the use of the variable speed drive in centrifugal pumps is an optimal solution in spite of its complexity and its relatively high price.

References

- [1] Peeic (Programmer of Energy Saving in Canadian Industry), "Guide of evaluation of the output of the energy driving systems ".Natural resources Canada 2004.
- [2] Arene, "The true cost of the pumps".Hydro more, N 128.November 2002.
- [3] Doumbia.M.L, "Tool of assistance to the systems design of electric drive of machine, example of application ".Thesis of PhD of the polytechnic school of Montreal. 2000.
- [4] Boubacar.N, "Design techno - economic of a system of autonomous pumping photovoltaic - aero generator ".Memory of M.Sc.A of the polytechnic school of Montreal. February 1999.
- [5] Mohan.N, Undeland.T and Robbins.W, "Simulation of Power Electronic and Motion Systems Control - Year Overview» Proceeding of the IEEE, vol. 82, No 8, August, 1989.
- [6] Etxeberria- Otadui.I, "On the system of the electronics of power dedicate has the electric distribution - application has the quality of energy ".Thesis of doctorate of the Institut National Polytechnique of Grenoble.September 2003.
- [7] Stanoff. A. J, "Centrifugal pump and pumps Propellers ".Dunod. Paris.1961

[8] Betka Achour Perspectives for the sake of photovoltaic pumping development in the south thesis for doctorate of state Biskra Science.

[9] Automatic alpha issaga diallo Sélection of the asynchronous motors in the industrial drives thesis for obtaining Master be sciences (M.Sc) University Laval 1998