



HAL
open science

Hierarchical approach to investigate the robust performance of uncertain large scale systems

Khaled Laib, Anton Korniienko, Marc Dinh, Gérard Scorletti, Florent Morel

► **To cite this version:**

Khaled Laib, Anton Korniienko, Marc Dinh, Gérard Scorletti, Florent Morel. Hierarchical approach to investigate the robust performance of uncertain large scale systems. [Research Report] Ecole Centrale de Lyon. 2016. hal-01306918

HAL Id: hal-01306918

<https://hal.science/hal-01306918>

Submitted on 28 May 2016

HAL is a multi-disciplinary open access archive for the deposit and dissemination of scientific research documents, whether they are published or not. The documents may come from teaching and research institutions in France or abroad, or from public or private research centers.

L'archive ouverte pluridisciplinaire **HAL**, est destinée au dépôt et à la diffusion de documents scientifiques de niveau recherche, publiés ou non, émanant des établissements d'enseignement et de recherche français ou étrangers, des laboratoires publics ou privés.

Hierarchical approach to investigate the robust performance of uncertain large scale systems

K. Laib¹, A. Korniienko¹, M. Dinh², G. Scorletti¹ and F. Morel¹

¹ Laboratoire Ampère Dpt. EEA of the Ecole Centrale de Lyon, Université de Lyon,
69134 Ecully Cedex, France.

² MaIAGE, INRA, Université Paris-Saclay, 78350 Jouy-en-Josas, France.

Abstract

In this report, the problem of robust performance analysis of interconnected uncertain systems with hierarchical structure is considered. The computational load associated to such problems does not allow a direct application of robustness analysis usual tools. To overcome this difficulty, we exploit the hierarchical structure of the problem and propose an algorithm to perform robustness analysis using IQC "propagation" along the hierarchical structure. This algorithm allows to establish a trade-off between computation time required to perform the analysis and the conservatism of the obtained results. Furthermore, it is easy to perform parallel computation using the proposed algorithm.

keywords Uncertain large scale systems, robustness analysis, IQC analysis, LMI optimization, hierarchical approach, IQC propagation.

1 Introduction

Robustness analysis of uncertain large scale systems (LSS) to ensure a certain level of performance in the worst case scenario is a major topic in the automatic control community. These LSS (networks) are obtained by interconnecting smaller subsystems within the objective of ensuring some global tasks. Therefore, it is natural to consider the hierarchical structure of networks: subsystems define the local level while their interconnection define the global level. In this report, we are interested in robustness analysis of uncertain large scale systems with hierarchical structure.

Robustness analysis of uncertain LSS is a problem with many challenges. Major difficulties that frequently arise in this problem are: robustness analysis and large scale aspects. Although the robustness analysis is an NP hard problem [1], many efficient methods have been developed based on relaxations as convex optimization problem under Linear Matrix Inequality (LMI) constraints [2], see e.g. the μ -upper bound [3] in the μ -analysis approach [4] or the Integral Quadratic Constraint (IQC) approach [5].

The second aspect is the large scale associated to networks. Even when we consider the interconnection of systems without any uncertainties, the analysis problem remains complicated and the network stability is not easy to certify. In this case, the robustness of the LSS is discussed with respect to size of the network and its interconnection topology. The objective is to establish decentralized conditions to ensure the stability of the LSS *i.e.* conditions that subsystems have to satisfy with respect to their interconnection matrix to guarantee the overall stability of the network. These conditions are obtained in different frameworks: [6] and [7] for dissipativity approaches, [8] and [9] for S -hull convexification approaches, [10] and [11] for graph theory approaches, *etc.*

Nevertheless, when considering both aspects (robustness and large scale), the complexity and computation time increase dramatically which is due to the large size optimization problem we have to solve. Therefore, the robustness analysis usual tools cannot be practically applied directly.

In order to reduce this computational load, researchers focused on exploiting the particular characteristics of the subsystems and their interconnections. The authors of [12] propose a decomposable approach to investigate the robustness of uncertain LSS. The obtained conditions involve the structured singular values of the individual systems and the eigenvalues of the interconnection matrix. However, these results are valid only when the subsystems are homogeneous. Within the framework

of IQC, characterizations of local systems and/or interconnections are used to obtain robust stability conditions in the case where the interconnection matrix is normal [13], unitarily diagonalized [14] or sparse with a chordal pattern [15] and [16]. However for a given LSS, it could be difficult to model the network with a normal, unitarily diagonalized or interconnection matrix with a chordal pattern. Furthermore, even if the network presents one of these structures, the previous methods allow only to investigate the stability. Adding extra signals to investigate the performance may change the structure. In addition, these results do not exploit an important aspect of the problem which is the hierarchical structure. In this context, the *Hierarchical approach* was initially introduced in [17], in the case of conic uncertainty *i.e.* non structured dynamical uncertainty, to split the overall analysis problem into several low dimensional problems. Each uncertain system in the network can be characterized with conic properties which are a special case of IQC. The overall analysis is then performed in hierarchical manner by propagating conic properties along the hierarchical structure. Nevertheless, this approach was not really exploited and implemented because it has neither been explained nor formulated how to obtain these IQC characterizing uncertain systems.

In this report, we adapt the hierarchical approach and extend it to the case of structured uncertainties. As a first contribution of this report, we define a set IQC characterizing different information of the uncertain system: gain uncertainty, phase uncertainty, mixed gain-phase uncertainty. The IQC set thus defines a basis to characterize uncertain systems. In order to reduce the conservatism of this approach, a size measure is defined and minimized for each of the basis element. The problem of minimizing each size measure is formulated as an LMI optimization problem which can be solved efficiently. A second contribution of this report is an algorithm to investigate the robust performance of the overall uncertain large scale system using basis propagation along the hierarchical structure. This algorithms allows to establish a trade-off between computation time required for the analysis and the conservatism of the results. Preliminary results of this approach can be found in [18–20].

Report outline

This report is organized as follows: Section 2 presents the formulation of uncertain LSS performance analysis problem. Section 3 presents the usual approach to perform robustness analysis of uncertain systems using dissipativity properties (IQC). Section 4 presents the proposed approach to solve the

problem of robustness analysis of uncertain LSS using basis propagation. The formulation and practical computation of the basis elements are presented in Section 5. The benefits of the hierarchical approach, compared to the direct analysis method, are illustrated through two examples: PLL network in Section 6 and a chain of uncertain system in Section 7. We discuss in Section 8 the algorithmic complexity and the computation time required to perform robustness analysis for a sub-class of uncertain LSS with hierarchical structure. Conclusions and perspectives are presented in Section 9.

Notations

The maximum singular value of a matrix M is denoted $\bar{\sigma}(M)$. If the index of a matrix or a signal is not relevant and can be understood from the context, then this index will be omitted or replaced with "•". The real and imaginary parts of the complex entity • are denoted $\text{Re}(\bullet)$ and $\text{Im}(\bullet)$ respectively. \mathbf{RH}_∞ (respectively \mathbf{RL}_∞) denotes the set of matrices of stable (resp. non causally stable) rational transfer functions. Moreover, we consistently denote elementary uncertainties by Δ and interconnections by M which can be partitioned into $M = \begin{pmatrix} M_{11} & M_{12} \\ M_{21} & M_{22} \end{pmatrix}$.

For several matrices M_i , $i = 1, \dots, n$, $\mathbf{bdiag}_i(M_i)$ denotes the block diagonal matrix composed of M_i given by

$$\mathbf{bdiag}_i(M_i) = \begin{pmatrix} M_1 & \dots & 0 \\ \vdots & \ddots & \vdots \\ 0 & \dots & M_n \end{pmatrix}$$

We denote by $\Delta \star M$ the set $\{\Delta \star M, \forall \Delta \in \mathbf{\Delta}\}$, referred to as an uncertain system, defined by

$$\Delta \star M = M_{22} + M_{21}\Delta(I - M_{11}\Delta)^{-1}M_{12}$$

with \star standing for the Redheffer star product and it will be referred to as the Linear Fractional Transformation (LFT) interconnection of M and Δ .

Finally, we denote by $\mathcal{L}_S(\bullet, \Phi_{11}, \Phi_{12}, \Phi_{22})$ the matrix

$$\begin{pmatrix} \bullet \\ I \end{pmatrix}^* \left(\begin{array}{c|c} -\Phi_{22} & -\Phi_{12}^* \\ \hline -\Phi_{12} & -\Phi_{11} \end{array} \right) \begin{pmatrix} \bullet \\ I \end{pmatrix}.$$

and we denote by $\mathcal{L}_P(\bullet, \Phi_{11}, \Phi_{12}, \Phi_{22}, X, Y, Z, \epsilon)$ the matrix

$$\begin{pmatrix} \bullet \\ I \end{pmatrix}^* \left(\begin{array}{cc|cc} -\Phi_{22} & 0 & -\Phi_{12}^* & 0 \\ 0 & X - \epsilon I & 0 & Y \\ \hline -\Phi_{12} & 0 & -\Phi_{11} & 0 \\ 0 & Y^* & 0 & Z - \epsilon I \end{array} \right) \begin{pmatrix} \bullet \\ I \end{pmatrix}.$$

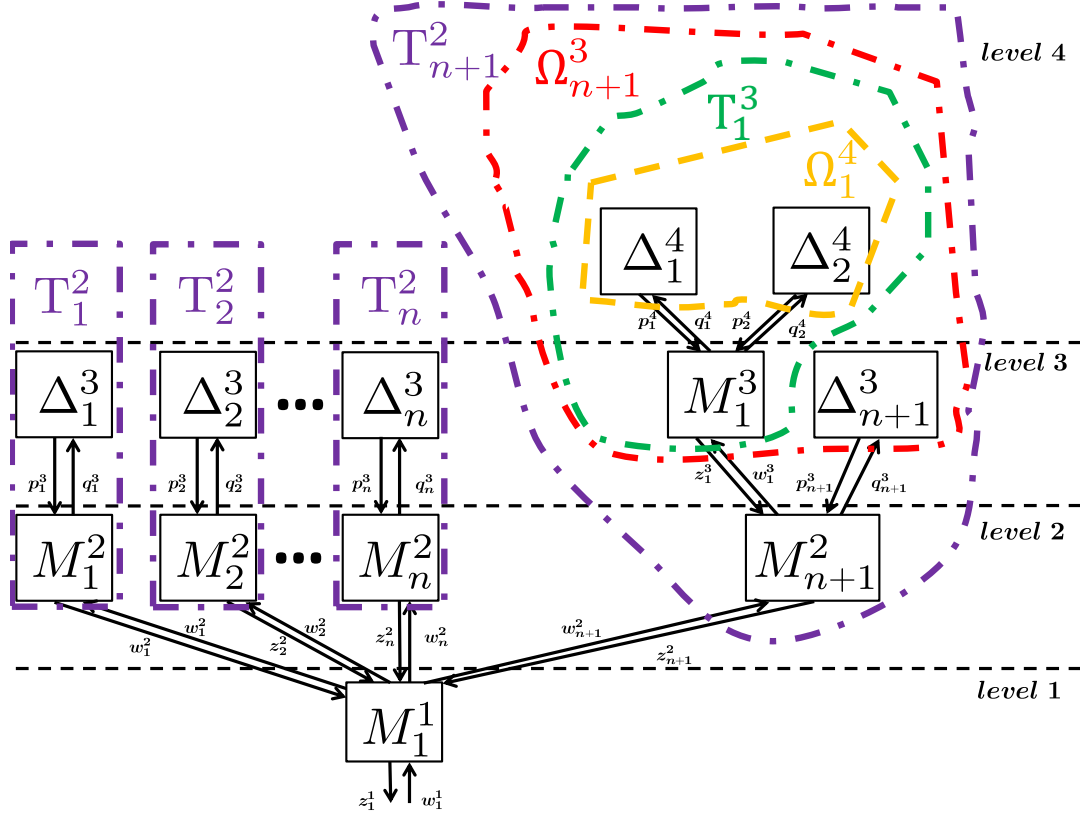

Figure 1: Uncertain linear large scale system T_1^1 with hierarchical structure of four levels

2 Problem Formulation

2.1 LSS Hierarchical Structure

Inspired by [17] and [18], an uncertain large scale system is defined by a tree composed of leaves interconnected through branches. These leaves and branches will be organized by levels. An example of tree is illustrated in Fig. 1 where a hierarchical structure arises with $l = 4$ levels.

An index i is associated to each level *i.e.* $i = 1, \dots, l$. At each level i , two types of components may be found: leaves and branches.

The leaves represent the elementary uncertain components and they are denoted $\Delta_{j_\Delta}^i \in \Delta$ with $j_\Delta \in \{1, \dots, N_\Delta^i\}$ where N_Δ^i is the number of elementary uncertain components at level i and Δ is the uncertainty set traditionally considered in robust analysis literature. It is given as block diagonal

combination of elementary uncertainties:

$$\mathbf{\Delta} = \left\{ \Delta \left| \begin{array}{l} \|\Delta\|_\infty < 1 \\ \Delta = \mathbf{bdiag}(\delta_1^r I_{r_1}, \dots, \delta_{n_r}^r I_{r_{n_r}}, \\ \delta_1^c I_{c_1}, \dots, \delta_{n_c}^c I_{c_{n_c}}, \\ \Delta_1, \dots, \Delta_{n_f}) \end{array} \right. \right\} \quad (1)$$

where

- $\delta_j^r \in \mathbb{R}$ is a real parametric uncertainty,
- $\delta_j^c \in \mathbb{C}$ is a complex uncertainty,
- Δ_j is a LTI systems which represents dynamical uncertainty with k_m^j inputs and k_l^j outputs.

The set $\mathbf{\Delta}$ is an elementary uncertainty set in the sense that it is a bounded and connected set with "known" bound $\|\Delta\|_\infty < 1$. The input output signals of $\Delta_{j\Delta}^i$ are $q_{j\Delta}^i$ and $p_{j\Delta}^i$ respectively. The elementary uncertain components $\Delta_{j\Delta}^i$, of level i , are the end of the tree *i.e.* leaves since they are only connected to the certain components of the level $i - 1$.

The branches are the certain components and they are denoted $M_{j_M}^i$, assumed to be LTI systems, with $j_M \in \{1, \dots, N_M^i\}$ where N_M^i is the number of certain components at the level i . In contrast with $\Delta_{j\Delta}^i$, which are only connected to certain components of the level below, $M_{j_M}^i$ are connected to both levels: below and above. The certain components $M_{j_M}^i$ are connected to certain and to uncertain components from level $i + 1$ and to certain components from level $i - 1$. The signals $w_{j_M}^i$ and p_{\bullet}^{i+1} (and possibly z_{\bullet}^{i+1}) are the input signals of $M_{j_M}^i$ while $z_{j_M}^i$ and q_{\bullet}^{i+1} (and possibly w_{\bullet}^{i+1}) are the output signals.

After showing the different levels of the LSS with its different certain and uncertain components (which can be seen as an horizontal decomposition), it is possible to regroup the components connected vertically. The result will be an uncertain system denoted T_j^i , where i stands for the hierarchical level and j is the index of the uncertain system at this hierarchical level. The signals w_j^i and z_j^i are the input and output signals of the uncertain system T_j^i . The number of uncertain systems at each level i is $N_T^i = N_M^i$.

Each uncertain system T_j^i , is the LFT interconnection of $M_{j_M}^i$ with either just only elementary uncertain components of the next hierarchical level (Δ_{\bullet}^{i+1} for example) or a block diagonal composition

of elementary uncertain components Δ_{\bullet}^{i+1} and uncertain systems T_{\bullet}^{i+1} from the next hierarchical level. For the ease of notation, and for the purpose of this report, both cases will be combined into block diagonal augmented uncertainty that will be denoted $\Omega_{\bullet}^{i+1} \in \mathbf{\Omega}$ where $\mathbf{\Omega}$ is the extension of the elementary uncertainty set (1), that is

$$\mathbf{\Omega} = \left\{ \Omega \mid \Omega = \mathbf{bdiag}_j (\Omega_j) \right\} \quad (2)$$

where Ω_j is either an elementary uncertainty block *i.e.* $\Omega_j \in \mathbf{\Delta}$, or an uncertain LTI system that belongs to a bounded and connected set without a priori "known" bound.

It is possible now to model the LSS as

$$\begin{aligned} \forall i \in \{1, \dots, l-1\} \\ \forall j \in \{1, \dots, N_T^i\} \\ z_j^i = \underbrace{\Omega_j^{i+1} \star M_j^i}_{T_j^i} w_j^i \end{aligned} \quad (3)$$

with

$$\Omega_j^{i+1} = \mathbf{bdiag} \left(\mathbf{bdiag}_{m \in \mathcal{N}_{\Delta}(M_j^i)} (\Delta_m^{i+1}), \mathbf{bdiag}_{n \in \mathcal{N}_T(M_j^i)} (T_n^{i+1}) \right) \quad (4)$$

where $\mathcal{N}_T(M_j^i)$ is the index set of the uncertain systems T_{\bullet}^{i+1} connected to M_j^i and $\mathcal{N}_{\Delta}(M_j^i)$ is the index set of the elementary uncertain components Δ_{\bullet}^{i+1} connected to M_j^i respectively.

For purpose of illustration, let us consider the LSS presented in Fig. 1 where w_1 and z_1 are the input and the output signals respectively. They define the system T_1^1 for which we want to investigate the performance as it will be formally defined later. At level 2, the components can be regrouped into $n+1$ uncertain systems T_j^2 , for $\forall j \in \{1, \dots, n+1\}$, interconnected through M_1^1 to form T_1^1 . Each T_j^2 is the LFT interconnection of M_j^2 with Ω_j^3 . Two types of Ω_j^3 appears: either $\Omega_j^3 = \Delta_j^3$ for $j = \{1, \dots, n\}$ or $\Omega_{n+1}^3 = \mathbf{bdiag} (\Delta_{n+1}^3, T_1^3)$. This last uncertain system T_1^3 , used to construct Ω_{n+1}^3 , is in itself the interconnection of M_1^3 with Ω_1^4 which is the block diagonal combination of two elementary uncertain components: $\Omega_1^4 = \mathbf{bdiag} (\Delta_1^4, \Delta_2^4)$.

2.2 Problem statement

The LTI system performance is achieved if the maximum singular value $\bar{\sigma}(\bullet)$ of the system frequency response respects, along the frequencies, some user-defined frequency dependent constraints (see [21]). Since the uncertainties will impact the system frequency response, we denote γ_{ω_0} as an upper bound on the system maximum singular value $\bar{\sigma}(\bullet)$ for a given frequency ω_0 and over all the uncertainties. Hence, the robust performance analysis boils down to check if the computed minimal value γ_{ω_0} , for each frequency ω_0 , is less than the user defined bound for all the possible uncertainties.

Now, the robust performance analysis problem of uncertain LSS can be formulated.

Problem 2.1 (Robust Performance) *Given an uncertain LSS defined by (3) and (4) with $\Delta_j^i \in \Delta$, $M_j^i \in \mathbf{RH}_\infty$. Given l , N_T^i , $\mathcal{N}_T(M_j^i)$ and $\mathcal{N}_\Delta(M_j^i)$ and given a frequency ω_0 , test efficiently if the global system is stable $\forall \Delta_j^i \in \Delta$ for all i, j and solve efficiently*

$$\begin{aligned} \min_{\gamma_{\omega_0}} \quad & \gamma_{\omega_0} \\ \text{s.t.} \quad & \bar{\sigma}(T_1^1(\mathbf{j}\omega_0)) < \gamma_{\omega_0} \quad \forall \Delta_j^i \in \Delta \end{aligned}$$

In the next section, we present robustness analysis tools from the robust control theory to investigate the performance of uncertain systems.

3 Robustness Analysis of Uncertain Systems

3.1 Uncertain systems

An uncertain system will be defined as an interconnection $T = \Omega \star M$ with $M \in \mathbf{RH}_\infty$ and $\Omega \in \mathbf{\Omega}$ where $\mathbf{\Omega}$ is bounded and connected set of LTI systems as in (2). Introducing the internal signals and using the frequency domain, we obtain the following system description

$$\begin{aligned} p(\mathbf{j}\omega) &= \Omega(\mathbf{j}\omega) q(\mathbf{j}\omega) \\ \begin{pmatrix} q(\mathbf{j}\omega) \\ z(\mathbf{j}\omega) \end{pmatrix} &= M(\mathbf{j}\omega) \begin{pmatrix} p(\mathbf{j}\omega) \\ w(\mathbf{j}\omega) \end{pmatrix} \end{aligned} \tag{5}$$

where $w(\mathbf{j}\omega)$ and $z(\mathbf{j}\omega)$ are the input and the output signals of size n_w and n_z respectively. These signals will be used to define and evaluate system performance as it will be explained later. The signals $p(\mathbf{j}\omega)$ and $q(\mathbf{j}\omega)$ are internal signals of size n_p and n_q respectively, see Fig 2.

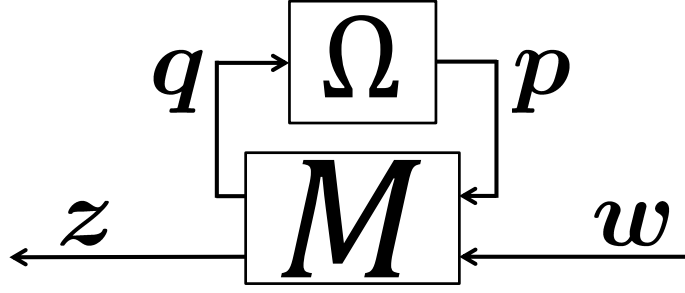

Figure 2: Uncertain Linear system

3.2 Robustness analysis

We will use dissipativity properties to characterize the performance of an uncertain system T . In the field of robust control theory, Integral Quadratic Constraints (IQC) are often used to characterize the system behavior in a form of input-output signal relations (also known as graph relations).

Definition 3.1 (IQC) *The two signals $w(\mathbf{j}\omega)$ and $z(\mathbf{j}\omega)$ are said to satisfy the IQC defined by the multiplier $\Phi \in \mathbf{RL}_\infty$, if $\exists \epsilon > 0$*

$$\int_{-\infty}^{+\infty} \begin{pmatrix} z(\mathbf{j}\omega) \\ w(\mathbf{j}\omega) \end{pmatrix}^* \Phi(\mathbf{j}\omega) \begin{pmatrix} z(\mathbf{j}\omega) \\ w(\mathbf{j}\omega) \end{pmatrix} d\omega \geq \epsilon \int_{-\infty}^{+\infty} \begin{pmatrix} z(\mathbf{j}\omega) \\ w(\mathbf{j}\omega) \end{pmatrix}^* \begin{pmatrix} z(\mathbf{j}\omega) \\ w(\mathbf{j}\omega) \end{pmatrix} d\omega \quad (6)$$

Since the problem considered in this report is the performance analysis of uncertain LTI systems *i.e.* $z(\mathbf{j}\omega) = T(\mathbf{j}\omega)w(\mathbf{j}\omega)$, the integral term could be dropped and the IQC become Quadratic Constraints (QC). Furthermore if:

$$\Phi(\mathbf{j}\omega) = \begin{pmatrix} X(\mathbf{j}\omega) & Y(\mathbf{j}\omega) \\ Y(\mathbf{j}\omega)^* & Z(\mathbf{j}\omega) \end{pmatrix}$$

with $X(\mathbf{j}\omega) = X(\mathbf{j}\omega)^*$, $Z(\mathbf{j}\omega) = Z(\mathbf{j}\omega)^*$ and $Y(\mathbf{j}\omega)$ are transfer functions of \mathbf{RL}_∞ , the QC thus define dissipativity properties for the uncertain system $\Omega \star M$ that is $\Omega \star M$ is said to be $\{X(\mathbf{j}\omega), Y(\mathbf{j}\omega), Z(\mathbf{j}\omega)\}$ dissipative for every ω if:

$$\begin{pmatrix} \Omega(\mathbf{j}\omega) \star M(\mathbf{j}\omega) \\ I \end{pmatrix}^* \begin{pmatrix} X(\mathbf{j}\omega) & Y(\mathbf{j}\omega) \\ Y(\mathbf{j}\omega)^* & Z(\mathbf{j}\omega) \end{pmatrix} \begin{pmatrix} \Omega(\mathbf{j}\omega) \star M(\mathbf{j}\omega) \\ I \end{pmatrix} \geq \epsilon \begin{pmatrix} \Omega(\mathbf{j}\omega) \star M(\mathbf{j}\omega) \\ I \end{pmatrix}^* \begin{pmatrix} \Omega(\mathbf{j}\omega) \star M(\mathbf{j}\omega) \\ I \end{pmatrix} \quad (7)$$

Furthermore, if the uncertain system $\Omega \star M$ is $\{X(\mathbf{j}\omega), Y(\mathbf{j}\omega), Z(\mathbf{j}\omega)\}$ dissipative for every $\Omega \in \mathbf{\Omega}$, then the uncertain system $\mathbf{\Omega} \star M$ is $\{X(\mathbf{j}\omega), Y(\mathbf{j}\omega), Z(\mathbf{j}\omega)\}$ dissipative. As it is usual for LTI systems, a

frequency by frequency approach can be performed without loss of generality [22]. A frequency gridding is defined and the different operations and ideas will be introduced for a given frequency ω_0 .

Lemma 3.1 *For a given LTI system T , given γ_{ω_0} , the robust performance defined in Problem 2.1, can be expressed in terms of $\{X, Y, Z\}$ dissipativity in the following way*

$$\bar{\sigma}(T(\mathbf{j}\omega_0)) < \gamma_{\omega_0} \iff T(\mathbf{j}\omega_0) \text{ is } \{X, Y, Z\} \text{ dissipative}$$

for all $\Delta_j^i \in \mathbf{\Delta}_j^i$ with $X = -I$, $Y = 0$ and $Z = \gamma_{\omega_0}^2 I$.

In order to keep the discussion as general as possible, we will use, in this report, a general performance measure defined by a general $\{X, Y, Z\}$ dissipativity.

The following theorem gives necessary and sufficient conditions to perform Robust Performance Analysis (RPA).

Theorem 3.1 (RPA Theorem) *Let $\mathbf{\Omega}$ be a bounded and connected set of LTI systems. The uncertain system $\mathbf{\Omega} \star M$ is stable and $\{X, Y, Z\}$ dissipative if and only if*

1. *There exists a $\Omega_0 \in \mathbf{\Omega}$ such that $\Omega_0 \star M$ is stable.*
2. *There exists a hermitian matrix $\Phi = \Phi^*$ of \mathbf{RL}_∞ such that Ω is $\{\Phi_{11}, \Phi_{12}, \Phi_{22}\}$ dissipative for every $\Omega \in \mathbf{\Omega}$*
3. *There exists $\epsilon > 0$ such that $\mathcal{L}_{\mathcal{P}}(M, \Phi_{11}, \Phi_{12}, \Phi_{22}, X, Y, Z, \epsilon) \geq 0$*

Proof 3.1 *The proof can be found in the Appendix.*

Theorem 3.1 presents necessary and sufficient conditions for the uncertain system $\mathbf{\Omega} \star M$ to be $\{X, Y, Z\}$ dissipative. Testing these conditions (find Φ such that conditions 2 and 3 are satisfied) is a convex optimization problem. Nevertheless, it is infinite dimensional since condition 2 has to be tested for all $\Omega \in \mathbf{\Omega}$ which is difficult from a computational point of view. In order to obtain a finite dimensional convex optimization problem, let us introduce the set

$$\mathbf{\Phi}_\Omega = \left\{ \Phi_\Omega = \begin{pmatrix} \mathbf{bdiag}(\Phi_{11})_j & \mathbf{bdiag}(\Phi_{12})_j \\ \mathbf{bdiag}(\Phi_{12}^*)_j & \mathbf{bdiag}(\Phi_{22})_j \end{pmatrix} \right\}$$

such that the second condition is satisfied for all $\Omega \in \Phi_{\Omega}$. Let us introduce as well the sets associated to each $\Omega_j \in \Phi_{\Omega_j}$ as

$$\Phi_{\Omega_j} = \left\{ \Phi_{\Omega_j} = \begin{pmatrix} (\Phi_{11})_j & (\Phi_{12})_j \\ (\Phi_{12}^*)_j & (\Phi_{22})_j \end{pmatrix} \right\}$$

Furthermore, for each Ω_j , let us define $\mathcal{B}_{\Omega_j}^{diss}$ sets of $\Phi_j^k \in \Phi_{\Omega_j}$ with $k \in \{1, \dots, n_j^d\}$, sets of conically independent elements Φ_j^k i.e. each Φ_j^k cannot be expressed as the conic combination of Φ_j^l , $l \in \{1, \dots, n_j^d\} \setminus \{k\}$. Please note, since $\Phi_j^k \in \Phi_{\Omega_j}$ for all $k \in \{1, \dots, n_j^d\}$, the uncertainty Ω_j is $\{(\Phi_{11})_j^k, (\Phi_{12})_j^k, (\Phi_{22})_j^k\}$ dissipative with

$$\begin{pmatrix} (\Phi_{11})_j^k & (\Phi_{12})_j^k \\ (\Phi_{12}^*)_j^k & (\Phi_{22})_j^k \end{pmatrix} = \Phi_j^k \in \mathcal{B}_{\Omega_j}^{diss} \quad (8)$$

Then, let us define $\Phi(\mathcal{B}_{\Omega}^{diss})$ a set of block diagonal conic combinations of the elements of $\mathcal{B}_{\Omega_j}^{diss}$ as

$$\Phi(\mathcal{B}_{\Omega}^{diss}) = \left\{ \Phi^{\Omega} \left| \begin{array}{l} \exists \alpha_{kj} \geq 0, k \in \{1, \dots, n_j^k\} \\ \Phi^{\Omega} = \begin{pmatrix} \Phi_{11}^{\Omega} & \Phi_{12}^{\Omega} \\ (\Phi_{12}^{\Omega})^* & \Phi_{22}^{\Omega} \end{pmatrix} \\ \Phi_{gh}^{\Omega} = \mathbf{bdiag}_j \left(\sum_{k=1}^{n_j^k} \alpha_{kj} (\Phi_{gh})_j^k \right) \\ \text{with } g, h \in \{1, 2\} \\ \text{and } \Phi_j^k \in \mathcal{B}_{\Omega_j}^{diss} \end{array} \right. \right\} \quad (9)$$

Since Φ_{Ω} is a convex cone, the subset $\Phi(\mathcal{B}_{\Omega}^{diss}) \subseteq \Phi_{\Omega}$.

A counterpart of Theorem 3.1 with sufficient conditions only is given in the following corollary.

Corollary 3.1 *Let Ω be a bounded and connected set of LTI systems as in (2), let:*

1. *There exists $\Omega_0 \in \Omega$ such that the system is $\Omega_0 \star M$ is stable.*
2. *There exist $\epsilon > 0$ basis sets $\mathcal{B}_{\Omega_j}^{diss}$ of conically independent elements Φ_j^k as in (8) for which Ω_j is $\{(\Phi_{11})_j^k, (\Phi_{12})_j^k, (\Phi_{22})_j^k\}$ dissipative $\forall k$*

Then, the uncertain system $\Omega \star M$ is stable and $\{X, Y, Z\}$ dissipative if there exists a $\Phi^{\Omega} \in \Phi(\mathcal{B}_{\Omega}^{diss})$ as in (9) such that

$$\mathcal{L}_{\mathcal{P}}(M, \Phi_{11}^{\Omega}, \Phi_{12}^{\Omega}, \Phi_{22}^{\Omega}, X, Y, Z, \epsilon) \geq 0 \quad (10)$$

Proof 3.2 *This is an immediate consequence of Theorem 3.1 after parametrization of Φ .*

Remark 3.1 *In contrast with Theorem 3.1 and if there exist the basis $\mathcal{B}_{\Omega_j}^{diss}$, Corollary 3.1 presents sufficient conditions for the uncertain system $\Omega \star M$ to be $\{X, Y, Z\}$ dissipative. Testing these conditions is a finite dimensional convex optimization problem under LMI constraints with α_{ij} as decision variables. It can be solved efficiently [2]. The consequence of introducing this parametrization $\Phi(\mathcal{B}_{\Omega}^{diss})$ is a possible conservatism. However, it can be reduced by an appropriate choice of $\mathcal{B}_{\Omega_j}^{diss}$, depending on the class of the uncertainty sets Ω_j . The conservatism depends as well on how precise each element of $\mathcal{B}_{\Omega_j}^{diss}$ characterizes Ω_j . Furthermore, the larger $\mathcal{B}_{\Omega_j}^{diss}$ sets are, the less conservative results can be obtained.*

In the case where the uncertainty set Ω is an elementary uncertainty set *i.e.* $\Omega = \Delta$, the associated basis can be easily obtained from [3] and [4] and it will be denoted by $\mathcal{B}_{\Delta}^{diss}$. In this case $\mathcal{B}_{\Delta}^{diss}$ can be defined as the well-known D or DG scaling sets according to (9).

3.3 Application to the uncertain LSS

A solution to Problem 2.1 can be obtained by applying Corollary 3.1 if the LSS is expressed as (5). After gathering all the different Δ_j^i in $\tilde{\Delta}$, defining the global uncertainty set $\tilde{\Delta}$, while the different M_j^i and the interconnections are gathered in \tilde{M} using LFT algebra, the global system T_1^1 will be given by

$$T_1^1 = \tilde{\Delta} \star \tilde{M} \quad (11)$$

with

$$\tilde{\Delta} = \mathbf{bdiag}_i \left(\mathbf{bdiag}_j (\Delta_j^i) \right), \quad \Delta_j^i \in \Delta, \quad (12)$$

Please note that $\tilde{M} \in \mathbf{RH}_{\infty}$. It is a direct consequence of the fact that the LSS is designed to be stable (in the nominal case).

The interest of transforming the LSS T_1^1 as in (11) and (12) is that the uncertainty $\tilde{\Delta}$ is the block diagonal composition of elementary uncertainties $\Delta_j^i \in \Delta$. As a consequence, and as mentioned before, the associated basis $\mathcal{B}_{\tilde{\Delta}}^{diss}$ is easily defined as in [3] and [4] and the set $\Phi(\mathcal{B}_{\tilde{\Delta}}^{diss})$ is straightforward. Furthermore, $\tilde{\Delta}_0 = 0$ ensures the stability of (11) since $\tilde{M} \in \mathbf{RH}_{\infty}$.

We can try to solve Problem 2.1 using a direct application of Corollary 3.1 where the basis $\mathcal{B}_{\tilde{\Delta}}^{diss}$ is chosen from [3] and [4]. This approach will be referred to as *direct LSS RPA* method and it is summarized in the following corollary.

Corollary 3.2 (Direct LSS RPA) *Let T_1^1 be the LSS defined by (11) and (12). Given a frequency ω_0 , Problem 2.1 can be solved with the following optimization problem*

$$\begin{aligned}
& \min && \gamma_{\omega_0} \\
& \gamma_{\omega_0} \\
& \tilde{\Phi} \in \Phi \left(\mathcal{B}_{\tilde{\Delta}}^{diss} \right) \\
& s.t. \\
& \mathcal{L}_{\mathcal{P}} \left(\tilde{M}, \tilde{\Phi}_{11}, \tilde{\Phi}_{12}, \tilde{\Phi}_{22}, -I, 0, \gamma_{\omega_0}^2 I, \epsilon \right) \geq 0
\end{aligned} \tag{13}$$

Proof 3.3 *Corollary 3.2 is a direct application of Corollary 3.1 with Lemma 3.1 and the minimization of γ_{ω_0} to obtain the lowest upper bound on $\tilde{\sigma}(T_1^1(\mathbf{j}\omega_0))$.*

As it will be shown later with numerical examples, the *direct LSS RPA* method cannot be practically applied when the size of the LSS becomes too important. This is due to the important number of decision variables in the LMI (13) which leads to a dramatic increase of the computation load and time. Please note that Corollary 3.2 can also be used to investigate only the stability of a network by replacing condition (13) with

$$\mathcal{L}_{\mathcal{S}} \left(\tilde{M}_{11}, \tilde{\Phi}_{11}, \tilde{\Phi}_{12}, \tilde{\Phi}_{22} \right) \geq 0$$

In the next section, we propose a method that allows to take advantage of the hierarchical structure to practically investigate the robust performance of uncertain LSS within a reasonable computation time.

4 Hierarchical Approach

In the previous section, we have shown that the performance can be characterized using dissipativity properties (IQC). Nevertheless, Corollary 3.1 reveals that to ensure robust performance, defined by

the $\{X, Y, Z\}$ dissipativity property, it is sufficient (and sometimes necessary) to exhibit a dissipativity property, defined by $\Phi^\Omega \in \Phi(\mathcal{B}_\Omega^{diss})$, satisfied by all $\Omega \in \Omega$ *i.e.* Ω is $\{\Phi_{11}^\Omega, \Phi_{12}^\Omega, \Phi_{22}^\Omega\}$ dissipative such that

$$\mathcal{L}_{\mathcal{P}}(M, \Phi_{11}^\Omega, \Phi_{12}^\Omega, \Phi_{22}^\Omega, X, Y, Z, \epsilon) \geq 0$$

holds true. Therefore, the dissipativity properties (IQC) are suitable to characterize both uncertainty and performance.

Corollary 3.1 allows to characterize the performance with $\{X, Y, Z\}$ dissipativity property (IQC) knowing that all the uncertainties Ω are $\{\Phi_{11}^\Omega, \Phi_{12}^\Omega, \Phi_{22}^\Omega\}$ dissipative where Φ^Ω is constructed from the basis of the uncertainty Ω_j as in (8). and (9). Thereafter, if we have a method, which will use necessarily Corollary 3.1, that allows to find a basis \mathcal{B}_T^{diss} for the system $T = \Omega \star M$ from the basis $\mathcal{B}_\Omega^{diss}$ of the uncertainty, then Problem 2.1 can be solved efficiently in a hierarchical manner. This method will be known as basis propagation and it consists in propagating the basis from one hierarchical level to another starting from level l where the uncertainty basis is known since $\Omega_j^i = \Delta_j^i$. This basis propagation method will be performed from basis of level i to basis of level $i - 1$ until reaching level 1 where the objective is to minimize γ_{ω_0} .

The proposed Hierarchical Robust Performance Analysis (HRPA) approach is summarized in the following algorithm

Algorithm 1 Hierarchical Robust Performance Analysis

% First Step: level 1-1

for $j \leftarrow 1$ **to** N_T^{l-1} **do**

Find a basis $\mathcal{B}_{T_j^{l-1}}^{diss}$ for each uncertain system T_j^{l-1} from the given basis $\mathcal{B}_{\Delta_j^l}^{diss}$ of elementary uncertainties Δ_j^l .

end

% Intermediate Steps: level 1-2 to level 2 for $i \leftarrow l - 2$ **to** 2 **do**

for $j \leftarrow 1$ **to** N_T^i **do**

Find a basis $\mathcal{B}_{T_j^i}^{diss}$ for each uncertain system T_j^i using the given basis $\mathcal{B}_{\Delta_m^{i+1}}^{diss}$ of the elementary uncertainties Δ_m^{i+1} and the basis $\mathcal{B}_{T_n^{i+1}}^{diss}$ of the uncertain systems T_n^{i+1} obtained at level $i + 1$.

end

end

% Last Step: level 1

Find the smallest γ_{ω_0} such that T_1^1 is $\{-I, 0, \gamma_{\omega_0}^2 I\}$ dissipative by applying Corollary 3.1 using the given basis $\mathcal{B}_{\Delta_m^2}^{diss}$ of the elementary uncertainties Δ_m^2 and the basis $\mathcal{B}_{T_n^2}^{diss}$ of the uncertain systems T_n^2 obtained at level 2.

Remark 4.1 *Algorithm 1 allows to investigate if the uncertain LSS is stable and $\{X, Y, Z\}$ dissipative. Nevertheless, if there are no performance signals for the LSS (w_1^1 and z_1^1) and the objective is just to certify the robust stability of the LSS, Algorithm 1 still can be applied. In this case, condition (10) of Corollary 3.1 in the last step of Algorithm 1 is replaced with the following LMI: $\mathcal{L}_S((M_{11})_1^1, \Phi_{11}^\Omega, \Phi_{12}^\Omega, \Phi_{22}^\Omega) \geq 0$. This will define the Hierarchical Robust Stability Analysis Algorithm (HRSAA). Therefore, Algorithm 1 can be used for both certification: stability and performance.*

Remark 4.2 *Algorithm 1 allows to investigate the performance and the stability of uncertain LSS in an efficient manner. The global LMI given in Corollary 3.2 will be replaced with several hierarchical LMI of Corollary 3.1 linked with appropriate condition in the next hierarchical levels. Furthermore, given a hierarchical level i , the different uncertain systems T_\bullet^i do not interfere with each other since their interconnections appear in level $i - 1$ and levels below. Therefore, the analysis performed at each level i (the performance analysis of the different T_\bullet^i) can be performed separately and in parallel. The*

consequence of this parallel analysis will be a very important decrease of the computation time as it will be shown in Section 7.

Remark 4.3 *In the case of parametric uncertainties and when the size of the uncertain LSS is not too important such that Corollary 3.2 can be practically applied, the basis $\mathcal{B}_{\Delta}^{diss}$ can be chosen in the form of the well-known DG scaling from [3]. In order to reduce the conservatism resulting from choosing this parametrization, the basis $\mathcal{B}_{\Delta}^{diss}$ can be chosen in the form of DGL scaling from [23] instead of DG scaling. In this case and since the basis is larger, the number of decision variables is more important and Corollary 3.2 may not be practically applied even if the size of the LSS is not too important. Nevertheless, Algorithm 1 allows to overcome this issue. Since the analysis in each level is performed on small size systems T_j^i , it is possible to choose the basis $\mathcal{B}_{\Delta_m^{i+1}}^{diss}$ in the form of DGL scaling. The consequence will be a less conservatism results in the overall analysis compared to those when using the hierarchical approach with DG scaling.*

In the next section, we present three types of elements for the basis $\mathcal{B}_{T^i}^{diss}$ and we formulate the problems of computing each one of them as a convex optimization problem allowing to minimize its size measure.

5 Practical Formulation and Computation of The Basis Elements

In the previous section, we revealed how it is possible to solve Problem 2.1 with Algorithm 1 using basis propagation from level i to level $i - 1$ with the assumption that we are able to find the basis elements of each uncertain system given the basis of its uncertainty. However, the conservatism of the overall result depends highly on the choice of the propagated basis. For this reason, it is important to define and compute the "best" basis for a given uncertain system. In the sequel, we consider an uncertain system T such that $z = Tw$ as in (5) with a given uncertainty basis $\mathcal{B}_{\Omega}^{diss}$.

Corollary 3.1 gives sufficient conditions to obtain $\{X, Y, Z\}$ dissipativity property for the uncertain system T by solving the following feasibility optimization problem

$$\mathcal{L}_{\mathcal{P}} (M, \Phi_{11}^{\Omega}, \Phi_{12}^{\Omega}, \Phi_{22}^{\Omega}, X^k, Y^k, Z^k, \epsilon) \geq 0$$

with $\Phi^\Omega \in \Phi(\mathcal{B}_\Omega^{diss})$ is of the form (9) with *a priori* known $\mathcal{B}_{\Omega_j}^{diss}$. This feasibility optimization problem is convex and can be solved efficiently. The obtained $\{X, Y, Z\}$ dissipativity property will define an element of the basis \mathcal{B}_T^{diss} . However, in order to ensure that this characterization is the best, it is important to define a size measure for each element *i.e.* characterize T with the optimal $\{X, Y, Z\}$ in the sense that this size is minimized. In addition, one can characterize the uncertain system T not with just one dissipativity property but with N different dissipativity properties which will be used to construct the basis \mathcal{B}_T^{diss}

$$\begin{pmatrix} X^k & Y^k \\ (Y^k)^* & Z^k \end{pmatrix} \in \mathcal{B}_T^{diss}, \forall k = 1, \dots, N^d$$

In order to construct the largest basis \mathcal{B}_T^{diss} , all its elements should be conically independent and capture information, of different nature, characterizing the uncertain system T such as gain or phase information.

In this section, for every frequency ω_0 and in order to have a geometric interpretation of each element of \mathcal{B}_T^{diss} , we characterize the uncertain system T in the signals space using the system input and output signals w and z . Within this context, a system T is said to be $\{X, Y, Z\}$ dissipative if

$$\begin{pmatrix} z \\ w \end{pmatrix}^* \begin{pmatrix} X & Y \\ Y^* & Z \end{pmatrix} \begin{pmatrix} z \\ w \end{pmatrix} > 0 \quad (14)$$

Therefore, the search of each element of \mathcal{B}_T^{diss} consists in the following: find $\{X, Y, Z\}$ dissipativity property such that (14) is ensured for all non null input signals w with its resulting output $z = \Omega \star Mw$ for all $\Omega \in \Omega$.

5.1 Ellipsoid

If $X < 0$, constraint (14) rewrites in the signals space as

$$(z - z_c)^*(-X)(z - z_c) < w^*(Z - Y^*X^{-1}Y)w$$

with $z_c = -X^{-1}Yw$ and $(Z - Y^*X^{-1}Y)$ is hermitian positive definite matrix since $X < 0$ and constraint (14) holds. Then, for all non null input signal w , the corresponding output signal z belongs to the ellipsoid \mathcal{E}_w (n_z dimensional space) centered at z_c and characterized with \mathcal{P}_w such that

$$\mathcal{E}_{\mathcal{P}_w} = \{z \in \mathbb{C}^{n_z} \mid (z - z_c)^*\mathcal{P}_w(z - z_c) < 1\} \quad (15)$$

where the matrix \mathcal{P}_w determines how far the ellipsoid extends in every direction and it is given by

$$\mathcal{P}_w = \frac{-X}{w^* (Z - Y^* X^{-1} Y) w}$$

We are now interested in finding X , Y and Z corresponding to the smallest ellipsoid $\mathcal{E}_{\mathcal{P}_w}$ for all inputs such that¹ $\|w\| = 1$ and the uncertain system $\Omega \star M$ is $\{X, Y, Z\}$ dissipative. For this purpose, a size measure \boldsymbol{v} for the ellipsoid $\mathcal{E}_{\mathcal{P}_w}$ can be defined as its volume $\boldsymbol{v} = \mathbf{vol}(\mathcal{E}_{\mathcal{P}_w})$, which is given by

$$\boldsymbol{v} = \beta \sqrt{\det(\mathcal{P}_w^{-1})}$$

where β is a positive scalar which depends on n_z .

Problem 5.1 *Let $\Omega \star M$ be an uncertain system. Find X , Y and Z which*

$$\begin{array}{llll} \text{minimize} & \text{maximize} & \text{maximize} & \boldsymbol{v}^2 \\ \text{over } \begin{array}{l} X, Y, Z \\ X < 0 \end{array} & \text{over } \Omega \in \Omega & \text{over } w & \\ & & \text{s.t.} & \begin{cases} \|w\| = 1 \\ (\Omega \star M) w \in \mathcal{E}_{\mathcal{P}_w} \end{cases} \end{array}$$

Theorem 5.1 *An upper bound $\tilde{\boldsymbol{v}}$ on $\boldsymbol{v}_{\text{opt}}$ optimal value of Problem 5.1 can be obtained by finding X , Y , Z , Φ_{11}^Ω , Φ_{12}^Ω and Φ_{22}^Ω with*

$$\Phi^\Omega = \begin{pmatrix} \Phi_{11}^\Omega & \Phi_{12}^\Omega \\ (\Phi_{12}^\Omega)^* & \Phi_{22}^\Omega \end{pmatrix} \in \Phi(\mathcal{B}_\Omega^{\text{diss}})$$

that minimize

$$\log(\det(-X^{-1}))$$

such that

1. $\mathcal{L}_{\mathcal{P}}(M, \Phi_{11}^\Omega, \Phi_{12}^\Omega, \Phi_{22}^\Omega, X, Y, Z, \epsilon) \geq 0$ holds;
2. $\begin{pmatrix} I & 0 \\ 0 & 0 \end{pmatrix} \geq \begin{pmatrix} Z & Y^* \\ Y & X \end{pmatrix}$ holds.

The upper bound $\tilde{\boldsymbol{v}}$ is given by $\tilde{\boldsymbol{v}} = \beta \sqrt{\det(-\tilde{X}^{-1})}$ where $\tilde{X} = \text{argmin} \log(\det(-X^{-1}))$ such that conditions 1 and 2 of Theorem 5.1 hold. The optimal ellipsoid $\mathcal{E}_{\mathcal{P}_{\text{opt}_w}}$ corresponding to $\boldsymbol{v}_{\text{opt}}$ will be included in $\mathcal{E}_{\tilde{\mathcal{P}}_w}$ the ellipsoid corresponding to $\tilde{\boldsymbol{v}}$

$$\mathcal{E}_{\mathcal{P}_{\text{opt}_w}} \subseteq \mathcal{E}_{\tilde{\mathcal{P}}_w}.$$

¹The normalization of the input signal w is absorbed in \mathcal{P}_w .

This optimization problem is a determinant maximization under linear matrix inequality constraints [24] and is convex.

Proof 5.1 *Problem 5.1 rewrites*

$$\begin{array}{lll} \text{minimize} & \text{maximize} & \text{maximize} & \mathbf{v}^2 \\ \text{over } \begin{array}{l} X, Y, Z \\ X < 0 \end{array} & \text{over } \Omega \in \Omega & \text{over } \|w\| = 1 & \\ \text{subject to} & \Omega \star M \text{ is } \{X, Y, Z\} \text{ dissipative} & & \end{array}$$

Let us introduce the logarithm function on \mathbf{v}^2 , which is strictly increasing according to its argument

$$\log(\mathbf{v}^2) = 2 \log(\beta) + \log(\det(-X^{-1})) + \log(w^*(Z - Y^*X^{-1}Y)w)$$

Maximizing $\log(\mathbf{v}^2)$ over the inputs $\|w\| = 1$ and with $\bar{\sigma}$ as the maximal singular value of $(Z - Y^*X^{-1}Y)$, it is possible to write

$$\max_{\|w\|=1} \log(\mathbf{v}^2) = 2 \log(\beta) + \log(\det(-X^{-1})) + \log(\bar{\sigma})$$

Since $(Z - Y^*X^{-1}Y)$ is hermitian definite positive, then its maximal singular value is equal to its largest eigenvalue λ_{\max} . We thus have

$$\lambda_{\max} I \geq (Z - Y^*X^{-1}Y)$$

Furthermore, as a dissipativity property is defined up to a strictly positive multiplicative coefficient and as $\{X, Y, Z\}$ dissipativity defines the same ellipsoid as $\{\tau X, \tau Y, \tau Z\}$ dissipativity for any $\tau > 0$. Then, one can search for X, Y and Z such that $\lambda_{\max} = 1$ without loss of generality. Since β is a constant, the optimization problem is equivalent to

$$\begin{array}{lll} \text{minimize} & \text{maximize} & \log(\det(-X^{-1})) \\ \text{over } \begin{array}{l} X, Y, Z \\ X < 0 \end{array} & \text{over } \Omega \in \Omega & \\ \text{subject to} & \Omega \star M \text{ is } \{X, Y, Z\} \text{ dissipative} & \\ & I \geq (Z - Y^*X^{-1}Y) & \end{array}$$

The last optimization problem is solved by applying Corollary 3.1 which gives condition 1 of Theorem 5.1 while condition 2 is obtained by applying Schur's lemma [25] on $I \geq (Z - Y^*X^{-1}Y)$. Please note that since Corollary 3.1 presents sufficient conditions, we are only able to compute an upper bound $\tilde{\mathbf{v}}$ on the optimal volume \mathbf{v}_{opt} .

Remark 5.1 *The interest of finding a bounded and connected set as ellipsoid, for which belongs the output z , is to characterize the gain of the uncertain system T . At each frequency ω_0 , the frequency response of the uncertain system is embedded in this ellipsoid i.e. it is possible to compute boundaries for the system gain at this frequency ω_0 . Furthermore, if $X = -I$, $Y = 0$ and $Z = \gamma_{\omega_0}^2 I$, the ellipsoid $\{X, Y, Z\}$ dissipativity property corresponds to the upper bound on the system maximum singular value i.e. $\bar{\sigma}(T(j\omega_0)) < \gamma_{\omega_0}$.*

5.2 Band

In the signals space and in case we enforce $X = 0$, constraint (14) rewrites as $\xi^* z - \eta > 0$ with $\xi = 2Yw$ and $\eta = -w^* Z w$. This last inequality expresses that for a given non null input signal w , the output signal z belongs to a half plane which is characterized by the hyperplane: $\{z \mid \xi^* z = \eta\}$ where ξ is a vector normal to the hyperplane and η is twice the 'signed distance' of the hyperplane to the origin (the dot product of any point of the hyperplane with ξ). In addition to a half plane, it is possible to define a band $\mathcal{B}_{(\eta_1, \eta_2)_w}$ as the intersection of two parallel half planes with the same normal direction ξ but opposite sign, i.e. two parallel half planes defined by two dissipativity properties $\{0, Y, Z_1\}$ and $\{0, -Y, Z_2\}$, that is

$$\mathcal{B}_{(\eta_1, \eta_2)_w} = \left\{ z \in \mathbb{C}^{n_z} \mid \begin{array}{l} \xi^* z - \eta_1 > 0 \\ -\xi^* z - \eta_2 > 0 \end{array} \right\}$$

with $\xi = 2Yw$, $\eta_1 = -w^* Z_1 w$ and $\eta_2 = -w^* Z_2 w$.

Our objective now is to find the band $\mathcal{B}_{(\eta_1, \eta_2)_w}$ with the smallest size measure for a fixed direction defined by Y , for all inputs such that $\|w\| = 1$ and provided that the uncertain system $\Omega \star M$ is $\{0, Y, Z_1\}$ and $\{0, -Y, Z_2\}$ dissipative. We can define a size measure \mathcal{d} as the width of the band, that is

$$\mathcal{d} = |\eta_1 + \eta_2|$$

Problem 5.2 *Let $\Omega \star M$ be an uncertain system. For a given Y , find Z_1 and Z_2 which*

$$\begin{array}{llll} \text{minimize} & \text{maximize} & \text{maximize} & \mathcal{d} \\ \text{over } Z_1, Z_2 & \text{over } \Omega \in \Omega & \text{over } w & \end{array} \quad \text{s.t.} \quad \begin{cases} \|w\| = 1 \\ (\Omega \star M) w \in \mathcal{B}_{(\eta_1, \eta_2)_w} \end{cases}$$

Theorem 5.2 An upper bound $\tilde{\mathcal{d}}$ on \mathcal{d}_{opt} the optimal value of Problem 5.2 can be obtained by finding $Z_1, Z_2, (\Phi_{11}^\Omega)^i, (\Phi_{12}^\Omega)^i$ and $(\Phi_{22}^\Omega)^i$ with

$$(\Phi^\Omega)^i = \begin{pmatrix} (\Phi_{11}^\Omega)^i & (\Phi_{12}^\Omega)^i \\ (\Phi_{12}^\Omega)^{i*} & (\Phi_{22}^\Omega)^i \end{pmatrix} \in \Phi(\mathcal{B}_\Omega^{diss})$$

with $i = \{1, 2\}$ that minimize

$$\mathcal{d}$$

such that

1. $\mathcal{L}_P \left(M, (\Phi_{11}^\Omega)^1, (\Phi_{12}^\Omega)^1, (\Phi_{22}^\Omega)^1, 0, Y, Z_1, \epsilon \right) \geq 0$ holds;
2. $\mathcal{L}_P \left(M, (\Phi_{11}^\Omega)^2, (\Phi_{12}^\Omega)^2, (\Phi_{22}^\Omega)^2, 0, -Y, Z_2, \epsilon \right) \geq 0$ holds;
3. $Z_1 + Z_2 \leq \mathcal{d}I$ holds.

The upper bound $\tilde{\mathcal{d}}$ is given by $\tilde{\mathcal{d}} = |\tilde{\eta}_1 + \tilde{\eta}_2| = \operatorname{argmin} \mathcal{d}$ such that conditions 1 and 2 of Theorem 5.2 hold. $\tilde{\eta}_1$ and $\tilde{\eta}_2$ correspond to the obtained solutions Z_1 and Z_2 .

The optimal band $\mathcal{B}_{(\eta_{1opt}, \eta_{2opt})_w}$ will be included in the band $\mathcal{B}_{(\tilde{\eta}_1, \tilde{\eta}_2)_w}$ corresponding to $\tilde{\mathcal{d}}$, that is

$$\mathcal{B}_{(\eta_{1opt}, \eta_{2opt})_w} \subseteq \mathcal{B}_{(\tilde{\eta}_1, \tilde{\eta}_2)_w}.$$

This optimization problem is the minimization of a linear cost under LMI constraints [25] and is convex. It is then also possible to search for the band direction by letting Y to be free.

Proof 5.2 Problem 5.2 rewrites

$$\begin{array}{lll} \text{minimize} & \text{maximize} & \text{maximize} \quad |\eta_1 + \eta_2| \\ \text{over } Z_1, Z_2 & \text{over } \Omega \in \Omega & \text{over } \|w\| = 1 \\ \text{subject to} & \Omega \star M \text{ is } \{0, Y, Z_1\} \text{ dissipative} & \\ & \Omega \star M \text{ is } \{0, -Y, Z_2\} \text{ dissipative} & \end{array}$$

with $\eta_1 = -w^* Z_1 w$ and $\eta_2 = -w^* Z_2 w$. Noting that, $|\eta_1 + \eta_2| = -\eta_1 - \eta_2 > 0$ since the set $\Omega \star M$ is not empty, the previous optimization problem is equivalent to:

$$\begin{array}{lll} \text{minimize} & \text{maximize} & \text{maximize} \quad -\eta_1 - \eta_2 \\ \text{over } Z_1, Z_2 & \text{over } \Omega \in \Omega & \text{over } \|w\| = 1 \\ \text{subject to} & \Omega \star M \text{ is } \{0, Y, Z_1\} \text{ dissipative} & \\ & \Omega \star M \text{ is } \{0, -Y, Z_2\} \text{ dissipative} & \end{array}$$

Therefore, $\max_{\|w\|=1}(-\eta_1 - \eta_2)$ is equivalent to minimize \mathcal{d} constrained by

$$\mathcal{d}I \geq Z_1 + Z_2.$$

The optimization is thus equivalent to

$$\begin{array}{lll} \text{minimize} & \text{maximize} & \text{minimize } \mathcal{d} \\ \text{over } Z_1, Z_2 & \text{over } \Omega \in \mathbf{\Omega} & \text{over } \mathcal{d} \\ \text{subject to} & \begin{array}{l} \Omega \star M \text{ is } \{0, Y, Z_1\} \text{ dissipative} \\ \Omega \star M \text{ is } \{0, -Y, Z_2\} \text{ dissipative} \\ \mathcal{d}I \geq (Z_1 + Z_2) \end{array} & \end{array}$$

Finally, condition 1 and condition 2 of Theorem 5.2 are obtained by applying Corollary 3.1. Again, since Corollary 3.1 presents sufficient conditions, we are only able to compute an upper bound $\tilde{\mathcal{d}}$ on the optimal width \mathcal{d}_{opt} .

5.3 Cone Sector

The phase uncertainty presents an other important characterization of uncertain system behavior. In contrast with the system gain, and beside for single input single output systems, there is no unique definition of multiple input multiple output systems phase. Furthermore, taking into account uncertainties in the system makes the phase characterization more complicated. It is possible to compare the direction variation between the input and the output signals to measure the phase of a system by measuring input direction variation added by the system. Furthermore, within this context, the phase uncertainty is characterized using the notion of numerical range as shown in [20] and [26]. The numerical range of a complex matrix Γ is defined to be a compact and convex set of \mathbb{C} and it is given by [27]

$$\mathcal{N}(\Gamma) = \{w^*z \mid z = \Gamma w, w \in \mathbb{C}^{n_w} \text{ and } \|w\| = 1\} \quad (16)$$

In order to define the phase of an uncertain system $\Omega \star M$, the numerical range is extended to the union of numerical ranges $\mathcal{N}(\Omega \star M)$ for any $\Omega \in \mathbf{\Omega}$. Let us define in the complex plane the cone sector centered at the origin and containing all these numerical ranges. It is defined by a spread angle α such that $0 < \alpha < \pi$ and the angle β measured between the bisectrix of α and the real axis direction. Please refer to [20] for more details. The angle β can be set to zero by introducing a scaling matrix $\Psi \in \mathbb{C}^{n_z \times n_w}$. More generally, the cone sector can be centered at any point $z_c = Cw$

with $C \in \mathbb{C}^{n_z \times n_w}$ and the objectives is to compute Ψ and α such that union of the numerical ranges $\mathcal{N}(\Psi^*(\Omega \star M))$ is included in the set of z^*w where $\|w\| = 1$ and $z \in \mathcal{C}_{(z_c, \alpha)_w}$ with

$$\mathcal{C}_{(z_c, \alpha)_w} = \left\{ z \in \mathbb{C}^{n_z} \left| \begin{array}{l} \begin{pmatrix} z \\ w \end{pmatrix}^* \begin{pmatrix} 0 & Y_1 \\ Y_1^* & Z_1 \end{pmatrix} \begin{pmatrix} z \\ w \end{pmatrix} > 0 \\ \begin{pmatrix} z \\ w \end{pmatrix}^* \begin{pmatrix} 0 & Y_2 \\ Y_2^* & Z_2 \end{pmatrix} \begin{pmatrix} z \\ w \end{pmatrix} > 0 \end{array} \right. \right\} \quad (17)$$

where

$$\begin{aligned} Y_1 &= \Psi \left(I + j \cot \left(\frac{\alpha}{2} \right) I \right) & Z_1 &= -(Y_1^* C + C^* Y_1) \\ Y_2 &= \Psi \left(I - j \cot \left(\frac{\alpha}{2} \right) I \right) & Z_2 &= -(Y_2^* C + C^* Y_2) \end{aligned}$$

with $0 < \frac{\alpha}{2} < \frac{\pi}{2}$. We are now interested in finding Y_i and Z_i corresponding to the smallest $\mathcal{C}_{(z_c, \alpha)_w}$ for all inputs such that $\|w\| = 1$. This inclusion ensures that the uncertain system $\Omega \star M$ is $\{0, Y_1, Z_1\}$ and $\{0, Y_2, Z_2\}$ dissipative. This problem can be solved by finding Ψ such that the union of the numerical ranges $\mathcal{N}(\Psi^*(\Omega \star M - C))$ is in the right half plane and then search for α . Furthermore, to obtain the smallest cone, a size measure \mathbf{a} for $\mathcal{C}_{(z_c, \alpha)_w}$ is needed. It can be defined as the tangent of the angle α

$$\mathbf{a} = \tan \left(\frac{\alpha}{2} \right)$$

Problem 5.3 *Let $\Omega \star M$ be an uncertain system and given a complex matrix C . Find Ψ and α such that the union of the numerical ranges $\mathcal{N}(\Psi^*(\Omega \star M - C))$ is in the right half plane and which*

$$\begin{array}{llll} \text{minimize} & \text{maximize} & \text{maximize} & \mathbf{a} \\ \text{over } \Psi, \mathbf{a} & \text{over } \Omega \in \Omega & \text{over } w & \end{array} \quad \text{s.t.} \begin{cases} \|w\| = 1 \\ (\Omega \star M) w \in \mathcal{C}_{(z_c, \alpha)_w} \end{cases}$$

Theorem 5.3 *The union of numerical ranges $\mathcal{N}(\Psi^*(\Omega \star M - C))$ of Problem 5.3 is located in the right half plane if $\exists \Psi$ and $\widehat{\Phi} \in \Phi(\mathcal{B}_\Omega^{diss})$ such that*

$$\begin{pmatrix} M \\ I \end{pmatrix}^* B \begin{pmatrix} M \\ I \end{pmatrix} \geq 0 \quad (18)$$

where

$$B = \begin{pmatrix} -\widehat{\Phi}_{22}^\Omega & 0 & -(\widehat{\Phi}_{12}^\Omega)^* & 0 \\ 0 & -\epsilon I & 0 & \Psi \\ -\widehat{\Phi}_{12}^\Omega & 0 & -\widehat{\Phi}_{11}^\Omega & 0 \\ 0 & \Psi^* & 0 & -(\Psi^* C + C^* \Psi) - \epsilon I \end{pmatrix}$$

Furthermore, an upper bound $\tilde{\mathbf{a}}$ on \mathbf{a}_{opt} , optimal value of Problem 5.3, can be obtained by finding \mathbf{a} , $\hat{\Phi}^\Omega$ and $(\tilde{\Phi}^\Omega)^i$ with

$$\hat{\Phi}^{\Omega+\mathbf{a}-1}(\tilde{\Phi}^\Omega)^1 \in \Phi(\mathcal{B}_\Omega^{diss}) \quad \hat{\Phi}^{\Omega-\mathbf{a}-1}(\tilde{\Phi}^\Omega)^2 \in \Phi(\mathcal{B}_\Omega^{diss})$$

that minimize

$$\mathbf{a}$$

such that:

1. $\mathbf{a} \begin{pmatrix} M \\ I \end{pmatrix}^* B \begin{pmatrix} M \\ I \end{pmatrix} + \begin{pmatrix} M \\ I \end{pmatrix}^* A_1 \begin{pmatrix} M \\ I \end{pmatrix} \geq 0;$
2. $\mathbf{a} \begin{pmatrix} M \\ I \end{pmatrix}^* B \begin{pmatrix} M \\ I \end{pmatrix} + \begin{pmatrix} M \\ I \end{pmatrix}^* A_2 \begin{pmatrix} M \\ I \end{pmatrix} \geq 0;$
3. condition (18) holds.

where

$$A_i = (-1)^{i-1} \begin{pmatrix} -(\tilde{\Phi}_{22}^\Omega)^i & 0 & -(\tilde{\Phi}_{12}^\Omega)^{i*} & 0 \\ 0 & 0 & 0 & -j\Psi \\ -(\tilde{\Phi}_{12}^\Omega)^i & 0 & -(\tilde{\Phi}_{11}^\Omega)^i & 0 \\ 0 & (-j\Psi)^* & 0 & -j(\Psi^*C - C^*\Psi) \end{pmatrix}$$

The upper bound $\tilde{\mathbf{a}}$ is given by $\tilde{\mathbf{a}} = \operatorname{argmin} \mathbf{a}$ such that conditions 1, 2 and 3 of Theorem 5.3 hold. The optimal cone sector $\mathcal{C}_{(z_c, \alpha_{opt})_w}$ of Problem 5.1, with $\alpha_{opt} = 2\operatorname{atan}(\mathbf{a}_{opt})$, will be included in the cone sector $\mathcal{C}_{(z_c, \tilde{\alpha})_w}$, with $\tilde{\alpha} = 2\operatorname{atan}(\tilde{\mathbf{a}})$, that is

$$\mathcal{C}_{(z_c, \alpha_{opt})_w} \subseteq \mathcal{C}_{(z_c, \tilde{\alpha})_w}.$$

Minimizing \mathbf{a} in Theorem 5.3 such that conditions 1, 2 and 3 hold is a generalized eigenvalues problem which has been proved that it is a quasiconvex optimization problem [25] and it can be solved efficiently [28].

Proof 5.3 *The union of the numerical ranges $\mathcal{N}(\Psi^*(\Omega \star M - C))$ is in the right half plane if and only if*

$$\operatorname{Re}(\mathcal{N}(\Psi^*(\Omega \star M - C))) \geq 0.$$

By (16), which defines the numerical range, the previous condition rewrites as

$$\begin{pmatrix} z \\ w \end{pmatrix}^* \begin{pmatrix} 0 & \Psi \\ \Psi^* & -(\Psi^*C + C^*\Psi) \end{pmatrix} \begin{pmatrix} z \\ w \end{pmatrix} \geq 0 \quad (19)$$

where $z = \Omega \star M$. This constraint expresses that the uncertain system $\Omega \star M$ is $\{0, \Psi, -(\Psi^*C + C^*\Psi)\}$ dissipative for all $\Omega \in \mathbf{\Omega}$. By applying Corollary 3.1, (19) is implied by (18) with $\widehat{\Phi} \in \Phi(\mathcal{B}_{\Omega}^{diss})$. Then, the minimization of \mathbf{a} is well-posed when the union of numerical ranges $\mathcal{N}(\Psi^*(\Omega \star M - C))$ is in the right half plane, that is $0 < \frac{\alpha}{2} < \frac{\pi}{2}$. With $\mathbf{a} = \tan\left(\frac{\alpha}{2}\right)$, Y_i and Z_i introduced in (17) become

$$\begin{aligned} Y_i &= \Psi + (-1)^{i-1} j \mathbf{a}^{-1} \Psi \\ Z_i &= -(\Psi^*C + C^*\Psi) + (-1)^i j \mathbf{a}^{-1} (\Psi^*C + C^*\Psi) \end{aligned} \quad (20)$$

The problem of minimizing \mathbf{a} rewrites

$$\begin{array}{lll} \text{minimize} & \text{maximize} & \text{maximize} \quad \mathbf{a} \\ \text{over } \Psi, \mathbf{a} & \text{over } \Omega \in \mathbf{\Omega} & \text{over } \|w\| = 1 \\ \text{s.t.} & \Omega \star M \text{ is } \{0, Y_1, Z_1\} \text{ dissipative} & \\ & \Omega \star M \text{ is } \{0, Y_2, Z_2\} \text{ dissipative} & \end{array}$$

where Y_i and Z_i are given in (20). Nevertheless, since the conditions of Corollary 3.1 are only sufficient, we are able to compute only an upper bound $\widetilde{\mathbf{a}}$ on \mathbf{a}_{opt} , solution of Problem 5.3. Applying Corollary 3.1 gives

$$\begin{aligned} \mathcal{L}_{\mathcal{P}} \left(M, (\Phi_{11}^{\Omega})^1, (\Phi_{12}^{\Omega})^1, (\Phi_{22}^{\Omega})^1, 0, Y_1, Z_1, \epsilon \right) &\geq 0 \\ \mathcal{L}_{\mathcal{P}} \left(M, (\Phi_{11}^{\Omega})^2, (\Phi_{12}^{\Omega})^2, (\Phi_{22}^{\Omega})^2, 0, Y_2, Z_2, \epsilon \right) &\geq 0 \end{aligned} \quad (21)$$

with $(\Phi^{\Omega})^1 \in \Phi(\mathcal{B}_{\Omega}^{diss})$, $(\Phi^{\Omega})^2 \in \Phi(\mathcal{B}_{\Omega}^{diss})$. Y_i and Z_i are given in (20). However, since \mathbf{a}^{-1} is multiplied by Ψ the optimization problem is bilinear in \mathbf{a}^{-1} and Ψ and this class of problems is known to be NP hard. Fortunately, there is a sub-class of bilinear problems known as generalized eigenvalue problem which is quasiconvex optimization problem and can be solved efficiently [25]. For this reason, it is possible to rewrite the problem of minimizing \mathbf{a} as generalized eigenvalue problem. In order to make the terms multiplied by \mathbf{a} positive semidefinite, we can choose $(\Phi^{\Omega})^i = \widehat{\Phi}^{\Omega}$ with $i \in \{1, 2\}$.

Nevertheless, fixing this structure to $(\Phi^\Omega)^i$ will increase the conservatism. The latter can be reduced with a more appropriate choice of $(\Phi^\Omega)^i$ such as

$$(\Phi^\Omega)^1 = \widehat{\Phi}^\Omega + \mathbf{a}^{-1}(\widetilde{\Phi}^\Omega)^1 \quad (\Phi^\Omega)^2 = \widehat{\Phi}^\Omega - \mathbf{a}^{-1}(\widetilde{\Phi}^\Omega)^2$$

This choice is interesting in the sense that $\widehat{\Phi}^\Omega$ will be used to make $\mathcal{N}(\Psi^*(\Omega \star M - C))$ is in the right half plane while $(\widetilde{\Phi}^\Omega)^i$ will ensure extra degree of freedom to minimize $\widetilde{\mathbf{a}}$. Developing (21) and factorizing \mathbf{a}^{-1} give

$$\begin{aligned} \begin{pmatrix} M \\ I \end{pmatrix}^* B \begin{pmatrix} M \\ I \end{pmatrix} + \mathbf{a}^{-1} \begin{pmatrix} M \\ I \end{pmatrix}^* A_1 \begin{pmatrix} M \\ I \end{pmatrix} &\geq 0 \\ \begin{pmatrix} M \\ I \end{pmatrix}^* B \begin{pmatrix} M \\ I \end{pmatrix} + \mathbf{a}^{-1} \begin{pmatrix} M \\ I \end{pmatrix}^* A_2 \begin{pmatrix} M \\ I \end{pmatrix} &\geq 0 \end{aligned}$$

Since $0 < \frac{\alpha}{2} < \frac{\pi}{2}$, then $\mathbf{a} \geq 0$ and we obtain

$$\begin{aligned} \mathbf{a} \begin{pmatrix} M \\ I \end{pmatrix}^* B \begin{pmatrix} M \\ I \end{pmatrix} + \begin{pmatrix} M \\ I \end{pmatrix}^* A_1 \begin{pmatrix} M \\ I \end{pmatrix} &\geq 0 \\ \mathbf{a} \begin{pmatrix} M \\ I \end{pmatrix}^* B \begin{pmatrix} M \\ I \end{pmatrix} + \begin{pmatrix} M \\ I \end{pmatrix}^* A_2 \begin{pmatrix} M \\ I \end{pmatrix} &\geq 0 \end{aligned}$$

Minimizing \mathbf{a} with the latter conditions is a generalize eigenvalue problem since condition (18) holds. Please note that since Corollary 3.1 presents sufficient conditions, we are only able to compute an upper bound $\widetilde{\mathbf{a}}$ on the optimal \mathbf{a}_{opt} .

Remark 5.2 The interest of finding a cone sector is to be able to characterize the phase variation by embedding the numerical range of the uncertain system inside the cone sector. This phase uncertainty information can be very important and critical in some applications such as the active control of vibrations. Please note that for SISO system, if $C = 0$ and $\Omega = 0$, the numerical range boils down into one point and the cone sector is nothing else than the phase of the nominal SISO system, according to the origin, at a given frequency ω_0 .

In the next section we present an application example to investigate the performance of an uncertain LSS using the hierarchical approach.

6 Performance analysis of PLL network

We consider the example of performance analysis of the active clock distribution network of [29]. It is composed of $N = 16$ mutually synchronized Phase Locked Loop (PLL) delivering clock signals to the chip. In order to synchronize all the network, the PLLs exchange information through an interconnection structure. This example is suitable for illustration of the proposed hierarchical analysis approach as the performance is naturally evaluated in the frequency domain.

6.1 PLL network description

The description of the N PLLs frequency responses are given by

$$T_j(\mathbf{j}\omega_0) = \frac{k_j(\mathbf{j}\omega_0 + a_j)}{-\omega^2 + k_j\mathbf{j}\omega_0 + k_j a_j} \quad \forall j \in \{1, \dots, N\}$$

where k_j and a_j are the PLL parameters and ω_0 is the current frequency defined by gridding. Due to the manufacturing process, technological dispersions are inevitable and the PLL parameters k_j and a_j are uncertain: $k_j \in [0.76, 6.84] \times 10^4$ and $a_j \in [91.1, 273.3]$. Furthermore, all the PLLs are homogeneous *i.e.* have the same description and uncertainty set Δ . Therefore, and after normalization, it is possible to present the PLLs as the interconnection of certain and uncertain part

$$T_j(\mathbf{j}\omega_0) = \Delta_j \star M_{PLL} \quad \Delta_j \in \Delta \quad j = 1, \dots, N$$

where Δ is given by

$$\Delta = \left\{ \Delta = \begin{pmatrix} \delta_k & 0 \\ 0 & \delta_a \end{pmatrix} \mid \delta_k \in \mathbf{R}, \delta_a \in \mathbf{R} \quad \|\Delta\|_\infty \leq 1 \right\}$$

The information exchange between PLLs is modeled by an interconnection matrix M_{int} defined as

$$M_{int} = \left(\begin{array}{cccccccccccccccc|c} 0 & \frac{1}{3} & 0 & 0 & \frac{1}{3} & 0 & 0 & 0 & 0 & 0 & 0 & 0 & 0 & 0 & 0 & 0 & \frac{1}{3} \\ \frac{1}{3} & 0 & \frac{1}{3} & 0 & 0 & \frac{1}{3} & 0 & 0 & 0 & 0 & 0 & 0 & 0 & 0 & 0 & 0 & 0 \\ 0 & \frac{1}{3} & 0 & \frac{1}{3} & 0 & 0 & \frac{1}{3} & 0 & 0 & 0 & 0 & 0 & 0 & 0 & 0 & 0 & 0 \\ 0 & 0 & \frac{1}{2} & 0 & 0 & 0 & 0 & \frac{1}{2} & 0 & 0 & 0 & 0 & 0 & 0 & 0 & 0 & 0 \\ \frac{1}{3} & 0 & 0 & 0 & 0 & \frac{1}{3} & 0 & 0 & \frac{1}{3} & 0 & 0 & 0 & 0 & 0 & 0 & 0 & 0 \\ 0 & \frac{1}{4} & 0 & 0 & \frac{1}{4} & 0 & \frac{1}{4} & 0 & 0 & \frac{1}{4} & 0 & 0 & 0 & 0 & 0 & 0 & 0 \\ 0 & 0 & \frac{1}{4} & 0 & 0 & \frac{1}{4} & 0 & \frac{1}{4} & 0 & 0 & \frac{1}{4} & 0 & 0 & 0 & 0 & 0 & 0 \\ 0 & 0 & 0 & \frac{1}{3} & 0 & 0 & \frac{1}{3} & 0 & 0 & 0 & 0 & \frac{1}{3} & 0 & 0 & 0 & 0 & 0 \\ 0 & 0 & 0 & 0 & \frac{1}{3} & 0 & 0 & 0 & 0 & \frac{1}{3} & 0 & 0 & \frac{1}{3} & 0 & 0 & 0 & 0 \\ 0 & 0 & 0 & 0 & 0 & \frac{1}{4} & 0 & 0 & \frac{1}{4} & 0 & \frac{1}{4} & 0 & 0 & \frac{1}{4} & 0 & 0 & 0 \\ 0 & 0 & 0 & 0 & 0 & 0 & \frac{1}{4} & 0 & 0 & \frac{1}{4} & 0 & \frac{1}{4} & 0 & 0 & \frac{1}{4} & 0 & 0 \\ 0 & 0 & 0 & 0 & 0 & 0 & 0 & \frac{1}{3} & 0 & 0 & \frac{1}{3} & 0 & 0 & 0 & 0 & \frac{1}{3} & 0 \\ 0 & 0 & 0 & 0 & 0 & 0 & 0 & 0 & \frac{1}{2} & 0 & 0 & 0 & 0 & \frac{1}{2} & 0 & 0 & 0 \\ 0 & 0 & 0 & 0 & 0 & 0 & 0 & 0 & 0 & \frac{1}{3} & 0 & 0 & \frac{1}{3} & 0 & \frac{1}{3} & 0 & 0 \\ 0 & 0 & 0 & 0 & 0 & 0 & 0 & 0 & 0 & 0 & \frac{1}{3} & 0 & 0 & \frac{1}{3} & 0 & \frac{1}{3} & 0 \\ 0 & 0 & 0 & 0 & 0 & 0 & 0 & 0 & 0 & 0 & 0 & \frac{1}{2} & 0 & 0 & \frac{1}{2} & 0 & 0 \\ \hline 0 & 0 & 0 & 0 & 0 & 0 & 0 & 0 & 0 & 0 & 0 & 0 & 0 & 0 & 0 & -1 & 1 \end{array} \right)$$

The network performance is characterized by its global input and output signals w_g and z_g using the global frequency response magnitude bound (more details in [18] and [19]). Therefore, the PLL network has a three level hierarchical structure and it is a sub-class of the LSS of (3) and (4), see Fig.3.

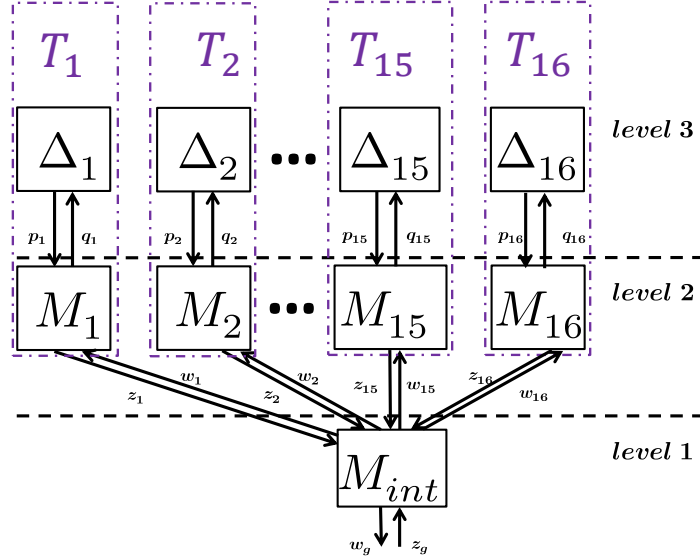

Figure 3: PLL network modeled as three level hierarchical structure

The different characteristics of this hierarchical structure are summarized in TABLE 1.

l	3
N_T^i	$N_T^1 = 1, N_T^2 = N$
$\mathcal{N}_\Delta(M_j^i)$	$\mathcal{N}_\Delta(M_j^2) = \{j\} \quad \forall j \in \{1, \dots, N_T^2\}$ $\mathcal{N}_\Delta(M_1^1) = \emptyset$
$\mathcal{N}_T(M_j^i)$	$\mathcal{N}_T(M_j^2) = \emptyset$ $\mathcal{N}_T(M_1^1) = \{1, \dots, N\}$
M_j^i	$M_1^1 = M_{int} \quad M_j^2 = M_{PLL} \quad \forall j \in \{1, \dots, N_T^2\}$

Table 1: Three level hierarchical structure characteristics

6.2 Hierarchical Approach

The hierarchical approach used in this application consists of applying Algorithm 1 in two steps.

6.2.1 Local step

find a basis $\mathcal{B}_{T_j}^{diss}$ for each PLL by applying Corollary 3.1 using the given basis $\mathcal{B}_{\Delta_j}^{diss}$ of the elementary uncertainties Δ_j . In order to construct the basis $\mathcal{B}_{T_j}^{diss}$, we consider several elements

- ellipsoid: we can use Theorem 5.1 to find a disc² center and an upper bound on the optimal radius;
- band: we can use Theorem 5.2 to find an upper bound on the band width with free orientation;
- cone sector: given a fixed center C , we can use Theorem 5.3 to find an upper bound of the cone angle.

Please note that since all the PLLs are homogeneous, the basis $\mathcal{B}_{T_j}^{diss}$ obtained for one PLL is valid for all the 16 PLL. Therefore, computation time of the local step is equal to computation time required to find the basis elements for one PLL.

6.2.2 Global step

find the smallest γ_{ω_0} such that the network, denoted T_1^1 , is $\{-I, 0, \gamma_{\omega_0}^2 I\}$ dissipative by applying Corollary 3.1 using the basis $\mathcal{B}_{T_j}^{diss}$ obtained in local step. In this step, one can combine the elements of $\mathcal{B}_{T_j}^{diss}$ to characterize each PLL by

- ellipsoid alone;
- ellipsoid and band;
- ellipsoid and cone, ...

and propagate these characterizations to investigate the performance of the network in the global step.

6.3 Results

6.3.1 Local step

In this step, we are interested in finding three elements of the basis $\mathcal{B}_{T_j}^{diss}$: ellipsoid, band and cone sector. The frequency responses of a PLL for different frequencies are presented in Fig. 4 in the complex

²In single input single output case, the ellipsoid boils down to a disc.

plane. The red dot is the nominal frequency response and the green dots represent a sampling of the uncertain frequency response obtained for a sampling of a_j and k_j for illustrations purposes only.

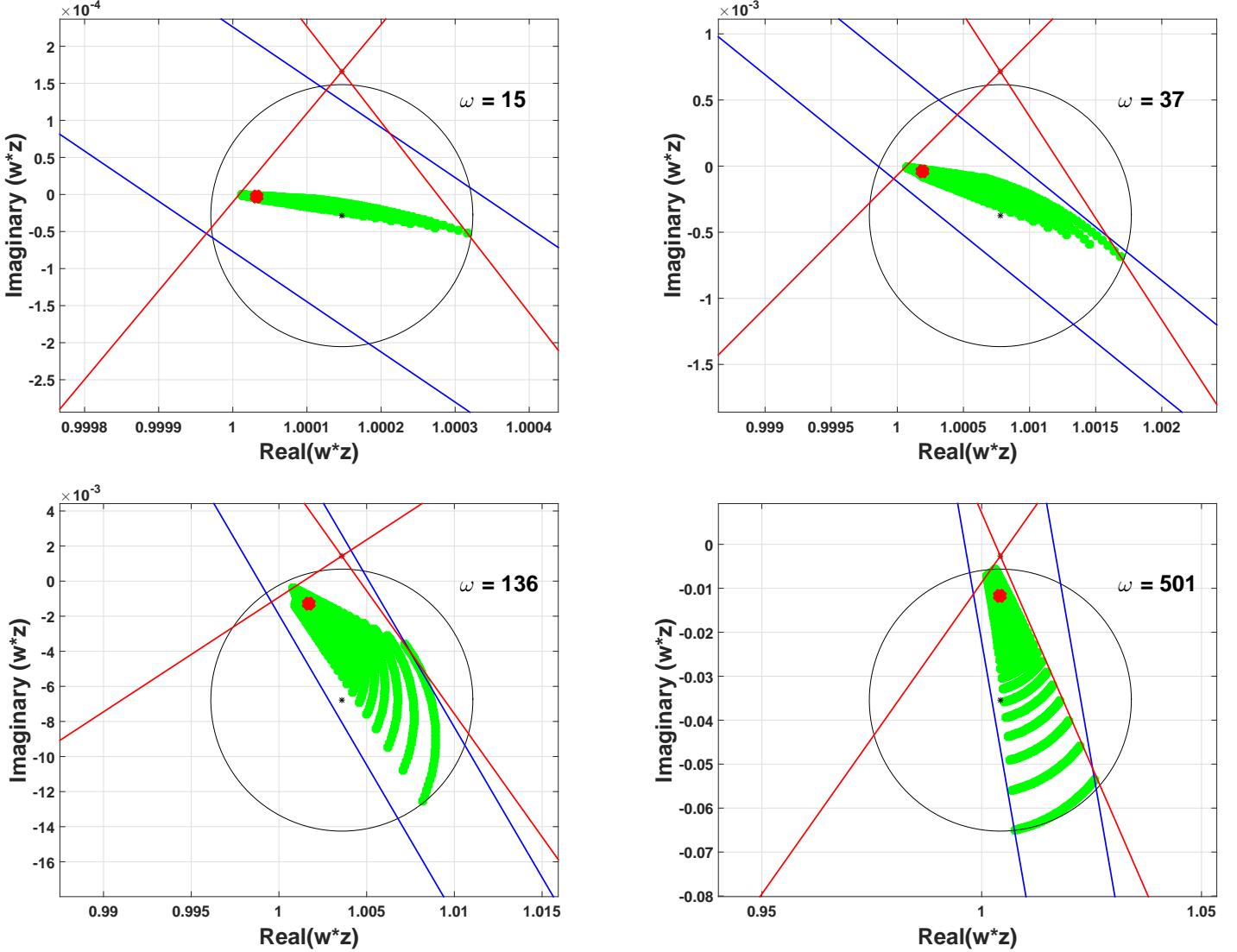

Figure 4: Visualization of the three elements of $\mathcal{B}_{T_j}^{diss}$ characterizing each PLL

The three elements of $\mathcal{B}_{T_j}^{diss}$ are interpreted in geometric terms and presented in Fig. 4. The obtained disc is presented in black with its center and we can see that the radius is minimized. The blue lines represent the obtained band with a free direction and the band width is also minimized. The red lines represent the obtained cone sector with its center C fixed as $C = c_{disc} + \mathbf{j} \times 1.1 \times r_{disc}$ where c_{disc} and r_{disc} are the disc center and radius respectively and the cone angle is minimized.

Please note that since the uncertainty Δ is parametric and in order to reduce the conservatism, the basis $\mathcal{B}_{\Delta}^{diss}$ is chosen in the form of DGL scaling from [23], see Remark 4.3.

6.3.2 Global step

The performance analysis results of the PLL network are presented in Fig. 5 and summarized in TABLE 2. Please note that the direct approach corresponds to the approach of Corollary 3.2.

Approach	Maximum peak	Computation time
Direct	6.01 dB	361.7s
Hierarchical: ellipsoid	13.44 dB	16.9s
Hierarchical: ellipsoid+band	12.97 dB	53.5s
Hierarchical: ellipsoid+cone	6.45 dB	115.9s

Table 2: Comparison between the different approaches

6.3.3 Discussion

All the analysis reveal that the PLL network is able to track a ramp as the slope of frequency response magnitude at low frequencies is 40 dB/dec (see [30] for more details) and the performance requirements are satisfied. The direct approach presents the less conservative results with a maximum peak of 6.01dB comparing to the different hierarchical approaches. However, computation time is significant: 361.7s. TABLE 2 illustrates the trade-off between conservatism and computation time that can be set by the user with the hierarchical approach. Please note that TABLE 2 gives the overall computation time for each approach *i.e.* computation time required for both steps. When using the disc alone, the results are conservative but they are obtained faster. The results are less conservative when using the disc with the band, but they are obtained in more time. However the maximum peak is also important. When using the disc with a cone sector, the results are much less conservative. Actually, they are close to the results of the direct approach: the difference in the maximal peak value with direct approach is +0.39 dB, that corresponds to 4.73 % of ratio. In addition, the results are obtained in 32.04 % of the time needed for direct approach.

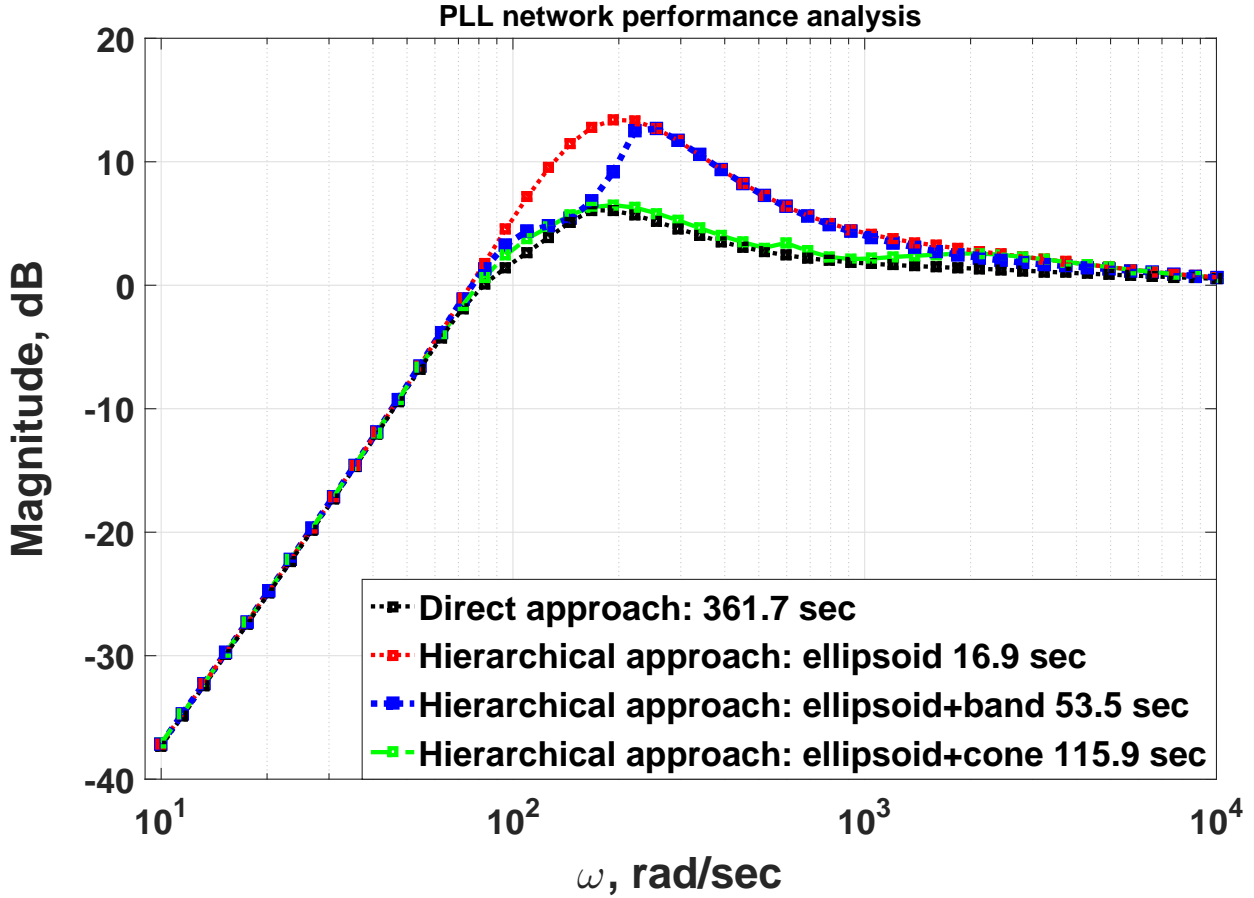

Figure 5: The PLL network performance analysis

7 Stability Analysis of a Chain of Uncertain Systems

In this section, we consider the stability analysis of a chain of uncertain systems taken from [16]. Our objective is to compare the computation time required in our hierarchical method, the direct analysis approach and the method proposed in [16].

7.1 Chain of uncertain systems description

Consider a chain of N uncertain system T_j . The uncertainties are assumed to be scalar reals: $\delta_1, \dots, \delta_N$ *i.e.* each system has one parametric uncertainty. The inputs and the outputs of each system T_j are denoted w_j and z_j .

For $j = \{2, \dots, N - 1\}$, each system T_j has two inputs and two outputs *i.e.* $w_j, z_j \in \mathbb{C}^2$ while $w_j, z_j \in \mathbb{C}$

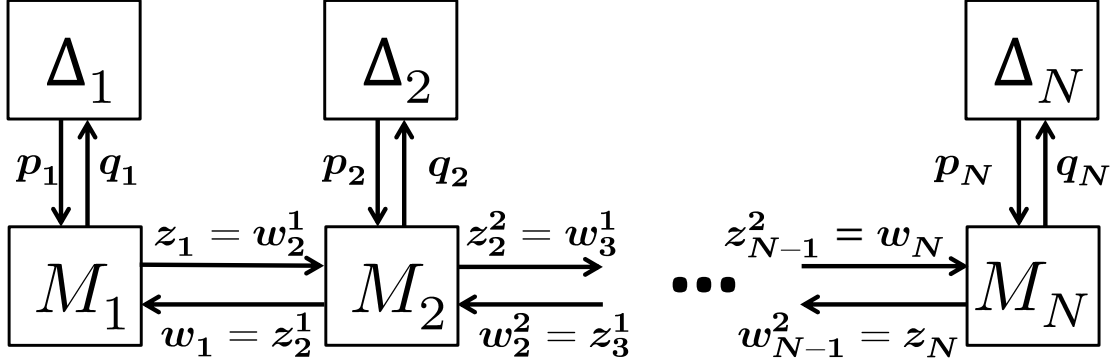

Figure 6: Chain of N uncertain systems

for $j = \{1, N\}$; hence it is possible, after normalization, to represent each uncertain system as

$$T_j = \Delta_j \star M_j \quad \Delta_j \in \mathbf{\Delta}$$

with $\mathbf{\Delta}$ is given by

$$\mathbf{\Delta} = \{\Delta = \delta, \quad \delta \in \mathbf{R} \quad \|\Delta\|_\infty \leq 1\}$$

Since each uncertain system T_j is only connected to T_{j-1} and to T_{j+1} , see Fig.6, the interconnections in this chain are defined by: $w_j^2 = z_{j+1}^1$ and $w_j^1 = z_{j-1}^2$ for $j = \{2, \dots, N-1\}$ and by $w_1 = z_2^1$ and $w_N = z_{N-1}^2$ for $j = \{1, N\}$. The global system is given by

$$T_{global} = \mathbf{bdiag}_j(T_j) \star M_{global}$$

where M_{global} is the global interconnection matrix. This matrix is sparse and it corresponds to a chordal graph, please refer to [16] for more details.

The systems are generated randomly as explained in [16] where the authors considered three conditions that different systems should satisfy

1. each system has to be nominally stable;
2. each system has to be robustly stable;
3. the chain of N systems has to be nominally stable.

7.2 Hierarchical approach

Let us suppose, without loss of generality, that N the number of systems in the chain is given by $N = 2^\nu$ where ν is a positive integer. It is possible to consider a three levels hierarchical structure as in TABLE 1, with $M_1^1 = M_{global}$ and $M_j^2 = M_j$ (the randomly defined), and perform the analysis in two steps as for the PLL application.

However, with this three level hierarchical structure, we will not exploit to the most the network structure which is sparse with a chordal pattern. To exploit this pattern, special optimization algorithms can be used as shown in [16]. Nevertheless, our hierarchical approach is flexible enough to capture this structure and exploit the chordal pattern. Since each system T_j is only connected to its direct neighbors, let us define a two by two fully split hierarchical structure such that at each hierarchical level we regroup systems two by two except level l and level $l - 1$, see Fig.7.

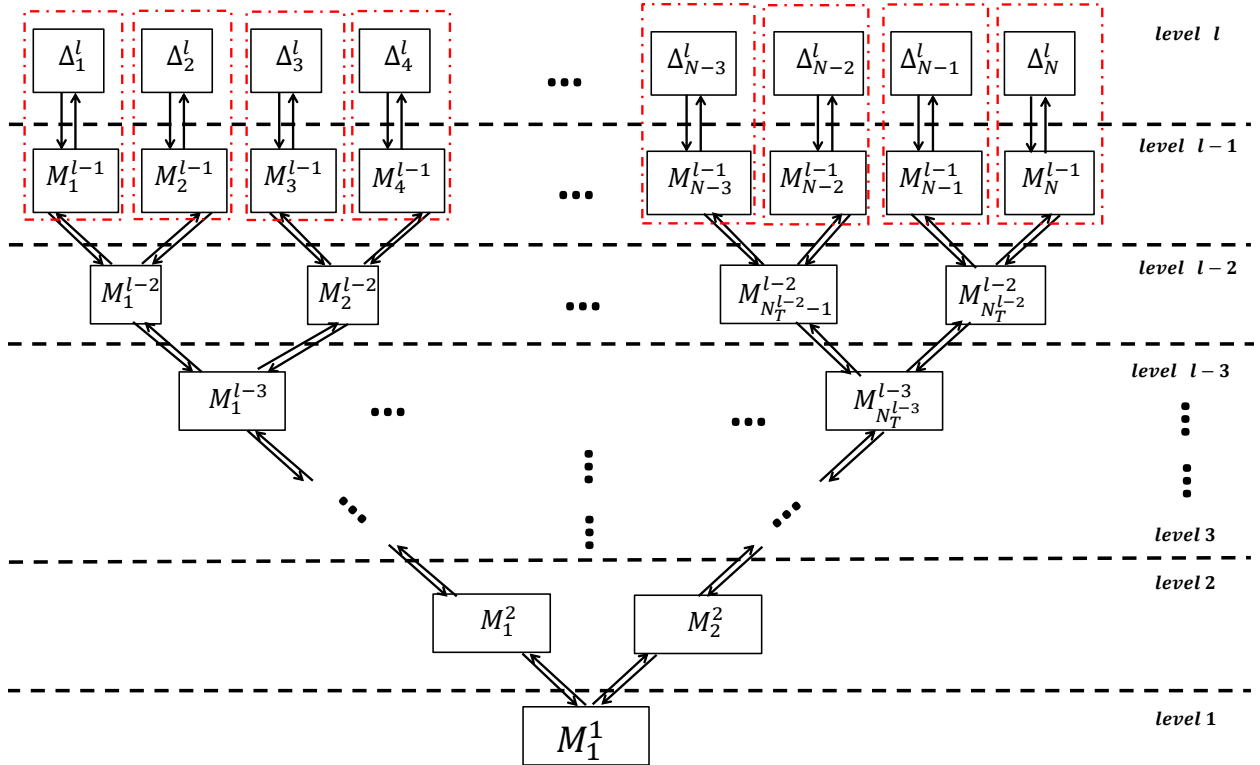

Figure 7: Two by two fully split hierarchical structure of chain of uncertain systems

Therefore, the chain of uncertain systems with the fully split hierarchical structure is a sub-class

of the LSS of (3) and (4). The different characteristics of its hierarchical structure are summarized in TABLE 3.

l	$\nu + 2$
N_T^i	2^{i-1}
$\mathcal{N}_\Delta(M_j^i)$	$\mathcal{N}_\Delta(M_j^{l-1}) = \{j\} \quad \forall j \in \{1, \dots, N_T^{l-1}\}$ $\mathcal{N}_\Delta(M_\bullet^i) = \emptyset \quad \forall i \in \{1, \dots, l-1\}$
$\mathcal{N}_T(M_j^i)$	$\mathcal{N}_T(M_\bullet^{l-1}) = \emptyset$ $\mathcal{N}_T(M_j^i) = \{2j-1, 2j\} \quad \text{for } \forall i \in \{1, \dots, l-2\}$
M_j^i	$M_1^1 = \begin{pmatrix} 0 & 1 \\ 1 & 0 \end{pmatrix} \quad M_j^{l-1} = M_j \quad \text{for } \forall j \in \{1, \dots, N_T^{l-1}\}$ $M_1^i = \begin{pmatrix} 0 & 1 & 0 & 0 \\ 1 & 0 & 0 & 0 \\ 0 & 0 & 0 & 1 \\ 0 & 0 & 1 & 0 \end{pmatrix}, \quad M_{N_T^i}^i = \begin{pmatrix} 0 & 0 & 0 & 1 \\ 0 & 0 & 1 & 0 \\ 0 & 1 & 0 & 0 \\ 1 & 0 & 0 & 0 \end{pmatrix} \quad \forall i \in \{2, \dots, l-2\}$ $M_j^i = \begin{pmatrix} 0 & 0 & 0 & 0 & 1 & 0 \\ 0 & 0 & 1 & 0 & 0 & 0 \\ 0 & 1 & 0 & 0 & 0 & 0 \\ 0 & 0 & 0 & 0 & 0 & 1 \\ 1 & 0 & 0 & 0 & 0 & 0 \\ 0 & 0 & 0 & 1 & 0 & 0 \end{pmatrix} \quad \begin{matrix} \forall i \in \{2, \dots, l-2\} \\ \forall j \in \{2, \dots, N_T^i-1\} \end{matrix}$

Table 3: Two by two fully split hierarchical structure characteristics

We can thus use the Hierarchical Robust Stability Analysis Algorithm of Remark 4.1 to certify the stability of the chain. The new hierarchical analysis setup will be performed in several steps.

7.2.1 First step

find a basis $\mathcal{B}_{T_j^{l-1}}^{diss}$ for each uncertain system T_j^{l-1} by applying Corollary 3.1 using the given basis $\mathcal{B}_{\Delta_j^l}^{diss}$ of the elementary uncertainties Δ_j^l .

7.2.2 Intermediate steps

for every $i = l-2, \dots, 2$ and for every $j = 1, \dots, N_T^i$, find a basis $\mathcal{B}_{T_j^i}^{diss}$ for each uncertain system T_j^i using the basis $\mathcal{B}_{T_n^{i+1}}^{diss}$ of the uncertain systems T_n^{i+1} obtained at level $i+1$.

7.2.3 Last step

given the basis $\mathcal{B}_{T_j^2}^{diss}$ obtained at level 2, test if $\mathcal{L}_S(M_1^1, \Phi_{11}^\Omega, \Phi_{12}^\Omega, \Phi_{22}^\Omega) \geq 0$.

To prove the robust stability of the network, it is sufficient to consider only one element: ellipsoid at each level. Furthermore and as we have seen, the uncertain systems of each hierarchical level i are interconnected at level $i - 1$ and levels below, it is hence easy to perform the hierarchical approach using parallel computation as it is explained in Remark 4.2.

7.3 Results

The objective here is to compute the ratio between the time required in the direct and the hierarchical approach and to compare it to that obtained in [16]. Therefore, we will apply the different approaches: direct and parallel hierarchical only for a single frequency³.

The analysis is performed for 10 realizations of the network presented earlier with different N . The evolution according to N of the average CPU time required to perform the analysis of 10 realizations in each approach is plotted in Fig.8.

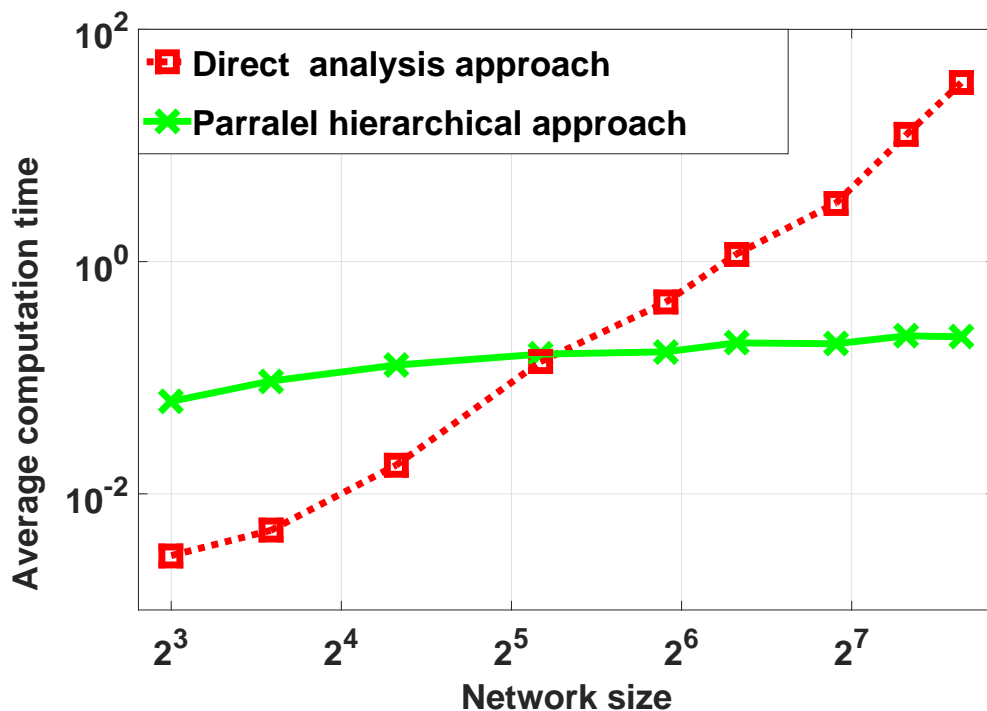

Figure 8: Average CPU computation time for different sizes N

³In order to conclude on the robust stability, the analysis has to be performed for a all the frequencies through a frequency griding.

Please note that in order to compare our results with those of [16], the basis $\mathcal{B}_{\tilde{\Delta}}^{diss}$ is the D-scaling from [4].

The average CPU time required for the direct approach increases dramatically when increasing the size of the network and it can reach 37.40s for a chain of 200 systems. For the hierarchical approach, the analysis is performed in a parallel manner at each hierarchical level. The required CPU time, at level i , is the maximum among all the CPU time required for the analysis of each sub-system T_j^i and the global CPU time is the sum of the computation time of each level. The average CPU time required for $N = 200$ is 0.2552s which gives a ratio of 154 between the time required in direct and hierarchical approaches. For comparison, this ratio is 10 in [16].

Please note that for small size chains (less than approximately 36), the computation time of the hierarchical approach is more important compared to the direct approach. When the chain size is increasing, the computation time of the direct approach becomes more and more important compared to the hierarchical approach. This behavior can be explained by analyzing how the network size N affects the computation time in both approach. The objective of the next section is to discuss how the computation time grows according to N .

8 Computation time for a Sub-Class of Uncertain LSS

The hierarchical structure considered in the previous section for the chain of uncertain systems can be generalized by regrouping systems n_s by n_s instead of two by two, see Fig.7, to obtain a fully split hierarchical structure. Without loss of generality, let us suppose that N the number of systems in the chain is given by $N = n_s^\kappa$ where κ is a positive integer.

The chain of uncertain systems, regrouped n_s by n_s fully split hierarchical structure is a sub-class of the LSS of (3) and (4). The different characteristics of this hierarchical structure can be given as in TABLE 3 with the following differences

- $l = \kappa + 2$;
- $N_T^i = n_s^{i-1}$;
- $\mathcal{N}_T(M_j^i) = \{n_s(j-1) + 1, \dots, n_s j\}$;

- M_j^i , for $i \neq l - 1$, are adapted according to n_s .

Furthermore, the stability problem considered in the previous section can be extended to a performance problem *i.e.* investigate if the chain is $\{X_1, Y_1, Z_1\}$ dissipative for all possible uncertainties by introducing the global performance signal w_g and z_g and adapting M_1^1 .

For illustration purpose of the computation time, and without lost of generality, we suppose that all the uncertainties Δ_j^l are homogeneous. Furthermore, again and without lost of generality, we perform basis propagation in hierarchical approaches, from level $l - 1$ to level 2, with only one element of $\mathcal{B}_{T_j^i}^{diss}$ such as the ellipsoid.

The objective is to characterize the computation time required to perform robustness analysis, at a given frequency ω_0 , using the different approaches: direct, hierarchical and parallel hierarchical.

Computation complexity

Computation time of an algorithm characterizes how fast or slow this algorithm performs. This computation time depends on the algorithm complexity which is defined as a numerical function of the number of variables n .

Given an optimization problem under LMI constraints, the algorithmic complexity is $\mathcal{O}(n^3)$ when using the interior point method [28]. The computation time of an algorithm depends on implementation details such as: processor speed, instruction set, *etc.* For this reason and subsequently in this report, we will refer to the algorithmic complexity as the computation time.

8.1 Direct approach

For the direct analysis approach and given a dissipativity property $\{X_1, Y_1, Z_1\}$, the number of decision variables of the robust performance analysis is $\eta_{\{X_1, Y_1, Z_1\}} + \sum_{k=1}^N \eta_{\Delta_k}$ where $\eta_{\{X_1, Y_1, Z_1\}}$ is the number of decision variables corresponding to $\{X_1, Y_1, Z_1\}$ and η_{Δ_k} is the number of decision variable corresponding to each elementary uncertainty Δ_k . In the case where all the uncertainties are homogeneous, all the η_{Δ_k} become η_{Δ} and the required computation time is given by

$$T_{DA} = \mathcal{O} \left((\eta_{\{X_1, Y_1, Z_1\}} + N\eta_{\Delta})^3 \right) \quad (22)$$

which is cubic according to N .

8.2 Hierarchical approach

Given $l = \kappa + 2$ and $N_T^i = n_s^{i-1}$. The total number of analysis to be performed for all levels is

$$N_{total} = \underbrace{1}_{\text{level 1}} + \underbrace{n_s + n_s^2 + \dots + n_s^{\kappa-1}}_{\text{intermediate levels}} + \underbrace{n_s^\kappa}_{\text{level } l-1}$$

which is the sum of $\kappa + 1$ first terms of a geometric progression, that is

$$N_{total} = N \frac{n_s}{n_s - 1} - \frac{1}{n_s - 1}$$

The algorithmic complexity of the hierarchical approach depends on the number of performed tests.

The latter changes according to the considered hierarchical structure *i.e.* the number of levels and the number of analysis at each level

- each of the N analysis problem, at level $l - 1$, has $(\eta_\Delta + \eta_{\{X,Y,Z\}})$ decision variables with $\eta_{\{X,Y,Z\}}$ is the number of decision variables corresponding to one $\{X, Y, Z\}$ dissipativity property to be propagated. The computation time is

$$N \mathcal{O} \left((\eta_\Delta + \eta_{\{X,Y,Z\}})^3 \right).$$

- each of the $N \frac{1}{n_s - 1} - \frac{n_s}{n_s - 1}$ intermediate analysis problems, from level $l - 2$ to level 2, has $(n_s + \eta_{\{X,Y,Z\}})$ decision variables⁴. The required computation time is

$$\left(N \frac{1}{n_s - 1} - \frac{n_s}{n_s - 1} \right) \mathcal{O} \left((n_s + \eta_{\{X,Y,Z\}})^3 \right).$$

- at level 1, the objective is to investigate if $T_1^1(\mathbf{j}\omega_0)$ is $\{X_1, Y_1, Z_1\}$ dissipative. The analysis problem has $(n_s + \eta_{\{X_1, Y_1, Z_1\}})$ decision variables and the computation time is

$$\mathcal{O} \left((n_s + \eta_{\{X_1, Y_1, Z_1\}})^3 \right).$$

Then the global computation time, at a given frequency ω_0 , of the hierarchical approach T_{HA} is

$$T_{HA} = N \mathcal{O} \left((\eta_\Delta + \eta_{\{X,Y,Z\}})^3 \right) + \mathcal{O} \left((n_s + \eta_{\{X_1, Y_1, Z_1\}})^3 \right) + \left(N \frac{1}{n_s - 1} - \frac{n_s}{n_s - 1} \right) \mathcal{O} \left((n_s + \eta_{\{X,Y,Z\}})^3 \right)$$

which is linear with respect to N .

⁴Here n_s corresponds to the number of α_{kj} of (9), with $k = 1$ and $j \in \{1, \dots, n_s\}$, corresponding to the n_s dissipativity properties propagated from level $i + 1$.

8.3 Parallel hierarchical approach

In this approach, the computation time at each level i is the maximum among computation time required for the analysis problems at this level i

- at level $l - 1$, the required computation time is

$$\mathcal{O}\left((\eta_{\Delta} + \eta_{\{X,Y,Z\}})^3\right)$$

- from level $l - 2$ to level 2, the number of intermediate levels is $(l - 2) = \kappa$, that is $\log_{n_s}(N)$ and the required computation time is

$$\log_{n_s}(N) \mathcal{O}\left((n_s + \eta_{\{X,Y,Z\}})^3\right)$$

- at level 1, the required computation time is

$$\mathcal{O}\left((n_s + \eta_{\{X_1,Y_1,Z_1\}})^3\right)$$

The global computation time required in this parallel hierarchical approach T_{PHA} is

$$T_{PHA} = \mathcal{O}\left((\eta_{\Delta} + \eta_{\{X,Y,Z\}})^3\right) + \mathcal{O}\left((n_s + \eta_{\{X_1,Y_1,Z_1\}})^3\right) + \log_{n_s}(N) \mathcal{O}\left((n_s + \eta_{\{X,Y,Z\}})^3\right)$$

which is logarithmic according to N .

We are able now to explain the results of Fig.8. Since the objective is to test the stability of the chain, $\eta_{\{X_1,Y_1,Z_1\}} = 0$ and the computation time T_{DA} becomes

$$T_{DA} = \mathcal{O}\left((N\eta_{\Delta})^3\right)$$

For the parallel hierarchical approach with $n_s = 2$, the computation time T_{PHA} becomes

$$T_{PHA} = \mathcal{O}\left((\eta_{\Delta} + \eta_{\{X,Y,Z\}})^3\right) + \mathcal{O}\left((2)^3\right) + \log_2(N) \mathcal{O}\left((2 + \eta_{\{X,Y,Z\}})^3\right)$$

The algorithmic complexity of the direct approach is cubic according to N . For $N < 36$, the algorithmic complexity is not really costly from computation time point of view and the analysis can be performed relatively fast. In the parallel hierarchical approach, even if finding one $\{X, Y, Z\}$ for each uncertain systems is not costly (since we are dealing with small size systems), the overall

algorithmic complexity is important compared to direct approach because of the multiplication term by $\log_2(N)$. However, when N is increasing, the evolution of the logarithmic function is less important than the cubic evolution which makes T_{DA} really significant compared to T_{PHA} . Fig.8 confirm this trend. Please note that the scales in this figure are logarithmic.

Remark 8.1 *It is possible to perform the same analysis for the case when $N \neq n_s^k$. The number of levels and systems at each level will change and the expressions of T_{HA} and T_{PHA} will be slightly different. However, the linear and logarithmic evolution of T_{HA} and T_{PHA} remain valid.*

9 Conclusion and Future Work

In this report, robustness analysis of uncertain large scale systems with hierarchical structure is considered. In order to reduce the computational load, a hierarchical robust performance analysis algorithm is proposed. This algorithm performs several hierarchical analysis using basis propagation from one hierarchical level to another. We have also presented how to formulate and compute several basis elements. The efficiency of this algorithm is illustrated through two examples: PLL network and chain of uncertain systems. The proposed algorithm allows to establish a trade-off between conservatism and computation time. Furthermore, we discuss the computation time for a sub-class of uncertain LSS. In contrast with cubic evolution of computation time with respect to N in the direct approach, the computation time grows linearly in the hierarchical approach and logarithmically in the parallel hierarchical approach. Therefore, the hierarchical approaches are more suitable and adapted to perform the robustness analysis when N becomes very significant. Nevertheless, in this report, we did not discuss how it is possible to obtain hierarchical structures neither the advantage of one hierarchical structure with respect to another. Therefore, major future work directions are

- establish a systematic approach to obtain the optimal hierarchical structure with respect to computation time and conservatism;
- combine the hierarchical approach with other approaches as the one presented in [15] and [16] *i.e.* introduce specialized solvers into the hierarchical approach.

References

- [1] R. D. Braatz, P. M. Young, J. C. Doyle, and M. Morari, “Computational complexity of μ calculation,” *IEEE Trans. Aut. Control*, vol. AC-39, no. 5, pp. 1000–1002, May. 1994.
- [2] S. Boyd and L. Vandenberghe, *Convex Optimization*. Cambridge University Press, 2004.
- [3] M. K. H. Fan, A. L. Tits, and J. C. Doyle, “Robustness in the presence of mixed parametric uncertainty and unmodeled dynamics,” *IEEE Trans. Aut. Control*, vol. 63, no. 1, pp. 25–38, Jan. 1991.
- [4] J. Doyle, “Analysis of feedback systems with structured uncertainties,” *IEEE Proceedings*, vol. 129-D, no. 6, pp. 242–250, Nov. 1982.
- [5] A. Megretski and A. Rantzer, “System analysis via integral quadratic constraints,” *IEEE Trans. Aut. Control*, vol. 42, no. 6, pp. 819–830, Jun. 1997.
- [6] P. Moylan, “A connective stability result for interconnected passive systems,” *IEEE Trans. Aut. Control*, vol. AC-25, no. 4, pp. 812–813, Aug. 1980.
- [7] M. Vidyasagar, *Input/Output Analysis of Large-Scale Interconnected Systems*, ser. Lecture Notes in Control and Information Sciences. Berlin: Springer-Verlag, 1981, no. 29.
- [8] I. Lestas and G. Vinnicombe, “Scalable decentralized robust stability certificates for networks of interconnected heterogeneous dynamical systems,” *IEEE Trans. Aut. Control*, vol. 51, no. 10, pp. 1613–1626, Oct. 2006.
- [9] I. Lestas and G. Vinnicombe, “Heterogeneity and scalability in group agreement protocols: Beyond small gain and passivity approaches,” *Automatica*, vol. 46, pp. 1141–1151, 2010.
- [10] J. A. Fax and R. M. Murray, “Information flow and cooperative control of vehicle formations,” *IEEE Trans. Aut. Control*, vol. 49, no. 09, pp. 1465–1476, Sep. 2004.
- [11] R. Olfati-Saber, J. A. Fax, and R. M. Murray, “Consensus and cooperation in networked multi-agent systems,” *Proceedings of the IEEE*, vol. 95, no. 1, pp. 215–233, Jan 2007.

- [12] K.-K. K. Kim and R. D. Braatz., “On the robustness of interconnected or networked uncertain multi-agent systems,” Melbourne, Jul. 2012.
- [13] C.-Y. Kao, U. Jönsson, and H. Fujioka, “Characterization of robust stability of a class of interconnected systems,” *Automatica*, vol. 45, no. 1, pp. 217–224, 2009.
- [14] U. Jönsson and C. Y. Kao, “A scalable robust stability criterion for systems with heterogeneous LTI components,” *IEEE Trans. Aut. Control*, vol. 55, no. 10, pp. 2219– 2234, Oct. 2010.
- [15] M. S. Andersen, A. Hansson, S. H. Pakazad, and A. Rantzer, “Distributed robust stability analysis of interconnected uncertain systetems,” in *IEEE Conf. Decision and Control*, Maui, Dec. 2012, pp. 1548–1553.
- [16] M. S. Andersen, S. H. Pakazad, A. Hansson, and A. Rantzer, “Robust stability analysis of sparsely interconnected uncertain systems,” *IEEE Trans. Aut. Control*, vol. 59, no. 8, pp. 2151–2156, Aug. 2014.
- [17] M. G. Safonov, “Propagation of conic model uncertainty in hierarchical systems,” *IEEE Trans. Aut. Control*, vol. 28, no. 6, pp. 701–709, Jun. 1983.
- [18] M. Dinh, A. Korniienko, and G. Scorletti, “Embedding of uncertainty propagation: Application to hierarchical performance analysis,” in *IFAC Joint Conference, 5th Symposium on System Structure and Control*, Grenoble, Feb. 2013, pp. 190–195.
- [19] ———, “Convex hierrachical analysis for the performance of uncertain large scale systems,” in *IEEE Conf. Decision and Control*, Los Angeles, Dec. 2014, pp. 5979– 5984.
- [20] K. Laib, A. Kornnienko, G. Scorletti, and F. Morel, “Phase IQC for the hierarchical performance analysis of uncertain large scale systems,” in *IEEE Conf. Decision and Control*, Osaka, Dec. 2015, pp. 5953–5958.
- [21] S. Skogestad and I. Postlethwaite, *Multivariable Feedback Control, Analysis and Design*. John Wiley & Sons, Chichester, England, 1996.

- [22] Y.-S. Chou, A. Tits, and V. Balakrishnan, “Stability multipliers and μ upper bounds: connections and implications for numerical verification of frequency domain conditions,” *IEEE Trans. Aut. Control*, vol. 44, no. 5, pp. 906–913, May. 1999.
- [23] G. Scorletti, X. Bombois, M. Barenthin, and V. Fromion, “Improved efficient analysis for systems with uncertain parameters,” in *IEEE Conf. Decision and Control*, New Orleans, Dec. 2007, pp. 5038–5043.
- [24] L. Vandenberghe, S. Boyd, and S.-P. Wu, “Determinant maximization with linear matrix inequality constraints,” *SIAM Journal on Matrix Analysis and Applications*, vol. 19, pp. 499–533, 1996.
- [25] S. Boyd, L. E. Ghaoui, E. Feron, and V. Balakrishnan, “Linear matrix inequalities in system and control theory,” *SIAM Studies in Applied Mathematics*, vol. 15, Jun 1994.
- [26] A. Tits, V. Balakrishnan, and L. Lee, “Robustness under bounded uncertainty with phase information,” *IEEE Trans. Aut. Control*, vol. 44, no. 1, pp. 50–65, Jan. 1999.
- [27] D. H. Owens, “The numerical range: A tool for robust stability studies?” *Syst. Control Letters*, no. 3, pp. 153–158, Dec. 1984.
- [28] Y. Nesterov and A. Nemirovski, *Interior Point Polynomial Methods in Convex Programming: Theory and Applications*. SIAM, 1994, vol. 13.
- [29] A. Korniienko, G. Scorletti, E. Colinet, E. Blanco, J. Juillard, and D. Galayko., “Control law synthesis for distributed multi-agent systems: Application to active clock distribution networks,” in *Proc. American Control Conf.*, San Fransisco, Jun. 2011, pp. 4691–4696.
- [30] A. Korniienko, G. Scorletti, E. Colinet, and E. Blanco, “Control law design for distributed multi-agent systems,” Laboratoire Ampère, Ecole Centrale de Lyon, Tech. Rep., 2011. [Online]. Available: <http://hal.archives-ouvertes.fr/hal-00630543/en/>
- [31] G. Scorletti, “Robustness analysis with time-delays,” in *IEEE Conf. Decision and Control*, San Diego, Dec. 1997, pp. 3824–3829.

- [32] V. Jakubovič, “The \mathcal{S} -procedure in nonlinear control theory,” *Vestnik Leningrad Univ. (russian)* *Vestnik Leningrad Univ. Math. (amer.)*, vol. 4 (amer.), no. 1 (russian), 1971 (russian) 1977 (amer.).

A Appendix

Theorem 3.1 gives necessary and sufficient conditions for the system $\Omega \star M$ to be stable and $\{X, Y, Z\}$ dissipative. The proof has to be done in two parts: stability and performance.

If the aim is only to investigate the system stability the external signals $w(\mathbf{j}\omega)$ and $z(\mathbf{j}\omega)$ could be suppressed. After dropping the frequency dependence, the system description of (5) becomes a feedback connection between M_{11} and Ω as follows:

$$\begin{aligned} p &= \Omega q \\ q &= M_{11} p \end{aligned}$$

A.1 Robust Stability Theorem

The following theorem is required to prove the stability statement in Theorem 3.1.

Theorem A.1 (Robust stability Theorem 4.1 of [31]) *Let Ω be a bounded and connected set of LTI systems. The uncertain system $\Omega \star M_{11}$ is stable if and only if*

1. *There exists a $\Omega_0 \in \Omega$ such that $\Omega_0 \star M$ is stable.*
2. *There exists a hermitian matrix $\Phi = \Phi^*$ of \mathbf{RL}_∞ such that Ω is $\{\Phi_{11}, \Phi_{12}, \Phi_{22}\}$ dissipative for every $\Omega \in \Omega$*
3. $\mathcal{L}_S(M_{11}, \Phi_{11}, \Phi_{12}, \Phi_{22}) \geq 0$

A.2 Proof of Theorem 3.1

The proof will be done for both statements stability and dissipativity.

A.2.1 Stability proof

The stability proof consists on proving that the conditions of Theorem 3.1 are equivalent to the conditions of Theorem A.1

Condition 1 and condition 2 of Theorem 3.1 are already given in Theorem 3.1. Condition 3 of Theorem 3.1 remains to be proven.

Post and pre multiplying condition 3 Theorem 3.1 by $\begin{pmatrix} p \\ w \end{pmatrix}$ yields

$$\begin{pmatrix} p \\ q \end{pmatrix}^* \begin{pmatrix} -\Phi_{11} & -\Phi_{12} \\ -\Phi_{12}^* & -\Phi_{22} \end{pmatrix} \begin{pmatrix} p \\ q \end{pmatrix} + \begin{pmatrix} z \\ w \end{pmatrix}^* \begin{pmatrix} X - \epsilon & Y \\ Y^* & Z - \epsilon \end{pmatrix} \begin{pmatrix} z \\ w \end{pmatrix} \geq 0$$

Since we are interested only in stability, we consider $\begin{pmatrix} z \\ w \end{pmatrix} = \begin{pmatrix} 0 \\ 0 \end{pmatrix}$ and with $q = M_{11}p$

$$\begin{pmatrix} I \\ M_{11} \end{pmatrix} \begin{pmatrix} -\Phi_{11} & -\Phi_{12} \\ -\Phi_{12}^* & -\Phi_{22} \end{pmatrix} \begin{pmatrix} I \\ M_{11} \end{pmatrix} \geq 0$$

which is condition 3 of Theorem A.1. Hence, the conditions of Theorem 3.1 are equivalent to the conditions of Theorem A.1.

A.2.2 Performance proof

Necessity The necessity is proved by supposing that $\Omega \star M$ is $\{X, Y, Z\}$ *dissipative* and proving condition 2 and condition 3 of Theorem 3.1.

By definition, for any $\Omega \in \underline{\Omega}$, the uncertain system $\Omega \star M$ is $\{X, Y, Z\}$ *dissipative* if:

$$\begin{pmatrix} p \\ w \end{pmatrix}^* \begin{pmatrix} M_{21} & M_{22} \\ 0 & I \end{pmatrix}^* \begin{pmatrix} X & Y \\ Y^* & Z \end{pmatrix} \begin{pmatrix} M_{21} & M_{22} \\ 0 & I \end{pmatrix} \begin{pmatrix} p \\ w \end{pmatrix} \geq \epsilon \begin{pmatrix} p \\ w \end{pmatrix}^* \begin{pmatrix} p \\ w \end{pmatrix} \quad (23)$$

such that

$$\begin{aligned} p &= \Omega q \\ q &= \begin{pmatrix} M_{11} & M_{22} \end{pmatrix} \begin{pmatrix} p \\ w \end{pmatrix} \end{aligned}$$

This last equality can be rewritten as

$$\begin{pmatrix} I & -\Omega \end{pmatrix} \begin{pmatrix} I & 0 \\ M_{11} & M_{12} \end{pmatrix} \begin{pmatrix} p \\ w \end{pmatrix} = 0.$$

that is

$$\begin{pmatrix} p \\ w \end{pmatrix}^* \begin{pmatrix} I & 0 \\ M_{11} & M_{12} \end{pmatrix}^* \begin{pmatrix} I \\ -\Omega^* \end{pmatrix} \begin{pmatrix} I & -\Omega \end{pmatrix} \begin{pmatrix} I & 0 \\ M_{11} & M_{12} \end{pmatrix} \begin{pmatrix} p \\ w \end{pmatrix} = 0 \quad (24)$$

Using the \mathcal{S} procedure [32] and [25], condition (23) holds such that (24) if and only if there exist τ such that for any⁵ $\Omega \in \underline{\Omega}$

$$\begin{aligned} & \begin{pmatrix} M_{21} & M_{22} \\ 0 & I \end{pmatrix}^* \begin{pmatrix} X - \epsilon & Y \\ Y^* & Z - \epsilon \end{pmatrix} \begin{pmatrix} M_{21} & M_{22} \\ 0 & I \end{pmatrix} + \dots \\ & \dots + \tau \begin{pmatrix} I & 0 \\ M_{11} & M_{12} \end{pmatrix}^* \begin{pmatrix} I \\ -\Omega^* \end{pmatrix} (I \quad -\Omega) \begin{pmatrix} I & 0 \\ M_{11} & M_{12} \end{pmatrix} \geq 0 \end{aligned}$$

which can be rewritten as

$$\begin{pmatrix} M_{21} & M_{22} \\ 0 & I \\ I & 0 \\ M_{11} & M_{12} \end{pmatrix}^* \left(\begin{array}{c|c} \begin{matrix} X - \epsilon & Y \\ Y^* & Z - \epsilon \end{matrix} & 0 \\ \hline 0 & \tau \begin{pmatrix} I \\ -\Omega^* \end{pmatrix} (I \quad -\Omega) \end{array} \right) \begin{pmatrix} M_{21} & M_{22} \\ 0 & I \\ I & 0 \\ M_{11} & M_{12} \end{pmatrix} \geq 0.$$

Let $(\mu_1 \quad \mu_2)$ be such that⁶

$$(\mu_1 \quad \mu_2)_{\perp} = \begin{pmatrix} M_{21} & M_{22} \\ 0 & I \\ I & 0 \\ M_{11} & M_{12} \end{pmatrix},$$

then, by applying Finsler's lemma⁷ [25], we obtain the equivalent condition there exists τ and ζ such that for any $\Omega \in \underline{\Omega}$,

$\exists \tau, \zeta$ such that

$$\begin{pmatrix} X - \epsilon & Y \\ Y^* & Z - \epsilon \\ 0 & \tau \begin{pmatrix} I \\ -\Omega^* \end{pmatrix} (I \quad -\Omega) \end{pmatrix} + \zeta \begin{pmatrix} \mu_1^* \\ \mu_2^* \end{pmatrix} (\mu_1 \quad \mu_2) \geq 0$$

It is equivalent by Schur's lemma to:

$$\begin{cases} \begin{pmatrix} X - \epsilon & Y \\ Y^* & Z - \epsilon \end{pmatrix} + \zeta \mu_1^* \mu_1 \geq 0 \\ \tau \begin{pmatrix} I \\ -\Omega^* \end{pmatrix} (I \quad -\Omega) + \zeta \mu_2^* \mu_2 - \zeta \mu_2^* \mu_1 \left[\begin{pmatrix} X & Y \\ Y^* & Z \end{pmatrix} + \zeta \mu_1^* \mu_1 \right]^{-1} \zeta \mu_1^* \mu_2 \geq 0 \end{cases}$$

Thus there exists τ, ζ and $\epsilon' > 0$ such that for any $\Omega \in \underline{\Omega}$,

$$\tau \begin{pmatrix} I \\ -\Omega^* \end{pmatrix} (I \quad -\Omega) + \zeta \mu_2^* \mu_2 - \zeta \mu_2^* \mu_1 \left[\begin{pmatrix} X - \epsilon & Y \\ Y^* & Z - \epsilon \end{pmatrix} + \zeta \mu_1^* \mu_1 \right]^{-1} \zeta \mu_1^* \mu_2 - \epsilon' I \geq 0$$

⁵In fact, τ should depend on Ω , that is τ_{Ω} . As shown in [22], it can be used a continuous function $\tau(\Omega)$ on the closure of $\underline{\Omega}$, but as $\underline{\Omega}$ is bounded, it can be selected independent of Ω (take the maximum on the closure of $\underline{\Omega}$).

⁶ A_{\perp} denotes the orthogonal of A i.e. $AA_{\perp} = 0$

⁷ $B^*AB \geq 0 \Leftrightarrow A + \zeta B_{\perp}^* B_{\perp} \geq 0$

Let us define

$$\Phi = \left(\zeta \mu_2^* \mu_2 - \zeta \mu_2^* \mu_1 \left[\left(\begin{array}{cc} X - \epsilon & Y \\ Y^* & Z - \epsilon \end{array} \right) + \zeta \mu_1^* \mu_1 \right]^{-1} \zeta \mu_1^* \mu_2 - \epsilon' I \right).$$

Then, using Finsler's lemma, there exist τ such that for any $\Omega \in \underline{\Omega}$,

$$\tau \left(\begin{array}{c} I \\ -\Omega^* \end{array} \right) (I \quad -\Omega) - \Phi \geq 0$$

is equivalent to for any $\Omega \in \underline{\Omega}$,

$$\left(\begin{array}{c} \Omega \\ I \end{array} \right)^* \Phi \left(\begin{array}{c} \Omega \\ I \end{array} \right) \geq 0.$$

That is condition 2 of Theorem 3.1.

For the remaining part, let us notice that

$$-\Phi + \zeta \mu_2^* \mu_2 - \zeta \mu_2^* \mu_1 \left[\left(\begin{array}{cc} X - \epsilon & Y \\ Y^* & Z - \epsilon \end{array} \right) + \zeta \mu_1^* \mu_1 \right]^{-1} \zeta \mu_1^* \mu_2 \geq 0.$$

Then by Schur's lemma, it is equivalent to

$$\left(\begin{array}{cc|c} X - \epsilon & Y & 0 \\ Y^* & Z - \epsilon & 0 \\ \hline 0 & 0 & -\Phi \end{array} \right) + \zeta \left(\begin{array}{c} \mu_1^* \\ \mu_2^* \end{array} \right) (\mu_1 \quad \mu_2) \geq 0.$$

Applying Finsler's lemma, it is equivalent to

$$\left(\begin{array}{cc} M_{21} & M_{22} \\ 0 & I \\ \hline I & 0 \\ M_{11} & M_{12} \end{array} \right)^* \left(\begin{array}{cc|c} X - \epsilon & Y & 0 \\ Y^* & Z - \epsilon & 0 \\ \hline 0 & 0 & -\Phi \end{array} \right) \left(\begin{array}{cc} M_{21} & M_{22} \\ 0 & I \\ \hline I & 0 \\ M_{11} & M_{12} \end{array} \right) \geq 0$$

which is exactly condition 3 of Theorem 3.1 after rearrangement.

Sufficiency The necessity can be proved by supposing condition 2 and condition 3 of Theorem 3.1 and prove that the system $\Omega \star M$ is $\{X, Y, Z\}$ dissipative.

Condition 2 of Theorem 3.1 is equivalent to

$$\left(\begin{array}{c} p \\ w \end{array} \right)^* \left(\begin{array}{cc} I & 0 \\ M_{11} & M_{12} \end{array} \right)^* \Phi \left(\begin{array}{cc} I & 0 \\ M_{11} & M_{12} \end{array} \right) \left(\begin{array}{c} p \\ w \end{array} \right) \geq 0 \quad (25)$$

After rearrangement Condition 3 of Theorem 3.1 can be written as

$$\begin{pmatrix} M_{21} & M_{22} \\ 0 & I \\ I & 0 \\ M_{11} & M_{12} \end{pmatrix}^* \left(\begin{array}{cc|c} X - \epsilon & Y & 0 \\ Y^* & Z - \epsilon & \\ \hline & 0 & -\Phi \end{array} \right) \begin{pmatrix} M_{21} & M_{22} \\ 0 & I \\ I & 0 \\ M_{11} & M_{12} \end{pmatrix} \geq 0$$

which can be decomposed to:

$$\begin{pmatrix} M_{21} & M_{22} \\ 0 & I \end{pmatrix}^* \begin{pmatrix} X - \epsilon & Y \\ Y^* & Z - \epsilon \end{pmatrix} \begin{pmatrix} M_{21} & M_{22} \\ 0 & I \end{pmatrix} - \begin{pmatrix} I & 0 \\ M_{11} & M_{12} \end{pmatrix}^* \Phi \begin{pmatrix} I & 0 \\ M_{11} & M_{12} \end{pmatrix} \geq 0$$

Post and pre multiplying by $\begin{pmatrix} p \\ w \end{pmatrix}$ yields

$$\begin{aligned} & \begin{pmatrix} p \\ w \end{pmatrix}^* \begin{pmatrix} M_{21} & M_{22} \\ 0 & I \end{pmatrix}^* \begin{pmatrix} X - \epsilon & Y \\ Y^* & Z - \epsilon \end{pmatrix} \begin{pmatrix} M_{21} & M_{22} \\ 0 & I \end{pmatrix} \begin{pmatrix} p \\ w \end{pmatrix} - \dots \\ & \dots - \begin{pmatrix} p \\ w \end{pmatrix}^* \begin{pmatrix} I & 0 \\ M_{11} & M_{12} \end{pmatrix}^* \Phi \begin{pmatrix} I & 0 \\ M_{11} & M_{12} \end{pmatrix} \begin{pmatrix} p \\ w \end{pmatrix} \geq 0 \end{aligned} \tag{26}$$

Adding (25) to (26) gives

$$\begin{pmatrix} p \\ w \end{pmatrix}^* \begin{pmatrix} M_{21} & M_{22} \\ 0 & I \end{pmatrix}^* \begin{pmatrix} X - \epsilon & Y \\ Y^* & Z - \epsilon \end{pmatrix} \begin{pmatrix} M_{21} & M_{22} \\ 0 & I \end{pmatrix} \begin{pmatrix} p \\ w \end{pmatrix} \geq 0$$

That is equivalent to $\Omega \star M$ is $\{X, Y, Z\}$ dissipative.