



HAL
open science

A heuristic approach for optimal sizing of ESS coupled with intermittent renewable sources systems

Laurent Bridier, David Hernández-Torres, Mathieu David, Philippe Lauret

► To cite this version:

Laurent Bridier, David Hernández-Torres, Mathieu David, Philippe Lauret. A heuristic approach for optimal sizing of ESS coupled with intermittent renewable sources systems. *Renewable Energy*, 2016, 91, pp.155-165. 10.1016/j.renene.2016.01.021 . hal-01306553

HAL Id: hal-01306553

<https://hal.science/hal-01306553>

Submitted on 25 Jun 2021

HAL is a multi-disciplinary open access archive for the deposit and dissemination of scientific research documents, whether they are published or not. The documents may come from teaching and research institutions in France or abroad, or from public or private research centers.

L'archive ouverte pluridisciplinaire **HAL**, est destinée au dépôt et à la diffusion de documents scientifiques de niveau recherche, publiés ou non, émanant des établissements d'enseignement et de recherche français ou étrangers, des laboratoires publics ou privés.

Techno-economic storage sizing for wind, wave and PV power

Laurent Bridier^{a,*}, David Hernández-Torres^a, Mathieu David^a, Phillipe Lauret^a

^aUniversité de La Réunion, 40 Avenue de Soweto, 97410 Saint-Pierre, Réunion, France

Abstract

In this paper a techno-economic comparison of an energy storage system (ESS) sizing for three intermittent renewables, wind, wave and PV power, with regard to two electricity grid services is presented. These services are defined by the utility operator in order to meet different load needs and have to be provided by the producer. The first service consists of output hourly smoothing, based on day-ahead power forecasts (S1). The second service supplies year-round guaranteed power (S2). This leads to an annual default time rate (*DTR*) for which the actual power supplied does not match the day-ahead power bid within a given tolerance. A heuristic optimization strategy based on the ESS state of charge denoted as *adaptive charge* is developed in this study. This approach enables the minimal 5%-*DTR* ESS capacity, power, energy and feed-in tariffs to be inferred from the operating conditions, depending on tolerance. Ocean wave and PV power measurements and forecasts are used in French overseas department Reunion and wind power in Guadeloupe. The simulations assess and compare the techno-economic viability and efficiency of every renewable sources coupled with ESS. Annual results show that PV power is more efficient with daylight hours restricted services and higher power levels can be guaranteed for S1. In the other hand, wind and wave power are more suitable than PV for services dedicated to full-day power delivery, as in the case of S2. For hourly smoothing the forecast accuracy influence is studied and yields a high impact on the techno-economic sizing.

Keywords: renewable energy storage, grid utility services, optimization

Nomenclature

P_{bid}	Guaranteed power bid [kW]
P_f	Power forecast [kW]
P_{out}, E_{out}	Output power, energy (from converter) [kW,kWh]
P_{sto}	Storage power ($P_{sto} > 0$ discharge, $P_{sto} < 0$ charge) [kW]
P_{grid}	Power supplied to the grid [kW]
$E_{gridS1,S2}$	Annual energy supplied while service is met [kWh]
P_{dev}	Deviation between power bid and output [kW]
P_{gtd}	Annual guaranteed power bid [kW]
P_{inst}	Installed capacity [kW]
P_{lost}, E_{lost}	Lost output power, energy [kW,kWh]
S	Useful storage capacity [kWh]
SOC	Storage state of charge [kWh]
dod	Depth of discharge [%S]
η_d, η_c	Storage block efficiency (discharge, charge) [%]
acp	Adaptive charge parameter [%S]
DTR	Default time rate [%]
tol	Allowed tolerance on power bid [kW, % \bar{P}_{out}]
Δt	Time step, 10 min. in this study [h]
$factor$	Part of forecast taken as power bid [%]
α	forecast accuracy factor [u]

N	Number of time points
$rMAE$	Relative Mean Absolute Error [% \bar{P}_{out}]
NPV	Net present value [€/MWh]
FIT	20-year storage payback feed-in tariff [€/MWh]
c_0	Feed-in tariff without storage [€/MWh]
c_1, c_2	Feed-in tariffs for services S1, S2 [€/MWh]
\bar{x}	mean value of parameter x
x^*	Optimal viable solution for parameter

1. Introduction

With the depletion of fossil fuel energy sources and the certainty of peak oil, the integration of renewable energy has become necessary, if not essential. In non-interconnected systems, particularly island grids, the challenge is to increase the energy independence and to cut the energy bills. However, when the integration rate of the renewables exceeds 15 or 20%, the grid operator has to cope with new problems. Since the renewable source is by nature highly intermittent, it is difficult to increase the input of renewable energy sources into the grid. In order to mitigate this variability and supply a smooth guaranteed power to the grid, renewable energy storage is a feasible solution and has, for several years, been studied and installed around the world [1].

Various papers have been written about the coupling of energy ESS with renewable sources [2]. PV, wind or

*corresponding author

Email addresses: laurent.bridier@univ-reunion.fr (Laurent Bridier), david.hernandez-torres@univ-reunion.fr (David Hernández-Torres), mathieu.david@univ-reunion.fr (Mathieu David), phillipe.lauret@univ-reunion.fr (Phillipe Lauret)

18 hybrid PV/wind systems with batteries or pumped hydro 46
 19 energy storage (PHES) systems have been well studied [3] 47
 20 [4]. The optimal ESS sizing is usually based either on 48
 21 analytical methods [5] [6] or iterative methods such as Genetic
 22 Algorithms [7] to minimize costs [8]. Another increasingly
 23 widespread approach is to take into account the uncertainty of
 24 renewable power through stochastic programming [9] [10]. In
 25 these studies, the time step is usually one hour, during 24 hours
 26 or a few days.

27 In this paper, a storage system with a 10-minute or less
 28 response time for power management applications is evaluated.
 29 The goal is to size the storage in an optimal viable way so that
 30 the supplier can provide to the grid utility two specific yearly
 31 services: hourly smoothing and annual leveling. These services
 32 may boost the integration of renewables into vulnerable grids
 33 [11]. A scheduled storage operation strategy that can be applied 49
 34 by the supplier to meet the considered service under operating 50
 35 conditions is initially presented. Secondly, the resulting ESS 51
 36 sizings are compared and discussed.

37 2. Modeling

38 2.1. Grid services

39 Two kinds of grid services defined by the utility operator,
 40 S1 and S2, are analyzed in this study and presented in figure 1.

The first service S1 is an ‘‘hourly smoothing’’. It yields an
 hourly smoothed output of the day-ahead forecast power P_f ,
 that is

$$S1 \equiv P_{bid}(\text{hour}) = factor \cdot P_f(\text{hour}) \quad (1)$$

41 for every exact hour and linear interpolation in between. α is
 42 the multiplying factor on forecast error in order to compute the
 43 impact of forecast accuracy.

Service S2 provides a year round constant power bid. This
 guaranteed power commitment P_{gtd} may be based directly (or
 not) on the forecast. For this study P_{gtd} is a part *factor* of
 the annual mean forecast power. Varying *factor* changes how
 much ESS capacity is needed by the producer to supply the
 corresponding power bid all year.

$$S2 \equiv P_{bid}(\text{year}) = P_{gtd} = factor \cdot \bar{P}_f(\text{year}) \quad (2)$$

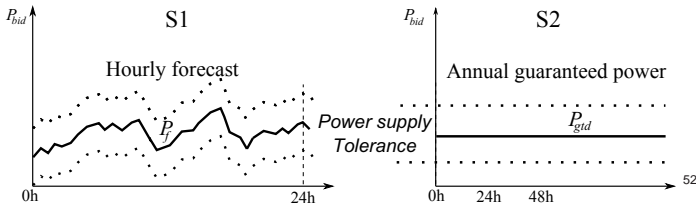

Figure 1: Grid services; The dashed lines represent the given tolerance layer. 53

44 The tolerance level tol may be used by the grid operator as 55
 45 a decision parameter in a bidding process to have more surely 56

a service met. The actual power supplied to the grid can be
 slightly different than the day-ahead bid due to this tolerance
 on power supply and also to the defaults.

The default time rate DTR is defined as the part of the
 total period during which the power supplied to the grid P_{grid}
 does not meet the day-ahead power bid P_{bid} , announced by
 the supplier to the grid operator, within the tolerance. The
 definition is considered as developed in [12] for a hybrid solar-
 wind system, where the DTR represents the Loss of Power
 Supply Probability (LPSP), with the power bid given by the
 load. This is shown in figure 2 and can be described as:

$$DTR = \frac{1}{N} \sum_{t=1}^N (P_{grid}(t) < P_{bid}(t) - tol) \quad (3)$$

where the inequality is 0 if false (service met), 1 if true (default).
 For PV power N corresponds to the number of daylight time
 steps.

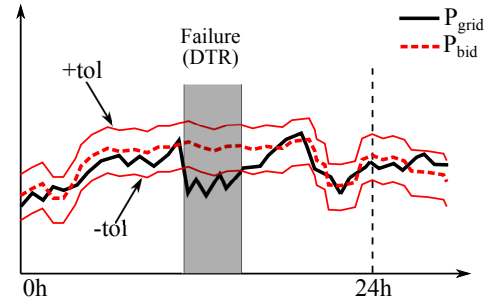

Figure 2: Tolerance and default of power supply.

There is no overshoot default. The output energy that cannot
 be neither supplied to the grid nor charged into the ESS is
 considered lost. This loss occurs when first the output is above
 the allowed power supply upper bound $P_{bid}(t) + tol$ and second
 the storage is full. The supplier meets the service when the
 DTR is less than DTR^{max} , 5% in this work. The aim is first
 to infer the minimal ESS capacity S^* meeting each service and
 to determinate corresponding energies and tariffs. For a given
 tolerance and ESS capacity, P_{gtd}^* is the maximal guaranteed
 power that meets the service with 5%- DTR . Secondly, for a
 fixed tolerance, an optimization process achieves the maximal
 power that can be supplied to the grid depending on the ESS
 capacity. $E_{grid_{S1,S2}}$ is the energy supplied to the grid only
 while the service S1 or S2 respectively is met:

$$E_{grid_{S1,S2}} = \sum_{\substack{1 \leq t \leq N \\ P_{grid}(t) \geq P_{bid}(t) - tol}} P_{grid}(t) \cdot \Delta t \quad (4)$$

2.2. Storage model

The figure 3 represents the flowchart of the output and
 storage block model where electrical devices may be converter,
 inverter and transformer. This modeling can be applied to
 systems with a load demand by setting the bid equal to the load.

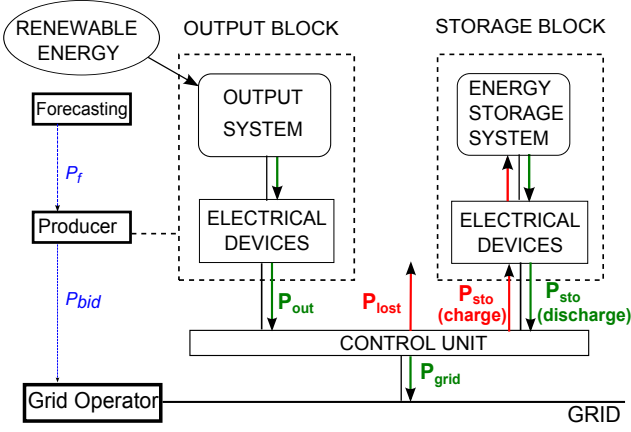

Figure 3: Modeling flowchart

57 The storage system is viewed as a black box defined by
 58 the following static technical characteristics: ESS capacity
 59 S , maximal charge power P_{sto}^{max} , maximal discharge power
 60 $-P_{sto}^{min}$, minimal state of charge SOC^{min} , maximal state of
 61 charge SOC^{max} , initial state of charge SOC_0 , maximal depth
 62 of discharge dod^{max} , charge/discharge efficiency η_c and η_d . The
 63 global efficiency of the storage block in figure 3 encompasses
 64 electrical conversion devices. It is assumed that the time step
 65 is sufficiently large compared to the systems dynamics. The
 66 ESS is supposed to have a response time lower than the time
 67 scale used (i.e. 10 minutes in this study). It must normally
 68 compensate for the deviation between the power bid and the
 69 actual power output. The main assumption is that whatever
 70 the state of charge $SOC(t)$ between SOC^{min} and SOC^{max} the
 71 storage device can charge or discharge during Δt the desired
 72 energy. This is generally the case as power deviation to balance
 73 is much lower than the rated capacity and SOC is not closed to
 74 extreme values.

75 The actual ESS power P_{sto} is constrained by the
 76 charge/discharge rated power and capacity limitations. The
 77 modeling developed in this study is similar to the approach
 78 considered in [13] with depth of discharge managing. As the
 79 operating conditions and the strategy require, the ESS has to
 80 charge or discharge a certain power P_{th} at time t as follows:

- DISCHARGE (P_{th}) with $P_{th} > 0$:

$$\begin{cases}
 P_{sto}(t) = \min(P_{th}, P_{sto}^{max}, P_{max}(t), P_{bid}(t) + tol) \\
 P_{grid}(t) = P_{out}(t) + P_{sto}(t) \\
 P_{lost}(t) = 0 \\
 SOC(t+1) = SOC(t) - \frac{1}{\eta_d} P_{sto}(t) \Delta t \\
 dod(t+1) = dod(t) + (SOC(t) - SOC(t+1))/S
 \end{cases} \quad (5)$$

- CHARGE (P_{th}) with $P_{th} \leq 0$:

$$\begin{cases}
 P_{sto}(t) = \max(P_{th}, P_{sto}^{min}, P_{min}(t), -P_{out}(t)) \\
 P_{grid}(t) = \min(P_{out}(t) + P_{sto}(t), P_{bid}(t) + tol) \\
 P_{lost}(t) = P_{out}(t) + P_{sto}(t) - P_{grid}(t) \\
 SOC(t+1) = SOC(t) - \eta_c P_{sto}(t) \Delta t \\
 dod(t) = 0
 \end{cases} \quad (6)$$

where

$$\begin{cases}
 P_{max}(t) = (SOC^{max} - SOC(t)) \cdot \eta_d / \Delta t \\
 P_{min}(t) = (SOC^{min} - SOC(t)) / (\eta_c \Delta t)
 \end{cases} \quad (7)$$

Ideally, without any strategy, the ESS should compensate for the exact power deviation between bid and output i.e.:

$$P_{th} = P_{dev}(t) = P_{bid}(t) - P_{out}(t) \quad (8)$$

81 This will be modified when applying the adaptive charge
 82 strategy developed in section 3. The power supplied to the
 83 grid P_{grid} and the corresponding annual energy E_{grid} have to
 84 be as high as possible under the paramount constraint that the
 85 service is met.

For given storage parameters, the initial problem is to find the storage operation that maximizes the energy injected into the grid meeting the service while complying with storage power, capacity and discharging constraints. This can be expressed as:

$$\max E_{grid_{S1,S2}} \text{ s.t. } \begin{cases}
 DTR < DTR^{max} \\
 P_{sto}^{min} \leq P_{sto}(t) \leq P_{sto}^{max} \\
 SOC^{min} \leq SOC(t) \leq SOC^{max} \\
 dod(t) \leq dod^{max}
 \end{cases} \quad t = 1, \dots, N \quad (9)$$

This is a large-scale non-linear optimization problem which can be approximated as a quadratic programming [14] minimizing the quadratic difference between the ESS power and the power bid deviation under linear capacity constraints. However this annual optimization cannot be performed in operational conditions as the whole year data are needed. The heuristic approach considered in this study consists of raising $|P_{sto}|$ as high as possible while respecting the constraints at each time step t . Operation strategies are added and developed in section 3 for DTR and sizing improvement. The interest with the proposed methodology is that a more flexible control and an optimal operation management of the ESS is possible at each time step, with decisions made based on the current forecast, output and state of charge. On the other hand, this model is helpful for testing and choosing storage operation strategies in order to compare viable results with regard to any kind of services. These services could either be related to the grid or to the load, for instance in stand-alone systems or zero net energy buildings.

2.3. Economic model

In this section the economic analysis methodology of the different services described above is presented. The study is based on the guidelines described in [15]. The classical cash flow and net present value (NPV) methodology is considered. A similar approach was used in [16] to assess the economic performance of a renewable energy farm with ESS facilities.

Cumulated NPV is computed via following equation:

$$NPV(Y) = \sum_{n=0}^Y \frac{C_n}{(1+i)^n} \quad (10)$$

where C_n is the total annualized cash flow for a given period n , i the discount rate and Y the study period.

Annual revenues from energy supplied to the grid are given by:

$$\begin{aligned} \text{Revenues}_{\text{Renewables}} &= c_0 \cdot E_{\text{grid}} & (11) \\ \text{Revenues}_{\text{Renewables+ESS}} &= c_i \cdot E_{\text{grid}_{S_i}} \quad i = 1, 2 & (12) \end{aligned}$$

where the feed-in tariff without storage c_0 is the tariff when output is supplied directly to the grid and no specific service is provided. c_1 and c_2 are the annual feed-in tariffs (FIT) for S1 and S2 services, with the price condition $c_0 < c_1 < c_2$.

As the revenues vary directly with the energy supplied while the service is met, the economic criterion is not the revenues but the value-added of the ESS. The economic performance of the ESS is therefore evaluated by its contribution to operational profit for each service. This study aims to compute the minimal FIT c_1^* or/and c_2^* for each service that results in a storage payback time of 20 years. The facility lifespan is supposed to be greater than this duration. The contribution of the storage device to operational profit for year y is computed by:

$$\text{Profit}_{\text{ESS}}(y) = NPV_{\text{Renewables+ESS}}(y) - NPV_{\text{Renewables}}(y) \quad (13)$$

The storage payback time is the earliest year y for which the ESS profit is positive. In order to compare renewables and services as function of storage payback, the feed-in tariff c_0 is chosen equally for all renewables. As the tariff decreases when more energy is supplied to the grid with a fixed ESS capacity, the 20-year storage payback limitation is also a constraint on grid energy and thus on energy lost. In terms of electricity purchase, service S2 may be of more interest than S1 because annual guaranteed power may have a higher feed-in tariff than the non-guaranteed service.

2.4. Inputs

For wind, wave and PV power facilities, the rated powers are normalized to a capacity of 1MWp i.e. $P_{\text{inst}} = 1000\text{kW}$. The considered simulation time step is 10 minutes i.e. $\Delta t = 1/6$ hour and thus the number of time points is $N = 52560$.

Wind power output was measured every 10 minutes from September 2010 to August 2011 in a Guadeloupe wind farm, a French overseas department. Wind power hourly forecasts are based on meteorological forecasts of the french national forecasting centre Meteo France and provided by a subsidiary specializing in regional climate services. The PV power output was measured from January to December 2009 in Saint-Pierre, Reunion (France). PV forecasts are given by the

persistence model where the forecast power is equal to the measured output at the same time the previous day. Wave data measurements were made from a site near Saint-Pierre (Pierrefonds) in Reunion. The data collected includes wave height and period measured from 2000–2007 and 2009. Wave state forecasts from W3 models are published by the US-NAVY at <http://www.usgodae.org/>.

Forecasts errors are shown in figure 4. Associated statistical indicators are presented in table 1. As during a failure of power supply, the default time is unchanged whether the deviation to compensate by the ESS is much higher or not, the chosen forecast accuracy metrics is the relative Mean Absolute Error $rMAE$. This metrics is less sensitive than root mean square error (RMSE) to extreme values [17].

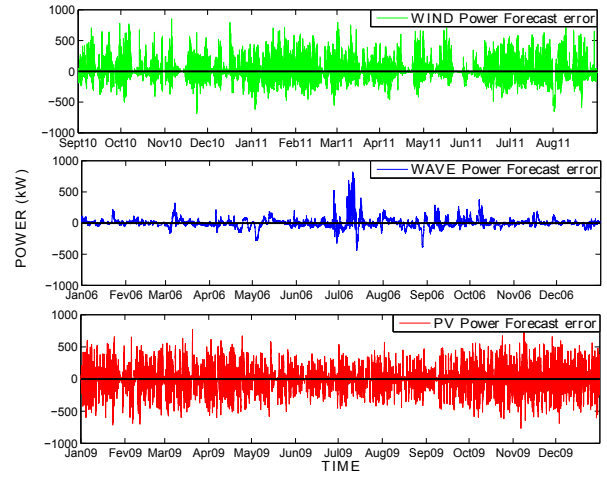

Figure 4: Wind, wave and PV power forecast errors

Table 1: Forecast and output statistical indicators

Renewable Source	annual output [MWh/MWp]	\bar{P}_{out} [kW]	\bar{P}_f [kW]	$\max(P_{out})$ [kW]	MAE [kW]	$rMAE$ [%]	Output-forecast correlation [%]	Day-ahead correlation [%]
Wind power	1692.2	193.2	189.4	1000	90.9	47.1	77.3	52.0
Wave power	964.3	110.1	107.1	888.8	47.9	43.5	72.6	69.7
PV power	1356.6	154.9	154.9	923.1	48.7	31.4	87.1	87.1

The base values of ESS and economic fixed parameters used for the simulations are given in tables 2.

Table 2: ESS and economic parameters values

Parameter	Value	Parameter	Value
P_{sto}^{max}	500kW	Investment ^a	2M€/MWp
$-P_{sto}^{min}$	500kW	Investment ^{b,c}	4M€/MWp
η_d	90%	Op.&Maintenance ^c	5%
η_c	90%	Op.&Maintenance ^{a,b}	10%
SOC^{max}	90%	Storage lifespan	20 years
SOC^{min}	10%	ESS cost	700€/kWh
SOC_0	50%	c_0	100€/MWh
dod^{max}	60%	Discount rate	10%

a=Wind, b=Wave, c=PV

157 3. Storage operation optimization

158 3.1. Tolerance Layer Strategy

159 As the producer can supply any power in the tolerance
 160 layer $[P_{bid} - tol; P_{bid} + tol]$ without default nor penalties, it
 161 is pertinent to choose the optimal power supply level in this
 162 range. Three levels are defined in figure 5 for charge and
 163 discharge which gives nine strategies. The strategies +/-, 0/0
 164 and -/+ correspond to power bids $P_{bid} - tol$, P_{bid} and $P_{bid} + tol$
 165 respectively. Strategies +/0, +/+ and 0/+ are inconsistent inside
 166 the tolerance layer and no charge/discharge order is performed.

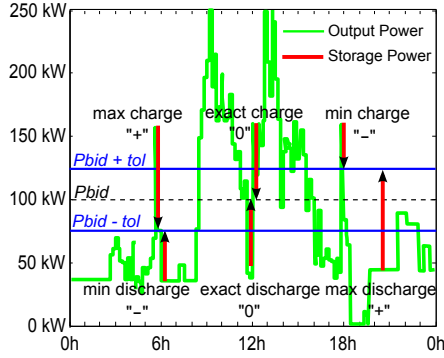

Figure 5: Tolerance layer strategies.

167 3.2. Adaptive charge

168 The maximum charging / minimum discharging strategy is
 169 adopted to further decrease the required ESS capacity. In this
 170 strategy the default energy provided by the renewables farm and
 171 the ESS in case of failure is supplied to the grid. This energy
 172 is little or not valued, if not accepted, by the utility operator.
 173 It is therefore better to use it directly for charging the storage
 174 device. This is called the “Default = Charge” strategy.

175 However when operating with this single strategy some
 176 oscillations occur in the grid power supply. These oscillations
 177 are shown in the first graph of figure 6 for a low wind power
 178 output day, 21/04/10, with a 25% tolerance and an ESS capacity
 179 of 1000kWh/MWp. They are due to alternating charge and
 180 discharge phases corresponding to empty and almost empty
 181 storage. This behavior is unacceptable for the grid operator as
 182 it infers instability in grid management.

183 In order to reduce these oscillations, an “adaptive charge
 184 parameter” acp is introduced. acp represents the energy (in
 185 ESS capacity unit) which must be charged into storage before
 186 supplying power to the grid. Ideally acp might be half the
 187 energy produced during a default series. It is thus very
 188 dependant on the default mean time from when the output drops
 189 until it rises again. The longer the default series is the higher
 190 the adaptive parameter may be. This parameter can be updated
 191 every day or even at every time step if short-horizon forecasts
 192 (e.g. one to six hours) were available at a default series start.

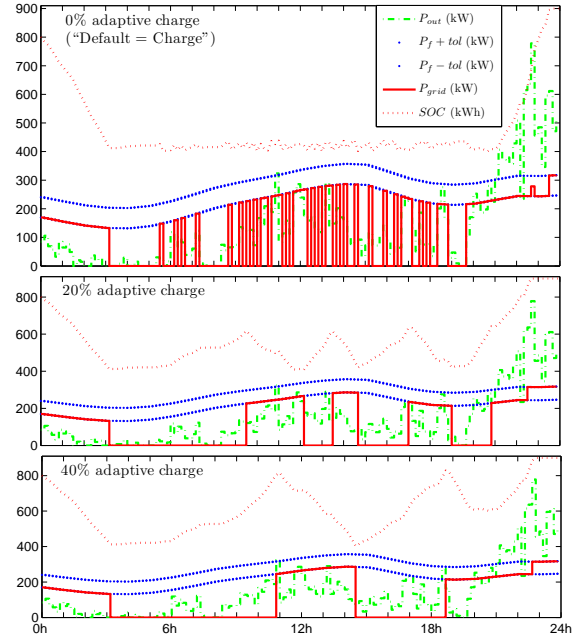

Figure 6: Grid supply oscillations curtailment with adaptive charge

193 3.3. Strategy comparison

194 Strategy comparisons are presented in figures 7 and 8 for
 195 services S1 and S2 with ESS capacity $S = 1000 \text{ kWh/MWp}$ and
 196 tolerance $tol = 25\% \bar{P}_{out}$. As the main constraint is to meet the
 197 service, the selection criterion is the annual DTR . Regardless
 198 of wind, wave or PV power, a lower DTR is obtained with the
 +/- strategy.

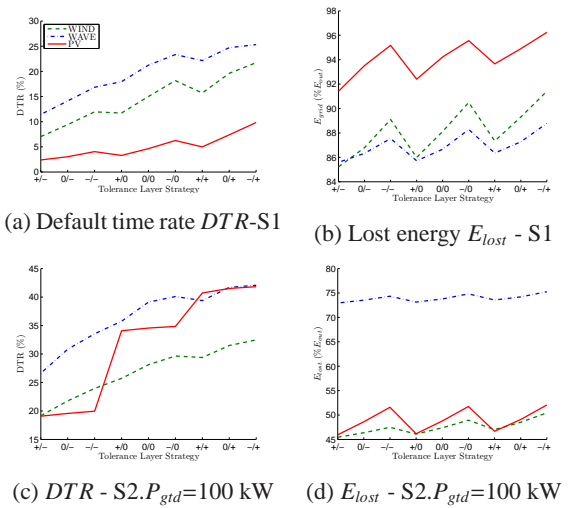

Figure 7: Tolerance layer strategies comparison

Generally speaking, a maximal charge strategy is the best
 for reducing defaults and thus ESS capacity, even if the energy
 losses can be higher and power supplied to the grid slightly
 lower. It can be also noted that only PV can meet the S1 service
 (5% - DTR) with a 1000kWh/MWp ESS and 25%-tolerance.

Other strategies lead to unworkable capacities greater than 5 and 10MWh/MWp for 0/0 and -/+ strategies respectively. Maximum charging/minimum discharging is therefore chosen as a core strategy for ESS sizing. This strategy has been used for wave power storage sizing in [18].

Decrease in oscillations through adaptive charge shown in figure 6 takes place all year round for all renewables evaluating the default mean time DMT in figure 8. Lower oscillations are achieved with greater adaptive parameter. As a counterpart, higher DTR and therefore higher ESS capacity are obtained.

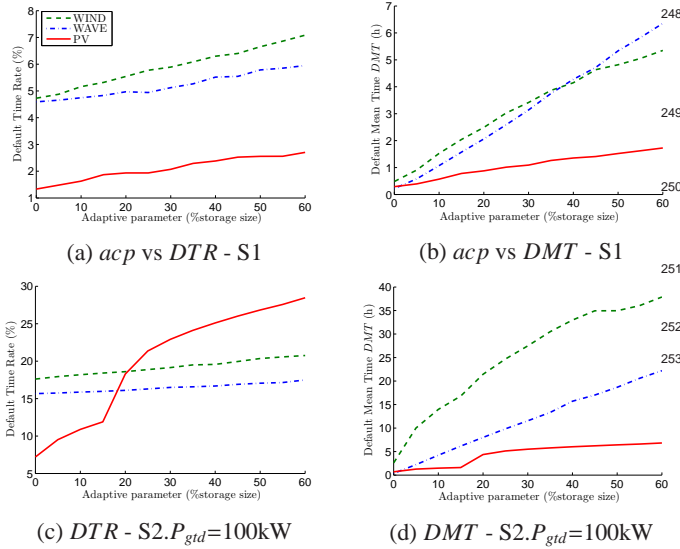

Figure 8: Comparison of adaptive charge strategies

With the adaptive charge, output energy is kept for charge as much as possible, although in some cases, there is no default, within and above the tolerance layer. The contribution of this strategy is clearly established as the DTR is divided by two or more. 5%- DTR capacities for all renewables are now feasible since they are lower than 2MWh/MWp.

In conclusion, the choice $acp = 20\%$ for adaptive charge offers for all renewables a good compromise between oscillations curtailment and an increase in DTR and thus required minimal ESS capacity. This optimization strategy is chosen as reference strategy for comparing renewables ESS sizing and corresponding energies or tariffs. This storage operation strategy can be applied by the supplier in operational conditions so as to comply with the service more efficiently.

3.4. Optimal Sizing

The optimized storage operation model presented in this paper, denoted as adaptive charge, aims at obtaining a lower DTR for a fixed ESS size and storage parameter base values while meeting the allowed maximal depth of discharge. This model gives also the corresponding supplied or lost energies and thus the feed-in-tariff for a 20-year storage payback. A feasible ESS sizing is first performed on the basis of tolerance.

For a fixed power level $factor$ and for each tolerance tol from 0 to 60% \bar{P}_{out} , the ESS size S is varying from 0 to 2000kWh/MWp to find the minimal feasible size that meets the service ($DTR \leq 5\%$).

Then the viable ESS sizing involves varying the power level $factor$ from 0.1 to 1.5 in order to find a viable solution (S^*, FIT^*). S^* is a feasible ESS size i.e. meeting the service with less than 2MWh/MWp and FIT^* is lower than 300 and 400€/MWh for S1 and S2 respectively. The associated $factor^*$ is the maximal multiplying factor on forecast for which at least one viable couple (S^*, FIT^*) is found. It corresponds to the maximal power that can be viably supplied to the grid.

4. Results and discussion

The results for S1 and S2 are summarized in Table 3.

4.1. Service S1

In this section, simulation results for hourly smoothing (S1) are presented.

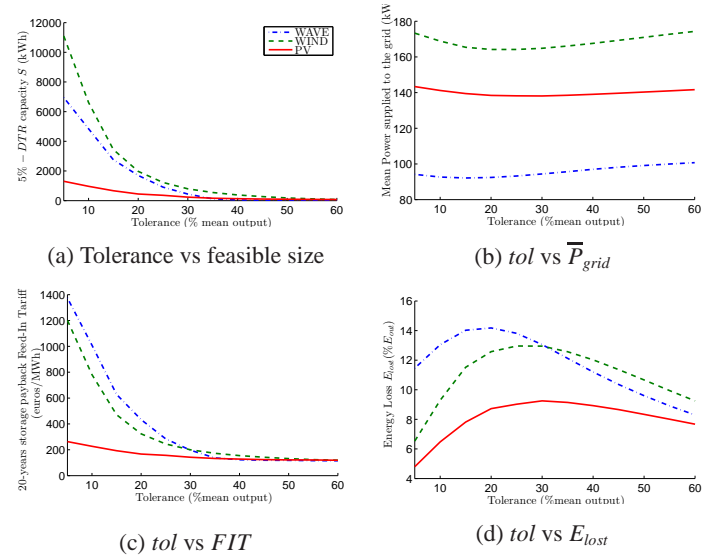

Figure 9: Storage sizing for hourly smoothing (S1.factor = 1).

The optimal capacity is the minimal capacity that meets the service with less than 5%- DTR . For service S1 with a PV power a DTR^{max} of 5% is measured during daylight hours as no service is provided overnight. Figure 9 shows a comparison of renewables storage sizing, corresponding energies and tariffs for hourly smoothing (S1) with 100% forecast i.e. $factor = 1$.

The mean power supplied to the grid \bar{P}_{grid} is around 85%-90% of the mean output. Tolerances lower than 20% of the mean output are unviable for wind or wave power. Within the 5 to 35% tolerance range, PV results are better in terms of capacity, energy lost and tariff required for a 20-year storage profitability. This comes from the fact that for PV power this

266 service operates as if it is restricted to output hours since no²⁹⁸
 267 energy is forecasted nor supplied overnight. Secondly, PV²⁹⁹
 268 power is by nature more day-ahead predictable [19] with the³⁰⁰
 269 higher output correlation (83%) from day to day (Table 1).³⁰¹

270 The bell curve of energy lost is due to the concurrence of³⁰²
 271 two phenomenas. On the one hand, increasing the tolerance³⁰³
 272 allows for more power output to be supplied. On the other³⁰⁴
 273 hand, adaptive charge tends to supply the lower bound $P_{bid} - tol$ ³⁰⁵
 274 to the grid. With high tolerance values the first phenomenon³⁰⁶
 275 prevails. As the storage cost is significant compared to the³⁰⁷
 276 potential revenues, the *FIT* for 20-year storage payback time is³⁰⁸
 277 very dependant on its capacity. At over 40% tolerance, required³⁰⁹
 278 capacities, 20-year storage payback *FIT* and energy parts tend
 279 to be very similar. This comes from the first aforementioned³¹⁰
 280 phenomenon where an increasing part of the output is directly³¹¹
 281 supplied to the grid. As the tolerance layer becomes larger the
 282 ESS is solicited less and has less impact with 80% and 20%
 283 ESS use time at 5% and 60% tolerance respectively.

284 To sum up, an hourly smoothing service (S1) could be
 285 achieved with 5%-*DTR* and 20% adaptive charge for wind
 286 or wave power only at tolerances greater than 25%. That
 287 represents 4.8% and 2.5% P_{inst} for wind and wave power
 288 respectively. However, PV power is well suited for this service,
 289 particularly with tolerances lower than 25%, that is 3.9% P_{inst} .
 290 The energies or mean powers supplied to the grid with storage
 291 are still ranked and bounded by the initial outputs.

292 4.2. Service S2

293 Optimization results for annual leveling service (S2) are³¹⁵
 294 presented in figure 10. It is clearly more difficult for all³¹⁶
 295 renewables to comply with this service as an important amount
 296 of energy is lost (35-70%).

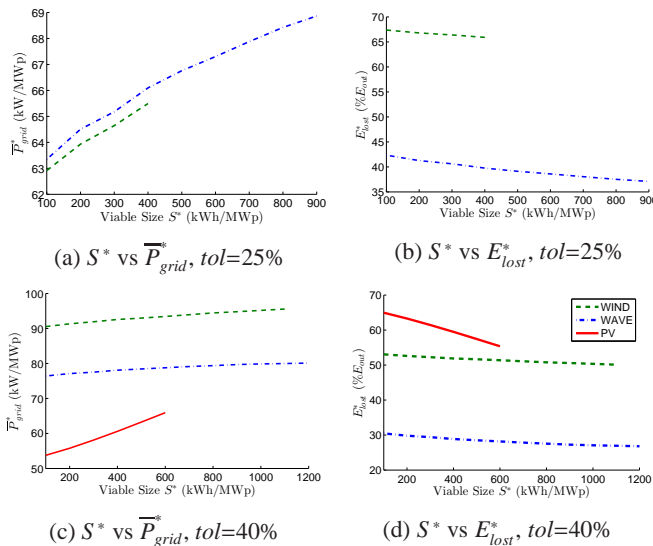

Figure 10: Viable storage sizing for annual leveling at 25 and 40%-tolerance

297 When decreasing *factor*, viable results can be found for

wave and wind power at 25% tolerance. However, the
 guaranteed power supplied is still low: less than 70kW. For
 service S2, viable capacities and FITs can be obtained with PV
 power only at higher tolerances greater than 30%.

The annual mean forecast (*factor* = 1) cannot feasibly be
 provided at a tolerance below 60% by any renewable source. In
 a general manner, energy losses are higher with annual leveling
 than with hourly smoothing. This can be easily explained since
 the guaranteed power P_{grid} is well below the mean output \bar{P}_{out} .
 PV power is not well suited for all-day constant power supply
 services like S2. With these services too large ESS capacities
 are needed and too much energy is lost.

With PV power, annual leveling service (S2) is more
 effective if limited to 9am-5pm as shown in figure 11.

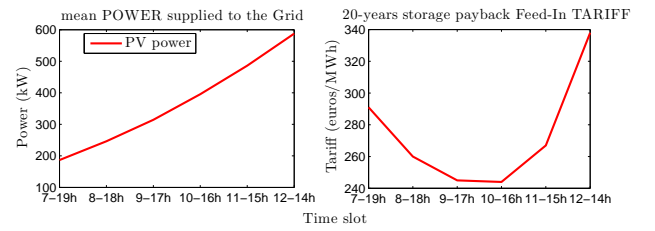

Figure 11: PV energy storage sizing with restricted service S2

312 During this time range, with 25% tolerance and 1000kWh
 313 ESS capacity, 314kW for S2, $factor = 1$, can be guaranteed all
 314 year long at 5%-*DTR*. Lower energy losses are also obtained
 with 22% of lost output energy.

The following conclusions on service S2 can be drawn :

- 317 • Feed-in tariffs *FIT* for a 20-year storage payback are very
 318 dependant on ESS capacities as initial costs are high.
- 319 • With low ESS capacities viable solutions can be found but
 320 only with low *factor* and power supplied to the grid. It may
 321 be sometimes worthless to consider larger ESS capacities as
 322 only an improvement of a few kW of power supplied to the
 323 grid is obtained, see figure 10(a) and (c) for an example.
- 324 • 100% annual mean forecast is viable at 25% tolerance for
 325 wind or wave power but not for PV power. With wave power
 326 the power supplied to the grid is much lower (70 vs 180kW)
 327 but with less energy loss and smaller ESS capacities.
- 328 • PV power is more suited to daylight hours services e.g.
 329 hourly forecast smoothing (S1) or annual leveling (S2)
 330 during [9am-5pm], especially with small tolerances.
- 331 • At 40% tolerance or more, viable capacities and FITs are
 332 possible for all renewables but the mean powers and thus
 333 energies supplied to the grid are still ranked by initial outputs.

334 4.3. Impact of forecast accuracy

As the annual guaranteed power with service S2 can be
 not based on the mean forecast but for instance on mean past
 outputs the influence of forecast accuracy is assessed with

the service S1. In order to compute the impact of forecast accuracy on sizing and feed-in-tariffs the hourly forecast error is multiplied by a factor $\alpha \geq 0$. Hence, the mean absolute error is also multiplied by α . The new forecast vector P_{f_α} is given by:

$$P_{f_\alpha} = (1 - \alpha)P_{out} + \alpha P_f \quad (14)$$

with P_{f_α} restricted to $[0; P_{inst}]$, so that $1-\alpha$ represents the forecast accuracy variation: positive for improvement and negative for reduction. The impact of the forecast accuracy on the techno-economic results for service S1 is shown in figure 12 for α in the range between 0.7 and 1.3.

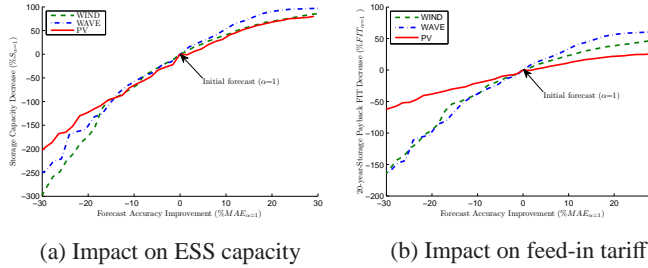

Figure 12: Impact of forecast accuracy for service S1

A high impact of forecast accuracy is noted for all renewables since 5% forecast accuracy improvement gives an optimal ESS capacity decrease of 22.3%, 28.3%, 13.2% and 12.5%, 17.9%, 4.4% -FIT reduction for wind, wave, PV power, respectively. Forecast accuracy reduction yields more impact than its improvement with for example a required ESS capacity tripled or more for 30% -MAE increase. It is thus important to realise that if the forecast quality is not taken into account, then the proposed sizing solution may not be worthwhile from an operational viewpoint.

Table 3: Viable results for services S1 and S2

Service / Renewables	tol ($\% \bar{P}_{out}$)	\bar{P}_{grid} (kW)	$factor^*$ (%forecast)	S^* (kWh)	E_{lost}^* ($\% E_{out}$)
Service S1 ($FIT^* \leq 300\text{€}/\text{MWh}$)					
Wind	25	167.2	104	1800	11.7
Wind	40	175.9	118	1900	6.3
Wave	25	93.1	99	900	13.9
Wave	40	98.2	111	1000	9.2
PV	25	146	112	1600	2.7
PV	40	146.3	118	1600	2.4
Service S2 ($FIT^* \leq 400\text{€}/\text{MWh}$)					
Wind	25	65.5	29	400	65.9
Wind	40	95.6	49	1100	50.1
Wind	60	124.8	71	1700	34.8
Wave	25	68.9	61	900	37.1
Wave	40	80.1	78	1200	26.8
Wave	60	88.6	100	1400	19.1
PV	25	No	viable	solution	-
PV	40	65.9	58	600	55.4
PV	60	99.5	100	1400	31.0

5. Conclusion

In order to improve the penetration of renewables into the electricity grid with respect to two specific services, an optimal viable storage sizing is performed in this study. The viable domain is defined so as to ensure a bounded ESS capacity and a not too high feed-in-tariff for a 20-year storage profitability. PV power is more efficient if restricted to daylight hours, particularly at tolerances lower than $25\% \bar{P}_{out}$. This is the case for S1 with 112% of the hourly forecast where 146kW on average can be annual guaranteed during evening peak. For not restricted S2 wind and wave power are more suitable than PV. Guaranteed power above 100kW can be feasibly supplied only with wind power but at higher tolerance (60%) and huge output energy loss (35% E_{out}). Besides, energy losses below 20% can be attained only with wave power but with a lower supply of 89kW. With hourly restricted S2, 314kW can be guaranteed with PV power all year long during 9am-5pm time range. For S1 forecast accuracy is a key factor of storage sizing. Tolerance on power supply and power level factor have also a huge impact on optimal size, energies and FIT. So as to increase the energy injected into the grid meeting the service, particularly during peak hours, and reduce energy losses, combination of the two services can be an interesting way.

Acknowledgements

This work was completed in the framework of french "Enerstock" project. The authors would like to thank Quadran company for providing their data of production and forecasting.

References

- [1] International energy storage database (2012). URL <http://www.energystorageexchange.org/projects>
- [2] J. Bernal-Agustín, R. Dufo-López, Simulation and optimization of stand-alone hybrid renewable energy systems, Renewable and Sustainable Energy Reviews 13 (2009) 2111–2118.
- [3] T. Ma, Y. Hongxing, L. Lu, Feasibility study and economic analysis of pumped hydro storage and battery storage for a renewable energy powered island, Energy Conversion and Management 79 (2014) 387–397.
- [4] O. Erdinc, M. Uzunoglu, Optimum design of hybrid renewable energy systems: Overview of different approaches, Renewable and Sustainable Energy Reviews 16 (2012) 1412–1425.
- [5] S. Diaf, G. Notton, M. Belhamel, M. Haddadi, A. Louche, Design and techno-economical optimization for hybrid pv/wind system under various meteorological conditions, Applied Energy 85 (2008) 967–987.
- [6] D. Connolly, H. Lund, B. Mathiesen, M. Leahy, A review of computer tools for analysing the integration of renewable energy into various energy systems, Applied Energy 87 (2010) 1059–1082.
- [7] E. Koutroulis, D. Kolokotsa, A. Potirakis, K. Kalaitzakis, Methodology for optimal sizing of stand-alone photovoltaic/wind-generator systems using genetic algorithms, Solar Energy 80 (2006) 1072–1088.
- [8] R. Luna-Rubio, M. Trejo-Pereab, D. Vargas-Vzquez, G. Ros-Moreno, Optimal sizing of renewable hybrids energy systems: A review of methodologies, Solar energy 86 (2012) 1077–1088.
- [9] E. Kaplani, S. Kaplanis, A stochastic simulation model for reliable pv system sizing providing for solar radiation fluctuations, Applied Energy 97 (2012) 970–981.

- 404 [10] Y. Yuan, Q. Li, W. Wang, Optimal operation strategy of energy storage
405 applied in wind power integration based on stochastic programming, *IET*
406 *Renewable Power Generation* 5(2) (2011) 194–201.
- 407 [11] D. Lefevre, C. Guilbaud, Hybrid energy storage for renewable energy
408 insertion into island grids, in: *Proceedings of SHF conference*, 2011.
- 409 [12] H. Yang, W. Zhou, L. Lu, Z. Fang, Optimal sizing method for stand-alone
410 hybrid solarwind system with lpsp technology by using genetic algorithm,
411 *Solar Energy* 82 (2008) 354–367.
- 412 [13] Y. Ru, J. Kleissl, S. Martinez, Exact sizing of battery capacity for
413 photovoltaic systems, *European Journal of Control* 20 (2013) 24–37.
- 414 [14] L. Bridier, M. David, P. Lauret, Optimal design of a storage system
415 coupled with intermittent renewables, *Renewable Energy* 67 (2014) 2–9.
- 416 [15] W. Short, D. J. Packey, T. Holt, *A Manual for the Economic Evaluation*
417 *of Energy Efficiency and Renewable Energy Technologies*, Tech. Rep.
418 NREL/TP-462-5173, National Renewable Energy Laboratory (March
419 1995).
- 420 [16] M. O’Connor, T. Lewis, G. Dalton, Techno-economic performance of
421 the Pelamis P1 and Wavestar at different ratings and various locations
422 in Europe, *Renewable Energy* 50 (2013) 889–900.
- 423 [17] T. E. Hoff, R. Perez, J. Kleissl, D. H. Renne, J. S. Stein, Reporting of
424 irradiance modeling relative prediction errors, *Prog Photovolt Res Appl*,
425 *American Solar Energy Society* 21(7) (2013) 1514–1519.
- 426 [18] D. Hernandez-Torres, L. Bridier, M. David, P. Lauret, T. Ardiale,
427 Technico-economical analysis of a hybrid wave powerair compression
428 storage system, *Renewable Energy* 74 (2015) 708–717.
- 429 [19] J. Zhang, B.-M. Hodge, A. Florita, Investigating the correlation between
430 wind and solar power forecast errors in the western interconnection, in:
431 *ASME 7th International Conference on Energy Sustainability and the*
432 *11th Fuel Cell Science, Engineering, and Technology Conference*, 2013.