



HAL
open science

Characterization of a needle-type giant magnetoresistance sensor for detection of *Escherichia coli*'s magnetic marker

Hamidreza Shirzadfar, Mustapha Nadi, Djilali Kourtiche, Sotoshi Yamada,
Payman Shahabi

► To cite this version:

Hamidreza Shirzadfar, Mustapha Nadi, Djilali Kourtiche, Sotoshi Yamada, Payman Shahabi. Characterization of a needle-type giant magnetoresistance sensor for detection of *Escherichia coli*'s magnetic marker. *International Journal on Smart Sensing and Intelligent Systems*, 2015, 8 (1), pp.220-234. hal-01293433

HAL Id: hal-01293433

<https://hal.science/hal-01293433>

Submitted on 8 Dec 2016

HAL is a multi-disciplinary open access archive for the deposit and dissemination of scientific research documents, whether they are published or not. The documents may come from teaching and research institutions in France or abroad, or from public or private research centers.

L'archive ouverte pluridisciplinaire **HAL**, est destinée au dépôt et à la diffusion de documents scientifiques de niveau recherche, publiés ou non, émanant des établissements d'enseignement et de recherche français ou étrangers, des laboratoires publics ou privés.



CHARACTERIZATION OF A NEEDLE-TYPE GIANT MAGNETORESISTANCE SENSOR FOR DETECTION OF ESCHERICHIA COLI'S MAGNETIC MARKER

Hamidreza Shirzadfar^{1*}, Mustapha Nadi¹, Djilali Kourtiche¹, Sotoshi Yamada² and Payman Shahabi³

1. Institut Jean Lamour, CNRS, UMR 7198, Université de Lorraine,

Vandœuvre-lès-Nancy, France

2. Institute of Nature and Environmental Technology, Kanazawa University,

Kanazawa 920-1192, Japan

3. Centre de Pharmacogénomique, Institute de Cardiologie de Montréal,

Université de Montréal, Montréal, QC H1T 1C8 Canada

Email: h.shirzadfar@gmail.com

Submitted: Nov. 3, 2014

Accepted: Jan. 11, 2015

Published: Mar. 1, 2015

Abstract- In the recent years, the introduction and development of simple and portable sensors has been the focus of researchers in nearly all scientific domains, particularly in the biomedical settings.

Giant magnetoresistance (GMR) provides a cutting-edge sensor technology. The GMR-based sensors are capable to affordably and sensitively detect and quantify micro- and nano-magnetic particles, even in very weak magnetic fields.

In this paper, we introduce a highly sensitive needle-type GMR-based sensor, designed for the identification and quantification of Escherichia coli O157:H7 bacteria covered by superparamagnetic beads, Dynabeads® MAX E.coli O157. The sensor characteristics, measurement system setup and the properties of the magnetic marker solution are discussed in detail.

Index terms: Giant magnetoresistance (GMR) sensor, Escherichia coli O157:H7, magnetic marker, sensor sensitivity, magnetic fluid weight density, magnetic field.

I. INTRODUCTION

Escherichia coli (*E. coli*) is a rod-shaped Gram-negative, facultative anaerobic bacterium of the genus *Escherichia* and is commonly found in the gut of human and warm-blooded animals [1]. As a part of the intestinal flora, the majority of *E. coli* strains are harmless and can provide advantages to their hosts by synthesizing appreciable amounts of vitamin K [2], and also suppressing colonization of the intestine with pathogenic bacteria [3, 4]. However, a few number of *E. coli* serotypes, such as O157:H7 are capable of causing human illness. *E. coli* O157:H7 is a food- and water-borne infectious pathogen causing diarrhea, hemorrhagic colitis and hemolytic uremic syndrome that leads, in some cases, to severe complications, even death [5]. Accordingly, a timely diagnosis and consequently an effective treatment, is essential.

In line with the promotion of the lab on a chip (LOC) concept, in which one or multiple diagnostic techniques are integrated into a simple and ambulatory device, a considerable amount of efforts have directed in recent years toward the development of rapid and reliable approaches of detection and qualification of specific infectious pathogens including *E. coli* O157:H7 [6]. In this regards, immunomagnetic sensors have provided an emerging and promising approach in which *E. coli* antigens are captured with specific antibody-coated magnetic particles and small magnetic field variations, caused by the presence of superparamagnetic beads bound to the antigens, are detected and quantified by a magnetic sensor [7].

Among different kinds of magnetic sensors, such as Hall sensors or GMI devices, a multilayered giant magnetoresistance (GMR) has been shown to have the greatest potential for success in the biological samples [8-11] and in cancer treatment [12]. Briefly, GMR refers to a large change, in general a reduction, in resistance (typically 10 to 20%) when the devices are subjected to a magnetic field composed of alternating ferromagnetic and nonmagnetic layers [13]. The GMRs have high magnetic properties and, thereby, possess high sensitivity at low magnetic field which makes them the most likely to be selected as the next generation magnetic field sensing devices.

Here, we introduce a novel GMR-based sensor that has been designed and fabricated for the detection of *E. coli* O157:H7 using superparamagnetic particles, Dynabeads® MAX *E. coli* O157.

II. MATERIALS AND METHODS

2.1. Needle type magnetoresistive sensor

The bio-magnetic sensor consists of two main parts, i.e:

- Two sensing elements (GMRs) located in a mini chip and are placed on a 30-mm length needle,
- A Wheatstone half bridge configuration.

Wheatstone half bridge configuration allows measuring the variation of voltage induced by the magnetic field with removing DC voltage part of GMR polarization of the measuring bridge. The GMR sensor schematic and its components are presented in figure 1.

The sensor's needle is injected into the magnetic cavity containing the magnetic fluid where, its physical properties are measured. The sensing direction of the GMR sensor is parallel to the needle, the characteristic that is important to create an external magnetic field. The maximum allowable current of the GMR sensor is 5 mA.

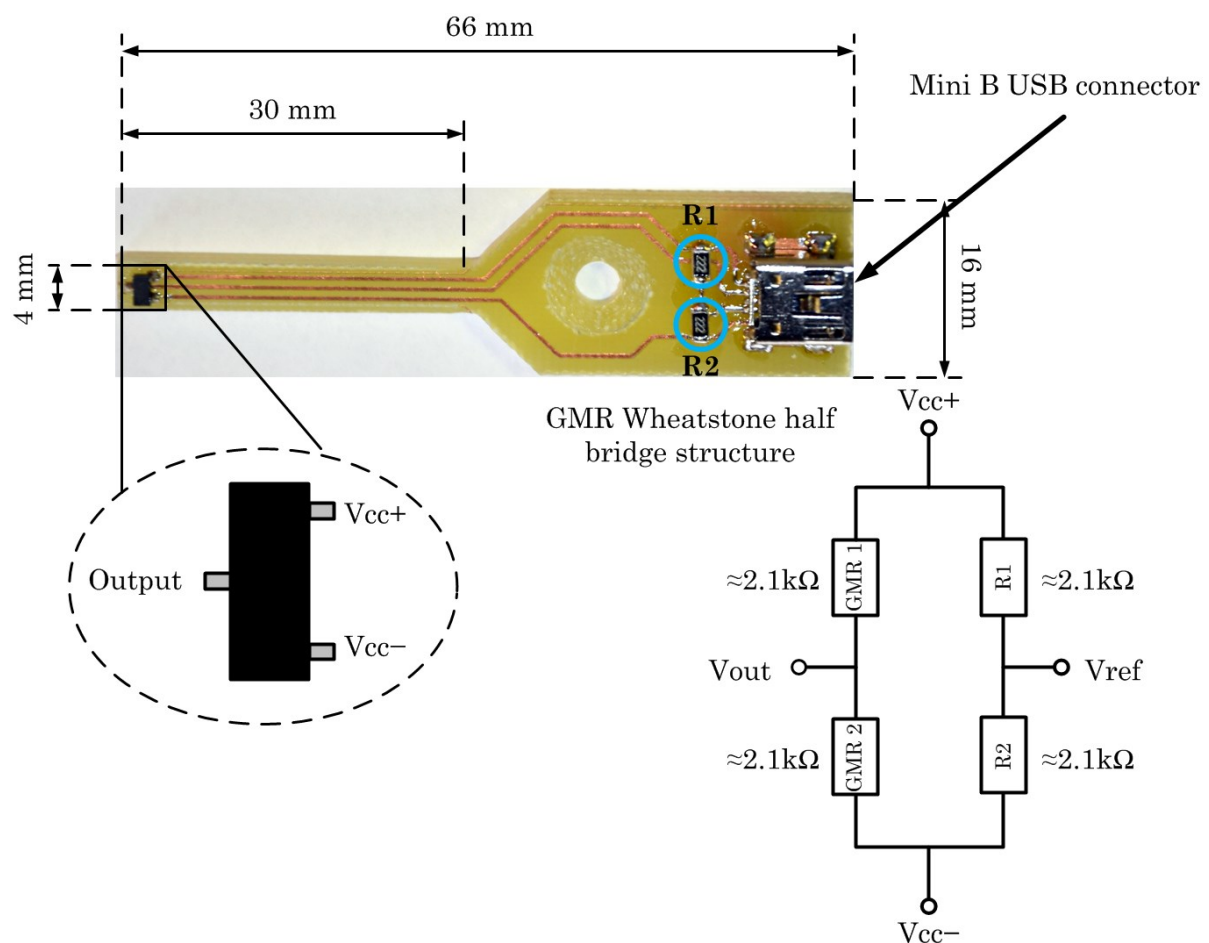

Figure 1. Design and details of GMR sensor

2.2. Dynabeads marker and sample preparation

Through the use of superparamagnetic spherical particles which are uniform in size, Dynabeads® MAX E. Coli O157, selectively capture and concentrates E.coli O157:H7 in food, feces, water and other environmental samples. By applying a magnetic field, the technology provides a powerful sample preparation method which improves rapidly detection and quantification of this organism. In figure 2, a few the magnetic particles are illustrated using an optical microscope with focusing objective 1000x.

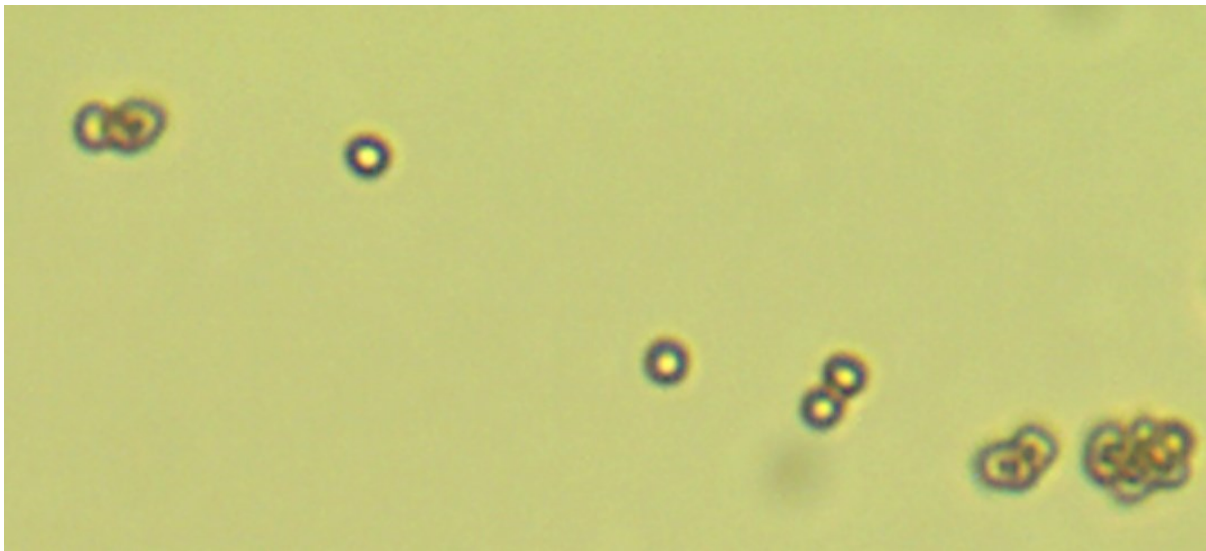

Figure 2. The microscopic image of Dynabeads particles

In order to be able to measure the magnetic parameters, such as relative permeability and susceptibility, in various concentrations, in this study we diluted the Dynabeads liquid with 10X buffer to obtain four concentrations: 1:1, 1:4, 1:8 and 1:16. In each value, the first and second digits represent the amount of Dynabeads solution and the value of mixed buffer, respectively. The micro pipette was used to reduce the amount of mixing errors.

2.3. Experimental setup and measurement conditions

The major parts of the final setup are as below:

- GMR sensor: to detect the magnetic particles.
- HF2IS Impedance Spectroscopy: to detect and measure the amplitude and phase of very weak AC signals and to also discriminate between the signal and noise. The HF2IS Impedance Spectroscopy can be used as impedance spectroscopy or lock-in amplifier.

- Helmholtz coil: to produce a uniform external magnetic field. The Helmholtz coil which was designed for this experiment consists of a pair of circular coils of 12 turns. The circular coils are 52 cm in diameter and are separated by a distance equivalent to the radius of one coil.
- Displacement system: that is adapted for two axes (X and Y) of the Helmholtz coil, according to the direction of sensing axis of each sensor. It also permits to protect the needle against any shock and to reduce the percentage of error during the needle positioning in the center of sample's cavity. The displacement system is controlled by a controller which allows backing up of the preset position using specific software. It is supported with a 220V-AC to 24V-DC convertor. An inappropriate distance between the displacement system and the coil center can interrupt the uniformity of the magnetic field. Therefore, the distance was calculated accurately using the finite element analysis as previously described [14].
- Cylindrical shape cavity: that is fabricated from Polydimethylsiloxane (PDMS) substance to accommodate the magnetic liquid. It should be noted that the aspect ratio (S), i.e. the proportional relationship between the length of the cylindrical container and its diameter (height/diameter), and N, i.e. demagnetizing factors which in turn depends on S, are important elements for calculating the magnetic parameters and both are determined by the shape and size of the cavity [15]. Accordingly, the structural characteristics of the cavity, including size and shape, are crucial parameters and need a special attention.

The GMR sensor was connected to a DC power supply ranging ± 6 V via a circuit interface and through a USB-A to mini B-USB cable. The output signals from the GMR sensor were supplied to the HF2IS Impedance Spectroscope where they were detected and recorded with an interface program of the Impedance Spectroscope.

Helmholtz coil is supported by a variable gain amplifier through a step down transformer. The experiment frequency of the Helmholtz coil is 75 Hz, the input voltage generated by the HF2IS Impedance Spectroscope is 350 mV and the value of magnetic flux density (B) at the center of Helmholtz coil, measured by 3D gauss/teslameter, is 212 μ T.

The wire connections of the GMR sensor are protected against humidity and external environmental influences by an electrolube; however, at the first test and when the needle of sensor was injected in the cavity of Dynabeads fluid, the connection systems were destroyed.

The reason was the presence of a corrosive material which was dissolved in the Dynabeads solution. Afterward, all the wire connections and the mini chip of the sensor have been guarded by several layers of PDMS substance. PDMS was selected for two main reasons. First, it is biocompatible and highly resistance to corrosive effects. The second reason is that in the PDMS cavity, containing Dynabeads solution, no structural changes and deformations were made.

After the sensor isolation, the GMR sensor's needle was located at the center of the Helmholtz coil via the displacement system. In order to be registered, the V_{out} - V_{ref} signal of the sensor was supplied directly to HF2IS Impedance Spectroscopy. First, the output data (V_{rms} and phase) was recorded without influencing by the magnetic marker (only air). Next, 350 μ L of pure Dynabeads solution was poured by a micro pipette into the 8 \times 8 mm cavity and was placed in the center of coils to record its data. This process was repeated for the other concentrations (1:4, 1:8 and 1:16). The output results for each sample were recorded 3 \times 64 times, according to the interface program of the HF2IS. In order to reduce the percentage of testing errors, the PDMS cavity and the needle's insulation layers, were cleaned very accurately with distilled water and dehumidified with a soft sponge. Additionally, two laptops, one for steering the displacement system and another for recording the data and controlling the HF2IS impedance spectroscopy, were employed in this experimental setup. The measurement setup used for the detection of the Dynabeads fluids and also the estimation of their magnetic properties is depicted in figure 3.

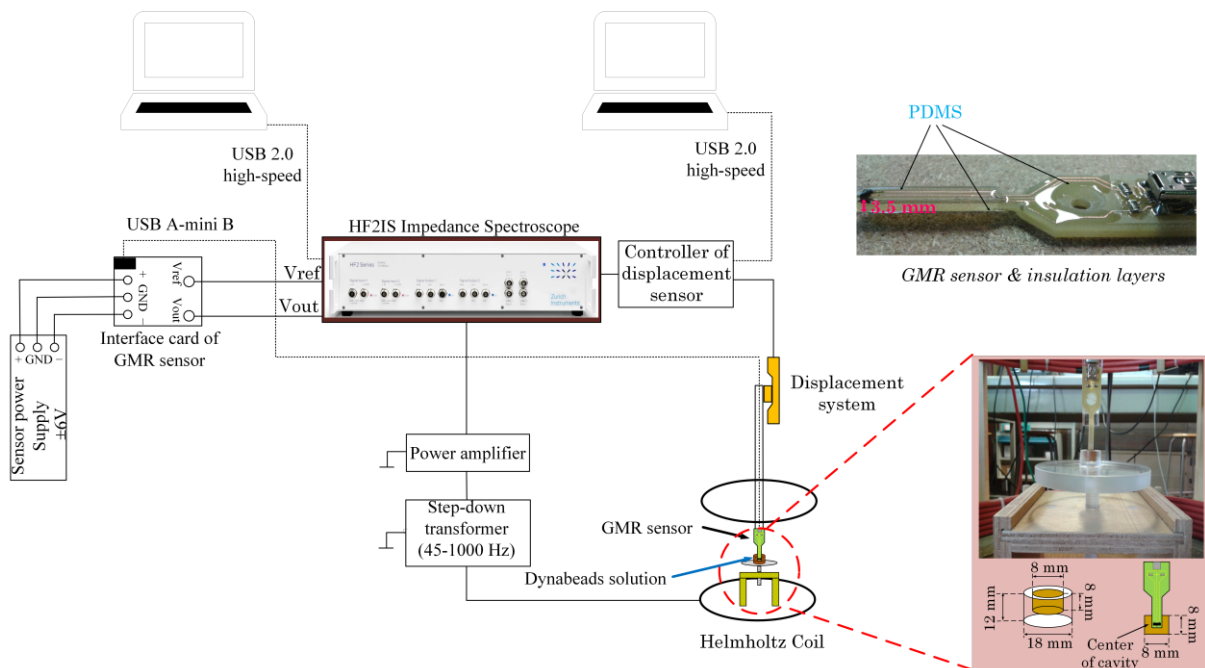

Figure 3. Measurement setup of GMR sensor

III. RESULTS AND DISCUSSION

3.1. GMR sensor characterization

3.1.1. Determination of GMR sensor sensitivity

Sensitivity is an extremely important parameter of sensors, including the magnetic sensors. For instance, the magnetic sensors are classified according to how sensitive they are for detecting the magnetic fields [16].

In order to determine the GMR sensor's sensitivity, the employed setup was similar to that is shown in figure 3. The magnetic flux density (B) was increased from approximately $3 \mu\text{T}$ to $600 \mu\text{T}$, and the frequency was fixed at 75 Hz . The output voltage obtained by the GMR sensor in various magnetic flux density values, are shown in figure 4, showing that the output voltage values follow a liner pattern and are proportional to the values of the magnetic flux density. The sensitivity obtained for this sensor was as high as $245 \mu\text{V}/\mu\text{T}$ (with magnetic flux density $\approx 296 \mu\text{T}$).

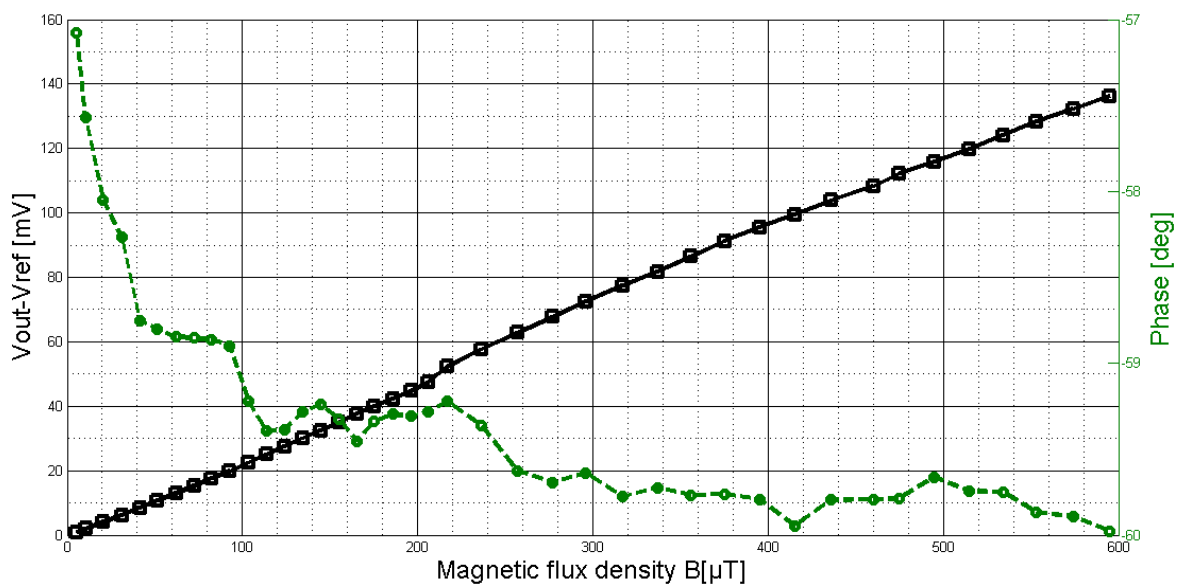

Figure 4. Experiments for obtaining the maximum sensitivity of GMR sensor

3.1.2. Variation of R in Wheatstone bridge of GMR sensor

As mentioned earlier, the GMR sensor consists of two sensing elements, located inside a mini chip at the needle tip. The sensing elements are connected to the Wheatstone half bridge of the GMR sensor. The sensor configuration can be figured out by considering $\Delta R+R$ and $\Delta R-R$ as comprising two sections of a linear potentiometer. $\Delta R+R$ and $\Delta R-R$ both are dependent on the direction of magnetic field, meaning that according to the magnetic field

direction, the variation of R for $\Delta R + R$ and $\Delta R - R$ is increased and decreased, respectively, when the sensing element is located along with the direction of magnetic field. Figure 5 depicts a simplified connection schematic of the GMR sensor.

The output signal ($V_{out} - V_{ref}$) of the GMR sensor can be determined by this equation:

$$V_{out} - V_{ref} = \left(\frac{V_{supply}}{2} + \frac{V_{supply} \times \Delta R}{2R} \right) - \frac{V_{supply}}{2} \quad (1)$$

In addition, the change of resistance in the Wheatstone bridge of the GMR sensor, after removing the DC component by the HF2IS Impedance Spectroscopy, can be written as the following expression:

$$\Delta R = \frac{(V_{out} - V_{ref}) \times 2R}{V_{supply}} \quad (2)$$

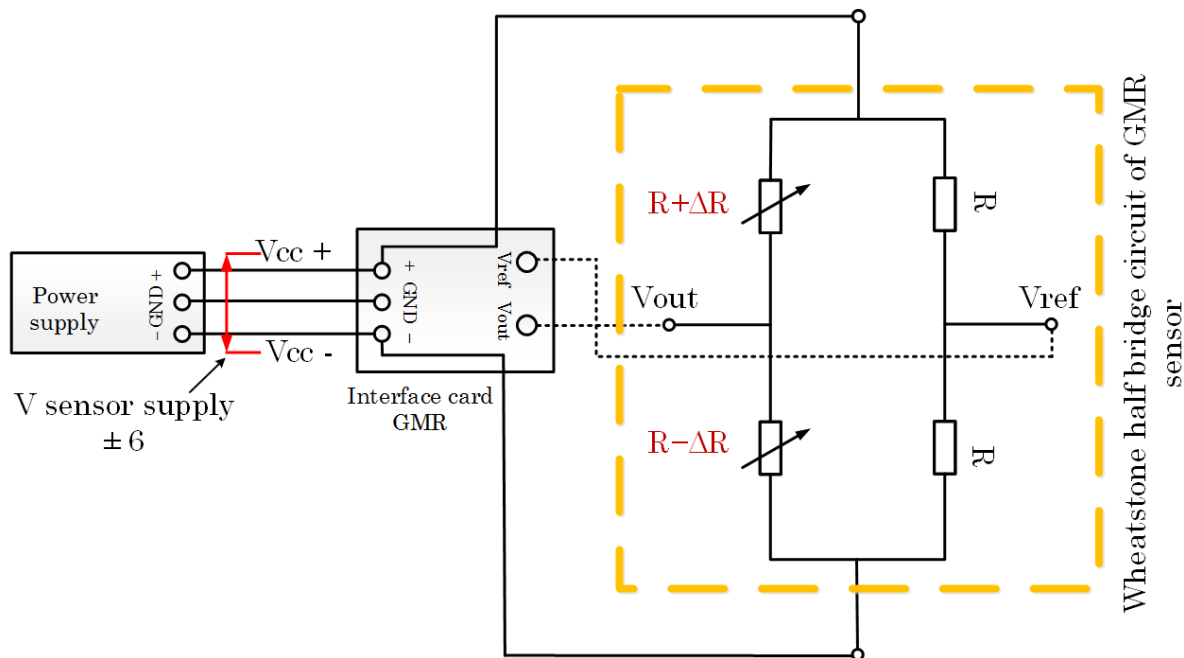

Figure 5. Overview of electrical connections and Wheatstone half bridge of GMR sensor

Figure 6 shows that ΔR values are proportional to the changes in the values of magnetic flux densities. Furthermore, the GMR sensing element sensitivity was calculated to be approximately $4\% \text{ mT}^{-1}$, using $(\Delta R/R)/B$; where B represents magnetic flux density.

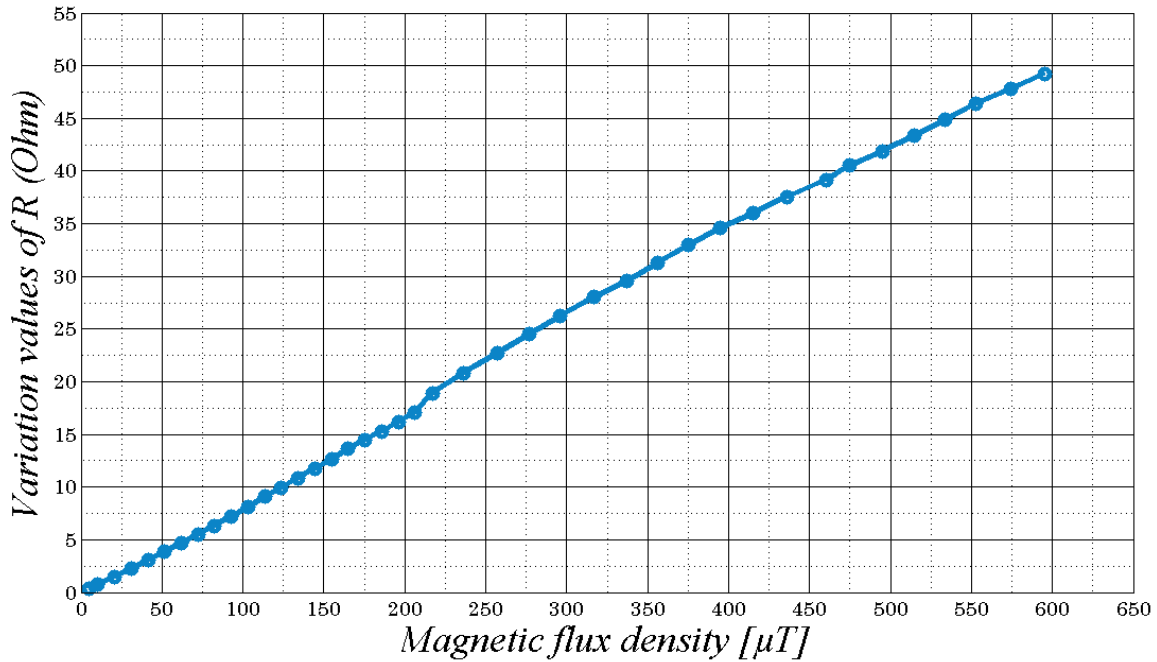

Figure 4. Variation of resistance of sensing elements according to changes of magnetic flux density

3.2. Characteristics of Dynabeads solution

The relative permeability (μ_r) and the magnetic susceptibility (χ) of the Dynabeads® MAX E.coli O157 solution at different magnetic fluid weight densities (D_w), i.e. various concentrations (1:1, 1:4, 1:8, 1:16), were determined by the following expressions [15] and the results are illustrated in figure 7 (a) and figure 7 (b), respectively.

$$\mu_r = \chi + 1 \quad (3)$$

$$\chi = \frac{(B_1 - B_0)}{B_0} \frac{1}{(1 - N)} \quad (4)$$

In the equation (4), B_0 and B_1 are the magnetic flux density outside and inside the cavity, respectively. The magnetic characterization of Dynabeads was completed by using the cavity with dimension 8×8 mm ($S = 1$ and $N = 0.333$).

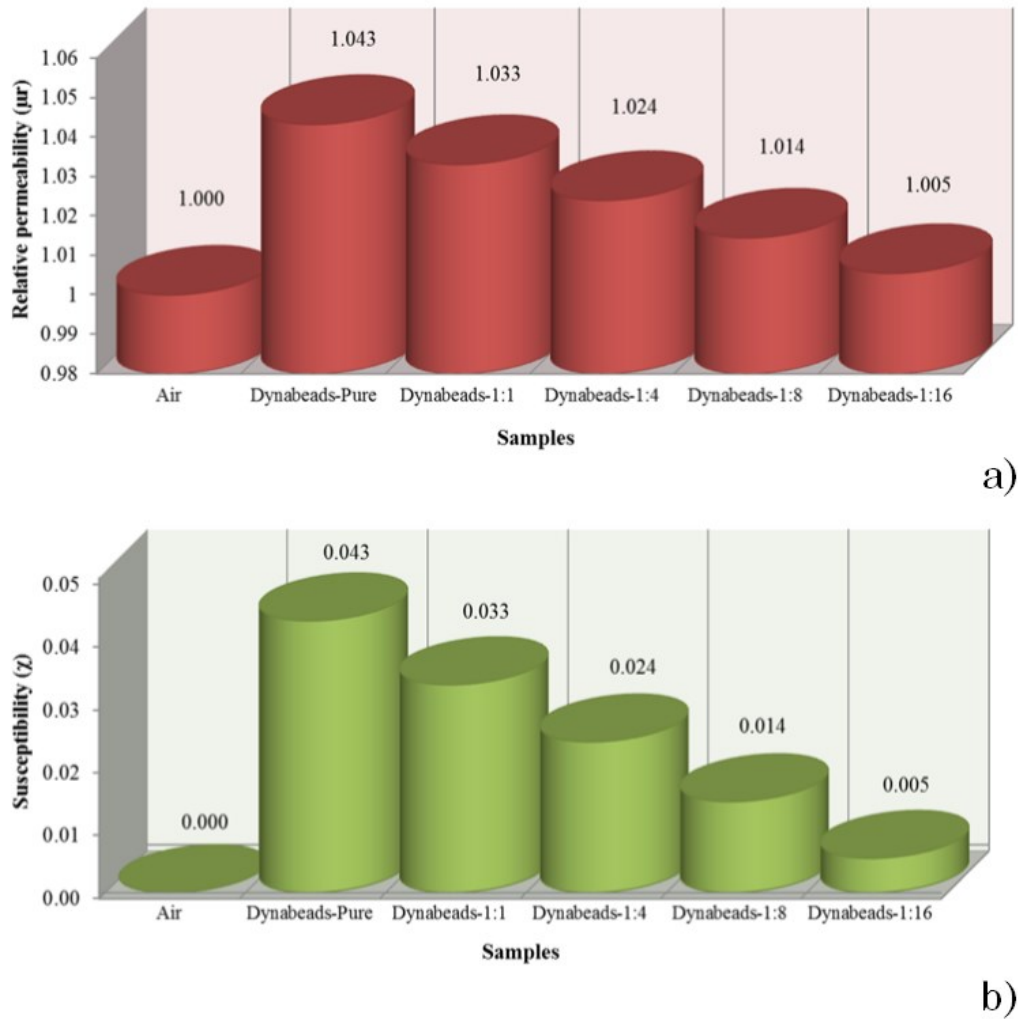

Figure 7. Relative permeability (a) and susceptibility (b) of Dynabeads solution at different concentrations

3.3. Output signal in spherical cavities of different size

This part of the experiment was performed to investigate whether there is a relationship between the GMR sensor output signals and the sizes of containers and the magnetic fluid weight density. For that, four PDMS containers as well as four Teflon and Nylon molds were fabricated to obtain cavities with different aspect ratios ($S= 1, 2$) and demagnetizing factors ($N= 0.333, 0.172$) (figure 8).

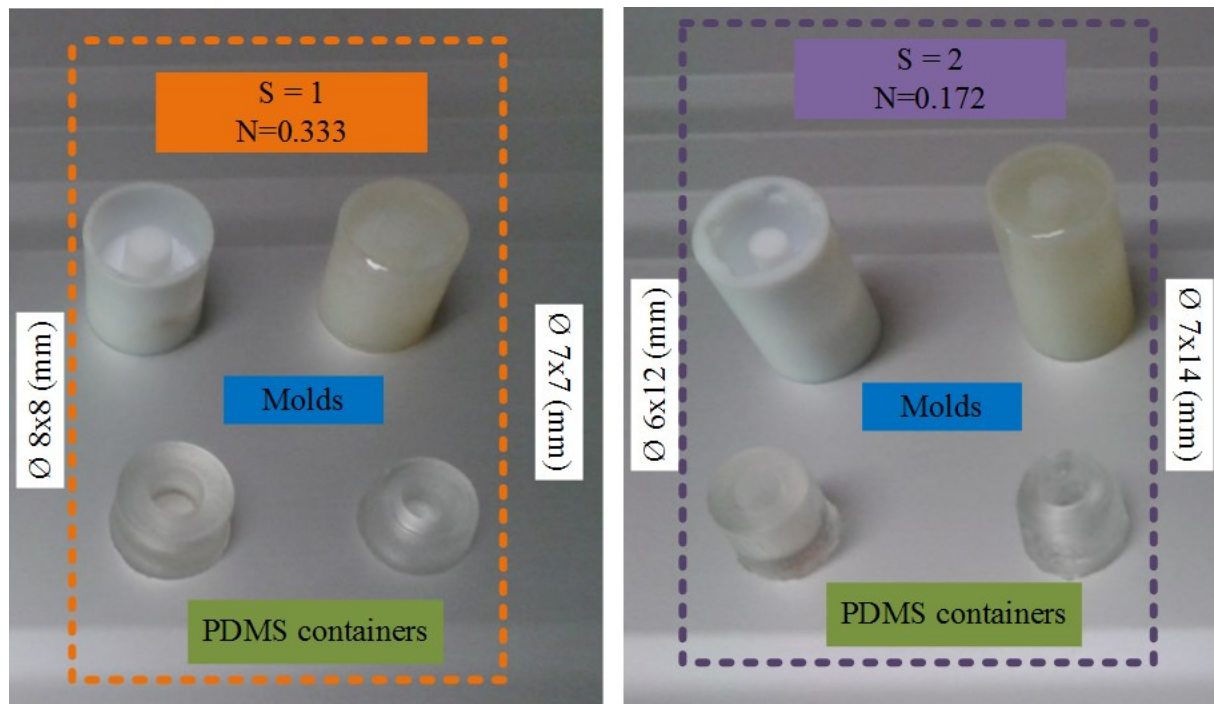
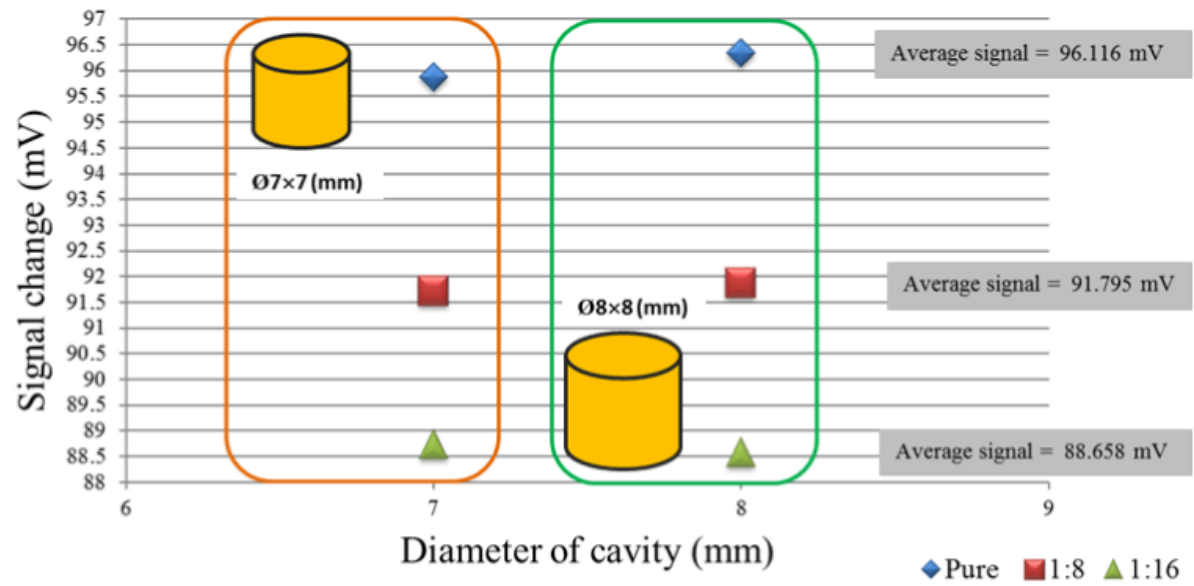

Figure 8. Four models of different sizes were fabricated from molds and PDMS to see if change in size of cavity is associated with output signal variation

Using a micropipette, the cylindrical cavities of various dimensions (8×8 mm, 7×7 mm, 6×12 mm and 7×14 mm) were filled with the Dynabeads solution of three concentrations (1:1, 1:8 and 1:16) and were placed in the center of Helmholtz coil where the magnetic flux density was more uniform and equal to 400 μT . The Helmholtz coil frequency was set at 75 Hz and the coil was fed 690 mV through the HF2IS Impedance. Finally, the GMR sensor was placed into the container, thanks to a displacement system. The sensor and the cavities were cleaned and dehumidified with distilled water and a sponge at the end of each test.

The associations between the output signals (mV), obtained by the GMR sensor, and the size of cavities and the various weight densities are shown in figure 9. The results indicate that, at a given concentration of the solution, comparable signals are achieved from the cavities with similar structural parameters (size, N and S) and that increasing the weight density of the solution is associated with a proportional increase in the output signals. Our findings are consistent with those observed by Yamada et al. [17-22] demonstrating that the output signals detected by the GMR sensor are dependent both to the cavity structure and the solution concentration.



a)

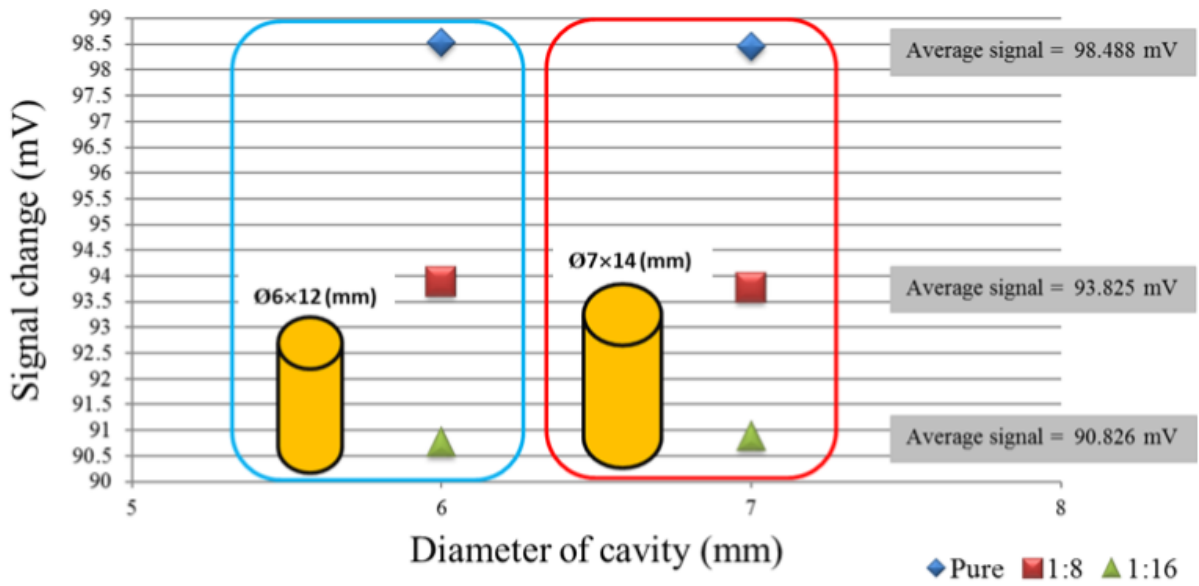

b)

Figure 9. Output signals detected from cavities with various structural parameters (S and N); S = 1, N = 0.333 (a) and S = 2, N = 0.172 (b) and different magnetic fluid weight densities (1:1, 1:8 and 1:16)

IV. SUMMARY

This paper introduces a novel highly susceptible needle-type GMR sensor which has potential to detect the micro- or nano-magnetic particles and to determine their major magnetic properties such as the susceptibility and the relative permeability. The GMR sensor was designed to detect and quantify rapidly E.coli O157:H7 bacteria coated by magnetic particles from the contaminated environments. In this experiment, Dynabeads® MAX E.coli O157 solution was used as the source of the magnetic particles.

Here, we have reported a method by which the maximum sensitivity of a sensor can be achieved and the ΔR variation of the sensing element in the Wheatstone half bridge of the GMR sensor can be calculated. Also, a part of the experiment was dedicated to the determination of the characteristics of the Dynabeads solution including χ and μ_r which showed that there exists a proportional relationship between χ , μ_r and D_w . Finally, we could demonstrate that the output signals detected by the GMR sensor are dependent to the aspect ratios (S) and demagnetizing factors (N) of the sensor cavities and also to the concentration of the Dynabeads solution used in the experiment.

Further studies are needed to employ the GMR sensor for the detection of E.coli O157:H7 in the real biological settings.

REFERENCES

- [1] P. Singleton, "Bacteria in Biology," in *Biotechnology and Medicine* ed: Wiley, 1999, pp. 444-454.
- [2] R. Bentley and R. Meganathan, "Biosynthesis of vitamin K (menaquinone) in bacteria," *Microbiological reviews*, vol. 46, p. 241, 1982.
- [3] S. Hudault, J. Guignot, and A. Servin, "Escherichia coli strains colonising the gastrointestinal tract protect germfree mice against Salmonella typhimurium infection," *Gut*, vol. 49, pp. 47-55, 2001.
- [4] G. Reid, J. Howard, and B. S. Gan, "Can bacterial interference prevent infection?," *Trends in microbiology*, vol. 9, pp. 424-428, 2001.
- [5] W. W. Lathem, T. Bergsbaken, S. E. Witowski, N. T. Perna, and R. A. Welch, "Acquisition of stcE a C1 esterase inhibitor-specific metalloprotease, during the evolution of Escherichia coli O157: H7," *Journal of Infectious Diseases*, vol. 187, pp. 1907-1914, 2003.
- [6] M. Mujika, S. Arana, E. Castano, M. Tijero, R. Vilares, J. Ruano-Lopez, A. Cruz, L. Sainz, and J. Berganza, "Magnetoresistive immunosensor for the detection of Escherichia coli

O157:H7 including a microfluidic network," *Biosensors and Bioelectronics*, vol. 24, pp. 1253-1258, 2009.

[7] E. Morandi, C. Grassi, P. Cellerino, P. P. Massara, F. Corsi, and E. Trabucchi, "Verocytotoxin-producing *Escherichia coli* EH 0157: H7 colitis," *Journal of clinical gastroenterology*, vol. 36, pp. 44-46, 2003.

[8] D. Graham, H. Ferreira, P. Freitas, and J. Cabral, "High sensitivity detection of molecular recognition using magnetically labelled biomolecules and magnetoresistive sensors," *Biosensors and Bioelectronics*, vol. 18, pp. 483-488, 2003.

[9] J. Rife, M. Miller, P. Sheehan, C. Tamanaha, M. Tondra, and L. Whitman, "Design and performance of GMR sensors for the detection of magnetic microbeads in biosensors," *Sensors and Actuators A: Physical*, vol. 107, pp. 209-218, 2003.

[10] R. Haraszczuk, M. Kakikawa, T. Ueno, S. Yamada and M. Nadi "Spectroscopic Susceptibility Measurements of Magnetic Markers by SV-GMR Needle Probe", *Journal of the Magnetism Society of Japan*, vol 35, pp. 157-162, 2011.

[11] C. Reig, S. Cardoso and S.C. Mukhopadhyay "Giant Magnetoresistance (GMR) Sensors" Springer Berlin Heidelberg, 2013.

[12] S.C. Mukhopadhyay, K. Chomsuwan, C. Gooneratne and S. Yamada, "A Novel Needle-Type SV-GMR Sensor for Biomedical Applications", *IEEE Sensors Journal*, Vol. 7, No. 3, pp. 401-408, 2007.

[13] C. Reig, M.-D. Cubells-Beltrán, and D. Ramírez Muñoz, "Magnetic field sensors based on giant magnetoresistance (GMR) technology: Applications in electrical current sensing," *Sensors*, vol. 9, pp. 7919-7942, 2009.

[14] H. Shirzadfar, J. Claudel, M. Nadi, D. Kourtiche, and S. Yamada, "Analysis Sensitivity by Novel Needle-Type GMR Sensor Used in Biomedical Investigation," in *XIII Mediterranean Conference on Medical and Biological Engineering and Computing 2013*. vol. 41, L. M. Roa Romero, Ed., ed: Springer International Publishing, pp. 833-836, 2014.

[15] C. P. Gooneratne, S. C. Mukhopadhyay, and S. Yamada, "An SV-GMR Needle Sensor-Based Estimation of Volume Density of Magnetic Fluid inside Human Body" *Journal of Sensors*, vol. 2008, Article ID 890293, 7 pages, doi:10.1155/2008/890293, 2008.

<http://www.hindawi.com/GetArticle.aspx?doi=10.1155/2008/890293>

[16] S. Yamada, K. Chomsuwan, S. C. Mukhopadhyay, M. Iwahara, M. Kakikawa and I. Nagano, "Detection of Magnetic Fluid Volume Density with a GMR Sensor", *Journal of Magnetism Society of Japan*, Vol. 31, No. 2, pp. 44-47, 2007.

- [17] C. P. Gooneratne, A. Kurnicki, S. Yamada, S. C. Mukhopadhyay, J. Kosel, "Analysis of the Distribution of Magnetic Fluid inside Tumors by a Giant Magnetoresistance Probe", PLOS ONE, vol 8 (11), e81227, 2013.
- [18] C. P. Gooneratne, A. Kurnicki, M. Iwahara, M. Kakigawa, S. C. Mukhopadhyay and S. Yamada, "A GMR Needle Probe to Estimate Magnetic Fluid Weight Density Inside Large Tumors", Lecture Notes in Electrical Engineering, Recent Advances in Sensing Technology, ISSN 1876-1100, ISBN 978-3-642-00577-0 Springer-Verlag, September 2009, pp. 1-14.
- [19] H. Shirzadfar, M. Nadi, D. Kourtiche and S. Yamada, "Characterization of a Needle-Type Probe GMR sensor for Biomedical applications", IEEE SENSORS 2013, Sensors IEEE Publisher, pp. 298-301, 2013.
- [20] S. Yamada, K. Chomsuwan, S. C. Mukhopadhyay, M. Iwahara, M. Kakikawa and I. Nagano, "Detection of Magnetic Fluid Volume Density with a GMR Sensor", Journal of Magnetism Society of Japan, Vol. 31, No. 2, pp. 44-47, 2007.
- [21] T. Somsak, K. Chomsuwan, S. Yamada, M. Iwahara and S. C. Mukhopadhyay, "Conductive Microbead Detection by Helmholtz Coil Technique with SV-GMR Sensor" Proceedings of 3rd IEEE International Workshop on Electronic Design, Test & Applications, DELTA 2006, January 17-19, 2006, Kuala Lumpur, Malaysia, pp. 157-162.
- [22] S. Yamada, "GMR sensor application in detecting and estimating magnetic fluid weight density inside various size tumors," Journal of the Magnetism Society of Japan, vol. 33, pp. 175-178, 2009.