



HAL
open science

Overview of evolved Multimedia Broadcast Multicast Services (eMBMS)

Muhammad Moiz Anis, Xavier Lagrange, Ramesh Pyndiah

► To cite this version:

Muhammad Moiz Anis, Xavier Lagrange, Ramesh Pyndiah. Overview of evolved Multimedia Broadcast Multicast Services (eMBMS). [Research Report] RR-2016-01-RSM, Dépt. Réseaux, Sécurité et Multimédia (Institut Mines-Télécom-Télécom Bretagne-UEB); Institut de recherche en informatique et systèmes aléatoires (UMR CNRS 6074 - Université de Rennes 1 - INRIA - INSA de Rennes - ENS de Cachan - Télécom Bretagne - Université de Bretagne Sud); Usman Institute of Technology - Hamdard University (.); Laboratoire en sciences et technologies de l'information, de la communication et de la connaissance (UMR CNRS 6285 - Télécom Bretagne - Université de Bretagne Occidentale - Université de Bretagne Sud); Dépt. Signal et Communications (Institut Mines-Télécom-Télécom Bretagne-UEB); Direction scientifique (Institut Mines-Télécom -Télécom Bretagne). 2016, pp.48. hal-01291201

HAL Id: hal-01291201

<https://hal.science/hal-01291201>

Submitted on 21 Mar 2016

HAL is a multi-disciplinary open access archive for the deposit and dissemination of scientific research documents, whether they are published or not. The documents may come from teaching and research institutions in France or abroad, or from public or private research centers.

L'archive ouverte pluridisciplinaire **HAL**, est destinée au dépôt et à la diffusion de documents scientifiques de niveau recherche, publiés ou non, émanant des établissements d'enseignement et de recherche français ou étrangers, des laboratoires publics ou privés.

Collection des rapports de recherche de
Télécom Bretagne

RR-2016-01-RSM

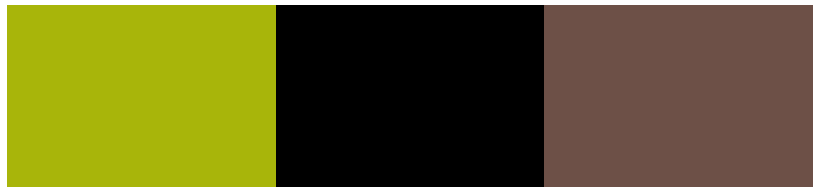

**Overview of evolved Multimedia
Broadcast Multicast Services (eMBMS)**

*Muhammad Moiz Anis (Usman Institute of
Technology - Hamdard University, Karachi,
Pakistan)*

*Xavier Lagrange (Télécom Bretagne)
Ramesh Pyndiah (Télécom Bretagne)*

Table of Content¹

1	INTRODUCTION	3
1.1	DEFINITIONS OF BROADCAST AND MULTICAST SERVICES	3
1.2	BROADCAST AND MULTICAST IN 3GPP NETWORKS	4
2	FUNCTIONAL LAYERS OF MBMS	5
2.1	USER SERVICE	6
2.2	DELIVERY METHOD	6
2.3	BEARER	6
3	PRESENTATION OF THE MBMS ARCHITECTURE	9
3.1	NEW ENTITIES IN MBMS.....	9
4	SPECIFIC ASPECTS OF MBMS ON THE RADIO INTERFACE.....	11
4.1	MBSFN.....	11
4.2	NEW MBMS CHANNELS.....	16
4.3	THE MULTICAST CHANNELS AND THE MBSFN SUBFRAME	18
4.4	SYNCHRONIZATION IN MULTICELL TRANSMISSION	22
4.5	USER DATA FLOW SYNCHRONIZATION	22
4.6	MBMS SERVICE DISCOVERY VIA BCCH	23
4.7	SERVICE CONTINUITY	23
5	SETTING UP AN MBMS SESSION	24
5.1	MULTICAST MODE	24
5.2	BROADCAST MODE	26
5.3	MBMS SESSION START PROCEDURE FOR EPS:.....	28
5.4	MBMS SESSION STOP PROCEDURE FOR EPS.....	30
5.5	SESSION UPDATE :	31
5.6	FLOW CHART FOR A UE TO RECEIVE MBMS DATA	33
6	MAXIMUM CAPACITY FOR MBMS	35
7	MBMS VS DVB - H.....	36
8	APPENDICES	38
8.1	MBMS TRANSMISSION RELIABILITY	38
8.2	EMBMS FROM 3GPP OVERVIEW DOCUMENTS	39

¹ (1) The work was mainly made when M.M. Anis was a PhD student at Télécom Bretagne. He is currently Assistant Professor, Usman Institute of Technology - Hamdard University, Karachi, Pakistan

8.3	INTEGRATED MOBILE BROADCAST (IMB) RELEASE 8	41
8.4	APPLICATION LEVEL FEEDBACK	41
8.5	MBMS APPLICATIONS	42
8.6	FILE DOWNLOAD DELIVERY METHOD AND MBMS IDENTITY FIELDS	42
8.7	STRUCTURE OF TMGI	43
9	GLOSSARY	44
10	REFERENCES	46

Abstract

MBMS was introduced as a service to optimize the dissemination of common interest multimedia content. Recently, it evolved to eMBMS based on LTE-centered flexibilities. However, launch of eMBMS over LTE may support new services e.g. pushed content for M2M services and delivery of premium content to the users enjoying secured QoS. This document primarily focusses on the rules, procedures and architecture supporting MBMS based data exchanges, which have not seen any major changes since Release 9.

1 INTRODUCTION

1.1 DEFINITIONS OF BROADCAST AND MULTICAST SERVICES

Broadcast and Multicast in general are two methods for providing a service from a single source to multiple users. The definition of both of the words is not same for all the authors. We give hereafter the definition given in TS 22.146 V8.4.0 of 3GPP [3].

"The *broadcast mode* is a unidirectional point-to-multipoint transmission of multimedia data (e.g. text, audio, picture, video) from a single source entity to all users in a broadcast service area. The broadcast mode is intended to efficiently use radio/network resources e.g. data is transmitted over a common radio channel. Data is transmitted in the broadcast service area as defined by the network (Home environment)."

"The *multicast mode* allows the unidirectional point-to-multipoint transmission of multimedia data (e.g. text, audio, picture, video) from a single source point to a multicast group in a multicast service area. The multicast mode is intended to efficiently use radio/network resources for example, data is transmitted over a common radio channel. Data is transmitted in the multicast service area as defined by the network (Home environment). In the multicast mode there is the possibility for the network to selectively transmit to cells within the multicast service area which contain members of a multicast group."

According to those definitions both modes are defined as point to multipoint transmission. In the multicast mode a subscription request is required and the transmission of data is restricted to those cells which have multicast group members in them. In the broadcast mode the service is made *a priori* available in the broadcast service area, whether there are users in the area or not.

Note that these definitions are not fully correct: Broadcast mode service can be restricted to users who subscribe to the service e.g. Canal+ in France is only available to people who have the ciphering key but the signal is broadcasted nationwide.

Note also that for some authors an acknowledgement process is the fundamental characteristic of a multicast service: as data is transmitted to a known set of terminals each data packet may be individually acknowledged by terminals. A transmission mode with acknowledgement is still possible in the 3GPP definition of the multicast mode but is not compulsory. Furthermore, when looking into the radio interface specifications of all technologies (3G or 4G), individual acknowledgement of multicast data is not possible.

1.2 BROADCAST AND MULTICAST IN 3GPP NETWORKS

Though it did not receive a lot of attention, a broadcast service was defined in the early phases of GSM. The Cell Broadcast Service (CBS) was introduced in the very first GSM recommendation in 1991. It supported a low data rate over a shared broadcast channel and offered a message-based service. Messages are transmitted in a broadcast mode in a given cell but they use different radio resources (on each cell a specific time slot and a specific frequency is used as GSM is based on frequency reuse clusters). Compared to the broadcast mode of 3G and 4G CBS is a lower data rate service and restricted only to text messaging. Example of CBS application can be advertisements and welcome messages when UE enters in a network. Multicast mode can be understood by the example of a football results service which requires users to go through the subscription process.

Multimedia Broadcast Multicast Services (MBMS) was introduced in WCDMA release 6. The main motivation was to provide multimedia services over cellular systems in both multicast and broadcast modes. According to 3GPP TS 23.246 [26] Evolved Packet System has been defined to support only the broadcast mode of MBMS in Rel 13. It is not clear whether multicast on EPS will be possible in next releases.

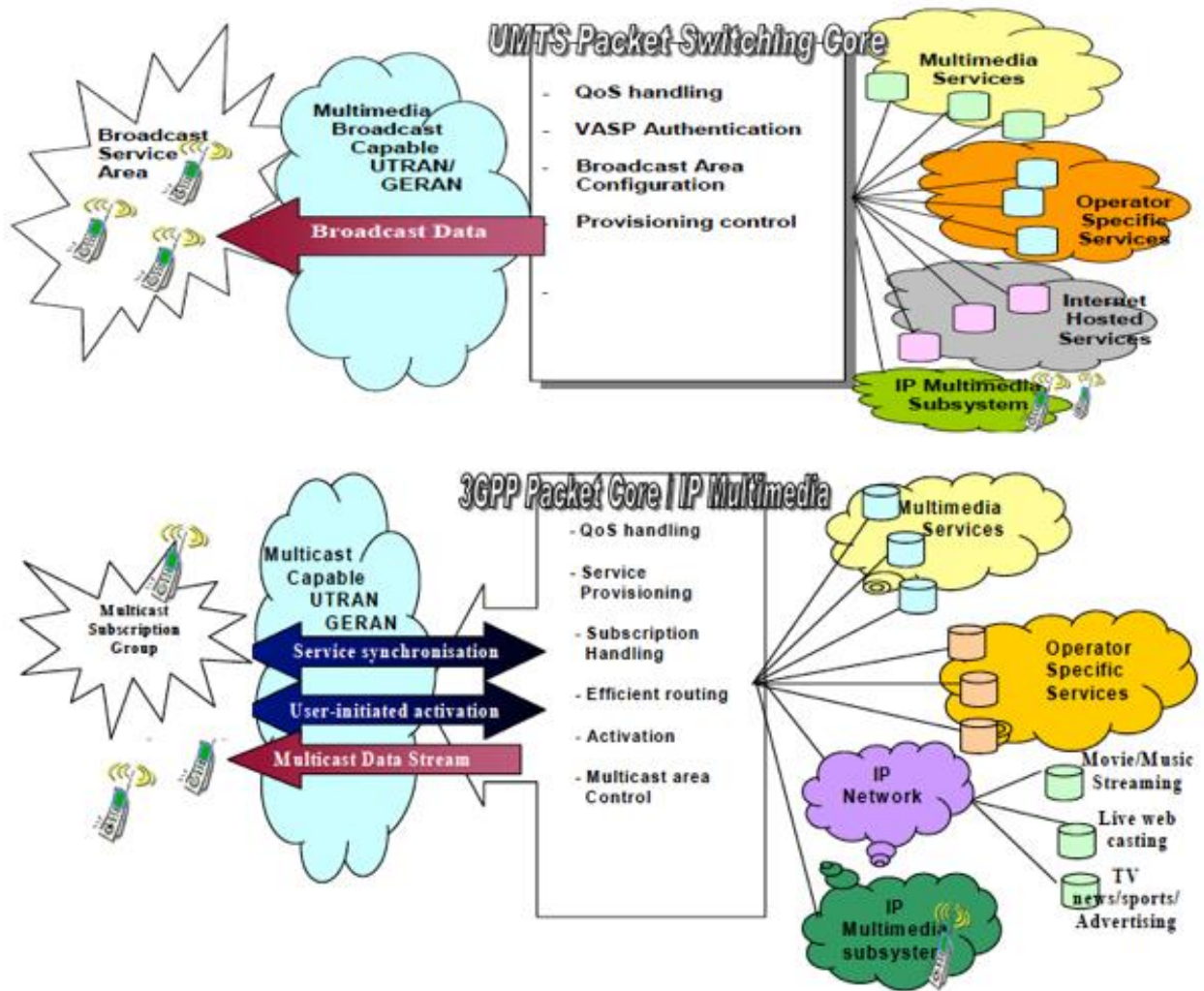

Figure 1 Comparison between Broadcast and Multicast modes of MBMS Source : Ref. [3]

2 FUNCTIONAL LAYERS OF MBMS

According to 3GPP TS 26.346 [12] and as shown in figure 2, there are three functional layers for the MBMS based services, which are User service, Delivery method and Bearer.

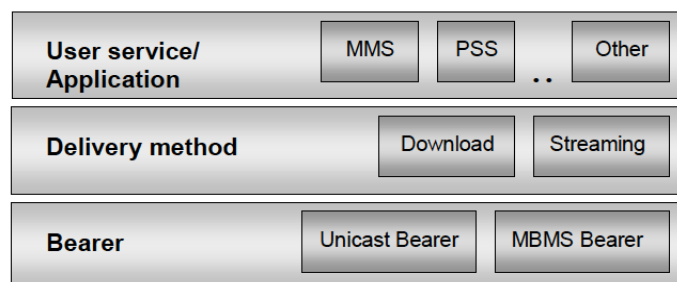

Figure 2 MBMS functional anatomy Source: 3GPP TS 26.346 [12]

2.1 USER SERVICE

The MBMS user service may be defined as the service as it is seen by the user. TS 22.246 [16] classifies **MBMS User Services** into four types:

- the *streaming service* is a continuous data flow providing a stream of media i.e. audio or/and video,
- the *file download service* is the binary reception of the user data, which is utilized by an appropriate application in the User Equipment, Multimedia Message Service (MMS) is an example of popular file download service.
- the *carousel service* combines the time synchronization aspect from streaming with file download service and is meant only for the static media i.e. text and still images.
- the TV (television) service may be seen as a particular streaming service of TV signals.

The QoS requirements of all services are not the same. It should be noted that the file download service should deliver all the data to the receiver with a very high probability and without any acknowledgement.

Services are not always available therefore MBMS defines the concept of session. A *session* can be defined as a period during which data is transmitted on a given service area. So a session is defined by a starting time and an ending time, the type of service (Video Clip, File Transfer, audio streaming...), and is identified by TMGI (Temporary Mobile Group Identity) and possibly a flow identifier. The TMGI is very similar to the TMSI (Temporary Mobile Subscriber Identity) and is defined to provide a very simple mapping function between an MBMS service and the data blocks the UE has to consider in its reception process.

2.2 DELIVERY METHOD

According to 3GPP TS 26.346 [12] there are two delivery methods, namely file download (or download) and streaming. For example, a messaging application such as Multimedia Messaging Service (MMS) would use the download delivery method, while a streaming application such as Packet-switched Streaming Service (PSS) would use the streaming delivery method.

When delivering an MBMS content to a receiving application, one or more delivery methods are used. The delivery method selection affects functionalities such as security and key distribution, reliability control by means of forward-error-correction techniques and associated delivery procedures such as file repair, delivery verification.

2.3 BEARER

Bearers are the mechanism by which IP data is transported within the EPC Core network. In Release 8 of the 3GPP recommendations, a set of unicast bearers are defined, each bearer being related to a type of service and hence a profile of QoS. In

3GPP TS 23.246 [4] and 3GPP TS 22.146 [3] new *MBMS bearers* are defined as for transporting multicast and broadcast traffic in an efficient point to multipoint fashion and are the fundamental base for the MBMS-based services. 3GPP TS 26.346 [12] suggests MBMS bearers joint usage with unicast PDP (Packet Data Protocol) contexts to offer service capabilities fully.

MBMS can be supported on both point to point unicast bearers and point to multipoint MBMS bearers. With point to point connections it is possible to use feedback techniques including closed loop power control, link adaptation and retransmissions, which cannot be used for a point to multipoint connection.

Both delivery methods are selectable with any of the bearers mentioned i.e. MBMS bearer or point-to-point bearer, following a set of MBMS associated procedures.

Different services can be proposed by the same content provider and transmitted on the same area. In that case there is one MBMS bearer and different sessions on this bearer. The bearer is identified by one TMGI and the different services on this bearer are identified by the Flow identifier.

Within the core network these bearers are based on IP multicast, which avoids traffic duplication. In the access network the extension to IP multicast is in the form of a single frequency network (SFN) for a specific Service Area.

MBMS is efficient for a large number of users and then to deliver popular content. While according to [13] it is more efficient to use point to point connections for providing MBMS services to fewer users receiving. In Figure 3 a pictorial comparison between unicast for fewer users and broadcast mode are presented.

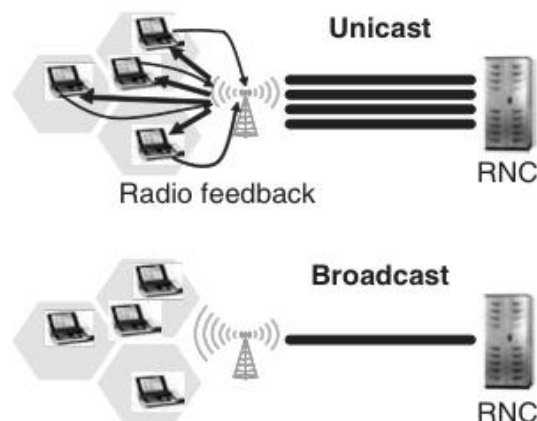

Figure 3 Unicast for fewer users and MBMS broadcast mode Source: Ref. [13]

The concept of MBMS bearers is demonstrated in Figure 4, where MBMS bearer have been shown starting from the PS domain Core and ending at User Equipments, UEs.

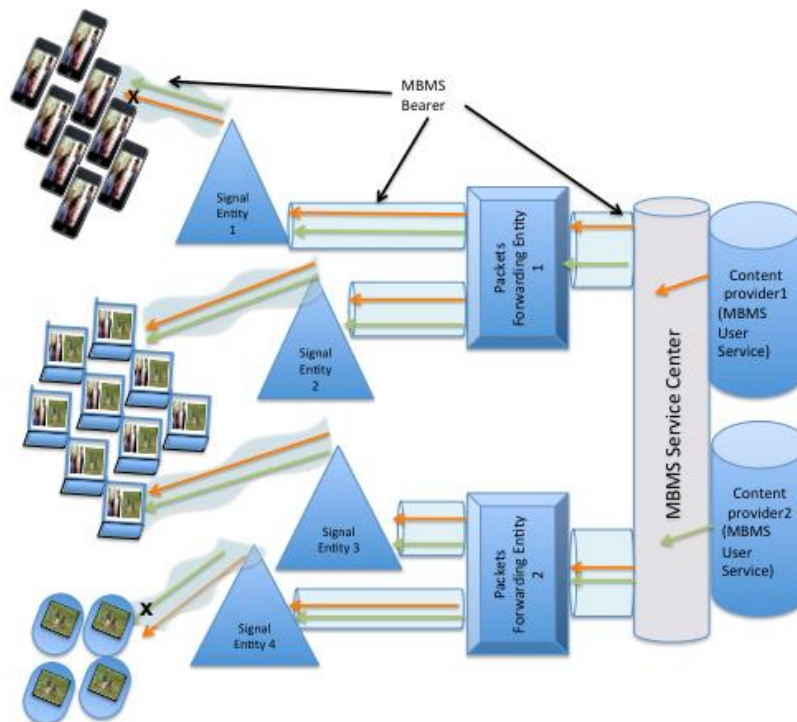

Figure 4(a) The MBMS user service over a MBMS bearer

Note that in Figure 4(a) a generalized architecture supporting MBMS is demonstrated and specific building blocks associated to any standardized Radio Network have been avoided. In this figure three types of network architecture building blocks have been shown i.e. MBMS Service center, Packet forwarding entity and Signal entity. MBMS Service Center is responsible for the management and authentication of both users and content providers, Packet forwarding entity is responsible to forward IP multicast traffic to the corresponding Signal Entities, which transmit the radio signal in the air.

For fewer users the use of individual unicast bearers is mentioned to be more efficient in [13]. There can be two advantages, first is avoiding un-necessary transmission of service to a non-subscribed user. As shown in Figure 4(a) for MBMS bearers that the subscribed user can decrypt the service with the available decryption keys in advance and the service for which it is not subscribed is shown with a cross over the arrow). Moreover, a unicast bearer can have feedback signal hence can retransmit at RLC and can have HARQ at MAC levels. In Figure 4(b) the concept has been demonstrated.

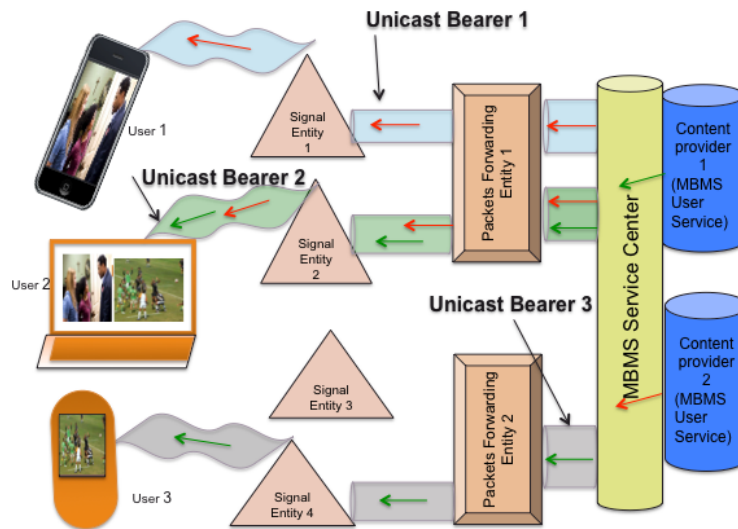

Figure 4(b) MBMS over Unicast Bearers

3 PRESENTATION OF THE MBMS ARCHITECTURE

In this section the changes MBMS brings about in the radio networks architecture are discussed. These changes are essential for the introduction of the MBMS services in the network. The changes introduced in the standardization documents are in the form of new network elements. A comprehensive explanation about the functionalities of those elements can also be found in this section.

3.1 NEW ENTITIES IN MBMS

The 3GPP TS 23.246 V9.5.0 Ref. [4] presents Multimedia Broadcast and Multicast Services architecture for the Evolved Packet System (EPS). This architecture supports E-UTRAN. MBMS service is realized by the addition of a number of new functional entities and addition of new capabilities to the pre-existing functional entities.

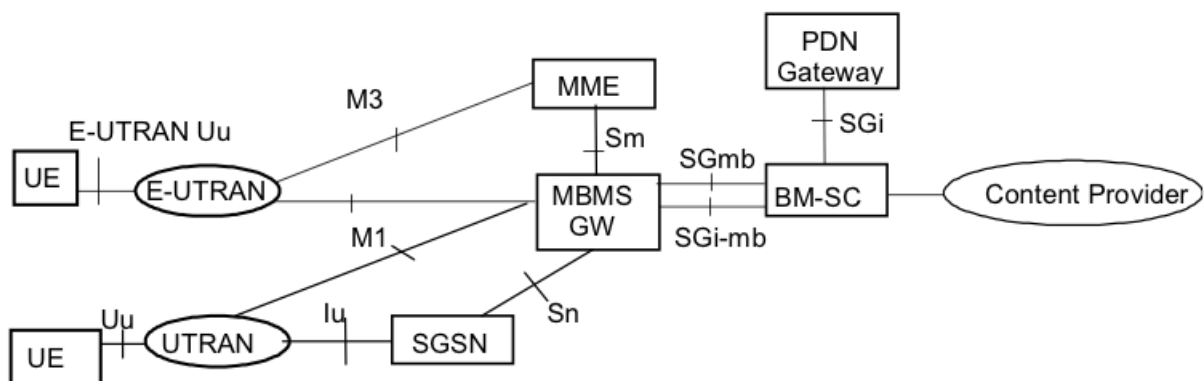

Figure 5 EPS based MBMS architecture Source: 3GPP TS 23.246 [4]

The BM-SC (Broadcast Multicast Service Center), is responsible for authentication/ authorization of both the content provider and the user, charging the user, configuration of the overall data flow through the core network and application level

coding. The data flow is ciphered by the BMSC. Hence the flow is ciphered on the whole transmission chain, from the BMSC till the UE.

Service announcement is one of the primary duties of BMSC, which can possibly be carried out over SMS, HTTP (home page) or by a MBMS broadcast bearer. The BMSC has to generate a session start message when it is ready to send data. Message comprises the quality of service parameters and information about the service area.

The *MBMS GW* is the entry point of the traffic (broadcast and multicast). It has three major responsibilities: broadcasting the packets to all eNodeBs (more generally to the radio access network), managing session start/stop and charging information collection for each terminal having an active session.

The *MCE* (not shown in figure 5) is responsible for the allocation of radio resources to multicell MBMS transmission using MBSFN operation. It is mandated to take decision about establishing the radio bearer of a new MBMS Service as per the availability of radio resources. It even also decides some further radio details like modulation and Coding scheme. There is no direct UE to MCE signaling but MCE is involved in the control signaling of an MBMS session. Each eNodeB is served by a single MCE.

There may be several eNodeBs connected to the same MBMS Gw and several MBMS Gws to the same BMSC. All these connections are IP-based and may include several intermediate routers. Multicast IP then should be used in order to avoid useless duplication of IP packets.

3.1.1 Comprehensive list of BMSC functions

We give hereafter a detailed list of BMSC functions.

- User authentication and authorization for MBMS services implementation is based on generic authentication architecture as explained in 3GPP TS 33.220. Along with encryption, authentication and authorization mechanism controls accessibility of a user
- In MBMS the encryption takes place in the BMSC which is closer to the application level, contrary to the bearer level encryption in the unicast data. According to 3GPP TS 33.246 BMSC is the incharge of key distribution and content encryption to have a restricted access policy over MBMS content.
- BMSC has to make use of FLUTE (File Delivery over Unidirectional Transport) protocol for file download and RTP (Real Time Protocol) for streaming type data to be forwarded to MBMS Gw in the of case of EPS core, as discussed in 3GPP TS 26.346.
- As a compensation for the absence of retransmission at MAC and RLC level 3GPP TS 26.346 recommends additional Forward Error

Correction as an option in BMSC (at application level) some explanation on application level coding can be found in Appendix A.

- According to 3GPP TS 32.273 BMSC gathers information about both bearers and users thus providing support for both kind of charging (bearer and User level)
- BMSC maintains MBMS bearer context for all MBMS bearers. The context contains information about the IP multicast address of the bearer, Temporary Mobile Group Identity (TMGI), QoS to be applied and area of the service.
- Context of each Mobile user joining MBMS services is also maintained as UE context by BMSC, which is similar to the PDP context of typical point to point example.

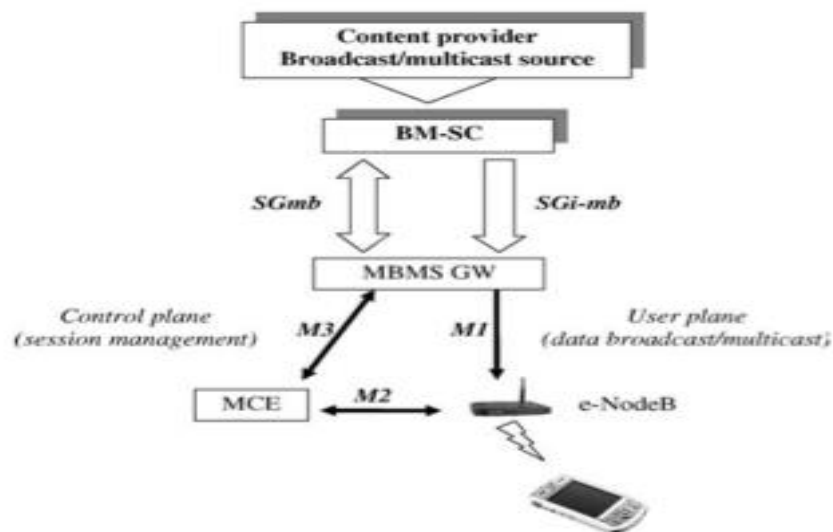

Figure 6 MBMS logical Architecture Source: Ref. [2]

In 3GPP TS 36.300 V9.4.0 under the scope of Evolved Packet System (EPS) networks two logical network entities were defined: the MCE (Multi-Cell/ multicast Coordination Entity) and MBMS Gateway.

4 SPECIFIC ASPECTS OF MBMS ON THE RADIO INTERFACE

4.1 MBSFN

MBSFN stands for MBMS Single Frequency Network. MBSFN transmission is a simulcast transmission technique realised by transmission of identical waveforms at the same time from multiple cells. This transmission is seen as a single transmission by a UE.

4.1.1 MBSFN Synchronization Area

An MBSFN synchronization area is defined as a network proximity where all eNodeBs are synchronizable and can perform MBSFN transmissions. They are capable of supporting one or more MBSFN Areas. An MBSFN area is included in one MBSFN synchronization area. An eNodeB can only belong to one MBSFN Synchronization Area. As MBSFN synchronization areas can be larger than MBSFN area, a cell can then belong to several MBSFN areas². These areas are independent from the definition of MBMSService Areas.

As MBSFN synchronization areas are larger than MBSFN area, an MBSFN Synchronization area may contain one or more MBSFN areas. To understand the realization of the synchronization in a MBSFN Synchronization Area, in figure8 we consider 8 cells out of which Cell 1 to 4 are synchronized to form a MBSFN Synchronization area. For practical use MBSFN synchronization area shall be very large, while the small number of cells taken in the figure is just for demonstration purpose.

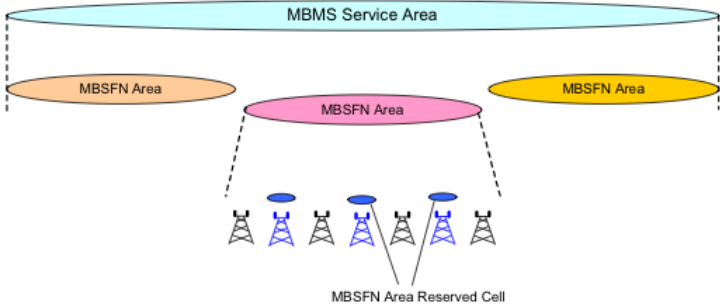

Figure 7 MBSFN Area and Reserved Cells Source: 3GPP TS 36.300 [5]

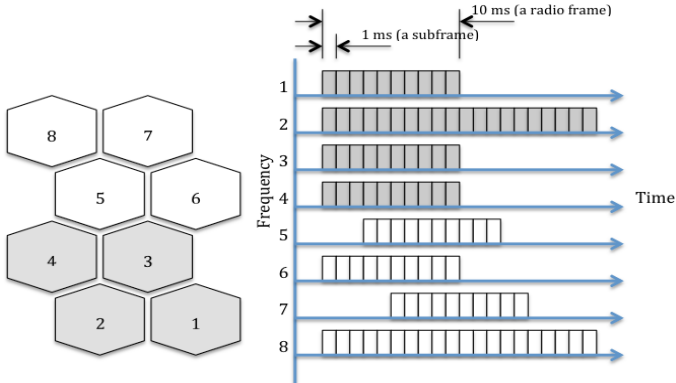

Figure 8 MBSFN Synchronization area

² According to 3GPP Rcd-11002 [18] as presented by Huawei Co. Ltd. , the limit been presented is up to 8 MCCHs, which means at a time a single cell can be a part of 8 MBSFN areas (as there is one for each MCCH MBSFN area).

4.1.2 MBSFN Area

Constructive aggregation of the energy received from multiple sources requires a tight synchronization so as to enable UE to soft combine the superimposed versions of the same signal, which is just like a multipath for the UE.

The group of cells which are co-ordinated to achieve an MBSFN transmission is called an *MBSFN Area*. An MBSFN area is generally a compact area without any hole. However, it is possible to exclude some cells from an MBSFN transmission though these cells are geographically located in the MBSFN area. An *MBSFN Area Reserved Cell* is defined as a cell within a MBSFN Area which is not contributing in the MBSFN Transmission. The cell can transmit for other services but with limited power on the resource allocated for the MBSFN transmission.

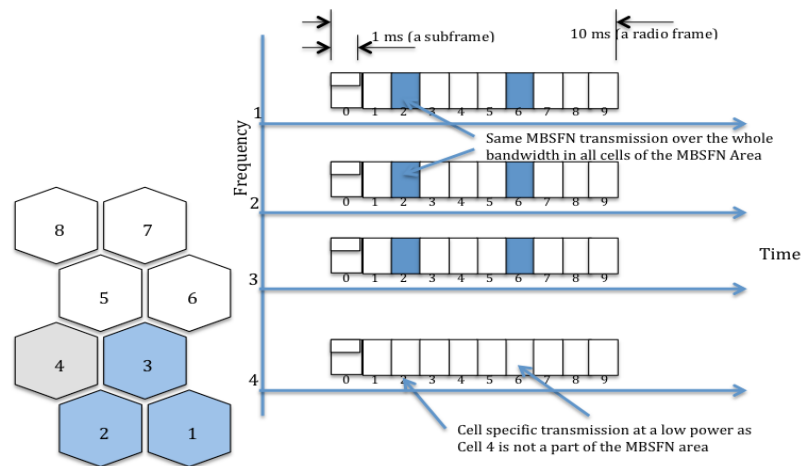

Figure 9 MBSFN Area in a MBSFN Synchronization Area

In Figure 9 a MBSFN Area consisting of Cell 1 to 3 has been shown. The MBSFN Areas are normally contained by a MBSFN Synchronization Area (shall be explained later). It can be observed that radio frames transmitted by Cell 1 to 4 are synchronized in time. In the figure subframe 2 and 6 for each cell are shown to transmit MBSFN signal. Due to synchronization there is a coincidence in time and the signal uses the entire bandwidth for the MBSFN transmission. For LTE having frequency reuse factor to be 1, frequency and time is same for the same signal from each Cell of MBSFN area. UE using macrodiversity have a high SNR of signal. For the UE all versions of signal from different cells appear to be the multipath version of the same data transmission from a single source.

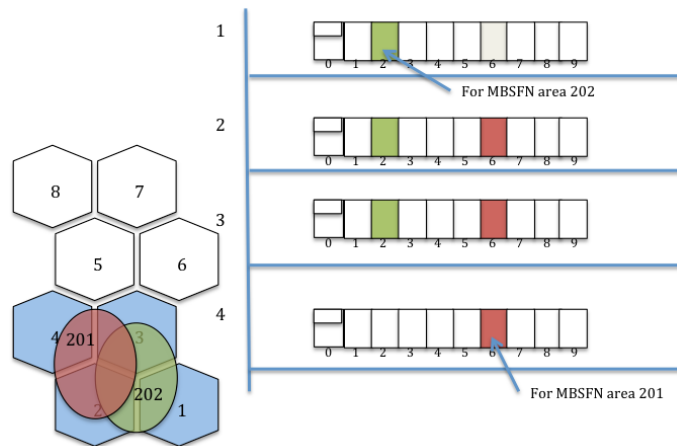

Figure 10 Multiple MBSFN areas in a MBSFN Synchronization Area

In Figure 10 a case of multiple MBSFN areas in a MBSFN Synchronization area is demonstrated. There are two MBSFN areas 201 and 202. The MBSFN area 201 comprises Cell 2, 3 and 4, whereas, 202 includes Cell 1, 2 and 3. It can be observed that data belonging to multiple MBSFN Areas can be transmitted using the same radio frames. Cell 2 and 3 belong to both of the MBSFN areas.

4.1.3 MBMS service Area

TS 23.246 [4] defines *MBMS Service Area* as the region within which same content is transmitted. Commenting on the definition of an MBMS service Area by standards, Reference [13] states a MBMS Service Area to be comprising of several cells or a single cell. Hence the definition is very flexible and is understood on cell to cell basis. In figure 11 the concept of service area is demonstrated.

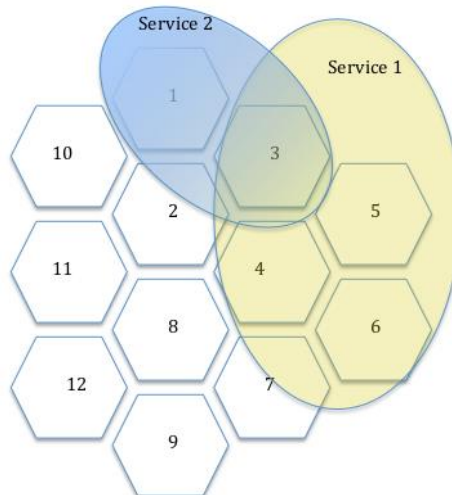

Figure 11 Concept of Service Area

In Figure 11 Service area for Service 1 comprises cell number 3, 4, 5 and 6, while the service area for Service 2 includes cell number 1 and 3 only. It can be noted that for cell number 3, MBMS sessions from both user services are transmitted to it by the MBMS bearer service. Hence it is a part of both of the service areas i.e. Service area 1 and Service area 2. For the service area it is not compulsory to have the same signal transmitted. Like two different MBSFN areas (or different MBSFN

Synchronization areas) have different signals but if content is same then they can be said to be a single service area.

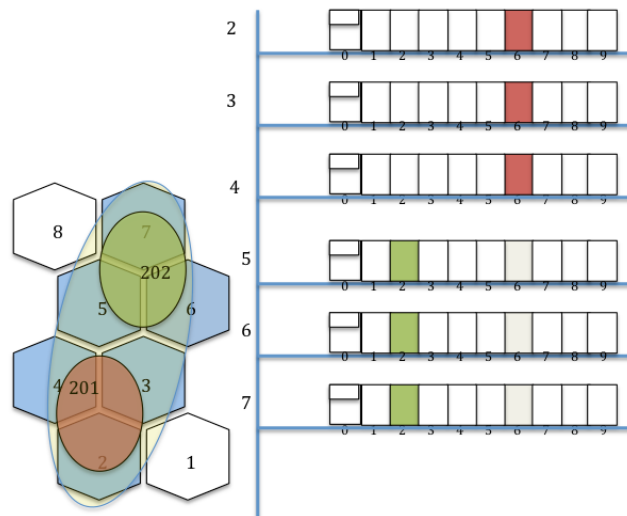

Figure 12 Service area comprising multiple MBSFN Areas

In Figure 12 the concept of service area is further elaborated by showing two different MBSFN areas i.e. 201 and 202. Both of them belong to the same Service area if the content transferred by MBMS is same. Service Area comprises Cell 2 to 7. However for UE on the boundary between 3 /5, 4 /5 and 3 /6 cannot have macrodiversity gain.

4.1.4 Multiple Services through Core Network

The MBMS Gw is the packet forwarding entity in the core network. The MBMS Gw forwards packets to the IP multicast addresses set for the eNodeBs by the MME via MCE. The forwarding of the packet takes place through M1 interface as mentioned earlier in the MBMS supporting architecture. Prior to packet forwarding the affairs related to the bearer service are also settled via the notification procedure in which every bearer service assigned a unique TMGI (see appendix for the structure of the TMGI). The concept of support for Multiple services is demonstrated in Figure 13.

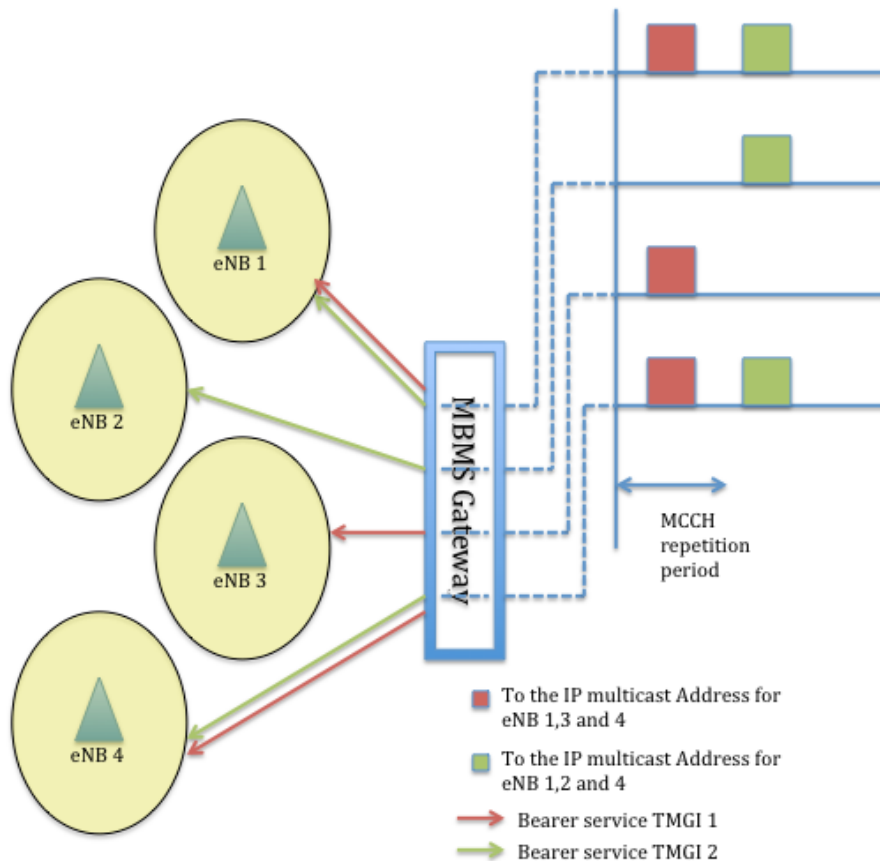

Figure 13 Multiple services IP multicasted through MBMS Gw

In Figure 13 there are two services. The relevant IP packets for each of them are multicasted sequentially. Moreover the MBMS Bearer services arranged for each User service during two different instants of time is also shown. In this whole process, the MBMS Gw is just forwarding the packets it receives to IP multicast Address of the eNodeBs being a part of that IP multicast group. These groups can be related to the MBSFN areas comprising those relevant cells. An eNodeB can have multiple IP multicast addresses, which indicates the association of that cell to more than one MBSFN area.

4.2 NEW MBMS CHANNELS

In the case of LTE E-UTRA as defined in TS 36.300, there are two logical channels:

1. MTCH (Multicast Traffic Channel)
2. MCCH (Multicast Control Channel).

And both of the channels are multiplexed to a single transport channel i.e. MCH (Multicast Channel).

4.2.1 MCCH functions in 3GPP TS 36.300

MCCH structure has been updated with some updated functionalities and procedures in 3GPP TS 36.300. An epitome of those features is as under:

- There is a one-to-one correspondance of MCCH for an MBSFN area i.e. One MBSFN Area is associated with one MCCH and vice versa.
- The MCCH is sent on MCH.
- MCCH consists of a single Radio Resource Control (RRC) message which lists all the MBMS services with ongoing sessions.
- Except the MBSFN Area Reserved Cells all cells within an MBSFN Area transmit MCCH.
- MCCH is transmitted by RRC every MCCH repetition period.
- Due to the start of session there are changes in the MCCH, which are announced using a notification mechanism. There is an MCCH modification period during which notification is sent periodically preceding the change of MCCH, in MBSFN subframes configured for notification.
- MCCH changes are notified using DCI (Downlink Control Information) format 1C (see glossary) with M-RNTI (MBMS-Radio Network Temporary Identifier). The format includes 8 bit bitmap to indicate the MBSFN areas where MCCH changes. The UE monitors more than one notification subframe per modification period. As for each notification UE acquires MCCH at the edge of next modification period boundary.
- The UE is informed of changes other than Session Start by MCCH monitoring at the modification period.

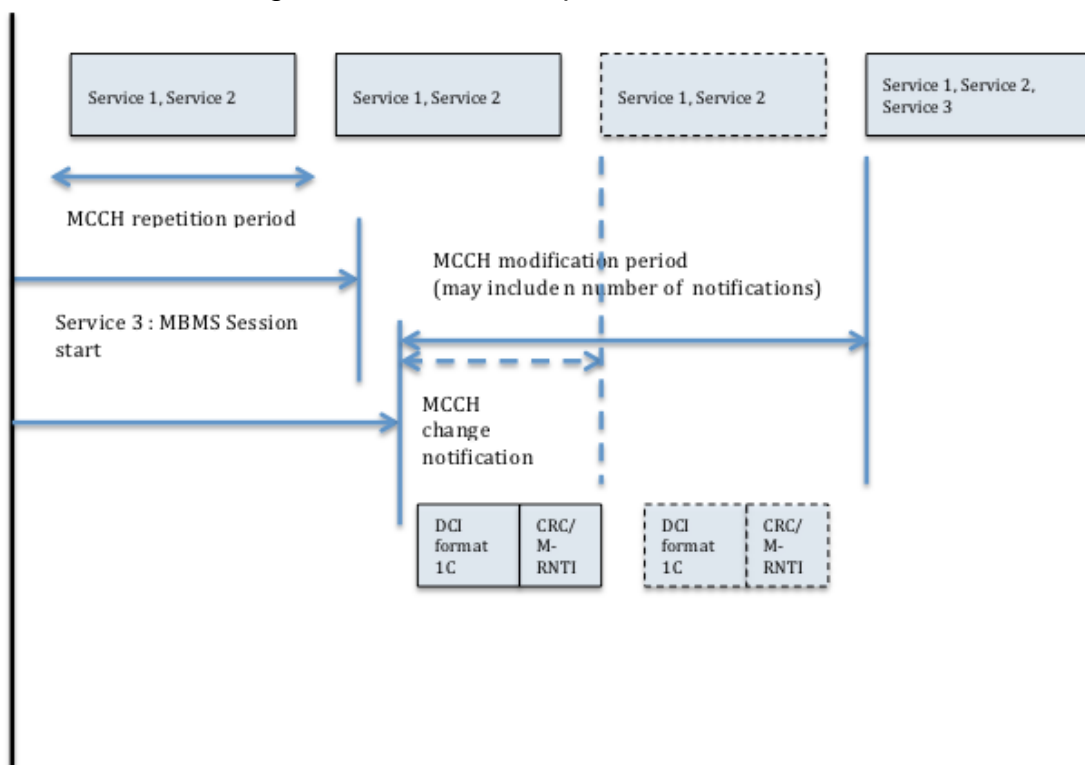

Figure 14 MCCH modification for a new Session start

Here the number of MCCH repetitions and number of notifications announcement depends on the duration of MCCH modification period. In Figure 14 the MCCH repetition and notification announcement drawn with the dotted lines show the possibility of being more than one.

4.3 THE MULTICAST CHANNELS AND THE MBSFN SUBFRAME

Simulcast is a key function of MBMS system. One specific aspect is the simultaneous transmission on the same carrier at the same time of the same signal by several eNodeBs. Hence, a new transport channel named MCH (Multicast Channel) is specified.

When a subframe is used for simulcast transmission, all the resource blocks are configured to support MCH. According to Reference [1] other LTE downlink transport channels like DL-SCH, PCH and BCH cannot be mapped to this subframe. However, the first two symbols convey reference signals, PDCCH,... to have the same structure as any subframe of the LTE radio interface. The resource block for MBSFN subframe comprises then two parts: the standard unicast part and the MBSFN part.

The Cyclic Prefix (CP) used by the MBSFN part is longer in time and is called extended CP. The Unicast part uses the same CP as any non-MBSFN subframe would use. Therefore, there may be a hole between the two parts, observable in figure 15 also.

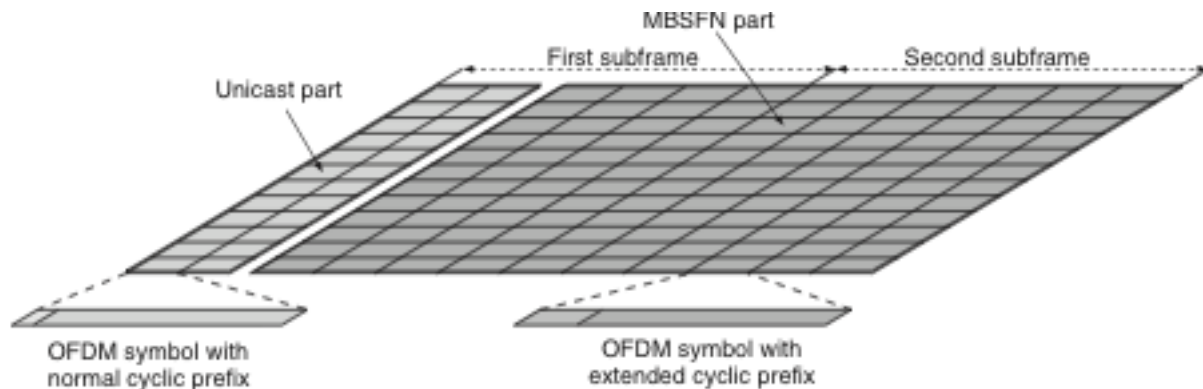

Figure 15 MBSFN subframe Source: [1]

The unicast part of the MBSFN Subframe carries L1/L2 Control signals i.e. PHICH, PDCCH and PCFICH. However, there is no mapping of DL-SCH to the MBSFN frame still the control is needed to get resources scheduled, HARQ retransmissions and power control commands for the uplink transmissions. Another difference is the limit of two symbols being reserved for unicast or control part as there is no DL-SCH scheduled resulting in a reduced size required for PDCCH.

Also the size of the control signal part in MBSFN subframe does not change dynamically because then it will complicate the maintenance of same signal in the MBSFN area. There are multiple cells within an MBSFN area, each cell transmits the MCH over radio channel. For the UE's perception it all aggregates to look as a single channel.

To enable coherent demodulation, MBSFN reference symbols are inserted within the MBSFN part of the subframe. The reason to specifically call those reference symbols as MBSFN reference symbol, is that they have to be same reference symbols on same position (same resource block) in the MBSFN subframe when transmitted by each cell belonging to the same MBSFN area. However, to remain on safe side, the channel estimation is carried out by averaging only the MBSFN reference symbols of

one single MBSFN subframe. There is no inter subframe averaging done as two different MBSFN subframes may possibly belong to two different MBSFN areas and carrying different MCHs. The reference symbols inserted in the control signal part are cell-specific. Both kinds of reference symbols are shown in figure 16.

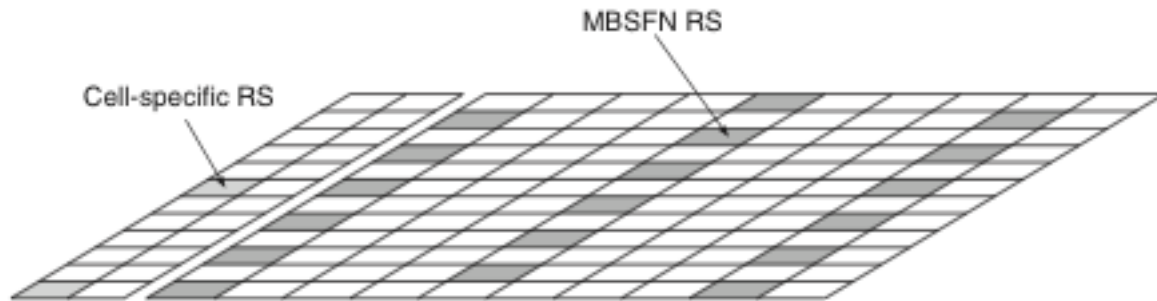

Figure 16 Reference Symbol structure for an MBSFN frame Source: [1]

4.3.1 MCH Subframe Allocation

The MCH transmission takes place in the form of Transport Blocks (TBs). In each Transmission Time interval only one Transport block is transmitted and it is mapped to a MBSFN subframe, whose all the MBSFN resources should be utilized.

The subframes are configured by layers upper to MAC layer for the transmission of MCH. A single MCH may contain Multiple MBMS services. According to 3GPP TS 36.300 each MCH carries data belonging to only one MBSFN area, but there can be one or more MCHs in an MBSFN area. By saying more than one MCH it means MCH transmitted from each participant cell of the MBSFN area, as MCHs from each of those should be same.

There is a unique pattern followed by subframes specific to a MBSFN area. Since this pattern is common for each cell's MCH within a MBSFN area, therefore it is called Common Subframe Allocation (CSA) Pattern. According to 3GPP TS 36.300 [5], the CSA pattern repeats in every CSA period. Moreover, 'MSA end' is also an important information as it indicates the last subframe of the MCH within the CSA period. The CSA pattern, the CSA period, and the MSA end all the three are signaled on MCCH. According to the 3GPP TS 36.321 [17] and TS 36.300 such transmission of an MCH over a set of subframes is called the *MCH Subframe allocation* (MSA). And to define any MSA CSA pattern, CSA period and MSA end are essential.

Enlisting the characteristics of multicell transmission in clause 15.3.3 of 3GPP TS 36.300 [5] it asserts MCE being responsible of scheduling each MCH.

In 3GPP TS 36.300 some other facts have also been laid down regarding the multi-cell transmission of MBMS, which are as under:

- The transmission of MBMS is required to be synchronous with in its MBSFN Area
- The combining of signals from multiple cells is the root of the MBMS transmission concept.
- MCH transmission neither supports HARQ repetition nor RLC quick repeats. It has only single transmission.
- RLC for MCH works in Unacknowledged mode, which means

4.3.2 MCH Scheduling Information MAC Control Element

The MSI MAC control element is identified by the LCID of the MAC PDU subheader. The value for the Subheader LCID identifying MSI MAC Control element with in the payload is 11110_b as stated in Table 6.2.1-4 of 3GPP TS 36.321 [17]. The byte aligned structure of the MSI MAC Control element is shown is in Figure 18.

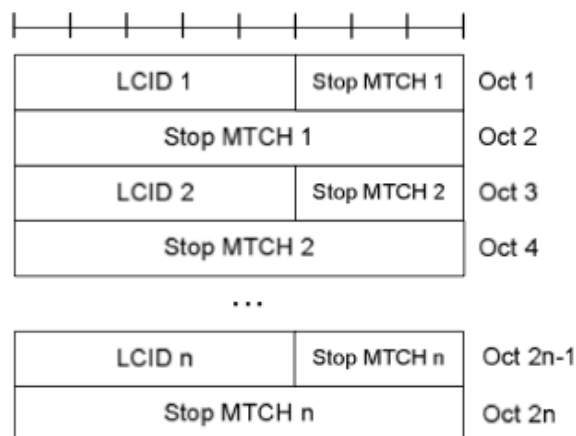

Figure 18 Byte aligned structure of MSI MAC Control Element Source: 3GPP TS 36.321 [17]

As MSI MAC Control element is supposed to convey the scheduling information therefore it carries Identification of all the constituent MTCH logical channels each carrying some MBMS service. The length of the field for Logical Channel ID is 5 bits while the remaining 3 bits and next byte i.e. 11 bits in total are used to point the ordinal number of the subframe with in the MCH scheduling period, where the corresponding MTCH stops. The value 2047 for Stop MTCH signifies that the corresponding MTCH has not been scheduled and the values from 2043-2046 are reserved.

According 3GPP TS 36.321 [17] "the UE shall assume that the first scheduled MTCH starts immediately after the MCCH or the MCH Scheduling Information MAC control element if the MCCH is not present, and the other scheduled MTCH(s) start at the earliest in the subframe where the previous MTCH stops."

4.4 SYNCHRONIZATION IN MULTICELL TRANSMISSION

Because of an IP based core network there is jitter which cannot guarantee an ideal simulcast by transmitting packets at the same time, belonging to the same MBSFN area. All the subframes from eNodeBs shall be transmitted at the same time by having a synchronized radio frame timing. MCE takes care of all eNodeBs to be identically configured for RLC/MAC/PHY. An MBMS-GW sends packets to all eNodeBs using SYNC protocol, which provides additional information about the subframe so that the eNodeB identify the transmission of radio frames. The eNodeB buffers MBMS packet and waits for the transmission timing indicated by SYNC. Segmentation and concatenation are handled by RLC and MAC layers in eNodeB.

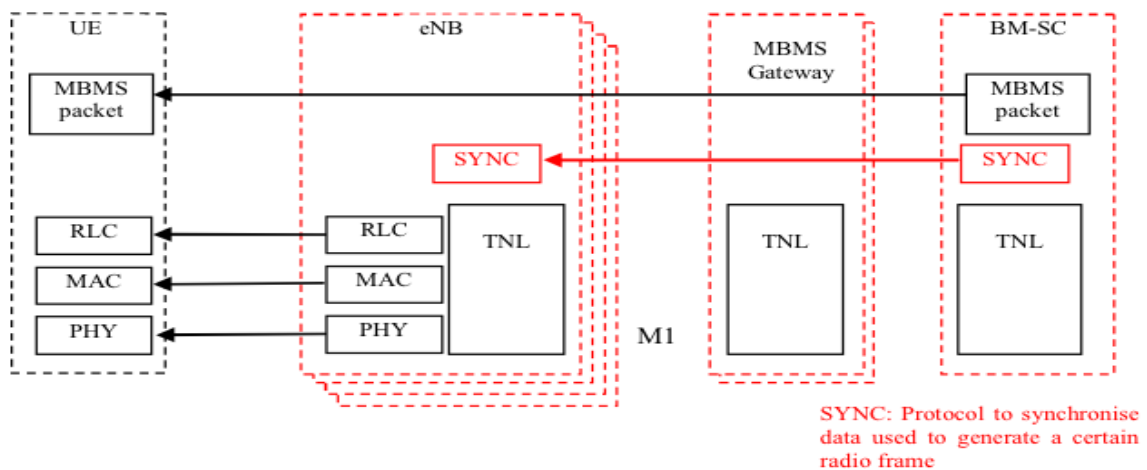

Figure 19 SYNC protocol Source: 3GPP TS 36.300 [5]

SYNC protocol provides means for detecting packet losses and supports a recovery mechanism which is robust against consecutive loss of PDU packets or packets with a SYNC header. The typical placement of the protocol in the stack can be observed from figure 19. In the case of packet loss between MBMS gateway and eNodeB the transmission of the radio blocks is muted using the information provided by the SYNC protocol.

The muting of blocks is not only limited to that MSP but it also stops transmission of corresponding MCH subframes as determined by MSI (CSA pattern, CSA period and end of MSA).

4.5 USER DATA FLOW SYNCHRONIZATION

SYNC PDUs have a time stamp field based on which MBMS sends data over air interface. This time stamp is based on a common time reference and is a reference value with respect to the common start of the first synchronization period. BMSC sets all the packets to the same value of time stamps in one sequence of synchronization.

The time stamping of user data is based on the separability of multiple synchronization sequences pertaining to different services. Increment by one or more synchronization sequence lengths in the time stamp value makes eNodeB to note the start of a new sequence.

The absolute start time of TTI is not known but the sequence length is defined by the Operation & Maintenance unit like delay parameters. BMSC uses those delay parameters as the time point for the transmission of the user data and for all other data packets arriving within the time stamp sequence length. For example if sequence length was set to be 40 ms then all the packets received since the start of the sequence till the 40 ms time elapsed receive same value of time stamp.

SYNC header comprises information like timestamp and Packet number etc. And according to 3GPP TS 36.300 [5], based on those parameters an eNodeB is able to derive size of a single packet if one or multiple consecutive SYNC packets are lost between BMSC and eNodeB and can also reorder PDUs before passing them to RLC processing.

At the end of each sequence BMSC sends total number of packet counter in the user data frame instead of the MBMS payload data, which also marks the end of the sequence. For the case when SYNC protocol delivers more data than the capability of eNodeB, it must drop a packet having too much data for the MCH scheduling period. To drop a packet following procedure can be quoted from the 3GPP TS 36.300.

- "Select the last bearer according to the order in the MCCH list with a SYNC SDU available for dropping;
- for the selected bearer, drop the available SYNC SDU with the highest Packet Number among the SYNC SDUs with the latest Timestamp.

(A SYNC SDU is considered available for dropping when the eNodeB knows its size and it has not been dropped by the eNodeB)"

4.6 MBMS SERVICE DISCOVERY VIA BCCH

BCCH (Broadcast Control Channel) is a downlink channel for broadcasting system control information in general. To trace MBMS service UE has to find pointers towards the MCCH resources. BCCH is the mean of getting information about MCCH.

BCCH indicates about the scheduling of the MCCH for multi-cell transmission on MCH, the MCCH modification period, repetition period, radio frame offset and subframe allocation. It also points out the MCS which applies to the subframes indicated for MCCH scheduling and for the first subframe of all MSPs in that MBSFN Area.

4.7 SERVICE CONTINUITY

In 3GPP TS 36.300 V9.4.0 an important mention about the topic of MBMS Service continuity has been mentioned. Especially the case when a UE is switching reception between MBSFNs, the frequency layer which carries the MBSFN transmission, is recommended to be set to a high priority to help service continuity. But any

Application Specific level mechanism is missing to address mobility outside the MBSFN area such as Home eNodeB (HeNodeB)

5 SETTING UP AN MBMS SESSION

In this section we present a step-by-step explanation for both modes procedures i.e. Broadcast and Multicast modes, for a MBMS session. In the same section a detailed explanation about session update, session start and session stop for EPS systems detailed procedures are also included.

5.1 MULTICAST MODE

In an MBMS Session there are several steps involved. The steps explained here are for the multicast mode and they are: subscription, service announcement, authentication, key delivery, session start and session stop.

5.1.1 Subscription

It is a relationship that enables a user to receive MBMS multicast services from the Service provider. For example, the user goes to an Orange/SFR/Bouygues store to subscribe to the service (administrative process). The user subscription information is stored in the BM-SC.

5.1.2 Service announcement

Service announcements are used to distribute service parameters among users. These parameters are required for the service activation, for example IP multicast addresses, TMGI and Service start time.

The BM-SC is in charge of delivering the service announcements to the terminals. In 3GPP TS 23.246, it is recommended that the UEs which are not subscribed to any services shall also be able to listen to those service announcements. In the support of her recommendation itService announcement can be realized in several ways presents a tentative list also which includes:

- " SMS Cell Broadcast to advertise MBMS Multicast and Broadcast user services; ,
- **MBMS**Services Broadcast mode to advertise MBMS Multicast and Broadcast user Services; ,
- MBMS Multicast mode to advertise MBMS Multicast user Services,
- PUSH mechanism based on (WAP, point-to-point SMS or-PP, MMS); ,
- web based announcement through a URL the user can browse (HTTP, FTP) " .

5.1.3 Authentication and key delivery

A subscribed user can obtain the encryption keys through point to point links. The policy of transmitting encrypted data ensures that only those users, who have paid the subscription fee, get benefit from the service.

5.1.4 Session start

The BM-SC sends the session start message to the MBMSGW as the MBMS session is about to start. The session start message contains, e.g., the QoS parameters of the bearer, the service areas and the session duration. Session start message further gets propagated to the SGSN and the RNC. The final step is the resource allocation to MBMS bearer by all of the network elements according to the parameters described in Session start message.

5.1.5 Notification

At the end of the set-up, the bearer is advertised on the radio interface. The notification mechanism is used to inform UE about the changes in the MBMS bearer setup. After a while the BM-SC can start to transmit data on the MBMS bearer³.

For MBMS session a notification mechanism has been referred without specifying any particular logical channel. 3GPP TS 36.300 section 15.3.6. defines that the BCCH is responsible for configuring the position of notification subframes about MCCH changes.

5.1.6 Terminal listening, decoding and departing or DATA transfer

The terminal finds out from the common control channels in the radio interface that the MBMS bearer is set up. BCCH can be taken as an example of a possible control channel. The terminal decrypts the traffic which it started to listen after determining the setup of MBMS bearer. The decryption of data is possible only because it has obtained the keys from point to point channels, while the appended keys are provided in the traffic stream of the MBMS bearer [13].

5.1.7 Session stop

When the session is over, the BM-SC sends the session stop message to the MBMS Gw, which then starts tearing down the MBMS bearer by contacting the SGSN. According to 3GPP TS 23.246, it is the point at which there will be no more data to send for some period of time and it is the length of such period which justifies removal of bearer resources associated with the session.

5.1.8 Leaving

According to 3GPP TS 23.246 the final step of a multicast mode MBMS session is Leaving. It is the process by which a subscriber stops being member of a multicast group i.e. a user no longer wants to receive multicast mode data of a specific MBMS bearer service.

³From release 6 onwards (i.e. for UTRAN) it is the notification channel which is used to inform the UE about changes in the MBMS bearer set-up. However, in TS 36.300 mention about channel like MBMS Notification or Paging Indicator Channel (MICH) is absent. For further study about the notification mechanism in UTRAN [13] Section 14.4.3 can be referred.

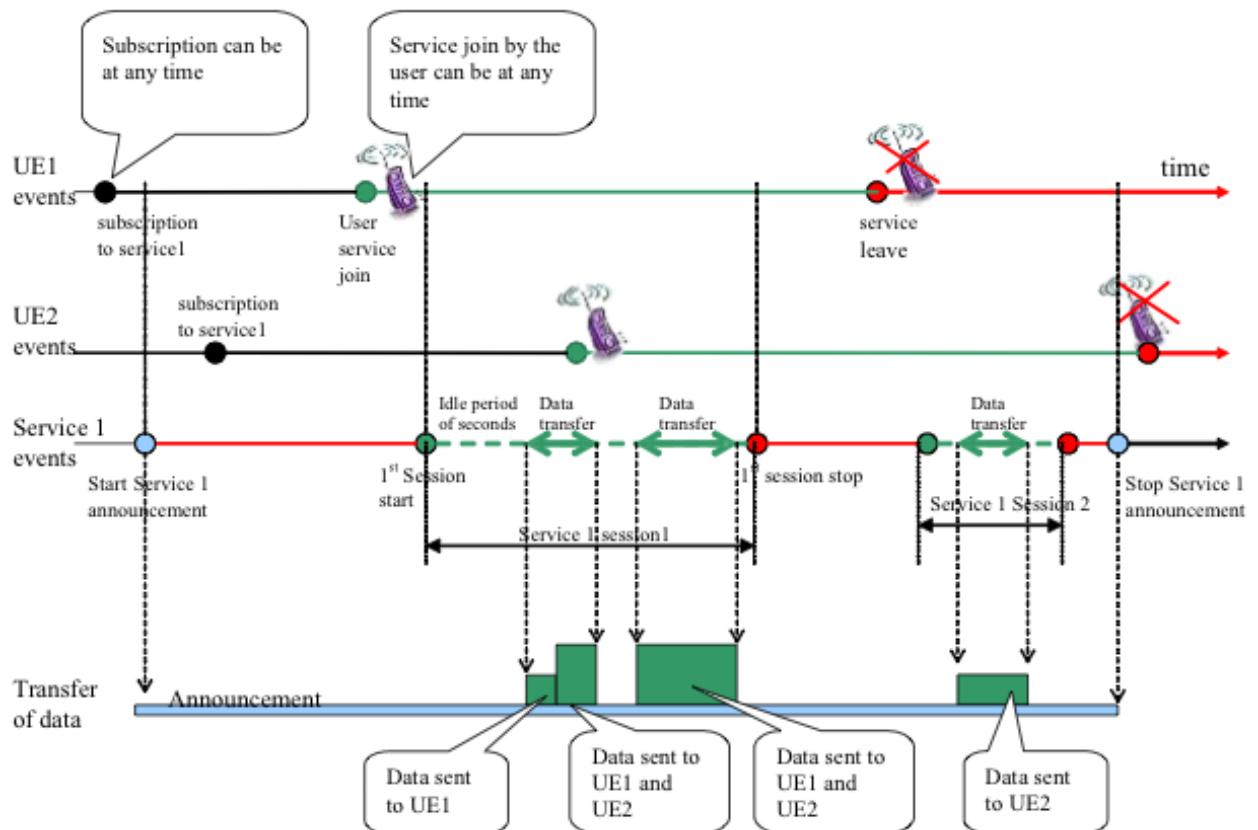

Figure 20 Example MBMS procedures for a multicast Session Source: 3GPP TS 23.246 [26]

5.2 BROADCAST MODE

In the case of Broadcast mode the sequence of phases may repeat, e.g. depending on the need to transfer data. It is also possible that the service announcement and MBMS notification phase may run in parallel with other phases, in order to inform UEs which have not yet received the related service.

5.2.1 Service Announcement

Informs UEs about forthcoming MBMS user services. The process is same as in Multicast mode.

5.2.2 UE local service activation

The part of UE demanding MBMS user service initiates reception of the MBMS bearer service to receive an MBMS user service. For the case when a single MBMS User service is beared by more than one MBMS bearer Services then according to clause 4.4.3.1a of 3GPP TS 23.246 [26], UE will have to activate all the relevant Bearer Services.

According to clause 8.12 of 3GPP TS 23.246 [4, 26], the service activation in the broadcast mode is very local for the UE as it doesnot interact with network nor it establishes UE context in the SGSN and GGSN (MBMS Gw for EPS). In other words there is no MBMS bearer service specific signalling exchange with the network.

5.2.3 Session Start

Session Start is the instant when the BM-SC is ready to send data. It triggers the bearer resources for MBMS data transfer. A Session Start message would be required for each MBMS bearer service incase if a MBMS user service is carried by more than one MBMS bearer services. UE should initiate the reception of multiple relevant MBMS bearer services to receive the MBMS user service.

5.2.4 MBMS notification

Notification step informs the UEs about forthcoming (and potentially about ongoing) MBMS broadcast data transfer.

5.2.5 Data transfer

It is the phase when MBMS data is transferred to the UEs.

5.2.6 Session Stop

At Session Stop, the bearer resources are released. It is the point when the period receiving no data gets long enough to justify the removal of bearer resources associated with the service. As MBMS user service determines that there will be no more data to send for some period of time.

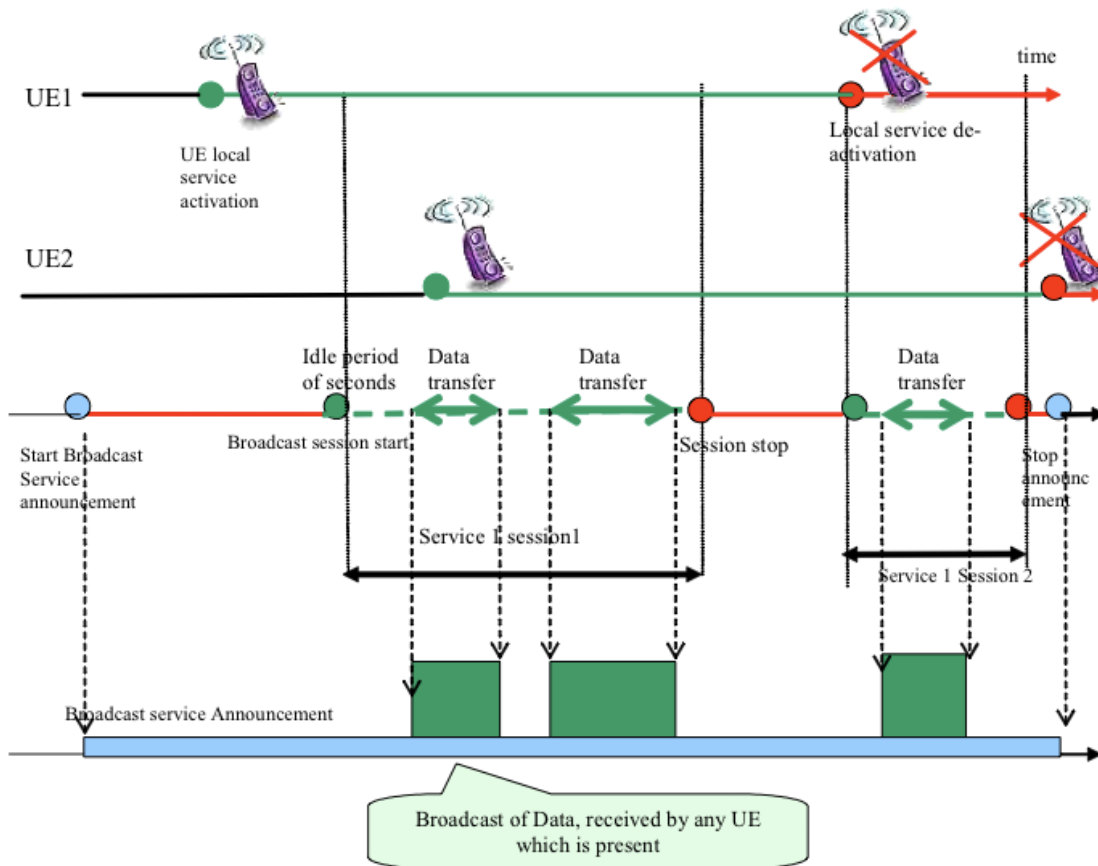

Figure 21 Example MBMS procedures for Broadcast session Source: 3GPP TS 23.246 [4]

5.3 MBMS SESSION START PROCEDURE FOR EPS:

MBMS session start is explained as a request to activate all the bearer resources to transfer MBMS data and to notify all the interested UE about it, when the BMSC is ready to send data. In this procedure MBMS session attributes are disseminated among all the registered SGSN(s), GGSN(s), MBMS Gw(s) and MME(s). Those session attributes can be QoS, Service Area and session duration estimated.

The procedure also allocates bearer plane to the mentioned architectural entities. MBMS Gw allocates IP multicast address to eNodeBs via MME and also provides the source IP address (MBMS Gw 's) and C-TEID to the eNodeBs along with that. In order to allow the completion of all required procedures for the MBMS data transfer like Radio bearer establishment and UE notification, BMSC waits for few seconds after sending the Session start request.

1. According to 3GPP TS 23.246 [21], BMSC have a list of downstream nodes and a list of control plane nodes (MMEs) of MBMS Gw. In the beginning BMSC has to deliver the list of control plane nodes of MBMS Gw to that default MBMS Gw which is a part of the list of downstream nodes. For resilience there are MBMS Gw kept as default. The mentioned list along with other session attributes are transferred along with the Session start request message, which is mainly the first step of the whole session start procedure.

The session attributes may comprise TMGI, Flow identifier, QoS, MBMS service Area, Session identifier, estimated session duration, list of MBMS

control plane nodes (MMEs) and access indicator etc. BMSC may start multiple sessions for the same MBMS bearer service (identified by TMGI) but with different content. These sub-sessions can be identified by Flow identifier, which is included in the session start request. This is done to avoid overlap of the service areas. There is another important session attribute called Access Indicator, which indicates the choice of access technology i.e. in the case EPS indicates the choice between UTRAN and EUTRAN.

2. The request by BMSC is responded by the MBMS Gw with the assertion to send the MBMS data to MBMS Gw.
3. The MBMS Gw makes a MBMS Bearer context by storing the session attributes and the list of control plane nodes. It also allocates the transport IP multicast address and C-TEID for the session. Moreover it propagates the session start request along with the transfer of session attributes to the MMEs listed in MBMS control plane nodes list after filtering the parameters according to the access indicator.
4. The MMEs then create their MBMS bearer context by storing the session attributes and send a session start request message to the E-UTRAN ahead. However like MBMS Gw they also transfer session attributes to the following entity but their message does include some extra parameters like IP Multicast address, C-TEID and IP address of the source i.e. MBMS Gw.

Falling back to the point to point MBMS bearer establishment in UTRAN :

In the case UTRAN if at least one of the downstream nodes do not accept the proposed IP multicast, source address for the backbone distribution or the proposed C-TEID the SGSN falls back to point to point bearer context establishment. And instead of issuing a C-TEID and IP multicast distribution address in the session start response message to MBMS Gw, it issues the TEID for the bearer plane that the MBMS Gw would use to forward the MBMS data. Hence the IP multicast distribution by MBMS Gw and/or point to point MBMS bearers depends on the response from MBMS.

5. The EUTRAN creates bearer context, stores attributes of the session and sets the state attribute to active for the case of UTRAN only. It also confirms the MME/SGSN about session start request message reception. Just like the rule stated in the previous point about falling back to point to point bearer in UTRAN, at this stage also if any RNC does not accept the IP multicast distribution and source address or the proposed C-TEID. The response message with an indication about the acceptance is not sent to the SGSN.
6. The MME/SGSN stores the session attributes and the identifier of the eNodeBs/RNCs as the "list of downstream nodes" parameter in its MBMS Bearer Context and responds to the MBMS GW.
7. The E-UTRAN/UTRAN establishes the necessary radio resources for the transfer of MBMS data to the interested UEs.

8. If the E-UTRAN/UTRAN node accepts IP Multicast distribution, it joins the transport network IP multicast address (including the IP address of the multicast source) allocated by the MBMS GW, to enable reception of MBMS data.
9. The BM-SC starts sending the MBMS data.
10. MBMS GW function receives MBMS data. MBMS GW sends the MBMS data using IP multicast distribution towards all joined eNodeBs/RNCs." 3GPP TS 23.246 [21]

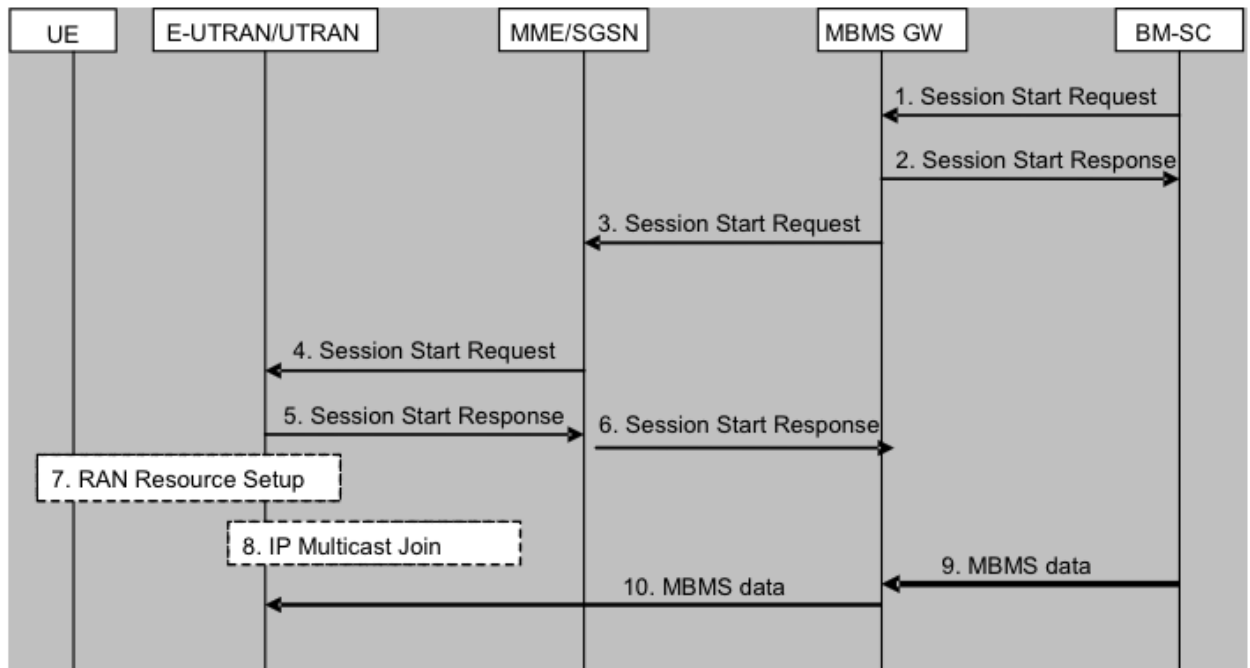

Figure 22 MBMS Session start procedure 3GPP TS 23.246 [21]

5.4 MBMS SESSION STOP PROCEDURE FOR EPS

The 3GPP TS 23.246 [21] talks about BMSC session and transmission function which initiates the procedure to stop a MBMS session when there is no more MBMS data transmission for a long enough period of time justifying the release of bearer plane resources in the network. The procedure is propagated through all the MBMS Gws and MMEs which are registered for the corresponding MBMS bearer service and through the EUTRAN which has accepted to receive IP multicast distribution.

1. The action of BMSC sending a session stop request message to the MBMS Gw listed in the "list of down stream nodes", results in the release of the affected parameters from the MBMS bearer context to indicate end of the session. It also results in the release of bearer plane resources. Each MBMS bearer context can uniquely be identified by TMGI or TMGI with Flow Identifier. The MBMS Gw releases the information for the ended session as it responds with the session stop response message. The state attribute of the BMSC 's MBMS bearer context sets to 'stand by'.

2. The Session stop request message is forwarded by the MBMS GW to the MME previously received the session start request message. MBMS Gw also releases the bearer plane resources to the EUTRAN and sets its state attribute of the bearer context to 'standby'. It also releases the bearer context in case of a broadcast MBMS bearer service.
3. The Session Stop Request message is further forwarded by the MME to the EUTRAN which previously had received the Session Start Request message. The MME sets the state attribute of its MBMS bearer Context to 'Standby' like BMSC and MBMS Gw.

The Session Stop Response message is responded by each EUTRAN for the MME. The MME/SGSN releases the MBMS Bearer Context in case of a broadcast MBMS bearer service. According to some RFC specifications i.e. 3376, 3810 and 4604, referred in 3GPP TS 23.246 if the E-UTRAN is using IP multicast distribution it shall disable reception from the IP backbone of the particular MBMS bearer service.

4. "The E-UTRAN/UTRAN releases the affected resources and removes the MBMS Bearer Context (in E-UTRAN) or sets the state attribute of its MBMS Bearer Context to 'Standby' (in UTRAN)." 3GPP TS 23.246 [21].

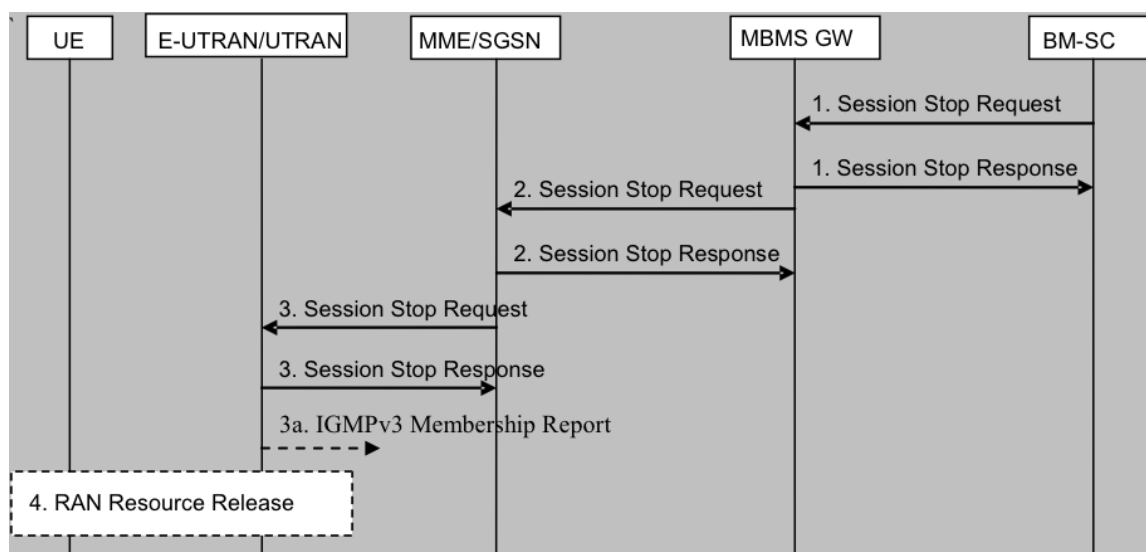

Figure 23 MBMS Session Stop Procedures

5.5 SESSION UPDATE :

Session Update is potentially a point of interest from the Bearer dynamicity perspective. The Session Update is used to update specific parameters of an ongoing MBMS session as per the already changed situation on ground. The 3GPP TS 23.246 explains three mechanisms for session updation. They are as under:

- The SGSN initiated Session Update for GERAN and UTRAN for MBMS Multicast service
- The BMSC initiated Session Update for GERAN and UTRAN for MBMS Broadcast service

- The BMSC initiated Session Update for EPS with E-UTRAN and UTRAN

The BMSC initiated Session update for EPS supports only the Broadcast, as TS 3GPP 23.246 states Multicast mode is supported by GPRS architecture only, while Broadcast mode is supported by both EPS and GPRS architectures. It further states that GPRS can support GERAN and UTRAN, while EPS can support UTRAN and E-UTRAN only. As a conclusion it can be stated that there is no Multicast mode for EPS. And as per our interest in E-UTRAN we explain in detail only the third mechanism from the above list.

The session update procedure is started by the BMSC to notify eNodeBs to join or leave the service area. Service Area, Access indicator and the list of control plane nodes are the modifiable service attributes. Any node receiving Session Update request compares the attributes in the message with the corresponding attributes stored in its MBMS bearer context. The change in service attributes then flows to the downstream nodes as well. If a session update received by MBMS Gw includes changes in the list of MME or SGSN also then at the same time it results in the Session start being sent to the new downstream nodes and Session stop message for the old ones, that have been removed from the list.

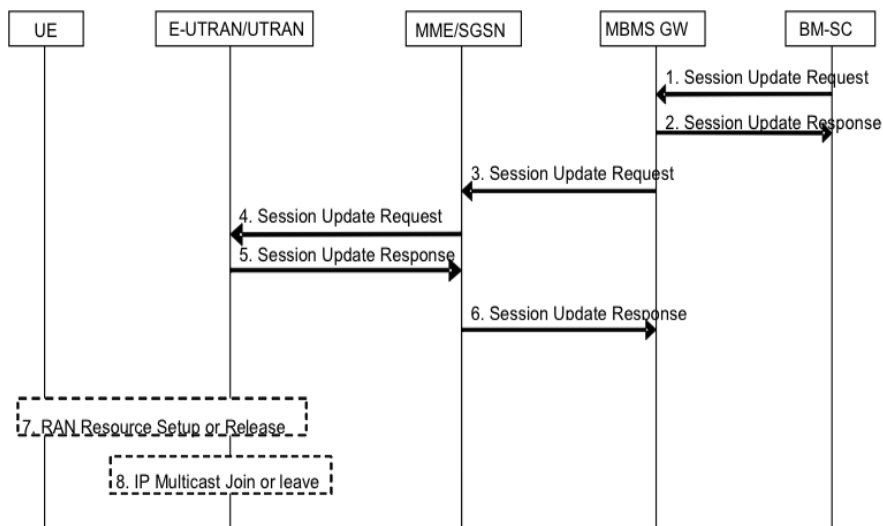

Figure 24 Session Update procedures for EUTRAN/UTRAN Source: 3GPP TS 23.246 [26]

5.5.1 Step-by-step Explanation

1. A Session Update Request is sent to MBMS GW by BMSC. The session update request comprises TMGI (Temporary Mobile Group Identification), Flow Identifier, QoS, MBMS Service Area, Session identifier, estimated session duration, the list of MBMS control plane nodes(MMEs, SGSNs) for MBMS GW and Access Indicator.

The TMGI and flow identifier are the identities for the session in progress. The QoS is typically same as in the preceding Session Start message. The MBMS Service Area and the list of MBMS control plane nodes(MMEs, SGSNs) for MBMS GW define the new service area.

The estimated session duration shall be set to a value corresponding to the remaining part of the session. Access indicator determines the radio access types to which MBMS service is broadcasted in case of EPS architecture it differentiates between UTRAN and E-UTRAN and for updating radio access information Access indicator is also included. MBMS Gw may generate charging information including Access indicator as well [3GPP TS 23.246].

2. The new session attributes are stored in the MBMS Bearer Context and a Session Update Response message is sent to the BM-SC by the MBMS Gw.
3. The MBMS Gw goes through the new list of control plane nodes ignoring those for which Access indicator is not in conformity. Then it compares the list with the one pre-stored in the MBMS bearer context. It sends session stop messages to the nodes from previous list not present in the new and sends session start messages to those which are vice versa. For the MMEs/SGSNs which keep up being in the list from previous context MBMS Gw sends a Session Update Request.
4. The MME receiving an MBMS Session Update Request message, sends an MBMS Session Update Request message including the session attributes to each eNodeB/RNC that is connected to that MME (TMGI, QoS, MBMS service Area, Session identifier, estimated session duration, broadcast(for UTRAN only), transport network IP Multicast Address, IP address of the multicast source, C-TEID, ...).
5. If with the TMGI indicated in the MBMS Session Update Request message the E-UTRAN does not have MBMS bearer context, an MBMS bearer context is created. Otherwise the E-UTRAN compares the new service area with the one it has stored in the MBMS Bearer Context and makes the corresponding update. Then the E-UTRAN/UTRAN responds to the MME/SGSN to confirm the reception of the Session Update Request message.
6. The MME/SGSN updates the session attributes in its MBMS Bearer Context and responds to the MBMS GW.
7. The E-UTRAN establishes/releases the radio resources for the transfer of MBMS data to the interested UEs.
8. The eNodeBs/RNCs send IP multicast Join or Leave message to the received user plane IP multicast address allocated by the MBMS GW. Refer to step 4.

5.6 FLOW CHART FOR A UE TO RECEIVE MBMS DATA

Based on the survey of 3GPP TS 36.331 [22] and other previously referred specifications explaining MBMS service a flow of actions can be constructed which are involved in the transmission of the MBMS data to a UE. In figure 25a flow chart presented which details all the steps. The most prior steps about the search of

relevant MCCH, then if found it addresses to the MTCH, which carries the data packet of the User service (e.g. a football match clip, news bulletin etc).

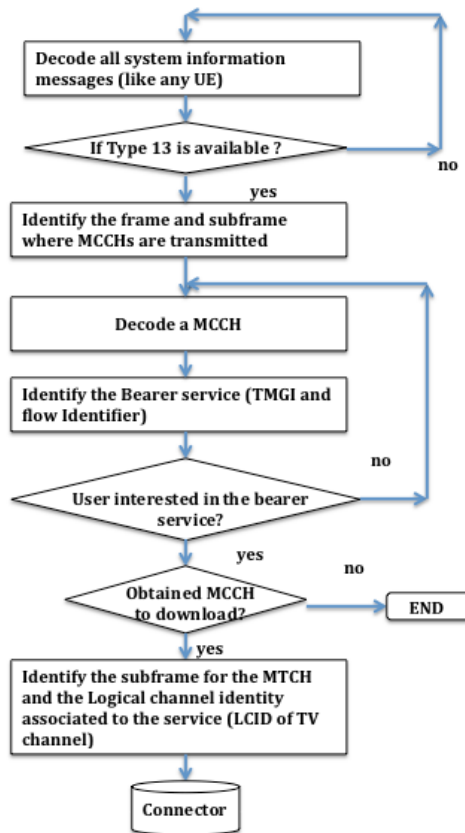

Figure 25(a) Flow chart (part 1) UE receiving MBMS service

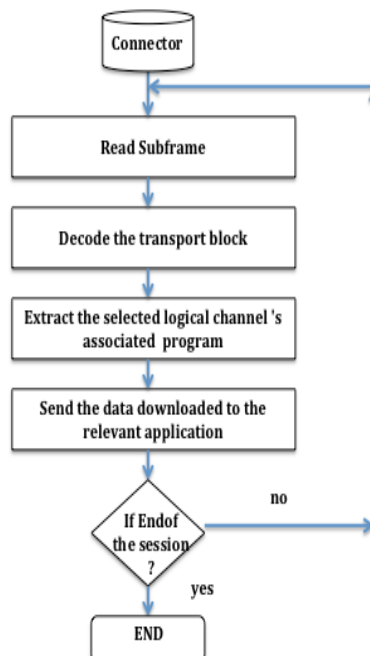

Figure 25(b) Flow chart (part 2) UE receiving MBMS services

There comes a point where the process started might end. This is going to be the case when the bearer identity TMGI is found for the bearer UE is interested in. This TMGI was obtained by decoding MCCH. But when it can not download MCCH for the

sake of finding the MTCH subframe. This situation may arise due to the lack of data flow for that User service (for example news bulletin or weather forecast are supposedly less frequent). In figure 26 two content providers are compared, which are sending their data packets being differently frequent over the bearer. For example let the content from Content Provider 2 be news bulletin then if the above discussed flow chart might end without downloading MCCH as in the first data packet content from Content provider 2 is absent.

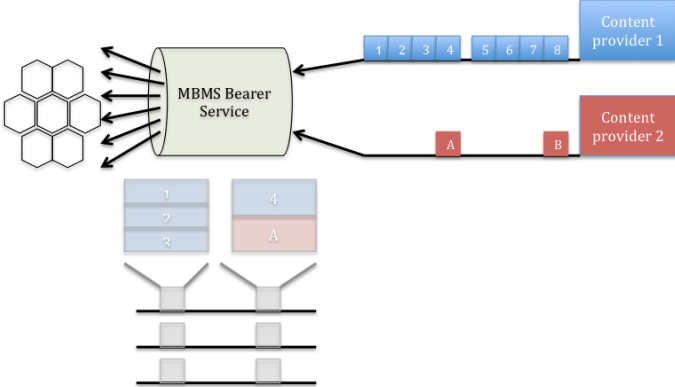

Figure 26 Different Content Provision patterns

6 MAXIMUM CAPACITY FOR MBMS

According to 3GPP TS 36.331 [22] there are six subframes which can be MBSFN Subframes in a given radio frame this means at maximum there shall be 6 subframes per 10 ms. The possible MCS selection is also among QPSK, 16 QAM and 64 QAM using this information MCS indices of choice can be determined. Based on the typical selection of resource blocks number i.e. 6 to 100 for a bandwidth selection from 1.25 to 20 MHz, the size of transport blocks can be determined using the 3GPP TS 36.213 [23]. An idea of the available capacity for the MBMS can be found in the Table 1.

Tableau 1 MBMS Capacity ranges

Bandwidth	MCS	Transport Block Size	Capacity
1.25 MHz (6 Resource Blocks)	QPSK (high coding rate)	152 ($I_{TBS}=0$)	$(6 \times 152 \text{ bits}) / 10 \text{ mS}$ = 91.2 kbps
	64 QAM (high coding rate)	4392 ($I_{TBS}=26$)	$(6 \times 4392 \text{ bits}) / 10 \text{ mS}$ = 2.635 Mbps
20 MHz (100 Resource Blocks)	QPSK (high coding rate)	2792 ($I_{TBS}=0$)	$(6 \times 2792 \text{ bits}) / 10 \text{ mS}$ = 1.675 Mbps
	64 QAM (high coding rate)	75376 ($I_{TBS}=26$)	$(6 \times 75376 \text{ bits}) / 10 \text{ mS}$ = 45.225 Mbps

7 MBMS VS DVB - H

Dedicated Broadcast solutions like Traditional analog transmission based TV, radio or Digital Video Broadcasting systems like DVB-T (Terrestrial) and DVB-H (Handheld) require high transmission powers and high data rates using high masts. The number of installations are few in a country. Hence, the only way to ensure high capacity and good coverage is increasing transmission power.

Compared to that MBMS is based over cellular networks, for which there are several thousand sites with in a country with low coverage per site. For very high capacity additional sites would be required. Otherwise, just by modifying the software and using a pre-existing infrastructure MBMS can be a good competition to the traditional Broadcasts because of the lack of power efficiency in them. A pictorial comparison between the two is shown in Figure 27.

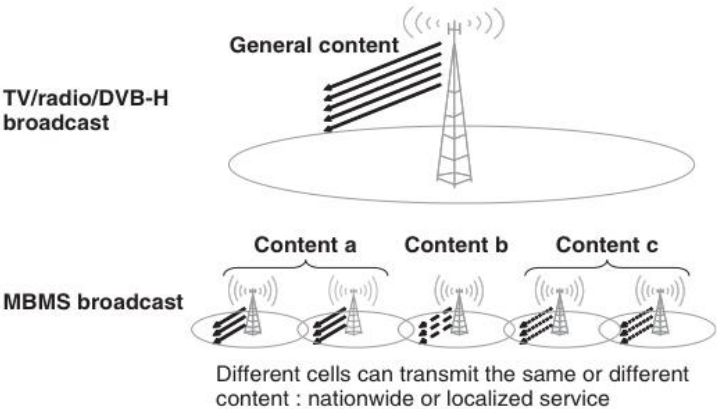

Figure 27 Localized services possible in MBMS compared to traditional Broadcasting Source: [13]

DVB-H is a pure broadcast solution for mobile devices. It can support more simultaneous channels than MBMS. It uses OFDM as the air interface. It supports both streaming and broadcast while taking care of the mobility aspects affecting transmission.

DVB-H forms a single frequency network in which signals are transmitted at the same frequency. At the Dedicated DVB – H receiver end all signals are combined as multipath signals coming from a single base station. In order to find a comparison between MBMS and DVB – H Table 2 can be followed.

Tableau 2 Comparison DVB and MBMS

	MBMS point to point over HSDPA	MBMS point to multipoint	DVB – H
User data rate	1 Mbps (theoretical) <512 kbps (practical)	< 256 kbps 64 – 128 kbps (typical)	128 – 384 kbps (typical)
Number of	Limited by the	5-10 channels per	Tens of channels

channels per 128 kbps	number of users supportable	5MHz	
Support of on demand services	Yes	Provided via point to point channels	Provided via Cellular network
Number of users per channel each 128 kbps	16 per 5MHz	Limitless	Limitless
Frequency	3GPP standard	3GPP standard	UHF band 474–746MHz (ch 21–69)
Network Solution	3GPP architecture	3GPP architecture	High power transmitting tall masts with repeaters
Cell Size	3GPP standardized urban and rural cell sizes	3GPP standardized urban and rural cell sizes	< 50 km

8 CONCLUSION

With eMBMS, broadcast transmission is possible in a mode that is fully integrated to the LTE network. However, like for DVB the absence of a feedback channel prevents from any reliable transmission. With FLUTE protocols, correction mechanisms can be activated when a file is received but only at the end of the reception process. These mechanisms are not real time. The real time repair mechanism we proposed in [24] can be easily reused in an eMBMS architecture.

9 APPENDICES

9.1 MBMS TRANSMISSION RELIABILITY

There are no feedback signals like unicast. According to 3GPP TS 36.300 RLC for MBMS works in unacknowledged mode. Because, for instance if all broadcast/multicast receiving users had to respond with feedback signals like H-ARQ status reports or CQI reports then it would consume a prohibitive large amount of radio resource in the uplink.

MBMS transmission faces a power limitation scenario (for having a feedback mechanism) to ensure more reliable transmission. However, to add to the reliability of the transmission we have:

- Macrodiversity by combining transmission from multiple cells. There are two methods of combining : soft and selection combining.
- Time diversity to curb fast fading by having a long Transmission Time Interval as MBMS is not delay sensitive for TV and Video applications.
- Application level FEC coding.

9.1.1 Application level FEC Coding

To compensate the absence of H-ARQ and RLC based retransmission mechanisms to control errors, application level coding is adopted. MBMS transmission may work with a block error rate of 1-10%, which helps conserving transmission power also.

This coding resides in the BM-SC and is very effective against occasional packet loss conditions in the transport network due temporary overloading conditions.

One of the known example of such codes is Systematic Raptor Code. It belongs to a class of Fountain codes. From the source data as many encoded packets can be generated on-the-fly. As for the decoder it requires more than one version of coded packets helps compensating the factor of packets getting lost or been received out of order.

Application level coding also eases the UE measurement by complementing the error correction at other levels. A UE has to undertake measurements when shifting to a new frequency or to a different access technology. The scheduler normally avoids UE getting scheduled for that period of time. But in the case of MBMS, every UE is allowed to undertake those measurements autonomously and going through this process there are chances of losing some multicast/broadcast packets. Such omissions are nevertheless mitigated to some extent by the turbo coding on the physical layer. But if there are still some errors then application level makes it possible to give an extra cover. Follow Figure28 to observe a typical application level encoded transmission.

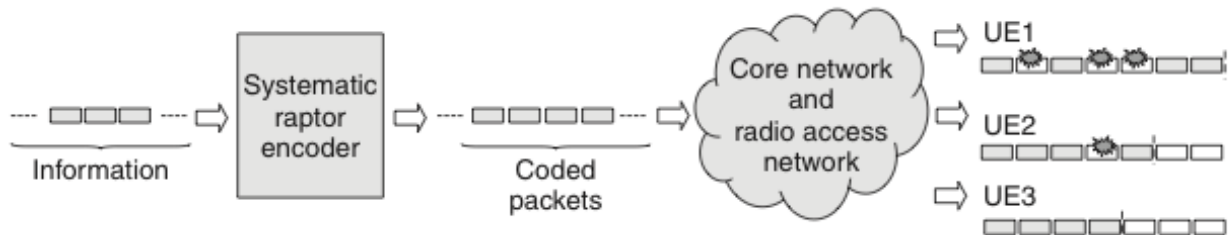

Figure 28 Application level encoded transmission Source: [1]

9.1.2 Macrodiversity

Combining transmission from multiple resources brings some diversity gain to the combined signal. There are two types of diversity strategies known for MBMS :

Soft combining, in which soft bits received prior to Turbo decoding at the receiver are combined. In the said scenario such macrodiversity is available for free because the signal from the neighbouring cell is the signal itself and not an interference. Soft combining is preferable as power from multiple cells is exploited.

Selection combining, here every received set of soft bits is decoded and selects the best blocks for further processing.

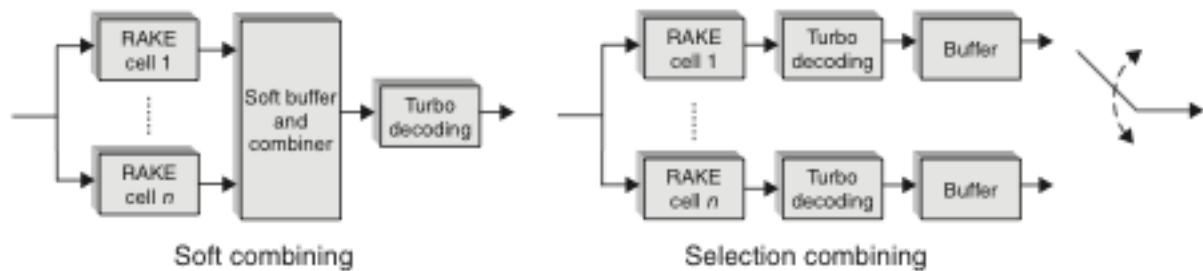

Figure 29 Soft combining and selection combining strategies Source: [1]

9.2 EMBMS FROM 3GPP OVERVIEW DOCUMENTS

In order to take into account the current developments over MBMS a preliminary survey of the relevant 3GPP overview documents has been conducted. Main observations are given below :

9.2.1 Release 12

Release 12 marks the addition of high quality video codec modes and improved file repair and reporting procedures and Group Communication System Enablers for LTE (GCSE_LTE).

GCSE_LTE was proposed as a mean for critical communication via LTE network e.g. Public safety. The initial perception about such service was to launch large and static MBSFNs for services like mobile TV. In 2014 a new move was observed in the name of Single Cell Point To Multipoint (PTM) transmission. The new concept has been

introduced to improve the Spectral efficiency, which sub-optimal in the case MBSFNs lacking adaptability as per the movement of the UE demanding a common interest service in the network. [25]

A significant impact on the performance was due to the inclusion of Dynamic Adaptive Streaming over HTTP (DASH) as download delivery method which provides pseudo-streaming services. For the same service and architecture it introduced MBMS Operation on-Demand (MoD), which includes MBMS provisioning to respond high uptake of the same Unicast service within an MBMS service area. Enhanced MBMS Operation (EMO) was introduced as a futuristic concept to improve MBMS-based Datacasting for M2M applications, to reduce FLUTE overhead for improving MBMS efficiency and to utilize DASH content streaming for real-time events via MBMS.

9.2.2 Release 11

In Release 11 description document mentions MBMS along with IMS (IP Multimedia Subsystem) as a part of Building block III which has been mentioned as an ongoing Work Item almost 60% complete. [6]

9.2.3 Release 10

In release 10 description document includes optimization and enhancement of MBMS services e.g. Session transfer between two devices, network personal video recorder and pull mode. Also under point 10.15 it talks about the enhancement of MBMS for LTE. A need to further emphasize the features already proposed in Release 9. For instance, Guaranteed Bit Rate (GBR) Bearers were defined in release 9. Due to the fact that MBR is always equal to GBR which shows variable bit rates are supported inefficiently. Mechanisms are needed to make $MBR > GBR$ through statistical multiplexing of multiple variable bit rate services on the MCH.

RAN3 removed the support for the Allocation and Retention Priority (ARP) and pre-emption function for MBMS E-RABs in order to complete Rel-9 on time. This should be supported in Release-10.

In Release-9 the network has no feedback from the MBMS UEs regarding the reception status of the MBMS service. A mechanism is needed to determine if there are sufficient UEs interested in receiving a service to enable the operator to decide if it is appropriate to deliver the service via MBSFN. This will allow the operator to choose between enabling or disabling MBSFN transmission for each service

Under point 10.14 it says in Release-9 MBMS services are broadcast over a whole MBSFN area. However certain services may only be relevant to certain localized areas (smaller than the MBSFN area). A UE might minimize its battery consumption if it is able to determine which services are relevant to its current location. It should therefore be possible to provide location information relevant to a service so that a UE can select, based on its current location, whether or not to demodulate and decode a service.

The mobility procedures do not account for MBMS reception in Release-9. By making the network aware of UE's MBMS reception it could hand the UE over preferably to a target cell that can provide service continuity. Identifying such UEs also allows setting dedicated RAT/frequency reselection priorities. TS-26.237 explain about user services (MBMS) [7]

9.2.4 Release 9

In Release 9 Technical Specification documents have been mentioned with some description about the content they address. For instance, TS- 23.246 addresses architecture and functional details etc. [8]

9.3 INTEGRATED MOBILE BROADCAST (IMB) RELEASE 8

The spectrum 1900-1920 MHz has been reserved as TDD spectrum and remained empty contrary to the FDD bands which were occupied and saturated. In 3GPP release 8 an MBMS service for those TDD bands has been proposed under the name of Integrated Mobile Broadcast (IMB) [13]. Being based over a TDD spectrum there are some contrasting differences and some requirements. Which are summarized in Table 3 [13].

Tableau 3 Comparison between IMB (MBSFN) and MBMS on shared carrier (No SFN) Source: [13]

	MBMS on shared carrier (no SFN)	IMB (MBSFN)
Spectrum	FDD spectrum	TDD Spectrum 1900-1920 MHz
Carrier sharing with Unicast	Takes part of the unicast capacity	Does not
Antennas and RF modules	Existing antennas and RF modules	New antenna and RF modules
Base Station synchronization	No need for synchronization	Synchronization with GPS is needed for Single frequency network
Capacity	1 Mbps per 5 MHz	2-3 Mbps

One of the major consideration for IMB is the possible interference it is going to produce in the neighbouring uplink FDD bands i.e. 1920-1980 MHz. According to [13] there is a -40 dBm blocking required by the WCDMA base station in the case if there is a separation of 10 MHz between FDD uplink and IMB transmission.

9.4 APPLICATION LEVEL FEEDBACK

Being a point to multipoint mechanism at RLC/MAC level the feedback signaling is not possible. However, being on the top of a cellular network, it can automatically

benefit from the existing point-to-point channels to carry any potential service level feedback information. This feedback path can be used to keep track of the number of users using service and for other interactive applications [13]. As demonstrated in Figure 30.

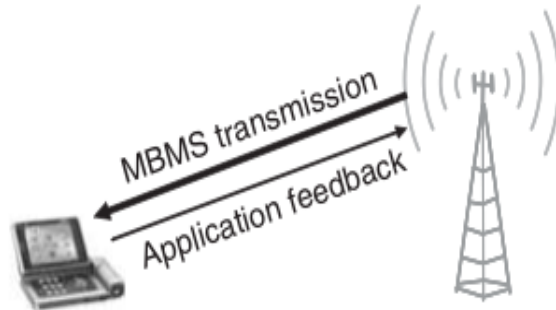

Figure 30 MBMS feedback in Uplink Source: [13]

9.5 MBMS APPLICATIONS

If each user is unicasted with the same signal for a group of users, then it makes an inefficient use of the spectrum. Point to multipoint transmission feature of MBMS helps in the conservation of radio resources.

Some of the typical applications of MBMS include e.g. mobile TV, news updates via file downloads, operator home pages pre-downloaded to mobiles, local content distribution, traffic information, software downloads to terminals and distribution of emergency information to all terminals [13].

9.6 FILE DOWNLOAD DELIVERY METHOD AND MBMS IDENTITY FIELDS

To establish a mapping between the files of a file download session and the MBMS bearer session to transport files over BMSC and UE use MBMS Identity fields (like Session ID and TMGI (Temporary Mobile Group Identity) are used.

Normally these identity fields are transferred to the UE before data transmission could start. The UEs use TMGI and Session ID to decide whether they are interested in the corresponding session. As BMSC maintains the same TMGI and Session ID incase if it is a repetition of the previous session so that the UEs successfully received it earlier can ignore the current session. The Figure 31 can be followed to see the entire procedure for GERAN.

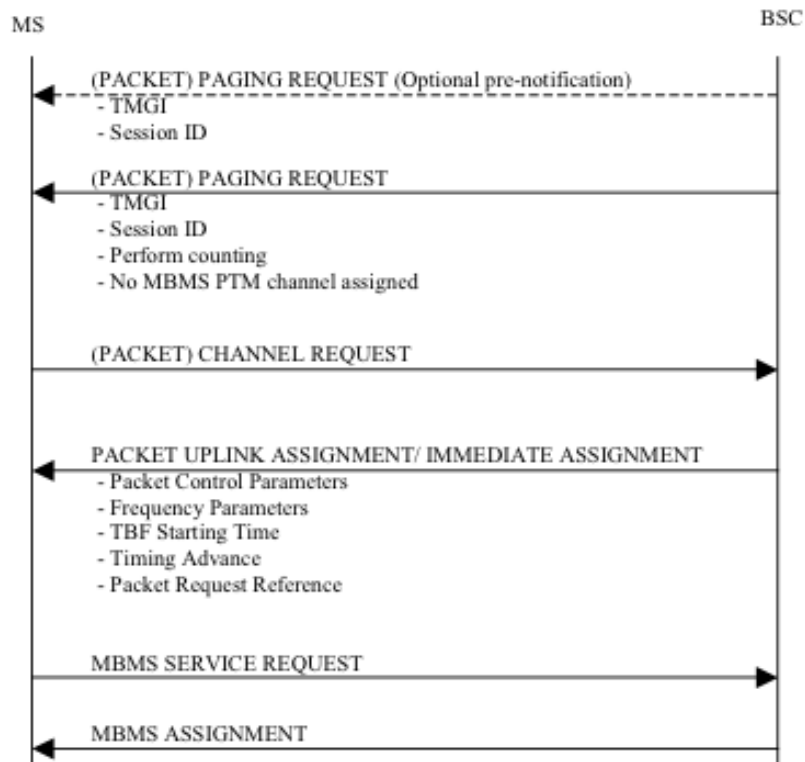

Figure 31 Notification Process in the GERAN Source : 3GPP TR 26.946

9.7 STRUCTURE OF TMGI

As discussed in 3GPP 23.003 [20] TMGI (Temporary Mobile Group Identity) is used to uniquely identify the Multicast/Broadcast Bearer services. It comprises three parts:

- MBMS Service ID: It is a 6 digit hexadecimal number between 000000 and FFFFFFFF. The value should be unique for a bearer service within a Public Land Mobile Network (PLMN).
- Mobile Country Code (MCC): MCC consists of three digits. It identifies the country of the domicile of the BMSC.
- Mobile Network Code (MNC): MNC may consist of two or three digits (to be decided by the national number assigning authority for the PLMN) and the field of MNC actually identifies the PLMN to which BMSC belongs.



Figure 32 Structure of TMGI

10 GLOSSARY

- ARP** Allocation/Retention Priority [7, 15] i.e. 3GPP TS 23.107
ARP specifies the relative importance compared to other Radio access bearers for allocation and retention of the Radio access bearer.
- BCCH** Broadcast Control CHannel
- BMSC** Broadcast Multicast Service Center
- CBS** Cell Broadcast Service
- Control Element**
Besides the major function of multiplexing logical channels MAC layer can also insert MAC Control Elements . A MAC control element is used for inband control signaling, for example, timing-advance commands and random access response. Control elements are identified with reserved values in the LCID field, where the LCID value indicates the type of control information. Furthermore, the length field in the subheader is removed for control elements with a fixed length . Ref. [1]
- CQI** Channel Quality Indicator
- CSA** Common Subframe Allocation
- C-TEID** Common TEID
- DCI Format 1C**
DCI format 1C is used for various special purposes such as random-access response, paging, and transmission of system information. Common for these applications is simultaneous reception of a relatively small amount of information by multiple users. Hence, DCI format 1C supports QPSK only, has no support for hybrid-ARQ retransmissions, and does not support closed-loop spatial multiplexing. Consequently, the message size for DCI format 1C is small, which is beneficial for coverage and efficiency of the type of system messages for which it is intended. Ref. [1]
- DCI** Downlink Control Information
There are also physical channels without a corresponding transport channel. These channels, known as L1/L2 control channels, are used for downlink control information (DCI), providing the terminal with the necessary information for proper reception and decoding of the downlink data transmission, and uplink control information (UCI) used for providing the scheduler and the hybrid-ARQ protocol with information about the situation in the terminal. For downlink DCI is carried over PDCCH, PCFICH and PHICH. And for Uplink control information it is PUCCH. Ref. [1]
- DVB – H** Digital Video Broadcasting - Handheld
- EPS** Evolved Packet Systems
- E-RAB** Evolved Radio Access Bearer [7]
E-RAB is defined as a RAB for EUTRA.
- E-UTRAN** Evolved - UTRAN
- FLUTE** File Delivery over Unidirectional Transport,
FLUTE is a protocol for the unidirectional delivery of files over the Internet, suited to multicast networks. In particular, FLUTE is used in the 3GPP MBMS service. [2]
- GBR** Guaranteed Bit Rate [7, 15] i.e. 3GPP TS 23.107
- GERAN** GSM Edge Radio Access Network
- IMB** Integrated Mobile Broadcast
- LCID** Logical Channel Identification
- MBMS** Multimedia Broadcast Multicast System
- MBR** Maximum Bit Rate [7, 15] i.e. 3GPP TS 23.107
- MBSFN** Multicast Broadcast Single Frequency Network [1] or MBMS over Single Frequency Network [21]

MCCH	Multicast Control CHannel
MCE	MBMS Coordination Entity [1]
MCH	Multicast CHannel
MICH	MBMS Indicator Channel <i>Its purpose is to inform UEs about upcoming changes in the critical MCCH information and the structure is identical to the paging indicator channel (for UTRAN) [1]</i>
MME	Mobile Management Entity
M-RNTI	MBMS-RNTI, Ref. 3GPP TS 36.321 [17]
MSA	MCH Subframe Allocation
MSI	MCH Scheduling Information
MSP	MCH Scheduling Period
MTCH	Multicast Traffic CHannel
PDN	Public Data Network or Packet Data Network
PDP	Packet Data Protocol, <i>Any protocol which transmits data as discrete units known as packets, e.g., IP, or X.25.</i>
RAB	Radio Access Bearer [15] i.e. 3GPP TS 23.107
RNTI	Radio Network Temporary Identifier <i>A CRC is attached to each DCI message payload. The identity of the terminal (or terminals) addressed, that is, the RNTI, is included in the CRC calculation but not explicitly transmitted. Depending on the purpose of the DCI message (unicast data transmission, power-control command, random-access response, etc.), different RNTIs are used; For example, for normal unicast data transmission, the terminal-specific C-RNTI is used [1] section 16.4.7</i>
RTP	Real Time Protocol
SGSN	Serving GPRS Support Node
SMS	Short Message Service
TEID	Tunnel End-point Identifier
TMGI	Temporary Mobile Group Identity, <i>Temporary Mobile Group Identity (TMGI) is used for MBMS notification purpose. The BM-SC allocates a globally unique TMGI per MBMS bearer service. For Multicast MBMS bearer services the TMGI is transmitted to UE via the MBMS Multicast Service Activation procedure. For broadcast Service the TMGI can be obtained via service announcement see "Service Announcement". The TMGI is a radio resource efficient MBMS bearer service identification, which is equivalent to the MBMS bearer service identification consisting of IP multicast address and APN (Access Point Name). 3GPP TS 23.246 [4]</i>
TTI	Transmission Timing Interval
UE	User Equipment
UTRAN	UMTS Terrestrial Radio Access Network
VASP	Value Added Service Provider, <i>Typically associated to the multimedia services.</i>

The most of the abbreviations are referred from [14] i.e. 3GPP TR 21.905.

11 REFERENCES

- [1] 3G Evolution : HSPA and LTE for Mobile Broadband, 2nd edition by Erik Dahlmann Stefan Parkvall, Johan Skold and Per Beming, published in 2008
- [2] EVOLVED PACKET SYSTEM (EPS) THE LTE AND SAE EVOLUTION OF 3G UMTS by Pierre Lescuyer and Thierry Lucidarme, published in 2008
- [3] 3GPP TS 22.146 V8.4.0 (2008-06) : Technical Specification Group Services and System Aspects, Multimedia Broadcast/Multicast Service, Stage 1 (Release 8)
- [4] 3GPP TS 23.246 V9.5.0 (2010-06) : Technical Specification Group Services and System Aspects; Multimedia Broadcast/Multicast Service (MBMS); Architecture and functional description (Release 9)
- [5] 3GPP TS 36.300 V9.4.0 (2010-06) : Evolved Universal Terrestrial Radio Access (E-UTRA) and Evolved Universal Terrestrial Radio Access Network (E-UTRAN); Overall description; Stage 2 (Release 9)
- [6] Overview of 3GPP Release 11 V0.0.4 (2010-09)
- [7] Overview of 3GPP Release 10 V0.0.8 (2010-09)
- [8] Overview of 3GPP Release 9 V0.1.1 (2010-09)
- [9] 3GPP TS 32.273 Telecommunication management; Charging management; Multimedia Broadcast and Multicast Service (MBMS) charging.
- [10] 3GPP TS 33.220 Generic Authentication Architecture (GAA); Generic Bootstrapping Architecture (GBA)
- [11] 3GPP TS 33.246 3G Security; Security of Multimedia Broadcast/Multicast Service (MBMS)
- [12] 3GPP TS 26.346 V9.4.0 (2010-09) : Multimedia Broadcast/Multicast Service (MBMS); Protocols and codecs
- [13] WCDMA FOR UMTS HSPA Evolution and LTE 5th Edition, Edited by Harri Holma and Antti Toskala, Nokia Siemens Networks, Finland, published in 2010.
- [14] 3GPP TR 21.905 V10.2.0 (2010-03) : Vocabulary for 3GPP Specifications (Release 10)
- [15] 3GPP TS 23.107 V9.1.0 (2010-06) : Quality of Service (QoS) concept and architecture (Release 9)
- [16] 3GPP TS 22.246 V9.0.0 (2010-01) : Multimedia Broadcast/Multicast Service (MBMS) user services; Stage 1 (Release 9)

- [17] 3GPP TS 36.321 V9.3.0 (2010-06) : Evolved Universal Terrestrial Radio Access (E-UTRA); Medium Access Control (MAC) protocol specification (Release 9)
- [18] 3GPP RCD-11002 : MBMS support in E-UTRAN presented in 3GPP-DVB Workshop Kansas City, USA 16th March 2011, by Thomas Salzer from Huawei Technologies
- [19] 3GPP TR 26.946 V9.0.0 (2009-12) : Multimedia Broadcast/Multicast Service (MBMS) User service guidelines (Release 9)
- [20] 3GPP TS 23.003 V9.6.0 (2011-03) : Numbering, addressing and identification (Release 9)
- [21] 3GPP TS 23.246 V10.0.0 (2011-03) : Multimedia Broadcast/Multicast Service (MBMS): Architecture and Functional description (Release 10)
- [22] 3GPP TS 36.331 V9.6.0 (2011 – 03) : Evolved Universal Terrestrial Radio Access (E-UTRA);Radio Resource Control (RRC);Protocol specification(Release 9)
- [23] 3GPP TS 36.213 V9.3.0 (2010 – 09) : Evolved Universal Terrestrial Radio Access (E-UTRA); Physical layer procedures (Release 9)
- [24] ANIS Muhammad Moiz, LAGRANGE Xavier, PYNDIAH Ramesh, “Cellular-based Real-Time Flow Repair for Broadcast Flows. IEEE transactions on broadcasting”, september 2015, vol. 61, n° 3, pp. 457-469
- [25] RP-142205, 3GPP TSG RAN Meeting #66, Maui, Hawaii, USA, December 8 - 11, 2014
- [26] 3GPP TS 23.246 V13.3.0 (2015-12) : Technical Specification Group Services and System Aspects; Multimedia Broadcast/Multicast Service (MBMS); Architecture and functional description (Release 13)

Campus de Brest

Technopôle Brest-Iroise
CS 83818
29238 Brest Cedex 3
France
+33 (0)2 29 00 11 11

Campus de Rennes

2, rue de la Chataigneraie
CS 17607
35576 Cesson Sévigné Cédex
France
+33 (0)2 99 12 70 00

Campus de Toulouse

10, avenue Edouard Belin
BP 44004
31028 Toulouse Cedex 04
France
+33 (0)5 61 33 83 65

www.telecom-bretagne.eu

© Télécom Bretagne, 2016
Imprimé à Télécom Bretagne
Dépôt légal : Mars 2016
ISSN : 1255-2275

