



HAL
open science

Phylogenetic trees and the tropical geometry of flag varieties

Christopher Manon

► **To cite this version:**

Christopher Manon. Phylogenetic trees and the tropical geometry of flag varieties. 24th International Conference on Formal Power Series and Algebraic Combinatorics (FPSAC 2012), 2012, Nagoya, Japan. pp.503-514, 10.46298/dmtcs.3058 . hal-01283109

HAL Id: hal-01283109

<https://hal.science/hal-01283109>

Submitted on 5 Mar 2016

HAL is a multi-disciplinary open access archive for the deposit and dissemination of scientific research documents, whether they are published or not. The documents may come from teaching and research institutions in France or abroad, or from public or private research centers.

L'archive ouverte pluridisciplinaire **HAL**, est destinée au dépôt et à la diffusion de documents scientifiques de niveau recherche, publiés ou non, émanant des établissements d'enseignement et de recherche français ou étrangers, des laboratoires publics ou privés.

Phylogenetic trees and the tropical geometry of flag varieties

Christopher Manon^{1 †}

¹Department of Mathematics, University of California at Berkeley, Berkeley, CA 94720-3840 USA

Abstract. We will discuss some recent theorems relating the space of weighted phylogenetic trees to the tropical varieties of each flag variety of type A . We will also discuss the tropicalizations of the functions corresponding to semi-standard tableaux, in particular we relate them to familiar functions from phylogenetics. We close with some remarks on the generalization of these results to the tropical geometry of arbitrary flag varieties. This involves the family of Bergman complexes derived from the hyperplane arrangements associated to simple Dynkin diagrams.

Résumé. Nous allons discuter de quelques théorèmes récents concernant l'espace des arbres phylogénétiques aux variétés Tropicales de chaque variété de drapeaux de type A . Nous allons également discuter des tropicalizations des fonctions correspondant à tableaux semi-standard, en particulier, nous les rapporter à des fonctions familières de la phylogénétique. Nous terminerons avec quelques remarques sur la généralisation de ces résultats à la géométrie tropicale de variétés de drapeaux arbitraires. Il s'agit de la famille de complexes Bergman provenant des arrangements d'hyperplans associés à des diagrammes de Dynkin simples.

Keywords: Combinatorial Representation Theory, Flag Variety, Phylogenetics, Tropical Geometry

This abstract deals with three subjects, flag varieties, tropical geometry, and phylogenetics, all of which with their own distinct mathematical language. We will ease the discussion by giving a brief introduction to the elements of each subject that we will need.

0.1 Flag Varieties

Flag varieties for a reductive group G are the algebro-geometric analogue of an irreducible representation of G . Recall that these representations are indexed by the lattice points λ , the dominant weights, in a convex cone Δ called the Weyl chamber. Recall that each such representation has a unique highest-weight vector $v_\lambda \in V(\lambda)$. For $SL_m(\mathbb{C})$ one such Weyl chamber is given below.

$$\Delta_{SL_m(\mathbb{C})} = \{(a_1, \dots, a_{m-1}) \mid a_i \geq a_j, i < j\} \quad (1)$$

This cone is generated by the vectors $\omega_k = (1, \dots, 1, 0, \dots, 0)$, where the first k entries are 1. These lie on the extremal rays of the cone. The representation $V(\omega_k)$ corresponding to ω_k is the k - exterior product of the vector space \mathbb{C}^m , and the highest weight vector of this representation is the exterior product

[†]This work was supported by the NSF fellowship DMS-0902710

$z_1 \wedge \dots \wedge z_k$. For the basics of representation theory of reductive groups see the book *Representation Theory, A First Course*, GTM, Vol. 129, Springer, 1991, by Fulton and Harris.

$$V(\omega_k) = \bigwedge^k (\mathbb{C}^m) \quad (2)$$

A flag variety G/P is a quotient of a reductive group G by a parabolic subgroup $P \subset G$. Roughly speaking, parabolic subgroups are the stabilizers of highest weight vectors. Any flag variety G/P can be found as the orbit $G \circ [v_\lambda] \subset \mathbb{P}(V(\lambda))$ through the point represented by the highest weight vector in some representation of G . In particular, flag varieties are projective. We will be concerned with projective coordinate ring R_λ of G/P corresponding to this embedding. This algebra has the structure of a G -representation, we give its isotypical decomposition below.

$$R_\lambda = \bigoplus_{N \geq 0} H^0(G/P, L_\lambda^{\otimes N}) = \bigoplus_{N \geq 0} V(N\lambda^*) \quad (3)$$

This decomposition is multiplicity-free, and the representations appearing are exactly the non-negative integer multiples of the dual weight λ^* . These are the lattice points in Δ on the ray through the dual weight λ^* . For the group $G = SL_m(\mathbb{C})$, let $P_{k,m}$ be the parabolic subgroup of $SL_m(\mathbb{C})$ of the form

$$\begin{bmatrix} A & B \\ 0 & C \end{bmatrix}$$

where A is $k \times k$. The flag variety corresponding to this parabolic subgroup is the Grassmannian variety of k -planes in the vector space \mathbb{C}^m .

$$SL_m(\mathbb{C})/P_{k,m} \cong Gr_k(\mathbb{C}^m) = SL_m(\mathbb{C}) \circ [z_1 \wedge \dots \wedge z_k] \subset \mathbb{P}(\bigwedge^k (\mathbb{C}^m)) \quad (4)$$

The projective coordinate ring given by this embedding of the Grassmannian is called the Plücker algebra, it is a classical object from invariant theory. For more on the Plücker algebra and its degenerations see the book *Combinatorial Commutative Algebra*, GTM, Vol. 227, Springer, 2005 by Miller and Sturmfels.

$$R_{\omega_i} = \bigoplus_{N \geq 0} V(N\omega_k^*) = \mathbb{C}[\dots z_{i_1 \dots i_k} \dots] / I_{k,m} \quad (5)$$

Here we show the Plücker algebra as presented on $\binom{m}{k}$ generators by the Plücker ideal $I_{k,m}$. The Grassmannians play a prominent role in what follows.

0.2 Tropical Geometry

The tropical variety $tr(I)$ of an ideal $I \subset \mathbb{C}[x_1, \dots, x_n]$ is a combinatorial replacement for the algebraic variety $V(I)$. We briefly review how to construct $tr(I)$. We denote the tropical real line $\mathbb{R} \cup \{-\infty\}$ with \mathbb{T} . This set has the structure of a semi-field, with the following binary operations.

$$a \oplus b = \max(a, b) \quad (6)$$

$$a \otimes b = a + b \quad (7)$$

The element $0 \in \mathbb{T}$ is the tropical multiplicative identity, and $-\infty$ is the tropical additive identity. Notice that there are multiplicative inverses in \mathbb{T} for non-infinite elements, but no additive inverses. For a polynomial $f \in \mathbb{C}[x_1, \dots, x_n]$ we can build a tropical polynomial as follows.

$$T(f) = \bigoplus_{C_m \neq 0} \left(\bigotimes_{i=1}^n x_i^{\otimes m_i} \right) = \max\left\{ \dots, \sum_{i=1}^n m_i x_i, \dots \right\} \tag{8}$$

We use this tropical polynomial to define a tropical hypersurface in \mathbb{T}^n . A point \vec{p} is in $tr(f) \subset \mathbb{T}^n$ if two of the monomials in the above expression are equal to each other and greater than or equal to all other monomials in that expression when evaluated on \vec{p} . When this condition is met at \vec{p} we say that \vec{p} satisfies the tropical equation $T(f)$. Now we define the tropical variety $tr(I)$ to be the intersection of the tropical hypersurfaces defined by the polynomials in I .

$$tr(I) = \bigcap_{f \in I} tr(f) \tag{9}$$

Note that this intersection is infinite. In their paper *Computing Tropical Varieties*, Journal of Symbolic Computation, V 42, pg 54-73, Bogart, Jensen, Speyer, Sturmfels, and Thomas show that there is always a finite set of generators of I which suffice to cut out $tr(I)$, however it does not suffice to take any generating set. A set of polynomials in I with this property is said to be a tropical basis of I .

0.3 Weighted Phylogenetic Trees

We now describe a topological space \mathcal{T}^n used in mathematical biology to construct phylogenies between taxa. The reader should keep in mind throughout this construction that we are actually describing a particular tropical variety of a flag variety. A weighted phylogenetic tree (T, w) is a tree T with n leaves labeled by the set $\{1, \dots, n\}$, with an assignment of real numbers to the edges of T such that all assignments to internal edges of the tree are non-negative. For a fixed tree T we denote by P_T the space of all such assignments, we have

$$P_T \cong \mathbb{R}_{\geq 0}^{Edge(T) - Leaf(T)} \times \mathbb{R}^{Leaf(T)}. \tag{10}$$

The space \mathcal{T}^n is built out of the spaces P_T as T runs over all possible leaf-labeled trees T with internal vertices of valence at least 3. These spaces are glued together via certain combinatorially admissible maps on the trees T . We say a map $\pi : T \rightarrow T'$ is a map of n -trees if it is a surjective map of trees which respects the edge labels and collapses a collection of internal edges of T . Such a map defines a map of cones $\pi^* : P_{T'} \rightarrow P_T$ calculated by extending a weight on T' to T by 0 over the edges collapsed by π . We defined \mathcal{T}^n to be the space obtained by gluing the P_T together along these maps, see Figure 2.

These spaces were studied in the paper *The Geometry of the Space of Phylogenetic Trees*, Adv. in Appl. Math, 1999, 733-767 by Billera, Holmes, and Vogtman, and serve as an output set for algorithms which compute ancestral relationships between n taxa. Next we introduce some functions on \mathcal{T}^n which serve as coordinates for (T, w) . In practice, the structure of the tree underlying a given set of taxa is not known-a priori, so it must be constructed from experimentally measured quantities that make sense for any tree.

Definition 0.1 (Dissimilarity Functions) For a set of indices $i_1, \dots, i_m \subset \{1, \dots, n\}$ the dissimilarity function $d_{i_1, \dots, i_m} : \mathcal{T}^n \rightarrow \mathbb{R}$ takes a tree (T, w) to the sum of the weights on the edges in the minimal subtree of T containing the leaves i_1, \dots, i_m .

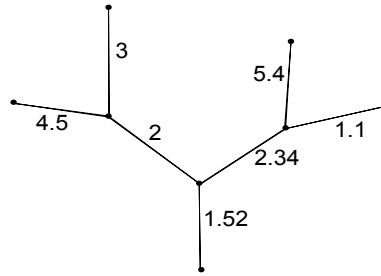

Fig. 1: A weighted tree

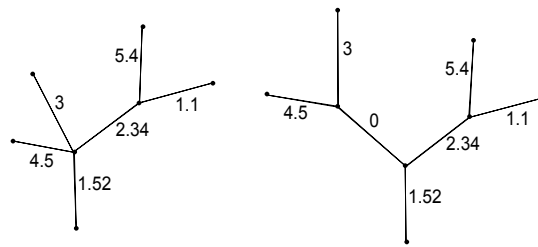

Fig. 2: Using a collapsing map to extend by 0

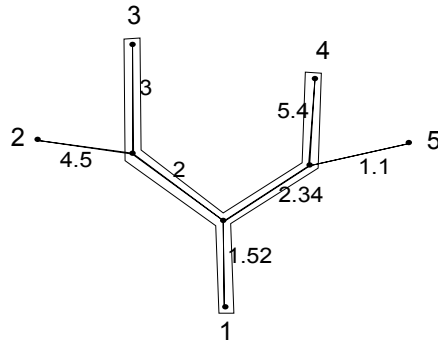
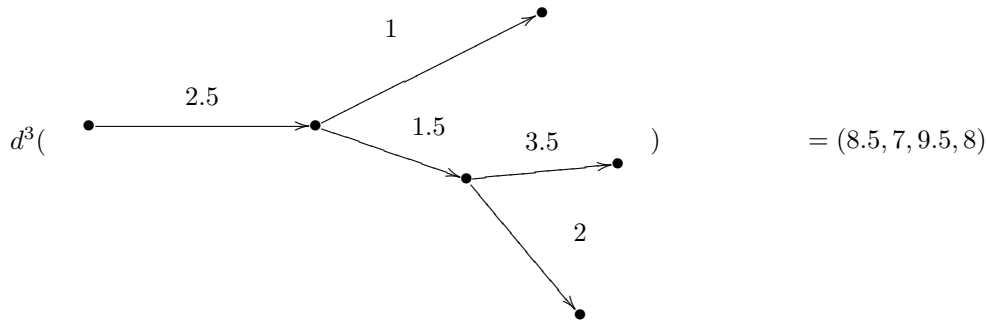

Fig. 3: $d_{134}(T, w) = 14.26$

For a choice of $m < n$ we call the $\binom{m}{n}$ -vector $d^m(T, w) = (\dots, d_{i_1, \dots, i_m}(T, w), \dots)$ the m -dissimilarity vector of $(T, w) \in \mathcal{T}^n$.



These quantities can be measured experimentally, and are used to reconstruct (T, w) . For example, one such method employs the 2-dissimilarity vector $d^2 : \mathcal{T}^n \rightarrow \mathbb{R}^{\binom{n}{2}}$. For this reason it is useful to have a criteria to determine when a given $\binom{n}{2}$ vector comes from a tree. This is where tropical geometry enters the picture.

0.4 2-Dissimilarity Vectors and $tr(I_{2,n})$

The following theorem of Speyer and Sturmfels gives a tropical criterion for determining when a $\binom{n}{2}$ vector comes from a phylogenetic n -tree. It appears in their paper *The Tropical Grassmannian*, Adv. Geom. 4, no. 3, (2004), 389-411.

Theorem 0.2 *The image of d^2 coincides with $tr(I_{2,n})$.*

Recall the Plücker algebra $R_{\omega_2} = \mathbb{C}[\dots z_{ij} \dots]/I_{2,n}$. The Plücker ideal $I_{2,n}$ is generated by the forms

$$z_{ij}z_{kl} - z_{ik}z_{jl} + z_{il}z_{jk} \tag{11}$$

for $1 \leq i < j < k < l \leq n$. Speyer and Sturmfels show that these constitute a tropical basis of $I_{2,n}$. From this it follows that a point $\vec{p} \in \mathbb{R}^{\binom{n}{2}}$ is the dissimilarity vector of a phylogenetic n -tree if and only if it satisfies

$$\max\{d_{ij} + d_{kl}, d_{ik} + d_{jl}, d_{il} + d_{jk}\} \quad (12)$$

This relationship between the tropical Plücker relations and the space of Phylogenetic trees lead Pachter and Speyer to investigate properties of the higher dissimilarity vectors. In *Reconstructing Trees From Subtree Weights*, Applied Math. Let. 17 (2004), 615 - 621, they establish that when $2m < n$ the map $d^m : \mathcal{T}^n \rightarrow \mathbb{R}^{\binom{n}{m}}$ is 1 - 1. Speyer and Pachter remark that experimentally measured m -dissimilarity vectors provide a more accurate reconstruction of the underlying phylogenetic tree, so there are applications of these results to mathematical biology. This is the motivation for finding equations in $\binom{n}{m}$ variables which are satisfied by the image of d^m . To this point, Pachter and Speyer asked whether or not $d^m(\mathcal{T}^n)$ lies in the tropical variety $tr(I_{m,n})$. This question was investigated by Cools, *On The Relation Between Weighted Trees and Tropical Grassmannians*, J. Symb. Comp. Volume 44 , Issue 8 (August 2009), Pages: 1079-1086, where he showed that this is the case for $m = 3, 4$ and gave strong evidence for the statement to hold when $m = 5$, leading him to conjecture that it did indeed hold for all m .

Theorem 0.3 (Iriarte-Giraldo, M)

$$d^m(\mathcal{T}^n) \subset tr(I_{m,n}) \subset \mathbb{R}^{\binom{n}{m}} \quad (13)$$

This conjecture was proved by the author in *Dissimilarity Vectors and The Representation Theory of $SL_m(\mathbb{C})$* , J. Alg. Comb. 2011 33: 199-213, and by Iriarte-Giraldo in *Dissimilarity Vectors of Trees are Contained in the Tropical Grassmannian*, The Electronic Journal of Combinatorics 17, no 1, (2010), with different techniques. We next describe our approach to this result as a warm up for the general result on flag varieties.

0.5 Tropical Theory: Valuations

Computing tropical bases is difficult, and the classical Plücker relations derived from invariant theory cease to be a tropical basis in general for $m > 2$, so we resorted to a different technique: tropical lifting. This involves the use of valuations which continue the trivial valuation on \mathbb{C} .

Definition 0.4 By a valuation $v : A \rightarrow \mathbb{T}$ on a commutative algebra A over \mathbb{C} we mean a function to the tropical line which satisfies the following conditions.

1. $v(ab) = v(a) \otimes v(b)$
2. $v(a + b) \leq v(a) \oplus v(b)$
3. $v(C) = 0$ for $C \neq 0 \in \mathbb{C}$
4. $v(0) = -\infty$

Note the use of the tropical algebraic operations. We let $\mathbb{V}_{\mathbb{T}}(A)$ be the set of all valuations on A . For our purposes this set has the structure of a topological space, but it actually the Berkovich analytification of A over the trivial valuation on \mathbb{C} , see Payne’s paper *Analytification is The Limit of All Tropicalizations*, Math. Res. Lett. 16 (2009), no. 3, 543 - 556. Analytifications belong in the world of tropical geometry because of the following theorem, which appears in Payne’s paper.

Theorem 0.5 (Payne) *For any presentation*

$$0 \longrightarrow I \longrightarrow \mathbb{C}[X] \longrightarrow A \longrightarrow 0$$

there is a surjective map $\pi_X : \mathbb{V}_{\mathbb{T}}(A) \rightarrow \text{tr}(I)$ given by $\pi_X(v) = (\dots v(x_i) \dots)$. Furthermore, the analytification can be recovered from tropical geometry as an inverse limit of topological spaces.

$$\mathbb{V}_{\mathbb{T}}(A) \cong \varprojlim \text{tr}(I) \tag{14}$$

Here the limit is over all presentations of A .

The content of this theorem is that one can build structures in every tropical variety attached to an algebra A by constructing them in the analytification. This is our strategy: for a phylogenetic tree (T, w) , build a valuation on the Plücker algebra R_{ω_m} which evaluates z_{i_1, \dots, i_m} to $d_{i_1, \dots, i_m}(T, w)$. In order to do this we take advantage of the representation theory structures on the Plücker algebra. We use the following realization of the Plücker algebra R_{ω_m} as a direct sum of spaces of invariant vectors in tensor products of $SL_m(\mathbb{C})$ representations, it is a consequence of the first fundamental theorem of invariant theory.

$$R_{\omega_m} = \bigoplus_{\vec{r} \in \mathbb{Z}_{\geq 0}^m} (V(r_1\omega_1^*) \otimes \dots \otimes V(r_m\omega_m^*))^{SL_m(\mathbb{C})} \tag{15}$$

These spaces of invariants count the multiplicities of $SL_m(\mathbb{C})$ representations in tensor products of $SL_m(\mathbb{C})$ representations by the following identity.

$$(V(r_1\omega_1^*) \otimes \dots \otimes V(r_m\omega_m^*))^{SL_m(\mathbb{C})} = \text{Hom}(V(r_1\omega_1), V(r_2\omega_1^*) \otimes \dots \otimes V(r_m\omega_1^*)) \tag{16}$$

The representation $V(r_2\omega_1^*) \otimes \dots \otimes V(r_m\omega_1^*)$ is also an irreducible representation of SL_m^{n-1} , and the space above counts how many times $V(r_1\omega_1)$ appears in the restriction of this representation to the diagonal copy of $SL_m(\mathbb{C})$ in $SL_m(\mathbb{C})^{n-1}$, this is an example of a branching problem.

In general, the branching problem for a map $\phi : H \rightarrow G$ of reductive groups is a computation of the multiplicity space $\text{Hom}_H(V(\eta), V(\lambda))$ for η and λ dominant weights of H and G respectively. These problems are frequent sources of beautiful combinatorial formulas, such as the Pierri rule and the Littlewood-Richardson formula. One method an algebraist or combinatorialist can use to study the branching problem for ϕ is to associate to it a commutative algebra $R(\phi)$, called the branching algebra.

$$R(\phi) = \bigoplus_{\eta, \lambda \in \Delta_H \times \Delta_G} \text{Hom}_H(V(\eta), V(\lambda)) \tag{17}$$

The algebra $R(\phi)$ is finitely generated over \mathbb{C} . Let $\delta_{n-1} : SL_m \rightarrow SL_m^{n-1}$ be the diagonal map mentioned above, our remarks imply that the Plücker algebra is a subalgebra of $R(\delta_{n-1})$.

$$R_{\omega_m} \subset R(\delta_{n-1}) \tag{18}$$

We construct the required valuations by employing the following theorem, which can be found in our preprint *Toric Degenerations and Tropical Geometry of Branching Algebras*, (2011) <http://arxiv.org/abs/1103.2484>.

Theorem 0.6 (M) For every factorization of ϕ

$$H \xrightarrow{\phi_1} G_1 \longrightarrow \dots \longrightarrow G_{k-1} \xrightarrow{\phi_k} G,$$

there is a cone of valuations $D_{\vec{\phi}}$ in $\mathbb{V}_{\mathbb{T}}(R(\phi))$.

With this theorem in mind, the strategy is to turn n -trees T into factorizations of the diagonal morphism δ_{n-1} . An example of this is illustrated below.

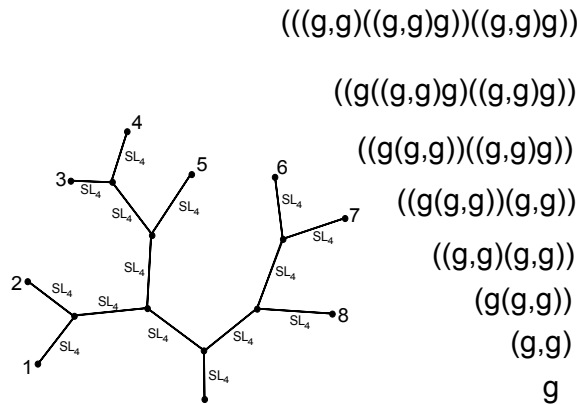
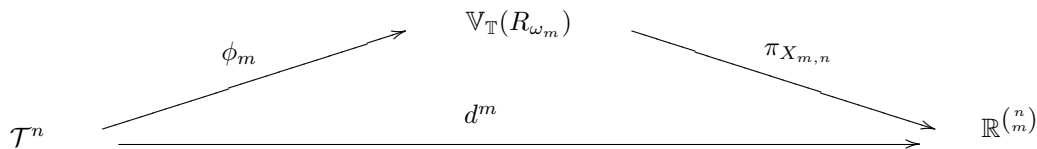

Fig. 4: A factorization of the map $\delta_8 : SL_4(\mathbb{C}) \rightarrow SL_4(\mathbb{C})^8$ by diagonal maps.

The idea is to label the leaves of the tree with $0, \dots, n - 1$, and assign an $SL_m(\mathbb{C})$ to each edge of the tree T . This determines a chain of subgroups of $SL_m(\mathbb{C})^{n-1}$ which all contain the diagonal subgroup, and therefore a cone in $\mathbb{V}_{\mathbb{T}}(R_{\omega_m})$, which can be shown to be isomorphic to P_T .

Theorem 0.7 (M) For each metric tree (T, w) there is a valuation $v_{T,w} \in \mathbb{V}_{\mathbb{T}}(R_{\omega_m})$ satisfying $v_{\mathcal{T},w}(z_{i_1,\dots,i_m}) = d_{i_1,\dots,i_m}(T, w)$ for all Plücker generators z_{i_1,\dots,i_m}

This defines a 1 - 1 map $\phi_m : \mathcal{T}^n \rightarrow \mathbb{V}_{\mathbb{T}}(R_{\omega_m})$



0.6 The Space of Phylogenetic Trees and Flag Varieties

We can use the same methods to show that \mathcal{T}^n can be found in general flag varieties of type A . We first briefly return to representation theory of $GL_n(\mathbb{C})$. Recall that irreducible representations in type A are indexed by the cone of lists of non-increasing, non-negative real numbers. The lattice points in this cone can be represented by Young diagrams, as on the left below.

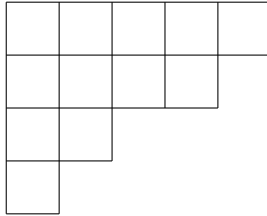

1	1	2	4	5
3	3	3	6	
4	5			
5				

Just as $V(\omega_m)$ has a distinguished basis of Plücker generators, the irreducible representation $V(\lambda)$ associated to a weight λ has a distinguished basis labeled by so-called semi-standard fillings of the Young diagram. These are assignments of numbers in $\{1, \dots, n\}$ to the boxes of λ such that each column is strictly increasing from top to bottom, and each row is weakly increasing from left to right. Notice that we recover the Plücker basis of $V(\omega_m)$ as the semi-standard fillings of a diagram with one column of length m .

1
3
4
5
6

$$z_1 \wedge z_3 \wedge z_4 \wedge z_5 \wedge z_6$$

Just as each Plücker basis member z_{i_1, \dots, i_m} determines a function $d_{i_1, \dots, i_m} : \mathcal{T}^n \rightarrow \mathbb{R}$, it is natural to ask if such a construction exists for a semi-standard filling τ .

Definition 0.8 We define $d_\tau : \mathcal{T}^{n+1} \rightarrow \mathbb{R}$ to be $\sum d_{I_k, 0}$, where I_k are the columns of τ .

The following theorem shows that these functions d_τ serve as tropicalizations of the canonical basis of $V(\lambda)$, it appears in our preprint *Toric Degenerations and Tropical Geometry of Branching Algebras*.

Theorem 0.9 Let R_λ be a projective coordinate ring of the flag variety $GL_n(\mathbb{C})/P$, and let I_λ be the ideal that presents R_λ . There is a map $d^\lambda : \mathcal{T}^{n+1} \rightarrow \text{tr}(I_\lambda)$ where $d^\lambda = (d_{\tau_1}, \dots, d_{\tau_t})$

This theorem is proved with the same branching techniques, by using Theorem 0.6 on the map $i_{GL_n(\mathbb{C})} : 1 \rightarrow GL_n(\mathbb{C})$. This map has branching algebra

$$R(i_{GL_n(\mathbb{C})}) = \bigoplus_{\lambda \in \Delta} V(\lambda) \tag{19}$$

Notice that $R_\lambda \subset R(i_{GL_n(\mathbb{C})})$ for any $\lambda \in \Delta$. The Plücker algebra R_{ω_k} has two different branching algebra structures. Also, any chain of subgroups $G_0 \subset \dots \subset G_k = GL_n(\mathbb{C})$ defines a cone of valuations on $R(i_{GL_n(\mathbb{C})})$. The strategy is then to find a way to turn phylogenetic trees in chains of subgroups of $GL_n(\mathbb{C})$. This is illustrated below.

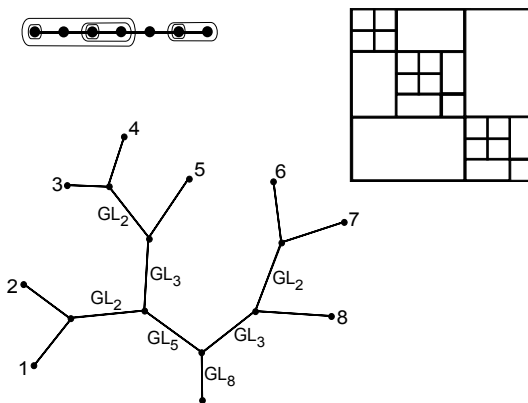

Fig. 5: A factorization of $i_{GL_8(\mathbb{C})} : 1 \rightarrow GL_8(\mathbb{C})$ by Levi subgroups.

To each edge $e \in Edge(T)$ we assign a copy of $GL_k(\mathbb{C})$, where k is the number of leaves above e . This copy of $GL_k(\mathbb{C})$ is embedded in $GL_n(\mathbb{C})$ as the subgroup which acts on the indices i_1, \dots, i_k over e . These chains of subgroups are the tools used to prove the above theorem.

0.7 Final Remarks

The last theorem shows that the space of Phylogenetic trees \mathcal{T}^n has a close relationship with the tropical geometry of flag varieties of type A . We make some remarks on how this generalizes to other types. Theorem 0.6 is quite broad in its potential applications. In particular, the map $i_{GL_n(\mathbb{C})} : 1 \rightarrow GL_n(\mathbb{C})$ makes sense for any group in place of the general linear group. The proof of Theorem 0.9 uses a certain type of embedded $GL_n(\mathbb{C})$ to achieve the affinity with the combinatorics of \mathcal{T}^n . The subgroups obtained by this construction have natural generalizations for any reductive group called Levi subgroups.

For a simple group $G(\Gamma)$ with corresponding Dynkin diagram Γ , a certain class of Levi subgroups can be obtained from sub-diagrams of Γ . We indicate a collection of sub diagrams with a "tubing" of the Dynkin diagram, an example is shown below for D_9 .

These tubings can be associated to chains of Levi subgroups in $G(\Gamma)$, for example the tubing above corresponds to $1 \rightarrow [[SL_2(\mathbb{C})] \times SL_2(\mathbb{C})] \times [SL_2(\mathbb{C})^3] \rightarrow [SL_3(\mathbb{C}) \times SL_2(\mathbb{C})] \times [SL_2(\mathbb{C})^3] \rightarrow SL_5(\mathbb{C}) \times$

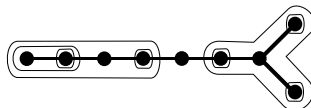

Fig. 6: A tubing of D_9 , corresponding to a factorization of $i_{SO_{18}(\mathbb{C})}$.

$SO_8(\mathbb{C}) \rightarrow SO_{18}(\mathbb{C})$. We have also illustrated an example tubing for type A in figure 5. In this way, the so-called Bergman fan $B(\Gamma)$ can be mapped into the tropical varieties of the flag varieties of $G(\Gamma)$. This fan is studied by Ardila, Reiner, and Williams for a general simple Dynkin diagram in their paper *Bergman Complexes, Coxeter Arrangements, and Graph Associahedra*, *Seminaire Lotharingien de Combinatoire*, 54A (2006), Article B54Aj). The Bergman fan has a distinguished subfan $B^+(\Gamma)$, which depends only on the underlying graph of the Dynkin diagram Γ . For example, $B^+(A_n)$ is the space of planar phylogenetic trees. A consequence of this observation is that the tropical varieties of the flag varieties of $G(\Gamma)$ see a version of the space of phylogenetic trees whenever Γ has a subgraph with the same underlying graph as some type A Dynkin diagram. A quick inspection of the simple Dynkin diagrams in Figure 7 leads to the punchline of this abstract: this happens quite a lot.

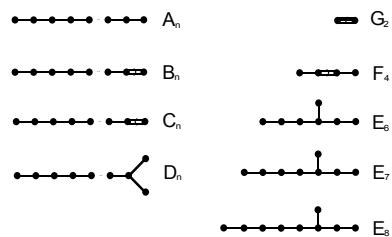

Fig. 7: Simple Dynkin diagrams

