



**HAL**  
open science

# REWRITING IN HIGHER DIMENSIONAL LINEAR CATEGORIES AND APPLICATION TO THE AFFINE ORIENTED BRAUER CATEGORY

Clément Alleaume

► **To cite this version:**

Clément Alleaume. REWRITING IN HIGHER DIMENSIONAL LINEAR CATEGORIES AND APPLICATION TO THE AFFINE ORIENTED BRAUER CATEGORY. 2016. hal-01281219

**HAL Id: hal-01281219**

**<https://hal.science/hal-01281219>**

Preprint submitted on 1 Mar 2016

**HAL** is a multi-disciplinary open access archive for the deposit and dissemination of scientific research documents, whether they are published or not. The documents may come from teaching and research institutions in France or abroad, or from public or private research centers.

L'archive ouverte pluridisciplinaire **HAL**, est destinée au dépôt et à la diffusion de documents scientifiques de niveau recherche, publiés ou non, émanant des établissements d'enseignement et de recherche français ou étrangers, des laboratoires publics ou privés.

# REWRITING IN HIGHER DIMENSIONAL LINEAR CATEGORIES AND APPLICATION TO THE AFFINE ORIENTED BRAUER CATEGORY

Clément Alleaume

Univ Lyon, Université Claude Bernard Lyon 1, CNRS UMR 5208,  
Institut Camille Jordan, 43 blvd. du 11 novembre 1918, F-69622 Villeurbanne cedex, France  
clement.alleaume@univ-st-etienne.fr

**Abstract** – In this paper, we introduce a rewriting theory of linear monoidal categories. Those categories are a particular case of what we will define as linear  $(n, p)$ -categories. We will also define linear  $(n, p)$ -polygraphs, a linear adaptation of  $n$ -polygraphs, to present linear  $(n - 1, p)$ -categories. We focus then on linear  $(3, 2)$ -polygraphs to give presentations of linear monoidal categories. We finally give an application of this theory in linear  $(3, 2)$ -polygraphs to prove a basis theorem on the category  $\mathcal{AOB}$  with a new method using a rewriting property defined by van Oostrom: decreasingness.

## 1. INTRODUCTION

Affine walled Brauer algebras were introduced by Rui and Su [RS13] in the study of super Schur-Weyl duality. A result of [RS13] is the Schur-Weyl duality between general Lie superalgebras and affine walled Brauer algebras. A linear monoidal category, the affine oriented Brauer category  $\mathcal{AOB}$  was introduced in [BCNR14] to encode each walled Brauer algebra as one of its morphism spaces. This category is used to prove basis theorems for the affine walled Brauer algebras given in [RS13], which gives an explicit basis for each affine walled Brauer algebra. The proof of this theorem uses an intermediate result on cyclotomic quotients of  $\mathcal{AOB}$ . For each of those quotients, a basis is given. With these multiple bases, each morphism space of  $\mathcal{AOB}$  is given a generating family which is proved to be linearly independent.

Our aim is to give a constructive proof of the mentioned basis result. For this, we study  $\mathcal{AOB}$  in this article by rewriting methods. Rewriting is a model of computation presenting relations between expressions as oriented computation steps. There are multiple examples of rewriting systems. An abstract rewriting system [Hue80] is the data of a set  $S$  and a relation  $\rightarrow$  on  $S$  called the rewrite relation. A rewriting sequence from  $a$  to  $b$  is a finite sequence  $(u_0, u_1, \dots, u_{n-1}, u_n)$  of elements of  $S$  such that:

$$a = u_0,$$

$$b = u_n,$$

and for any  $0 \leq k < n$ , we have  $u_k \rightarrow u_{k+1}$ . A word rewriting system is the data of an alphabet  $A$  and a relation  $\Rightarrow$  on the free monoid  $A^*$  over  $A$ . We say that there is a rewriting step from a word  $u$  to a word  $v$  if there are words  $a, b, u'$  and  $v'$  such that:

$$u = au'b,$$

$$v = av'b,$$

$$u' \Rightarrow v'.$$

A higher dimensional generalization of such rewriting systems has been introduced by Burroni [Bur93] under the name of polygraph. An  $(n+1)$ -polygraph is a rewriting system on the  $n$ -cells of an  $n$ -category.

To study  $\mathcal{AOB}$  from a rewriting point of view, we will need to introduce the rewriting systems presenting monoidal linear categories. The objects giving such rewriting systems will be called linear  $(n, p)$ -polygraphs which are linear adaptations of  $n$ -polygraphs. Linear monoidal categories are a special case of what we will call linear  $(n, p)$ -categories. In this language, linear monoidal categories are linear  $(2, 2)$ -categories with only one 0-cell. They are presented by linear  $(3, 2)$ -polygraphs. Once those objects are defined, we will introduce the rewriting theory of linear  $(3, 2)$ -polygraphs. Once we have this theory, we will use it to construct bases for the morphism spaces of  $\mathcal{AOB}$ .

Rewriting can offer constructive proofs by giving presentations of objects with certain properties. For example, two properties studied in rewriting systems are termination and confluence. A rewriting system

is terminating if it has no infinite rewriting sequence, in which case all computations end. A rewriting system is confluent if any pair of rewriting sequences with the same source can be completed into a pair of rewriting sequences with the same target, in which case all computations lead to the same result. A rewriting system is said to be convergent if it is terminating and confluent. In the case of word rewriting, the property of convergence, the conjunction of termination and confluence, gives a way to decide the word problem, that is, deciding if two words in  $A^*$  are equal in the quotient of  $A^*$  by the relation  $\Rightarrow$ .

What we will do in the case of  $\mathcal{AOB}$  is giving a confluent presentation  $\overline{\mathcal{AOB}}$  of this linear  $(2, 2)$ -category with some others properties. Those properties will prove the bases given in [BCNR14] are indeed bases. The linear  $(3, 2)$ -polygraph  $\overline{\mathcal{AOB}}$  will not be terminating, which will prevent us to prove  $\overline{\mathcal{AOB}}$  is confluent by the use of Newman's lemma, a criterion needing termination to prove confluence from a weaker property called local confluence [Hue80]. To prove  $\overline{\mathcal{AOB}}$  is confluent, we will use a more general property called decreasingness introduced in [vO94]. We will prove  $\overline{\mathcal{AOB}}$  is decreasing and use the theorem from [vO94] stating decreasingness implies confluence.

In the first section, we recall first the notions of higher dimensional category theory. Then, we define linear  $(n, p)$ -categories, which will be our higher dimensional categories with linear structure. After defining them, we recall in the second section the categorical construction of the category of  $n$ -polygraphs given in [Mét08]. We define next the categorical construction of the category of linear  $(n, p)$ -polygraphs. We give their main rewriting properties, such than 4.2.15 in the case  $(n, p) = (3, 2)$  in which  $\mathcal{AOB}$  falls.

In the third section we will study the decreasingness property defined in the case of abstract rewriting systems by van Oostrom [vO94]. Then, in the last section, we recall from [BCNR14] the definition of the linear  $(2, 2)$ -category  $\mathcal{AOB}$ . This will lead us to give two linear  $(3, 2)$ -polygraphs presenting  $\mathcal{AOB}$ . Those linear  $(3, 2)$ -polygraphs will be called  $\mathcal{AOB}$  and  $\overline{\mathcal{AOB}}$ . The first one is a translation of the definition of  $\mathcal{AOB}$ .

The main result of this article, Theorem 5.2.9 states  $\overline{\mathcal{AOB}}$  is confluent. It will be proved with the properties of confluence of critical branchings and decreasingness. This theorem gives us the main result of [BCNR14] as an entirely constructive consequence given as corollary 5.2.10.

## ACKNOWLEDGMENTS

The author would like to thank Labex Milyon (ANR-10-LABX-0070). This work has been supported by the project *Cathre*, ANR-13BS02-0005-02.

## 2. LINEAR $(n, p)$ -CATEGORIES

This section and section 3 will recall the basic notions of  $n$ -category and  $n$ -polygraphs. The rewriting techniques used in this paper will be presented in the last two sections.

### 2.1. Preliminaries

We fix  $n$  an integer. We denote by **Set** the category of sets.

**2.1.1. Definition.** An  $n$ -graph in a category **C** is a diagram in **C**:

$$G_0 \begin{array}{c} \xleftarrow{s_0} \\ \xleftarrow{t_0} \end{array} G_1 \begin{array}{c} \xleftarrow{s_1} \\ \xleftarrow{t_1} \end{array} \cdots \begin{array}{c} \xleftarrow{s_{n-2}} \\ \xleftarrow{t_{n-2}} \end{array} G_{n-1} \begin{array}{c} \xleftarrow{s_{n-1}} \\ \xleftarrow{t_{n-1}} \end{array} G_n$$

such that for any  $1 \leq k \leq n-1$ , we have  $s_{k-1} \circ s_k = s_{k-1} \circ t_k$  and  $t_{k-1} \circ s_k = t_{k-1} \circ t_k$ . Those relations are called the *globular relations*. We just call an  $n$ -graph in **Set** an  $n$ -graph.

The elements of  $G_k$  are called  $k$ -cells. The maps  $s_k$  and  $t_k$  are respectively called  $k$ -source and  $k$ -target maps. For any  $l$ -cell  $u$  of  $G$  with  $l > k + 1$ , we respectively denote by  $s_k(u)$  and  $t_k(u)$  the  $k$ -cells  $(s_k \circ \cdots \circ s_{l-1})(u)$  and  $(t_k \circ \cdots \circ t_{l-1})(u)$ .

A morphism of  $n$ -graphs  $F$  from  $G$  to  $G'$  is a collection  $(F_k : G_k \rightarrow G'_k)$  of maps such that, for every  $0 < k \leq n$ , the following diagrams commute:

$$\begin{array}{ccc} & s_{k-1} & \\ & \longleftarrow & \\ G_{k-1} & & G_k \\ \downarrow F_{k-1} & & \downarrow F_k \\ G'_{k-1} & \xleftarrow{s'_{k-1}} & G'_k \end{array} \quad \begin{array}{ccc} & t_{k-1} & \\ & \longleftarrow & \\ G_{k-1} & & G_k \\ \downarrow F_{k-1} & & \downarrow F_k \\ G'_{k-1} & \xleftarrow{t'_{k-1}} & G'_k \end{array}$$

We call  $\mathbf{Grph}_n$  the category of  $n$ -graphs.

In particular,  $\mathbf{Grph}_0$  is the category  $\mathbf{Set}$  and  $\mathbf{Grph}_1$  is the category of directed graphs.

We can define  $n$ -categories by enrichment. A 0-category is a set. For  $n \geq 1$ , an  $n$ -category is a 1-category enriched in  $(n-1)$ -categories. We denote by  $\mathbf{Cat}_n$  the category of  $n$ -categories and  $n$ -functors. This category has a terminal object  $I_n$  with only one  $k$ -cell for  $0 \leq k \leq n$ .

In an  $n$ -category, for any  $0 \leq k < n$ , we denote the  $k$ -composition by  $\star_k$ . For all  $0 \leq i < j \leq n-1$  the following equality, called *exchange relation*, holds:

$$(u \star_i v) \star_j (u' \star_i v') = (u \star_j u') \star_i (v \star_j v'). \quad (1)$$

By forgetting its units and compositions, an  $n$ -category is in particular an  $n$ -graph. We now denote by  $\mathcal{U}_n$  the forgetful functor from  $\mathbf{Cat}_n$  to  $\mathbf{Grph}_n$ .

## 2.2. Linear $(n, p)$ -categories

In this section, we fix  $n$  an integer. We will define linear  $(n, p)$ -categories by induction on  $p \leq n$ . We will denote by  $\mathbf{Vect}$  the category of vector spaces over a fixed field.

**2.2.1. Definition.** An internal  $n$ -category in  $\mathbf{Vect}$  is the data of:

- an  $n$ -graph in  $\mathbf{Vect}$ :

$$V_0 \begin{array}{c} \xleftarrow{s_0} \\ \xleftarrow{t_0} \end{array} V_1 \begin{array}{c} \xleftarrow{s_1} \\ \xleftarrow{t_1} \end{array} \cdots \begin{array}{c} \xleftarrow{s_{n-2}} \\ \xleftarrow{t_{n-2}} \end{array} V_{n-1} \begin{array}{c} \xleftarrow{s_{n-1}} \\ \xleftarrow{t_{n-1}} \end{array} V_n$$

- for each  $0 \leq k < l \leq n$ , a linear unit map  $v \mapsto 1_v$  from  $V_k$  to  $V_{k+1}$ . Linearity of the unit maps gives us the following relation:

$$1_{\lambda u + \mu v} = \lambda 1_u + \mu 1_v \quad (2)$$

for any scalars  $\lambda$  and  $\mu$  and any  $k$ -cells  $u$  and  $v$  such that  $p \leq k < n$ ,

- for each  $0 \leq k < l \leq n$ , a linear composition map  $\star_k$  from  $V_l \times_{V_k} V_l$  to  $V_k$ . Linearity of the unit maps gives us the following properties:

$$(f + g) \star_k (f' + g') = f \star_k f' + g \star_k g', \quad (3)$$

$$\lambda f \star_k \lambda f' = \lambda (f \star_k f'). \quad (4)$$

for any scalar  $\lambda$  and any pairs  $(f, f')$  and  $(g, g')$  of  $k$ -composable  $l$ -cells such that  $p \leq k < l \leq n$  verifying the axioms of  $n$ -categories.

Internal  $n$ -categories in **Vect** are also called  $(n + 1)$ -vector spaces [BC04], see also [KMP11].

**2.2.2. Definition.** A linear  $(n, 0)$ -category is an internal  $n$ -category in **Vect**. Let us assume linear  $(n, p)$ -categories are defined for  $p \geq 0$ . A linear  $(n + 1, p + 1)$ -category is the data of a set  $\mathcal{C}_0$  and:

- for each  $a$  and  $b$  in  $\mathcal{C}_0$ , a linear  $(n, p)$ -category  $\mathcal{C}(a, b)$ ,
- for each  $a$  in  $\mathcal{C}_0$ , an identity morphism  $i_a$  from the terminal  $n$ -category  $I_n$  to  $\mathcal{C}(a, a)$ ,
- for each  $a, b$  and  $c$  in  $\mathcal{C}_0$ , a bilinear composition morphism  $\star^{a,b,c}$  from  $\mathcal{C}(a, b) \times \mathcal{C}(b, c)$  to  $\mathcal{C}(a, c)$ .

such that:

- $\star^{a,c,d} \circ (\star^{a,b,c} \times \text{id}_{\mathcal{C}(c,d)}) = \star^{a,b,d} \circ (\text{id}_{\mathcal{C}(a,b)} \times \star^{b,c,d})$ ,
- $\star^{a,a,b} \circ (i_a \times \text{id}_{\mathcal{C}(a,b)}) \circ \text{is}_l = \text{id}_{\mathcal{C}(a,b)} = \star^{a,b,b} \circ (\text{id}_{\mathcal{C}(a,b)} \times i_b) \circ \text{is}_r$  where  $\text{is}_l$  and  $\text{is}_r$  respectively denote the canonic isomorphisms from  $\mathcal{C}(a, b)$  to  $I_n \times \mathcal{C}(a, b)$  and to  $\mathcal{C}(a, b) \times I_n$ .

**2.2.3. Remark.** In particular, a linear  $(n, p)$ -category is an  $n$ -category.

A morphism of linear  $(n, p)$ -categories from  $\mathcal{C}$  to  $\mathcal{C}'$  is an  $n$ -functor:

$$\begin{array}{ccccccc}
 \mathcal{C}_0 & \xleftarrow{s_0} & \mathcal{C}_1 & \xleftarrow{s_1} & \cdots & \xleftarrow{s_{n-2}} & \mathcal{C}_{n-1} & \xleftarrow{s_{n-1}} & \mathcal{C}_n \\
 & \xleftarrow{t_0} & & \xleftarrow{t_1} & & \xleftarrow{t_{n-2}} & & \xleftarrow{t_{n-1}} & \\
 F_0 \downarrow & & F_1 \downarrow & & & F_{n-1} \downarrow & & F_n \downarrow & \\
 \mathcal{C}'_0 & \xleftarrow{s'_0} & \mathcal{C}'_1 & \xleftarrow{s'_1} & \cdots & \xleftarrow{s'_{n-2}} & \mathcal{C}'_{n-1} & \xleftarrow{s'_{n-1}} & \mathcal{C}'_n \\
 & \xleftarrow{t'_0} & & \xleftarrow{t'_1} & & \xleftarrow{t'_{n-2}} & & \xleftarrow{t'_{n-1}} & 
 \end{array}$$

such that for any  $p \leq k \leq n$ , the map  $F_k$  is linear. We denote by  $\mathbf{LinCat}_{n,p}$  the category of linear  $(n, p)$ -categories. We denote by  $\mathcal{U}_{n,p}$  the forgetful functor from  $\mathbf{LinCat}_{n,p}$  to  $\mathbf{Grph}_n$ .

**2.2.4. Example.** A linear  $(1, 1)$ -category is just a linear category or a category enriched in vector spaces as introduced by Mitchell [Mit72].

**2.2.5. Remark.** Let  $\mathcal{C}$  be a linear  $(n, p)$ -category with  $0 \leq p < n$ . The underlying  $(n - 1)$ -category to  $\mathcal{C}$  is a linear  $(n - 1, p)$ -category. Indeed, there is an internal  $(n + p - 1)$ -graph in the category of vector spaces given by:

$$\mathcal{C}_p \xleftarrow{s_p} \mathcal{C}_{p+1} \xleftarrow{s_{p+1}} \cdots \xleftarrow{s_{n-3}} \mathcal{C}_{n-2} \xleftarrow{s_{n-2}} \mathcal{C}_{n-1}$$

$$\xleftarrow{t_p} \quad \xleftarrow{t_{p+1}} \quad \cdots \quad \xleftarrow{t_{n-3}} \quad \xleftarrow{t_{n-2}}$$

which can be completed into an  $(n - 1)$ -category:

$$\mathcal{C}_0 \xleftarrow{s_0} \mathcal{C}_1 \xleftarrow{s_1} \cdots \xleftarrow{s_{p-2}} \mathcal{C}_{p-1} \xleftarrow{s_{p-1}} \mathcal{C}_p \xleftarrow{s_p} \mathcal{C}_{p+1} \xleftarrow{s_{p+1}} \cdots \xleftarrow{s_{n-3}} \mathcal{C}_{n-2} \xleftarrow{s_{n-2}} \mathcal{C}_{n-1}$$

$$\xleftarrow{t_0} \quad \xleftarrow{t_1} \quad \cdots \quad \xleftarrow{t_{p-2}} \quad \xleftarrow{t_{p-1}} \quad \xleftarrow{t_p} \quad \xleftarrow{t_{p+1}} \quad \cdots \quad \xleftarrow{t_{n-3}} \quad \xleftarrow{t_{n-2}}$$

The source maps, target maps and composition maps of this  $(n - 1)$ -category meet all the requirements of a linear  $(n - 1, p)$ -category.

### 3. POLYGRAPHS

#### 3.1. n-Polygraphs

The notion of polygraph was introduced by Burroni [Bur93]. It was introduced independently by Street under the name of computad [Str87] as system of generators and relations for higher dimensional categories. Let us recall the constructions of the categories of n-categories with a globular extension and n-polygraphs from [Mét08].

**3.1.1. Definition.** The category  $\mathbf{Cat}_n^+$  of n-categories with a globular extension is defined by the following pullback diagram:

$$\begin{array}{ccc} \mathbf{Cat}_n^+ & \longrightarrow & \mathbf{Grph}_{n+1} \\ \downarrow & \lrcorner & \downarrow \mathcal{U}_n^G \\ \mathbf{Cat}_n & \xrightarrow{\quad} & \mathbf{Grph}_n \\ & \mathcal{U}_n & \end{array}$$

where  $\mathcal{U}_n^G$  is the functor from  $\mathbf{Grph}_{n+1}$  to  $\mathbf{Grph}_n$  associating to each  $(n + 1)$ -graph its underlying n-graph by eliminating the  $(n + 1)$ -cells.

In a diagrammatic way, a globular extension of an n-category  $\mathcal{C}$  is the data of a set  $\Gamma$  and of two maps  $s_n$  and  $t_n$  from  $\Gamma$  to  $\mathcal{C}_n$  forming an  $(n + 1)$ -graph:

$$\begin{array}{ccccccc} \mathcal{C}_0 & \xleftarrow{s_0} & \mathcal{C}_1 & \xleftarrow{s_1} & \cdots & \xleftarrow{s_{n-2}} & \mathcal{C}_{n-1} & \xleftarrow{s_{n-1}} & \mathcal{C}_n & \xleftarrow{s_n} & \Gamma \\ & \xleftarrow{t_0} & & \xleftarrow{t_1} & & \xleftarrow{t_{n-2}} & & \xleftarrow{t_{n-1}} & & \xleftarrow{t_n} & \end{array}$$

A morphism of n-categories with globular extension from  $(\mathcal{C}, \Gamma)$  to  $(\mathcal{C}', \Gamma')$  is the data of an n-functor  $F$  from  $\mathcal{C}$  to  $\mathcal{C}'$  and a map  $\varphi$  from  $\Gamma$  to  $\Gamma'$  such that  $(F, \varphi)$  makes a morphism of  $(n + 1)$ -graphs.

**3.1.2. Definition.** Let  $(\mathcal{C}, \Gamma)$  be an n-category with globular extension. The free  $(n + 1)$ -category over  $(\mathcal{C}, \Gamma)$  is the  $(n + 1)$ -category which underlying n-category is  $\mathcal{C}$  and which  $(n + 1)$ -cells are the compositions of elements of  $\Gamma$  and elements of the form  $1_u$  where  $u$  is in  $\mathcal{C}_n$ . The free functor from  $\mathbf{Cat}_n^+$  to  $\mathbf{Grph}_{n+1}$  is denoted by  $\mathcal{F}_{n+1}^W$ .

**3.1.3. Definition.**  $\mathbf{Pol}_0$  is the category of sets and the functor  $\mathcal{F}_0$  from  $\mathbf{Pol}_0$  to  $\mathbf{Cat}_0$  is the identity functor. Let us assume the category  $\mathbf{Pol}_n$  of n-polygraphs and the functor  $\mathcal{F}_n$  from  $\mathbf{Pol}_n$  to  $\mathbf{Cat}_n$  are defined. The category  $\mathbf{Pol}_{n+1}$  is defined by the following pullback diagram:

$$\begin{array}{ccc} \mathbf{Pol}_{n+1} & \xrightarrow{\mathcal{U}_{n+1}^{GP}} & \mathbf{Grph}_{n+1} \\ \downarrow \mathcal{U}_n^P & \lrcorner & \downarrow \mathcal{U}_n^G \\ \mathbf{Pol}_n & \xrightarrow{\mathcal{F}_n} \mathbf{Cat}_n \xrightarrow{\mathcal{U}_n} & \mathbf{Grph}_n \end{array}$$

We denote by  $\mathcal{F}_{n+1}^P$  the unique functor making the following diagram commutative:

$$\begin{array}{ccccc}
 \mathbf{Pol}_{n+1} & & & & \\
 \downarrow \mathcal{U}_n^P & \searrow \mathcal{F}_{n+1}^P & & \searrow \mathcal{U}_{n+1}^{GP} & \\
 & & \mathbf{Cat}_n^+ & \longrightarrow & \mathbf{Grph}_{n+1} \\
 & & \downarrow \lrcorner & & \downarrow \mathcal{U}_n^G \\
 \mathbf{Pol}_n & \xrightarrow{\mathcal{F}_n} & \mathbf{Cat}_n & \xrightarrow{\mathcal{U}_n} & \mathbf{Grph}_n
 \end{array}$$

The functor  $\mathcal{F}_{n+1}^P$  is defined as the following composite:

$$\mathbf{Pol}_{n+1} \xrightarrow{\mathcal{F}_{n+1}^P} \mathbf{Cat}_n^+ \xrightarrow{\mathcal{F}_{n+1}^W} \mathbf{Cat}_{n+1}$$

A 0-polygraph is a set. The free 0-category over a 0-polygraph is the 0-polygraph itself.

Given an  $n$ -polygraph  $\Sigma$ , we denote by  $\Sigma^*$  the free  $n$ -category over  $\Sigma$ . Let us assume  $n$ -polygraphs and free  $n$ -categories over  $n$ -polygraphs are defined. An  $(n + 1)$ -polygraph is the data of an  $n$ -polygraph  $\Sigma$ :

$$\begin{array}{ccccccc}
 \Sigma_0^* & \xleftarrow{t_0} & \Sigma_1^* & \xleftarrow{t_1} & \cdots & \xleftarrow{t_{n-2}} & \Sigma_{n-1}^* & \xleftarrow{t_{n-1}} & \Sigma_n \\
 \uparrow s_0 & \swarrow & \uparrow s_1 & \swarrow & \cdots & \swarrow s_{n-2} & \uparrow s_{n-1} & \swarrow & \\
 \Sigma_0 & & \Sigma_1 & & \cdots & & \Sigma_{n-1} & & \Sigma_n
 \end{array}$$

and a globular extension  $\Sigma_{n+1}$  of the free  $n$ -category over  $\Sigma$ :

$$\begin{array}{ccccccc}
 \Sigma_0^* & \xleftarrow{t_0} & \Sigma_1^* & \xleftarrow{t_1} & \cdots & \xleftarrow{t_{n-2}} & \Sigma_{n-1}^* & \xleftarrow{t_{n-1}} & \Sigma_n^* & \xleftarrow{t_n} & \Sigma_{n+1} \\
 \uparrow s_0 & \swarrow & \uparrow s_1 & \swarrow & \cdots & \swarrow s_{n-2} & \uparrow s_{n-1} & \swarrow & \uparrow s_n & \swarrow & \\
 \Sigma_0 & & \Sigma_1 & & \cdots & & \Sigma_{n-1} & & \Sigma_n & & \Sigma_{n+1}
 \end{array}$$

The elements of  $\Sigma_k$  are called  $k$ -cells.

### 3.2. Linear $(n, p)$ -polygraphs

In this section, we introduce linear  $(n, p)$ -polygraphs.

**3.2.1. Definition.** The category  $\mathbf{LinCat}_{n,p}^+$  of linear  $(n, p)$ -categories with a globular extension is defined by the following pullback diagram:

$$\begin{array}{ccc}
 \mathbf{LinCat}_{n,p}^+ & \longrightarrow & \mathbf{Grph}_{n+1} \\
 \downarrow \lrcorner & & \downarrow \mathcal{U}_n^G \\
 \mathbf{LinCat}_{n,p} & \xrightarrow{\mathcal{U}_{n,p}} & \mathbf{Grph}_n
 \end{array}$$

**3.2.2. Definition.** The free linear  $(0, 0)$ -category  $\Sigma^\ell$  over the 0-polygraph  $\Sigma$  is the vector space spanned by  $\Sigma$ . For  $n > 0$ , the free linear  $(n, n)$ -category over the  $n$ -polygraph  $\Sigma$  is the linear  $(n, n)$ -category  $\Sigma^\ell$  such that  $\Sigma_k^\ell = \Sigma_k^*$  for  $0 \leq k < n$  and  $\Sigma_n^\ell(u, v)$  is the vector space spanned by  $\Sigma^*(u, v)$  for each  $(n - 1)$ -cells  $u$  and  $v$ .

**3.2.3. Definition.**  $\mathbf{LinPol}_{n,n}$  is the category of  $n$ -polygraphs and the functor  $\mathcal{F}_{n,n}$  from  $\mathbf{LinPol}_{n,n}$  to  $\mathbf{LinCat}_{n,n}$  is the free functor from  $\mathbf{LinPol}_{n,n}$  to  $\mathbf{LinCat}_{n,n}$ . Let us assume the category  $\mathbf{LinPol}_{n,p}$  of linear  $(n, p)$ -polygraphs and the functor  $\mathcal{F}_{n,p}$  from  $\mathbf{LinPol}_{n,p}$  to  $\mathbf{LinCat}_{n,p}$  are defined. The category  $\mathbf{LinPol}_{n+1,p}$  is defined by the following pullback diagram:

$$\begin{array}{ccc}
\mathbf{LinPol}_{n+1,p} & \xrightarrow{\mathcal{U}_{n+1,p}^{\text{GP}}} & \mathbf{Grph}_{n+1} \\
\mathcal{U}_{n,p}^{\text{P}} \downarrow \lrcorner & & \downarrow \mathcal{U}_n^{\text{G}} \\
\mathbf{LinPol}_{n,p} & \xrightarrow{\mathcal{F}_{n,p}} \mathbf{LinCat}_{n,p} \xrightarrow{\mathcal{U}_{n,p}} & \mathbf{Grph}_n
\end{array}$$

We denote by  $\mathcal{F}_{n+1,p}^{\text{P}}$  the unique functor making the following diagram commutative:

$$\begin{array}{ccccc}
\mathbf{LinPol}_{n+1,p} & & & & \\
\mathcal{U}_{n,p}^{\text{P}} \downarrow & \searrow \mathcal{F}_{n+1,p}^{\text{P}} & & \searrow \mathcal{U}_{n+1,p}^{\text{GP}} & \\
& & \mathbf{LinCat}_{n,p}^+ & \xrightarrow{\quad} & \mathbf{Grph}_{n+1} \\
& & \downarrow \lrcorner & & \downarrow \mathcal{U}_n^{\text{G}} \\
\mathbf{LinPol}_{n,p} & \xrightarrow{\mathcal{F}_{n,p}} & \mathbf{LinCat}_{n,p} & \xrightarrow{\mathcal{U}_{n,p}} & \mathbf{Grph}_n
\end{array}$$

The functor  $\mathcal{F}_{n+1,p}$  is defined as the following composite:

$$\mathbf{LinPol}_{n+1,p} \xrightarrow{\mathcal{F}_{n+1,p}^{\text{P}}} \mathbf{LinCat}_{n,p}^+ \xrightarrow{\mathcal{F}_{n+1,p}^{\text{W}}} \mathbf{LinCat}_{n+1,p}$$

**3.2.4. Definition.** Let  $0 \leq p \leq n$ . The free linear  $(n + 1, p)$ -category over a linear  $(n, p)$ -category with globular extension  $(\mathcal{C}, \Gamma)$  is the linear  $(n + 1, p)$ -category having  $\mathcal{C}$  as an underlying linear  $(n, p)$ -category and which  $(n + 1)$ -cells are defined this way:

- we construct the set  $A_1$  of all  $(n + 1)$ -cells of the form  $1_{u_1} \star_n \cdots \star_0 \alpha \star_0 \cdots \star_n 1_{u_{2n}}$  where each  $u_k$  is in  $\mathcal{C}_n$  and  $\alpha$  is in  $\Gamma$ ,
- we define the set of all formal  $n$ -compositions of elements of  $A_1$  quotiented by the exchange relations (1) to obtain a set  $A_2$ ,
- if  $p = 0$ , the  $(n + 1)$ -cells of the free linear  $(n + 1, p)$ -category are the linear combinations of elements of  $A_2$  quotiented by Relations (2), (3) and (4). if  $p > 0$ , the  $(n + 1)$ -cells of the free linear  $(n + 1, p)$ -category are the linear combinations of  $(p - 1)$ -composable elements of  $A_2$  quotiented by Relations (2), (3) and (4).



A linear  $(n, n)$ -polygraph is an  $n$ -polygraph. Given an  $n$ -polygraph  $\Sigma$ , we denote by  $\Sigma^*$  the free  $n$ -category over  $\Sigma$ . Let us assume linear  $(n, p)$ -polygraphs are defined. a linear  $(n + 1, p)$ -polygraph is the data of a linear  $(n, p)$ -polygraph  $\Sigma$ :

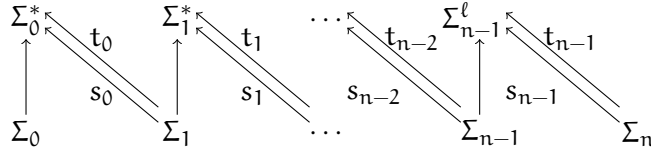

and a globular extension  $\Sigma_{n+1}$  of the free  $(n, p)$ -category  $\Sigma^\ell$  over  $\Sigma$ :

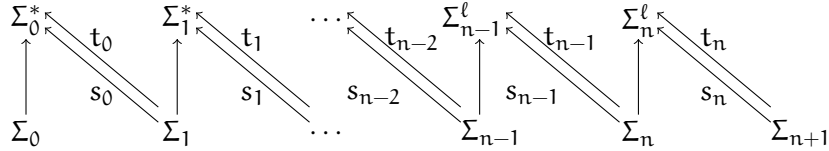

## 4. LINEAR REWRITING

### 4.1. Higher dimensional monomials

We will consider  $n > 0$  for this section.

In 2-categories, 2-cells can be represented as planar diagrams with an upper boundary and a lower boundary. The upper boundary will correspond to the 1-source of the 2-cell and the lower boundary will correspond to its 1-target. A generating 2-cell with 1-source  $a$  and 1-target  $b$  will be pictured as follows:



The 0-composition  $\alpha \star_0 \beta$  will be represented by horizontal concatenation

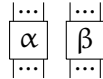

and the 1-composition  $\alpha \star_1 \beta$  will be represented by vertical concatenation



The exchange relation is diagrammatically represented by:

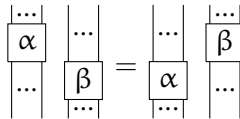

If a 2-cell  $\alpha$  verifies  $s_1(\alpha) = t_1(\alpha) = a$ , we use for any  $k \in \mathbb{N}$  the following notations:

$$\begin{array}{|c|} \hline \dots \\ \hline \alpha \\ \hline \dots \\ \hline \end{array} 0 = 1_a, \quad \begin{array}{|c|} \hline \dots \\ \hline \alpha \\ \hline \dots \\ \hline \end{array} k+1 = \begin{array}{|c|} \hline \dots \\ \hline \alpha \\ \hline \dots \\ \hline \alpha \\ \hline \dots \\ \hline \end{array} k \quad (5)$$

In linear  $(2, 2)$ -categories, linear combinations of such diagrams will be used to represent 2-cells. Such a representation will be used later.

**4.1.1. Example.** Let  $\mathcal{C}$  be a linear  $(2, 2)$ -category with only one 0-cell, one 1-cell  $x$  from and  $\alpha$  a 2-cell from  $x$  to  $xx$ . By representing  $1_x$  this way:



we can represent  $\alpha$  by:



Then, the following diagrams:

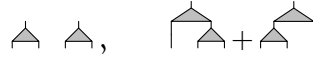

respectively correspond to  $\alpha \star_0 \alpha$  and  $\alpha \star_1 (1_x \star_0 \alpha) + \alpha \star_1 (\alpha \star_0 1_x)$ .

**4.1.2. Definition.** Let  $\Sigma$  be a linear  $(n, n - 1)$ -polygraph. A monomial of  $\Sigma$  is a  $(n - 1)$ -cell of the free  $(n - 1)$ -category  $\Sigma_{(n-1)}^*$ . We say  $\Sigma$  is *left-monomial* if all elements of  $\Sigma_n$  have monomial source.

**4.1.3. Remark.** Let  $\Sigma$  be a linear  $(n, n - 1)$ -polygraph. Any  $n$ -cell of  $\Sigma^\ell$  has a unique decomposition as a linear combination of monomials.

**4.1.4. Definition.** Let  $\Sigma$  be an  $n$ -polygraph. A monomial order on  $\Sigma$  is a well-founded order  $\prec$  on  $\Sigma_n^*$  such that:

- for any  $0 \leq k < n$  and any  $n$ -cells  $a, b, u$  and  $v$ , we have  $a \star_k u \star_k b \prec a \star_k v \star_k b$  if  $u \prec v$  whenever this makes sense,
- $\prec$  is strict on  $\Sigma_n^*(a, b)$  for each  $(n - 1)$ -cells  $a$  and  $b$ .

An  $n$ -polygraph does not always have a monomial order.

**4.1.5. Example.** Let  $\Sigma$  be a 2-polygraph with only one 0-cell, one 1-cell and two 2-cells represented by:



If there is a monomial order  $\prec$  on  $\Sigma$ , we have one of the following inequalities:

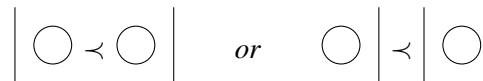

Let us assume the first inequality is true, the other case being symmetric. Then, we have:

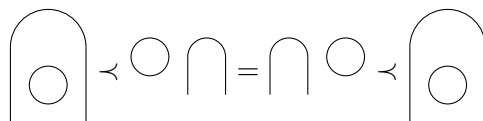

which contradicts the existence of a monomial order  $\Sigma_2^*$ .

## 4.2. Rewriting in linear (2, 2)-categories

We recall that a linear (2, 2)-category is a category enriched in linear categories. We will explicit the rewriting systems arising from linear (3, 2)-polygraphs. A similar theory exists in the case of  $n$ -polygraphs [GM09]. The rewriting theory of linear (2, 2)-categories we will present is a linear adaptation of the case of 2-categories.

Let  $\Sigma$  be a linear (3, 2)-polygraph. The *congruence* generated by  $\Sigma$  is the equivalence relation  $\equiv$  on  $\Sigma_2^\ell$  such that  $u \equiv v$  if there is a 3-cell  $\alpha$  in  $\Sigma^\ell$  such that  $s_2(\alpha) = u$  and  $t_2(\alpha) = v$ . Note that in a linear (3, 2)-category, all 3-cells are invertible. If  $\alpha$  is a 3-cell from a 2-cell  $u$  to a 2-cell  $v$ , the 3-cell  $1_v + 1_u - \alpha$  has 2-source  $v$  and 2-target  $u$ . Let  $\Sigma$  be a linear (3, 2)-polygraph. A linear (2, 2)-category is *presented* by  $\Sigma$  if it is isomorphic to the quotient of  $\Sigma_2^\ell$  by the congruence generated by  $\Sigma$ .

We introduce next the notions of rewriting step of a left-monomial linear (3, 2)-polygraph to define branchings, termination and confluence in this context. We will fix  $\Sigma$  a left-monomial linear (3, 2)-polygraph for the remainder of this section.

**4.2.1. Definition.** A *rewriting step* of  $\Sigma$  is a 3-cell of  $\Sigma^\ell$  of the form:

$$\lambda m_1 \star_1 (m_2 \star_0 s_2(\alpha) \star_0 m_3) \star_1 m_4 + u \Rightarrow \lambda m_1 \star_1 (m_2 \star_0 t_2(\alpha) \star_0 m_3) \star_1 m_4 + u$$

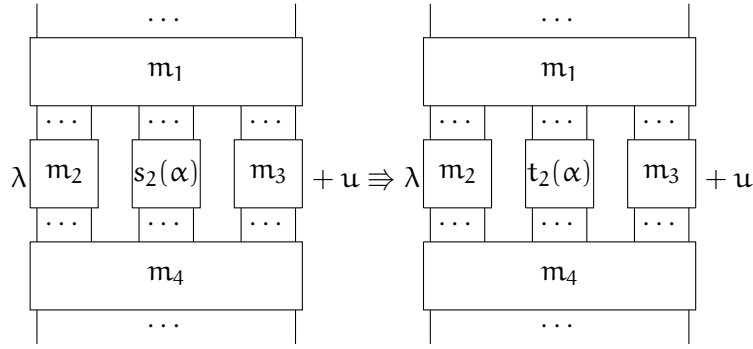

where  $\alpha$  is in  $\Sigma_3$ , the  $m_i$  are monomials,  $\lambda$  is a nonzero scalar and  $u$  is a 2-cell such that the monomial  $\lambda m_2 \star_1 (m_1 \star_0 m_4) \star_1 m_3$  does not appear in the monomial decomposition of  $u$ . A rewriting sequence of  $\Sigma$  is a finite or infinite sequence:

$$u_0 \Rightarrow \dots \Rightarrow u_n \Rightarrow \dots$$

of rewriting steps of  $\Sigma$ .

For any 2-cells  $u$  and  $v$ , we say  $u$  rewrites into  $v$  if there is a non-degenerate rewriting sequence from  $u$  to  $v$ . A 2-cell is a *normal form* if it can not be rewritten. We say  $\Sigma$  is normalizing if each 2-cell rewrites into a normal form or is a normal form.

A *branching* of  $\Sigma$  is a pair of rewriting sequences of  $\Sigma$  with the same 2-source:

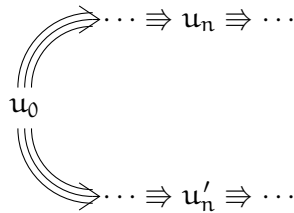

A *local branching* of  $\Sigma$  is a pair of rewriting steps of  $\Sigma$  with the same 2-source.

A branching  $(\alpha, \beta)$  is *confluent* if it can be completed

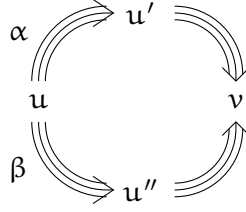

into a branching made of rewriting sequences with the same 2-target. A linear  $(3, 2)$ -polygraph is *confluent at a 2-cell*  $u \in \Sigma_2^\ell$  if all its branchings of source  $u$  are confluent. A linear  $(3, 2)$ -polygraph is *confluent* if all its branchings are confluent. A linear  $(3, 2)$ -polygraph is *locally confluent at a 2-cell*  $u \in \Sigma_2^\ell$  if all its local branchings of source  $u$  are confluent. A linear  $(3, 2)$ -polygraph is *locally confluent* if all its local branchings are confluent.

The linear  $(3, 2)$ -polygraph  $\Sigma$  is *terminating* if it has no infinite rewriting sequence.

The linear  $(3, 2)$ -polygraph  $\Sigma$  is *convergent* if it is terminating and confluent.

**4.2.2. Proposition (Noetherian induction principle).** *Let  $\Sigma$  be a terminating left-monomial linear  $(3, 2)$ -polygraph. Let  $P$  be a property on the 2-cells of  $\Sigma^\ell$  such that for any  $u \in \Sigma_2^\ell$ , if for all  $v$  such that  $u$  rewrites into  $v$ , the property  $P(v)$  is true,  $P(u)$  is true. Then,  $P(u)$  is true for any  $u \in \Sigma_2^\ell$ .*

*Proof.* Let us assume  $P(u_0)$  is false for some  $u_0 \in \Sigma_2^\ell$ . So, there exists  $u_1 \in \Sigma_2^\ell$  such that  $u_0$  rewrites into  $u_1$  and  $P(u_1)$  is false. This gives us an infinite rewriting sequence:

$$u_0 \Rightarrow \cdots \Rightarrow u_n \Rightarrow \cdots$$

where  $P(u_n)$  is false for each  $n \in \mathbb{N}$ . The existence of this rewriting sequence contradicts the termination hypothesis. Noetherian induction principle is thus proved.  $\square$

Termination of a rewriting system implies equivalence between confluence and local confluence [New42]. This result is called Newman's lemma. We have the same result in the case of linear  $(3, 2)$ -polygraphs.

**4.2.3. Lemma.** *Let  $\Sigma$  be a terminating left-monomial linear  $(3, 2)$ -polygraph. Then  $\Sigma$  is confluent if and only if  $\Sigma$  is locally confluent.*

*Proof.* Confluence implies local confluence. We have to prove the converse implication, assuming  $\Sigma$  is terminating. Let us assume  $\Sigma$  is locally confluent and let  $u$  be in  $\Sigma_2^\ell$ . if  $u$  is a normal form, all branchings with source  $u$  are confluent because there is no branching with source  $u$ . if  $u$  is not a normal form, and if for any  $v$  such that  $u$  rewrites into  $v$  all branchings with source  $v$  are confluent, any non-trivial branching  $(\alpha, \beta)$  is confluent by the following confluence diagram:

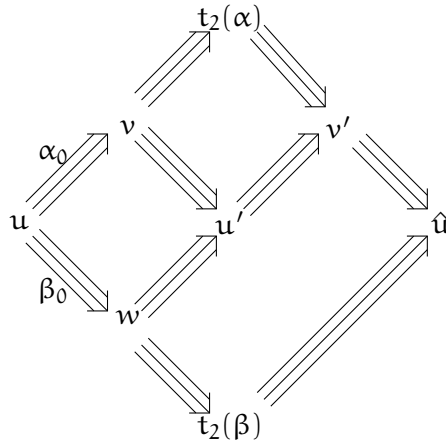

where  $\alpha_0$  and  $\beta_0$  are respectively the first rewriting step of  $\alpha$  and  $\beta$ .  $\square$

This proof for linear  $(3, 2)$ -polygraphs by Noetherian induction works like in the case of abstract rewriting systems [Hue80].

**4.2.4. Definition.** An aspherical branching of  $\Sigma$  is a branching made up of two identical rewriting steps. A Peiffer branching is a branching of the form:

$$t_2(\alpha) \star_1 s_2(\beta) + h \Leftarrow s_2(\alpha) \star_1 s_2(\beta) + h \Rightarrow s_2(\alpha) \star_1 t_2(\beta) + h$$

where  $\alpha$  and  $\beta$  are rewriting steps of  $\Sigma$  with monomial source. Note that all branchings of the form:

$$t_2(\alpha) \star_1 s_2(\beta) + h \Leftarrow s_2(\alpha) \star_0 s_2(\beta) + h \Rightarrow s_2(\alpha) \star_1 t_2(\beta) + h$$

are also Peiffer branchings because of the relation:

$$s_2(\alpha) \star_0 s_2(\beta) = (s_2(\alpha) \star_0 1_{s_1(\beta)}) \star_1 (1_{s_1(\alpha)} \star_0 s_2(\beta))$$

An *additive branching* is a branching of the form:

$$t_2(\alpha) + s_2(\beta) \Leftarrow s_2(\alpha) + s_2(\beta) \Rightarrow s_2(\alpha) + t_2(\beta)$$

where  $\alpha$  and  $\beta$  are rewriting steps of  $\Sigma$ . An overlapping branching is a branching that is not aspherical, Peiffer or additive.

**4.2.5. Notation.** Let us partition  $\Sigma_3$  in multiple families and assume an overlapping branching  $(\alpha, \beta)$  of  $\Sigma$  is confluent. If  $\alpha$  is in the family  $i$  and  $\beta$  is in the family  $j$ , we denote:

$$u \Rightarrow_j^i v$$

where  $u$  is the source of  $(\alpha, \beta)$  and  $v$  is a 2-cell attained after completion of  $(\alpha, \beta)$ .

**4.2.6. Definition.** Let  $\sqsubseteq$  be the order on the monomials of  $\Sigma$  such that we have  $f \sqsubseteq g$  if we have  $g = m_1 \star_1 (m_2 \star_0 f \star_0 m_3) \star_1 m_4$  for some monomials  $m_i$ . A *critical branching* is an overlapping branching with monomial source such that its source is minimal for  $\sqsubseteq$ .

**4.2.7. Definition.** A 3-cell of  $\Sigma^\ell$  is *elementary* if it is of the form  $\lambda m_1 \star_1 (m_2 \star_0 \alpha \star_0 m_3) \star_1 m_4 + u$  where  $\alpha$  is in  $\Sigma_3$ , the  $m_i$  are monomials,  $\lambda$  is a nonzero scalar, and  $u$  is a 2-cell.

**4.2.8. Example.** Let  $A$  and  $B$  be two monomials of  $\Sigma^\ell$  such that there is a rewriting step from  $A$  to  $B$ . Then, there is a 3-cell of  $\Sigma^\ell$  from  $2A$  to  $A + B$  which is not a rewriting step. But this 3-cell is elementary.

**4.2.9. Lemma.** Let  $\alpha$  be an elementary 3-cell. Then, there exists two rewriting sequences  $\beta$  and  $\gamma$  of length at most 1 such that  $\alpha = \beta \star_2 \gamma^{-1}$ .

*Proof.* Let us write  $\alpha = \alpha' + g$  where  $\alpha'$  is a rewriting step from a 2-cell  $u$  to a 2-cell  $f$  and  $g$  is a 2-cell. Let us write  $g = \lambda u + h$  where  $f$  does not appear in the monomial decomposition of  $h$ . Then,  $(\lambda + 1)u + h$  rewrites into  $(\lambda + 1)f + h$  either by an identity or a rewriting step and  $u + g$  rewrites into  $(\lambda + 1)u + h$  either by an identity or a rewriting step.  $\square$

**4.2.10. Definition.** Let  $\Sigma$  be a left-monomial linear  $(3, 2)$ -polygraph. The *rewrite order* of  $\Sigma$  is the relation  $\preceq'_\Sigma$  on  $\Sigma_2^\ell$  defined by  $v \preceq'_\Sigma u$  if  $u$  rewrites into  $v$  or  $u = v$ . The *canonical rewrite order* of  $\Sigma$  is the minimal binary relation  $\preceq_\Sigma$  such that:

- if  $v \preceq'_\Sigma u$ , then  $v \preceq_\Sigma u$ ,
- if  $v \preceq_\Sigma u$ ,  $v' \preceq_\Sigma u'$ , and  $u$  and  $u'$  do not have any common monomial in their decomposition, then  $v + v' \preceq_\Sigma u + u'$ .

The *strict canonical rewrite order* of  $\Sigma$  is the strict order  $\prec_\Sigma$  defined for any 2-cells  $u$  and  $v$  by  $v \prec_\Sigma u$  if we have  $v \preceq_\Sigma u$  but not  $u \preceq_\Sigma v$ . The *semistrict rewrite order* of  $\Sigma$  is the binary relation  $\prec'_\Sigma$  on  $\Sigma_2^\ell$  defined by  $v \prec'_\Sigma u$  if  $u$  rewrites into  $v$ .

**4.2.11. Remark.** if  $\Sigma$  is terminating, those relations are order relations and  $\prec_\Sigma$  is well-founded. In general, only  $\prec_\Sigma$  is an order.

**4.2.12. Lemma.** Let  $f$  be a 2-cell of a left-monomial linear  $(3,2)$ -polygraph  $\Sigma$ . Let us assume that all critical branchings of  $\Sigma$  are confluent and  $\Sigma$  is locally confluent at every 2-cell  $g$  such that  $g \prec_\Sigma f$ . Then,  $\Sigma$  is locally confluent at  $f$ .

*Proof.* A local branching with source  $f$  is either an aspherical branching, an overlapping branching, an additive branching or a Peiffer branching. Aspherical branchings are always confluent. Let  $(\alpha, \beta)$  be an additive branching with source  $f$ . Let us write  $f = s_2(\alpha') + s_2(\beta')$  where  $\alpha'$  is the rewriting step  $\alpha - s_2(\beta)$  and  $\beta'$  is the rewriting step  $\beta - s_2(\alpha)$ . If we do not have  $f \prec_\Sigma t_2(\alpha') + t_2(\beta')$ , we have either  $t_2(\alpha') + s_2(\beta') \preceq'_\Sigma s_2(\alpha') + t_2(\beta')$  or  $s_2(\alpha') + t_2(\beta') \preceq'_\Sigma t_2(\alpha') + s_2(\beta')$ , and  $(\alpha, \beta)$  is confluent. Else, we have the following confluence diagram:

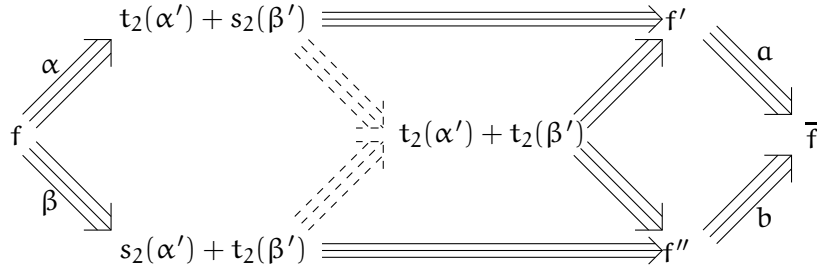

Here, the dotted 3-cells are elementary, the 3-cells  $a$  and  $b$  are rewriting sequences, and the other 3-cells are rewriting steps or identities, whose existence are guaranteed by Lemma 4.2.9.

Assume there is a Peiffer branching with source  $f$ . Let us write  $f = u \star_1 v + h$  where  $u$  and  $v$  are respectively monomial sources of rewriting steps  $\alpha$  and  $\beta$ . If we do not have  $f \prec_\Sigma t_2(\alpha) \star_1 t_2(\beta) + h$ , we have either  $u \star_1 \beta + h \preceq'_\Sigma t_2(\alpha) \star_1 v + h$  or  $t_2(\alpha) \star_1 v + h \preceq'_\Sigma u \star_1 \beta + h$ , and the Peiffer branching is confluent. Else, we have the following confluence diagram:

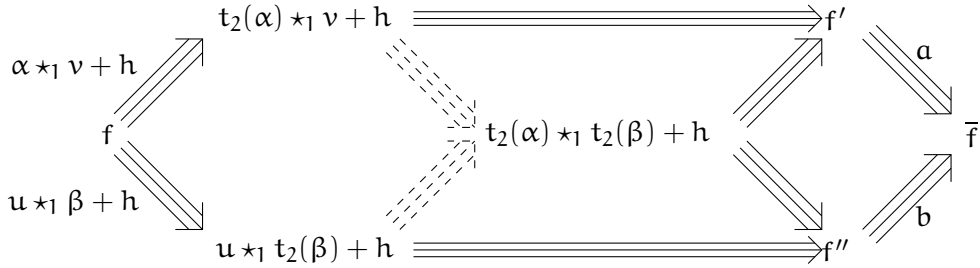

Assume there is an overlapping branching with source  $f$ . Let us write  $f = \lambda m_1(m_2 \star_1 u \star_1 m_3)m_4 + h$  where the  $m_i$  are monomials,  $u$  is the source of a critical branching and  $\lambda$  is a nonzero scalar. The overlapping branching can be written  $(\alpha + h, \beta + h)$  where  $(\alpha, \beta)$  is confluent by hypothesis to a common target  $g$ . if  $t_2(\alpha) = t_2(\beta)$  or if we do not have  $f \prec_\Sigma g + h$ , we have either  $t_2(\alpha) + h \preceq'_\Sigma t_2(\beta) + h$  or  $t_2(\beta) + h \preceq'_\Sigma t_2(\alpha) + h$ , and the overlapping branching is confluent. Else, because  $\prec_\Sigma$  is well-founded, there is a monomial  $m$  of  $t_2(\alpha) - t_2(\beta)$  such that:

- $m$  can be rewritten into a linear combination of the others monomials of  $t_2(\alpha) - t_2(\beta)$ ,
- $m$  only appears in  $t_2(\alpha)$  or  $t_2(\beta)$ .

This makes the branching  $(\alpha + h, \beta + h)$  confluent and concludes the last case of local branching.  $\square$

**4.2.13. Theorem.** Let  $\Sigma$  be a left-monomial linear  $(3,2)$ -polygraph such that  $\prec_\Sigma$  is well-founded. Then,  $\Sigma$  is locally confluent if and only if its critical branchings are confluent.

*Proof.* if  $\Sigma$  is locally confluent, then its critical branchings are confluent. Conversely, let us assume that all critical branchings of  $\Sigma$  are confluent. Induction on  $\prec_{\Sigma}$  can be used to prove that  $\Sigma$  is confluent. Indeed,  $\Sigma$  is locally confluent at every minimal 2-cell for  $\prec_{\Sigma}$  and lemma 4.2.12 concludes the proof.  $\square$

**4.2.14. Lemma.** *Let  $\Sigma$  be a confluent left-monomial linear  $(3, 2)$ -polygraph. Let  $\mathcal{C}$  be the linear  $(2, 2)$ -category presented by  $\Sigma$ . Then, for any 1-cells  $u$  and  $v$  of  $\mathcal{C}$  with same 0-source and 0-target, the linear map  $\tau$  from  $\Sigma_2^{\ell}(u, v)$  to  $\mathcal{C}(u, v)$  sending each 2-cell to its congruence class has for kernel the subspace of  $\Sigma_2^{\ell}(u, v)$  made of all 2-cells having 0 as a normal form.*

*Proof.*  $\Sigma$  being left-monomial, 0 is a normal form. If a 2-cell rewrites into 0, it is congruent to 0. Conversely, let us assume a non-zero 2-cell  $f$  is in  $\text{Ker}(\tau)$ . Confluence of  $\Sigma$  makes  $f$  rewrite into 0. This concludes the proof.  $\square$

**4.2.15. Proposition.** *Let  $\Sigma$  be a confluent and normalizing left-monomial linear  $(3, 2)$ -polygraph. Let  $\mathcal{C}$  be the linear  $(2, 2)$ -category presented by  $\Sigma$ . Then, for any 1-cells  $u$  and  $v$  of  $\mathcal{C}$  with same 0-source and 0-target, the set of monomials of  $\Sigma$  in normal form with 1-source  $u$  and 1-target  $v$  gives a basis of  $\mathcal{C}(u, v)$ .*

*Proof.* Let us fix two 1-cells  $u$  and  $v$  of  $\mathcal{C}$  with same 0-source and 0-target. Every 2-cell of  $\Sigma^{\ell}$  with 1-source  $u$  and 1-target  $v$  has a normal form because  $\Sigma$  is terminating. Each normal form is a linear combination of monomials in normal form because  $\Sigma$  is left-monomial. So, the family of monomials in normal form is generating. The family of monomials in normal forms is free because  $\Sigma$  is confluent, which allows us to use lemma 4.2.14. This concludes the proof.  $\square$

### 4.3. Confluence by decreasingness

We fix in this section  $\Sigma$  a left-monomial linear  $(3, 2)$ -polygraph.

**4.3.1. Definition.** Let  $R$  be the set of all rewriting steps of  $\Sigma$ . We say  $\Sigma$  is decreasing if there is a well-founded order  $\prec$  on a partition  $\mathcal{P}$  of  $R$  such that, for every  $I$  and  $J$  in  $\mathcal{P}$ , every local branching  $(i, j)$  with  $i \in I$  and  $j \in J$  can be completed into a confluence diagram

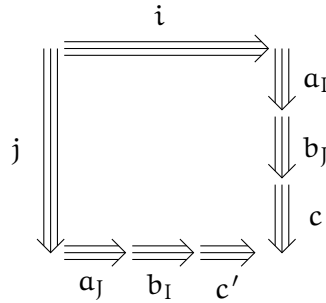

such that:

- $a_I$  is a rewriting sequence such that for each rewriting step  $k$  in  $a_I$ , there exists  $K$  in  $\mathcal{P}$  such that  $k \in K$  and  $K \prec I$ .
- $a_J$  is a rewriting sequence such that for each rewriting step  $k$  in  $a_J$ , there exists  $K$  in  $\mathcal{P}$  such that  $k \in K$  and  $K \prec J$ .
- $b_I$  is either an identity or an element of  $I$ .
- $b_J$  is either an identity or an element of  $J$ .
- $c$  and  $c'$  are rewriting sequences such that for each rewriting step  $k$  in  $c$  or  $c'$ , there exists  $K$  in  $\mathcal{P}$  such that  $k \in K$  and  $K \prec I$  or  $K \prec J$ .

**4.3.2. Example.** Let  $\Sigma_{\text{ex}}$  be the linear  $(3, 2)$ -polygraph with only one 0-cell, one 1-cell  $\alpha$ , two 2-cells represented by:

$$\cap, \quad \cup$$

and the following 3-cell:

$$\left| \bigcirc \Rightarrow \bigcirc \right|$$

A 2-cell is said in semi-normal form if it cannot be rewritten by using a rewriting step of one of the following forms:

$$\cap \bigcirc \Rightarrow \left( \bigcirc \right), \quad \cup \bigcirc \Rightarrow \left( \bigcirc \right)$$

We give a partition  $\{\mathcal{P}_n | n \in \mathbb{N}\}$  of the set of rewriting steps of  $\Sigma_{\text{ex}}$  such that, for any rewriting step  $\alpha$ , we have  $\alpha \in \mathcal{P}_n$  if the shortest rewriting sequence from  $\iota_2(\alpha)$  to a semi-normal form is of length  $n$ . This is a partition of the set of rewriting steps of  $\Sigma_{\text{ex}}$  because every 2-cell rewrites into a semi-normal form. We define on  $\{\mathcal{P}_n | n \in \mathbb{N}\}$  the order  $\prec$  by  $\mathcal{P}_n \prec \mathcal{P}_m$  if  $n < m$ . With this well-ordered partition given,  $\Sigma_{\text{ex}}$  is decreasing. This translates the fact any 2-cell has a unique semi-normal form.

The following result is proved in [vO94] in the case of abstract rewriting systems. The proof can be adapted to the case of linear  $(3, 2)$ -polygraphs.

**4.3.3. Theorem.** Let  $\Sigma$  be a left-monomial linear  $(3, 2)$ -polygraph. if  $\Sigma$  is decreasing, then  $\Sigma$  is confluent.

*Proof.* Let us assume  $\Sigma$  is decreasing for a partition  $\mathcal{P}$  of the set of its rewriting steps and an order  $\prec$  on  $\mathcal{P}$ . We introduce the following map  $|\cdot \cdot \cdot|$  from the free monoid  $\mathcal{P}^*$  over  $\mathcal{P}$  to  $\mathbb{N}^{\mathcal{P}}$ :

- if  $\varepsilon$  is the empty word of  $\mathcal{P}^*$ , for every  $K$  in  $\mathcal{P}$ , we have  $|\varepsilon|(K) = 0$ ,
- for every  $I$  in  $\mathcal{P}$  and every  $K$  in  $\mathcal{P}$ , we have  $|I|(I) = 1$  and  $|I|(K) = 0$  if  $I \neq K$ ,
- for every  $I$  in  $\mathcal{P}$  and every word  $\sigma$  of  $\mathcal{P}^*$ , we have  $|I\sigma| = |I| + |\sigma^{(I)}|$  where  $\sigma^{(I)}$  denotes the word  $\sigma$  without the letters  $J$  such that  $J \prec I$ .

We remark that for every words  $\sigma_1$  and  $\sigma_2$  of  $\mathcal{P}^*$ , we have:

$$|\sigma_1 \sigma_2| = |\sigma_1| + |\sigma_2|^{(\sigma_1)},$$

where:

$$|\sigma_2|^{(\sigma_1)}(K) = \begin{cases} 0 & \text{if there exists } I \text{ in } \mathcal{P} \text{ such that } K \prec I \text{ and } |\sigma_1|(I) \neq 0 \\ |\sigma_2|(K) & \text{otherwise} \end{cases}$$

Then, we extend  $|\cdot \cdot \cdot|$  to the set of finite rewriting sequences of  $\Sigma$  by defining  $|r_1 \cdot \cdot \cdot r_n| = |K_1 \cdot \cdot \cdot K_n|$  for every rewriting sequence

$$u_0 \xRightarrow{r_1} \cdots \xRightarrow{r_n} u_n$$

such that for each  $1 \leq i \leq n$  we have  $r_i \in K_i$ .

We extend finally  $|\cdot \cdot \cdot|$  to the set of branchings of  $\Sigma$  made of finite rewriting sequences by defining  $|(\alpha, \beta)| = |\alpha| + |\beta|$  for every finite rewriting sequences  $\alpha$  and  $\beta$ .

We now define a strict order  $\prec'$  on  $\mathbb{N}^{\mathcal{P}}$ . For any  $M$  and  $N$  in  $\mathbb{N}^{\mathcal{P}}$ , we define  $M \prec' N$  if there exist  $X, Y$  and  $Z$  in  $\mathbb{N}^{\mathcal{P}}$  such that:



- $M = Z + X$ ,
- $N = Z + Y$ ,
- $Y$  is not zero,
- for every  $I$  in  $\mathcal{P}$  such that  $M(I) \neq 0$ , there exists  $J$  in  $\mathcal{P}$  such that  $N(J) \neq 0$  and  $I \prec J$ .

The order  $\prec'$  is well-founded because  $\prec$  is. We call  $\preceq'$  the symmetric closure of  $\prec'$ .

To prove that  $\Sigma$  is confluent, it is sufficient to prove that every branching  $(\alpha, \beta)$  made of finite rewriting sequences can be completed into a confluence diagram  $(\alpha \star_2 \tau, \beta \star_2 \sigma)$

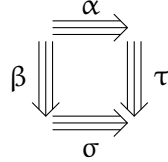

such that:

$$|\alpha \star_2 \tau| \preceq' |(\alpha, \beta)|, \quad (6)$$

$$|\beta \star_2 \sigma| \preceq' |(\alpha, \beta)|. \quad (7)$$

We will prove this fact by induction on  $|(\alpha, \beta)|$ . This is trivial when  $|(\alpha, \beta)|$  is minimal because this is the case of a trivial branching made of two identities.

Let us now assume that for each branching  $(\alpha', \beta')$  made of finite rewriting sequences such that  $|(\alpha', \beta')| \prec' |(\alpha, \beta)|$ , we can complete  $(\alpha', \beta')$  into a confluence diagram verifying (6) and (7). For every diagram of the following form:

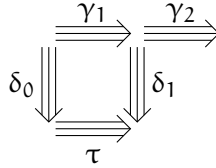

such that  $|\gamma_1 \star_2 \delta_1| \preceq' |(\delta_0, \gamma_1)|$ , we have  $|(\delta_1, \gamma_2)| \prec' |(\delta_0, \gamma_1 \star_2 \gamma_2)|$  if  $\gamma_1$  is not an identity. Indeed:

$$|(\delta_1, \gamma_2)| \prec' |\gamma_1| + |(\delta_1, \gamma_2)|^{(\gamma_1)} = |\gamma_1 \star_2 \delta_1| + |\gamma_2|^{(\gamma_1)} \preceq' |(\delta_0, \gamma_1)| + |\gamma_2|^{(\gamma_1)} = |(\delta_0, \gamma_1 \star_2 \gamma_2)|.$$

Let us also remark that for every diagram of the form:

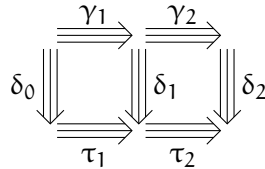

such that:

$$|\delta_0 \star_2 \tau_1| \preceq' |(\delta_0, \gamma_1)| \text{ and } |\gamma_1 \star_2 \delta_1| \preceq' |(\delta_0, \gamma_1)|,$$

$$|\delta_1 \star_2 \tau_2| \preceq' |(\delta_1, \gamma_2)| \text{ and } |\gamma_2 \star_2 \delta_2| \preceq' |(\delta_1, \gamma_2)|$$

We have the *pasting property*  $|\delta_0 \star_2 \tau_1 \star_2 \tau_2| \preceq' |(\delta_0, \gamma_1 \star_2 \gamma_2)|$  and  $|\gamma_1 \star_2 \gamma_2 \star_2 \delta_2| \preceq' |(\delta_0, \gamma_1 \star_2 \gamma_2)|$ .  
Indeed:

$$|\delta_0 \star_2 \tau_1 \star_2 \tau_2| = |\delta_0 \star_2 \tau_1| + |\tau_2|^{(\delta_0 \star_2 \tau_1)} \preceq' |(\delta_0, \gamma_1)| + |\tau_2|^{(\delta_0 \star_2 \tau_1)(\gamma_1)} \preceq' |(\delta_0, \gamma_1 \star_2 \gamma_2)|,$$

$$|\gamma_1 \star_2 \gamma_2 \star_2 \delta_2| = |\gamma_1 \star_2 \gamma_2| + |\delta_2|^{(\gamma_1)(\gamma_2)} \preceq' |\gamma_1 \star_2 \gamma_2| + |\delta_2|^{(\gamma_2)} \preceq' |(\delta_0, \gamma_1 \star_2 \gamma_2)|.$$

To prove  $(\alpha, \beta)$  is confluent when  $\alpha$  and  $\beta$  have nonzero length, we consider  $\alpha_0$  the first step of  $\alpha$  and  $\beta_0$  the first step of  $\beta$ . We have then the following confluence diagram:

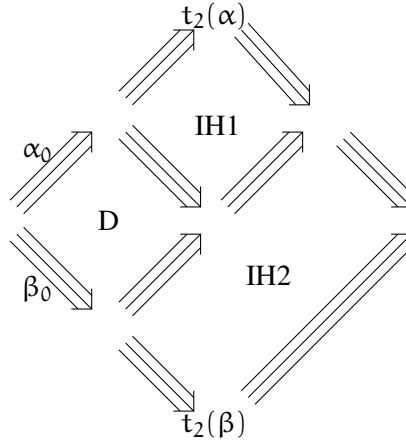

Where  $D$  verifies (6) and (7) by decreasingness of  $\Sigma$ , the diagram  $IH1$  exists because of the induction hypothesis and verifies (6) and (7) by the pasting property. Finally, the induction hypothesis allows us to construct  $IH2$ . The pasting property proves all the diagram verifies (6) and (7). This proves in particular by well-founded induction  $\Sigma$  is confluent.  $\square$

**4.3.4. Example.** *The linear  $(3, 2)$ -polygraph  $\Sigma_{ex}$  from 4.3.2 is decreasing and is therefore confluent. Because every 2-cell rewrites into a semi-normal form and the semi-normal form of a 2-cell is unique, we easily conclude  $\Sigma_{ex}$  is indeed confluent.*

## 5. THE AFFINE ORIENTED BRAUER CATEGORY

### 5.1. Dotted oriented Brauer diagrams with bubbles

After recalling the definition of the affine oriented Brauer category  $\mathcal{AOB}$  from [BCNR14], we will present it by a linear  $(3, 2)$ -polygraph.

**5.1.1. Dotted oriented Brauer diagrams with bubbles.** *A dotted oriented Brauer diagram with bubbles is a planar diagram such that:*

- edges are oriented,
- edges are either bubbles or have a boundary as source and target,
- each edge is decorated with an arbitrary number of dots not allowed to pass through the crossings.

**5.1.2. Equivalence of dotted oriented Brauer diagrams with bubbles.** *Two dotted oriented Brauer diagrams are equivalent if one can be transformed into the other with isotopies and Reidemeister moves. A description of those moves can be found in [Tur10]. An isotopy can move a dot along an edge but cannot make a dot go through a crossing. A dotted oriented Brauer diagram is normally ordered if:*

- all bubbles are clockwise,
- all bubbles are in the leftmost side region,
- all dots are either on a bubble or a segment pointing toward a boundary.

**5.1.3. Example.** Here is an example of dotted oriented Brauer diagram:

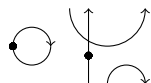

This diagram is not normally ordered. The following one is normally ordered:

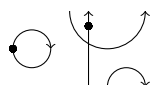

Those diagrams are not equivalent.

Dotted oriented Brauer diagrams with bubbles will be described as 2-cells of a 2-category with vertical and horizontal concatenation respectively standing as 1-composition and 0-composition.

**5.1.4. Definition.** The affine oriented Brauer category  $\mathcal{AOB}$  is the linear  $(2, 2)$ -category with one 0-cell, two generating 1-cells and with 2-cells from  $a$  to  $b$  given by linear combinations of dotted oriented Brauer diagrams with bubbles with source  $a$  and target  $b$  subject to the following relations:

- invariance by equivalence given in 5.1.2,

–

$$\begin{array}{c} \diagup \\ \diagdown \end{array} = \begin{array}{c} \bullet \\ \diagup \\ \diagdown \end{array} + \begin{array}{c} \uparrow \\ \uparrow \end{array}$$

**5.1.5. An equational presentation of  $\mathcal{AOB}$ .** There is a presentation by generators and relations of the linear  $(2, 2)$ -category  $\mathcal{AOB}$  given in [BCNR14]. The category  $\mathcal{AOB}$  is the linear  $(2, 2)$ -category with only one 0-cell, two generating 1-cells  $\wedge$  and  $\vee$  and five generating 2-cells

$$1 \stackrel{s}{\cong} \wedge \vee, \quad \vee \wedge \stackrel{d}{\cong} 1, \quad \wedge \wedge \stackrel{s}{\cong} \wedge \wedge, \quad \wedge \vee \stackrel{t}{\cong} \vee \wedge, \quad \wedge \stackrel{x}{\cong} \wedge$$

respectively represented by:

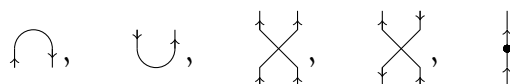

subject to the following relations:

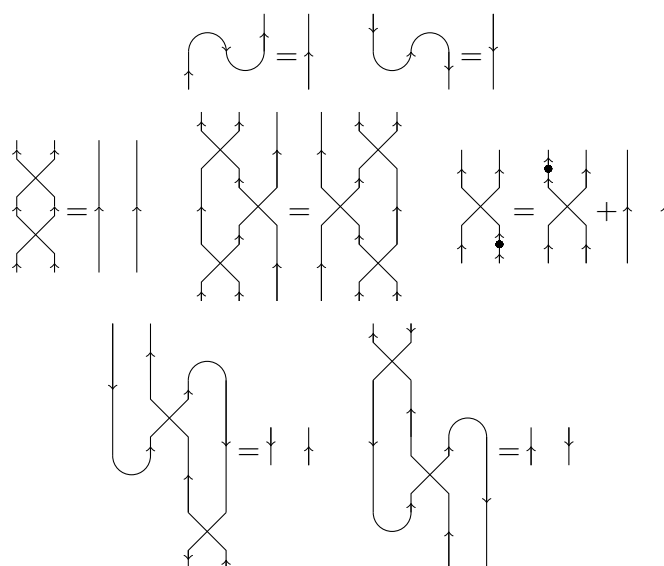

From this equational presentation of the linear  $(2, 2)$ -category  $\mathcal{AOB}$ , we deduce a linear  $(3, 2)$ -polygraph presenting  $\mathcal{AOB}$ .

**5.1.6. The linear  $(3, 2)$ -polygraph  $\mathcal{AOB}$ .** Let us define the linear  $(3, 2)$ -polygraph  $\mathcal{AOB}$ . It is the  $(3, 2)$ -polygraph with only one 0-cell and:

–  $\mathcal{AOB}_1 = \{\wedge, \vee\}$ ,

–  $\mathcal{AOB}_2 = \{ \curvearrowright, \curvearrowleft, \begin{array}{c} \downarrow \quad \downarrow \\ \diagup \quad \diagdown \\ \downarrow \quad \downarrow \end{array}, \begin{array}{c} \downarrow \quad \downarrow \\ \diagdown \quad \diagup \\ \downarrow \quad \downarrow \end{array}, \begin{array}{c} \bullet \\ \downarrow \end{array} \}$ ,

–  $\mathcal{AOB}_3$  is made of the following 3-cells:

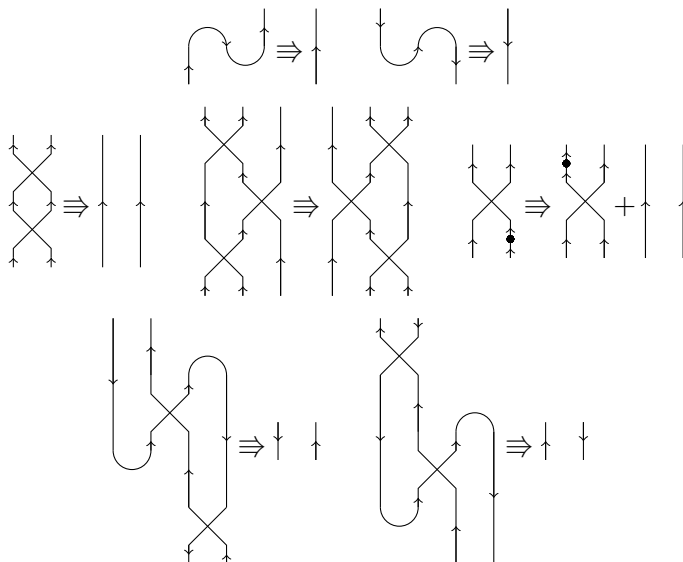

This linear  $(3, 2)$ -polygraph presents the linear  $(2, 2)$ -category  $\mathcal{AOB}$ . This presentation is not confluent. For example, the following critical branching is not confluent:

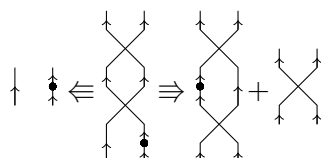

We will give a confluent presentation of the linear  $(2, 2)$ -category  $\mathcal{AOB}$  in Theorem 5.2.9.

## 5.2. A confluent presentation of $\mathcal{AOB}$

We will give a linear  $(3, 2)$ -polygraph  $\overline{\mathcal{AOB}}$  presenting the linear  $(2, 2)$ -category  $\mathcal{AOB}$ , with more 2-cells than the linear  $(3, 2)$ -polygraph  $\mathcal{AOB}$ . We will prove that  $\overline{\mathcal{AOB}}$  is confluent. The presence of redundant 2-cells can be seen as an addition of redundant generators to give more relations and make our presentation confluent.

**5.2.1. The linear  $(3, 2)$ -polygraph  $\overline{\mathcal{AOB}}$ .** The linear  $(3, 2)$ -polygraph is defined by:

–  $\overline{\mathcal{AOB}}$  has the same 0-cells and 1-cells than the linear  $(3, 2)$ -polygraph  $\mathcal{AOB}$ ,

–  $\overline{\mathcal{AOB}}_2 = \mathcal{AOB}_2 \cup \{ \curvearrowright, \curvearrowleft, \begin{array}{c} \bullet \\ \downarrow \end{array}, \begin{array}{c} \downarrow \quad \downarrow \\ \diagup \quad \diagdown \\ \downarrow \quad \downarrow \end{array}, \begin{array}{c} \downarrow \quad \downarrow \\ \diagdown \quad \diagup \\ \downarrow \quad \downarrow \end{array} \}$ ,

–  $\overline{\mathcal{AOB}}_3$  is made of the following four families of 3-cells:

### Isotopy 3-cells

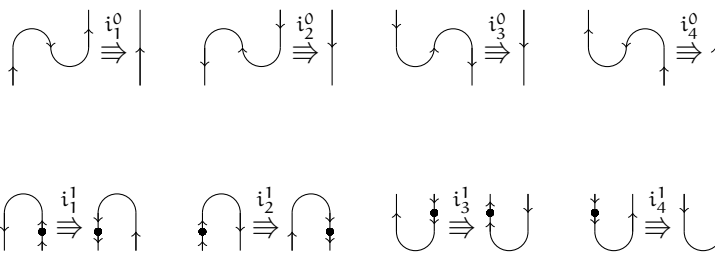

### Reidemeister 3-cells

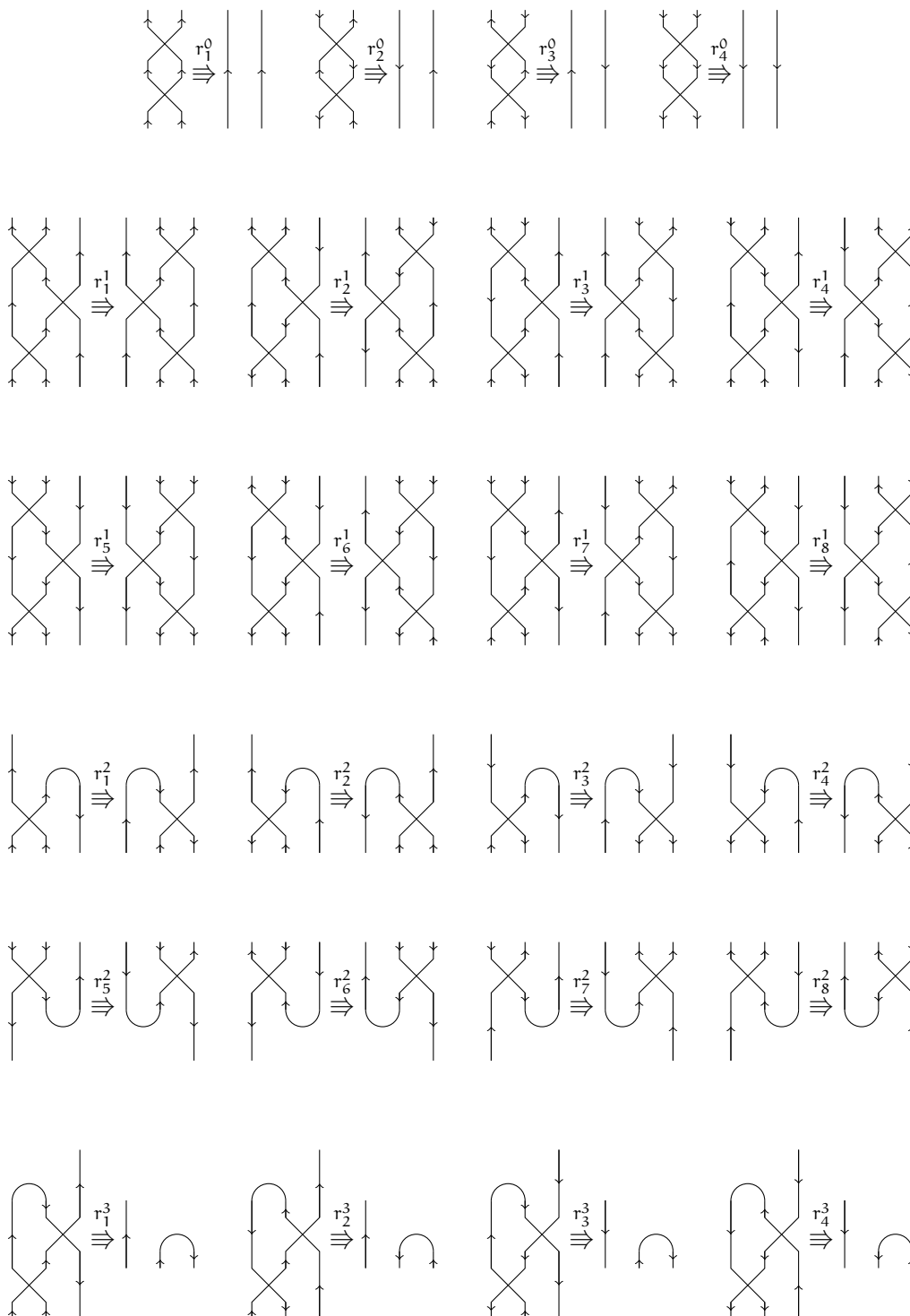

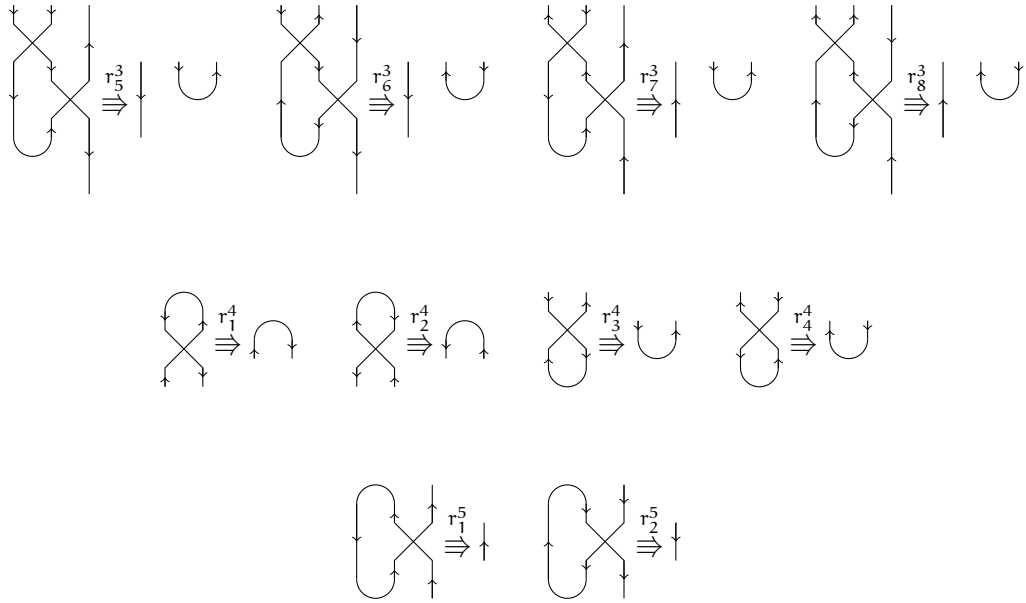

Ordering 3-cells

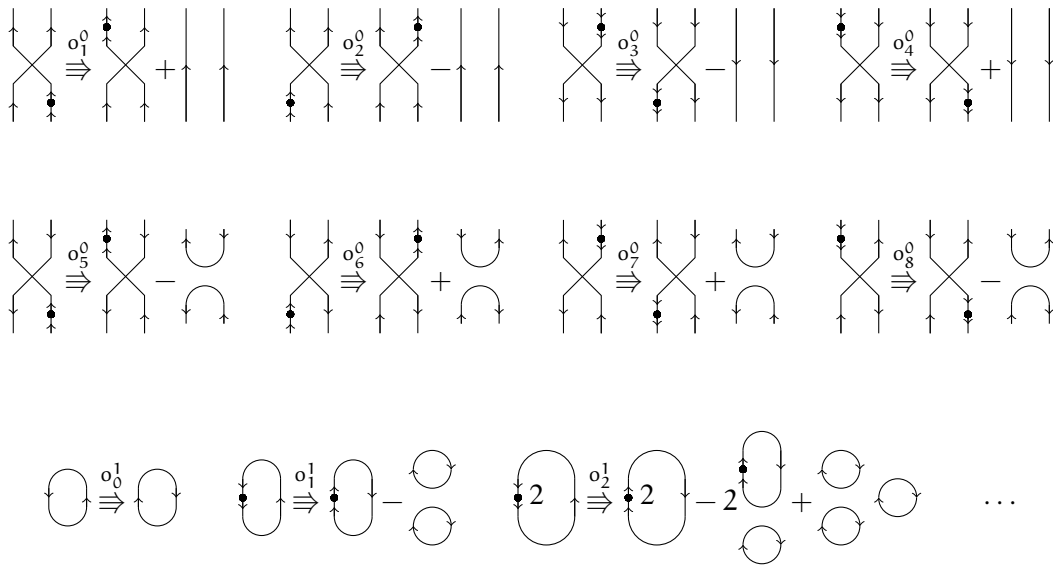

Sliding 3-cells

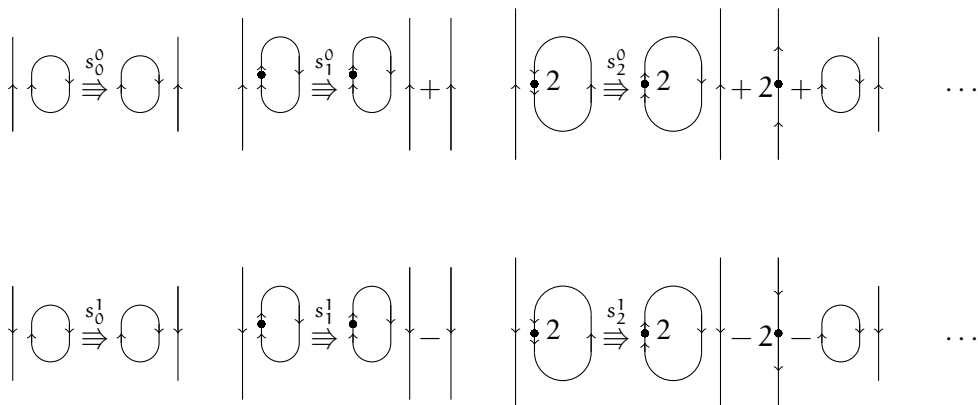

**5.2.2. Remark.** The last three families of 3-cells correspond to infinite families of relations which can be calculated by induction. Those relations are noted as in Convention (5). The first induction formula is given in [BCNR14]. If we denote the counterclockwise bubble with  $n$  dots

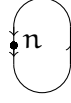

as  $u_{n,0}$  and by expressing the clockwise bubbles with  $m$  dots



as  $u_{0,m}$ , we have for any  $n$  and  $m$  of  $\mathbb{N}$ :

$$u_{n+1,m} = u_{n,m+1} - u_{n,0} \star_1 u_{0,m}.$$

Which can be used to rewrite  $u_{n,0}$  as a linear combination of the family  $(u_{0,i}^j)_{0 \leq i \leq n, j \in \mathbb{N}}$ . The others induction formulas are:

$$v_{n+1,m} = v_{n,m+1} + w_{n+m} + \sum_{k=0}^{n-1} w_{m+n-k} \star_1 v_{k,0},$$

$$v'_{n+1,m} = v'_{n,m+1} + w'_{n+m} - \sum_{k=0}^{n-1} v'_{0,k} \star_1 w'_{m+n-k}$$

where  $v_{n,0}$ ,  $v_{0,m}$ ,  $v'_{n,0}$  and  $v'_{0,m}$  respectively denote:

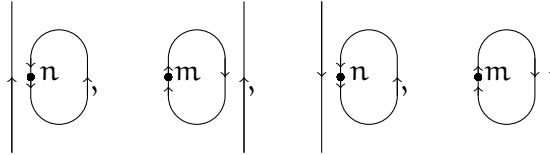

and where  $w_n$  and  $w'_n$  respectively denote:

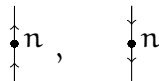

Let us now expand on the first chapter of [Tur10]. This chapter defines first ribbon categories as braided monoidal categories with duals and twist. The twist is a natural transformation  $\theta$  from the identity functor to itself satisfying:

$$\theta_{V \otimes W} = b_{W,V} \circ (\theta_V \otimes \theta_W) \circ b_{V,W}$$

for each objects  $V$  and  $W$ , where  $b$  denotes the braiding. A ribbon category satisfies the axiom  $\theta^* = \theta$ .

An example of ribbon category is the category of ribbon tangles on a set  $S$  of colors. This strict monoidal category  $\mathcal{RIB}_S$  is defined by:

- the objects of  $\mathcal{RIB}_S$  are the words of the free monoid on  $S \times \{\vee, \wedge\}$ ,
- the morphisms of  $\mathcal{RIB}_S$  from a word  $u$  to a word  $v$  are the oriented tangles of colored ribbons such that the word  $u$  is on the upper boundary and the word  $v$  is on the lower boundary,
- two isotopic tangles are equal.

In this category, each object is its own dual. The twist corresponds to transversally twisting a ribbon by 360 degrees. Turaev then gives a presentation by generators and relations of  $\mathcal{RIB}_S$ . The generators are the cups, caps, crossings and twistings of each ribbon colors and directions. The relations are invariance by multiple moves Turaev describes as elementary isotopies and Reidemeister moves.

From the presentation of  $\mathcal{RIB}_S$  by generators and relations, we can present the category  $\mathcal{RIB}$  of ribbon tangles with only one color by generators and relations.  $\mathcal{RIB}$  being a monoidal category, we can describe it as a 2-category with only one 0-cell. The linearization of  $\mathcal{RIB}$  is thus a linear  $(2, 2)$ -category with the same 0-cell and 1-cells than  $\mathcal{RIB}$ . We will call  $\mathcal{RIB}_{\mathbb{K}}$  this linear  $(2, 2)$ -category, where  $\mathbb{K}$  is our fixed field. Let  $\mathcal{OB}$  be the subcategory of  $\mathcal{AOB}$  defined by:

- $\mathcal{OB}_0 = \mathcal{AOB}_0$  and  $\mathcal{OB}_1 = \mathcal{AOB}_1$ ,
- $\mathcal{OB}_2$  is made of the oriented Brauer diagrams with bubbles (without dots)

The linear 2-functor from  $\mathcal{RIB}_{\mathbb{K}}$  to  $\mathcal{OB}$  sending each ribbon to a string with the same direction is full as noted in [BCNR14]. We derive from this fact a description of elementary isotopies and Reidemeister moves first described in [Tur10] for the linear  $(2, 2)$ -category  $\mathcal{AOB}$

**5.2.3. Proposition.** *The linear  $(3, 2)$ -polygraph  $\overline{\mathcal{AOB}}$  is a presentation of the linear  $(2, 2)$ -category  $\mathcal{AOB}$ .*

*Proof.* All 3-cells of  $\overline{\mathcal{AOB}}$  correspond to a relation verified in the linear  $(2, 2)$ -category  $\mathcal{AOB}$  by Definition 5.1.4. Moreover, the set of 3-cells of type  $i^0, r^0, r^1, r^2, r^4$ , and  $r^5$  contains all elementary isotopies and Reidemeister moves given in [Tur10] (Chapter 1, Section 4), and thus generates the equivalence of dotted oriented Brauer diagram with bubbles. As a consequence, the 3-cells of  $\overline{\mathcal{AOB}}$  are sufficient to find any relation verified in  $\overline{\mathcal{AOB}}$ .  $\square$

Then, we define some particular 2-cells of  $\overline{\mathcal{AOB}}_2^l$ .

**5.2.4. Definition.** We call a monomial of  $\overline{\mathcal{AOB}}$  quasi-reduced if the only 3-cells we can apply to it are of the form:

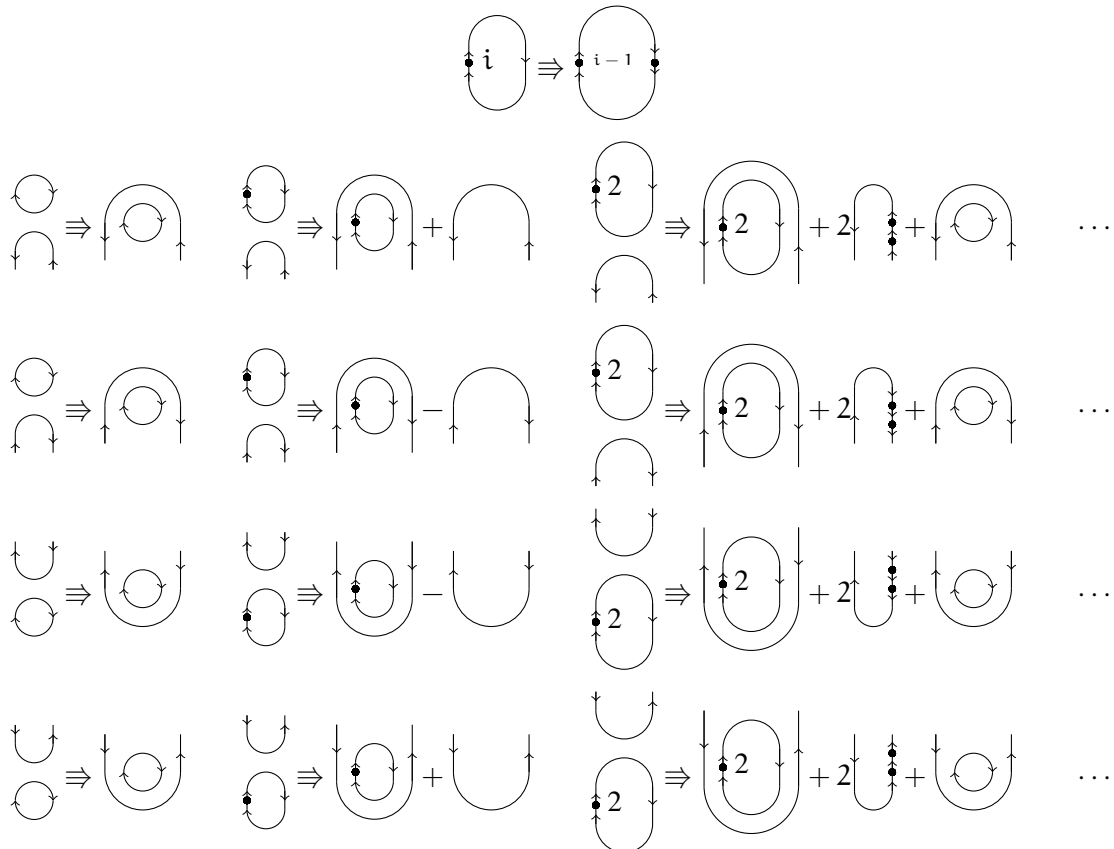



We call a 2-cell of  $\overline{\text{AOB}}_2^l$  quasi-reduced if all monomials in its monomial decomposition are quasi-reduced.

**5.2.5. Lemma.** *The linear (3, 2)-polygraph  $\overline{\text{AOB}}$  is locally confluent.*

*Proof.* We will prove all critical branchings of  $\overline{\text{AOB}}$  are confluent, which will give local confluence of  $\overline{\text{AOB}}$  by 4.2.13 because its strict canonical rewrite order is well-founded.

We enumerate first the sources of the critical branchings which do not involve dotted bubbles, starting with the overlapping of the isotopy 3-cells and continuing in the order in which the relations are given. The first given 3-cell of AOB is  $i_1^0$ . We search for all the cells having a source overlapping with the source of  $i_1^0$ . Those 3-cells are  $i_3^0, i_2^1, r_1^2$  and a family of sliding 3-cells given in the end denoted by  $s_*$ . We continue our enumeration by searching for all the overlaps of the source of  $i_2^0$  and so on. The final enumeration is:

$$\begin{aligned}
& (i_1^0, i_3^0), (i_1^0, i_2^1), (i_1^0, r_1^2), (i_1^0, r_3^2), (i_2^0, i_4^0), (i_2^0, i_3^1), (i_2^0, r_2^2), (i_2^0, r_4^2), (i_3^0, i_4^1), (i_3^0, r_5^2), \\
& (i_3^0, r_7^2), (i_4^0, i_1^1), (i_4^0, r_6^2), (i_4^0, r_8^2), (i_1^1, r_2^2), (i_1^1, r_4^2), (i_3^1, r_6^2), (i_3^1, r_8^2), (r_1^0, r_1^0), (r_1^0, r_1^1), \\
& (r_1^0, r_1^2), (r_1^0, r_4^1), (r_1^0, r_7^2), (r_1^0, r_1^3), (r_2^0, r_2^0), (r_2^0, r_2^1), (r_2^0, r_4^1), (r_2^0, r_8^1), (r_2^0, r_2^2), \\
& (r_2^0, r_7^2), (r_2^0, r_3^3), (r_2^0, r_6^3), (r_2^0, r_4^4), (r_2^0, r_3^4), (r_2^0, o_6^0), (r_2^0, o_7^0), (r_3^0, r_3^0), (r_3^0, r_3^1), \\
& (r_3^0, r_6^1), (r_3^0, r_7^1), (r_3^0, r_3^2), (r_3^0, r_6^2), (r_3^0, r_3^3), (r_3^0, r_7^3), (r_3^0, r_4^1), (r_3^0, r_4^4), (r_3^0, o_5^0), \\
& (r_3^0, o_8^0), (r_4^0, r_4^0), (r_4^0, r_5^1), (r_4^0, r_6^1), (r_4^0, r_7^1), (r_4^0, r_4^2), (r_4^0, r_5^2), (r_4^0, r_4^3), (r_4^0, r_5^3), \\
& (r_4^0, o_4^0), (r_4^0, o_7^0), (r_1^1, r_1^1), (r_1^1, o_1^0), (r_1^1, o_2^0), (r_2^1, r_4^1), (r_2^1, r_7^3), (r_2^1, o_5^0), (r_2^1, o_7^0), \\
& (r_3^1, r_3^1), (r_3^1, r_3^2), (r_3^1, r_4^1), (r_3^1, o_5^0), (r_3^1, o_6^0), (r_3^1, o_7^0), (r_4^1, r_8^2), (r_4^1, r_8^2), (r_4^1, r_8^3), \\
& (r_4^1, r_2^4), (r_4^1, o_1^0), (r_4^1, o_2^0), (r_4^1, o_6^0), (r_4^1, o_8^0), (r_5^1, r_5^1), (r_5^1, o_3^0), (r_5^1, o_4^0), (r_6^1, r_7^1), \\
& (r_6^1, r_3^2), (r_6^1, r_5^2), (r_6^1, r_3^3), (r_6^1, r_4^1), (r_6^1, o_5^0), (r_6^1, o_7^0), (r_7^1, r_4^1), (r_7^1, r_6^2), (r_7^1, r_3^4), \\
& (r_7^1, r_4^4), (r_7^1, o_4^0), (r_7^1, o_5^0), (r_7^1, o_6^0), (r_8^1, r_8^1), (r_8^1, r_3^3), (r_8^1, r_6^3), (r_8^1, r_2^4), (r_8^1, r_3^4), \\
& (r_8^1, o_3^0), (r_8^1, o_5^0), (r_8^1, o_8^0), (r_7^2, r_8^2), (r_7^2, r_7^3), (r_7^2, r_8^3), (r_7^2, r_5^5), (r_7^2, o_1^0), (r_7^2, o_2^0), \\
& (r_2^2, r_4^3), (r_2^2, r_8^3), (r_2^2, r_4^4), (r_2^2, o_5^0), (r_2^2, r_3^1), (r_2^2, r_6^3), (r_2^2, r_4^4), (r_2^2, o_6^0), (r_4^2, r_5^2), \\
& (r_4^2, r_3^3), (r_4^2, r_5^3), (r_4^2, r_2^5), (r_4^2, o_4^0), (r_5^2, r_4^3), (r_5^2, r_6^3), (r_5^2, r_2^5), (r_5^2, o_3^0), (r_5^2, o_4^0), \\
& (r_6^2, r_8^3), (r_6^2, r_4^1), (r_6^2, o_7^0), (r_7^2, r_3^3), (r_7^2, r_5^3), (r_7^2, r_4^4), (r_7^2, o_6^0), (r_7^2, o_8^0), (r_8^2, r_3^2), \\
& (r_8^2, r_5^1), (r_8^2, o_2^0), (r_3^3, r_8^3), (r_3^3, o_1^0), (r_3^3, o_2^0), (r_3^3, r_4^4), (r_3^3, o_5^0), (r_3^3, o_6^0), (r_3^3, r_4^4), \\
& (r_3^3, o_3^0), (r_3^3, o_5^0), (r_4^3, r_5^3), (r_4^3, o_5^0), (r_4^3, o_7^0), (r_5^3, o_3^0), (r_5^3, o_4^0), (r_6^3, r_2^4), (r_6^3, r_4^4), \\
& (r_6^3, o_7^0), (r_6^3, o_8^0), (r_7^3, r_4^1), (r_7^3, o_1^0), (r_7^3, o_7^0), (r_8^3, o_5^0), (r_8^3, o_7^0), (r_4^4, r_4^4), (r_4^4, o_6^0), \\
& (r_2^4, r_3^4), (r_2^4, o_5^0), (r_3^4, o_8^0), (r_4^4, o_7^0), (r_1^5, o_1^0), (r_2^5, o_3^0), \\
& (i_1^0, s_*), (i_2^0, s_*), (i_3^0, s_*), (i_4^0, s_*), (r_1^0, s_*), (r_2^0, s_*), (r_3^0, s_*), (r_4^0, s_*), \\
& (r_1^1, s_*), (r_2^1, s_*), (r_3^1, s_*), (r_4^1, s_*), (r_5^1, s_*), (r_6^1, s_*), (r_7^1, s_*), (r_8^1, s_*), \\
& (r_2^2, s_*), (r_2^2, s_*), (r_2^2, s_*), (r_4^2, s_*), (r_5^2, s_*), (r_6^2, s_*), (r_7^2, s_*), (r_8^2, s_*), \\
& (r_1^3, s_*), (r_2^3, s_*), (r_3^3, s_*), (r_4^3, s_*), (r_5^3, s_*), (r_6^3, s_*), (r_7^3, s_*), (r_8^3, s_*), \\
& (r_1^4, s_*), (r_2^4, s_*), (r_3^4, s_*), (r_4^4, s_*), (r_1^5, s_*), (r_2^5, s_*), (o_*^1, s_*), (s_*, s_*).
\end{aligned}$$

By doing this, we remark we can eliminate multiple critical branchings, similar to others. First, we can ignore the directions of the up and down for each of the following interactions:

- all critical branchings involving  $i_k^1$  and  $i_l^1$  for some  $1 \leq k \leq 4$  and  $1 \leq l \leq 4$ ,

- all critical branchings involving  $i_k^1$  for some  $1 \leq k \leq 4$  and a Reidemeister 3-cell,
- all critical branchings involving two Reidemeister 3-cells.

Indeed, the above 3-cells correspond to the relations verified by the category  $\mathcal{OB}$  defined in [BCNR14]. Those relations do not depend on the up or down directions. Those relations are also invariant by axial symmetry. Those facts allow us to withdraw multiple critical pairs from our enumeration. In the same way, any critical branchings involving two isotopy 3-cells can be studied up to axial symmetry.

The interactions between an ordering 3-cell and a Reidemeister 3-cell are not invariant by symmetry. But, when a critical branching involving an ordering 3-cell and a Reidemeister 3-cell  $r_k^1$  is confluent, all critical branchings involving an ordering 3-cell and a 3-cell of the form  $r_*^k$  are confluent. This fact allows us to treat multiple cases of critical branching simultaneously.

We now verify each critical branching is confluent. For each critical branching we are treating, we will use notation 4.2.5. Thus, we will give the source of each critical branching and a target attained once a confluence diagram is given for this critical pair.

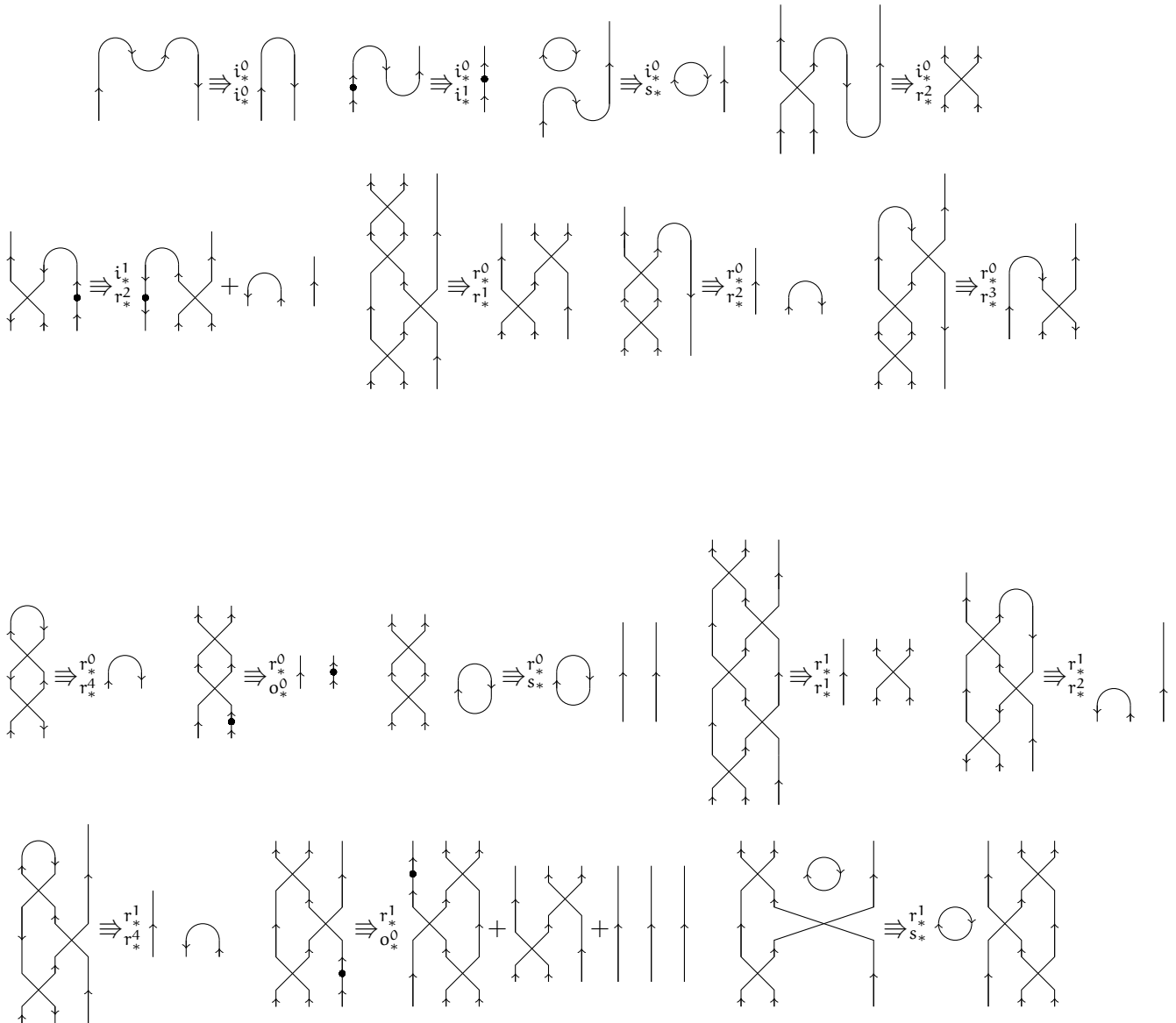

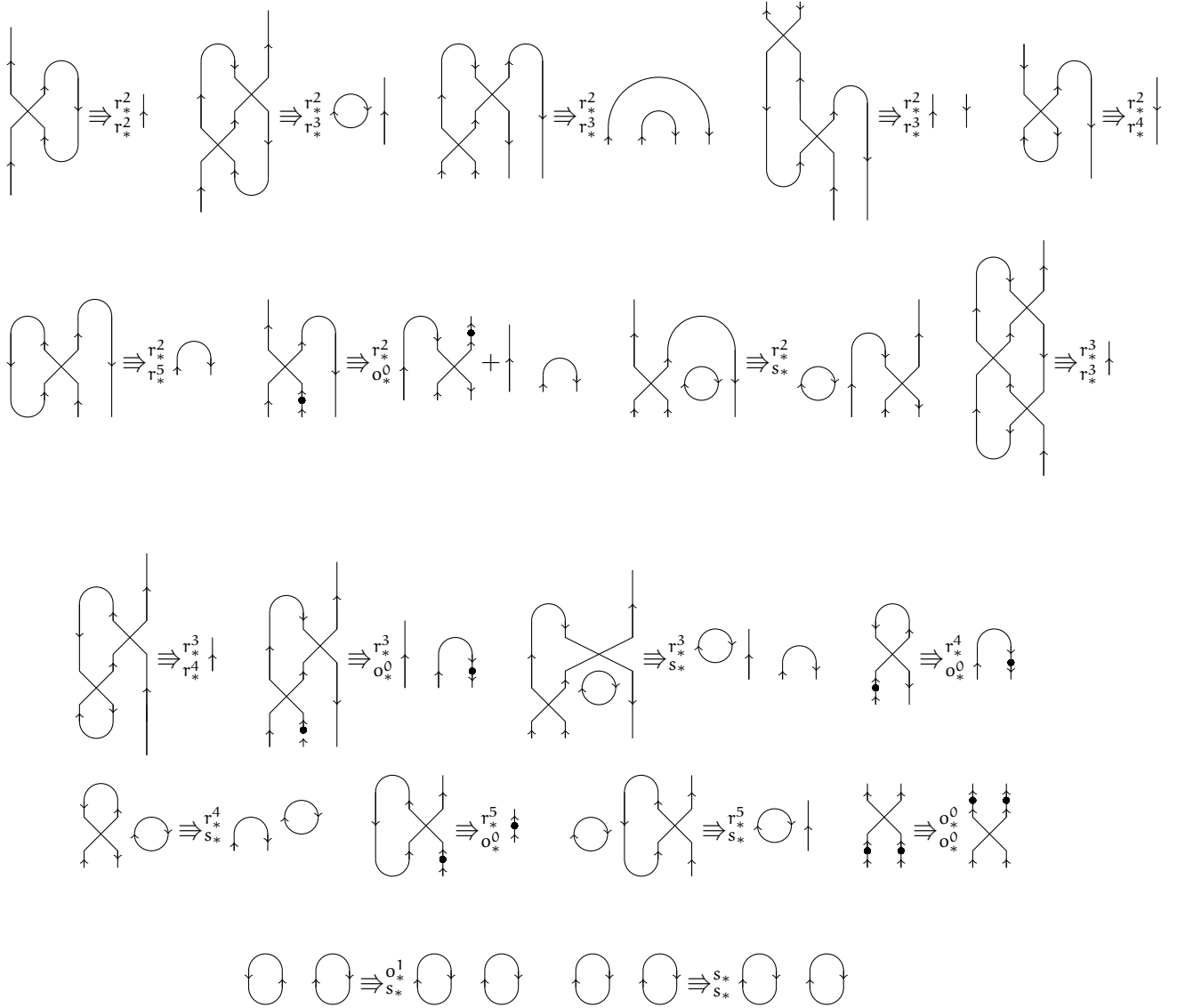

The sliding 3-cells can be seen as making a bubble going through an identity and creating some additive residues. For each  $n$  of  $\mathbb{N}$ , the only bubbles created by the 3-cells  $s_n^0$  and  $s_n^1$  have less than  $n$  dots. Thus, treating the confluence of the critical branchings involving no sliding relation other than  $s_0^0$  and  $s_0^1$  shows by induction on  $n$  all critical branchings involving sliding relations are confluent. This deals with the totality of the critical branchings.  $\square$

**5.2.6. Lemma.** *Each 2-cell of the linear  $(2, 2)$ -polygraph  $\overline{\text{AOB}}_2^\ell$  can be rewritten into a quasi-reduced 2-cell.*

Before proving this claim, we introduce the notion of weight function on a linear  $(2, 2)$ -category.

**5.2.7. Definition.** Let  $\mathcal{C}$  be a linear  $(2, 2)$ -category. A weight function on  $\mathcal{C}$  is a function  $\tau$  from  $\mathcal{C}_2$  to  $\mathbb{N}$  such that:

- for each 0-composable monomials  $a$  and  $b$  we have  $\tau(a \star_0 b) = \tau(a) + \tau(b)$ ,
- for each 1-composable monomials  $a$  and  $b$  we have  $\tau(a \star_1 b) = \tau(a) + \tau(b)$ ,
- for each 2-cell  $x$ , we have  $\tau(x) = \max\{\tau(a) \mid a \text{ appears in the monomial decomposition of } x\}$ .

*Proof.* To prove that each 2-cell of  $\overline{\text{AOB}}_2^\ell$  rewrites into a normally dotted oriented Brauer diagram, we give first a weight function  $\tau$  on  $\overline{\text{AOB}}_2^\ell$  defined by:

$$\begin{aligned} \tau \begin{array}{c} \curvearrowright \\ \downarrow \end{array} &= \tau \begin{array}{c} \curvearrowleft \\ \downarrow \end{array} = \tau \begin{array}{c} \uparrow \\ \cup \end{array} = \tau \begin{array}{c} \downarrow \\ \cup \end{array} = 1 \\ \tau \begin{array}{c} \downarrow \quad \downarrow \\ \times \end{array} &= \tau \begin{array}{c} \downarrow \quad \downarrow \\ \times \end{array} = \tau \begin{array}{c} \downarrow \quad \downarrow \\ \times \end{array} = \tau \begin{array}{c} \downarrow \quad \downarrow \\ \times \end{array} = 3 \\ \tau \begin{array}{c} \downarrow \\ \bullet \\ \downarrow \end{array} &= \tau \begin{array}{c} \downarrow \\ \bullet \\ \downarrow \end{array} = 0 \end{aligned}$$

Then, we give the following algorithm taking a monomial  $m$  as an entry:

- While  $m$  can be rewritten into a 2-cell  $m'$  such that  $\tau(m') < \tau(m)$  do:
  - assign  $m$  to  $m'$
- While  $m$  can be rewritten into a 2-cell  $m'$  without applying a 3-cell of the form:

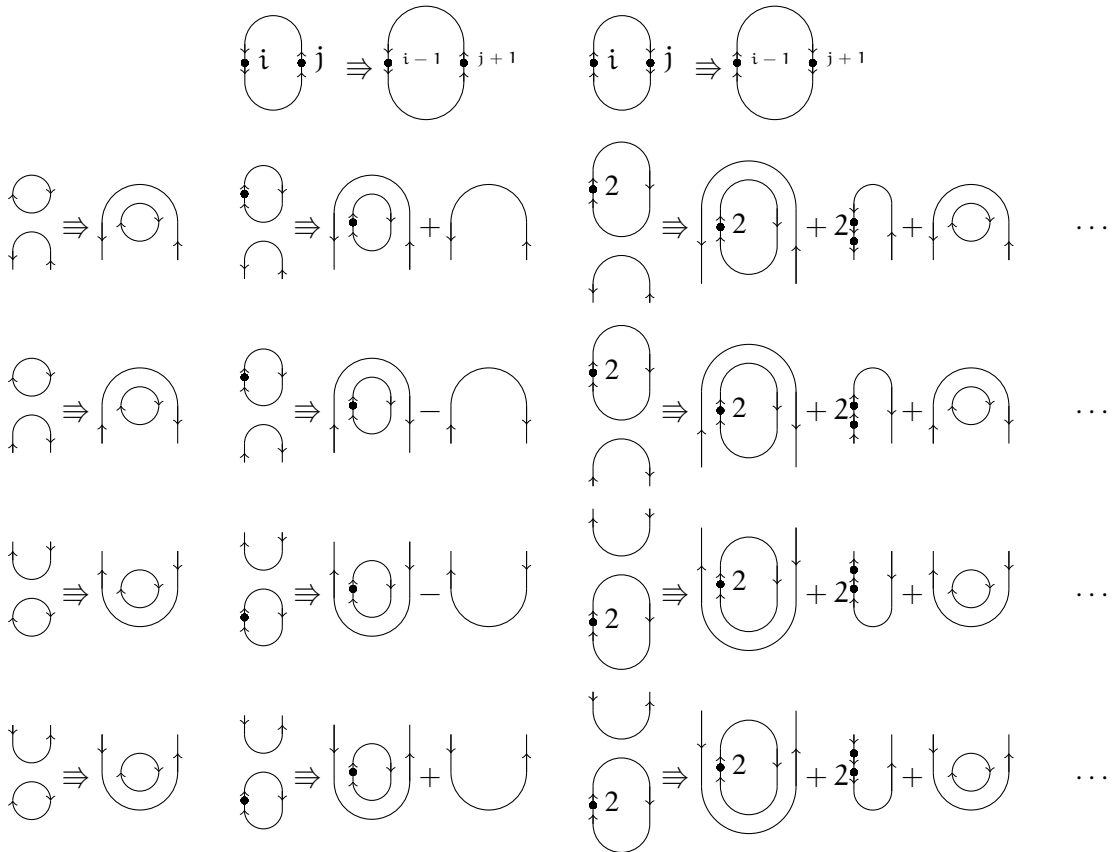

do:

- assign  $m$  to  $m'$

This algorithm terminates because  $\Sigma$  is terminating without the sliding 3-cells and the isotopy 3-cells that do not decrease the weight. This results in rewriting any 2-cell into a linear combination of normally ordered Brauer diagrams. For each equivalence class of dotted oriented Brauer diagram with bubbles, exactly one representative of this class can appear in a 2-cell attained by the given algorithm because there is no isotopy or Reidemeister 3-cell to apply anymore. Those are the quasi-reduced monomials.  $\square$

**5.2.8. Lemma.** *The linear  $(3, 2)$ -polygraph  $\overline{\text{AOB}}$  is decreasing.*

*Proof.* We define the set  $\mathcal{P} = \{P_n | n \in \mathbb{N}\}$  where for each rewriting step  $\alpha$  of  $\overline{AOB}$  and each  $n$  in  $\mathbb{N}$ , we have  $\alpha \in P_n$  if and only if the rewriting sequence of minimal length from  $t_2(\alpha)$  to a quasi-reduced 2-cell is of length  $n$ . Because of the fact that every 2-cell can be rewritten into a quasi-reduced one 5.2.6,  $\mathcal{P}$  is a partition of the set of rewriting steps of  $\overline{AOB}$ . We give on this partition the order  $\prec$  such that  $P_n \prec P_m$  if and only if  $n < m$ . This well-founded order respects all the properties of 4.3.1 for the critical branchings of  $\overline{AOB}$ . The decreasingness critical branchings is explicited in the appendix. Then, the order  $\prec$  meets the properties of 4.3.1, ending the proof by 4.3.3.  $\square$

**5.2.9. Theorem.** *The linear  $(3, 2)$ -polygraph  $\overline{AOB}$  is a confluent presentation of  $AOB$ .*

*Proof.* The linear  $(3, 2)$ -polygraph  $\overline{AOB}$  is locally confluent by lemma 5.2.5. Lemma 5.2.8 allows us to use 4.3.3 and conclude the proof.  $\square$

This theorem implies the following result from [BCNR14]:

**5.2.10. Corollary.** *Let  $a$  and  $b$  be two 1-cells of the linear  $(2, 2)$ -category  $AOB$ . Then, the vector space  $AOB_2(a, b)$  has basis given by equivalence classes of normally ordered dotted oriented Brauer diagrams with bubbles with source  $a$  and target  $b$ .*

*Proof.* We need to give a confluent left-monomial linear  $(3, 2)$ -polygraph presenting the linear  $(2, 2)$ -category  $AOB$  such that:

- There is a bijection between the 2-cells of the free linear  $(2, 2)$ -category and dotted oriented Brauer diagrams with bubbles.
- A normally ordered dotted oriented Brauer diagram does not rewrite into a linear combination of non-equivalent others.
- Each 2-cell that is not in normal form rewrites into a linear combination of normally ordered dotted oriented Brauer diagrams.

The linear  $(3, 2)$ -polygraph  $\overline{AOB}$  from 5.2.9 verifies those properties. To prove that a normally ordered Brauer diagram does not rewrite into a linear combination of non-equivalent others, it is sufficient to show that a quasi-reduced 2-cell does not rewrite into another quasi-reduced 2-cell. The only way to rewrite a quasi-reduced monomial is to apply sliding 3-cells or isotopy relations that do not decrease the weight. So, the only way to rewrite a quasi-reduced monomial into a linear combination of others is to use rewriting paths of the forms:

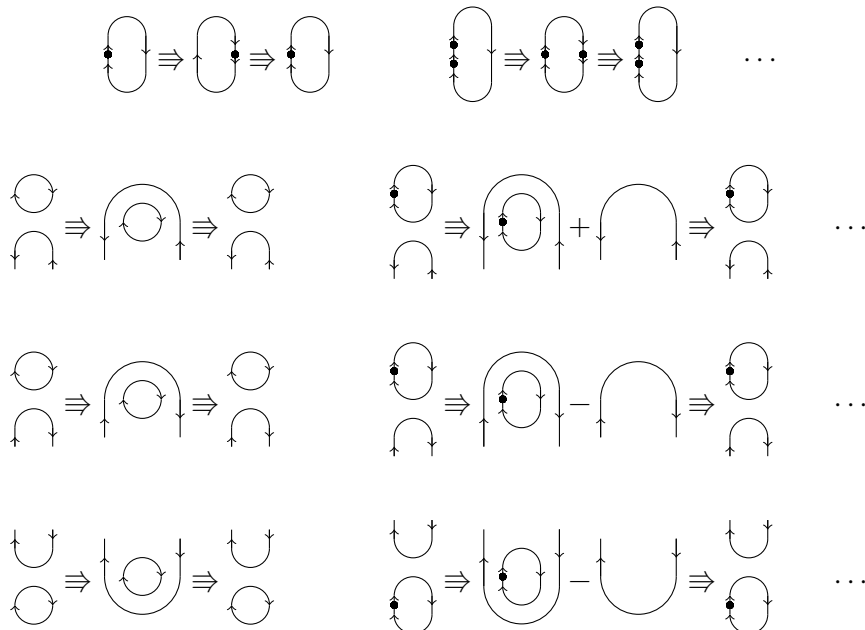

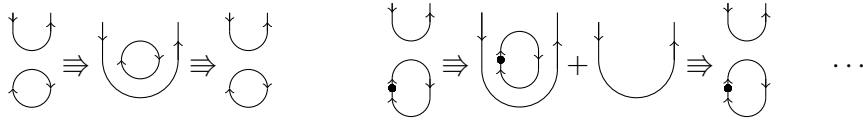

Then, a quasi-reduced 2-cell does not rewrite into a linear combination of others.  $\square$

## REFERENCES

- [BC04] John Baez and Alissa Crans. Higher-dimensional algebra. VI. Lie 2-algebras. *Theory Appl. Categ.*, 12:492–538, 2004.
- [BCNR14] Jonathan Brundan, Jonathan Comes, David Nash, and Andrew Reynolds. A basis theorem for the affine oriented Brauer category and its cyclotomic quotients. *ArXiv: 1404.6574*, 2014.
- [Bur93] Albert Burroni. Higher-dimensional word problems with applications to equational logic. *Theoret. Comput. Sci.*, 115(1):43–62, jul 1993.
- [GM09] Yves Guiraud and Philippe Malbos. Higher-dimensional categories with finite derivation type. *Theory Appl. Categ.*, 22:No. 18, 420–478, 2009.
- [Hue80] Gérard Huet. Confluent reductions: abstract properties and applications to term rewriting systems. *J. Assoc. Comput. Mach.*, 27(4):797–821, 1980.
- [KMP11] David Khudaverdyan, Ashis Mandal, and Norbert Poncin. Higher categorified algebras versus bounded homotopy algebras. *Theory Appl. Categ.*, 25:No. 10, 251–275, 2011.
- [Mét08] François Métayer. Cofibrant objects among higher-dimensional categories. *Homology, Homotopy Appl.*, 10(1):181–203, 2008.
- [Mit72] Barry Mitchell. Rings with several objects. *Advances in Mathematics*, 8:1–161, 1972.
- [New42] Maxwell Newman. On theories with a combinatorial definition of “equivalence”. *Ann. of Math. (2)*, 43(2):223–243, 1942.
- [RS13] Hebing Rui and Yucai Su. Affine walled brauer algebras. *ArXiv: 1305.0450*, 2013.
- [Str87] Ross Street. The algebra of oriented simplexes. *J. Pure Appl. Algebra*, 49(3):283–335, 1987.
- [Tur10] Vladimir Turaev. *Quantum Invariants of Knots and 3-Manifolds*, volume 18 of *Studies in Mathematics*. de Gruyter, 2010.
- [vO94] Vincent van Oostrom. *Confluence for Abstract and Higher-Order Rewriting*. PhD thesis, 1994.

## 6. APPENDIX

In this appendix, we give all confluence diagrams for the critical branchings of  $\overline{\text{AOB}}$  verifying the axioms of decreasingness. For each  $n$  in  $\mathbb{N}$ , with respect to the partition defined in the proof of lemma 5.2.8, we index the rewriting steps of  $P_n$  by  $n$ .



