



HAL
open science

Application of continuous spindle speed variation for chatter avoidance in milling. Optimisation of speed variation parameters

Iñigo Bediaga, Mikel Zatarain, Jokin Munoa, Rafael Lizarralde, Luis Norberto López de Lacalle

► To cite this version:

Iñigo Bediaga, Mikel Zatarain, Jokin Munoa, Rafael Lizarralde, Luis Norberto López de Lacalle. Application of continuous spindle speed variation for chatter avoidance in milling. Optimisation of speed variation parameters. 7th International CIRP Conference on High Speed Machining, May 2008, Darmstadt, Germany. hal-01271076

HAL Id: hal-01271076

<https://hal.science/hal-01271076v1>

Submitted on 17 Feb 2016

HAL is a multi-disciplinary open access archive for the deposit and dissemination of scientific research documents, whether they are published or not. The documents may come from teaching and research institutions in France or abroad, or from public or private research centers.

L'archive ouverte pluridisciplinaire **HAL**, est destinée au dépôt et à la diffusion de documents scientifiques de niveau recherche, publiés ou non, émanant des établissements d'enseignement et de recherche français ou étrangers, des laboratoires publics ou privés.

Application of continuous spindle speed variation for chatter avoidance in milling. Optimisation of speed variation parameters.

I. Bediaga¹, M. Zatarain¹, J. Muñoa¹, R. Lizarralde¹, L.N. López de Lacalle²

¹Ideko IK4, Elgoibar, Spain

²University of the Basque Country, Mechanical Engineering Dept., Bilbao, Spain

Abstract

This paper investigates the effectiveness of Continuous Spindle Speed Variation (CSSV) technique as a chatter suppression strategy in milling process. On this purpose, a twofold study was carried out: on the one hand, a simulation analysis, and on the other, experimental tests. First, Semidiscretization method has been extended to n -mode systems in any spatial directions and modified to include simulation capabilities concerning spindle speed variation with different waveforms. A new kind of stability map for different amplitude and frequency variations is proposed in order to optimise the parameter selection when machining. Finally, the effectiveness of CSSV technique is verified through experimental tests.

Keywords:

Chatter, Milling, Continuous Spindle Speed Variation, Semidiscretization

1 INTRODUCTION

The productivity of milling operations is often constrained by the regenerative chatter. This occurs when relative vibrations between the cutting tool and the workpiece feed back the cutting force, leading to self-excited vibrations. Depending on cutting conditions and dynamic properties, the vibration feed back can lead to a decreasing vibration (stable cut) or to an increasing vibration resulting in chatter (unstable cut). This affects the quality of the machined surface, along with excessive tool wear or tool breakage. Thereby the material removal rate is limited.

In order to increase the material removal rate a chatter suppression method based on Continuous Spindle Speed Variation (CSSV) is analysed. This technique consists in a continuous variation of the tooth passing frequency, yielding a continuous variation of the phase between the tool-workpiece relative displacement and the tooth passing cycle. This is an 'electronic' or software way to continuously change the phase lag, comparable to the 'mechanic' or hardware way of using uneven pitch mills.

2 STATE OF THE ART

Knowledge of chatter vibration has been progressing since the first papers by Tobias [1] and Tlustý[2]. The basic theory did not advance significantly until the research by Altintas and Budak [3], were the general single frequency multimodal solution was developed [4], and Budak and Altintas [5] were the general solution for milling was obtained by using multifrequency [6].

Later, some new ways of obtaining the lobe diagram for milling were proposed. Fundamental papers were those of Davies et al. [7], Insperger et al. [8], and Baily et al. [9]. In these papers the uprising of a new chatter situation in milling was shown: that of period doubling, which appears mainly at high cutting speeds and low radial immersions. Merdol and Altintas [10] proved that multifrequency theory also explains the emergence of this chatter mechanism.

Variable pitch mills have been used since many years ago to increase the stable limit depth of cut. Probably a paper by Slavicek [11] is the oldest one showing this effect.

Outstanding papers in this direction are those by Stone [12], Altintas et al. [13], and Budak [14].

Continuous speed variation might be considered as an equivalent for variable pitch mills in single cutting edge processes, like turning. In milling, speed variation provides a more flexible solution than variable pitch mills, as proposed by Stone [15].

Inamura and Sata [16] produced a simple function for the study of the stability with variable spindle speed for the turning process. Their experimental results were not as good as those calculated by their theory.

Takemura et al. [17] analysed the stability of turning with variable speed by means of an energy balance. The analysis was performed for triangular, rectangular and sinusoidal speed variations.

Sexton and Stone [18], disagreed with previous works, like [16], showing that the results for variable speed machining are not spectacular. The theoretically good results of previous works were due to oversimplified models of the system.

De Canniere et al. [19] used the perturbation analysis for the determination of the stability in turning with CSSV. This analysis is only valid for small speed and frequency variations. With these conditions, they showed that the speed modulation is equivalent to the modulation of the time lag. This fact was also used by Altintas and Chan [20], who developed a system based on the modulation of the speed for stabilisation of chatter vibration.

Tsao et al. [21] used the angle domain to analyse variable speed machining. It was shown that this technique is very sensitive to the number of samples used in the discretization of the time system, and the conclusions were not trustworthy.

Jayaram et al. [22] developed a Fourier expansion of the equations of the process of turning. They used an approximation of the delayed vibration and obtained a system of an infinite number of frequencies, which could be solved approximately by truncation to a number of frequencies close to the main frequency only. The mathematics behind this approach resemble the method of Multifrequency [5] for constant speed milling.

This development was extended by Sastry et al. [23] for the process of face milling. Again, an infinite order system is found, which has to be truncated to be solved. This is the most advanced approach, up to now, to the application of CSSV in milling, but it still applies some simplifications to the problem.

Zatarain et al. [24] presented the general theory for analysis of milling with CSSV in the frequency domain and for any speed variation strategy. The results were compared with those obtained by Semidiscretization and time integration, as well as with those obtained by experiments.

Insperger and Stépán [25] used Semidiscretization to obtain lobe diagrams for turning processes with CSSV. Three kinds of speed variation schemes are investigated: Sinusoidal, increasing saw teeth, and decreasing saw teeth. They concluded that the best solution was that of sinusoidal speed variation.

3 CONTENT OF THE PAPER

Semidiscretization method has been well documented for systems with a single modes in X and Y directions. This paper will present the way to enhance the Semidiscretization method to n-mode systems in any spatial directions. Also, CSSV will be considered with different spindle speed variation strategies, and results of experimental tests that have been carried out for verification of the effectiveness of CSSV technique will be shown.

The arrangement of this paper is as follows. In section 4, machining conditions used for illustration of the theoretical developments and for the experiments are summarised. In section 5 the theoretical development of CSSV using extended Semidiscretization method is included. In section 6 CSSV parameter optimisation charts are shown. In section 7, the evolution of eigenvalues during CSSV simulation is analysed. Afterwards in section 8, experimental tests are detailed to demonstrate the utility of the SSV in milling.

4 PARAMETERS OF SYSTEM USED.

The developments that will be presented in this paper will be applied to a system with a flexible part support. The system has a clearly dominant mode in Y direction (perpendicular to feed), with parameters $\omega_n=95.6$ Hz, stiffness=49N/ μ m, $\zeta=0.6\%$. Cutting conditions are: Tool diameter 80 mm, 3 flutes, lead angle 45°, half immersion, down milling. Specific cutting coefficients: Tangential 1889 MPa, Radial 776 MPa, Axial 364 MPa.

5 THEORETICAL DEVELOPMENT USING SEMIDISCRETIZATION

The Semidiscretization method is a well-known technique in the analysis of rigid solids, or in the fluid mechanics. The application of this theory to stability modelling of the cutting process was carried out by Insperger and Stépán [26], and fully detailed for milling and turning processes with a single mode in X and Y directions by Insperger [27].

In this section the Semidiscretization method is enhanced to n-mode systems in any spatial directions and the CSSV with different waveforms is proposed.

5.1 Semidiscretization for n-modes of excitation

The first step to develop Semidiscretization method consists in the definition of the time interval $[\tilde{t}, \tilde{t}_{+1})$ of Δt

increments for $i=0,1\dots n$. So that the time increment at step can be expressed as $\Delta t = \tau / m$ where τ is the time delay and m is the approximation parameter of the Semidiscretization method.

The mechanical model of the milling process can be seen in the Figure 1, where the dynamical parameters are defined as m mass of the system, c damping coefficient, and k spring stiffness. The angular spindle speed is expressed as Ω in rad/s, and the cutting force in modal direction as F_m .

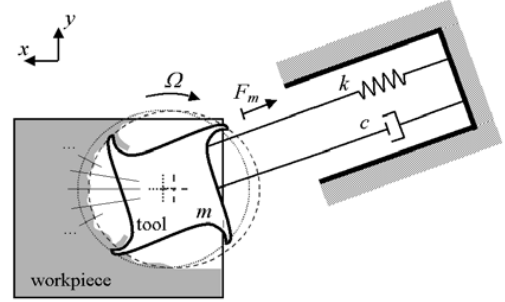

Figure 1: Mechanical model of milling process.

The cutting angle is divided into sufficiently small arcs, according to the defined time increment. So that, the cutting angle achieves from φ_0 to φ_n , then the arcs are $\varphi_0, \varphi_1, \varphi_2, \varphi_3\dots \varphi_n$. At each of these positions the displacement vectors of the tool at the previous pass are stored (1). These would represent the trajectory of tool tip in the previous pass.

$$\{\delta_0 \ \delta_1 \ \delta_2 \ \delta_3 \ \dots \ | \ \mathbf{q}_n \ \dot{\mathbf{q}}_n\}^T \quad (1)$$

Starting with the tool tip at the last angle, it is needed to know the state at that position, that is, the modal displacement and velocity for all the modes. For that position, these variables will be stored instead of the displacements, because the displacements do not contain all the necessary information of the state.

With position and speed defined by the parameters with sub index 'n', the state when the tool tip reaches the angle '0' is obtained again by calculating the free trajectory defined by modal coefficients,

$$\text{Time from 'n' to '0': } \Delta = \frac{2\pi + \varphi_0 - \varphi_n}{\Omega}$$

Free decay from 'n' to '0',

$$\mathbf{q}_0 = \begin{Bmatrix} q_1 \\ \vdots \\ q_m \\ \dot{q}_1 \\ \vdots \\ \dot{q}_m \end{Bmatrix}_0 = \mathbf{A}_{n0} \cdot \mathbf{q}_n = \begin{bmatrix} A11 & A12 \\ A21 & A22 \end{bmatrix} \begin{Bmatrix} q_1 \\ \vdots \\ q_m \\ \dot{q}_1 \\ \vdots \\ \dot{q}_m \end{Bmatrix}_n \quad (2)$$

Where A11 and A12 represent the damped free oscillation from 'n' to '0' position. And A21, A22 correspond to its derivate.

Now, at angle '0' chip width is calculated as,

$$h = \begin{bmatrix} \sin(\kappa)\sin(\varphi) \\ \sin(\kappa)\cos(\varphi) \\ -\cos(\kappa) \end{bmatrix}^T \left(\begin{bmatrix} \phi_{x1} & \phi_{xm} & 0 \\ \phi_{y1} & \phi_{ym} & \ddots \\ \phi_{z1} & \phi_{zm} & 0 \end{bmatrix} \mathbf{q}_0 - \delta_0 \right) \quad (3)$$

Cutting force at state \mathbf{q}_0 is,

$$\begin{Bmatrix} f_t \\ f_r \\ f_a \end{Bmatrix} = -b \begin{bmatrix} k_t \\ k_r \\ k_a \end{bmatrix} \begin{bmatrix} \sin(\kappa) \sin(\varphi) \\ \sin(\kappa) \cos(\varphi) \\ -\cos(\kappa) \end{bmatrix}^T (\mathbf{\Phi} \mathbf{0} \mathbf{q}_0 - \delta_0) \quad (4)$$

Projection of force into the mode is,

$$f_\phi = -b \mathbf{\Phi}^T \begin{bmatrix} \cos(\varphi) & \sin(\varphi) & 0 \\ -\sin(\varphi) & \cos(\varphi) & 0 \\ 0 & 0 & 1 \end{bmatrix} \begin{Bmatrix} f_t \\ f_r \\ f_a \end{Bmatrix} \quad (5)$$

If a more accurate solution was needed, the position between 0 and 1 could be obtained by including the velocity at position 0 for interpolation. Similarly, excess material from previous pass could be obtained by linear interpolation between 0 and 1.

Now the new state at position 1 can be calculated,

$$\mathbf{q}_1 = \mathbf{A}_{01} \mathbf{q}_0 + \mathbf{R}_{01} \mathbf{f}_\phi \equiv \mathbf{A}_{01} \begin{Bmatrix} q_0 \\ \dot{q}_0 \end{Bmatrix} - \mathbf{B}_{01} \mathbf{q}_0 + \mathbf{C}_{01} \delta_0 \quad (6)$$

$$\mathbf{A}_{01} = \begin{bmatrix} A11 & A12 \\ A21 & A22 \end{bmatrix}$$

Where A11 and A12 represent the damped free oscillation from one position to the next one. And A21, A22 correspond to its derivate.

The term \mathbf{B}_{01} of equation (6) is calculated as,

$$\mathbf{B}_{01} = \begin{bmatrix} \frac{\tau^2}{2} & \frac{\tau^3}{6} \\ \tau & \frac{\tau^2}{2} \end{bmatrix} \begin{bmatrix} \mathbf{Bf} & 0 \\ 0 & \mathbf{Bf} \end{bmatrix} \quad (7)$$

$$\mathbf{Bf} = b \mathbf{\Phi}^T \begin{bmatrix} \cos(\varphi) & \sin(\varphi) & 0 \\ -\sin(\varphi) & \cos(\varphi) & 0 \\ 0 & 0 & 1 \end{bmatrix} \begin{bmatrix} k_t \\ k_r \\ k_a \end{bmatrix} \begin{bmatrix} \sin(\kappa) \sin(\varphi) \\ \sin(\kappa) \cos(\varphi) \\ -\cos(\kappa) \end{bmatrix}^T \mathbf{\Phi}$$

In the same way, the term \mathbf{C}_{01} of equation (6) is expressed as,

$$\mathbf{C}_{01} = \begin{bmatrix} \frac{\tau^2}{2} \\ \tau \end{bmatrix} \mathbf{Cf} \quad (8)$$

$$\mathbf{Cf} = b \mathbf{\Phi}^T \begin{bmatrix} \cos(\varphi) & \sin(\varphi) & 0 \\ -\sin(\varphi) & \cos(\varphi) & 0 \\ 0 & 0 & 1 \end{bmatrix} \begin{bmatrix} k_t \\ k_r \\ k_a \end{bmatrix} \begin{bmatrix} \sin(\kappa) \sin(\varphi) \\ \sin(\kappa) \cos(\varphi) \\ -\cos(\kappa) \end{bmatrix}^T$$

Now, the new displacements of the tool/part will be,

$$\begin{aligned} \hat{\delta}_0 &= \mathbf{\Phi} \mathbf{0} \mathbf{q}_0 = \mathbf{T} \mathbf{q}_0 \\ \hat{\delta}_1 &= \mathbf{\Phi} \mathbf{0} \mathbf{q}_1 = \mathbf{T} \mathbf{q}_1 \end{aligned} \quad (9)$$

Writing down the complete vector for position 0,

$$\hat{\delta}_0 = \mathbf{T} \mathbf{q}_0 = \mathbf{T} \mathbf{A}_{n0} \mathbf{q}_n = \begin{bmatrix} 0 & \dots & 0 & \mathbf{T} \mathbf{A}_{n0} \end{bmatrix} \begin{Bmatrix} \hat{\delta}_0 \\ \vdots \\ \hat{\delta}_{n-1} \\ \mathbf{q}_n \end{Bmatrix} \quad (10)$$

$$\mathbf{q}_0 = \mathbf{A}_{n0} \mathbf{q}_n$$

And for position 1,

$$\mathbf{q}_1 = \mathbf{A}_{01} \begin{Bmatrix} \mathbf{q}_0 \\ \dot{\mathbf{q}}_0 \end{Bmatrix} - \mathbf{B}_{01} \mathbf{q}_0 + \mathbf{C}_{01} \delta_0 = \mathbf{D}_{01} \mathbf{A}_{n0} \mathbf{q}_n + \mathbf{C}_{01} \delta_0 \quad (11)$$

$$\begin{Bmatrix} \hat{\delta}_0 \\ \hat{\delta}_1 \end{Bmatrix} = \begin{bmatrix} 0 & 0 & 0 & \mathbf{T} \mathbf{A}_{n0} \\ \mathbf{T} \mathbf{C}_{01} & 0 & 0 & \mathbf{T} \mathbf{D}_{01} \mathbf{A}_{n0} \end{bmatrix} \begin{Bmatrix} \hat{\delta}_0 \\ \vdots \\ \hat{\delta}_{n-1} \\ \mathbf{q}_n \end{Bmatrix}$$

The last step consists in determining the state transition matrix Φ over the principal period $T = k \Delta t$. The transition matrix links the last displacement to the first one, δ_k to δ_0 , in the form, $\delta_k = \Phi \cdot \delta_0$.

$$\mathbf{q}_n = \mathbf{A}_{n-1n} \mathbf{q}_{n-1} - \mathbf{B}_{n-1n} \mathbf{q}_{n-1} + \mathbf{C}_{n-1n} \delta_{n-1} = \mathbf{D}_{n-1n} \mathbf{q}_{n-1} + \mathbf{C}_{n-1n} \delta_{n-1} \quad (11)$$

$$\begin{Bmatrix} \hat{\delta}_0 \\ \hat{\delta}_1 \\ \hat{\delta}_2 \\ \hat{\delta}_3 \\ \vdots \\ \hat{\delta}_{n-1} \\ \mathbf{q}_n \end{Bmatrix} = \begin{bmatrix} 0 & 0 & 0 & \dots & 0 & \mathbf{T} \mathbf{A}_{n0} \\ \mathbf{T} \mathbf{C} & 0 & 0 & \dots & 0 & \mathbf{T} \mathbf{D} \mathbf{A}_{n0} \\ \mathbf{T} \mathbf{D} \mathbf{C} & \mathbf{T} \mathbf{C} & 0 & \dots & 0 & \mathbf{T} \mathbf{D} \mathbf{D} \mathbf{A}_{n0} \\ \mathbf{T} \mathbf{D} \mathbf{D} \mathbf{C} & \mathbf{T} \mathbf{D} \mathbf{C} & \mathbf{T} \mathbf{C} & \dots & 0 & \mathbf{T} \mathbf{D} \mathbf{D} \mathbf{D} \mathbf{A}_{n0} \\ \vdots & \vdots & \vdots & \ddots & \vdots & \vdots \\ \mathbf{T} \mathbf{D}^{n-2} \mathbf{C} & \mathbf{T} \mathbf{D}^{n-3} \mathbf{C} & \mathbf{T} \mathbf{D}^{n-4} \mathbf{C} & \dots & \mathbf{T} \mathbf{C} & \mathbf{T} \mathbf{D}^{n-1} \mathbf{A}_{n0} \\ \mathbf{D}^{n-1} \mathbf{C} & \mathbf{D}^{n-2} \mathbf{C} & \mathbf{D}^{n-3} \mathbf{C} & \dots & \mathbf{C} & \mathbf{D}^n \mathbf{A}_{n0} \end{bmatrix} \begin{Bmatrix} \delta_0 \\ \delta_1 \\ \delta_2 \\ \delta_3 \\ \vdots \\ \delta_{n-1} \\ \mathbf{q}_n \end{Bmatrix}$$

The stability analysis of the system reduces to obtain the eigenvalue of maximum amplitude of the transition matrix (12). If any eigenvalue has a magnitude larger than 1, then the system is unstable, whereas when all magnitudes are lower than 1 the system is stable.

5.2 Development for different continuous spindle speed variation waveforms

The sinusoidal spindle speed variation method consists in adding a sinusoidal component to the constant spindle speed according to equation (13). For constant speed machining the time delay τ takes a constant value, but for variable speed cutting this time lag is time dependent: $\tau = \tau(t)$. Calling Ω the instantaneous speed, a sinusoidal speed variation can be represented by,

$$\Omega = \Omega_0 + \Delta \sin(\gamma t) \quad (5)$$

where Ω_0 represents the average speed, Δ is the maximum speed variation, and γ is the speed variation frequency.

The adaptation of Semidiscretization to continuous spindle speed variation is straightforward, with the condition that the period of the speed variation is an integer multiple of the tooth pass period: It suffices to calculate the transition matrix over the speed variation period, that is, an integer number of tooth pass periods. Again, the magnitude of the eigenvalues of this matrix will define the stability of the system.

Another speed variation law can be considered to analyse CSSV strategy to eliminate chatter: trapezoidal waveform. This law permits obtaining particular cases like triangular and square variations, but also many more possibilities. In this paper only sinusoidal and triangular variation are considered, although other variation laws can be analysed in the same way.

6 OPTIMIZATION OF SSV PARAMETERS

In fact, if an operator dials the speed override knob back and forth, chatter sometimes vanishes. But not all kind of variations permit avoiding chatter. The effectiveness of the spindle speed variation method depends on the forcing input signal, and on its parameters (amplitude and

frequency). Continuous Spindle Speed Variation can be considered as a way of avoiding chatter vibration when chip load is too large and cutting velocity corresponds to a high order lobe. In this case it is more interesting to optimise speed variation parameters rather than using lobe diagrams for selecting an optimal constant speed. Figure 2 shows the limit depth of cut for different frequencies and amplitudes of the sinusoidal speed variation at the speed 525 r/min. The figure has been obtained by the analysis in the frequency domain [24]. Considering a plane (in yellow) at 4mm axial depth of cut that sections the map of limit depth of cut, an excellent view of unstable areas (in dark blue) below the yellow plane could be obtained.

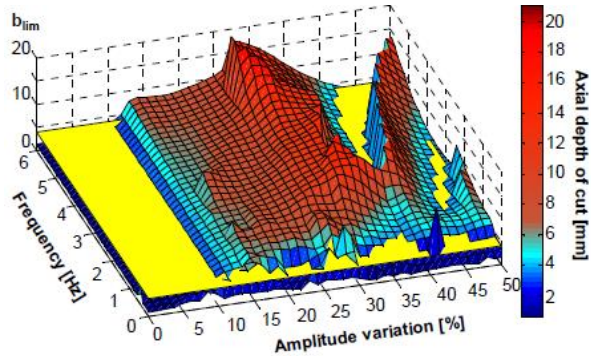

Figure 2: Map of limit depth of cut for sinusoidal spindle speed variation.

Semidiscretization calculates a stability level for each depth of cut. In order to obtain a map similar to the one shown in Figure 2, Semidiscretization simulation would require to evaluate a very large amount of levels along axial depth of cut. This is not a practical approach due to the large time of computation required. Therefore, a new approach is proposed: representation of the stability level for different frequencies and amplitudes of the SSV at a defined axial depth of cut. The stability level is defined by the magnitude of the maximum eigenvalue for the whole transition matrix. Figure 3 shows inverted eigenvalues to permit an easier comparison with the map of depth of cut in Figure 2. Considering that the stability limit is denoted by the unit ($\lambda=1$), a plane (in yellow) will divide up stable areas (in red) from unstable areas (in dark blue).

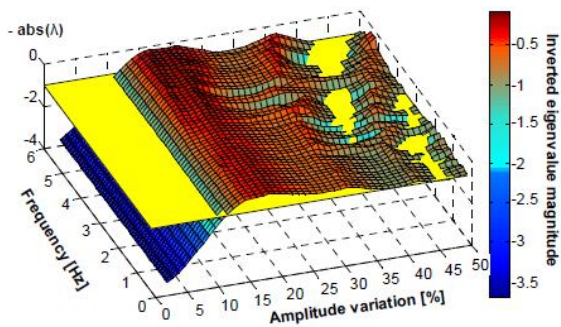

Figure 3: Semidiscretization map of the degree of stability for sinusoidal speed variation.

Comparing figures 2 and 3 it can be deduced that both of them give very similar information. The system becomes stable from amplitude variations of 10%. In addition, some unstable areas appear for amplitude variations from 40% to 50%.

It becomes clear that speed variation ratio is a more influent parameter than frequency. As a general rule, stability grows with the amplitude of speed variation,

although there are some areas of local optimum solutions. In this particular example, optimum values of speed variation ratio are at 15% and 30%. In the practice, 30% variation should already be considered too large, and also it should be analysed whether the spindle is able to get the acceleration required.

Figure 4 shows the limit depth of cut for different frequencies and amplitudes of the triangular speed variation at the speed 525 r/min. The figure has been obtained by the analysis in the frequency domain [24]. Again, a yellow plane at 4mm axial depth of cut sections the map, offering a better view of unstable areas (in dark blue) below the yellow plane.

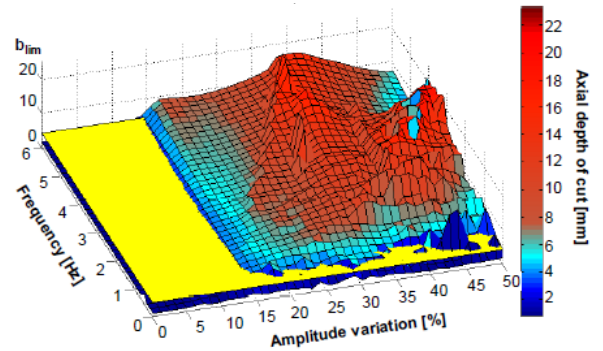

Figure 4: Map of limit depth of cut for triangular spindle speed variation.

As explained before for the sinusoidal variation, Figure 5 shows Semidiscretization map of the degree of stability for triangular speed variation. It can be appreciate that the process becomes stable for amplitude variations larger than 15%, and, opposite to Figure 3, no unstable areas appear at higher amplitude and frequencies. From these graphs it is possible to select variation parameters that are adequate for the cutting conditions required.

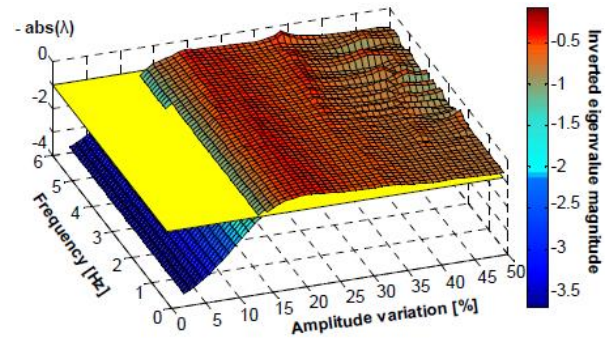

Figure 4: Semidiscretization map of the degree of stability for triangular speed variation.

A consequence obtained from comparing Figure 3 and Figure 5 is that sinusoidal speed variation is more performing than triangular speed variation, as stable area is obtained with lower amplitude and frequency variations, at least for small amplitude variations.

7 EVOLUTION OF STABILITY

A system that varies with time can be stable globally while being unstable at some portion of the time. The requirement is that any vibration growth in the unstable period is damped out during the stable part of the cycle. This phenomenon was presented by Zatarain et al. [24] and can be analysed by the method of Semidiscretization. As explained in section 5, this method produces a transition matrix, whose eigenvalues define the stability of

the system. This matrix is computed along several tooth pass periods, up to reaching the speed variation period. The evolution of this matrix can be used to analyse the progression of stability during the speed variation cycle, which means, that it is possible to analyse the evolution of the amplitude of the eigenvalues at different moments of the cycle.

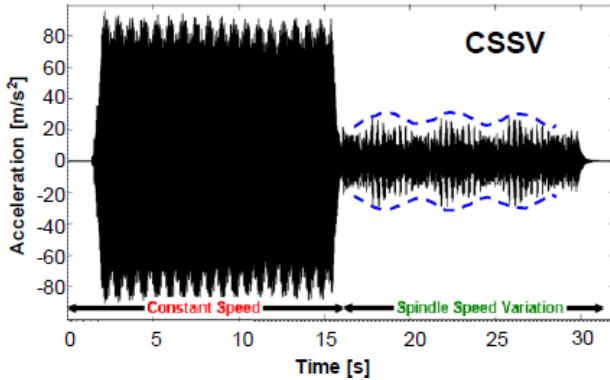

Figure 7: Experimental results with 15% variation at 3Hz.

Whenever the speed variation period is not an exact multiple of the tooth pass period, the analysis should be done on a longer time, a time that is an exact multiple of both the speed variation period and the tooth pass period. This can produce a beating with this new, longer period. Figure 6 shows this effect, obtained with a velocity variation frequency of 3 Hz and spindle velocity 525 r/min. Tooth pass period is 0.0381s, while velocity change period is 0.333s, producing a repetition period of 1.333 seconds ($= 4 \times 0.333 = 35 \times 0.0381$).

8 COMPARISON WITH EXPERIMENTAL RESULTS

The industrial implementation of the CSSV method inside the kernel of the SORALUCE SV6000 milling machine working with a Sinumerik 840D CNC was presented in [28,29]. The experimental results are shown in Figure 6, where the severity of the vibration is measured instead of the amplitude of the chatter peak in the spectrum. The reason is that the measurement of chatter peak could lead to a mistaken conclusion, since the CSSV excites more frequencies than the normal machining but with less energy. Experience has shown that the overall vibration measured over a fixed range (i.e. 2 to 500 Hz) gives the best indication of vibration level. A probable explanation is that a given velocity level corresponds to a given energy level, so that vibration at low and high frequencies are equally weighted from a vibration energy point of view.

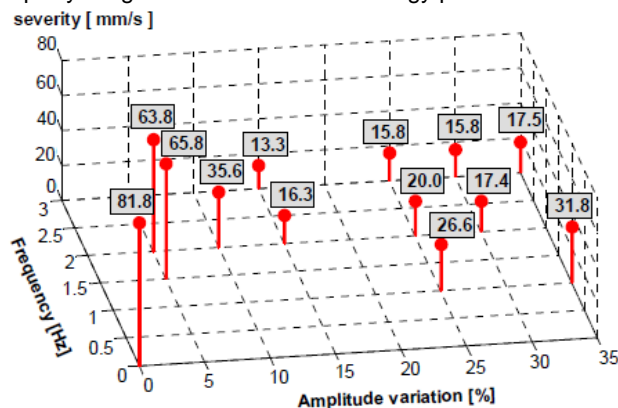

Figure 8: Vibration severity obtained in experimental tests.

Figure 8 represents the vibration severity level for each amplitude and frequency of the CSSV. It is evident that for variation amplitudes larger than 10%, the vibration level is highly reduced. The same conclusion could be obtained from the Semidiscretization map – Figure 3- and frequency domain map – Figure 2-. It is remarkable that there is an optimum area of vibration reduction in the range of 15% amplitude variation of spindle speed, as was foreseen by the results of frequency domain analysis shown in Figure 2, and the Semidiscretization map in Figure 3. Although, the further improvement of behavior at higher speed variation amplitudes foreseen in Figure 2 and Figure 3 were not found in experimental results, the general tendency agrees.

9 CONCLUSIONS

Continuous Spindle Speed Variation is a successful technique to reduce the vibration level in milling when the system is unstable. It is an appropriate strategy at a high order lobe. And although certain vibration level might be maintained, the surface quality obtained at the work part is improved.

Modelling milling processes with CSSV with the Semidiscretization method gives a good orientation on the optimum parameters of the speed variation. For that, a new chart representing the degree of stability for a range of amplitude and frequency of speed variation is proposed. In the simulations done so far, sinusoidal variation shows to be more performing than triangular variation.

In addition, Semidiscretization method has been extended to n -mode systems in any spatial directions.

10 ACKNOWLEDGMENTS

The authors gratefully appreciate the help provided by Mr. Gorka Arrate, Mr. Ruben Merino and Mr. Juan Pablo Rodriguez for their contributions in the machining tests.

11 REFERENCES

- [1] Tobias, S.A., Fiswick, W., 1958, Theory of Regenerative Machine Tool Chatter, Engineering, London, 258.
- [2] Tlustý, J., Poláček, M., 1957, Beispiele der Behandlung der selbsterregten Schwingung der Werkzeugmaschinen FoKoMa, Hanser Verlag, München.
- [3] Altintas, Y., Budak, E., 1995, Analytical Prediction of Stability Lobes in Milling, Annals of the CIRP, 44/1:357-362.
- [4] Muñoa, J., Zatarain, M., Bediaga, I., Peigne, G. 2006, Stability study of the milling process using an exponential forced model in frequency domain, CIRP-2nd International HPC Conference, Vancouver, Canada.
- [5] Budak, E., Altintas, Y., 1998, Analytical Prediction of Chatter Stability Conditions for Multidegree of Freedom Systems in Milling. Part I: General Formulation, Part II: Application of the General formulation to Common Milling Systems”, Transactions of the ASME, 120:22-36.
- [6] Zatarain, M., Munoa, J., Villasante, C., Sedano, A., 2004, Estudio comparativo de los modelos matemáticos de chatter en fresado: monofrecuencia, multifrecuencia y simulación en el tiempo, XV Congreso de Máquinas-Herramienta y Tecnologías de Fabricación, 179-192.

- [7] Davies, M., Pratt, J.R., Dutterer, B.S., Burns, T.J., 2000, The stability of low radial immersion milling, *Annals of the CIRP*, 49/1:37-40.
- [8] Insperger, T., Stépán, G., 2000, Stability of High Speed Milling, *Proceedings of the 2000 ASME International Engineering Congress and Exposition*, Orlando, Florida, AMD – 241:119-123.
- [9] Bayly, P.V., Halley, J.E., Mann, B.P., Davies, M.A., 2003, Stability of Interrupted Cutting by Temporal Finite Element Analysis, *Journal of Manufacturing Science and Engineering*, 125:220-225.
- [10] Merdol, S.D., Altintas, Y., 2004, Multi Frequency Solution of Chatter Stability for Low Immersion Milling, *Journal of Manufacturing Science and Engineering*, 126:459-466.
- [11] Slavicek, J., 1965, The Effect of Irregular Tooth Pitch on Stability of Milling, *Proceedings of the 6th MTDR Conference*, Pergamon Press, London, 15-22.
- [12] Stone, B.J. 1970, The effect on the chatter behaviour of machine tools of cutters with different helix angles on adjacent teeth" *Proc. M.T.D.R.*
- [13] Altintas, Y., Engin, S, Budak, E., 1999, Analytical Stability Prediction and Design of Variable Pitch Cutters, *Trans. ASME Journal of Manufacturing Science and Engineering*, 121:173-178.
- [14] Budak, E., 2000, Improvement of Productivity and Part Quality in Milling of Titanium Based Impellers by Chatter Suppression and Force Control, *Annals of the CIRP*, 49/1:31-36.
- [15] Stone, B.J., 1985, The effect of time varying parameters on the built-up of chatter in turning, *Annals of the CIRP*, 31/1, pp. 371-374.
- [16] Inamura, T., Sata, T., 1974, Stability analysis of cutting under varying spindle speed, *Annals of the CIRP*, 23/1:119-120.
- [17] Takemura, T., Kitamura, T., Hoshi, T., Okushimo, K., 1974, Active suppression of chatter by programmed variation of spindle speed. *Annals of the CIRP*, 23/1:121-122.
- [18] Sexton, J.S., Stone, B.J., 1978, The Stability of machining with continuously varying spindle speed, *Annals of the CIRP*, 27/1:312-326.
- [19] De Canniere, J., van Brussel, H., van Bogaert, J., 1981, A contribution to the mathematical analysis of variable spindle speed machining, *Appl. Math. Modelling*, 5:158-164.
- [20] Altintas, Y., Chan, P.K., 1992, In-process detection and suppression of chatter in milling, *International Journal of Machine Tools and Manufacture*, 32/3:329-347.
- [21] Tsao, T.C., McCarthy, M.W., Kapoor, S.G., 1993, A new approach to stability analysis of variable speed machining systems, *International Journal of Machine Tools and Manufacture*, 33/6:791-808.
- [22] Jayaram, S., Kapoor, S., DeVor, R., 2000, Analytical stability analysis of variable spindle speed machining, *Trans. ASME Journal of Manufacturing Science and Engineering*, 122:391-397.
- [23] Sastry, S., Kapoor, S.G., DeVor, R.E., 2002, Floquet theory based approach for stability analysis of the variable speed face-milling process, *Trans. ASME J. of Manufacturing Science Eng.*,124:10-17.
- [24] Zatarain, M., Bediaga, I., Muñoa, J., Lizarralde, R., 2008, Stability of Milling Processes with Continuous Spindle Speed Variation: Analysis in the Frequency and Time Domains, and Experimental Correlation, accepted in *Annals of the CIRP*.
- [25] Insperger, T., Schmitz, T., Burns, T.J., Stépán, G., 2003, Comparison of analytical and numerical simulations for variable spindle speed turning. *Proc. of IMECE'03 Int. Mechanical Engineering Congress*.
- [26] Insperger, T., Stépán, G., 2001, Semi-discretization of delayed dynamical systems, *Proceedings of the ASME 2001 Design Engineering Technical Conferences, Pittsburgh, Pennsylvania*, paper no. DECT2001/VIB-21446.
- [27] Insperger, T., 2002, Stability analysis of periodic delay-differential equations modelling machine tool chatter, PhD dissertation, University of Budapest, Hungary.
- [28] Bediaga, I., Egaña, I., Muñoa, J., 2006, Reducción de la inestabilidad en cortes interrumpidos en fresado a alta velocidad mediante variación de la velocidad del husillo, XVI Congreso de Máquinas-Herramienta y Tecnologías de Fabricación.
- [29] Bediaga, I., Egaña, I., Muñoa, J., Zatarain, M., López de Lacalle, L. N., 2007, Chatter Avoidance Method for Milling Process based on Sinusoidal Spindle Speed Variation Method: Simulation and Experimental Results, 10th, CIRP International Workshop on Modeling of Machining Operations, Reggio Calabria, Italy.