

Appendix to A Black-box Identification Method for Automated Discrete Event Systems

I. ADDITIONAL EXAMPLES

Additional examples of application of the method that obtains (G^{obs}, M_0) are included. The tests were performed using the following procedure. The net is built using the Platform Independent Petri net Editor (PIPE) [1], which is an editor for visualization and analysis of Petri nets. Through the tool, we have generated a transition sequence, and then the method is applied.

Example A.1. The aim of this example is to illustrate the corrections steps of the technique. Consider the net in Fig. A.1; through PIPE, we have generated a transition sequence of length 1000 by firing randomly transitions of the net : $S = t_9 t_{11} t_1 t_4 t_{10} t_9 t_6 t_1 t_2 t_{12} t_5 t_6 t_{12} t_8 t_{11} t_{10} t_9 t_6 t_{10} t_{12} t_8 t_{11} t_9 t_{10} t_{11} t_9 t_{10} t_{11} t_9 t_{11} t_{10} t_9 t_6 t_{12} t_{10} t_5 t_{11} t_9 t_1 t_4 t_1 t_6 t_2 t_1 t_2 t_5 t_1 t_2 t_{10} t_6 t_{12} t_8 t_{11} t_9 t_{10} t_{11} t_9 t_{10} t_{11} t_9 t_{10} t_{11} t_9 t_1 t_4 t_{11} t_{10} t_9 t_{11} t_{10} t_9 t_{11} t_1 t_4 t_{10} t_9 t_1 t_{11} t_2 t_1 t_2 t_1 t_2 t_1 t_2 t_{10} t_9 t_6 t_1 t_{12} t_2 t_{10} t_8 t_{11} t_9 t_{11} t_{10} t_9 t_{10} t_6 t_{12} t_8 t_{11} t_9 t_6 t_1 t_2 t_{10} t_{12} t_5 t_{11} t_9 t_{11} t_{10} t_9 t_6 t_{10} t_{12} t_5 t_{11} t_9 t_6 t_1 t_2 t_1 t_2 t_{12} t_1 t_5 t_6 t_2 t_1 t_4 t_{10} t_{12} t_8 t_{11} t_9 t_1 t_4 t_{10} t_6 t_{12} t_5 t_{11} t_9 t_{10} t_{11} t_9 t_{10} t_6 \dots$

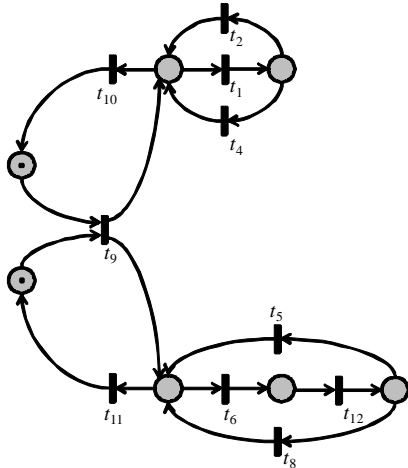

Fig. A.1. A test IPN with non-observable places

From such a sequence, the following data has been computed:

$SP(t_{11}) = \{t_{11}, t_9\}$, $SP(t_{10}) = \{t_{10}, t_9\}$, $SP(t_9) = \{t_9, t_{11}, t_{10}\}$, $SP(t_8) = \{t_8, t_6, t_{12}\}$, $SP(t_6) = \{t_6, t_{12}\}$, $SP(t_5) = \{t_5, t_6, t_{12}\}$, $SP(t_4) = \{t_4, t_1\}$, $SP(t_2) = \{t_2, t_1\}$, $SP(t_1) = \{t_1\}$, $SP(t_{12}) = \{t_{12}, t_6\}$.

$Occ(t_{11})=127$, $Occ(t_{10})=128$, $Occ(t_9)=128$, $Occ(t_8)=60$,
 $Occ(t_6)=123$, $Occ(t_5)=63$, $Occ(t_4)=55$, $Occ(t_2)=69$,
 $Occ(t_1)=124$, $Occ(t_{12})=123$

$Seq = \{(t_9, t_{11}), (t_{11}, t_1), (t_1, t_4), (t_4, t_{10}), (t_{10}, t_9), (t_9, t_6), (t_6, t_1), (t_1, t_2), (t_2, t_{12}), (t_{12}, t_5), (t_5, t_6), (t_6, t_{12}), (t_{12}, t_8), (t_8, t_{11}), (t_{11}, t_{10}), (t_6, t_{10}), (t_{10}, t_{12}), (t_{11}, t_9), (t_9, t_{10}), (t_{10}, t_{11}), (t_{12}, t_{10}), (t_{10}, t_5), (t_5, t_{11}), (t_9, t_1), (t_4, t_1), (t_1, t_6), (t_6, t_2), (t_5, t_1), (t_2, t_{10}), (t_{10}, t_6), (t_4, t_{11}), (t_1, t_{11}), (t_{11}, t_2),$

$(t_2, t_1), (t_1, t_{12}), (t_{12}, t_2), (t_{10}, t_8), (t_{12}, t_1), (t_1, t_5), (t_6, t_4), (t_8, t_6), (t_2, t_6), (t_{12}, t_4), (t_{11}, t_4), (t_1, t_8), (t_8, t_2), (t_2, t_8), (t_4, t_{12}), (t_2, t_{11}), (t_8, t_4), (t_4, t_6), (t_8, t_{10}), (t_2, t_5), (t_5, t_{10}), (t_8, t_1)\}$

Concurrences:

$ConcR = \{(t_2, t_{12}), (t_{11}, t_{10}), (t_6, t_{10}), (t_{10}, t_{12}), (t_{10}, t_5), (t_6, t_2), (t_4, t_{11}), (t_{11}, t_2), (t_{10}, t_8), (t_6, t_4), (t_{12}, t_4), (t_8, t_2), (t_1, t_{11}), (t_1, t_6), (t_1, t_{12})\}$.

After the creation of the net, the following places have been considered: $p_{11}: [t_{11}, t_9]$, $p_{10}: [t_{10}, t_9]$, $p_9: [t_8, t_5, t_1]$, $p_8: [t_1, t_8, t_5]$, $p_7: [t_{12}, t_8, t_5]$, $p_6: [t_8, t_4]$, $p_5: [t_6, t_{12}]$, $p_4: [t_9, t_8, t_5, t_6, t_{11}]$, $p_3: [t_2, t_5]$, $p_2: [t_9, t_4, t_2, t_{10}, t_1]$, and $p_1: [t_1, t_4, t_2]$.

Observe that $t_2 < t_5$ has been observed, but $t_5 < t_2$ has not been observed; this leads to the creation of the place $p_3: [t_2, t_5]$. However, when the previously described verification procedure is applied on p_3 and other places, some corrections have to be made:

- Place $p_{11}: [t_{11}, t_9]$ Correct place
- Place $p_{10}: [t_{10}, t_9]$ Correct place
- Place $p_9: [t_8, t_5, t_1]$ Wrong place: $t_1 \notin SP(t_8)$, $t_1 \notin SP(t_5)$
- Place $p_8: [t_1, t_8, t_5]$ Wrong place: $t_1 \notin SP(t_8)$, $t_1 \notin SP(t_5)$
- Place $p_7: [t_{12}, t_8, t_5]$ Correct place
- Place $p_6: [t_8, t_4]$ Wrong place: $Occ(t_8) \neq Occ(t_4) \pm 1$
- Place $p_5: [t_6, t_{12}]$ Correct place
- Place $p_4: [t_9, t_8, t_5, t_6, t_{11}]$ Correct place
- Place $p_3: [t_2, t_5]$ Wrong place: $Occ(t_2) \neq Occ(t_5) \pm 1$
- Place $p_2: [t_9, t_4, t_2, t_{10}, t_1]$ Correct place
- Place $p_1: [t_1, t_4, t_2]$ Correct place

All places not satisfying the flow equation are deleted. The final set of places is $\{p_{11}: [t_{11}, t_9], p_{10}: [t_{10}, t_9], p_7: [t_{12}, t_8, t_5], p_5: [t_6, t_{12}], p_4: [t_9, t_8, t_5, t_6, t_{11}], p_2: [t_9, t_4, t_2, t_{10}, t_1]$ and $p_1: [t_1, t_4, t_2]\}$, which corresponds in fact to the net in Fig. A.1.

Other representative examples which have been correctly identified are given below.

Example A.2 The identification method applied to the sequence $S = t_4 t_1 t_2 t_3 t_1 t_5 t_6 t_7 t_2 t_3 t_4 t_5 t_6 t_1 t_2 t_3 t_7 t_1 t_4 t_2 t_5 t_4 t_3 t_5 t_1 t_4 t_5 t_2 t_6 t_3 t_1 t_7 t_6 t_7 t_6 t_2 t_3 t_1 t_2 t_3 t_7 t_1 t_4 t_5 t_2 t_4 t_5 t_3 t_4 t_5 t_4 t_5 t_1 t_6 t_7 t_4 t_2 t_3 t_1 t_5 t_6 t_7 t_6 t_2 t_3 t_7 t_4 t_1 t_5 t_2 t_4 t_5 t_6 t_7 t_3 t_1 t_6 t_2 t_7 t_6 t_7 t_6 t_3 t_7 t_4 t_1 t_2 t_3 t_5 t_1 t_4 t_5 t_6 t_7 t_2 t_6 t_3 t_1 t_7 t_4 t_2 t_3 t_5 t_6 t_1 t_2 t_3 t_1 t_7 t_4 t_5 t_6 t_7 t_4 t_2 t_3 t_1 t_5 t_4 t_2 t_5 t_6 t_3 t_7 t_6 t_1 t_7 t_4 t_2 t_3 t_5 t_4 t_5 t_1 t_6 t_2 t_7 t_4 t_5 t_6 t_3 t_7 t_1 t_6 t_7 t_2 t_3 t_1 t_2 t_6 t_7 t_4 t_5 t_4 t_5 t_3 t_4 t_1 t_5 t_4 t_5 t_4 t_5 t_2 t_6 t_3 t_1 t_2 t_3 t_1 t_7 t_2 t_3 t_1 t_4 t_5 t_6 t_2 t_3 t_1 t_2 t_3 t_1 t_2 t_3 t_1 t_7 t_2 t_6 t_7 t_3 t_1 t_2 t_4 t_5 t_4$ yields two different independent *PN* models shown in Fig. A.2.

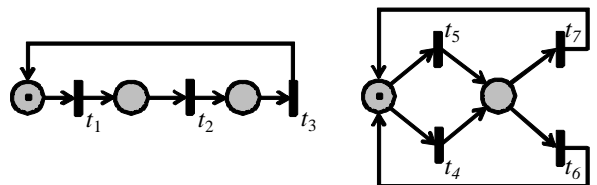

Fig. A.2. Two different components running concurrently

Example A.3 From the sequence $S = t_1 t_2 t_3 t_1 t_4 t_5 t_6 t_7 t_8 t_2 t_3 t_1 t_2 t_4 t_5 t_6 t_3 t_4 t_5 t_1 t_7 t_2 t_8 t_6 t_3 t_4 t_1 t_2 t_5 t_7 t_8 t_6 t_7 t_8 t_3 t_1 t_2 t_4 t_5 t_6 t_3 t_7 t_8 t_1 t_2 t_4 t_5 t_6 t_7 t_3 t_1 t_2 t_4 t_5 t_6 t_7 t_8 t_3 t_4 t_5 t_1 t_2 t_6 t_7 t_3 t_8 t_1 t_2 t_4 t_5 t_6 t_3 t_7 t_8 t_1 t_2 t_4 t_5 t_6 t_7 t_3 t_8 t_4 t_5 t_6 t_1 t_7 t_2 t_3 t_4 t_8 t_1 t_5 t_2 t_6 t_7 t_3 t_1 t_4$, the obtained model is shown in Fig. A.3.

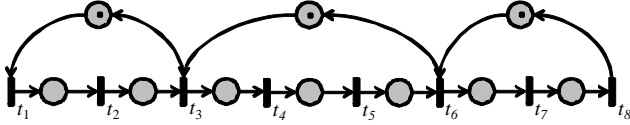

Fig. A.3. Concurrent machines net

Example A.4 Finally, the model in Fig. A.4 is obtained after the treatment of the sequence $S = t_0 t_1 t_2 t_3 t_4 t_5 t_6 t_1 t_2 t_3 t_4 t_5 t_6 t_1 t_2 t_3 t_4 t_5 t_6 t_1 t_2 t_4 t_5 t_3 t_6 t_1 t_2 t_4 t_3 t_5 t_6 t_1 t_2 t_3 t_4 t_5 t_6 t_1 t_2 t_3 t_4 t_5 t_6 t_1 t_2 t_4 t_7$. Notice that there are transitions which fire only once in the sequence (t_0 and t_7).

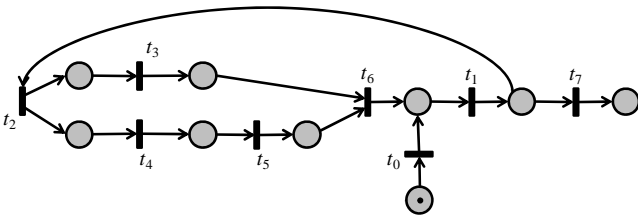

Fig. A.4 A PN with transitions that fire only once in the sequence

II. CASE STUDY

The Mechatronics Standard System (MSS) from Bosch is an assembly machine composed by four stations. The machine treats several gearwheels in order to insert or remove bearings into them. At the end of the treatment, the work pieces are sorted by material into a warehouse. Fig. A.5 shows the MSS installations at LURPA – ENS Cachan.

The controller (a PLC with 57 inputs and 48 outputs) communicates with the plant via Ethernet [2]. The data collection has been made with a routine in Python allowing a computer to acquire the input sequence from the PLC through the Modbus communication protocol. The machine has several operation modes: the bearings can be removed or inserted (or both), and the sorting mode can be by material or by arriving order. For purposes of this work, we have considered that only the fourth station was identified (Fig. A.6), which is in charge of the arrangement and storage of the work pieces; 16 inputs and 6 outputs of the PLC are dedicated to the control of the fourth station.

We have made the data collection with a scenario where the gearwheels have been sorted by material in one of the three available pallets. An I/O sequence of 63,797 vectors has been stored. The index of the inputs and outputs belonging to the fourth station were inserted in the user interface. They correspond to values in Table II and Table III respectively.

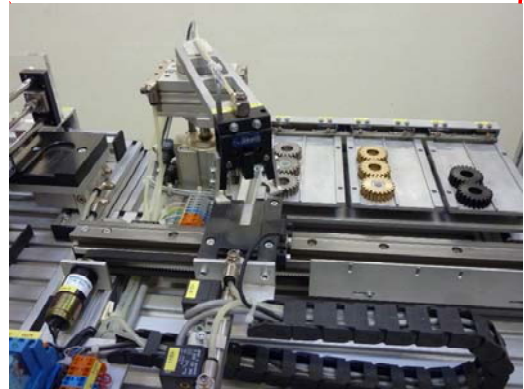
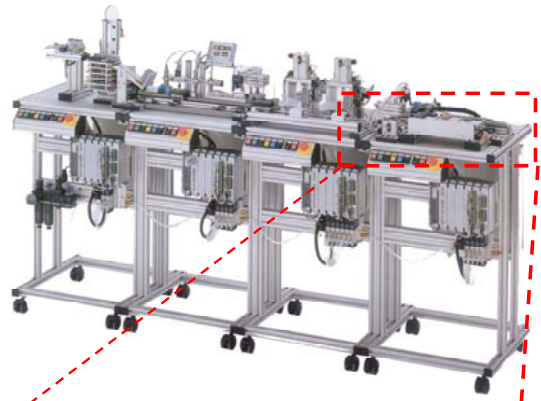

Fig. A.5. Experimental environment of the MSS

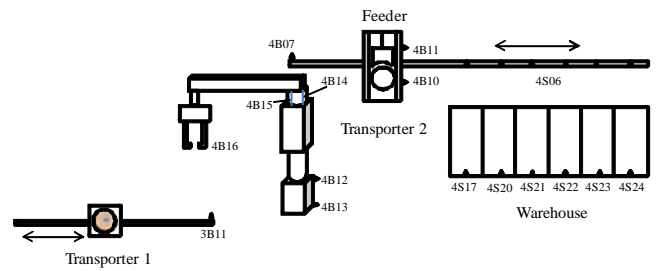

Fig. A.6. Fourth station of the Mechatronics Standard System

TABLE II
INPUTS OF THE MSS 4TH STATION

ID	Input
3B11	Position transporter 1 - right
4S24	Track 6 sensor
4S23	Track 5 sensor
4S22	Track 4 sensor
4S21	Track 3 sensor
4S20	Track 2 sensor
4S17	Track 1 sensor
4B16	Gripper sensor
4B15	Rotary gripper right
4B14	Rotary gripper left
4B13	Rotary gripper bottom
4B12	Rotary gripper top
4B11	Feeder retracted
4B10	Feeder extended
4B07	Transporter 2 store position
4S06	Transporter 2 left position

TABLE III
OUTPUTS OF THE MSS 4TH STATION

ID	Output
4Y11	Rotary gripper - Grip
4Y10	Rotary gripper - Swivel
4Y07	Rotary gripper - Lower
4Y06	Feed cylinder - Extend
4K05	Relay for motor on to the left
4K04	Relay for motor on to the right

By processing the I/O sequence, we have computed direct and indirect matrices in Fig. A.7 and Fig. A.8 respectively.

	4Y11_1	4Y11_0	4Y10_1	4Y10_0	4Y07_1	4Y07_0	4Y06_1	4Y06_0	4K05_1	4K05_0	4K04_1	4K04_0
3B11_1	0.000	0.000	0.000	0.000	0.000	0.000	0.000	0.000	0.000	0.000	0.000	0.000
3B11_0	0.000	0.000	0.000	0.000	0.000	0.000	0.000	0.000	0.000	0.000	0.000	0.000
4S24_1	0.000	0.000	0.000	0.000	0.000	0.000	0.000	0.006	0.000	0.000	0.000	0.000
4S24_0	0.000	0.000	0.000	0.000	0.000	0.000	0.000	0.000	0.000	0.000	0.000	0.000
4S23_1	0.000	0.000	0.000	0.000	0.000	0.000	0.000	0.010	0.000	0.000	0.000	0.000
4S23_0	0.000	0.000	0.000	0.000	0.000	0.000	0.000	0.000	0.000	0.000	0.000	0.000
4S22_1	0.000	0.000	0.000	0.000	0.000	0.000	0.000	0.006	0.000	0.000	0.000	0.000
4S22_0	0.000	0.000	0.000	0.000	0.000	0.000	0.000	0.000	0.000	0.000	0.000	0.000
4S21_1	0.000	0.000	0.000	0.000	0.000	0.000	0.000	0.004	0.000	0.000	0.000	0.000
4S21_0	0.000	0.000	0.000	0.000	0.000	0.000	0.000	0.000	0.000	0.000	0.000	0.000
4S20_1	0.000	0.000	0.000	0.000	0.000	0.000	0.000	0.002	0.000	0.000	0.000	0.000
4S20_0	0.000	0.000	0.000	0.000	0.000	0.000	0.000	0.000	0.000	0.000	0.000	0.000
4S17_1	0.000	0.000	0.000	0.000	0.000	0.000	0.000	0.012	0.000	0.000	0.000	0.000
4S17_0	0.000	0.000	0.000	0.000	0.000	0.000	0.000	0.000	0.000	0.000	0.000	0.000
4B16_1	0.000	0.000	0.000	0.000	0.000	0.000	0.000	0.000	0.000	0.000	0.000	0.000
4B16_0	0.000	0.000	0.000	0.000	0.000	0.000	0.000	0.000	0.000	0.000	0.000	0.000
4B15_1	0.000	0.000	0.000	0.000	0.000	0.000	0.000	0.000	0.000	0.000	0.000	0.000
4B15_0	0.000	0.000	0.000	0.000	0.000	0.000	0.006	0.000	0.000	0.000	0.000	0.077
4B14_1	0.000	0.000	0.000	0.000	0.000	0.000	0.004	0.000	0.000	0.000	0.000	0.023
4B14_0	0.000	0.000	0.000	0.000	0.000	0.000	0.000	0.000	0.000	0.000	0.000	0.000
4B13_1	0.000	0.000	0.000	0.000	0.000	0.000	0.000	0.000	0.000	0.000	0.000	0.000
4B13_0	0.000	0.000	0.000	0.000	0.000	0.000	0.000	0.000	0.000	0.000	0.000	1.000
4B12_1	0.000	0.000	0.000	0.000	0.000	0.000	0.000	0.000	0.000	0.000	0.000	0.000
4B12_0	1.000	1.000	0.000	0.000	0.000	0.000	0.000	0.000	0.000	0.000	0.000	0.000
4B11_1	0.000	0.000	0.000	0.000	0.000	0.000	0.000	0.000	0.000	0.000	1.000	0.000
4B11_0	0.000	0.000	0.000	0.000	0.000	0.000	0.000	0.000	0.000	0.008	0.000	0.000
4B10_1	0.000	0.000	0.000	0.000	0.000	0.000	0.000	0.000	0.000	0.985	0.000	0.000
4B10_0	0.000	0.000	0.000	0.000	0.000	0.000	0.000	0.000	0.000	0.000	0.000	0.000
4B07_1	0.000	0.000	0.000	0.000	0.000	0.000	0.000	0.000	0.000	0.000	0.000	0.000
4B07_0	0.000	0.000	0.000	0.000	0.000	0.000	0.001	0.000	0.000	0.000	0.990	0.000
4S06_1	0.000	0.000	0.000	0.000	0.000	0.002	0.000	0.000	0.000	0.000	0.000	0.000
4S06_0	0.000	0.000	0.000	0.000	0.000	0.000	0.000	0.000	0.000	0.000	0.000	0.085

Fig. A.7. Direct Causality Matrix of the MSS

	4Y11_1	4Y11_0	4Y10_1	4Y10_0	4Y07_1	4Y07_0	4Y06_1	4Y06_0	4K05_1	4K05_0	4K04_1	4K04_0
3B11=1	1.000	0.098	1.000	1.000	1.000	0.549	0.088	0.062	0.044	0.056	0.098	0.088
3B11=0	0.000	0.000	0.902	0.000	0.000	0.451	0.912	0.938	0.956	0.944	0.902	0.912
4S24=0	0.000	0.000	0.000	0.000	0.000	0.000	0.000	0.006	0.000	0.000	0.000	0.000
4S24=0	1.000	1.000	1.000	1.000	1.000	1.000	0.994	1.000	1.000	1.000	1.000	1.000
4S23=1	0.000	0.000	0.000	0.000	0.000	0.000	0.000	0.010	0.000	0.000	0.000	0.000
4S23=0	1.000	1.000	1.000	1.000	1.000	1.000	0.990	1.000	1.000	1.000	1.000	1.000
4S22=1	0.000	0.000	0.000	0.000	0.000	0.000	0.000	0.006	0.000	0.000	0.000	0.000
4S22=0	1.000	1.000	1.000	1.000	1.000	1.000	0.994	1.000	1.000	1.000	1.000	1.000
4S21=1	0.000	0.000	0.000	0.000	0.000	0.000	0.004	0.000	0.000	0.000	0.000	0.000
4S21=0	1.000	1.000	1.000	1.000	1.000	1.000	0.996	1.000	1.000	1.000	1.000	1.000
4S20=1	0.000	0.000	0.000	0.000	0.000	0.000	0.002	0.000	0.000	0.000	0.000	0.000
4S20=0	1.000	1.000	1.000	1.000	1.000	1.000	0.998	1.000	1.000	1.000	1.000	1.000
4S17=1	0.000	0.000	0.000	0.000	0.000	0.000	0.012	0.000	0.000	0.000	0.000	0.000
4S17=0	1.000	1.000	1.000	1.000	1.000	1.000	0.988	1.000	1.000	1.000	1.000	1.000
4B16=1	0.000	1.000	0.000	1.000	0.500	0.500	0.000	0.000	0.000	0.000	0.000	0.000
4B16=0	1.000	0.000	1.000	0.000	0.500	0.500	1.000	1.000	1.000	1.000	1.000	1.000
4B15=1	0.000	1.000	1.000	0.000	0.500	0.500	0.002	0.000	0.000	0.000	1.000	0.008
4B15=0	1.000	0.000	0.000	1.000	0.500	0.500	0.998	1.000	1.000	1.000	0.000	0.992
4B14=1	1.000	0.000	0.000	1.000	0.500	0.500	0.833	1.000	1.000	1.000	0.000	0.829
4B14=0	0.000	1.000	1.000	0.000	0.500	0.500	0.167	0.000	0.000	0.000	1.000	0.171
4B13=1	1.000	1.000	0.000	0.000	1.000	0.000	0.000	0.000	0.000	0.000	0.000	0.000
4B13=0	0.000	0.000	1.000	1.000	1.000	0.000	1.000	1.000	1.000	1.000	1.000	1.000
4B12=1	0.000	0.000	1.000	1.000	1.000	0.000	1.000	1.000	1.000	1.000	1.000	1.000
4B12=0	1.000	1.000	0.000	0.000	0.000	1.000	0.000	0.000	0.000	0.000	0.000	0.000
4B11=1	1.000	1.000	1.000	1.000	1.000	1.000	1.000	0.000	1.000	1.000	1.000	1.000
4B11=0	0.000	0.000	0.000	0.000	0.000	0.000	0.000	1.000	0.000	0.000	0.000	0.000
4B10=1	0.000	0.000	0.000	0.000	0.000	0.000	0.000	1.000	0.000	0.000	0.000	0.000
4B10=0	1.000	1.000	1.000	1.000	1.000	1.000	0.992	0.992	0.000	0.000	1.000	1.000
4B07=1	0.000	0.000	0.000	0.000	0.000	0.000	0.008	0.008	1.000	1.000	0.000	0.000
4B07=0	1.000	1.000	1.000	1.000	1.000	1.000	0.000	0.000	0.000	0.000	1.000	0.000
4S06=1	1.000	1.000	1.000	1.000	0.995	1.000	0.000	0.000	0.000	1.000	1.000	0.000
4S06=0	0.000	0.000	0.000	0.000	0.005	0.000	1.000	1.000	1.000	0.000	0.000	1.000

Fig. A.8. Indirect Causality Matrix of the MSS

Notice that the DM matrix column corresponding to output event 4Y07_1 is zero and thus the computed firing conditions for this output event would be empty. The same occurs for

output events 4Y07_0, 4Y06_1 and 4K05_1: the corresponding DM matrix columns are almost zero and as a consequence they yield to empty firing conditions. This situation is the case specified at subsection IV.F, where instead of considering that the input and output events must occur at the same PLC cycle, we must look at the input events occurring in the previous event vector. We have computed the probability values considering the previous event vector to construct the called One Step Direct Matrix in Fig. A.9.

	4Y11_1	4Y11_0	4Y10_1	4Y10_0	4Y07_1	4Y07_0	4Y06_1	4Y06_0	4K05_1	4K05_0	4K04_1	4K04_0
3B11_1	0.000	0.000	0.000	0.000	0.500	0.000	0.000	0.000	0.000	0.000	0.000	0.000
3B11_0	0.000	0.000	0.000	0.000	0.000	0.451	0.000	0.000	0.000	0.000	0.000	0.000
4S24_1	0.000	0.000	0.000	0.000	0.000	0.000	0.000	0.000	0.000	0.000	0.000	0.000
4S24_0	0.000	0.000	0.000	0.000	0.000	0.000	0.000	0.000	0.000	0.000	0.000	0.000
4S23_1	0.000	0.000	0.000	0.000	0.000	0.000	0.000	0.000	0.000	0.000	0.000	0.000
4S23_0	0.000	0.000	0.000	0.000	0.000	0.000	0.000	0.000	0.000	0.000	0.000	0.000
4S22_1	0.000	0.000	0.000	0.000	0.000	0.000	0.000	0.000	0.000	0.000	0.000	0.000
4S22_0	0.000	0.000	0.000	0.000	0.000	0.000	0.000	0.000	0.000	0.000	0.000	0.000
4S21_1	0.000	0.000	0.000	0.000	0.000	0.000	0.000	0.000	0.000	0.000	0.000	0.000
4S21_0	0.000	0.000	0.000	0.000	0.000	0.000	0.000	0.000	0.000	0.000	0.000	0.000
4S20_1	0.000	0.000	0.000	0.000	0.000	0.000	0.000	0.000	0.000	0.000	0.000	0.000
4S20_0	0.000	0.000	0.000	0.000	0.000	0.000	0.000	0.000	0.000	0.000	0.000	0.000
4S17_1	0.000	0.000	0.000	0.000	0.000	0.000	0.000	0.000	0.000	0.000	0.000	0.000
4S17_0	0.000	0.000	0.000	0.000	0.000	0.000	0.000	0.000	0.000	0.000	0.000	0.000
4B16_1	0.000	0.000	0.000	0.000	0.000	0.500	0.000	0.000	0.000	0.000	0.000	0.000
4B16_0	0.000	0.000	0.000	0.000	0.000	0.049	0.000	0.000	0.000	0.000	0.000	0.000
4B15_1	0.000	0.000	0.000	0.000	0.500	0.000	0.000	0.000	0.000	0.000	0.000	0.000
4B15_0	0.000	0.000	0.000	0.0								

position, it goes down again to depose the gearwheel into another car. Once the piece is released, the gripper goes up again and to the left, to return to its initial position. Meanwhile, the car moves until the storage area. There, the car stops and then a cylinder is pushed until the gearwheel is in the warehouse. Then, the cylinder is completely retracted and then the car goes back to its initial position.

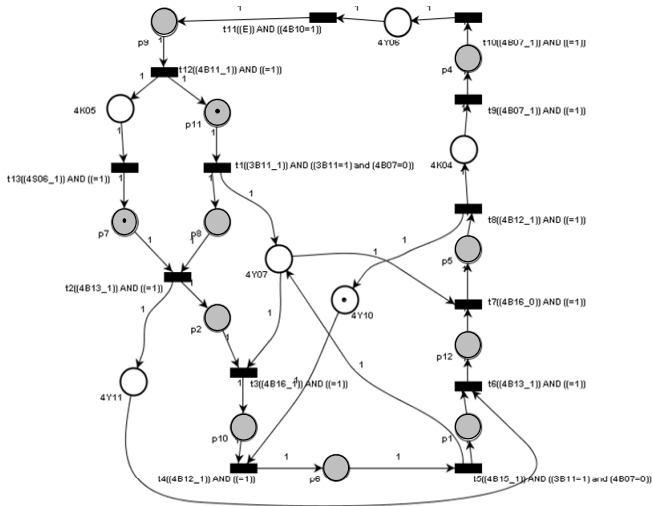

Fig. A.11. Final model for the MSS

Notice how the concurrence between the arriving of a new piece (t1) and the arrangement of the last one (t13) has been captured in the model.

III. REFERENCES

- [1] PIPE 2: Platform Independent Petri net Editor 2, <http://pipe2.sourceforge.net/>
- [2] M. Roth, J.-J. Lesage, and L. Litz, "Identification of Discrete Event Systems, implementation issues and model completeness", in *Proc. 7th Int. Conf. on Informatics in Control Automation and Robotics*, pp. 73–80, Funchal, Portugal, Jun. 2010.