



**HAL**  
open science

## A new species of the suid genus *Kolpochoerus* from Ethiopia

Antoine Souron, Jean-Renaud Boisserie, Tim White

► **To cite this version:**

Antoine Souron, Jean-Renaud Boisserie, Tim White. A new species of the suid genus *Kolpochoerus* from Ethiopia. *Acta Palaeontologica Polonica*, 2015, 60 (1), pp.79-96. 10.4202/app.2012.0083 . hal-01269949

**HAL Id: hal-01269949**

**<https://hal.science/hal-01269949v1>**

Submitted on 15 Jun 2020

**HAL** is a multi-disciplinary open access archive for the deposit and dissemination of scientific research documents, whether they are published or not. The documents may come from teaching and research institutions in France or abroad, or from public or private research centers.

L'archive ouverte pluridisciplinaire **HAL**, est destinée au dépôt et à la diffusion de documents scientifiques de niveau recherche, publiés ou non, émanant des établissements d'enseignement et de recherche français ou étrangers, des laboratoires publics ou privés.

# A new species of the suid genus *Kolpochoerus* from Ethiopia

ANTOINE SOURON, JEAN-RENAUD BOISSERIE, and TIM D. WHITE



Souron, A., Boisserie, J.-R., and White, T.D. 2015. A new species of the suid genus *Kolpochoerus* from Ethiopia. *Acta Palaeontologica Polonica* 60 (1): 79–96.

Although the suid genus *Kolpochoerus* is well known from the Plio-Pleistocene of Africa, the evolutionary history of one of its constituent species, *K. majus*, remained obscure until substantial fossil evidence accumulated during the last 20 years, largely from sites in Ethiopia. Here, we describe *Kolpochoerus phillipi* sp. nov., based on a fairly complete skull and the remains of additional individuals from ~2.5 Ma deposits at Matabaietu, in the Middle Awash study area of Ethiopia. Based on a phylogenetic analysis, we suggest that *K. phillipi* sp. nov. belongs to a clade of “bunolophodont suines” including *K. majus* and the extant giant forest hog *Hylochoerus meinertzhageni*. Within this clade, *K. phillipi* sp. nov. likely represents a potential ancestor of *K. majus*, based on its morphology and stratigraphic position.

**Key words:** Mammalia, Suinae, *Kolpochoerus*, *Hylochoerus*, *Potamochoerus*, Pliocene, Pleistocene, Middle Awash, Ethiopia.

Antoine Souron [antoine.souron@berkeley.edu], Institut de Paléoprimatologie, Paléontologie Humaine: Évolution et Paléoenvironnements (UMR 7262), CNRS & Université de Poitiers, Bât. B 35-6, rue Michel Brunet, 86022 Poitiers Cedex, France and Human Evolution Research Center, The University of California at Berkeley, Berkeley CA 94720 USA. Jean-Renaud Boisserie [jean.renaud.boisserie@univ-poitiers.fr], Institut de Paléoprimatologie, Paléontologie Humaine: Évolution et Paléoenvironnements (UMR 7262), CNRS & Université de Poitiers, Bât. B 35-6, rue Michel Brunet, 86022 Poitiers Cedex, France and Centre Français des Études Éthiopiennes (USR 3137), CNRS & Ministère des Affaires Étrangères, Ambassade de France en Éthiopie, P.O. Box 5554, Addis Ababa, Ethiopia. Tim D. White [timwhite@berkeley.edu], Human Evolution Research Center and Department of Integrative Biology, The University of California at Berkeley, Berkeley CA 94720 USA.

Received 6 August 2012, accepted 21 July 2013, available online 26 July 2013.

Copyright © 2015 A. Souron et al. This is an open-access article distributed under the terms of the Creative Commons Attribution License, which permits unrestricted use, distribution, and reproduction in any medium, provided the original author and source are credited.

## Introduction

In Sub-Saharan Africa, wild pigs (family Suidae) are represented by five extant omnivorous and herbivorous species, which have been the focus of research dealing mostly with biodiversity conservation (Oliver 1993; d’Huart and Yohannes 1995; Randi et al. 2002; Grubb and d’Huart 2010). Although recent molecular studies have shown extant African suids to form a monophyletic group, with *Hylochoerus* and *Phacochoerus* forming a clade to the exclusion of *Potamochoerus* (Gongora et al. 2011), relatively little is known about their origin and evolutionary history, owing to their patchy fossil record and the uncertain taxonomic and phylogenetic status of most of their fossil relatives. *Potamochoerus* in particular has traditionally been used as a wastebasket taxon for many archaic-looking specimens characterized by simple, short, brachyodont and bunodont teeth, resulting in general confusion regarding the antiquity of this genus (White 1995; Bishop 2010). The fossil record of *Hylochoerus* is also very

poor, with the only securely-dated and well-identified fossils coming from Member III of the Kibish Formation, ca. 0.1 Ma (Assefa et al. 2008).

Our current knowledge of the origins and evolution of extant African suids is highly reliant on abundant Plio-Pleistocene fossils. Specifically, *Hylochoerus* has been suggested to descend from the extinct genus *Kolpochoerus* (Harris and White 1979; Geraads 2004), whereas *Potamochoerus* might either be the sister group of *Kolpochoerus* (Cooke 1997; Geraads 2004), or a descendant of the Pliocene *K. afarensis* (White 1995). The genus *Kolpochoerus* itself is most famous for the rich fossil record and biostratigraphic value of its best represented lineage, *K. limnetes/K. olduvaiensis* (Cooke 1978b; Harris and White 1979). Most, but not all, authors recognize the following species: *Kolpochoerus afarensis*, *K. cookei*, *K. deheinzlini*, *K. limnetes* (also called *K. heseloni* following Cooke 1997), *K. majus*, *K. olduvaiensis*, *K. paiceae*, and *K. phacochoeroides* (White and Harris 1977; Cooke and Wilkinson 1978; Harris and White 1979; Hendey and

Cooke 1985; White 1995; Brunet and White 2001; Geraads 2004; Geraads et al. 2004a). In addition, Haile-Selassie and Simpson (2013) recently described *K. millensis*, a putative chronospecies intermediate in morphology and time between *K. deheinzlini* and *K. afarensis*.

Amongst the recognized species of *Kolpochoerus*, *K. afarensis*, the most abundantly represented early member of the genus, is considered the ancestor of the younger *K. limnetes* (White 1995), and it is sometimes assigned to the genus *Potamochoerus* (Cooke 1997; Bishop 2010). *Kolpochoerus olduvaiensis* is a derived chronospecies of *K. limnetes* (Gilbert 2008), and is sometimes included within the latter species (Harris and White 1979). This is also the case for *K. paiceae*, an apparent South African endemic similar to *K. olduvaiensis* (Harris and White 1979). By contrast, *K. phacochoeroides* is endemic to northern Africa (Geraads 1993, 2004), and sometimes interpreted as conspecific with either *K. limnetes* from eastern Africa (e.g., Pickford 1994), or *K. olduvaiensis* (e.g., White 1995).

*Kolpochoerus majus* was first described on the basis of a left mandibular fragment preserving p3–m1 and the alveolus for p2 from Bed IV of Olduvai Gorge (Hopwood 1934), and is characterized by brachyodont, mesiodistally short and simple third molars with a bunolophodont wear pattern resulting from mesiodistally compressed lateral pillars (Leakey 1942, 1958; Harris and White 1979). The species has been reported from various Pleistocene localities dating from ca. 1.9 Ma to ca. 0.5 Ma, including the Daka Member of the Bouri Formation and the Upper Bodo beds (Middle Awash), Member L of the Shungura Formation, the Busidima Formation (Asbole), the Melka Kunturé Formation (Garba IV), and the Konso, Olduvai, Kapthurin, Nachukui, Olorgesailie, and Nyabusosi formations (Hopwood 1934; Leakey 1942; Harris and White 1979; Harris et al. 1988; Pickford 1994; White 1995; Suwa et al. 2003; Geraads et al. 2004a, b). Despite this abundance of sites, the evolutionary history of the *K. majus* lineage has remained largely unknown, owing to a lack of adequate material predating the Pleistocene specimens—although some authors have hypothesized that the species may have evolved from an early form of *K. limnetes* ~2.5 Ma, before the latter acquired a more complex dental morphology (White 1995; Geraads et al. 2004a).

Here, we describe fossil material that is dated around 2.5 Ma and comes from the Matabaietu area in the Middle Awash study area of Ethiopia, and assign them to a new, archaic species of *Kolpochoerus*. The latter displays strong dental similarities to *K. majus*, and may help to shed light on the transition from *K. afarensis* (or from an early *K. limnetes* morph) to *K. majus*.

*Institutional abbreviations.*—ARCCH, Authority for Research and Conservation of Cultural Heritage, Addis Ababa, Ethiopia; KNM, Kenya National Museums, Nairobi, Kenya; MNHN-ZM-AC, Collection Zoologie et Anatomie Comparée, Muséum National d’Histoire Naturelle, Paris, France; MRAC, Muséum Royal d’Afrique Centrale, Tervuren, Belgium; NHMUK, Natural History Museum, London, United Kingdom.

*Other abbreviations.*—A.L., “Afar Locality”, prefix of locality numbers in the Hadar Formation, Ethiopia; ER, “East Rudolf”, prefix of fossil specimens from the Koobi Fora Formation, Kenya; KL, “Kalb Locality”, prefix of locality numbers defined by the RVRME (Rift Valley Research Mission in Ethiopia) in the Middle Awash study area, Ethiopia; L, Omo Shungura Formation, Ethiopia, American locality number; MAT-VP-, Middle Awash vertebrate paleontological locality Matabaietu, Ethiopia; OMO, Omo Shungura Formation, Ethiopia, French locality number; WIL-VP-, Middle Awash vertebrate paleontological locality Wilti Dora, Ethiopia.

## Geological setting

The new material of *Kolpochoerus* described here (Table 1) was recovered by the RVRME (prior to 1980), and subsequently the Middle Awash research project from the area of Matabaietu in the Middle Awash study area, Afar Depression, northern Ethiopia. Sediments in the local catchment range from the middle Pliocene to the Middle Pleistocene, with all of the present material coming from the late Pliocene “W” Formation of the Middle Awash (White et al. 1993), estimated to be roughly equivalent to the Hatayae Member of the Bouri Formation exposed on the western

Table 1. List of the specimens described as belonging to *Kolpochoerus phillipi* sp. nov. from the late Pliocene “W” Formation of the Middle Awash. For the specimens collected by the RVRME, the equivalent localities of the Middle Awash research project are indicated.

Taxon	Specimen ID	Element	Stratigraphic level
<i>Kolpochoerus phillipi</i> sp. nov.	MAT-VP-1/5	skull with dentition	in situ, Unit 9 sandstone
	MAT-VP-5/1	left mandible fragment with p4 to m3	in situ, Unit 4 sandstone
<i>Kolpochoerus</i> cf. <i>phillipi</i> sp. nov.	MAT-VP-5/2	right m3	Unit 4 sandstone
	KL 10-3	left m3 mesial fragment	cf. WIL-VP-2
	KL 24-1 b	left mandible fragment with m3	cf. WIL-VP-2
	KL 39-4	left m3	cf. MAT-VP-2 or 4
	KL 73-1	right mandible fragment with m3	cf. MAT-VP-5
	KL 234-1	right m3	cf. part MAT-VP-3
	KL 234-3-5	left m3	cf. part MAT-VP-3

side of the study area (de Heinzelin et al. 1999). The age of these deposits has been estimated at ~2.5 Ma, based notably on biochronological studies of fossil bovids (Kalb et al. 1982b; Vrba 1997; White et al. 2005; Bibi 2011). However, age assessments of this part of the Middle Awash are still a work in progress.

## Material and methods

We compared our new material to several species of *Kolpochoerus*, as well as specimens of extant African suids (*Potamochoerus* and *Hylochoerus*) held at ARCCH, KNM, MNHN-ZM-AC, MRAC, and NHMUK. Comparisons with the extant taxa in particular allowed us to evaluate the presence of both sexual dimorphism and geographic variation in the fossil record, and assess the effects of the latter on systematics.

Teeth were measured using a digital caliper (precision of 0.1 mm), following Harris and White (1979). To quantify differences in skull morphology, we developed a new measurement protocol (Table 2), adapted in part from the literature (Cooke and Ewer 1972; Driesch 1976). Using a 3D-digitizer (microscribe G2X, Immersion Corporation), each measurement was taken between two anatomical landmarks. Whenever both sides were preserved, measurements were averaged. To estimate the degree of repeatability of our measurements, the latter were performed ten times on two skulls (one of *Hylochoerus* and one of *Potamochoerus*), which resulted in per-measurement standard deviations averaging close to 1%. All data are reported in Tables 3 and 4, as well as the Supplementary Online Material (SOM available at [http://app.pan.pl/SOM/app60-Souron\\_etal\\_SOM.pdf](http://app.pan.pl/SOM/app60-Souron_etal_SOM.pdf)).

In order to determine the phylogenetic position of the new species described here, we performed a parsimony-based phylogenetic analysis in TNT (Goloboff et al. 2008). Our matrix (Appendix 1) included 22 characters (Appendices 1–4), coded for nine taxa. Some of the characters (0, 4, 7, 10–12, 18, and 21) were adopted from Geraads (2004). All characters were defined and coded based on direct observation (no taxa were coded from the literature), taking into account sexual dimorphism, geographic, and temporal variation. We focused our analysis on species of *Kolpochoerus* and two extant genera of African suids, *Potamochoerus* and *Hylochoerus*. Within *Kolpochoerus*, we restrained our analysis to species from eastern Africa for which sufficient complete cranio-mandibular material is available. A recent phylogenetic analysis revealed the Eurasian genus *Sus* to be the sister group of African suids, and *Babyrousa* to be the basalmost taxon within the subfamily Suinae (Gongora et al. 2011). We therefore used *Babyrousa* as outgroup, and included *Sus scrofa* in our analysis. We analyzed our data using an exhaustive search with all characters left unordered and unweighted. Bremer indices were calculated for each node to estimate branch support.

Table 2. Cranio-mandibular measurements used in the paper, based partly on Cooke and Ewer (1972) and Driesch (1976).

Cranium	
C1	length akrokranium-nasoincisive notch
C2	length prosthion-staphylion
C3	length nasoincisive notch-ventral lacrimal foramen
C4	length prosthion-anterior point of upper canine alveolus
C5	width between anterior edges of upper canine alveoli
C6	width between mesial extremities of cheek teeth row
C7	width between distal extremities of M3
C8	greatest width of nasal bone
C9	width zygion-zygion
C10	greatest width between the orbital processes of frontal bone
C11	least width of the parietal roof
C12	width between the supra-canine flanges
C13	medio-lateral diameter of upper canine alveolus
C14	rostrum height at the P4–M1 level
C15	height distal extremity of M3-dorsal edge of orbit
C16	premolar row length (without P1)
C17	molar row length
C18	cheek teeth row length (without P1)
C19	angle between cheek teeth row and premaxillary bone
C20	length of diastema between upper canine and most anterior upper premolars (excluding P1)
Mandible	
M1	length infradentale-posterior extremity of mandibular condyle
M2	length infradentale-distal extremity of m3
M3	length infradentale-posterior extremity of mandibular symphysis
M4	greatest width between labial edges of lower canines
M5	width between mesial extremities of cheek teeth row
M6	width between distal extremities of m3
M7	width of corpus at the m1–m2 level
M8	greatest width of mandible at m1–m2 level
M9	width condylion laterale-condylion laterale
M10	height of mandibular corpus anteriorly to first premolar
M11	height of mandibular corpus at m2–m3 level
M12	height ventral point of mandibular corpus at distal extremity of m3 level-condylion superior
M13	length diastem canine-cheek teeth row
M14	premolar row length
M15	molar row length
M16	cheek teeth row length
M17	mesio-distal diameter of lower canine alveolus
M18	medio-lateral diameter of lower canine alveolus
M19	angle between the line joining the anterior edges of the lower canine alveoli and the line joining the anterior edge of canine alveolus to the infradentale
M20	width of mandible between lingual faces of p4

Table 3. Cranium measurements of the holotype skull of *Kolpochoerus phillipi* sp. nov. (MAT-VP-1/5) compared to various suids. Measurements to nearest mm. Measurements are displayed as follows: mean  $\pm$  SD (n) (min; max); e, estimate.

	<i>Kolpochoerus phillipi</i> sp. nov.	<i>Hylochoerus</i>	<i>Potamochoerus</i>	<i>Kolpochoerus afarensis</i>	<i>Kolpochoerus limnetes</i> / <i>K. olduvaiensis</i>	<i>Kolpochoerus majus</i>
C1	379 e	345 $\pm$ 28 (36) (286; 390)	319 $\pm$ 18 (60) (278; 359)	–	462 $\pm$ 43 (10) (402; 517)	370 $\pm$ 11 (3) (360; 382)
C2	265	254 $\pm$ 20 (36) (217; 288)	228 $\pm$ 13 (63) (203; 254)	–	333 $\pm$ 30 (7) (296; 368)	268 $\pm$ 25 (8) (234; 316)
C3	230	213 $\pm$ 20 (36) (175; 246)	192 $\pm$ 13 (63) (164; 221)	–	289 $\pm$ 33 (12) (236; 334)	235 $\pm$ 28 (7) (191; 281)
C4	68	77 $\pm$ 8 (37) (61; 96)	67 $\pm$ 4 (64) (56; 75)	–	89 $\pm$ 9 (8) (74; 101)	84 $\pm$ 14 (8) (70; 113)
C5	64	66 $\pm$ 10 (37) (48; 88)	49 $\pm$ 5 (64) (40; 69)	–	89 $\pm$ 18 (16) (66; 137)	79 $\pm$ 6 (6) (72; 86)
C6	60	63 $\pm$ 6 (35) (51; 72)	45 $\pm$ 4 (64) (39; 53)	–	66 $\pm$ 8 (12) (53; 81)	80 $\pm$ 5 (10) (73; 87)
C7	53	57 $\pm$ 5 (36) (46; 67)	44 $\pm$ 3 (62) (38; 51)	48 $\pm$ 10 (3) (40; 59)	57 $\pm$ 9 (30) (42; 86)	54 $\pm$ 5 (13) (50; 64)
C8	59	47 $\pm$ 4 (37) (38; 55)	52 $\pm$ 11 (61) (30; 80)	–	58 $\pm$ 10 (25) (33; 73)	48 $\pm$ 8 (8) (38; 61)
C9	238 e	208 $\pm$ 27 (36) (160; 264)	169 $\pm$ 13 (61) (142; 196)	207 $\pm$ 18 (2) (194; 220)	304 $\pm$ 41 (14) (225; 369)	265 $\pm$ 53 (7) (220; 376)
C10	122 e	124 $\pm$ 11 (36) (101; 144)	104 $\pm$ 8 (60) (89; 123)	117 $\pm$ 31 (2) (95; 139)	134 $\pm$ 13 (10) (120; 156)	116 $\pm$ 7 (3) (110; 123)
C11	56	89 $\pm$ 10 (36) (72; 107)	37 $\pm$ 11 (60) (14; 61)	44 $\pm$ 19 (2) (31; 57)	54 $\pm$ 12 (13) (39; 71)	65 $\pm$ 8 (4) (59; 75)
C12	125	102 $\pm$ 14 (37) (77; 134)	82 $\pm$ 15 (60) (56; 113)	62	131 $\pm$ 24 (22) (73; 172)	114 $\pm$ 18 (10) (90; 145)
C13	41	36 $\pm$ 7 (35) (23; 51)	33 $\pm$ 8 (53) (14; 48)	11	55 $\pm$ 19 (19) (18; 94)	38 $\pm$ 11 (9) (25; 61)
C14	77	70 $\pm$ 7 (37) (57; 85)	66 $\pm$ 7 (61) (53; 80)	72 $\pm$ 20 (3) (51; 89)	74 $\pm$ 10 (26) (52; 105)	89 $\pm$ 15 (10) (71; 117)
C15	151	119 $\pm$ 9 (36) (100; 137)	104 $\pm$ 6 (62) (90; 116)	144 $\pm$ 14 (2) (135; 154)	166 $\pm$ 18 (18) (138; 213)	152 $\pm$ 11 (5) (145; 171)
C16	39	22 $\pm$ 6 (36) (7; 34)	39 $\pm$ 2 (64) (32; 44)	40 $\pm$ 1 (2) (39; 40)	42 $\pm$ 4 (24) (33; 49)	45 $\pm$ 5 (14) (37; 54)
C17	79	80 $\pm$ 5 (36) (67; 92)	69 $\pm$ 3 (64) (60; 76)	78 $\pm$ 4 (3) (75; 83)	97 $\pm$ 8 (29) (86; 119)	88 $\pm$ 9 (14) (77; 111)
C18	117	102 $\pm$ 7 (36) (87; 113)	106 $\pm$ 5 (64) (95; 117)	114 $\pm$ 1 (2) (114; 115)	136 $\pm$ 8 (22) (128; 162)	131 $\pm$ 11 (11) (113; 149)
C19	147	153 $\pm$ 5 (37) (143; 160)	158 $\pm$ 3 (63) (143; 163)	–	145 $\pm$ 5 (8) (140; 156)	146 $\pm$ 6 (8) (137; 158)
C20	33	40 $\pm$ 8 (37) (25; 64)	18 $\pm$ 5 (64) (8; 30)	14	42 $\pm$ 11 (20) (16; 58)	29 $\pm$ 6 (10) (21; 36)

## Systematic paleontology

Class Mammalia Linnaeus, 1758

Order Cetartiodactyla Montgelard, Catzeflis, and Douzery, 1997

Family Suidae Gray, 1821

Subfamily Suinae Gray, 1821

Genus *Kolpochoerus* van Hoepen and van Hoepen, 1932

*Type species*: *Kolpochoerus sinuosus* van Hoepen and van Hoepen, 1932. Holotype specimen from the Pleistocene of Uitzoek, near Cornelia, South Africa.

*Kolpochoerus phillipi* sp. nov.

Figs. 1–3.

*Etymology*: Named in honor of the late and great South African paleo-anthropologist Phillip V. Tobias for his support of the Middle Awash research project, and in recognition of his work on African fossil hominids never losing sight of the importance of associated vertebrate faunas and their environmental context (White 2012).

*Type material*: Holotype: MAT-VP-1/5 (housed at the ARCCH), partial cranium with alveoli for I1–I3, isolated I1 and I2, partial C, and P1–M3; associated mandible with i1, i2, alveoli for i3, partial c, and p2–m3 (Figs. 1–3). Paratype: MAT-VP-5/1 (housed at the ARCCH), left mandible fragment with p4, m2, m3 and alveoli for m1 (Fig. 3B).

*Type locality*: Matabaietu Vertebrate Paleontology Locality One, Middle Awash study area, Afar Depression, Ethiopia.

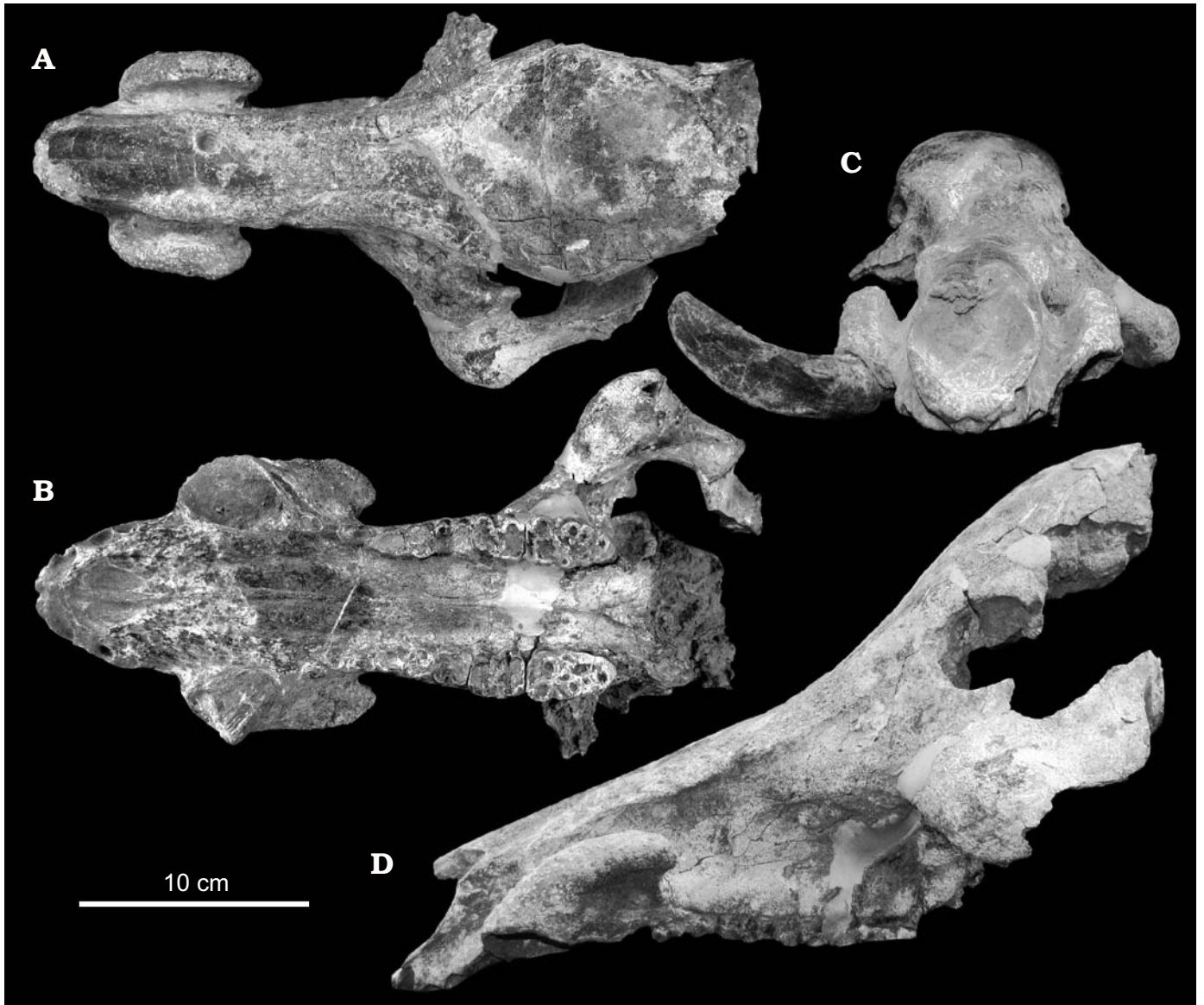

Fig. 1. Holotype cranium (MAT-VP-1/5) of the suid *Kolpochoerus phillipi* sp. nov. from Matabaietu area, ca. 2.5 Ma, Plio-Pleistocene, in dorsal (A), ventral (B), anterior (C), and lateral (D) views.

*Type horizon*: “W” Formation, Unit 9 sandstone (in situ), Plio-Pleistocene, ca. 2.5 Ma.

*Material*.—Seven isolated third molars, here referred to *Kolpochoerus* cf. *phillipi* sp. nov. (Table 1, Fig. 3C–I): KL 234-1, KL 234-3-5, MAT-VP-5/2, Matabaietu area, Middle Awash study area, Ethiopia; KL 10-3, KL 24-1 b, KL 39-4, KL 73-1, Wilti Dora area, Middle Awash region, Ethiopia; “W” Formation, Plio-Pleistocene, ca. 2.5 Ma.

*Diagnosis*.—Differs from all species of *Potamochoerus* and *Hylochoerus*, but resembles *Kolpochoerus*, in the presence of a ventrally extended and laterally expanded zygomatic arch, as well as a marked angle separating the rostrum and the elevated neurocranium in lateral view. Differs from all species of *Kolpochoerus* except *K. majus* in the presence of mesiodistally compressed lateral pillars of the molars, and zygomatic arches oriented at a 40° angle to the sagittal

plane in dorsal view in males; differs from *K. deheinznelini*, *K. millensis*, and *K. cookei* in having much larger and more complex teeth; differs from *K. afarensis* in having a dorsoventrally thickened mandibular symphysis, a more swollen mandibular body, less developed lower incisors, a less acute lower incisor arcade, more developed upper and lower canines, a less constricted parietal roof, and an anteroposteriorly elongated supra-canine flange (with the latter only being present in males); differs from *K. limnetes* in having a relatively shorter cranium, a rostrum retaining a constant width throughout, a narrower mandibular symphysis, and less symmetric and less complex m3 talonids; differs from *K. olduvaiensis*, *K. paiceae*, and *K. phacochoeroides* in having much shorter, lower and simpler third molars, unreduced premolars, an orbit located below the dorsal surface of the frontal, and a well-developed supra-canine flange in males;

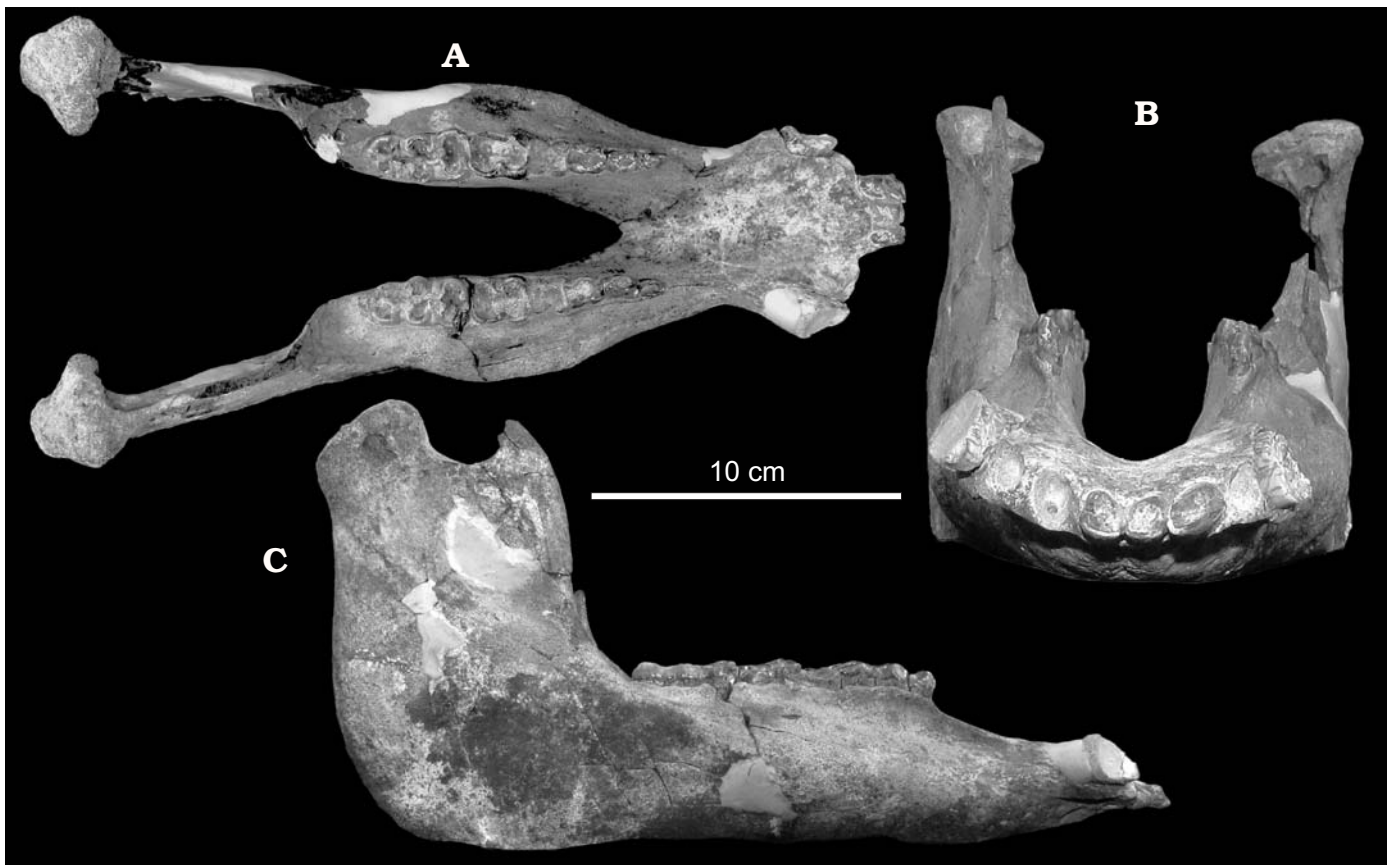

Fig. 2. Holotype mandible (MAT-VP-1/5) of the suid *Kolpochoerus phillipi* sp. nov. from Matabaietu area, ca. 2.5 Ma, Plio-Pleistocene, in dorsal (A), anterior (B), and lateral (C) views.

differs from *K. majus* in having a narrower mandibular symphysis, a more constricted parietal, near-parallel cheek tooth rows, and a strongly developed supra-canine flange in males.

**Description.**—The holotype cranium preserves the complete rostrum, most of the parietal roof, and the incomplete left zygomatic arch (Fig. 1), but lacks the entire occipital bone and the ventral portion of the braincase. An isolated piece of the basicranium was found, but is poorly preserved and cannot be attached to the rest of the skull. Judging from the eruption of all of the teeth and the presence of heavy wear on the first two molars, the specimen represents an adult. It can furthermore be identified as a male, based on the presence of well-developed lower and upper canines, a strong supra-canine flange, a laterally inflated zygomatic arch, a strongly swollen mandibular body, and a long mandibular symphysis. Sexual dimorphism in canine size is well documented in the Suidae (Harris and White 1979; Groves 1981; Made 1991; Cooke 2007), while the lateral expansion of the zygomatic arch in males occurs in several species of living and fossil African suids, including *Hylochoerus*, *Kolpochoerus*, and *Metridiochoerus* (Harris and White 1979; Geraads 2004). Similarly, a dorsoventrally developed, crest-like supra-canine flange characterizes males of *Potamochoerus* and some species of *Sus*, such as *S. celebensis* (Hardjasmita 1987), and is supposedly linked to the protection of the rhinarium muscles in species that fight using snout boxing (Kingdon 1979).

In terms of overall size, the skull is close to the average size of *Hylochoerus*, slightly smaller than female specimens of *K. majus*, and much smaller than *K. limnetes* and the only known male specimen of *K. majus* (BOU-VP-25/107; Gilbert 2008; Table 3). As in other species of *Kolpochoerus*, the cranium is relatively tall compared to *Potamochoerus* and *Hylochoerus*, and further resembles *K. majus* and early specimens of *K. limnetes*, but not *K. olduvaiensis*, in being relatively short anteroposteriorly (Fig. 4D). The postorbital constriction is comparable to the average *K. limnetes*, being weaker than in most specimens of *Potamochoerus* and *K. olduvaiensis*, but stronger than in *K. majus* and *Hylochoerus* (Fig. 4B, Table 3). The dental rows are almost parallel, unlike in *K. majus* in which the latter diverge anteriorly (Fig. 4C). The premaxilla is relatively wide transversely and inclined ventrally in lateral view, as in *K. majus* and *K. limnetes*. By contrast, the premaxilla is relatively narrow and more horizontal in *Potamochoerus* and *Hylochoerus* (Fig. 4A). In cross section, the rostrum is square, with vertical edges as seen in *Potamochoerus* and early specimens of *K. limnetes* (Fig. 1C). The transverse width of the rostrum remains constant along its entire length, unlike in *K. limnetes* in which the rostrum is widest somewhat posterior to the supra-canine flange and tapers anteriorly. As in *Potamochoerus* and early *K. limnetes*, the nasals overhang the maxilla in anterior view (Fig. 1C). In contrast to *K. olduvaiensis* and *K. paiceae*, the orbit is located

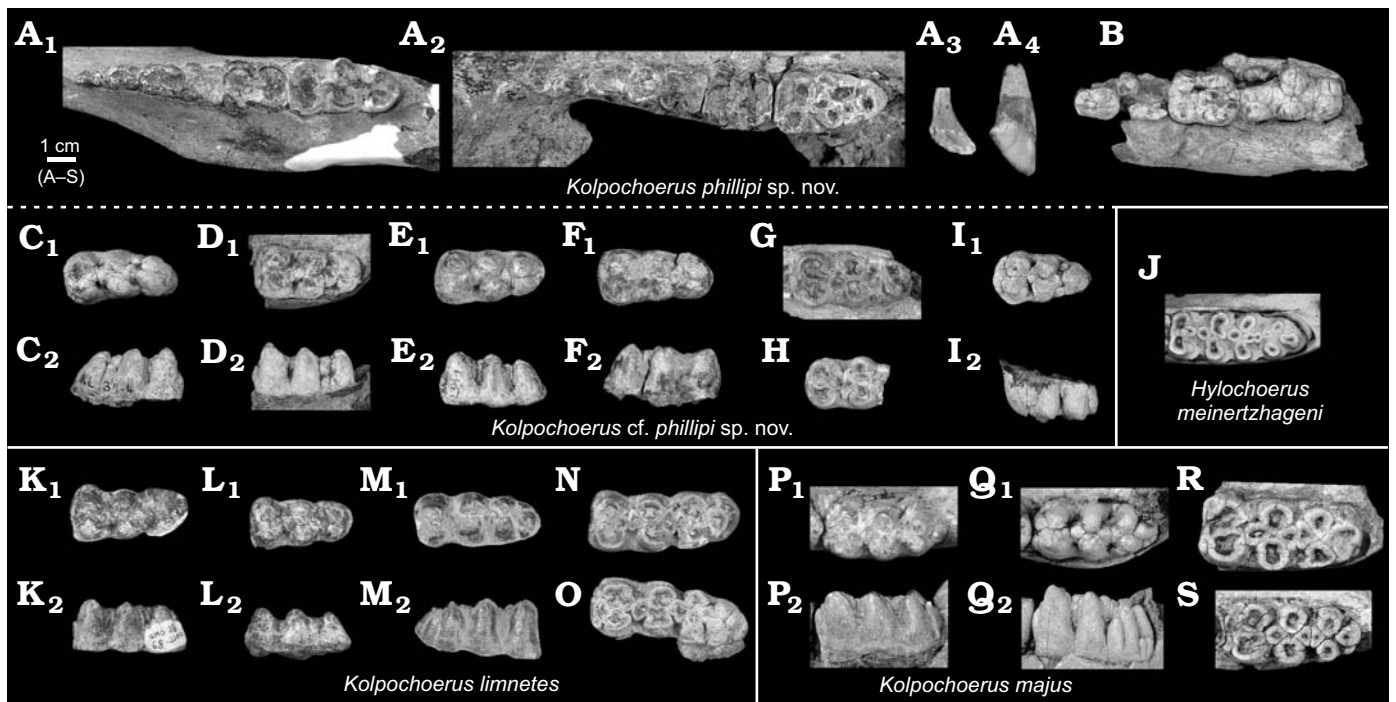

Fig. 3. Dental morphology of the suid mammal *Kolpochoerus phillipi* sp. nov. (A, B), *Kolpochoerus* cf. *phillipi* sp. nov. (C–I), *Hylochoerus meinertzhageni* (J), *Kolpochoerus limnetes* (K–O), and *Kolpochoerus majus* (P–S). Matabaietu area, ca. 2.5 Ma (A, B, E, F, I); Wilti Dora area, ca. 2.5 Ma (C, D, G, H); extant (J); unit B-10, Shungura Formation, ca. 2.95 Ma (K, L); unit C-8, Shungura Formation, ca. 2.58 Ma (M, N); lower part of Member J, Shungura Formation, ca. 1.7 Ma (O); Daka Member of Bouri Formation, ca. 1 Ma (P); Upper Bodo Sand Unit, ca. 0.5 Ma (Q, S). A. Holotype MAT-VP-1/5, left p2–m3 in occlusal view (A<sub>1</sub>), right P1–M3 in occlusal view (A<sub>2</sub>), right I2 (A<sub>3</sub>) and I1 (A<sub>4</sub>) in labial views. B. Paratype MAT-VP-5/1, left p4–m3 in occlusal view. C. KL 39-4, left m3 in occlusal (C<sub>1</sub>) and lingual (C<sub>2</sub>) views. D. KL 73-1, right m3 in occlusal (D<sub>1</sub>) and lingual (D<sub>2</sub>) views. E. KL 234-1, right m3 in occlusal (E<sub>1</sub>) and lingual (E<sub>2</sub>) views. F. KL 234-3-5, left m3 in occlusal (F<sub>1</sub>) and lingual (F<sub>2</sub>) views. G. KL 24-1 b, left m3 in occlusal view. H. KL 10-3, mesial fragment of left m3 in occlusal view. I. MAT-VP-5/2, right M3 in occlusal (I<sub>1</sub>) and labial (I<sub>2</sub>) views. J. MNHN-ZM-AC 1951-208, right m3 in occlusal view. K. OMO 28-1968-2100, right m3 in occlusal (K<sub>1</sub>) and lingual (K<sub>2</sub>) views. L. OMO 211-10005, right m3 in occlusal (L<sub>1</sub>) and lingual (L<sub>2</sub>) views. M. OMO 18-1968-2823, left m3 in occlusal (M<sub>1</sub>) and lingual (M<sub>2</sub>) views. N. OMO 18-1968-2104, right m3 in occlusal view. O. OMO 354-10004, left m3 in occlusal view. P. BOU-VP-3/50, right m3 in occlusal (P<sub>1</sub>) and lingual (P<sub>2</sub>) views. Q. BOD-VP-1/9, right m3 in occlusal (Q<sub>1</sub>) and lingual (Q<sub>2</sub>) views. R. KL 185-2, right m3 in occlusal view. S. KL 251-2, right m3 in occlusal view.

below the dorsal surface of the frontal, as in *K. afarensis*, *K. majus*, and *K. limnetes*. In lateral view, the dorsal surfaces of the frontal and parietal are arched dorsally, more so than in *K. afarensis*, but similar to *K. majus* and early *K. limnetes*.

The supra-canine flange is elongated anteroposteriorly and developed dorsoventrally, resembling the condition seen in males of early *Kolpochoerus limnetes*, although in the latter the dorsal edge of the flange is less rounded in lateral view. By contrast, the ventral part of the flange is short anteroposteriorly in males of *Potamochoerus*, and greatly reduced with only a weak lateral crest and a shallow gutter in *K. olduvaiensis*, *K. majus*, and *Hylochoerus* (Gilbert 2008). The zygomatic arch strongly projects ventrally, and is oriented at a 40° angle to the sagittal plane in dorsal view. In the latter feature, the present material resembles females of *K. majus* from the Daka Member of the Bouri Formation (ca. 1 Ma; Gilbert 2008) and the site of Asbole (Busidima Formation, 0.8–0.6 Ma; Geraads et al. 2004a), although it differs from males of this species in its slightly more obliquely oriented and less laterally inflated zygomatic arch (see above; Gilbert 2008). By contrast, the angle of the zygomatic arch to the sagittal plane is close to 90°, and the zygomatic knob is

usually covered with rugose bone in male specimens of *K. afarensis*, *K. limnetes*, and *K. olduvaiensis*. As in *K. afarensis* and early *K. limnetes*, the insertion scars for rostral muscles are relatively well marked in *K. phillipi* sp. nov., although less so than in *Potamochoerus*. In *Hylochoerus* and other species of *Kolpochoerus*, the muscle scars are reduced.

**Upper dentition.**—The upper dental formula is 3.1.4.3. The right I1 and I2 were found isolated (Fig. 3A), and resemble those of *K. limnetes* and *K. majus*. The upper canine is slightly triangular in cross section, much larger than in *Potamochoerus*, and much smaller than in males of *K. limnetes* and *K. majus* (Table 3). There are no marked grooves as in the canines of male *K. limnetes*, *K. majus*, and *Hylochoerus*, and the ventral side of the tooth displays a strongly ribbed enamel band. As in *Hylochoerus*, the canine is oriented slightly anterodorsally, at an angle of approximately 45° to the sagittal plane of the cranium (in dorsal view). The total length of the cheek tooth row is similar to that of the largest specimens of *Potamochoerus*, *K. afarensis*, and the smallest specimens of *K. limnetes* and *K. majus* (Table 3). The diastema between the upper canine and the premolars is relatively long compared to *Potamochoerus*, but within the range of *K. majus*, and relatively shorter than in



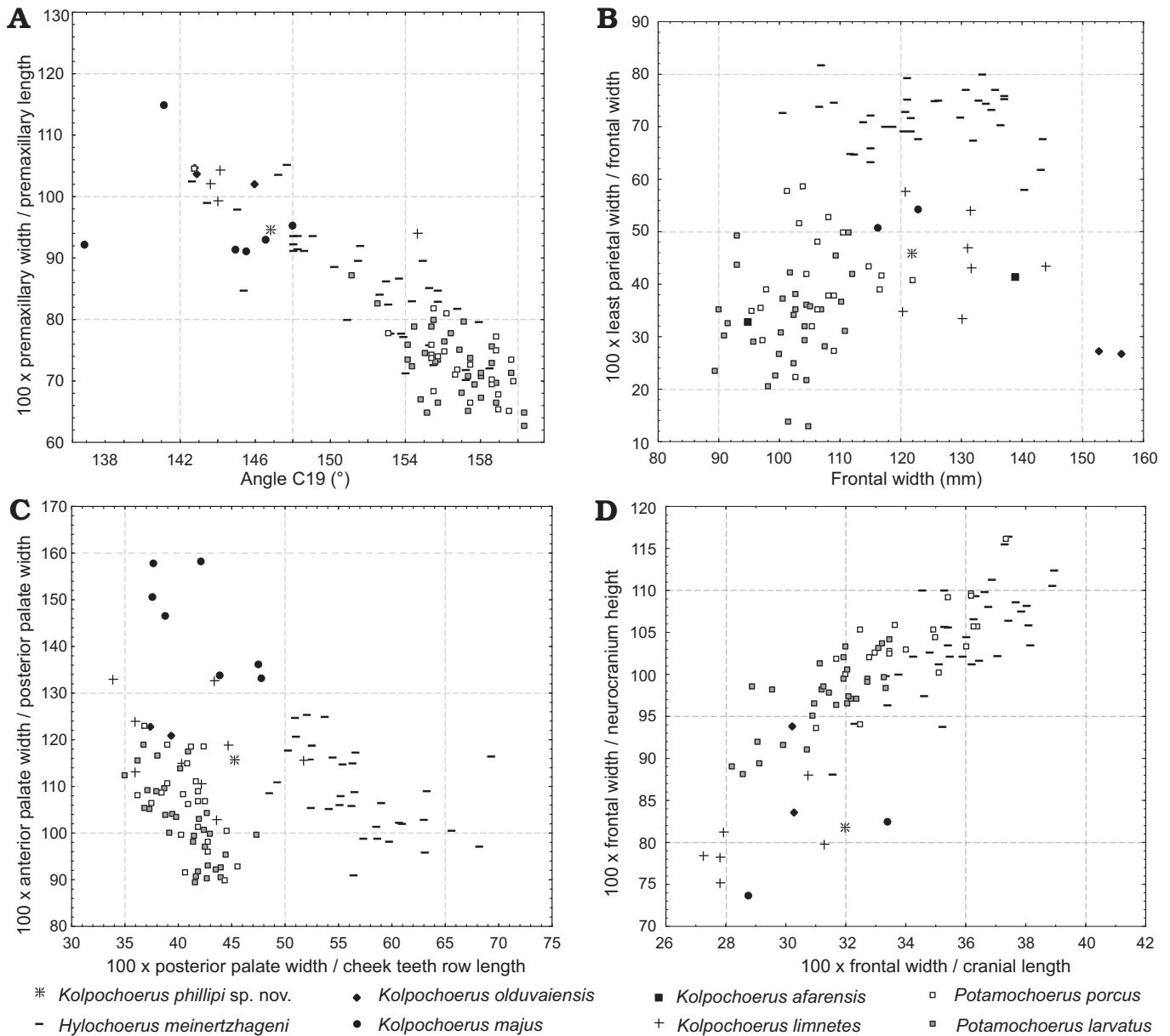

Fig. 4. Scatterplots of cranial measurements comparing *Kolpochoerus phillipi* sp. nov. with other species of *Kolpochoerus* and extant African species. **A.** Premaxillary proportions vs. premaxillary orientation. **B.** Parietal constriction vs. frontal width. **C.** Palate convergence vs. palate proportions. **D.** Cranium relative height vs. relative cranium length.

the average *K. limnetes* and *Hylochoerus* (Table 3). The upper premolars are similar in proportion and size (Table 5) to those of the smallest specimens of *K. limnetes* and *K. majus*, but relatively wider, with a higher width/length ratio, than those of *K. afarensis* (especially P3). P1 is small, and separated from P2 by a small diastema (Fig. 3A). The ratio between the premolar and molar row lengths is relatively high ( $C16/C17 \cdot 100 = 50$ ), similar to *Potamochoerus* (average  $C16/C17 \cdot 100 = 56$ ;  $n = 63$ ) and *K. majus* (average  $C16/C17 \cdot 100 = 54$ ;  $n = 12$ ), and relatively higher than in the average *K. limnetes* (average  $C16/C17 \cdot 100 = 44$ ;  $n = 20$ ). Both M1 and M2 are heavily worn, and fall within the range of *K. afarensis*, *K. limnetes*, and *K. majus* in terms of their size and proportions (Table 5). Finally, M3 comprises two pairs of lateral pillars, followed

by a strong terminal pillar and several small ectostyles (Fig. 3A), and resembles the corresponding teeth of *K. afarensis*, *K. majus*, and early *K. limnetes* from members B and C of the Shungura Formation (Fig. 5B). The wear pattern of the lateral pillars is simple, and similar to specimens of *K. majus*.

**Mandible.**—The holotype mandible is essentially complete (Fig. 2). As in other species of *Kolpochoerus* and *Hylochoerus*, the cheek tooth rows are nearly parallel, in contrast to the more anteriorly convergent condition seen in *Potamochoerus*. The mandibular symphysis is dorsoventrally thick as in *K. majus* and *K. limnetes*, but unlike *Potamochoerus* and *K. afarensis*. As in *K. majus*, the mandibular symphysis is thinnest close to its anterior extremity (Fig. 6D). The symphyseal area is relatively narrow, with its width/length ratio ( $M4/$

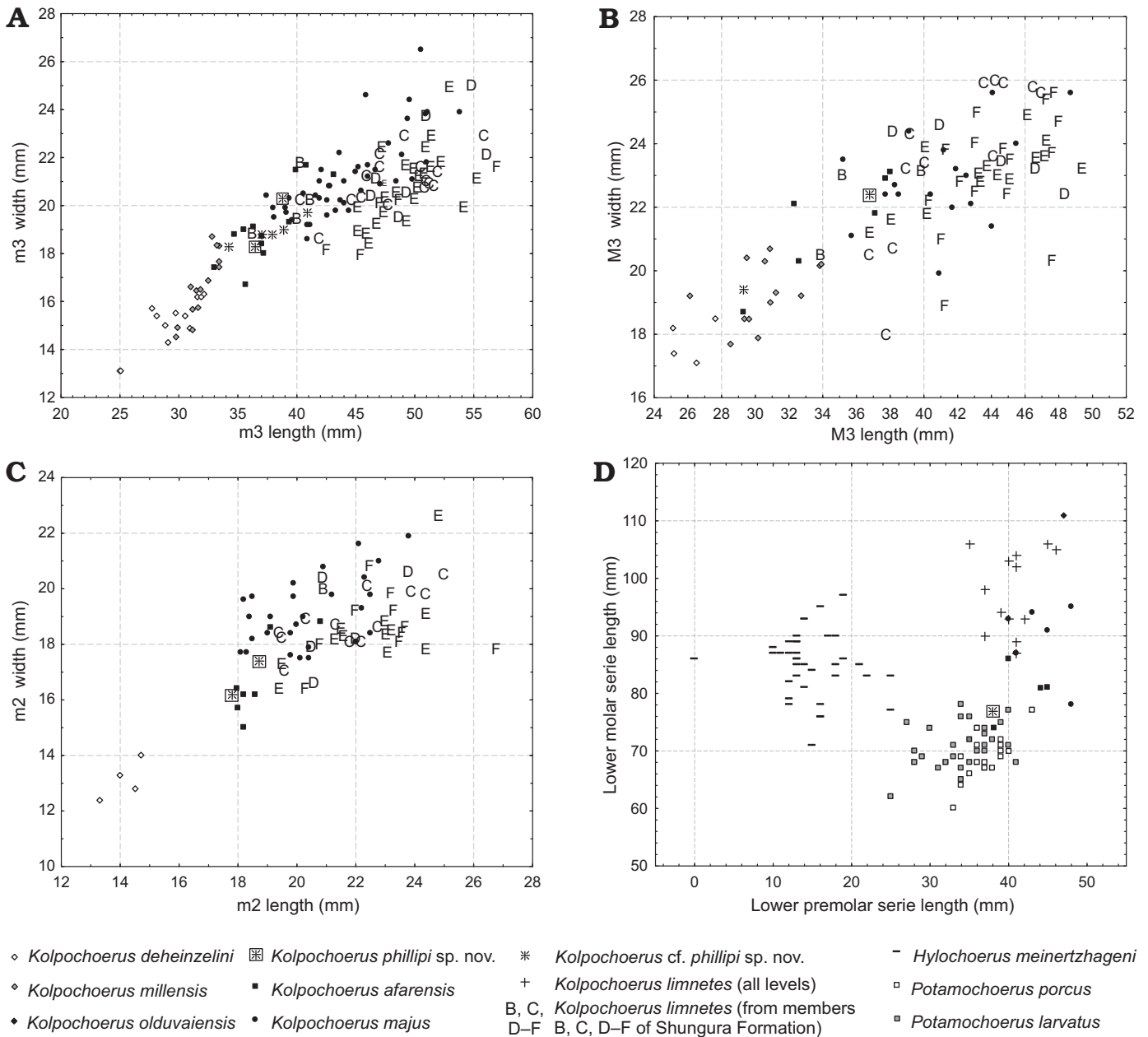

Fig. 5. Scatterplots of dental measurements comparing *Kolpochoerus phillipi* sp. nov. with other species of *Kolpochoerus* and extant species of African suids. **A.** Proportions of m3. **B.** Proportions of M3. **C.** Proportions of m2. **D.** Proportions of lower premolar and molar series. Data for *K. millensis* from Haile-Selassie and Simpson 2013.

M3\*100 = 75) falling within the range of *Potamochoerus* (59–85; n = 51) and *K. afarensis* (77–82; n = 2), while being narrower than in *K. majus* (93–114; n = 7) and males of *K. limnetes* (75–90; n = 3) (Fig. 6B, C). In female specimens of *K. limnetes* (recognized by their small lower canines and short mandibular symphysis), this region is comparatively narrow (ratio of 61–74; n = 3). In *K. phillipi* sp. nov., the posterior edge of the symphysis is fairly vertical, as in *K. majus*, but unlike the inclined condition seen in *K. limnetes* and *Potamochoerus* (Fig. 6D). The postcanine constriction is strong, although it should be noted that this character is related to sexual dimorphism (the differential development of canines in males and females), and hence highly variable

within each species. The incisor arcade is relatively straight, as in *Hylochoerus* and *K. majus* (Fig. 6C). It is possible that this character may be highly variable and related to sexual dimorphism as in *Potamochoerus*, *K. afarensis*, and *K. limnetes*, with relatively straight and angled incisor arcades characterizing males and females, respectively.

As in *Hylochoerus* and *K. majus*, but unlike in *Potamochoerus*, the width across both mandibular bodies at the level of the third molars is relatively large compared to the width of the mandible across the mandibular condyles (Table 4). The ascending ramus is relatively short, and similar to that of other species of *Kolpochoerus*. The mandibular body is relatively high compared to the overall height of the mandi-

Table 4. Mandible measurements of the holotype skull of *Kolpochoerus phillipi* sp. nov. (MAT-VP-1/5) compared to various suids. Measurements to nearest mm. Measurements are displayed as follows: mean  $\pm$  SD (n) (min; max).

	<i>Kolpochoerus phillipi</i> sp. nov.	<i>Hylochoerus</i>	<i>Potamochoerus</i>	<i>Kolpochoerus afarensis</i>	<i>Kolpochoerus limnetes</i> / <i>K. olduvaiensis</i>	<i>Kolpochoerus majus</i>
M1	334	319 $\pm$ 22 (35) (274; 354)	279 $\pm$ 16 (56) (248; 313)	–	420 $\pm$ 52 (3) (385; 480)	404 $\pm$ 32 (2) (381; 426)
M2	208	214 $\pm$ 14 (36) (185; 241)	182 $\pm$ 11 (60) (161; 205)	200 $\pm$ 13 (4) (187; 218)	267 $\pm$ 21 (13) (241; 314)	244 $\pm$ 21 (7) (218; 266)
M3	107	96 $\pm$ 10 (36) (77; 118)	90 $\pm$ 12 (60) (62; 112)	86 $\pm$ 17 (3) (67; 97)	125 $\pm$ 14 (19) (102; 151)	119 $\pm$ 18 (10) (95; 142)
M4	80	98 $\pm$ 11 (31) (81; 117)	63 $\pm$ 6 (48) (53; 75)	68 $\pm$ 14 (3) (52; 77)	102 $\pm$ 26 (8) (68; 129)	119 $\pm$ 15 (8) (100; 139)
M5	51	53 $\pm$ 5 (34) (40; 63)	37 $\pm$ 3 (55) (29; 43)	40 $\pm$ 2 (3) (39; 43)	57 $\pm$ 7 (6) (50; 66)	61 $\pm$ 3 (5) (58; 65)
M6	59	69 $\pm$ 6 (35) (59; 81)	57 $\pm$ 4 (59) (49; 67)	57 $\pm$ 0 (2) (57; 57)	72 $\pm$ 10 (8) (59; 88)	80 $\pm$ 8 (5) (73; 89)
M7	41	30 $\pm$ 4 (34) (22; 38)	28 $\pm$ 3 (45) (22; 37)	34 $\pm$ 5 (4) (29; 40)	45 $\pm$ 5 (11) (34; 54)	48 $\pm$ 7 (10) (39; 57)
M8	118	113 $\pm$ 10 (34) (95; 131)	94 $\pm$ 6 (45) (81; 106)	103 $\pm$ 14 (2) (93; 113)	138 $\pm$ 10 (7) (127; 154)	154 $\pm$ 12 (4) (141; 165)
M9	143	151 $\pm$ 13 (34) (114; 170)	134 $\pm$ 8 (53) (118; 154)	–	–	212 $\pm$ 5 (2) (208; 215)
M10	58	42 $\pm$ 5 (34) (31; 50)	46 $\pm$ 4 (45) (36; 55)	45 $\pm$ 4 (4) (41; 49)	57 $\pm$ 9 (8) (44; 72)	64 $\pm$ 9 (9) (48; 76)
M11	58	46 $\pm$ 4 (33) (37; 57)	44 $\pm$ 4 (45) (36; 53)	45 $\pm$ 6 (3) (39; 49)	58 $\pm$ 6 (10) (50; 68)	63 $\pm$ 8 (10) (47; 74)
M12	163	137 $\pm$ 11 (33) (114; 156)	129 $\pm$ 6 (44) (117; 144)	–	216 $\pm$ 26 (5) (181; 248)	214 $\pm$ 17 (3) (199; 233)
M13	52	67 $\pm$ 8 (36) (53; 89)	37 $\pm$ 7 (60) (18; 51)	36 $\pm$ 13 (6) (15; 49)	72 $\pm$ 12 (13) (50; 90)	55 $\pm$ 13 (11) (39; 74)
M14	38	15 $\pm$ 5 (36) (0; 25)	36 $\pm$ 4 (60) (25; 43)	42 $\pm$ 3 (5) (38; 45)	42 $\pm$ 6 (15) (35; 61)	43 $\pm$ 4 (10) (37; 50)
M15	77	85 $\pm$ 5 (36) (71; 97)	70 $\pm$ 4 (60) (60; 78)	80 $\pm$ 5 (5) (74; 86)	100 $\pm$ 7 (19) (87; 111)	91 $\pm$ 6 (9) (78; 98)
M16	113	99 $\pm$ 7 (34) (86; 115)	105 $\pm$ 6 (58) (87; 119)	120 $\pm$ 7 (5) (110; 126)	138 $\pm$ 9 (14) (126; 157)	132 $\pm$ 6 (7) (124; 142)
M17	32	23 $\pm$ 4 (36) (17; 33)	19 $\pm$ 3 (60) (13; 24)	20 $\pm$ 7 (5) (13; 29)	32 $\pm$ 7 (24) (18; 45)	33 $\pm$ 8 (13) (19; 45)
M18	22	19 $\pm$ 3 (34) (14; 28)	16 $\pm$ 2 (48) (12; 21)	15 $\pm$ 5 (4) (10; 20)	26 $\pm$ 6 (21) (14; 33)	28 $\pm$ 5 (11) (20; 37)
M19	26	34 $\pm$ 3 (35) (28; 41)	42 $\pm$ 6 (60) (25; 56)	50 $\pm$ 10 (2) (42; 57)	36 $\pm$ 11 (16) (18; 51)	22 $\pm$ 5 (8) (16; 31)
M20	39	46 $\pm$ 3 (33) (39; 52)	32 $\pm$ 3 (44) (26; 39)	37 $\pm$ 5 (2) (34; 41)	44 $\pm$ 3 (7) (40; 47)	47 $\pm$ 7 (5) (37; 56)

ble, and marked by a prominent swelling at the level of the molars. The latter feature, typical of *Kolpochoerus*, is to a lesser degree also present in *Potamochoerus* (Fig. 6A). The main anterolateral mental foramen is located relatively more dorsally than in *Potamochoerus* and *K. limnetes*, and more ventrally than in *Hylochoerus* and *K. majus*. In lateral view, the coronoid process terminates below the level of the dorsal border of the mandibular condyle, unlike in *Potamochoerus*, *Hylochoerus*, and other species of *Kolpochoerus*.

*Lower dentition.*—The mandibular dental formula is 3.1.3.3, with no evidence for p1. As in *Kolpochoerus limnetes* and *K. majus*, the lower incisors are reduced compared to *K. afarensis* and *Potamochoerus*. The enamel of the cheek teeth

is relatively thick, as in *K. afarensis*, *K. majus*, early *K. limnetes*, and *Potamochoerus*. The lower canine is verrucose (the distal face being smaller than the labial one), as in every species of *Kolpochoerus*. The canine is relatively wider than in *K. afarensis*, resulting in a relatively open, triangular cross section as seen in *K. majus* and *K. limnetes*; however, the height of the canine (measured from the alveolar rim to the crown apex) is smaller than in the latter two species.

The total length of the cheek tooth row is similar to *K. afarensis*, somewhat smaller than in *K. limnetes* and *K. majus*, and larger than in average specimens of *Potamochoerus* (Table 4). The diastema between the lower canine and the premolars is relatively short compared to the average *K. lim-*

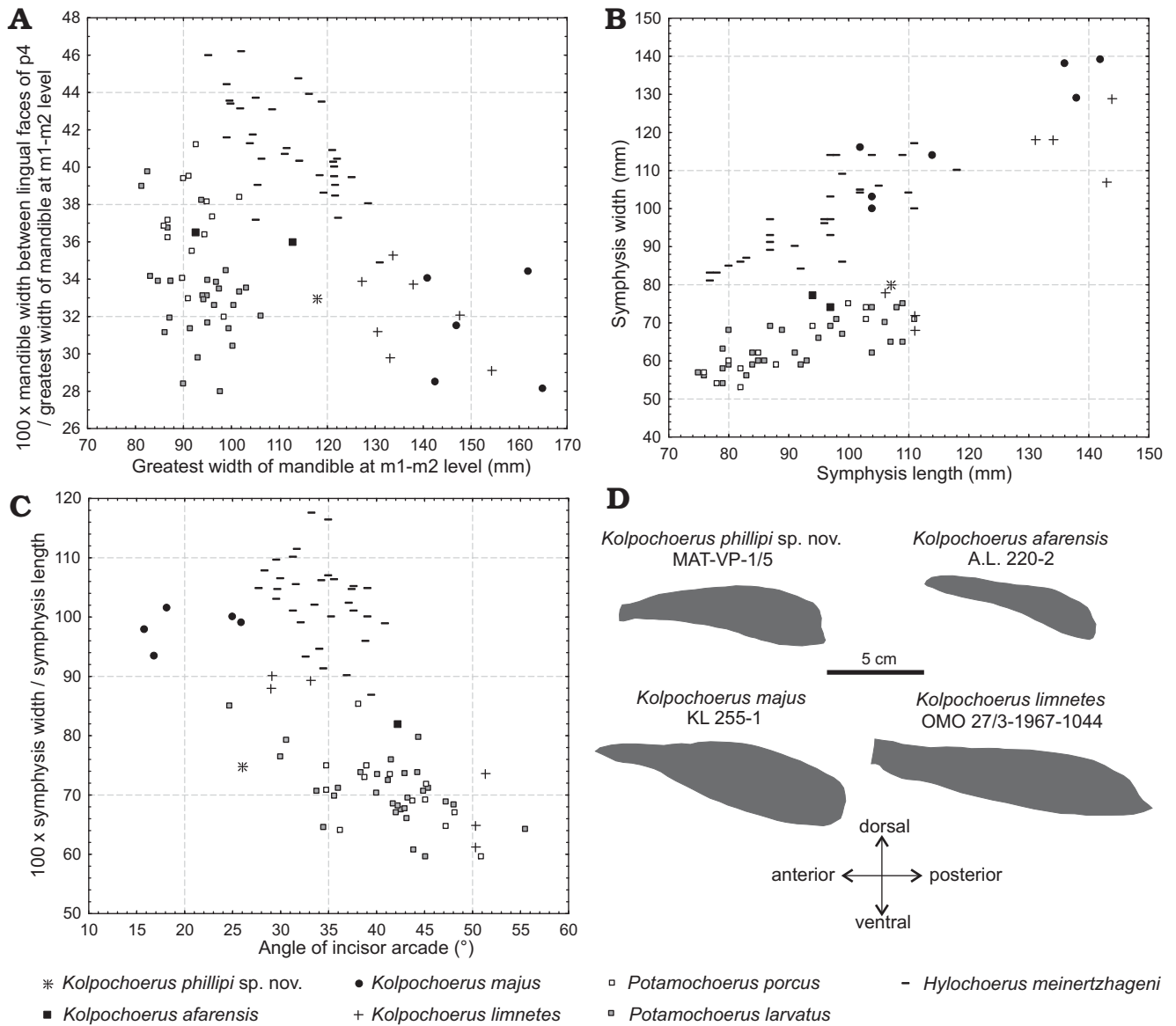

Fig. 6. Scatterplots of mandibular measurements comparing *Kolpochoerus phillipi* sp. nov. with other species of *Kolpochoerus* and extant African species. A. Degree of mandibular swelling. B. Proportions of mandibular symphysis. C. Proportions of symphysis vs. angle of incisor arcade. D. Sagittal profiles of mandibular symphysis in various suids.

*netes* and *K. majus*, and relatively longer than in *K. afarensis* and *Potamochoerus*. The premolars are similar in proportion and size to the smallest specimens of *K. limnetes* and *K. majus*. The ratio of premolar row to molar row length ( $M14/M15 \times 100 = 49$ ) resembles that of *Potamochoerus* (average  $M14/M15 \times 100 = 52$ ;  $n = 62$ ), early *K. limnetes* (for example, L 36-27 from Member D of Shungura Formation has a ratio of 46) and *K. majus* (average  $M14/M15 \times 100 = 49$ ;  $n = 7$ ) (Fig. 5D). Both the m1 and m2 of the holotype mandible are heavily worn, and within the range of *K. afarensis*, *K. limnetes*, and *K. majus* in terms of their size and proportions (Fig. 5C; Table 5). The m2 of the paratype mandible is slightly smaller than that of the holotype, similar in size to the specimens of *K. afarensis* (Fig. 5C).

Judging from the isolated m3s referred to *Kolpochoerus* cf. *phillipi* sp. nov. (Fig. 3C–G), it seems that they were small-

er, on average, than those of *K. majus* and early *K. limnetes* (Member C of the Shungura Formation). The holotype m3 is one of the largest specimens, which is congruent with its identification as a male (Fig. 5A; Table 5), and comprises three pairs of lateral pillars, followed by a small terminal pillar. The labial pillar of the third pair is more developed than the lingual one. In terms of its size and proportions, the m3 of *K. phillipi* sp. nov. is largely indistinguishable from that of *K. afarensis*, early *K. limnetes* (e.g., from members B and C of the Shungura Formation), and *K. majus* (Fig. 5A). However, the m3 talonid is more complex than in *K. afarensis*, which is characterized by two pairs of lateral pillars, followed by a single, well-developed terminal pillar. By contrast, the talonid of *K. phillipi* sp. nov. is less complex than that of contemporary specimens of *K. limnetes* from Member C of the Shungura Formation (ca. 2.7–2.5 Ma), which have a symmetric third

Table 5. Dental measurements (in mm) of the holotype skull of *Kolpochoerus phillipi* sp. nov. (MAT-VP-1/5). Abbreviations: e, estimate; L, length; P, p, premolar; M, m, molar; W, width.

P1		P2		P3		P4		M1		M2		M3		p2		p3		p4		m1		m2		m3	
L	W	L	W	L	W	L	W	L	W	L	W	L	W	L	W	L	W	L	W	L	W	L	W	L	W
6.1	5.1	9.0	8.2	9.2	13.3	9.6	14.0	12.0	15.7	18.0	20.4	36.8	22.4	7.9	5.7	12.2	8.3	10.6	11.4	13.5	12.7e	19.0	17.4	38.8	20.3

pair of lateral pillars and a well-developed terminal pillar (Fig. 3M, N); however, older representatives of *K. limnetes* from Member B of the Shungura Formation (ca. 2.9 Ma) resemble *K. phillipi* sp. nov. in terms of m3 talonid complexity (Fig. 3K, L). In Middle Pleistocene specimens of *K. majus*, there are three pairs of lateral pillars and a well-developed terminal pillar (Fig. 3P–S). With the exception of the smaller size of the terminal pillar, the holotype m3 thus resembles that of *K. majus*, having well-separated and mesiodistally compressed lateral pillars and a simple, rounded wear pattern, resulting in a bunolophodont aspect (Fig. 3A). Both of the holotype m3s are too worn to determine whether there are one or two median pillars between the second and third pairs of lateral pillars. Several authors consider this character to be diagnostic of the genus *Kolpochoerus* (van Hoepen and van Hoepen 1932; Geraads 2004), although it is absent in *K. deheinzeli*, *K. millensis*, *K. cookei*, and usually also *K. afarensis*. In *K. cf. phillipi* sp. nov., the median pillar is single, or faintly divided (Fig. 3B–G), whereas there is a double median pillar in the earliest *K. limnetes* (Fig. 3K, L) and *K. majus* (Fig. 3P–S).

*Stratigraphic and geographic range.*—Known only from ca. 2.5 Ma old deposits in the Matabaietu and Wilti Dora areas, Middle Awash study area, Afar Depression, northern Ethiopia.

## Discussion

**Evolutionary relationships.**—The ventrally and laterally expanded zygomatic arches, together with the dorsally expanded neurocranium, the characteristic dental morphology, and the inflated mandibular body firmly place the new species within the genus *Kolpochoerus*. This assignment was corroborated by the results of our cladistic analysis (Fig. 7), which resulted in a single most parsimonious tree of 35 steps (Consistency index = 0.69; Retention index = 0.75). Twelve characters (3, 5, 6, 9, 11, 12, 14, 16, 17, 19, 20, and 21) were free of homoplasy.

African suids form a monophyletic group (node A) including *Potamochoerus*, *Hylochoerus*, and a paraphyletic *Kolpochoerus*. This clade is supported by three unambiguous synapomorphies: a transverse zygomatic arch in dorsal view in males (ch. 1); a dorsoventrally high supra-canine flange (ch. 11); and a strongly swollen mandibular body (ch. 15). A clade comprising *Kolpochoerus* + *Hylochoerus* (node B) is also supported by three unambiguous synapomorphies, including: a ventrally extended zygomatic arch in males (ch. 0); a mediolaterally thickened zygomatic arch in males (ch. 2); and the separation of the rostrum and neuro-

cranium by a distinct angle in lateral view (ch. 4). Characters describing the morphology of the premaxilla (ch. 8 and 9) could not be coded for *K. afarensis*, as the premaxillae were either missing or distorted in all available specimens, including the holotype A.L. 147-10 (Cooke 1978a). However, based on the morphology of the mandibular symphysis, which bears an infradentale located distinctly ventral to the level of the lower cheek teeth, it is likely that the premaxilla of *K. afarensis* was strongly inclined so as to allow contact between the lower and upper incisors. If confirmed by new fossils, this would make the presence of a relatively wide and ventrally inclined premaxilla (ch. 8 and 9) a potential synapomorphy for *Kolpochoerus*. In addition, the symphyseal morphology of *K. millensis* is very similar to that of *K. afarensis* (Haile-Selassie and Simpson 2013: fig. 4), and might therefore support the inclusion of *K. millensis* (and, indirectly, its ancestral chronospecies *K. deheinzeli*) within the genus *Kolpochoerus*.

The clustering of advanced species of *Kolpochoerus* (*K. limnetes*, *K. olduvaiensis*, *K. majus*, and *K. phillipi* sp. nov.) and *Hylochoerus* to the exclusion of *K. afarensis* (node C) is supported by two unique, unambiguous synapomorphies: a straight lower incisor arcade in males (ch. 16); and reduced lower incisors with i2 being shorter and oriented obliquely to i1 (ch. 19). The presence of an anteroposteriorly elongated supra-canine flange (ch. 12) is an ambiguous synapomorphy that could support either this clade (node C) or the clade comprising *Kolpochoerus* + *Hylochoerus* (node B). This ambiguity stems from the fact that the morphology of the supra-canine flange is unknown in *K. afarensis*.

Within the clade comprising advanced *Kolpochoerus* species and *Hylochoerus*, *K. limnetes*, and *K. olduvaiensis* form a sister-group relationship (node D) supported by three unique, unambiguous synapomorphies: a relatively long cranium (ch. 3); a relatively low rostrum (ch. 5); and molars tending to display a flat wear pattern of the lateral pillars (ch. 21). Closely related to this group is a clade comprising the “bunolophodont suines” *K. majus*, *K. phillipi* sp. nov., and *Hylochoerus*, supported by two unambiguous synapomorphies: an obliquely oriented zygomatic arch in dorsal view in males (ch. 1); and molar teeth displaying mesiodistally compressed lateral pillars (ch. 20), resulting in a characteristic bunolophodont appearance (Fig. 3A–J, P–S).

Within the “bunolophodont suines”, *Kolpochoerus majus* is the sister taxon of the extant *Hylochoerus meinertzhageni* (node F), to the exclusion of *K. phillipi* sp. nov. This relationship is supported by four unambiguous synapomorphies: a weakly constricted parietal roof (ch. 6); reduced scars for the attachment of the rhinarium muscles (ch. 7); the absence of a crest-like supra-canine flange (ch. 10); and a dorsoventrally

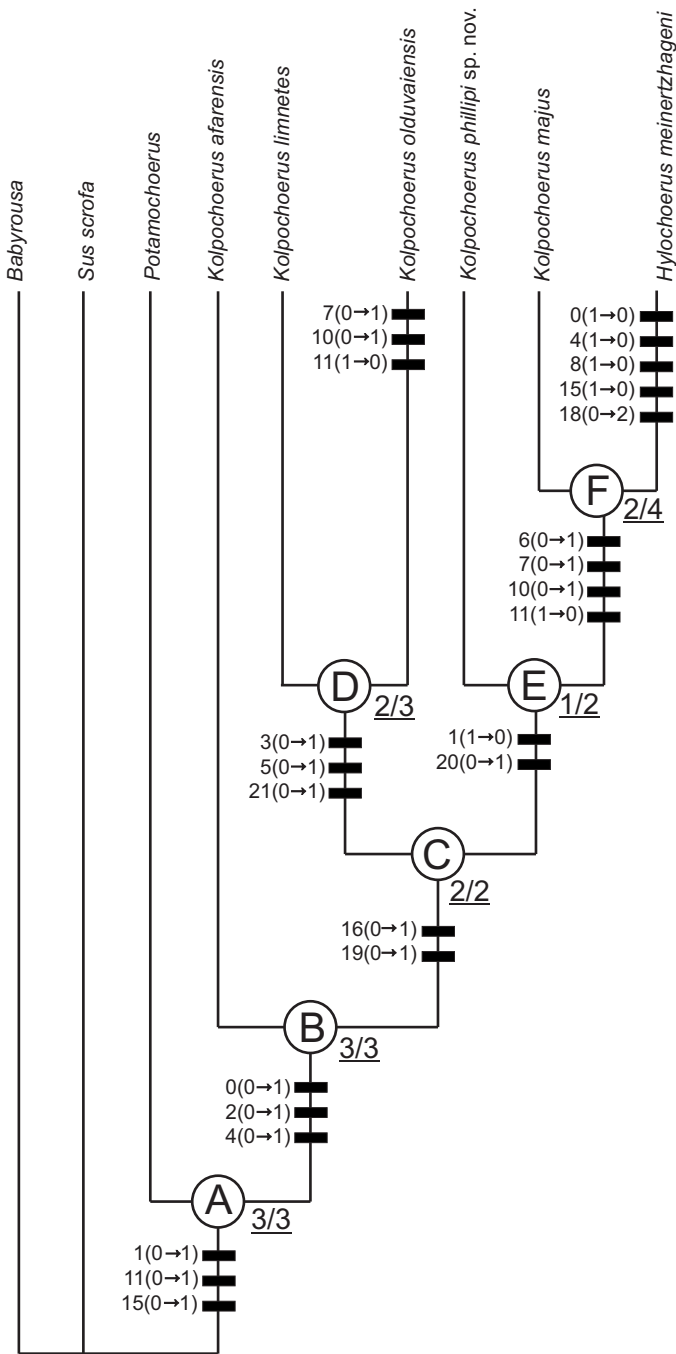

Fig. 7. Single most parsimonious cladogram obtained from the matrix shown in Appendix 1. TL = 35, CI = 0.69, RI = 0.75. Synapomorphies are mapped. For each node, support is indicated by the Bremer index followed by the number of unambiguous synapomorphies (separated by a dash).

low supra-canine flange (ch. 11). Two characters (14 and 17) describing the mandibular morphology of female specimens could not be coded for *K. phillipi* sp. nov., and thus represent ambiguous synapomorphies that could support either the clade comprising *K. majus* + *Hylochoerus* clade, or the “bunolophodont suines” as a whole.

The only previous cladistic analysis of *Kolpochoerus* found all of the dentally derived species (*K. olduvaiensis*, *K. paiceae*, *K. phacochoeroides*, and *Hylochoerus*) to form

a clade based on the reduction of the premolars, and the presence of longer and more complex third molars (Geraads 1993, 2004). However, these characters are notorious for being prone to convergence (Harris and White 1979), and appear multiple times during the Plio-Pleistocene in different genera of African suids (*Kolpochoerus*, *Metridiochoerus*, *Nyanzachoerus*/*Notochoerus*), probably as an adaptation to a more specialized herbivorous diet. We therefore chose not to include characters dealing with the length of the third molars in our analysis. In addition, we found that the reduction of the upper premolars convergently occurs in at least two independent groups (*K. limnetes*/*K. olduvaiensis* and *Hylochoerus*), according to our results.

In our cladogram, *Kolpochoerus phillipi* sp. nov. is positioned as an early offshoot of the “bunolophodont suines”. However, given their respective ages, their general morphological resemblance (especially as regards the morphology of the molars), the apparent absence of autapomorphies in the new species, and the fact that phyletic change is a well-documented phenomenon in various lineages of Plio-Pleistocene suids (Harris and White 1979), we consider it likely that *K. phillipi* sp. nov. and *K. majus* form a chronospecies pair analogous to *K. limnetes*/*K. olduvaiensis*, with *K. phillipi* sp. nov. representing an earlier, ancestral form of *K. majus*. Clarification of this question will likely have to await the description of abundant material of *K. majus* from Konso, southern Ethiopia, dated to around 1.9–1.4 Ma (currently under study by Gen Suwa and colleagues). Given the limited fossil record of *Hylochoerus* and our poor knowledge of its evolutionary history, the potential status of *H. meinertzhageni* as a highly derived species of *Kolpochoerus* is intriguing (e.g., Cooke and Wilkinson 1978; Harris and White 1979; Geraads 2004), and we suggest that it may have originated sometime during the Pleistocene from a *K. majus*-like ancestor. Our ongoing studies of numerous *K. majus* specimens from the Middle Awash area spanning the time period from 1.0–0.1 Ma may help to resolve this issue.

**Biochronology.**—*Kolpochoerus phillipi* sp. nov. closes the morphological gap between the small, brachyodont and bunodont Pliocene *K. afarensis* and the larger, bunolophodont Middle Pleistocene *K. majus*. Although the lower third molars of *K. phillipi* sp. nov. are somewhat shorter and less complex than that of *K. majus*, the similarities in dental morphology and wear pattern are striking, and draw attention to the potential use of cranio-mandibular anatomy as a biostratigraphic tool within a potential *K. phillipi* sp. nov. + *K. majus* lineage. Especially interesting features include the supra-canine flange, the zygomatic arch, and the mandibular symphysis.

The Konso Formation of Ethiopia and the Nyabusosi Formation of Uganda have been dated to around 1.9–1.4 Ma and 1.8 Ma, respectively, and have yielded numerous dental specimens assigned to *K. majus* (Pickford 1994; Suwa et al. 2003). In terms of their morphology, these specimens are less complex than those of Middle Pleistocene *K. majus*,

and include m3s with three well-developed pairs of lateral pillars, followed by a small terminal pillar. While resembling the condition seen in *K. phillipi* sp. nov., the terminal pillar appears somewhat more developed than in the latter, and thus possibly represents an intermediate morphological stage. More complete cranio-mandibular material from Konso will enable us to test this hypothesis. Harris et al. (1988) also attributed a single m3 from the upper part of the Lomekwi Member of the Nachukui Formation (dated to around 2.6 Ma) to *K. majus*. Although its age makes it possible that this specimen may in fact belong to *K. phillipi* sp. nov., no cranio-mandibular remains were found in association.

**Paleoecology.**—Suid paleodiets are generally interpreted based on the strong differences between the three extant African genera *Potamochoerus*, *Hylochoerus*, and *Phacochoerus*. *Potamochoerus* has short, brachyodont and simple third molars, as well as well-developed lower and upper incisors and well-marked rhinarium muscle scars. By contrast, *Phacochoerus* has very long, complex, and hypsodont third molars with numerous pillars packed within cement, greatly reduced incisors, and reduced rhinarium muscle scars. These characteristics are thought to be adaptations to omnivorous (with a strong rootling behavior) and grazing diets (e.g., Kullmer 1999), respectively. *Hylochoerus* has moderately hypsodont and relatively complex bunolophodont cheek teeth that are thought to reflect its diet of soft browse (Harris and Cerling 2002), although some studies also indicate a more opportunistic diet (d’Huart 1978; Viehl 2003; Cerling and Viehl 2004).

Considered within this framework, *Kolpochoerus phillipi* sp. nov. would definitely fall within the *Potamochoerus*-like omnivorous suids, based on its well-developed rhinarium muscle scars, square cross-section of the rostrum, and relatively unspecialized dentition. *Kolpochoerus majus* also retains an unspecialized dentition (although there is a trend towards a somewhat more complex and hypsodont m3), but the cross-section of its rostrum is less square and the rhinarium muscles scars are reduced, suggesting an omnivorous diet with a reduced degree of rootling.

Based on our results, two different groups of *Kolpochoerus* coexisted during the Pleistocene: the *K. limnetes*/*K. olduvaiensis* phyletic lineage, and the newly described clade of “bunolophodont suines.” Whereas the former displays clear, progressive adaptations to grazing, as shown by the increased length, hypsodonty, and complexity of the third molars, as well as the reduction of the premolars (Harris and White 1979), *K. phillipi* sp. nov. and *K. majus* retained their overall unspecialized dental morphologies from the apparent origin of the lineage ~2.6 Ma up to the last known occurrence of *K. majus* around 0.1 Ma (Kalb et al. 1982a; Gilbert 2008; Middle Awash research project unpublished data). During this period, lateral pillars apparently increased in height relative to crown length, and enamel became more rugose as an anchor for thicker cementum, phenomena also observed

in the living *Hylochoerus*. A bunolophodont morphology associated with an otherwise unspecialized dentition and skull was therefore a hallmark of the lineage leading to *K. majus*, in contrast to the obviously specialized cranio-mandibular and derived dentition of *Hylochoerus*. Future paleoecological reconstructions using dental microwear, stable isotopes, and morpho-functional analysis should help to shed light on the relationships between the cranio-mandibular morphology, dental morphology, and diet of these “bunolophodont suines”.

## Conclusions

We describe the new species *Kolpochoerus phillipi* sp. nov. and suggest that it may either represent an early member of a clade of “bunolophodont suines”, or, more likely, an ancestral chronospecies of the younger *K. majus*. In order to better understand the interrelationships, as well as the mode and tempo of evolutionary change within this lineage, additional efforts are needed in several respects. More collection is planned for the Matabaietu area to increase the number of specimens assignable to the new species. In addition, ongoing stratigraphic and geochronological studies on both sides of the Awash River in the Middle Awash will further refine the placement of specimens of both *K. phillipi* sp. nov. and *K. majus*. We judge it likely that in time, either here or elsewhere in Africa, there will be transitional forms found that may either confirm the status of *K. phillipi* sp. nov. as an independent species, or unite the latter and *K. majus* as chronospecies within a single phyletic lineage. We are of the opinion that the creation of yet another chronospecies for such yet undiscovered fossils—to fill such temporal gaps along a phyletic lineage (as was the case for the recently proposed *K. millensis*; Haile-Selassie and Simpson 2013)—is a classificatory practice that over-parses the fossil record and unnecessarily inflates the roster of Plio-Pleistocene suids. Only additional fossils will clarify these matters.

Lineage differentiation within the *Kolpochoerus* clade has been clarified by the recognition of *K. phillipi* sp. nov. as a close relative and potential ancestor of *K. majus*, but timing the origin of this species lineage remains difficult. Likewise, the *K. limnetes* lineage also continues to be plagued by a paucity of adequate cranial material, and its earliest members are usually only represented by dental remains. Obviously, by the time *K. phillipi* sp. nov. appears in the African fossil record at 2.5 Ma, there has been cladogenesis within *Kolpochoerus*, presumably arising from a common ancestor such as *K. afarensis*. Recent discoveries in the 3.0–2.5 Ma intervals of the Omo Shungura Formation of southern Ethiopia and the Middle Awash of the Afar Rift promise to resolve the details of this cladogenesis, and clarify the lower bounds of the lineages leading to *K. phillipi* sp. nov. and *K. limnetes*, pending completion of the chronostratigraphic and anatomical studies currently underway.

## Acknowledgements

We are grateful to the staff of the institutions, where we spent much time studying collections of extant and fossil suids: Joséphine Lesur and Christine Lefèvre (Muséum National d'Histoire Naturelle, Paris, France), Wim Wendelen and Emmanuel Gilissen (Musée Royal d'Afrique Centrale, Tervuren, Belgium), Roberto Portela, Richard Sabin, Andy Currant, and Jerry Hooker (all Natural History Museum, London, UK), Jara HaileMariam, Yonas Desta, Mamitu Yilma, Dawit Tibebe, Tomas Getachew, and Andergachew Girmaye (all Authority for Research and Conservation of Cultural Heritage, Addis Ababa, Ethiopia), Emma Mbuja, Mary Muungu, and Ogeto Mwebi (all Kenya National Museums). We also thank the Omo Group Research Expedition for access to its specimens. We are grateful to Zeresenay Alemseged (California Academy of Sciences, San Francisco, USA) and Denis Geraads (Muséum National d'Histoire Naturelle, Paris, France) for access to the Asbole suids. Preparation work of the holotype specimen of the new species was done with much help by Wogen Amarga (Middle Awash research project). We also thank Patrick Vignaud, Ghislaine Florent, and Carine Noël (Institut de Paléoprimateologie, Paléontologie Humaine: Évolution et Paléoenvironnements, Université de Poitiers, France) for their support, the editor Felix Marx (University of Bristol, Bristol, UK), John Harris (Natural History Museum of Los Angeles County & George C. Page Museum, Los Angeles, USA), Ray Bernor (Howard University, Washington, DC, USA), and an anonymous reviewer for their reviews that helped to improve our manuscript, and Gen Suwa (University of Tokyo Museum, Tokyo, Japan) for fruitful discussions. AS was supported by a European Union SYNTHESYS grant (GB-TAF 886) for his work at the NHMUK, and also by the Agence Nationale pour la Recherche (project ANR-09-BLAN-0238, Michel Brunet) for other collections. For funding of the Middle Awash research project, we thank the NSF (this material is based on work supported by grants 8210897, 9318698, 9512534, 9632389, 9729060, 9727519, 9910344, and 0321893 (HOMINID-RHOI), the Institute of Geophysics and Planetary Physics of the University of California at Los Alamos National Laboratory (LANL), and the Japan Society for the Promotion of Science. Desmond Clark (University of California, Berkeley, USA) inspired this effort and conducted Middle Awash laboratory and/or field research. We thank the Ministry of Tourism and Culture and the Authority for Research and Conservation of the Cultural Heritage for permissions and facilitation; and the Afar Regional Government, the Afar people of the Middle Awash, and many other field workers who contributed directly to the research effort and results.

## References

- Assefa, Z., Yirga, S., and Reed, K.E. 2008. The large-mammal fauna from the Kibish Formation. *Journal of Human Evolution* 55: 501–512.
- Bibi, F. 2011. *Tragelaphus nakuae*: evolutionary change, biochronology, and turnover in the African Plio-Pleistocene. *Zoological Journal of the Linnean Society* 162: 699–711.
- Bishop, L.C. 2010. Suidae. In: L. Werdelin and W.J. Sanders (eds.), *Cenozoic Mammals of Africa*, 821–842. University of California Press, Berkeley.
- Brunet, M. and White, T.D. 2001. Deux nouvelles espèces de Suini (Mammalia, Suidae) du continent africain (Ethiopie; Tchad). *Comptes Rendus de l'Académie des Sciences* 332: 51–57.
- Cerling, T.E. and Viehl, K. 2004. Seasonal diet changes of the forest hog (*Hylochoerus meinertzhageni* Thomas) based on the carbon isotopic composition of hair. *African Journal of Ecology* 42: 88–92.
- Cooke, H.B.S. 1978a. Pliocene–Pleistocene Suidae from Hadar, Ethiopia. *Kirtlandia* 29: 1–63.
- Cooke, H.B.S. 1978b. Suid evolution and correlation of African hominid localities: an alternative taxonomy. *Science* 201: 460–463.
- Cooke, H.B.S. 1997. The status of the African fossil suids *Kolpochoerus limnetes* (Hopwood, 1926), *K. phacochoeroides* (Thomas, 1884) and “*K.*” *afarensis* (Cooke, 1978). *Géobios* 30: 121–126.
- Cooke, H.B.S. 2007. Stratigraphic variation in Suidae from the Shungura Formation and some coeval deposits. In: R. Bobe, Z. Alemseged, and A.K. Behrensmeyer (eds.), *Hominin Environments in the East African Pliocene*, 107–127. Springer, Dordrecht.
- Cooke, H.B.S. and Ewer, R.F. 1972. Fossil Suidae from Kanapoi and Lothagam, Northwestern Kenya. *Bulletin of the Museum of Comparative Zoology* 143: 149–237.
- Cooke, H.B.S. and Wilkinson, A.F. 1978. Suidae and Tayassuidae. In: V.J. Maglio and H.B.S. Cooke (eds.), *Evolution of African Mammals*, 435–482. Harvard University Press, Cambridge.
- d’Huart, J.-P. 1978. *Ecologie de l’hylochère (Hylochoerus meinertzhageni Thomas) au Parc National des Virunga. Exploration du Parc National des Virunga, Deuxième Série, Fascicule 25*. 156 pp. Fondation pour Favoriser les Recherches scientifiques en Afrique, Brussels.
- d’Huart, J.-P. and Yohannes, E. 1995. Assessment of the present distribution of the forest hog (*Hylochoerus meinertzhageni*) in Ethiopia. *IBEX Journal of Mountain Ecology* 3: 46–48.
- de Heinzelin, J., Clark, J.D., White, T.D., Hart, W.K., Renne, P., WoldeGabriel, G., Beyene, Y., and Vrba, E. 1999. Environment and behavior of 2.5-million-year-old Bouri hominids. *Science* 284: 625–629.
- Driesch, A. v.d. 1976. A guide to the measurement of animal bones from archaeological sites. *Peabody Museum Bulletin* 1: 1–172.
- Geraads, D. 1993. *Kolpochoerus phacochoeroides* (Thomas, 1884) (Suidae, Mammalia), du Pliocène supérieur de Ahl Al Oughlam (Casablanca, Maroc). *Géobios* 26: 731–743.
- Geraads, D. 2004. New skulls of *Kolpochoerus phacochoeroides* (Suidae: Mammalia) from the late Pliocene of Ahl al Oughlam, Morocco. *Palaeontologia Africana* 40: 69–83.
- Geraads, D., Alemseged, Z., Reed, D., Wynn, J., and Roman, D.C. 2004a. The Pleistocene fauna (other than Primates) from Asbole, lower Awash Valley, Ethiopia, and its environmental and biochronological implications. *Géobios* 37: 697–718.
- Geraads, D., Eisenmann, V., and Petter, G. 2004b. The large mammal fauna of the Oldowan sites of Melka Kunture. In: J. Chavaillon and M. Piperno (eds.), *Studies on the Early Paleolithic Site of Melka Kunture, Ethiopia*, 169–192. Istituto Italiano di Preistoria e Protostoria, Firenze.
- Gilbert, H.W. 2008. Suidae. In: H.W. Gilbert and B. Asfaw (eds.), *Homo erectus: Pleistocene Evidence from the Middle Awash, Ethiopia*, 231–260. University of California Press, Berkeley.
- Goloboff, P.A., Farris, J.S., and Nixon, K.C. 2008. TNT, a free program for phylogenetic analysis. *Cladistics* 24: 774–786.
- Gongora, J., Cuddahee, R.E., Nascimento, F.F., Palgrave, C.J., Lowden, S., Ho, S.Y.W., Simond, D., Damayanti, C.S., White, D.J., Tay, W.T., Randi, E., Klingel, H., Rodrigues-Zarate, C.J., Allen, K., Moran, C., and Larson, G. 2011. Rethinking the evolution of extant sub-Saharan African suids (Suidae, Artiodactyla). *Zoologica Scripta* 40: 327–335.
- Groves, C. 1981. Ancestors for the pigs: taxonomy and phylogeny of the genus *Sus*. *Technical Bulletin* 3: 4–8.
- Grubb, P. and d’Huart, J.-P. 2010. Rediscovery of the Cape warthog *Phacochoerus aethiopicus*: a review. *Journal of East African Natural History* 99: 77–99.
- Haile-Selassie, Y. and Simpson, S.W. 2013. A new species of *Kolpochoerus* (Mammalia: Suidae) from the Pliocene of Central Afar, Ethiopia: its taxonomy and phylogenetic relationships. *Journal of Mammalian Evolution* 20: 115–127.
- Hardjasasmita, H.S. 1987. Taxonomy and phylogeny of the Suidae (Mammalia) in Indonesia. *Scripta Geologica* 85: 1–68.
- Harris, J.M. and Cerling, T.E. 2002. Dietary adaptations of extant and Neogene African suids. *Journal of Zoology* 256: 45–54.
- Harris, J.M. and White, T.D. 1979. Evolution of the Plio-Pleistocene African Suidae. *Transactions of the American Philosophical Society* 69 (2): 1–128.



- Harris, J.M., Brown, F.H., and Leakey, M.G. 1988. Stratigraphy and paleontology of Pliocene and Pleistocene localities west of Lake Turkana, Kenya. *Contributions in Science, Natural History Museum of Los Angeles County* 399: 1–128.
- Hendey, Q.B. and Cooke, H.B.S. 1985. *Kolpochoerus paiceae* (Mammalia, Suidae) from Skurwerug, near Saldanha, South Africa, and its palaeoenvironmental implications. *Annals of the South African Museum* 97 (2): 9–56.
- Hopwood, A.T. 1934. New fossil mammals from Olduvai, Tanganyika Territory. *Annals and Magazine of Natural History* 14: 546–550.
- Kalb, J.E., Jolly, C.J., Mebrate, A., Tebedge, S., Smart, C., Oswald, E.B., Cramer, D., Whitehead, P., Wood, C.B., Conroy, G.C., Adefris, T., Sperling, L., and Kana, B. 1982a. Fossil mammals and artefacts from the Middle Awash valley, Ethiopia. *Nature* 298: 25–29.
- Kalb, J.E., Oswald, E.B., Tebedge, S., Mebrate, A., Tola, E., and Peak, D. 1982b. Geology and stratigraphy of Neogene deposits, Middle Awash valley, Ethiopia. *Nature* 298: 17–25.
- Kingdon, J. 1979. East African mammals. An atlas of evolution in Africa. In: J. Kingdon (ed.), *East African Mammals—an Atlas of Evolution in Africa*, 184–249. Academic Press, London.
- Kullmer, O. 1999. Evolution of African Plio-Pleistocene Suids (Artiodactyla: Suidae) Based on Tooth Pattern Analysis. *Kaupia Darmstädter Beiträg zur Naturgeschichte* 9: 1–34.
- Leakey, L.S.B. 1942. Fossil Suidae from Oldoway. *Journal of East African Natural Society* 16: 178–196.
- Leakey, L.S.B. 1958. Some East African Pleistocene Suidae. *Fossil Mammals of Africa* 14: 1–133.
- Made, J. v.d. 1991. Sexual bimodality in some recent pig populations and application of the findings to the study of fossils. *Zeitschrift für Säugetierkunde* 56: 81–87.
- Oliver, W.L.R. (ed.) 1993. *Pigs, Peccaries and Hippos*. 202 pp. IUCN, Gland.
- Pickford, M. 1994. Fossil Suidae of the Albertine Rift Valley, Uganda-Zaire. In: B. Senut and M. Pickford (eds.), *Geology and Palaeobiology of the Albertine Rift Valley, Uganda-Zaire. Vol. 2: Palaeobiology*, 339–373. CIFEG, Orléans.
- Randi, E., d’Huart, J.-P., Lucchini, V., and Aman, R. 2002. Evidence of two genetically deeply divergent species of warthog, *Phacochoerus africanus* and *P. aethiopicus* (Artiodactyla, Suiformes) in East Africa. *Mammalian Biology* 67: 91–96.
- Suwa, G., Nakaya, H., Asfaw, B., Saegusa, H., Amzaye, A., Kono, R.T., Beyene, Y., and Katoh, S. 2003. Plio-Pleistocene terrestrial mammal assemblage from Konso, southern Ethiopia. *Journal of Vertebrate Paleontology* 23: 901–916.
- van Hoepen, E.C.N. and van Hoepen, H.E. 1932. Vrystaate wilde varke. *Paleontologische Navorsing van die Nasionale Museum* 2: 39–62.
- Viehl, K. 2003. *Untersuchungen zur Nahrungsökologie des Afrikanischen Riesenwaldschweins (Hylochoerus meinertzhageni Thomas) im Queen Elizabeth National Park, Uganda*. 130 pp. Unpublished Ph.D. Thesis, Leibniz Universität Hannover, Hannover.
- Vrba, E.S. 1997. New fossils of Alcelaphini and Caprinae (Bovidae: Mammalia) from Awash, Ethiopia, and phylogenetic analysis of Alcelaphini. *Palaeontologia africana* 34: 127–198.
- White, T.D. 1995. African omnivores: global climatic change and Plio-Pleistocene hominids and suids. In: E.S. Vrba, G.H. Denton, T.C. Partridge, and L.H. Burckle (eds.), *Paleoclimate and Evolution with Emphasis on Human Origins*, 369–384. Yale University Press, New Haven.
- White, T.D. 2012. Phillip V. Tobias (1925–2012). *Science* 337: 423.
- White, T.D. and Harris, J.M. 1977. Suid evolution and correlation of African hominid localities. *Science* 198: 13–21.
- White, T.D., Asfaw, B., and Suwa, G. 2005. Pliocene hominid fossils from Gamedah, Middle Awash, Ethiopia. *Transactions of the Royal Society of South Africa* 60 (2): 79–83.
- White, T.D., Suwa, G., Hart, W.K., Walter, R.C., WoldeGabriel, G., de Heinzelin, J., Clark, J.D., Asfaw, B., and Vrba, E. 1993. New discoveries of *Australopithecus* at Maka in Ethiopia. *Nature* 366: 261–264.

## Appendix 1

Character matrix used in the cladistic analysis. ?: unknown, +: polymorphism

Character	0	1	2	3	4	5	6	7	8	9	10	11	12	13	14	15	16	17	18	19	20	21
<i>Kolpochoerus phillipi</i> sp. nov.	1	0	2	0	1	?	0	0	1	?	0	1	1	0	?	1	1	?	0	1	1	0
<i>Kolpochoerus afarensis</i>	1	1	1	?	1	0	0	0	?	?	0	?	?	0	?	1	0	0	0	0	0	0
<i>Kolpochoerus limnetes</i>	1	1	1	1	1	1	0	0	1	1	0	1	1	1	0	1	1	0	1	1	0	1
<i>Kolpochoerus olduvaiensis</i>	1	1	1	1	1	1	0	1	1	1	1	–	1	1	0	1	1	0	2	1	0	1
<i>Kolpochoerus majus</i>	1	0	2	0	1	0	1	1	1	1	1	–	1	1	1	1	1	1	0	1	1	0
<i>Potamochoerus</i>	0	1	0	0	0	0	0	0	0	0	0	1	0	0	0	1	0	0	0+1	0	0	0
<i>Hylochoerus</i>	0	0	1	0	0	0	1	1	0	1	1	–	1	1	1	0	1	1	2	1	1	0
<i>Sus scrofa</i>	0	0	0	0	0	0	0	0	0	0	0	0	0	0	0	0	0	0	0	0	0	0
<i>Babyrusa</i>	0	0	0	0	0	0	0	0	0	?	0	0	0	0	?	0	0	?	2	0	0	0

## Appendix 2

List of characters used in the cladistic analysis.

- Anterior part of male zygomatic arch in lateral view: (0) sub-horizontal; (1) strongly drooping.
- Orientation of zygomatic arch in dorsal view in males: (0) oblique (angle <math><90^\circ</math>); (1) transverse (angle ca. - Development of zygomatic arch in males: (0) thin; (1) latero-medially thickened zygomatic; (2) rounded knob.
- Relative cranium length: (0) relatively short (average - Angulation between rostrum and neurocranium: (0) absent; (1) present.
- Relative height of rostrum: (0) relatively high (average - Constriction of parietal roof posteriorly to orbital processes: (0) constricted (average - Development of rhinarium muscle scars: (0) well-marked scars; (1) reduced scars.
- Premaxillary proportions and inclination in males: (0) relatively narrow (average - Premaxillary proportions and inclination in females: (0) relatively narrow (average - Crest-like supracanine flange: (0) present; (1) absent.
- Supracanine flange dorso-ventral development: (0) low; (1) high.
- Supracanine flange antero-posterior development: (0) short; (1) elongated.
- Mandibular symphysis proportions in males: (0) relatively narrow (average - Mandibular symphysis proportions in females: (0) relatively narrow (average - Mandibular corpus swelling in males: (0) weak (average - Lower incisor arcade angle in males: (0) sharp incisor arcade (average angle - Lower incisor arcade angle in females: (0) sharp incisor arcade (average angle - Development of upper premolars: (0) P1 usually present and well-developed.; (1) P1 usually absent, P2 well-developed; (2) P2 reduced or even absent.
- Development of lower incisors: (0) i1 and i2 very long and parallel, forming a comb; (1) i2 smaller and oblique to i1.
- Mesio-distal compression of lateral pillars in molars: (0) not compressed; (1) compressed.
- Wear pattern of lateral pillars (labial and lingual walls): (0) always rounded; (1) tend to be flat.

## Appendix 3

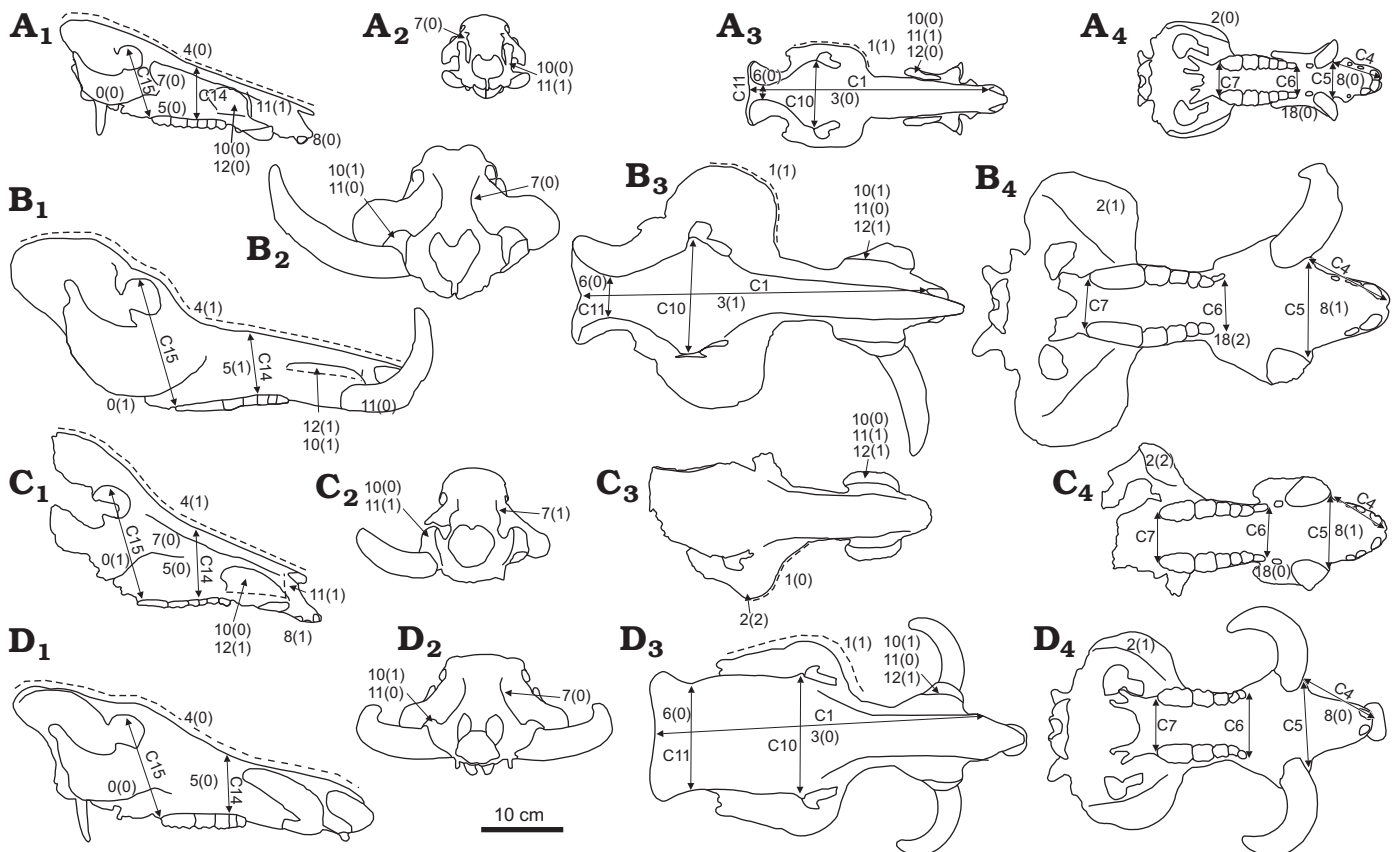

Cranial character states. Each cranium is schematically represented in lateral (1), anterior (2), dorsal (3), and ventral (4) views. **A.** *Potamochoerus larvatus* (MRAC 920). **B.** *Kolpochoerus olduvaiensis* (KNM-ER 788). **C.** *Kolpochoerus phillipi* sp. nov. (MAT-VP-1/5). **D.** *Hylochoerus meinertzhageni* (MRAC 17783). All specimens are males. Character 9 is coded in the same way as character 8, but on female specimens. Cranial measurements used to code characters are illustrated.

## Appendix 4

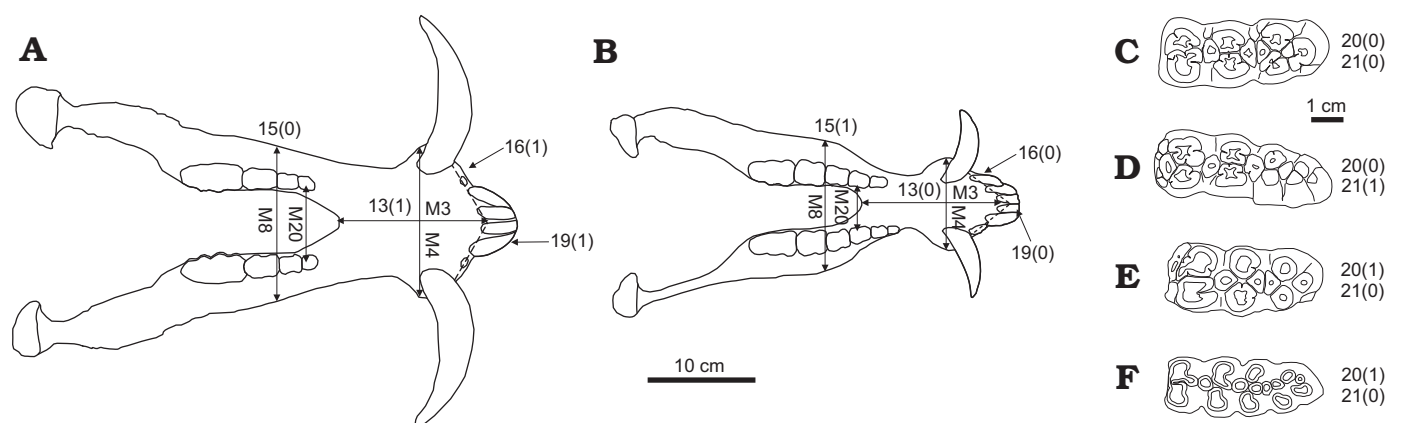

Mandibular and dental character states. Mandibles (A, B) and lower third molars (C–F) are schematically represented in dorsal and occlusal views, respectively. **A.** *Hylochoerus meinertzhageni*, male (MRAC 17783). **B.** *Potamochoerus* sp., male (MNHN-ZM-AC, no number). **C.** *Kolpochoerus limnetes* (OMO 18-1968-2104). **D.** *Kolpochoerus limnetes* (OMO 354-10004). **E.** *Kolpochoerus majus* (KL 251-2). **F.** *Hylochoerus meinertzhageni* (MNHN-ZM-AC 1951-208). Characters 14 and 17 are coded in the same way as characters 13 and 16, respectively, but on female specimens. Mandibular measurements used to code characters are illustrated.