



HAL
open science

Grid Compliance of Ocean Energy Converters: Control Strategies and Recommendations

Anne Blavette, Dara O'Sullivan, Michael Egan, Antony Lewis

► **To cite this version:**

Anne Blavette, Dara O'Sullivan, Michael Egan, Antony Lewis. Grid Compliance of Ocean Energy Converters: Control Strategies and Recommendations. 9th European Wave and Tidal Energy Conference, 2011, Southampton, France. <hal-01265988>

HAL Id: hal-01265988

<https://hal.science/hal-01265988v1>

Submitted on 1 Feb 2016

HAL is a multi-disciplinary open access archive for the deposit and dissemination of scientific research documents, whether they are published or not. The documents may come from teaching and research institutions in France or abroad, or from public or private research centers.

L'archive ouverte pluridisciplinaire **HAL**, est destinée au dépôt et à la diffusion de documents scientifiques de niveau recherche, publiés ou non, émanant des établissements d'enseignement et de recherche français ou étrangers, des laboratoires publics ou privés.



HAL Authorization

Grid Compliance of Ocean Energy Converters: Control Strategies and Recommendations

Anne Blavette^{#1}, Dara O'Sullivan^{#2}, Michael Egan^{*}, Antony Lewis[#]

[#]*Hydraulics & Maritime Research Centre, University College Cork
Pouladuff road, Cork, Ireland*

¹anne.blavette@gmail.com

²dara.osullivan@ucc.ie

^{*}*Electrical Engineering Department, University College Cork
Cork, Ireland*

Abstract— The potentially variable and intermittent electricity generated from wave and tidal energy may have some negative impact on the power quality of an electrical network. Impact assessment is usually performed by the use of power system simulators and appropriate numerical models of the electrical network components. However, standard generator models are unable to reflect some of the inherent features of ocean energy converters, in particular regarding power variability and intermittency. New numerical models for these devices must hence be created. This will be achieved using the generic modelling approach.

Another technical obstacle to the grid connection of ocean devices stems from the absence of strategy to make the devices grid compliant. This is partly explainable by the early development stage of most devices. However, although the current conditions that are required from ocean energy converters for being allowed grid connection are relatively permissive, they are expected to become more stringent in the near future. Complying with these requirements will make necessary the use of control strategies which still remain to be developed.

This paper concerns the control systems of near-term ocean energy converters from a grid compliance perspective. It details the main grid code requirements from a power quality and network stability perspective. Then, it presents some control strategies developed for complying with these requirements, as well as approaches for modelling them generically.

Keywords— grid code requirements, power quality, generic modelling, control

I. INTRODUCTION

The potentially variable and intermittent electricity generated from wave and tidal energy may have some negative impact on the power quality of an electrical network. This influence can be assessed through power system simulations which require numerical models of the electrical network components. However, the standard generator models are unable to reflect the inherent features of ocean energy converters, in particular regarding power variability and intermittency. Hence, there are no widely available models for ocean devices as yet. Without these models, no impact assessment studies can be carried out, what limits the grid-

connection to ocean farms of small power capacity only (from few megawatts to few tens of megawatts depending on the strength of the local network). The absence of numerical models is hence a barrier to the grid integration of ocean devices on a large scale.

Another technical obstacle to the grid connection of ocean devices stems from the absence of strategy to make the devices grid compliant. This does not represent a major issue at the present time, as the current conditions required of ocean energy converters are relatively permissive. However, when the number of grid-connected ocean devices becomes non-negligible, these conditions will inevitably become more stringent and will require the devices to be controlled actively. The relative immaturity of the ocean energy industry partly explains the absence of strategies regarding grid compliance. Most converters are currently at a testing stage with few of them experiencing offshore sea conditions. Considering this early stage of development, most developers have focussed their design work on the device performance and survivability in harsh environments. However, once devices have demonstrated their ability in these fields, the following step towards their commercialisation will involve validation of grid compliance. Grid compliance may be achieved by the use of control strategies which still remain to be developed. In conclusion, the impact assessment of near-term ocean energy farms requires developing and integrating these control strategies into the numerical models of ocean energy converters.

In summary, this paper analyses the control systems of ocean devices from a grid compliance perspective. After providing some background regarding the numerical modelling of ocean energy converters, it details the main existing grid code requirements which the devices will have most likely to comply with. Control strategies for achieving grid compliance have been developed and are explained in this paper. Finally, the paper details the generic modelling of these control strategies.

II. NUMERICAL DYNAMIC MODELLING OF OCEAN DEVICES

Understanding the real impact of ocean devices on the grid will help to gain confidence in this new technology. Impact

assessment studies are usually performed using power system simulators that reproduce numerically the dynamics of an electrical network. Standard dynamic numerical models of common electrical network components (such as generators, transformers, loads, etc.) are included within the simulators. However, the built-in generator models are unable to reflect the inherent features of ocean energy converters, in particular regarding power variability and intermittency. Hence, numerical models for ocean energy converters must be created.

Although the modelling of ocean energy converters is still in its infancy, this sector will benefit from the experience gained in the wind energy industry. The relative numerical instability of some wind turbine models, due to uncoordinated code programming, along with their unnecessary complexity [1] has led to the late appearance of standard, built-in models. Few numerically-reliable commercial models are actually available to date.

Generic modelling has emerged as an option to overcome these obstacles whose complexity is all the more increased by the broad diversity of ocean energy converter types. The structure of a generic model, common to most ocean energy converters, must be parameterisable by a minimum amount of device-specific data that developers have the ability to provide. Besides, a generic model should utilise generic system variables such as speed or power, instead of more device-specific variables, such as pressure or flow.

A recommendation for a generic model outline was published as the outcome of two developer surveys launched in the framework of the IEA-OES Collaborative Annex III, Workpackage 2. [2].

A. Survey Respondents

Seventeen developers took part in the first survey in 2009. The number of respondents doubled the year after as thirty-five developers took part in the second survey, including which involved 22 wave devices and 13 tidal devices. Besides providing information on the device control systems, the second survey confirmed the results obtained from the previous edition. Responses were received from various countries and regions including Europe, Canada, the USA and Russia. Similarly to the geographical origin of the respondents, the development stage of their devices was diverse, ranging from small-scale prototypes to pre-commercial units. As no leading technology has emerged as yet, this diversity in terms of development stage is considered to be beneficial to the relevance and to the impartiality of the study.

B. Results of the Surveys

The first survey focussed on the main characteristics of ocean energy converters. A recommendation for a generic model outline, as shown in Fig. 1, was released as an outcome of this work. The outline consists of a series of blocks representing the energy conversion or storage stages within the device. The ocean power capture is represented by the

primary power capture stage. The primary power capture component may be for instance a hydro-turbine, an OWC air chamber, an oscillating flap, etc. Ocean power is often converted into fluid power at the primary power capture stage. Where applicable, this power is stored in a fluid accumulator or hydro-reservoir. This type of energy storage is referred to as “inherent”, as it forms part of the inherent functionality of the device. The following block, the prime mover, represents the moving part of the system which is coupled to the generator rotor. This can be a turbine or hydraulic motor, for instance, and includes any gearing systems. A significant amount of energy may be stored at the prime mover stage as kinetic energy and is represented by the inertial energy storage block. The generator block represents the electrical part and any associated power converters. Some devices do not involve any fluid power along their energy conversion chain. They are referred to as “direct-drive devices”, and in their case, the primary power capture stage is merged with the prime mover. The inherent energy storage block is then deleted from the model.

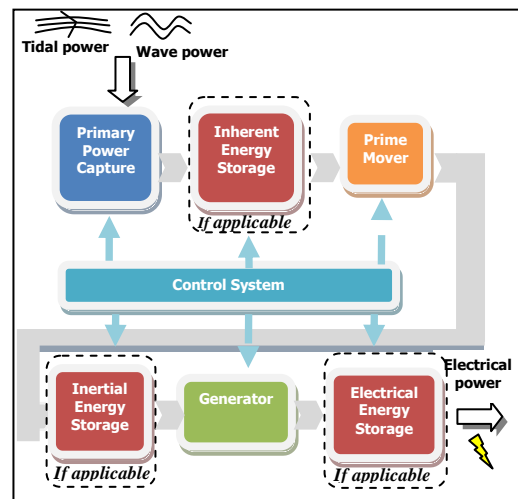

Fig. 1 Generic model outline as released from first survey

The second survey focussed on the control systems. It has highlighted the wide use of control means among various types of ocean energy converters for power optimisation and limitation. It has also stressed that the modelling of optimisation control is complex and needs further investigations. The challenges specific to the generic modelling of control systems include the confidential nature of these systems and their broad diversity.

Finally, the analysis report recommended including the following generic control elements in the model outline:

- primary power capture and prime mover efficiencies at different control operating points (both optimal and non-optimal states)
- response time for the optimisation of the primary power capture component
-
- power limitation limits and response time of the limitation mechanism

- primary power capture and prime mover efficiencies at different control operating points (both optimum and non-optimum states)
- response time for the optimisation of the primary power capture component
- generator/power converters control

- inherent and electrical storage charge/discharge rates and limits

- generator/power converters control

Although this type of data provides enough information to parameterise a generic model, it has the additional advantage that it does not reveal the technical means actually implemented within the device nor their strategy.

C. Further Analyses

Further analyses were carried out in order to complete the generic model, and in particular its control system. The initial generic model outline was refined as shown in Fig. 2. The blocks which may involve some means of control are circled in red.

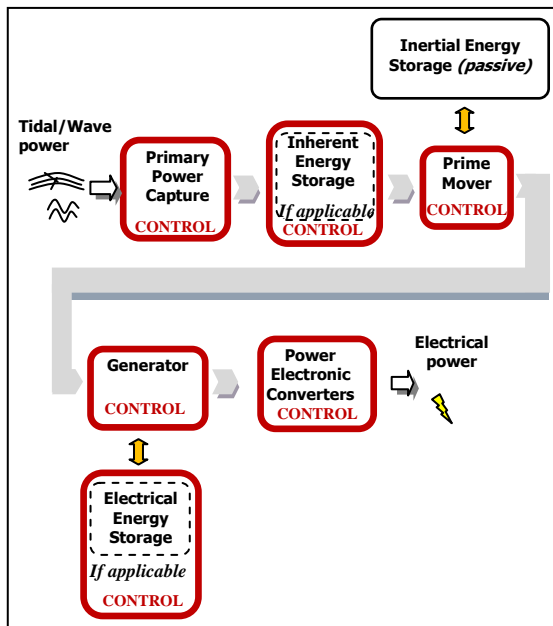

Fig. 2 Generic model outline

The second inertial energy storage block is represented in parallel with the prime mover block rather than in series with it, as previously shown in Fig. 1. The modelling in series may have suggested that the energy was stored in a storage component located between the prime mover and the generator, similarly to the inherent energy storage. However, as the energy at this stage is actually stored in the rotation of the prime mover itself, it is preferable to model this block in parallel with the prime mover block, even though the optimal operation of the generator may imply direct control of the

prime mover speed and hence influence the inertial energy storage, the inertial energy storage at this stage is considered as passive, as opposed to actively controlled. Similarly, the electrical storage block is represented in parallel with the generator block as only a fraction of the generator output power is stored in the storage unit(s) under normal grid conditions.

The last additional block represents the power electronic converters which may be used depending on the electrical system configuration. However, their utilisation will become necessary-effectively mandatory as the compliance of many devices with some grid code requirements will be achieved only by this means. The main grid code requirements will be detailed in the following section III.

III. GRID CODE REQUIREMENTS

Grid codes detail-define the requirements imposed on all types of grid-connected power plants. The objective of these requirements is to ensure-a safe and reliable operation of the network. Hence, complying with them is a mandatory step for power plants to be allowed grid connection.

The grid connection conditions for the ocean energy converters are currently quite permissive due to the small number of grid-connected devices. However, they will be more stringent in the near future when this number becomes non-negligible. The main requirements are presented in this section.

A. Power Quality

A device supplies power at a sufficient quality level when the fluctuations of its power output are considered as small enough not to interfere negatively with the local network. The required level of power quality is defined in grid codes. Power quality issues are usually investigated for wave devices only as their power output may actually reflect the high variability of wave power in the timeframe of seconds to minutes to a significant extent. In particular, oscillating devices with ~~no~~ small little or no energy storage capacity may require some control strategies in order to comply with the grid code requirements regarding power quality.

Apart from compliance with the power quality requirements, smoothing the power output of a wave or tidal device has additional advantages. First, reducing the amplitude of high mechanical power peaks contributes to decreasing the maximum stress on the drive train. Moreover, if power peaks of smaller amplitude are transmitted, the rating of power electronic converters may be decreased as well. This may reduce significantly the cost of this usually expensive piece of equipment which is very dependent on its rating.

B. Frequency Response Requirement

The frequency response requirement was issued for distribution generation units to ~~mimic~~ emulate the behaviour of the conventional, directly-connected synchronous generators regarding short-term network stability.

In the days when distributed generation from renewables was negligible, the stability of the network in the timeframe of seconds to minutes was maintained as a result of the natural behaviour of conventional generators. Their electricity production varies with respect to the network frequency, whose variations from its nominal value indicate a certain level of power imbalance in the network. Hence, they act as an automatic control system which contributes to maintaining the network stability. For instance, the network frequency rises if the ~~global~~ total active power generation exceeds the electrical consumption. This network frequency increase induces mechanically a decrease in the active power supplied by the generators, ~~what~~ which contributes to stabilise the system. Similarly, more active power is automatically generated if the network frequency decreases. This behaviour allows some time for the grid operator to shut some power plants down or to start them up. The short-term network stability is entirely based on this principle. However, the generator configuration of renewable power plants, in particular of wind turbines and of ocean devices, is radically different. They generally use, or are envisaged to use, power electronic converters that decouple the generator frequency from the network frequency. The generator is thus not directly influenced by the network frequency and is consequently unable to reproduce the frequency-based behaviour of synchronous generators.

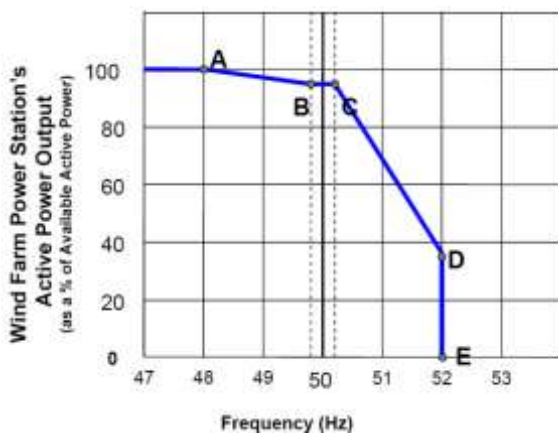

Fig. 3 Frequency response requirement [3]

Considering the significant and ever increasing number of grid-connected wind turbines, they would have constituted a stability threat if not taking an active part in maintaining the network stability in similar fashion to conventional power plants. Hence, grid operators now require them to ~~mimic~~ emulate artificially the behaviour of directly-connected synchronous generators, what is defined as the “frequency response requirement”. Fig. 3 shows the graphical description of this requirement as detailed in the Irish distribution code [3]. The power plant is required to supply a given percentage of its ~~nominal~~ available active power ~~with respect to~~ as a function of

the network frequency. This requirement, issued originally for wind turbines, will likely be applied to ocean energy converters as well.

C. Fault Ride-Through

Similarly to the frequency response requirement, the fault ride-through requirement was originally issued from the perspective of wind energy grid integration. It requires wind turbines to stay connected in the event of a fault under certain conditions. A fault, for instance a short-circuit, causes a local voltage dip of variable amplitude and period which may disturb the normal operation of power plants in general, and of wind turbines in particular. This could lead them to disconnect from the network. However, the sudden disconnection of a large number of wind turbines could increase the impact of the initial fault on the network and induce widespread network collapse. Hence, the fault ride-through requirement ensures that wind turbines, by staying connected under certain conditions, do not compromise further the stability of the network nor its recovery.

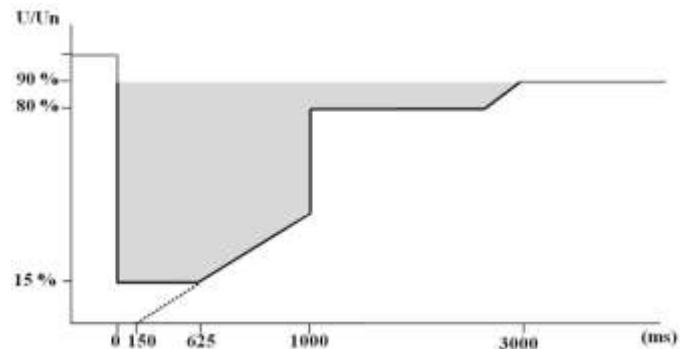

Fig. 4 Fault ride-through requirement [3]

The grey-shaded area in Fig. 4 shows the time duration during which wind turbines are required to remain connected. It is determined with respect to the voltage dip amplitude. This requirement is expected to be applied also to ocean energy converters once the number of grid-connected devices is considered as non-negligible.

IV. GRID COMPLIANCE CONTROL STRATEGIES

Most converters are currently at a testing stage with few of them ~~experiencing~~ operating under actual offshore sea conditions. Considering this early stage of development, most developers have prioritised their design work on the device performance and survivability in harsh environments. Complying with grid code requirements has generally not been considered, although it is mandatory for devices to be allowed grid-connection. Grid compliance can be achieved by controlling devices actively and by the addition of energy

storage when necessary. Control strategies have been developed and are described in this ~~section IV~~section.

A. Power Quality

The ~~high-large~~ short-term variability of wave power may be reflected in the electrical power supplied by wave devices. However, it is important to reduce the amplitude of large fluctuations in order to comply with the power quality requirements. This can be achieved at the primary power capture, storage and generator stages as described in the following sections.

~~1) Similarities of Some Control Strategies:~~

The common objective of control strategies regarding ~~the~~ power quality is to supply the network with electricity whose fluctuation amplitude is acceptable. Its implementation consists of adapting the device characteristics with respect to the fluctuation amplitude, in order to smooth these fluctuations efficiently. In the case of wind power, this information regarding the fluctuations would be provided to wind parks central controller by voltage measurement at some point of the local network, preferably at the point of common coupling (PCC). In the case of ocean energy~~Alternatively~~, the detection of large fluctuations by the control systems ~~could also~~ be based on one of the following signals:

- wave height (either predicted or measured by the device itself)
- power output at different stages of the device
- prime mover speed

As mentioned in the previous paragraph, wind turbines' or farms' power quality control is directly based on the measured voltage. This strategy can hence be qualified as "corrective" as it intends to mitigate some fluctuations which have already been transmitted to the network. However, preventing the occurrence of these large voltage fluctuations would be more beneficial from a power quality perspective.

Both approaches have their advantages and drawbacks. The corrective approach is implementable at all stages of the energy conversion chain. Besides, it is based on a simple closed loop system, which makes its implementation relatively easy. However, this approach cannot be optimal as it is based on past wave fluctuations, which might be very different from the incoming fluctuations. Besides, the corrective approach would fail completely in the event of a single high wave as it is relevant only in the occurrence of a group of high fluctuations. Moreover, it cannot prevent the transmission of the first fluctuation to the network. However, this approach may be the only one implementable in most cases at the primary power capture stage.

Contrary to the corrective approach, the objective of the preventive approach is to ensure that no large fluctuation is transmitted to the network. However, it may not always be possible to obtain data of the incoming fluctuations in practice,

in particular at the primary power capture stage. Besides, this approach is based on estimations regarding the theoretical amplitude of the fluctuations that would be transmitted to the network. Hence, it may require an accurate calibration of the algorithms with respect to the local network and under several grid loading conditions, which may be complex. Such a "preventive" approach having not been developed as yet, the corrective approach remains the primary option at this stage, although both will be addressed in this paper. These approaches can be implemented at the following stages of the device energy conversion chain.

~~2) 1) Primary Power Capture:~~

Fluctuations can be significantly reduced by controlling the efficiency of the primary power capture component. The efficiency at this stage is generally controlled for achieving a maximum power capture, sometimes for each incoming wave. However, using this strategy may deteriorate the power quality significantly in the occurrence of high amplitude waves. Hence, a constraint should be applied to this traditional strategy. It should intend to optimise the efficiency of the primary power capture component provided that the amplitude of the induced electricity fluctuation remains below a certain limit.

In order to prevent the transmission of high power peaks, the primary power component may decrease its efficiency deliberately in the occurrence of large fluctuations of power or prime mover speed. For instance, the damping level of the device may be modified or the ~~exposition-exposure~~ of the device to the sea conditions may be reduced, for instance by increasing the immersion depth of devices based on the submerged point absorber design, or by pitching the blades of a hydro turbine.

The new efficiency reference must be carefully selected. Ideally, it should allow the device to extract a maximum amount of energy while taking into account the fluctuations constraints. Besides, adapting the device to the new efficiency reference should also require a minimum amount of energy from the system and enable it to come back to its initial efficiency in a minimum amount of time.

Such control at the primary power capture stage is intended for wave devices, and in particular for resonating devices having ~~no-or-small~~little or no storage capacity. The implementation of such strategy is irrelevant for overtopping devices, which are by definition equipped with a large reservoir that inherently smoothes the wave-to-wave variations.

~~3) 2) Inherent and Electrical Storage:~~

Storage is currently considered as the most common way to smooth the wave power fluctuations and hence to improve its quality. Although storage systems are usually passive, controlling them actively could significantly enhance the power quality.

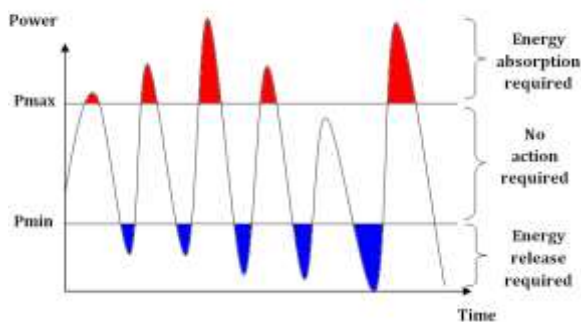

Fig. 5 Action required from storage units

This can be achieved by smoothing power peaks and troughs in order to maintain power at around an average value, as shown in Fig. 5. The upper and lower power limits are determined based on the voltage limits detailed in the grid codes and on a sufficient voltage security margin with respect to these limits. The relation between power level and grid voltage depends on the network configuration, on its strength and on its loading conditions at a given time. The loading conditions varying negligibly over the duration of a sea-state, the power limits can hence be considered as constant during a simulation.

Methods of energy storage control involve switched banks of energy storage units with uncontrolled charging and discharging, or controlled charge and discharge rates to a single energy storage device (using controllable actuators such as valves or PWM-switched circuits).

The control strategy implying the use of several storage units would consist in allowing selected units to charge (or to discharge) when power or voltage reach defined limits, either maximal or minimal. ~~However, under normal power or voltage conditions, the storage units would be "disconnected" from the energy conversion chain, preventing hence any useless charge or discharge.~~ This can be achieved by means of power transistors which can (dis)connect batteries or ultra-capacitors from an electrical circuit, or by means of valves which have a similar role for gas accumulators or other hydraulic-type storage units. In this case, the charge and discharge rates depend on the difference of potential (e.g. pressure or voltage) between the storage unit and the external environment. This technique requires developing less complex algorithms than the second method detailed in the following paragraph. Besides, utilising a number of switched units can improve the overall lifetime of the energy storage system by only utilising the number of units required at any given time.

The same power transistors and valves can be used to control the energy flow into and out of the energy storage units and hence control the charge and discharge rates of a storage unit. By enhancing the controllability of the storage units, this technique may be more efficient regarding the maintenance of power at a sufficient quality level. However, it may require developing complex optimisation methods.

Both of these methods are based on modifying the resulting charge or discharge rate of the energy storage system, which may be constituted of one or more storage units. Ideally,

in the case of a power peak, the resulting charge rate would match exactly the excess of power. Similarly, the resulting discharge rate would equal the power deficit in the event of a power trough. In reality, due to control limits, a resulting charge or discharge rate matching exactly the power excess or deficit may not always exist. For instance, if the resulting charge or discharge rate were smaller than the power excess or deficit, then the incoming power peak or trough could be insufficiently attenuated. On the other hand, if the resulting charge or discharge rate were higher, then a power trough or peak of significant amplitude could be subsequently created.

~~Other criteria in the control of the energy storage system are the required lifetime of the energy storage elements and the current storage level of the units. These will further determine the controllability of the storage units at any given point in time.~~

Clearly, another criterion in the control of the energy storage element is the current storage level of the unit. Furthermore, lifetime limitation due to over-cycling may also be a concern.

4-3) Generator:

Control of the generator electrical torque is already widely used for controlling ~~fluctuations- variations in of~~ the prime mover speed, ~~which canthus absorbing and releasing mechanical energy to smooth fluctuations from the primary source, absorb and release more smoothly peaks of the incoming energy~~ This improves the output power quality by contributing to reduce electrical power fluctuations. Such strategies already exist [4-5], and hence they will not be addressed further in this paper.

5-4) Power Electronics Converters:

Control of the reactive power Q via power electronic converters is also used for maintaining the voltage within allowed limits. Such strategies have already been developed in the context of wind turbines [6] and ocean energy converters grid-connection [7], so they will not be addressed in this paper.

B. Frequency Response

The compliance with the frequency response requirement can be achieved by controlling the efficiency of the primary power capture component. Varying its efficiency with respect to the network frequency is equivalent to varying the power output of the device with respect to this parameter.

C. Fault Ride-Through

The poor fault ride-through capability of old wind turbines using directly-connected generators has demonstrated the necessity to use power electronic converters. For ocean energy converters, it is likely that power electronic converters will

also be required to fulfil this function. Also, during a fault, the capacity of the grid to absorb power is significantly reduced. Thus, the absorption efficiency of the device must be decreased. This can be achieved by setting the efficiency reference of the primary power capture stage to its minimum value. Considering the short durations during which devices would be required to stay connected (maximum 3 s in the Republic of Ireland [3]), the efficiency may not reach its reference value during the fault, due to usually slow-changing mechanisms. However, this strategy would induce a significant decrease in the efficiency, which improves the fault ride-through capability of a device. Energy storage means may also be utilised. Its energy absorption capacity would be increased by setting its reference charge rate to its maximum value. Similarly to the modification of the primary power capture efficiency, faults would usually be cleared before the charge rate reaches its reference, but this strategy would at least lead to a fast increase of this value, which is beneficial from a fault ride-through capability perspective as well. It is also required to provide reactive power to the grid for the duration of the fault. This is usually accomplished with power electronic converters or other devices such as Static Var Compensators (SVC). When the fault is cleared, the application of the control strategies mentioned in this section is suspended.

V. GENERIC MODELLING OF CONTROL STRATEGIES

Control strategies are very specific to a given technology and may be very different. In addition, these control strategies are usually kept confidential: very little data ~~is~~ is revealed by developers, which ~~what~~ increases further the ~~difficulty in achieving the generic system modelling complexity of the control systems generic modelling~~. This section provides some guidelines towards the generic modelling of control strategies for grid compliance.

A. Generic Control Laws

Control systems typically consist of several interconnected control laws. ~~They dictate the behaviour of control mechanisms, such as valves for instance. However, the algorithms confidentiality and their need for device specific information prevent their direct implementation in a generic model. Hence, generic control laws must be developed.~~ Contrary to these original control laws, representative generic control laws must not—they must not use device-specific system variables such as pressure or flow. ~~On the contrary~~ In contrast, they must reflect the impact of the control strategies on the generic system variables such as power or prime mover speed.

One option is to model the control laws by means of polynomials whose coefficients may be adapted for each device. The coefficients could be determined by the developer from the device characteristics graphs or from tank and sea-

testing. Representing the impact of control strategies rather than implementing the original control laws provides the additional advantage of not revealing confidential information.

Should the definition of the control law be too complex to be modelled by one polynomial only, several polynomials may be used as illustrated by the following equation:

$$\begin{cases} T_{ref} = A_0 * N + A_1 * (N - N_{avg}) & \text{if } N > 1.1N_{ref} \\ T_{ref} = 0 & \text{if } 1.1N_{ref} > N > 0.9N_{ref} \\ T_{ref} = -T_{max} & \text{if } 0.9N_{ref} > N \end{cases} \quad (1)$$

where T_{ref} is the electrical torque reference, A_0 and A_1 are constant parameters, N is the instantaneous speed, N_{avg} its average and N_{ref} is a reference speed. As shown in the example, the average or any other usual function of a variable may be used in order to allow more flexibility to the generic control laws. In practice, a minimum number of generic control laws must be developed. The main control laws will be implemented in the device generic model and be activated or deactivated depending on the device to be modelled. The following sections describe the generic modelling of the control strategies previously described in section IV.

B. Modelling of Power Quality Control

This section describes the generic modelling of the different control laws regarding the device compliance with the power quality requirements presented in section IV.A.

The red-circled blocks in Fig. 6 recall which of them are involved in control strategies regarding the power quality.

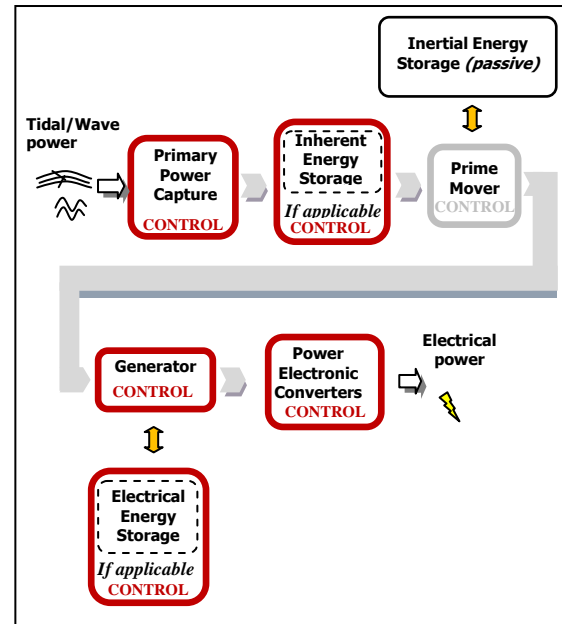

Fig. 6 Stages of the energy conversion chain involved in control strategies regarding the power quality

1) Primary Power Capture:

The strategy proposed for improving the power quality at this stage ~~intends to decrease~~ is based on decreasing the efficiency of the primary power capture component in the occurrence of high power fluctuations. The efficiency decrease must be sufficient so that only power peaks of minor amplitude are transmitted to the network. The control strategy can be modelled generically by the following process:

1) High power fluctuations are detected by the control system.

2) It must be determined whether the efficiency of the primary power capture component needs to be modified. The answer is positive in the case of control systems based on the corrective approach, but the question must be studied for those based on the preventive approach. Devices involving the corrective approach must skip step 3 and continue the process from step 4.

3) Calculations are performed to evaluate the theoretical power fluctuation that may be transmitted with respect to the current system configuration. If the amplitude of the theoretical fluctuations is acceptable, the device remains as it is. Otherwise, the efficiency of the primary power capture stage must decrease.

4) Calculations are performed to select the new efficiency reference among the graphs or data sets available for optimal and non-optimal conditions, and with respect to the current sea conditions. The selected efficiency must be as close as possible ~~from-to~~ the initial efficiency, ~~what-which~~ represents the constraint regarding the minimisation of energy required from the system to adapt the primary power capture component as explained in section IV.A.1). For instance, in the case of an oscillating device, this will represent the fact that the nearest damping level is select~~ed~~ so as to minimise the energy losses and time delay for the adaptation of the system as illustrated in Fig. 7.

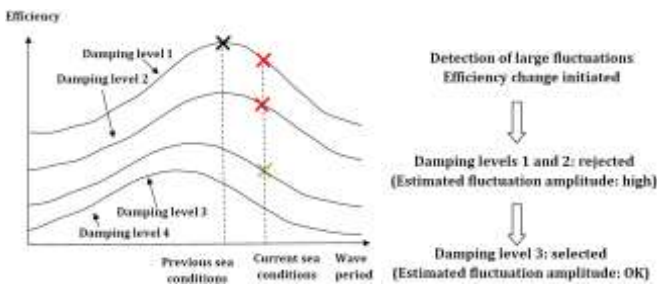

Fig. 7 Illustration of the control strategy applied to a resonating wave device

2) Inherent and Electrical Storage:

The active control of the storage units intends to maintain power quality at an acceptable level with respect to the grid code requirements. This strategy relies on the optimal control of the storage system, constituted of either one or more storage units, whose charge and discharge rates may be

controlled or not. The storage system resulting charge or discharge rate enables the power to remain within allowed limits, as shown in Eq. 2:

$$P_{min} \leq P - P_{opt} \leq P_{max} \quad (2)$$

where P_{opt} is the resulting charge or discharge rate of the energy storage system.

Any storage unit can be represented by its energy storage level, and its charge and discharge rates at any time t . However, in the case of inherent storage unit, the determination of these variables may require information on physical variables such as hydraulic pressure and fluid volume within the storage unit at any time t . These variables can be sensitive from a confidentiality point of view and are usually avoided in the design of a generic model. Alternatively, this data can be processed so that no confidential information can be extracted out of it. This can be achieved by adopting the per unit system for both volume and pressure, as shown in Eq. 3:

$$X_{pu} = \frac{X_{actual}}{X_{basis}} \quad (3)$$

The basis, called X_{basis} , reveals information on the order of magnitude of commonly-used variable X_{actual} . By using X_{pu} , this information is left concealed.

The storage unit can hence be represented by an approximate physical model based on these per unit variables and on physical equations to represent the variations of volume and pressure within the storage unit. The external pressure, expressed in the same per unit system as the storage unit, can be determined by means of a transfer function linking this variable and the water-level elevation. This transfer function can be obtained with tank or sea-testing.

The energy filling level at time t , formulated in Joules, can be determined from the initial energy level, the maximum energy capacity of the storage unit and from the energy charged and discharged until time t . This quantity of energy can be easily calculated from the charge and discharge rates at each time step multiplied by the time step duration. A cycle efficiency must also be included to represent the cycle loss of the system. As for the electrical energy storage unit, some models are already available in power system simulators.

The selection of P_{opt} relies on the complex optimisation of several parameters which include for instance the energy capacity of the storage unit, the control system energy consumption minimisation, and the minimisation of equipment failure.

3) Generator:

The generator electrical torque control intends to reduce the electrical power fluctuations by controlling the prime mover speed. Already existing control laws can generally be represented by a polynomial function that usually links the

torque reference with the prime mover speed. Alternatively, the torque reference may be determined with respect to the power fluctuations at each stage of the device or with respect to the wave height.

4) Power Electronic Converters:

Reactive power control is achieved by power electronic converters. Control laws relative to this strategy have already been developed and, in similar fashion to generator control laws, they may be modelled by means of a polynomial function linking the reactive power with the voltage.

C. Modelling of Frequency Response Control

The control strategy regarding the frequency response requirement is based on the control of the primary power capture component efficiency. It may be modelled generically by the following process:

1) The network frequency changes significantly, what modifies the active power reference. The active power of the device must hence vary accordingly.

2) The primary power capture stage contains graphs or data sets on its component efficiency for several sea conditions and under optimal and non-optimal conditions. There exist several efficiency values for given sea conditions, among which one is optimal. The efficiency values for the current sea conditions are selected.

3) Calculations are performed using each of the selected efficiency values in order to determine the electrical power output in each case. The current system parameters, such as the efficiencies at the following stages, are used for the calculations.

4) The primary power capture efficiency leading to the smallest difference between the current electrical power output and its reference is selected.

5) The actual electrical power output is compared to its estimated value after the new efficiency value is selected. It is actually possible that the change in the primary power capture efficiency leads to a non-negligible change in other parameters of the system, such as the prime mover speed for instance. This could have an impact on the electrical power output and hence lead to a significant difference between the estimated power output and the actual power. However, it is likely that only small changes in the device characteristics will be implied, as the network frequency is usually quite stable. Hence, a second iteration is likely not to be required in most cases. However, if an additional iteration is needed, the process should be performed again from step 2.

If the network frequency changes significantly during the iteration process, it must be performed again from step 1.

D. Modelling of Fault Ride-Through Capability

It was mentioned in section IV.C that the fault ride-through capability may be enhanced by means of active control of the primary power capture component, that is by reducing its efficiency appropriately, and/or by the use of sufficient energy storage means. Hence, this must be modelled at one or both of the stages mentioned above. In the event of a fault, the precedence of the fault-mode control strategies over the ones applied under normal conditions would be modelled by activating the former and deactivating the latter.

One option consists of changing the efficiency of the primary power capture component to its minimum value. The behaviour of slow-changing mechanisms may be modelled by decreasing the efficiency in a linear fashion over an average time Δt . The charge rate increase of storage means may be modelled in similar fashion. Then, a simple connect/disconnect algorithm would leave the device connected under the conditions relative to the fault-ride through requirement.

VI. CONCLUSIONS

The paper has presented an overview of the technical abilities required from ocean energy devices control systems from a grid compliance perspective. It has detailed the challenges relative to this topic and proposed some control strategies to overcome them. Then, it has explained how these control strategies could be modelled generically in order to be integrated into a generic model for power system studies.

The current absence of control strategies regarding grid compliance seems to indicate that this topic is considered at a late stage in the device design process. However, these control strategies, and the additional equipment they might potentially require, may have a great impact on the device design itself. Modifications of the original design can require a considerable amount of additional work. Hence, in order to accelerate the development process of ocean energy converters in general, the ocean energy industry should consider the grid compliance issue at the preliminary stages of the device design.

ACKNOWLEDGMENT

The first and second authors wish to acknowledge the Science Foundation Ireland-Charles Parsons Initiative for funding their research work.

REFERENCES

- [1] Y. Coughlan, P. Smith, A. Mullane and M. O'Malley, *Wind Turbine Modelling for Power System Stability Analysis—A System Operator Perspective*, 2007.
- [2] D. O'Sullivan, D. Mollaghan, A. Blavette and R. Alcorn, *Dynamic characteristics of wave and tidal energy converters & a recommended structure for development of a generic model for grid connection*, a report prepared by HMRC-UCC for the OES-IA Annex III. [Online], Available: www.iea-oceans.org. (2010)

[3] ESB Distribution Code, applicable in the Republic of Ireland, 2007

[4] D. B. Murray, M. G. Egan, J. G. Hayes and D. L. O'Sullivan, *Applications of Supercapacitor Energy Storage for a Wave Energy Converter System*, EWTEC, 2009

[5] P. A. P. Justino, A. F. de O. Falcão, *Rotational Speed Control of an OWC Wave Power Plant*, J. Offshore Mech. Arct. Eng. -- May 1999 -- Volume 121, Issue 2, 1999

[6] M. Machmoum, A. Hatoum, T. Bouaouiche, *Flicker mitigation in a doubly fed induction generator wind turbine system*, 2010.

[7] A. J. Nambiar, A. E. Kiprakis, D. I. M. Forehand and A. R. Wallace, *Effects of array configuration, network impacts and mitigation of arrays of wave energy converters connected to weak, rural electricity networks*, 3rd International Conference on Ocean Energy, 2010