



**HAL**  
open science

# INTEGRATING WAVE AND TIDAL CURRENT POWER: Case Studies Through Modelling and Simulation

M. Santos, F. Salcedo, D. Ben Haim, J. L. Mendia, P. Ricci, J.L. Villate, J.  
Khan, D. Leon, S. Arabi, A. Moshref, et al.

► **To cite this version:**

M. Santos, F. Salcedo, D. Ben Haim, J. L. Mendia, P. Ricci, et al.. INTEGRATING WAVE AND TIDAL CURRENT POWER: Case Studies Through Modelling and Simulation . [Research Report] Document No: T0331, International Energy Agency Implementing Agreement on Ocean Energy Systems 2011. hal-01265985

**HAL Id: hal-01265985**

**<https://hal.science/hal-01265985>**

Submitted on 1 Feb 2016

**HAL** is a multi-disciplinary open access archive for the deposit and dissemination of scientific research documents, whether they are published or not. The documents may come from teaching and research institutions in France or abroad, or from public or private research centers.

L'archive ouverte pluridisciplinaire **HAL**, est destinée au dépôt et à la diffusion de documents scientifiques de niveau recherche, publiés ou non, émanant des établissements d'enseignement et de recherche français ou étrangers, des laboratoires publics ou privés.

**International Energy Agency Implementing Agreement on  
Ocean Energy Systems**

**INTEGRATING WAVE AND TIDAL CURRENT POWER:  
Case Studies Through Modelling and Simulation**

**March 2011**

**A report prepared by  
Tecnalia, Powertech Labs and HMRC**

**As part of the OES-IA Annex III Collaborative Task on  
Integration of Ocean Energy Plants into Electrical Grids**

**OES-IA Document No: T0331**



# **INTEGRATING WAVE AND TIDAL CURRENT POWER: Case Studies Through Modelling and Simulation**

**OES-IA Annex III Technical Report**

**OES-IA Document No: T0331**

## **Operating Agent:**

Gouri Bhuyan, Powertech Labs, Canada

## **Authors:**

Maidor Santos Múgica, Tecnalia, Spain

Fernando Salcedo Fernandez, Tecnalia, Spain

David Ben Haim, Tecnalia, Spain

Joseba Lopez Mendia, Tecnalia, Spain

Pierpaolo Ricci, Tecnalia, Spain

Jose Luis Villate Martínez, Tecnalia, Spain

Jahangir Khan, Powertech Labs, Canada

Daniel Leon, Powertech Labs, Canada

Saeed Arabi, Powertech Labs, Canada

Ali Moshref, Powertech Labs, Canada

Gouri Bhuyan, Powertech Labs, Canada

Anne Blavette, HMRC, Ireland

Dara O’Sullivan, HMRC, Ireland

Ray Alcorn, HMRC, Ireland

## **Availability of the Report:**

A PDF file of this report is available at: [www.iea-oceans.org](http://www.iea-oceans.org)

## **Suggested Citation for the Report:**

M. Santos, F. Salcedo, D. Ben Haim, J. L. Mendia, P. Ricci, J.L. Villate, J. Khan, D. Leon, S. Arabi, A. Moshref, G. Bhuyan, A. Blavette, D. O’Sullivan, R. Alcorn; (2011). Integrating Wave and Tidal Current Power: Case Studies through Modelling and Simulation, A report prepared jointly by Tecnalia (Spain), Powertech Labs (Canada) and HMRC (Ireland) for the OES-IA. Available: [www.iea-oceans.org](http://www.iea-oceans.org)

## **DISCLAIMER**

The OES-IA, also known as the Implementing Agreement on Ocean Energy Systems, functions within a framework created by the International Energy Agency (IEA). Views, findings and publications of the OES-IA do not necessarily represent the views or policies of the IEA Secretariat or of all its individual member countries.

The reader is encouraged to consult with relevant references and external sources.

Various device names, technologies, software and hardware systems cited in this report may represent trade names and the TM symbol is not used. These trademarks should be treated accordingly.

## **FOREWARD**

The International Energy Agency (IEA) is an autonomous body within the framework of the Organization of Economic Co-operation and Development (OECD), which carries out a comprehensive program of energy co-operation among different countries. The Implementing Agreement on Ocean Energy Systems (OES-IA) is one of the several IEA collaborative agreements within the renewable energy domain.

This report has been prepared under the supervision of the Operating Agent for the OES-IA Annex III on Integration of Ocean Energy Plants into Distribution and Transmission Grids based on cost-shared and task-shared collaborative activities. The report provides valuable information to various stakeholders, including the members of the OES-IA, and presents case studies demonstrating integration of wave and tidal current power generating plants to distribution grids, as well as to a larger power system at the transmission level, considering various long-term scenarios.

*Dr. John Huckerby*  
Chair, OES-IA ExCo

*Dr. Gouri Bhuyan*  
Operating Agent, Annex III

## ACKNOWLEDGEMENTS

The OES-IA member countries that are participating in the work program of the Annex are Canada, Ireland, United Kingdom, Spain and New Zealand. Funding for the overall management of the Annex activities was provided by Powertech Labs, the UK Department of Energy and Climate Change (DECC), Tecnalia of Spain and AWATEA of New Zealand.

The participating organisations and the corresponding enabling funding contributors for this Annex are as follows:

Powertech Labs with direct and indirect financial contribution from BC Hydro and Powertech Labs, Canada; Bonneville Power Administration (BPA), USA; Oregon Wave Energy Trust (OWET), USA; and Asia Pacific Partnership (APP) Program of Environment Canada.

Hydraulic Maritime Research Centre (HMRC) with financial contribution from the Sustainable Energy Authority of Ireland (SEAI), and Science Foundation Ireland under the Charles Parsons Initiative.

Tecnalia with direct financial contribution from Ente Vasco de la Energía (EVE).

The Tecnalia authors wish to acknowledge Ana Morales from DIgSILENT Iberica, S.L. for her help with the simulation models.

The Powertech authors acknowledge contributions from John Schaad and Sara Sundborg of BPA; Mark Tallman and Dennis Desmarais of PacifiCorp; Pat Ashby of Tillamook PUD; Mike Wilson and Joseph Monsanto of Central Lincoln PUD; Dave Sabala and Todd Sherwood of Douglas Electric Cooperative; Kevin Watkins of PNGC Power; Vickie VanZandt of Ecofys; and Justin Klure and Therese Hampton of Pacific Energy Venture for enabling the case study, reported in section 3.3 of this report. Also, contributions from Kang Won Lee of DAEHWA Power Engineering Co., Ltd., Republic of Korea, and Seung Hee Kim of KEPCO, Republic of Korea, towards providing the required information on the Korean system for the case study discussed in section 3.4 of this report are acknowledged. Technical contributions by Frederic Howell and Xi Lin from Powertech Labs Inc. for providing assistance toward developing and implementing the tidal current and wave energy conversion models into DSATools are greatly appreciated.

Thanks to James Griffiths for his technical help to the HMRC team. Valuable inputs provided by Michael Egan during the program as well as in drafting and producing certain part of this report are acknowledged.

Special thanks to Hannele Holttinen of VTT Technical Research Centre of Finland, and John Pease, John Schaad, Nic Peck and Paul Fiedler of BPA for their expert review of the document. Also, efforts made by Ana Brito Melo of Wave Energy Centre, Portugal, and John Huckerby of AWATEA, New Zealand, in reviewing the report are very much appreciated.

## EXECUTIVE SUMMARY

---

Ocean renewable energy is an emerging resource option. In the long term, ocean renewable energy has the potential to provide a significant share of global energy needs. Currently, some of the conversion technologies for harnessing variable wave and tidal current energy resources are reaching commercial stage. Several pilot projects, having sizes upto 2 MW, are operating in various parts of the world. Also multi-MW wave and tidal current energy farms are being developed. Identification of the near- and longer-term technical potential of wave and tidal current resources that could be integrated to existing and future electricity infrastructure in a region is an important step towards developing integrated long-term energy planning for the region and relevant policy instruments to realize the potential.

During the past three years, a collaborative project related to integration of wave and tidal current energy into electrical systems (known as Annex III) was carried out under the umbrella of the International Energy Agency’s Implementing Agreement on Ocean Energy Systems (OES-IA) ([www.iea-oceans.org](http://www.iea-oceans.org)). Following the completion of the Work Packages 1 and 2 under the Annex III of IEA’s Ocean Energy Implementing Agreement, a number of landmark activities took place within the emerging global ocean energy sector. This report summarizes the work performed through the Work Package 3 activities. The report provides insight into the grid integration of wave and tidal current resources, particularly through case studies spanning a wide range of scenarios. In particular, the following case studies are presented in this report:

Case Study	Country	Generation Level (MW)	Time Horizon	Project Type	Conversion Device	Case Study Focus	Integration Level
Biscay Marine Energy Platform ( <i>bimep</i> )	Spain	20	Near-term (2011)	Multi-unit pilot	Generic wave	Power quality	Distribution
Belmullet Wave Test Site	Ireland	5	Near-term (2011)	Multi-unit pilot	Generic wave	Power quality	Distribution
Oregon Coasts	USA	~500	Long-term (~2019)	Wave farm	Generic wave	System planning and deployment potential, adequacy of on-shore infrastructure	Transmission
Korean Country-wide	Republic of Korea	~ 2000	Long-term (~2022)	Tidal and wave farm	Generic tidal and wave	System planning and deployment potential	Transmission

Prior to discussing these case studies, a number of generic power system related aspects (such as system control, stability, power quality, grid codes, etc.) are highlighted in this report. In addition, brief discussions are presented on wave and tidal resource variability/predictability, offshore farm layout, system control and characteristics, plant location (in contrast to the location of load centers, network topology, etc.).

The following summary can be drawn upon from the studied cases:

#### **Distribution Integration (Spain, Ireland):**

- The developed case studies for distribution systems indicate that there are no significant technical barriers to the grid connection of a wave farm, both at Biscay Marine Energy Platform (*bimep*) (20 MW) and at the Belmullet test site (5 MW). This is a positive outcome, especially as, apart from the study focused on the effect of device aggregation, all the other studies were performed with no phase shift applied between the power output of the different devices' power output, which represents the worst case scenario for the power fluctuations approach.
- In the case of *bimep*, the wave farm effects on the connection point are not significant since the associated distribution grid is strong. With an increasing penetration level of marine renewable energy, the achievement of acceptable power quality issues will be more complex and specific studies on reactive power control and compensation (i.e., flexible AC transmission system or FACTS) will be mandatory.
- Some minor concerns in terms of power quality and voltage variation arise at Belmullet for the wave farms with power capacity exceeding 3 MW and with extreme power fluctuations (zero to peak value at each cycle). This situation occurs when connecting devices have no energy storage capacity and with minimal smoothing from device aggregation.
- The system power losses were shown to be larger for a system with fluctuating power output, compared with a non-fluctuating system with the same mean output. This has an impact on component ratings and special attention must be paid to thermal design when considering fluctuating power flows.
- The local network of Belmullet is currently used to distribute power to a small population from remote power plants. The integration of a wave farm to this grid radically alters the operating envelope of the local circuit breakers, as shown by the fault study.

#### **Transmission Integration (USA, Republic of Korea):**

- Considering simultaneous wave energy power generation from selected target areas along the coast of Oregon, the aggregated capacity transfer limit from west to east is found to be approximately 430 MW. This threshold of capacity addition is a conservative estimate. A set of twelve points of interconnection (POI)s were evaluated and the capacity levels were found to be highly diverse (from 5 MW to 480 MW, depending on the POI).
- Under the scope of this study, with its underlying assumptions and criteria, it has been identified that the primary limiting factor is line overloading. Further studies with broader scope may provide more insight considering the Pacific NW coastal region (Washington, British Columbia, California, in addition to Oregon under



longer time horizons), as well as the use of high voltage DC transmission (HVDC), flexible AC transmission system (FACTS) devices, effects of special contingencies and protection schemes.

- With regard to tidal and wave power integration in the Korean electricity network, voltage security, transient security and small signal stability analyses for the years 2017 and 2022, under both peak and light loading conditions, have been carried out. It was assumed that, before 2017, Jeju Island would be connected to the Korean mainland through two high voltage direct current (HVDC) submarine transmission links, totalling a maximum capacity of 700 MW in either direction.
- Two locations of ocean wave energy generation into Jeju Island and four locations of tidal current power generation into the Korean mainland were considered. The maximum new generation injections into the island and mainland were 1000 MW and 620 MW, respectively, to be dispatched against forecasted load increases in certain areas of the mainland. The voltage and transient security limitations observed from the case study could be removed by adding a parallel 765 kV circuit.

These case studies provide insights into a broad range of project scenarios, integration challenges, device types, time-horizons and technical aspects. Power system modelling and simulation have been used as vehicles for these assessments.

Based on the knowledge gained through the activities of this Annex, recommendations for subsequent collaboration on relevant topics have been made.

## TABLE OF CONTENTS

---

Executive Summary.....	6
Table of Contents .....	9
List of Figures.....	13
List of Tables .....	18
Acronyms .....	20
1 Introduction.....	22
1.1 Background.....	22
1.2 Scope.....	22
1.3 Variability and Intermittency of Wave and Tidal Current Resources .....	23
1.4 Present Generation Characteristics of Wave and Tidal Current Conversion Processes.....	26
1.5 Power System Stability and Control.....	28
1.5.1 Power System Control.....	31
1.5.2 Power System Inertia.....	33
1.5.3 Power System Stability Problem.....	33
1.5.4 Classification of Stability .....	34
1.6 Power Quality .....	36
1.6.1 Local Impact and Power Quality Issues .....	38
1.7 Grid Connection Codes.....	41
1.7.1 Voltage and Reactive Power Control .....	43
1.7.2 Frequency Control.....	44
1.7.3 Fault Ride-Through Capability .....	47
1.7.4 Relay Protections.....	48
1.8 Interconnection Standards and Guidelines .....	49
1.8.1 IEEE Standard for Interconnecting Distributed Resources with Electric Power Systems (IEEE 1547/2003) .....	49
1.9 Energy storage .....	50

1.10	Power System Simulation Tools.....	51
2	Grid-connected Pilot Plants and Future Grid Integration Issues .....	54
2.1	Grid-Connected Pilot Plants .....	54
2.1.1	Predictability, Dispatchability and Capacity Factor.....	59
2.2	Layout of devices.....	62
2.2.1	Basic Structures of Ocean Farm Electrical Systems .....	62
2.2.2	Cluster Array Types .....	64
2.2.3	Integration Architectures.....	66
2.2.4	Electrical Transmission Options .....	68
2.2.5	Generation Units and Conversion Systems .....	73
2.3	Characteristics of Conversion Systems and control .....	76
2.3.1	System Modelling Detail Level.....	77
2.3.2	Control of Oscillating Wave Energy Converters .....	78
2.3.3	Reactive Power Compensation Technologies for Control of Grid Integration .....	79
2.4	Site .....	81
2.4.1	Strong Grid and Weak Grid.....	81
2.4.2	National Electric Power System Maps.....	83
2.4.3	Biscay Marine Energy Platform.....	102
2.4.4	Belmullet Wave Energy Test Site .....	103
3	Case Study .....	105
3.1	Distribution System: Basque Country Case Study .....	105
3.1.1	Electrical Network Modelling.....	106
3.1.2	WEC Modelling .....	109
3.1.3	Distribution Code Requirements .....	110
3.1.4	Load Flow.....	111
3.1.5	Power Losses.....	114
3.1.6	Aggregation of Devices.....	114
3.1.7	Contingency Analysis.....	115

3.1.8	Voltage Issues.....	116
3.1.9	Conclusion.....	116
3.2	Distribution System: Ireland Case Study.....	118
3.2.1	Electrical Network Modelling.....	118
3.2.2	WECs Modelling.....	119
3.2.3	Distribution Code Requirements.....	120
3.2.4	Load Flow.....	120
3.2.5	Power Losses.....	121
3.2.6	Aggregation of Devices.....	126
3.2.7	Contingency Analysis.....	127
3.2.8	Voltage Limits and Voltage Variations.....	127
3.2.9	Conclusion.....	135
3.3	Transmission System: Oregon (USA) Case Study.....	136
3.3.1	Introduction.....	136
3.3.2	Base Case Description.....	137
3.3.3	Dynamic Modelling of Wave Energy Converter.....	141
3.3.4	Scenario Setup.....	145
3.3.5	Steady-State/Voltage-Security Analysis.....	149
3.3.6	Time Domain/Transient Security Analysis.....	151
3.3.7	Conclusion.....	154
3.4	Transmission System: The Republic of Korea Case Study.....	155
3.4.1	Introduction.....	155
3.4.2	Base Case Descriptions.....	156
3.4.3	Dynamic Modelling of Tidal Current Energy Converter.....	156
3.4.4	Scenario Setup.....	159
3.4.5	Steady-State/Voltage-Security Assessments.....	160
3.4.6	Time Domain/Transient Security Assessment.....	162
3.4.7	Small Signal Stability Analysis.....	162
3.4.8	Conclusion.....	162

4	Discussion and Recommendations .....	164
4.1	Summary.....	164
4.1.1	Predictability of Wave and Tidal Current Resources.....	164
4.1.2	Dispatchability .....	165
4.1.3	Capacity Factor of Wave and Tidal Current Power Plants .....	165
4.1.4	Power quality .....	165
4.1.5	Interconnection guidelines .....	166
4.1.6	Integrated system scenario analyses.....	167
4.1.7	Integration of the Technologies with Storage into NIA/Autonomous Systems .....	168
4.2	Recommendations for Future Collaboration.....	169
4.2.1	Pilot project information collection and dissemination .....	169
4.2.2	Power quality impact and system design .....	169
4.2.3	Dynamic model validation .....	169
4.2.4	Device and interconnection guidelines .....	169
4.2.5	Integrated system scenario assessment for a larger power system .....	169
4.2.6	Development methodology to optimise size of demonstration and storage for NIA/autonomous systems.....	170
5	Bibliography .....	171

## LIST OF FIGURES

---

Figure 1.1: Ocean Energy Conversion Systems (Tidal and Wave) [1].	26
Figure 1.2: Subsystems of a power system and associated controls [13].	30
Figure 1.3: Load balance and scheduling [1].	31
Figure 1.4: Power system operating states [13].	32
Figure 1.5: Classification of power system stability [13].	35
Figure 1.6: Classical model of the power system [17].	36
Figure 1.7: Modern model of power system [17].	37
Figure 1.8: Possible grid impact issues pertaining to ocean energy systems [1].	38
Figure 1.9: Typical limiting curve for reactive power [22].	43
Figure 1.10: Typical frequency controlled regulation of active power [24].	44
Figure 1.11: Summary of frequency control requirements imposed by several countries grid codes ([21], [22], [23], [31], [32], [33]).	46
Figure 1.12: Curve of the voltage in function of the time at the connection point, defining the voltage dip area [32].	47
Figure 1.13: Operational area (in grey) during fault and recovery periods in function of the voltage at the connection point [33].	48
Figure 2.1: Examples of potential wave farms spatial configurations	63
Figure 2.2: Interaction diagram: Main factors influencing the offshore farm layout design	63
Figure 2.3: Main types of clustering for marine energy farms [64]	65
Figure 2.4: Interconnecting cables routes for AC and DC technology	65
Figure 2.5: DC series cabling	66
Figure 2.6: Integration topologies [65].	67
Figure 2.7: HVAC transmission - small farm (T1).	69
Figure 2.8: HVAC transmission – large farm (T2).	69
Figure 2.9: HVDC transmission – large AC-clustered farm (T3)	71
Figure 2.10: HVDC transmission – large DC-clustered farm 1 (T4)	71
Figure 2.11: HVDC transmission – large DC-clustered farm 2 (T5)	72

Figure 2.12: HVDC transmission – small DC-clustered farm (T6) .....	72
Figure 2.13: Generation units configurations used in marine offshore energy .....	74
Figure 2.14: Typical ocean energy conversion process.....	76
Figure 2.15: Short-circuit diagram .....	81
Figure 2.16: X/R ratio [87].....	83
Figure 2.17: Population distribution in England and Wales [88] and in Scotland [89] .....	84
Figure 2.18: Electric power transmission grid in United Kingdom [90].....	84
Figure 2.19: Population distribution in Spain [67].....	85
Figure 2.20: Electric power transmission grid in Spain [91].....	85
Figure 2.21: Population distribution in Portugal [92] .....	86
Figure 2.22: Electric power transmission grid in Portugal [93] .....	86
Figure 2.23: Population distribution in Ireland [67].....	87
Figure 2.24: Electric power transmission grid in Ireland [94]. .....	87
Figure 2.25: Population distribution as of July 1, 2007 in Canada [95].....	88
Figure 2.26: Canada-USA interconnected electricity network [96].....	88
Figure 2.27: Population distribution in United States [97].....	89
Figure 2.28: Electric power transmission grid in the United States [98]. .....	89
Figure 2.29: Population distribution in the Republic of Korea [99].....	90
Figure 2.30: Electric power transmission grid in the Republic of Korea [100]. .....	90
Figure 2.31: Population distribution in Denmark [101]. .....	91
Figure 2.32: Electric power transmission grid in Denmark [98].....	91
Figure 2.33: Population distribution in Japan [67].....	92
Figure 2.34: Electric power transmission grid in Japan [98].....	92
Figure 2.35: Population distribution in Belgium [101]. .....	93
Figure 2.36: Electric power transmission grid in Belgium [102].....	93
Figure 2.37: Population distribution in Germany [67] .....	94
Figure 2.38: Electric power transmission grid in Germany [98].....	94
Figure 2.39: Population distribution in Mexico [67].....	95
Figure 2.40: Electric power transmission grid in Mexico [98] .....	95

Figure 2.41: Population distribution in Norway [101] .....	96
Figure 2.42: Electric power transmission grid in Norway [98].....	96
Figure 2.43: Population distribution in Italy [103].....	97
Figure 2.44: Electric power transmission grid in Italy [98] .....	97
Figure 2.45: Population distribution in New Zealand [67].....	98
Figure 2.46: Electric power transmission grid in New Zealand [98] .....	98
Figure 2.47: Population distribution in Sweden [104] .....	99
Figure 2.48: Electric power transmission grid in Sweden [105].....	99
Figure 2.49: Population distribution in Australia [106] .....	100
Figure 2.50: Electric power transmission grid in Australia [107].....	100
Figure 2.51: Population distribution in South Africa [67] .....	101
Figure 2.52: Electric power transmission grid in South Africa [98] .....	101
Figure 2.53: Location of <i>bimep</i> .....	102
Figure 2.54: Aerial view of <i>bimep</i> test zone with planned cable routes [108]......	103
Figure 2.55: Conceptual layout of the facility [109]. .....	104
Figure 3.1: <i>bimep</i> architecture. ....	106
Figure 3.2: Simulated grid model.....	108
Figure 3.3: Fault ride-through capability.....	111
Figure 3.4: Maximum loading level .....	112
Figure 3.5: Voltage profile from the WEC 1 to the PCC for SC and SG.....	113
Figure 3.6: Voltage profile from the WEC 4 to the PCC for SC and SG.....	113
Figure 3.7: Total losses (MW) and efficiency (%).....	114
Figure 3.8: Power and voltage variations .....	115
Figure 3.9: Voltage profile (pu) when a voltage sag occurs at the PCC for different wave farm power (a) 1.1 MW (b) 6 MW (c) 7.5 MW (d) 12 MW.....	117
Figure 3.10: Voltage profile (pu) when a voltage sag occurs at the PCC for different wave farm power (a) 1.1 MW (b) 7.5 MW .....	117
Figure 3.11: Grid model .....	119
Figure 3.12: Voltage profile from the 10 kV bus to the AC voltage source .....	121



Figure 3.13: Distribution of power loss with respect to the electrical components (load flow) .....	122
Figure 3.14: Power output of generator SG 1.....	123
Figure 3.15: Efficiency of the network.....	124
Figure 3.16: Standard deviation of $P_{in}$ and $P_{out}$ .....	125
Figure 3.17: Difference between the standard deviation of $P_{in}$ and $P_{out}$ .....	125
Figure 3.18: Maximum voltage standard deviation.....	127
Figure 3.19: Voltage at the 10 kV bus versus number of generation units lost.....	127
Figure 3.20: Maximum voltage values at the 10 kV, 20 kV and 38 kV buses.....	128
Figure 3.21: Minimum voltages .....	129
Figure 3.22: Maximum allowed power fluctuation amplitude.....	130
Figure 3.23: Voltage at the PCC for wave farm capacity of 1 MW, 3 MW and 5 MW (Scenario a) .....	131
Figure 3.24: Voltage at the PCC and at two generator terminals for a wave farm capacity of 3 MW (Scenario a).....	131
Figure 3.25: Voltage at the PCC and at two generator terminals with no short-circuit clearance for a wave farm capacity of 3 MW (scenario a).....	132
Figure 3.26: Reactive power in MVAR of a single generator and voltage at the PCC in pu .....	133
Figure 3.27: Speed in pu of Generator 1 .....	133
Figure 3.28: Voltage at the PCC for wave farm capacity of 1 MW, 3 MW and 5 MW (Scenario b).....	134
Figure 3.29: Northwest area and the neighbouring authorities .....	138
Figure 3.30: Oregon coast and the transmission network (existing) .....	140
Figure 3.31: Coastal regions and power flow directions (projected, but no wave power generation added) .....	140
Figure 3.32: Outline of ocean wave energy converter model.....	142
Figure 3.33 Example power matrix of a hinged contour device .....	144
Figure 3.34: Transfers and points of interconnection.....	147
Figure 3.35: WEC implementation in powerflow base cases.....	149
Figure 3.36: Bus voltage criteria violations observed at selected buses .....	152

Figure 3.37: Ocean wave generator speed observed at all POIs .....	152
Figure 3.38: Generator relative rotor angles for units located near the wave power plants .....	153
Figure 3.39: A map of the power grid of the Republic of Korea in 2009 .....	155
Figure 3.40: Diversity of tidal current energy conversion systems.....	157
Figure 3.41: Tidal current device power conversion subsystems.....	157
Figure 3.42: Model elements of a tidal current conversion system.....	158
Figure 3.43: Tidal current device model blocks, as implemented in power system analysis software.....	159
Figure 3.44: PV curves of 2017 light load case.....	161

## LIST OF TABLES

---

Table 1.1: Timescale of natural cycle of renewable energy processes [4].....	23
Table 1.2: Ocean device specific factors affecting the connection configuration.....	40
Table 1.3: Basic requirements imposed for wind energy generation by grid codes [21], [22], [23] .....	42
Table 1.4: Farm transmission system frequency and active power targets. ....	45
Table 1.5: Interconnection system response to abnormal voltage.....	50
Table 1.6: Properties of some storage technologies [37].....	51
Table 2.1: Examples of grid-connected pilot wave power plants.....	56
Table 2.2: Examples of grid-connected pilot tidal current power plants.....	58
Table 2.3: Selected future grid-connected sites/projects .....	59
Table 2.4: Response means to power dispatch requests .....	61
Table 2.5: Capacity factors for some pilot power plants .....	62
Table 2.6: Typical voltage levels for offshore marine energy applications [64].....	64
Table 2.7: Comparison of the different integration configurations [64] .....	67
Table 2.8: Model types versus analysis type [75]. ....	77
Table 2.9: Comparison of basic types of compensators [85] .....	80
Table 3.1: Subsea cables lengths .....	107
Table 3.2: Power variance .....	115
Table 3.3: Period of the sinusoidal terms .....	123
Table 3.4: Amplitude sets for the simulations .....	123
Table 3.5: Phase shifts .....	124
Table 3.6: Amplitudes and periods of the sinusoidal terms .....	126
Table 3.7: Random phase shifts.....	126
Table 3.8: Summary of summer and winter powerflow base cases (year 2019).....	138
Table 3.9: Northwest area interchange summary .....	139
Table 3.10: Northwest Balancing Authority area loads and resources .....	139
Table 3.11: WEC parameter list .....	145

Table 3.12: Transfer description and sink system plants (units) .....	146
Table 3.13: Typical relay and circuit breaker interrupting times .....	148
Table 3.14: POI capacities for added new wave power .....	150
Table 3.15: Power flow summaries of the combined base cases.....	156
Table 3.16: New renewable generation interconnection .....	159
Table 3.17: Number of applied contingencies to the four cases in various types of studies .....	160
Table 3.18: Maximum overloads for 2017 light load case with 700 MW ocean renewable generation .....	161
Table 3.19: Load models for dynamic simulations .....	162
Table 3.20: Relevant inter-area mode for the worst contingency before and after renewable resources.....	162

## ACRONYMS

---

AC	Alternating Current
AGC	Automatic Generation Control
ATC	Available Transmission Capacity
DC	Direct Current
DFIG	Doubly Fed Induction Generator
DG	Distributed Generation
DSO	Distribution System Operator
FACTS	Flexible AC Transmission System
FRT	Fault Ride-Through
GC	Grid Codes
HV	High Voltage
HVAC	High Voltage Alternating Current
HVDC	High Voltage Direct Current
IGBT	Insulated Gate Bipolar Transistors
LCC	Line Commutated Converter
MPPT	Maximum Power Point Tracking
MSC	Mechanically Switched Shunt Capacitor
MV	Medium Voltage
NIA	Non Integrated Area
ODE	Ordinary Differential Equation
PCC	Point of Common Coupling
PHEV	Plug-in Hybrid Electric Vehicle
PM	Permanent Magnet
POI	Point of Interconnection
PSAT	Powerflow and Short circuit Analysis Tool
PSS	Power System Stabilisers
PTO	Power Take Off
PWM	Pulse Width Modulation
rms	Root Mean Square

SC	Squirrel Cage Generator
SG	Static Gen
SPS	Special Protection System
SSAT	Small Signal Assessment Tool
STATCOM	Static Synchronous Compensator
SVC	Static VAR Compensator
TCR	Thyristor Controlled Reactor
THD	Total Harmonic Distortion
TSAT	Transient Security Assessment Tool
TSC	Thyristor Switched Capacitor
TSO	Transmission System Operator
VAR	Volt-Ampere Reactive
VSAT	Voltage Security Assessment Tool
VSC	Voltage Source Converter
WEC	Wave Energy Converter
XLPE	Cross-linked Polyethylene

# 1 INTRODUCTION

---

## 1.1 BACKGROUND

Renewable energy from ocean wave and tidal current resources is an emerging resource option. Potential contribution of this energy resource towards electricity production and for other utilisations is being examined by various organisations in more than 25 countries. Several countries have embarked on research, demonstration and commercial operations to harness wave and tidal current energy resources. To provide a forum for information exchange related to integration of wave and tidal current energy into electrical systems, the International Energy Agency's Implementing Agreement on Ocean Energy Systems (OES-IA) ([www.iea-oceans.org](http://www.iea-oceans.org)) initiated a task-shared and cost-shared collaborative program in 2007, called Annex III. Task activities through this Annex were carried out in three work packages. This report presents the work performed in Work Package 3. The report also presents some earlier work carried out through this Annex and reported in the following three OES-IA documents:

- Potential opportunities and differences associated with integration of ocean wave and ocean current energy plants in comparison to wind energy. OES-IA Document No: T0311 [1].
- Key features and identification of needed improvements to existing interconnection guidelines for facilitating integration of ocean energy pilot projects. OES-IA Document No: T0312 [2].
- Dynamic characteristics of wave and tidal energy converters and a recommended structure for development of a generic model for grid connection. OES-IA Document No: T0321 [3].

## 1.2 SCOPE

The variability of wave and tidal current resources as well as present generation characteristics of the wave and tidal current conversion processes are discussed in the following sub-sections of this first section. This section also presents the meaning of grid integration, defines various terms and discusses important grid integration issues (e.g., power quality, active and reactive power, etc.). Finally, grid codes are briefly discussed.

Section 2 describes how various potential grid integration issues can be managed considering several factors, including deployment site, conversion systems, layout of devices and system control.

Sub-sections 3.1 and 3.2 show case studies illustrating integration of a wave energy plant into a typical distribution grid, whereas sub-sections 3.3 and 3.4 present case studies illustrating integration of aggregate wave energy and tidal current power plants into a larger power system at transmission levels.

Section 4 of the report presents some observations from this work and recommendations for future collaboration.

### 1.3 VARIABILITY AND INTERMITTENCY OF WAVE AND TIDAL CURRENT RESOURCES

Renewable energy systems convert the energy flux from natural sources into useful forms. Therefore, the stochastic and periodic nature of various environmental elements affects the operation, output and availability of such energy converters. The frequency variation of the power produced from the renewable resources depends especially on the variability of the resources. The conversion principle and the mechanism employed can help smoothing this variation [4]. Table 1-1 shows the timescale of natural cycle of renewable energy processes.

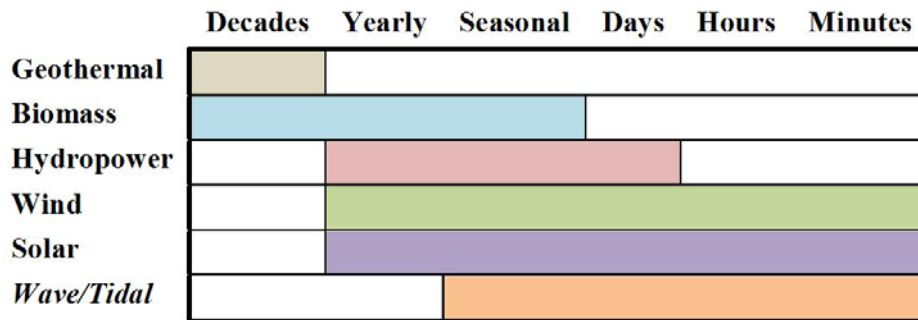

Table 1.1: Timescale of natural cycle of renewable energy processes [4]

Historically, resource intermittency and variability have been considered as the main obstacle to integration of many renewable energy sources. The key aspects in this regard are [1]:

- **Lack of dispatchability:** In the absence of sufficient prior knowledge (predictions 1 to 40 hours before) on how much generation can be realised from a time-varying generating source and what timeframe of operation can be ensured, the system operators find such variable sources difficult to synchronise with present or predicted load demand.
- **Stress on the electrical grid:** As the operation of many renewable energy systems directly depends upon the variations in environmental conditions, a sudden increase in output or an outage from one or more of the surrounding generators may cause the neighbouring grid to reach its threshold of continuous operation. In addition, effects of flicker, harmonics and thermal overload may introduce various operational challenges.
- **High penetration effects:** With a minimal level of renewable energy integration into the existing bulk power system, time variations are buried in the overall load generation mix. However, with higher penetration of such generating sources, occasional mismatch between existing load demand and generation level may cause the system to migrate from its equilibrium condition. In some European and North American countries, high penetration of wind energy is a major topic of interest.



Regarding tidal resources, the main characteristic is the predictability. In a tidal farm, the power production can be accurately forecasted. This is a big advantage compared to other renewable resources because the influence of the farm on the grid can be estimated. In economic terms, knowing the efficiency of the current tidal energy converters, the benefits can be estimated with a reasonable margin of error. However, the large variability of the tidal resource will pose challenges to the power systems.

The gravitational and rotational forces between the earth, moon and sun that cause water on the earth's surface to move in different directions drive tides. The moon is the main cause of the existence of tides; however, the relative influence of the sun and moon varies over the course of a year. This results in variations in the tide height on a number of time scales [5].

- Daily Tides: the change in tide height that occurs each day is the most readily observable tidal pattern. In many locations around the world, these tides occur on a semi-diurnal basis – roughly two high tides and two low tides each day. Local bathymetry and coastal geography will influence the tidal patterns of individual locations. Some locations may experience only one tide per day (diurnal), or show a mixture of the two depending on the spring-neap tide cycle. The timing of high and low tides is affected by location, particularly in areas where water flow is restricted.
- Spring and Neap Tides: The relative position of the moon and sun in relation to each other has a significant effect on the daily tidal range.

Tidal currents occur when the tide forces water movement, particularly if that water is constrained by headlands, islands or channels. As tidal currents are a direct result of the action of tides, the pattern of variation is controlled by the pattern of tides.

Wave energy resources, however, depend largely on wind. Wind speed, duration of wind blow and fetch define the amount of energy transferred. Wave energy is subject to cyclic fluctuation dominated by wave periods and wave heights. Power levels vary both on a daily and monthly basis, with seasonal variations being less in more temperate zones. Power levels also vary on a wave-to-wave and wave group basis. A sea-state lasts around 10 to 20 minutes, so variation can be visible on a basis of minutes.

Taking into account wave and tidal current resource characteristics, the lack of dispatchability is not a main problem as both resources are more predictable than other renewable resources, such as wind. In the case of wave and tidal resources, significant variations are mostly limited between hourly and seasonal variations. Nevertheless, in the case of wave energy converters, stress on the electrical grid and high penetration effects may be serious obstacles due to the effect of wave by wave variability in the regulation time domain (seconds).

The Irish meteorological institute states, “The wave model outputs include hourly predictions of significant wave height and direction, mean wave period, peak period, significant height, direction and mean period of primary swell and sea/wind waves; and six-hourly outputs of the wave energy spectra. Waves can be forecast up to two days ahead on the Irish model and up to six days ahead on the European global model.” ([http://www.met.ie/marine/marine\\_forecast.asp](http://www.met.ie/marine/marine_forecast.asp)).

Waves can be forecasted, but not on the long term (e.g., precisely with significant height, mean period, etc. a week ahead). Existing global and local forecasting models need to be refined and optimised to match the accuracy requirements demanded by grid operators for the integration of wave energy into the energy mix.

In spite of being highly variable and difficult to predict, wind energy has secured its place alongside other conventional energy sources. The key lessons learned from this technology include:

- The aggregation of wind generation reduces output fluctuations resulting from resource variations. Aggregation also reduces prediction error.
- Improved forecasting methods allow greater penetration of wind power into the grid.
- In order to maintain system stability and to supply the load demand, at higher penetration levels (>15% of energy) sufficient reserve capacity may be needed.
- Expansion and reinforcement of transmission and distribution grids plays a key role in allowing higher levels of wind power integration into the grid.
- Newer technologies and management strategies support the grid and have paved the path for fast growth of wind power.

Wave and tidal current generation schemes will undoubtedly require similar arrangements in order to be integrated into an electric grid. The good news is large scale wind may inadvertently lead in the management of wave and tidal current resources by forcing utilities to develop operational approaches to manage their variability. Solar energy in established markets may offer a model for the integration of wave and tidal current resources in the regulation time domain where impacts are likely to occur. Tracking the integration of wind and solar in established markets may offer solutions with the impacts of these variable ocean renewables.

Capitalising on the commonly perceived notion that wave and tidal resources are more predictable, development of reliable, effective and accurate forecasting methods will have multi-dimensional effects, such as:

- Resource assessment and prediction of wave/tidal plant output for feasibility/cost studies.
- Becoming competitive to dispatchable generation units and providing ancillary services.
- Avoiding scheduling penalties and contributing to reliability enhancement.

In brief, the effects of resource variability can be reduced by accommodating one or more of the following schemes:

- Resource forecasting.
- Intra- and inter-site smoothing.
- Generation and load mix (balancing area management).
- Storage (i.e. large hydro, pumped hydro, battery storage).
- Load forecasting and demand side management.
- Generation/load flexibility offering could be most cost effective solution. This is the main scheme applied today in power systems and has potential to be increased.

## 1.4 PRESENT GENERATION CHARACTERISTICS OF WAVE AND TIDAL CURRENT CONVERSION PROCESSES

A brief look at the ocean energy conversion schemes reveals that most of the tidal current energy conversion devices are analogous to wind turbines and these units mostly utilise designs, concepts and equipment that originated in the wind industry (Figure 1.1). In sharp contrast to wind and tidal turbines, wave energy converters operate on diverse principles and may require cascaded conversion mechanisms.

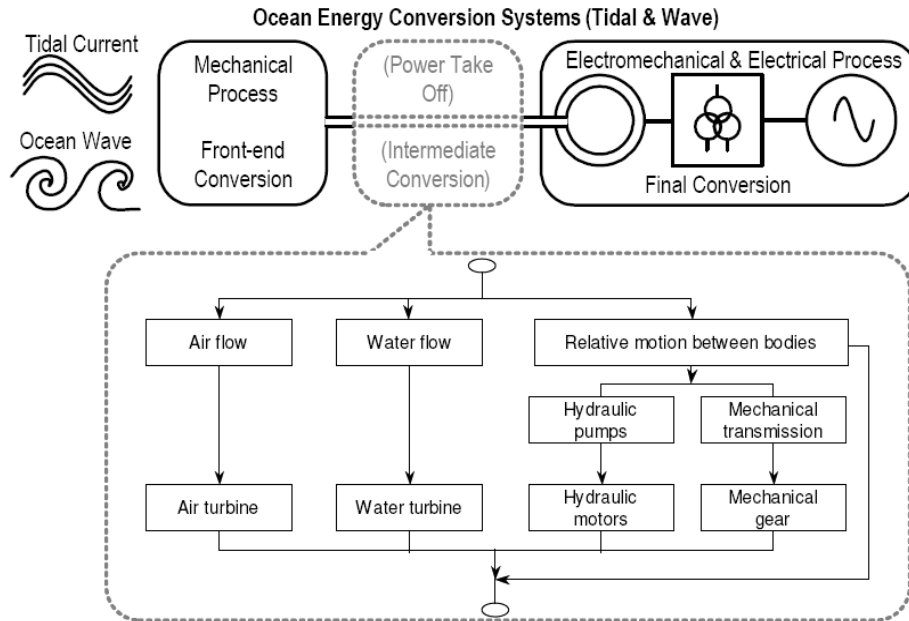

Figure 1.1: Ocean Energy Conversion Systems (Tidal and Wave) [1].

Even though tidal turbines can be viewed through established terms and definitions of the wind energy literature, studying wave energy devices poses a unique challenge. Different systems operate on different methods of wave-device interaction (such as heave, pitch or surge) and may need pneumatic, hydraulic or mechanical power take-off (PTO) stages. As in any efficiency calculation, addition of a second energy conversion feature, whether electrical or mechanical, may introduce efficiency degradation since losses are multiplicative in nature (this includes energy storage if included in the design, either at the plant or at the grid level). Wave and tidal technologies with a simple mechanical to electrical conversion are likely to dominate more complicated designs for this reason. Power electronics will likely enable wave and tidal resources to offer transmission support, which may provide a secondary value stream to make respective projects more economic.

In addition, placement of these devices (distance from shore, depth from surface and orientation with respect to the wave-front) and subtle structural aspects (resonance, directionality, etc.,) may blur the definition of operating principles. While the front-end stages may have significant diversity in design, the final stages of conversion (i.e. electric machines and equipment) are generally very similar for both wind and ocean (tidal or

wave) power plants, though reactive support for wave conversion will continue to be an issue for weak buses without energy storage.

Tidal current energy systems convert the kinetic energy of a water flow into the motion of a mechanical system, which can then drive a generator. Regarding the type of the rotor, there are two different concepts, axial flow rotors and cross flow rotors. Cross flow rotors are characterised by having the axis of rotation perpendicular to the flow [6].

Most of the devices can be characterised as belonging to one of four types:

- Horizontal axis systems such as SeaGen [7], which has been installed at Strangford Lough, Northern Ireland.
- Vertical axis systems such as the ENERMAR [8] device, which was tested in the Strait of Messina between Sicily and the Italian mainland.
- Reciprocating hydrofoil systems such as Stingray [9], which has been tested in Yell Sound in Shetland, which lies to the north of Scotland and Orkney.
- Venturi effect systems such as the Lunar Energy device [10], which uses pressure changes induced by flow constriction to drive a secondary hydraulic or pneumatic turbine.

Wave and tidal energy devices currently make use of a very wide range of technologies for primary energy conversion. All of the concepts aiming at generating electricity must include an electrical generator in the design, generally driven by an intermediate mover, but in some cases directly driven by the motion of the device itself. The different PTO systems can be classified in seven different concepts:

- Air turbines
- Hydraulic turbines contained in a closed circuit of pressurised oil
- Direct drive (linear generator using moving or stationary coils and moving or stationary permanent magnets)
- Low head water turbine
- Water pump
- Hydraulic turbine contained in an open circuit of sea water

Most of wave energy converters at an advanced stage of development have considered hydraulic systems for energy conversion. The motion of the device is in this case transferred to a hydraulic motor, which runs a conventional rotary generator. Pelamis [11], for instance, runs a hydraulic motor coupled with an asynchronous generator spinning at 1500 rpm.

Other technologies, mainly heaving point-absorbers, convert the power through directly driven generators, translating at a variable velocity and therefore generating output at variable frequency.

Tidal devices, especially horizontal (parallel to flow) axis turbines, present more similarities with the conventional wind turbine conversion mechanisms, with a gearbox interfacing between the shaft and the rotor of an electrical generator.

The step of electrical conversion consists of a generator and power electronics to adapt the energy generated to the grid, at the point where the energy converter is connected. The choice of the type of generator will influence the rating level of power electronics required as well as the type of grid connection interface and control. A brief summary of the existing technologies applicable to ocean energy devices is given below [12]:

- Synchronous Machines: The field source is provided by DC electromagnets, usually located on the rotor. Current in field coils can be adjusted to load, so that the power factor can be kept close to unity or within prescribed values. An external electric power source is needed to feed rotating DC coils.
- Permanent Magnet Synchronous Machines: Instead of electromagnets, rare-earth (usually neodymium [NdFeB]) permanent magnets are implemented. In machines rated up to a few MW, permanent magnets allow for remarkable improvements in terms of power density and design/manufacturing simplicity (no DC power source required).
- Variable Reluctance Synchronous Machines: Magnets are replaced by toothed-iron in the rotor, magnetised by the armature field windings. These machines are low-cost, have a simple design and a remarkably low power density. Variable-speed Synchronous Machines require fully-rated (MVA) power converters.
- Induction Generators: There is no autonomous field source. Rotor circuits hold low-frequency AC currents induced by armature field coils in the stator. No-load voltage is therefore zero and the power factor is always lower than unity. Air-gap length is determinant for performance (the smaller the better). Squirrel-cage machines have solid bars of conducting material; rotor-wound machines have windings.
- Doubly-Fed Induction Generators (DFIG): The frequency of the rotor currents is controlled by a power converter. Since the power electronics converter is rated for only a fraction of maximum machine power capability, it represents a very convenient solution for applications where the speed is varied within limits (e.g., 30%) of the rated value.
- Linear Generators: A typical wave energy converter with a linear generator consists of a buoy, floating on the surface of the ocean, connected with a cable to the rotor. The piston, in turn, is moving in a coil where electricity is induced. The tension in the cable is maintained with a spring attached at the bottom of the piston.

Induction machines are cheap and reliable, but encumbrance and efficiency may make them unfit for certain applications. Low speed direct drive energy conversion, for example, requires generators with torque/force density as high as possible. This is the case of linear generators for wave power, where the speed rarely exceeds one to two metres per second. Literature recommends permanent magnet technology for this class of electric machines.

## **1.5 POWER SYSTEM STABILITY AND CONTROL**

The main task of an electric power system is to convert energy from one of the available primary sources to electrical form and to transport it to the points of consumption. Energy is seldom consumed in the electrical form; the advantage of the electrical form of the energy is that it can be transported and controlled with relative ease and with a high degree of efficiency and reliability. A properly designed and operated power system should meet the following fundamental requirements [13].

- The system must be able to meet the continuously varying load demand for active and reactive power. Since electricity cannot be conveniently stored in sufficient quantities, adequate spinning reserves of active and reactive power should be maintained and appropriately controlled at all times.
- The system should supply energy at minimum cost and with minimum ecological impact.
- The quality of power supply must meet certain minimum standards with regard to the following factors:
  - Constancy of frequency (frequency stability).
  - Constancy of voltage (voltage stability).
  - Level of reliability.

In Figure 1.2 various subsystems and associated controls are depicted. In this structure, there are controllers operating directly on individual system elements. In a generating unit, these consist of prime mover controls and excitation controls.

The primary purpose of the system-generation control is to balance the total system generation against system load and losses so that the desired frequency and power interchange with neighbouring systems (tie flows) are maintained.

The transmission controls include power and voltage control devices, such as SVC, synchronous condensers, switched capacitors and reactors, tap-changing transformers, phase-shifting transformers and HVDC controls.

The controls described in Figure 1.2 not only contribute to the satisfactory operation of the power system but also have a profound effect on the dynamic performance of the power system, and on its ability to cope with disturbances.

Major system failures are usually brought about by a combination of circumstances that stress the grid beyond its capability. Severe natural disturbances (such as a tornado, severe storm or freezing rain), equipment malfunction, human error and inadequate design combine to weaken the power system and eventually lead to its breakdown [13].

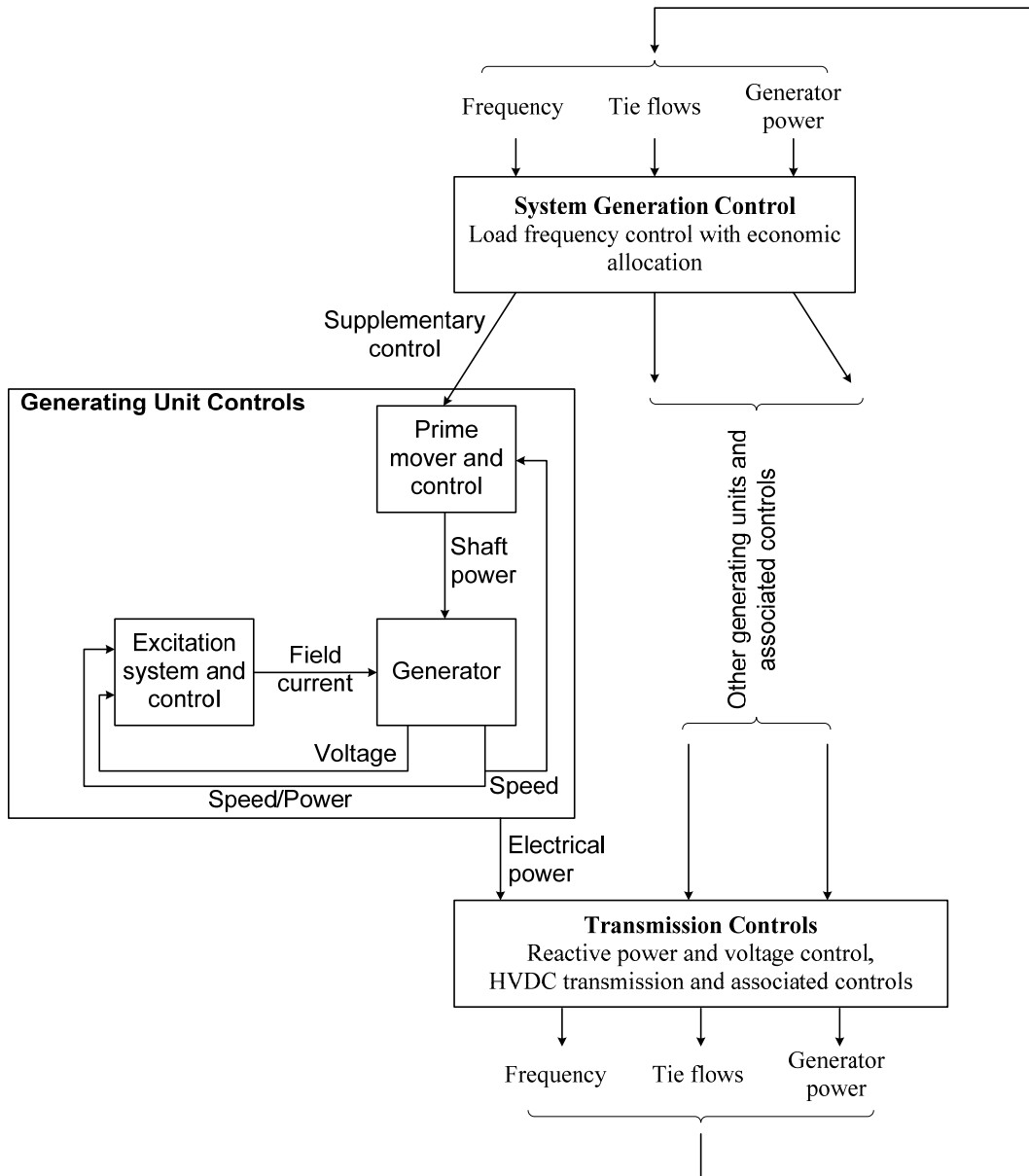

Figure 1.2: Subsystems of a power system and associated controls [13]

The impact of time varying generation sources, such as wind, wave or tidal, can be studied through three time domains (Figure 1.3):

- Regulation: Short-term (seconds-minutes) balance management using methods such as automatic generation control (AGC).
- Load-Following: Mid-term (minutes-hours) arrangement to follow the load variations, such as morning peak-load and evening light-load conditions.
- Scheduling and Unit Commitment: Securing sufficient generation in advance (hours or days), preferably in a more real-time manner.

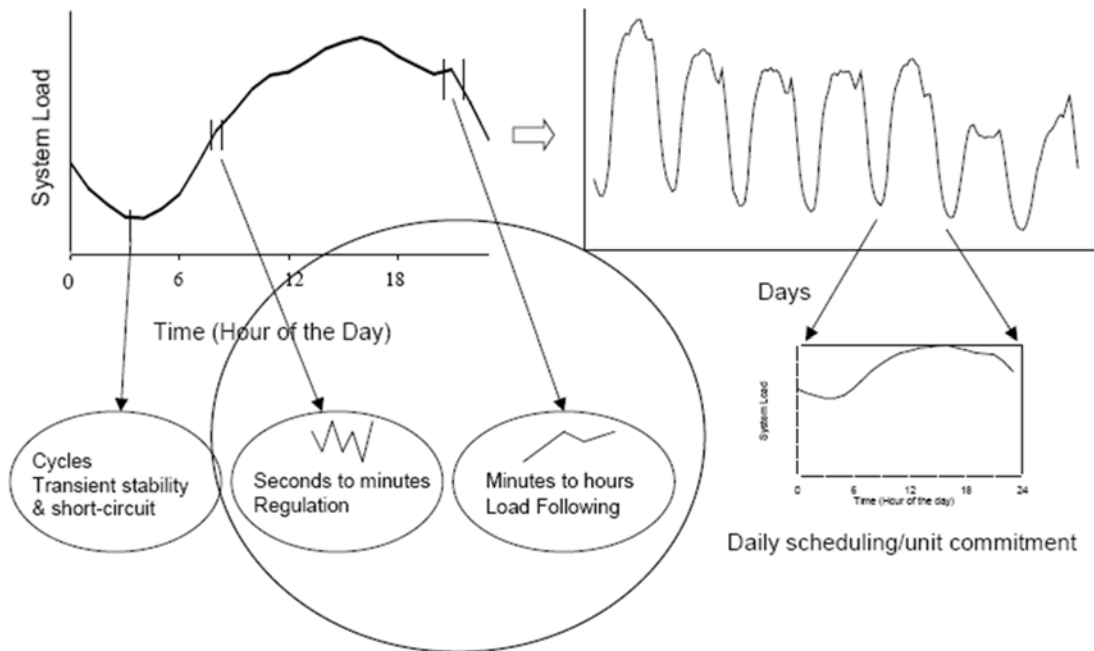

Figure 1.3: Load balance and scheduling [1].

Before introducing aspects regarding power quality, it is of a very high importance to understand how the power system works and guarantee quality energy supply at any point on the grid. The following sections of this chapter explain how the power system manages to assure reliable service, i.e., remain intact and be capable to withstanding a wide variety of disturbances [13].

### 1.5.1 Power System Control

A properly designed and operated power system should be able to meet the continually changing load demand for active and reactive power. Since electricity cannot be conveniently stored in sufficient quantities, adequate spinning reserves of active and reactive power should be maintained and appropriately controlled at all times.

At the same time, the system should supply energy at minimum cost and be able to guarantee the quality of power supply. The power supply must follow standards of quality which include the following factors:

- Constancy of frequency (frequency stability).
- Constancy of voltage (voltage stability).
- Level of reliability.



## ***Operating States of a Power System and Control Strategies***

Regarding power system security and the design of appropriate control systems, it is useful to take into account the following figure in order to classify system operating conditions (Figure 1.4):

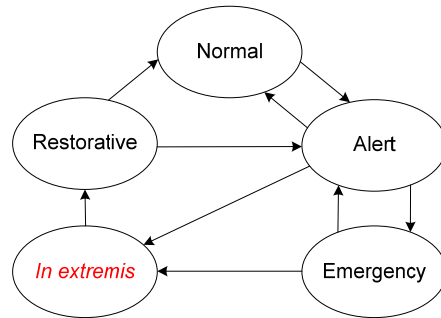

Figure 1.4: Power system operating states [13]

- Normal state: The system variables are within the normal range and there is no overloaded equipment.
- Alert state: The security level falls below the normal range or the possibility of a disturbance increases because of adverse weather conditions. In this state, all the system variables are still within acceptable range and all constraints. To restore the system to the normal state, preventive actions can be taken such as generation shifting (i.e., security dispatch) or increased reserve.
- Emergency state: When the system is in the “alert state” and a severe disturbance occurs. Voltages at many buses are low and/or equipment loadings exceed short-term emergency ratings. The system is still intact and may be restored to the alert state by the initiating of emergency control action:
  - Fault cleaning
  - Excitation control
  - Fast-valving
  - Generation tripping
  - Generation run-back
  - HVDC modulation
  - Load curtailment
- In extremis state: If the above-listed measures are not applied or are ineffective, the result is cascading outages and possibly a shut-down of a major portion of the system. Control actions, such as load shedding and controlled system separation, are aimed at saving as much of the system as possible from a widespread blackout.
- Restorative state: Control action reconnects all the facilities and restores system load. Depending on the system conditions, the system goes from this state to alert state or normal state.

### **1.5.2 Power System Inertia**

System inertia is the capacity of the power system to oppose changes in frequency [14]. Physically, it is loosely defined by the mass of all the synchronous rotating generators and motors connected to the system. In a power system with high inertia, frequency will fall slowly during a system disturbance, such as a generator tripping off line. On the other hand, in a power system with low inertia, frequency will fall faster during a loss of generation.

Although system inertia does not provide frequency control per se, it does influence in the time it takes for the frequency to recover from a given disturbance or loss of generation. Thus, higher system inertia is better than lower system inertia because it will provide more time for governors to respond to the drop in frequency [15]. Replacing conventional synchronous generators by a large number of DFIG or full converter synchronous generators will reduce the angular momentum of the system. Active power control with an additional loop is needed to tackle this problem.

### **1.5.3 Power System Stability Problem**

Power system stability can be defined as the property of a power system that enables it to remain in a state of operating equilibrium under normal operating conditions and to regain an acceptable state of equilibrium after being subjected to a disturbance. In the evaluation of stability, the behaviour of the power system is analysed when subjected to a transient disturbance.

The following classification of stability into various categories [16] helps provide the understanding of stability problems (Figure 1.5).

- Rotor angle stability: The ability of the interconnected synchronous machines of a power system to remain in synchronism. This stability problem involves the study of the electromechanical oscillations inherent in power system.
- Small-signal stability: The ability of the power system to maintain synchronism under small disturbances due to small variations in loads and generation. These disturbances are considered small enough for linearisation of system equations.
- Transient stability: The ability of the power system to maintain synchronism when subjected to a severe transient disturbance. Stability depends both on the initial conditions and on the severity of the disturbance. The resulting system response involves large excursions of generator rotor angles and is influenced by a nonlinear power-angle relationship.
- Voltage stability: The ability of a power system to maintain steady state acceptable voltages at all buses in the system under normal operating conditions and after being subjected to a disturbance. When the system condition causes a progressive and uncontrollable drop in voltage, the system enters in to a state of voltage instability. The incapability of the power system to meet the demand for reactive power is the main factor causing voltage instability. Another reason for the progressive drop in bus voltage can be associated with rotor angle going out of step due to the nonlinear power-angle relationship. Even though voltage instability is in essence a local phenomenon, its consequences may have a widespread impact.

- Large-disturbance voltage stability: This form of stability is involved with a system's ability to control voltages following large disturbances such as system faults, loss of generation or circuit contingences. This is determined by the system-load characteristics and the interaction of both continuous and discrete controls and protection schemes. Determination of large-disturbance stability requires the examination of the nonlinear dynamic performance of a system over a period of time (from a few seconds to tens of minutes).
- Small-disturbance voltage stability: This form of stability is involved with a system's ability to control voltages following small perturbations, such as incremental changes in system load. This form of stability is determined by the characteristics of the load, both continuous and discrete load changes (controls) at a given instant of time. Static analysis can be used to carry out small-disturbance voltage stability analysis because the basic processes contributing to small-disturbance voltage instability are of a steady state.
- Voltage collapse: This form of stability it is more complex than simple voltage instability and is usually the result of a sequence of events coupled with voltage instability leading to a low-voltage profile in a significant part of the power system. Usually this is due to the inability of the power system to supply the full amount of reactive power required and consumed by long transmission lines, such as attempting to carry loads exceeding the Available Transmission Capacity (ATC) of the lines themselves.
- Mid-term and long-term stability problems: These stability problems are associated with inadequacies in equipment responses, poor coordination of control and protection equipment, or insufficient active/reactive power reserves (i.e., with problems associated with the dynamic response of the power system to severe disturbances). In mid-term stability studies, the focus is on synchronising power oscillations between machines; whereas in the case of long-term stability studies, the focus is on the slower and longer-duration phenomena that accompany large-scale system disturbances and the resulting large, sustained mismatches between generation and consumption of active and reactive power.

#### **1.5.4 Classification of Stability**

Instability of the power systems can take different forms and can be influenced by a wide range of factors. Analysis of stability problems, identification of essential factors that contribute to instability, and the formation of methods of improving stable operation are greatly facilitated by classification of stability into appropriate categories. These are based on the following considerations [16]:

- The physical nature of the resulting instability.
- The size of the disturbance considered.
- The devices, processes and time span that must be taken into consideration in order to determine stability.
- The most appropriate method of calculation and prediction of stability.

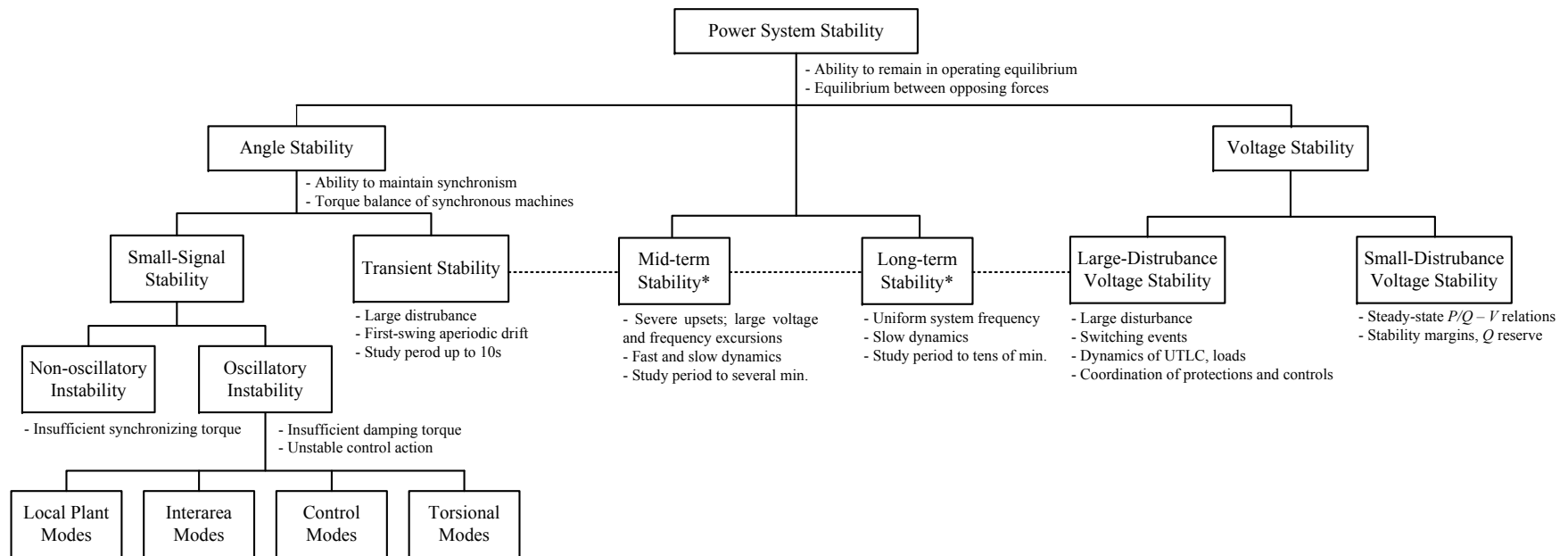

\* With availability of improved analytical techniques providing unified approach for analysis of fast and slow dynamics, distinction between mid-term and long-term stability has become less significant.

Figure 1.5: Classification of power system stability [13].

## 1.6 POWER QUALITY

To assure that the energy is transported and controlled with relative ease and with a high degree of efficiency and reliability, a specific level of power quality, must be guaranteed. In this report, the following definitions are considered [17]:

- Voltage quality is concerned with deviations of the voltage from the ideal voltage. The ideal voltage is a single-frequency sine wave of constant amplitude and frequency.
- Current quality is the complementary term to voltage quality. The ideal current is again a single-frequency sine wave of constant amplitude and frequency, with the additional requirement that the current sine wave is in phase with the voltage sine wave.
- Quality of supply is a combination of voltage quality and the non-technical aspects of the interaction from the power grid to its customers.
- Quality of consumption is the complementary term to quality of supply.

*Power quality* is the combination of voltage quality and current quality and is an issue to be managed locally at the point of connection (POC). All definitions given above apply to the interface between the grid (electric utility) and the customer. The term power quality is certainly not restricted to the interaction between the power grid and end-user equipment. Depending on the way a characteristic of voltage or current is measured, power quality disturbances can be defined as variations or events.

- Variations are small deviations of voltage or current characteristics from their nominal or ideal value. Variations are measured at any moment in time.
- Events are larger deviations that only occur occasionally. Events are disturbances that start and end with a threshold crossing.

The chief difference between variations and events is that variations can be measured at any moment in time whereas events require waiting for a voltage or current characteristic to exceed a pre-defined threshold. As the setting of a threshold is always somewhat arbitrary, there is no clear border between variations and events. Regardless, the difference between them remains useful and is analyzed (implicitly or explicitly) in almost every relevant study.

With a limited number of large power stations and an adequate transmission and distribution system, the electrical power system can distribute electrical power with a high power quality, with a fixed frequency, at a fixed voltage level and in a reliable way. The power is then transmitted via high voltage transmission lines and distributed via medium and low voltage distribution systems with good protection systems. The protection systems are sized based on the power flow from the power stations via the transmission lines and the distribution system to the customers (Figure 1.6).

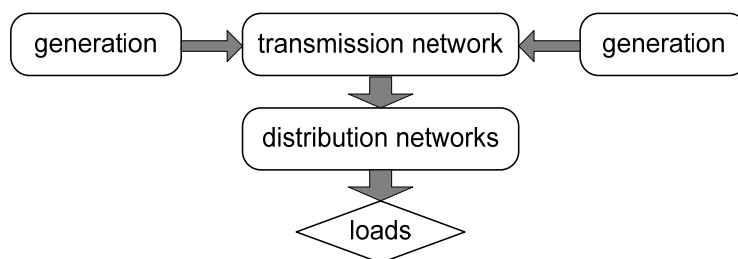

Figure 1.6: Classical model of the power system [17].

In the classical definition of the power system, the customers are traditionally referred to as loads. However, due to changes in these traditional loads (i.e., becoming more nonlinear) a modern model of power system has developed. Two developments can be highlighted: 1) the deregulation of the electricity industry; and 2) the increased number of smaller units connected at lower voltage levels. Because of this, the power system can no longer be seen as one entity, but as an electricity grid with customers. This new model is shown in Figure 1.7.

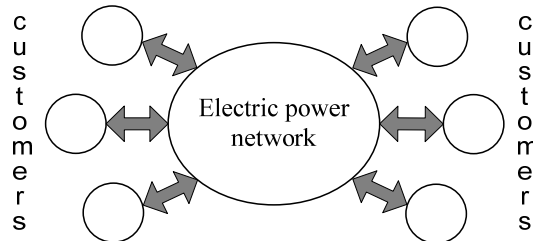

Figure 1.7: Modern model of power system [17].

To maintain a fixed voltage and frequency in a reliable way becomes more difficult as the contributions from distributed generation increases, especially in the case of variable renewable energy sources.

This is because these systems:

- Do not always contribute to voltage control, as they often do not vary reactive power output (especially older systems);
- Can disturb frequency control and cause voltage variations, due to the variability of the delivery of active power.
- Under voltage disturbances, they may disconnect and lead to significant loss of generation and thus disturb the power balance.
- May affect the protection system, when they connect to the distribution system and may change the power flow direction.

For wind energy, these aspects are being investigated and several problems have been solved [18]. Because of the similarities between wind and other renewable energy sources, wave and tidal energy can profit from this knowledge.

A set of possible grid impact issues can be broadly linked with wave and tidal current turbine farm power plant size and area of impact as indicated in Figure 1.8. While many of these factors are interrelated and cannot be viewed separately (such as reactive power and voltage stability), this approach differentiates between the effects of a small project against large future projects and development initiatives [1].

Energy buffering for wave energy converters may represent a serious issue since the raw power produced by a single unit may cause voltage variations at the connection node depending on the grid strength. Due to *wave grouping* in a given sea state, a large number of devices opportunely deployed can reduce the short-term variations of the output power.

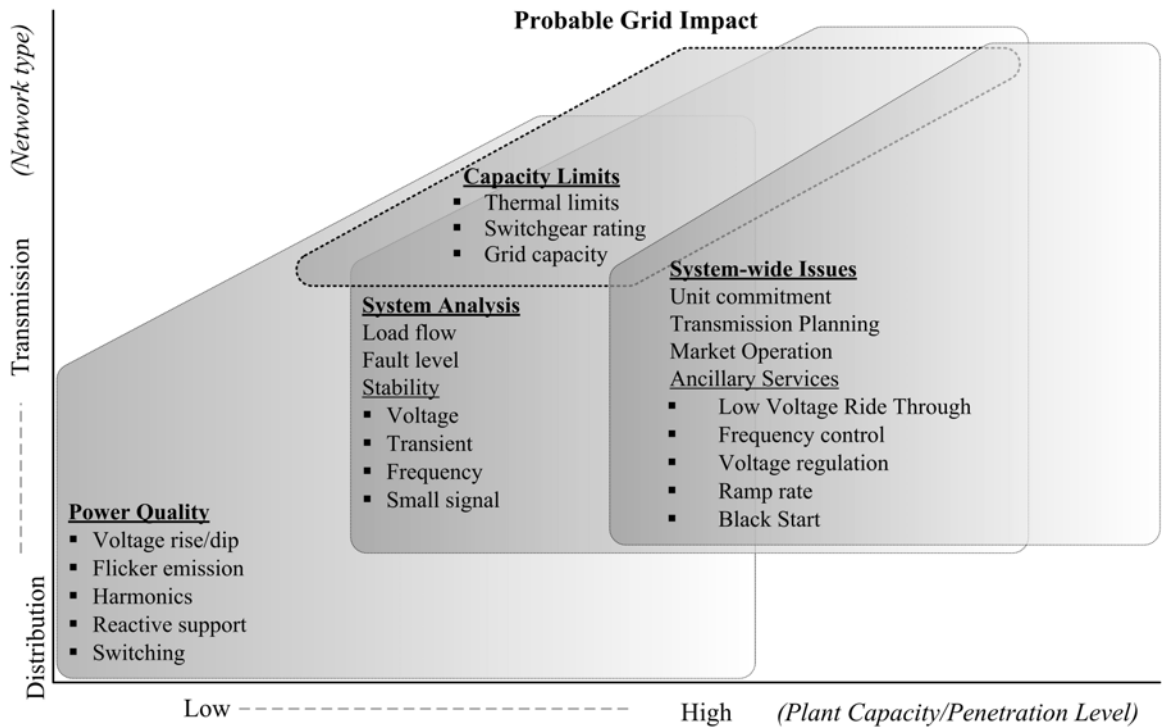

Figure 1.8: Possible grid impact issues pertaining to ocean energy systems [1].

### 1.6.1 Local Impact and Power Quality Issues

The impact of wave and tidal farms depends on the strength of the grid. A weaker grid will suffer larger voltage variations at the connection point than a strong one; this is because of the impedance of the grid. In a weak grid, this impedance is high and in this scenario a small amount of generation can greatly affect the steady-state voltage. Taking into account that many wave and tidal energy converters and farms will be connected to the distribution system close to shore (i.e., to grids with high impedance), many grid integration aspects should be analysed to assess suitable and secure operation both of the wave farm and of the grid.

A single ocean energy converter connected to the distribution system close to shore does not have a significant impact on entire grid. However, there may be some local effects in the distribution system where the ocean energy converter is connected, such as:

- Voltage variations
- Harmonics
- Flicker
- Performance during grid disturbances faults

Power electronic converters produce harmonics, but state-of-the-art filtering will usually keep these below a prescribed value. It has to be noted that the most modern electronic converters (based on insulated gate bipolar transistor [IGBT] thyristers) produce harmonics at their pulse wave modulation (PWM) frequency and at some multiple frequencies of the commutation frequency. All these frequencies are between 2 kHz and 9 kHz. Some effects were detected on loads but further studies are still needed in order to examine this issue in detail.

If there is no energy buffer in the device, the power delivered to the grid can vary significantly. These variations may be small in the case of tidal devices, while it is expected to represent a major issue for single wave energy converters. The magnitude of this variation depends on the strength of the grid. Fast variations can be problematic for other utility customers connected at this point.

This problem could be solved in different ways:

- Use a coupling point with a strong grid if possible (which may not be available).
- Add some form of grid reinforcement: For bulk power generation in remote areas, grid reinforcement (higher capacity conductors, transformers and switchgear) would allow for greater variations.
- Tap changing transformers: Tap changing systems may better regulate the bus-bar voltage (i.e., step-up during high load and step-down during high generation conditions).
- Use an energy buffer in the device, if possible (which may be expensive or not feasible).
- Use more than one energy converter so that the combined output contains less variation.
- Optimum sizing of the generation station: Depending on the type of plant and resource conditions, the optimum size of a generating station can be recommended for a given grid.
- Power factor adjustments: Operating with a leading power factor raises the generator terminal voltage and vice-versa. The addition of capacitor banks also affects the voltage magnitude.

If there is a fault on the grid, large short-circuit currents will activate the protection system and the faulted grid section will be disconnected. Depending on the distance to the fault, this will be seen as a smaller or larger voltage dip. Ocean energy converters with power electronics for the most part cannot significantly contribute to the fault currents (required to activate protection systems), since they cannot deliver more than their rated current.

In the early application of wind turbines connected to the distribution system, they typically disconnect from the grid in case of large voltage dips or system disturbances. However, with the increasing amount of wind power, disconnecting wind turbines can lead to a considerable loss of generation feeding the fault (and thereby further lowering system voltage). Therefore, new grid regulations now require that wind turbines stay connected to the grid for a specified time during faults (referred to as fault ride-through capability). The same may be expected for the application of ocean power. For variable speed systems with a full converter between the generator and the grid, it is not a problem to remain connected. For variable speed systems with a doubly fed induction generator, special measures might be necessary, comparable to the measures developed for wind turbines.

Large numbers of ocean energy converters in ocean energy farms have to be connected to the grid via an offshore electrical infrastructure and at a suitable onshore connection point. Similar to offshore wind farms, large ocean energy farms are unlikely to be connected to the distribution systems, but more likely to the high voltage transmission system. In that case, the existing protection systems may be suitable and ocean energy farms will be operated in the same way as traditional large power plants.



As happened with wind farms, large ocean energy farms may have to contribute to voltage control by controlling reactive power generation and to frequency control by controlling active power generation. Most ocean energy devices have variable speed generator systems, connected to the grid via power electronic converters. Some electronic converters can control the reactive power flow, such as voltage source inverters. Other converters cannot control the reactive power flow or even deliver a varying reactive power, such as current source inverters.

When converters with the capability of controlling the reactive power are chosen, these can contribute to voltage control on the grid, as long as the rating of these converters is large enough. Long submarine cables will limit, however, the capability of the offshore power station to provide these services and special measures may have to be taken at the point of common connection.

For frequency control, it is necessary that the active power be controlled. This is especially difficult in systems without an energy buffer, because they depend on the incoming renewable power. In an ocean farm, it could be decided that the ocean energy converters should not produce the maximum power they can extract, so that the output power can be increased when required by the control system. This option will cost more than other options, but it is important to consider this at higher penetration levels to enable more conventional power plants to shut down to avoid curtailment.

In order to control the frequency of the grid when uncontrolled variations of the power delivered by an ocean farm occurs, it may be necessary to have increased short-term reserve capabilities in the power system. It is a question of providing more flexibility from existing conventional power plants, demand side, and by balancing larger areas. The most challenging situations are heavy storms when system is shut down often at short notice.

Other factors (not device specific) will also affect the electrical configuration of the ocean energy farm. These factors, which are shown in Table 1.2, may change over time as the ocean energy industry develops, but they will have a significant effect on decisions made at present.

Item	Description	Examples	Considerations
1	Status of technology – especially that associated with the ocean environment	DC link technology Subsea transformer, switchgear Dry-mate/wet-mate connectors	Is there a history of similar equipment/installations? How does the maintenance requirement balance with the accessibility? What is the reliability? Is it suitable for the environment in which it will be operated?
2	Cost of technology	Oil and gas industry costs	Existing subsea technology designed for deep water (1000 m). Losses are unimportant in oil and gas industry. Need to adapt this technology to make it adequate for shallow water (up to 100 m), high efficiency and far less costly.
3	Availability/cost of installation and maintenance support	Installation/support vessels, divers	Charter/hire of vessels very costly. Need to design to make installation/maintenance possible with lower specification of vessel, e.g., without dynamic positioning. E.g., for cable laying, cable splicing, static cable trenching, installation of subsea electrical infrastructure

Table 1.2: Ocean device specific factors affecting the connection configuration

## 1.7 GRID CONNECTION CODES

A key challenge for both wind and ocean renewables, with their intrinsically fluctuating power generation, are the grid codes and distribution codes for electrical transmission and distribution systems, which underpin the entire electrical grid operation. These rules require electricity suppliers to match their devices to the point of common coupling. Issues such as frequency stability, voltage, power factor, harmonics and fault level all need to be taken into account.

Ideally for grid connection of any generation technology, a predictable power flow is needed. The predictability of the power generated from tidal and wind turbines potentially makes them more positively considered by grid-operators. However, wave farms may use a range of methods to level the variable power flow seen from an individual device [19].

A majority of sites having good offshore wind and/or wave energy resources is located far from the main load centres and often have only a weak distribution grid available for interconnection. Linking electricity generation in these remote areas to the local grid can result in grid problems requiring costly reinforcement; hence, project costs may be prohibitive if significant deep reinforcement is deemed necessary.

Once ocean renewables are ready to progress to full scale farms, identifying appropriate locations should be quite straightforward, given the fact that much research has already been done in terms of the wave energy resource. Moreover, it is likely that very large ocean renewable farms will be built to take advantage of economies of scale and justify the construction of a common shore-based grid connection.

Historically, the first generating plants exporting energy to the grid have been ruled by two kinds of regulation: those concerning local grids and those required by the main transmission grid as a whole.

Distribution systems operators (DSOs) define local regulations, generally regarding voltage and current, through the issuing of distribution codes. Global grid regulations, focused on active and reactive power flow, are defined by transmission systems operators (TSOs) through grid codes.

The requirements imposed by these codes are generally different from one country to another. The growing interconnection between different national grids and the wind energy boom have recently highlighted the future need for a standard base for grid connection, common to all countries having the capability of interconnection with each other, such as in Europe.

A 2005 report from the European Wind Energy Association [20] summarises the principal issues related to grid connection of large wind farms. Table 1.3 shows a list of basic requirements imposed by national codes for wind energy. Such requirements have not yet been defined for ocean energy because of the negligible impact of wave and tidal energy production on global electrical power supply, but those defined for wind energy are likely to be applicable to future large scale ocean energy plants.

Large scale ocean energy farms installed to maximise energy output will probably have major limitations in terms of:

- Voltage and reactive power control
- Frequency control
- Fault ride-through capabilities
- Generator protection

These are the four main points that new grid codes are adapting for wind farm connections. The most troublesome problem would likely be a voltage dip in the grid depending upon the penetration level and the amount of installed capacity. The effects of transient faults may propagate over large geographical areas and the resulting disconnection of ocean energy farms under fault conditions could pose a serious threat to grid security and security of supply, because a great amount of wind power could be disconnected simultaneously. Table 1.3 summarises existing transmission codes for several European countries. Grid connected ocean energy devices will be required to comply with these regulations.

<b>Active power control</b>	Several grid codes require active wind farm power control to secure frequency stability, avoid grid overloading etc. The required extent of modulation of the power might change between the different grid codes.
<b>Frequency control</b>	Frequency control within acceptable limits to secure supply, avoid overloading and comply with quality power standards.
<b>Frequency range and voltage range</b>	The requirement to be able to continue to operate even when the system is in difficulty, i.e. when voltage or frequency are far from the nominal values.
<b>Voltage control</b>	This implies requirements for reactive power compensation.
<b>Voltage quality (rapid changes, flickers, harmonics)</b>	A whole set of different requirements is included in national codes.
<b>Tap-changing transformers</b>	Some grid codes ([21], [22]) require that wind farms are equipped with tap-changing grid transformers in order to be able to vary the voltage ratio between the wind farm and the grid in the case of need.
<b>Wind farm protection</b>	This category of requirements is intended for situations with faults and disturbances in the grid. A relay protection system should be present to act, for example, in cases of high short-circuit currents, undervoltages, overvoltages during and after a fault. This should ensure that the wind farm complies with requirements for normal grid operation and supports the grid during and after a fault. It should equally secure the wind farms against damage from impacts originating from faults in the grid. The fault ride-through (FRT) requirements fall under this category.
<b>Wind farm modelling and verification</b>	Some codes require wind farm owners/developers to provide models and system data, to enable the operator to investigate by simulations the interaction between the wind farm and the power system. They also require installation of monitoring equipment to verify the actual behaviour of the farm during faults and to check the model.
<b>Communication and remote control</b>	Unlike the requirements above, national codes are quite unanimous on this point. The wind farm operator should provide signals corresponding to a number of parameters important for the system operator to enable proper operation of the power system (typically voltage, active and reactive power, operating status, wind speed and direction etc.). Moreover, it must be possible to connect and disconnect the wind turbines externally ([21], [23]).

Table 1.3: Basic requirements imposed for wind energy generation by grid codes [21], [22], [23]

### 1.7.1 Voltage and Reactive Power Control

Under a simplified approach [24], it could be shown that the magnitude of the voltage is controlled by the reactive power exchange, whereas the phase difference between the sending and receiving end is dictated by the active power. The active and reactive power flow between the generation and the load in the power system must be balanced in order to avoid large voltage and frequency excursions.

Voltage regulation and reactive power control are fundamental in the distribution of electric energy. A mismatch between the supply and demand of reactive power results in a change in the system voltage: if the supply of lagging reactive power is less than the demand, a decrease in the system voltage results; conversely, if the supply of lagging reactive power exceeds the demand, an increase in system voltage results.

Voltage or reactive power requirements in the grid codes are usually specified with a limiting curve such as that shown in Figure 1.9.

The mean value of the reactive power over several seconds should stay within the limits of the curve. When the generating unit is providing low active power, the power factor may deviate from unity because it can support additional leading or lagging currents due to the reactive power demanded by the utility. When the generating unit is working under nominal conditions, the power factor must be kept close to unity or else there will be excessive currents.

Future ocean energy farms should have the capability to control the voltage and/or the reactive power at the connection point. Several methods for voltage control have been adopted in wind energy technologies ([25], [26], and [27]) and might be considered for application to ocean energy.

Other specifications for ocean energy converters might involve the quality of supply, including abrupt variations of the voltage level, flicker (low frequency perturbations of the voltage) and harmonics (high frequency perturbations of voltage, and intensity values, typically integer multiples of the transmission frequency).

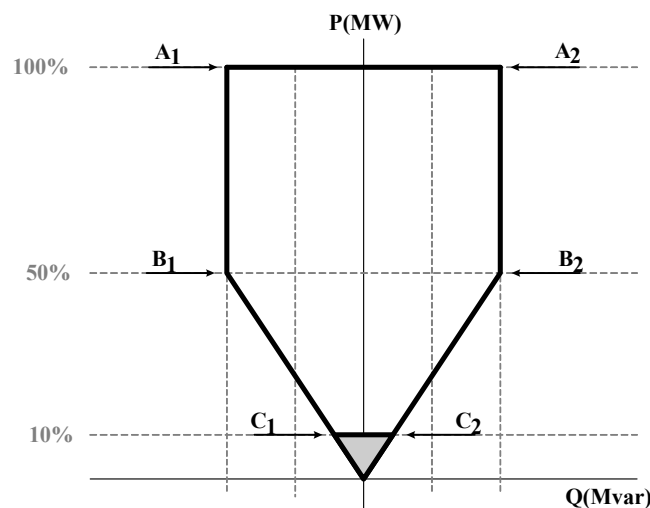

Figure 1.9: Typical limiting curve for reactive power [22].

## 1.7.2 Frequency Control

The frequency of a grid is an indicator of the balance between power production and consumption. Power sources in the grid are usually rotating machines (although many wave energy converters make use of linear generators for their conversion system) and the active power output of the generators is determined by the mechanical power input from their prime movers (steam turbines, hydro, wind, etc.).

The consequence of a mismatch between the supply (i.e., generation) and demand (i.e., load and grid losses) for active power is a change in the kinetic energy stored in the moving mass of the generators, and hence results in a drift in the system frequency.

Grid management usually considers an operating reserve sized to cover the loss of the largest generating unit of the system. Distinction can be made between spinning reserve (i.e., the difference between the total on-line generator capacity and the total output of the generators) and supplementary reserve (i.e., the amount of generating capacity that can be brought into operation within a limited time).

All the generating equipment in an electric system is designed to operate within very strict frequency margins. Grid codes specify that all generating plants should be able to operate continuously within a frequency range around the nominal frequency of the grid, usually between 49.5 and 50.5 Hz, or 59.5 to 60.5 Hz, depending on geographical location. Operation outside these limits would damage the generating plants.

Grid codes usually specify limiting curves for frequency controlled regulation of the active power. An example is shown in Figure 1.10.

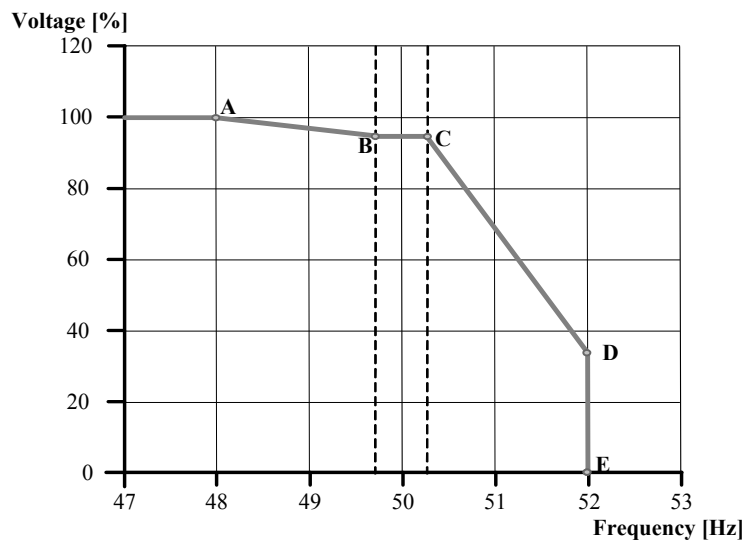

Figure 1.10: Typical frequency controlled regulation of active power [24].

Points A, B, C, D and E depend on a power system targets, a combination of frequency, active power and MW reduction. These requirements can vary for each farm, depending on the power system conditions and on the farm emplacement. In Table 1.4 can be seen the targets.

Operation point	Transmission system frequency (Hz)	Farm active power (% available power)
A	$F_A$	$P_A$
B	$F_B$	Lowest of: $P_B$ or MW reduction target
C	$F_C$	Lowest of: $P_C$ or MW reduction target
D	$F_D$	Lowest of: $P_D$ or MW reduction target
E	$F_E$	$P_E = 0$

Table 1.4: Farm transmission system frequency and active power targets.

The future deployment of large scale ocean energy farms might suggest modifications to national grid codes, as has been happening in recent years with wind energy depending upon the penetration levels. Some of these codes require wind farms to participate in frequency control of the grid through variation of the active power output. However, as for wind turbines, wave and tidal converters are not able to provide the same control available from conventional power plants.

While in the case of a grid frequency higher than the nominal value, it would be sufficient to disconnect a number of units, the underfrequency control would be possible only if the farm were operating at a lower capacity than normal conditions. Some additional power control strategies have been indeed defined in recent years for wind energy ([28],[20]) that contemplate the possibility of using a percentage of the active power capacity for reserves. That might be economically feasible if the tariff payment for low-frequency response were to compensate for the loss of generated power.

Other requirements for frequency control could include limitations on the positive and negative changes of active power output to avoid frequency fluctuations on the grid (ramp rates). This types of requirement already exists in several jurisdictions.

Figure 1.11 shows a summary of the frequency control requirements imposed on wind turbines by several national grid codes ([29],[30]).

53 (106%)	Disconnection after 0.3 s	Disconnection after 0.2 s	Not mentioned	Fast automatic disconnection	Not mentioned	Not mentioned	Not mentioned	Disconnection within max 1s
52.5 (105%)						110% > 30 min Reduced power volt. 95-105%	110% > 30 min Reduced power volt. 95-105%	
52 (104%)	1 min 100.6 - 106%	> 1 min 95- 106%						
51.5 (103%)			60 min (101-104%)	> 30 min (90-115% volt)	Continuous (90-111.5% volt)	volt. 85-90% or 105- 110% <10% power reduction, >1hour		Power reduction 2% per 0.1Hz (110.8-104%)
51 (102%)		Continuous (90-106% volt)				volt. 90-105% continuous	Continuous volt. 90-105%	
50.5 (101%)				Continuous (95-110% volt)		Continuous volt. 90-105%		
50 (100%)	Continuous (100-100.6%)	Voltage: 106-110%=>1min 85-90%=>1min 75-85%=>10s	Continuous (99-101%)	Voltage: 110-115%=>30min 90-95%=>2h	Voltage: 111.5-115%=>1h 87.5-90%=>3h 85-87.5%=>30min			
49.5 (99%)								
49 (98%)						>30 min <5% Power reduction volt. 95-105%	>30 min <5% Power reduction volt. 95-105%	Continuous (95-100.8%)
48.5 (97%)	25 min (96-100%)	25 min (95-106% volt)	60 min (95-99%)	> 30 min (90-115% volt)				
48 (96%)				> 20 min				
47.5 (95%)	5 min (95-96%)	5 min 95-106%		> 10 min	3 s			
47 (94%)	10 s	10 s	20 s					20 s
46.5 (93%)	Disconnection after 0.3 s	Disconnection after 0.2 s	Not mentioned	Fast automatic disconnection	Not mentioned	Not mentioned	Not mentioned	Disconnection within max 1s
	Eltra	Eltra&Elkraft	ESBNG	E.On	REE	SvK (>20MW)	SvK (<20MW)	Scotland

Figure 1.11: Summary of frequency control requirements imposed by several countries grid codes ([21], [22], [23], [31], [32], [33]).

### 1.7.3 Fault Ride-Through Capability

When a short circuit takes place at some location on the grid, the voltage on the faulted phases will be near zero. Due to the low impedance of transmission circuits, a large voltage depression would be experienced across large areas of the transmission system until the fault is cleared by the opening of circuit-breakers.

Older grid codes required the disconnection of wind turbines during such faults. But with the increasing relevance and amount of wind power production, these regulations had to be changed, since the simultaneous disconnection of many generators within the system by the fault may result in a drop in system frequency, and even a black-out.

In many countries (e.g., Denmark, Ireland, Spain) with a significant penetration level of wind power into the grid, wind farms are now required to have a fault ride-through capability for faults on the transmission system. Typical requirements for this case are described by a plot of the voltage against the time that specifies the area of the *voltage dip* that the installation must support (Figure 1.12).

During the fault clearing time and the subsequent voltage recovery, no reactive power should be consumed by the plant at the connection point and the installation should contribute to the grid with a current intensity as high as possible (Figure 1.13).

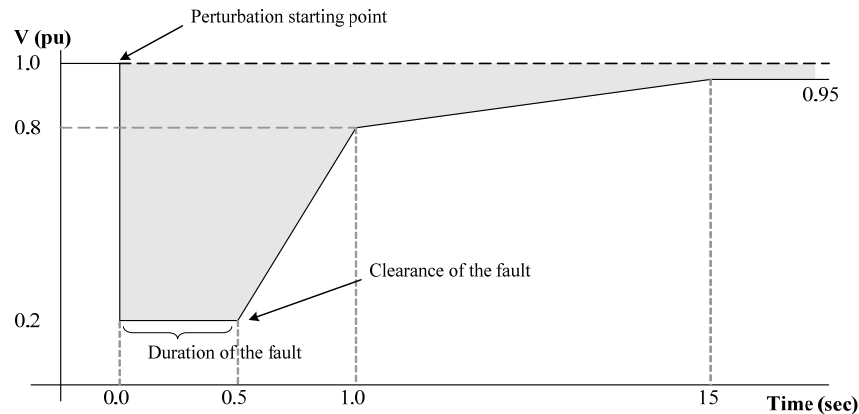

Figure 1.12: Curve of the voltage in function of the time at the connection point, defining the voltage dip area [32]

Currently at a pre-commercial stage, ocean energy technologies will not likely be relevant in terms of percentage of global electrical power output into the grid for nearly a decade. Therefore, it is expected that wave and tidal energy converters will be required to disconnect in case of faults in the early years. Large-scale wave and tidal current energy farms will likely require similar grid code requirements, as is happening for wind energy.



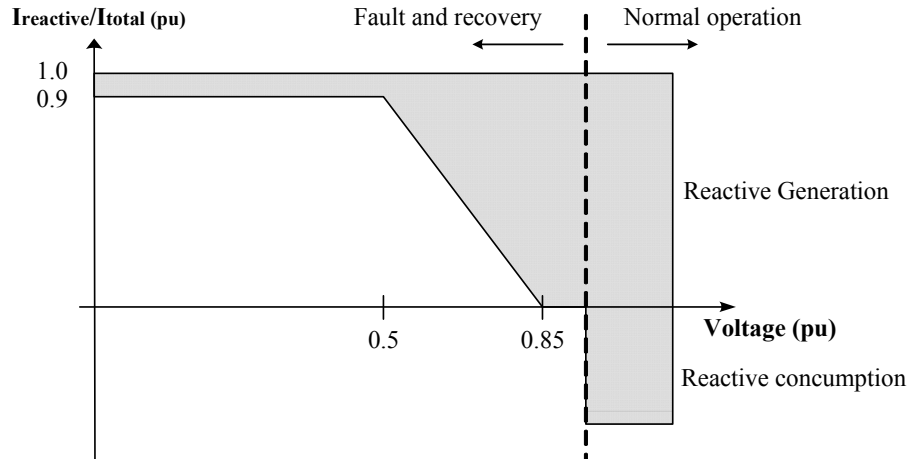

Figure 1.13: Operational area (in grey) during fault and recovery periods in function of the voltage at the connection point [33]

### 1.7.4 Relay Protections

Due to the installation of distributed generation, the traditional passive distribution grid will be transformed into an active one (including bidirectional powerflow). Therefore, some of the relay protections located in the distribution grid will not work properly because the power flow directions will change. For instance, it may be necessary to modify the overcurrent relays and islanding detection.

For overcurrent relays, when embedded generation is connected to a distribution feeder, the fault level at the point of fault will increase, but the fault current at other points on the feeder may increase, decrease or remain unaffected.

This causes major problems for conventional overcurrent relays which assume that down-line, on the load side of the relay, the current of the fault is near zero, while on the source side of the relay the fault current reduces or remains constant away from the fault towards the source [34].

Consequently, if the short circuit capacity of the embedded generator is high, as compared to the capacity of the grid supply, proper setting of the overcurrent relays becomes impossible. The problem can be resolved by the use of current differential protections or distance protections similar to those normally used on transmission feeders. Some of these differential of distance protection schemes can be expensive.

An alternative method is to employ directional overcurrent relays operating with directional comparison schemes.

In addition, it is necessary to improve/modify the islanding detection methods. A fault occurring in the power distribution system is generally cleared by the protective relay that is located closest to the fault location. As a result, the distributed generation tries to supply its power to a part of the distribution system that has been separated from the utility's power system [35]. In most cases, this islanded generation is then overloaded, and the system frequency may decrease rapidly.

## 1.8 INTERCONNECTION STANDARDS AND GUIDELINES

Most utilities worldwide have already dealt with Distributed Generation (DG) in one form or another; however, standardised practices in most cases have not yet been developed nor implemented. Interconnection requirements are typically treated more on a case-by-case basis using the methods accepted by the local utility. In order to permit greater integration, experience with integrating DG needs to be shared and contained in easily available documents describing its effect and the conditions under which integration is realistic and when it is not. This work is under way to a certain extent through the development of application guides, for example IEEE 1547 series [36]. Some relevant standards have already been issued. The OES-IA report T0312 [2] presents a summary of the existing interconnection standards and guidelines. The report identifies the areas where the existing guidelines could be modified to develop an appropriate guideline for ocean energy.

### 1.8.1 IEEE Standard for Interconnecting Distributed Resources with Electric Power Systems (IEEE 1547/2003)

This standard establishes a minimum collection of technical requirements, which are universally needed for interconnection of distributed generation, including requirements relevant to the performance, operation, testing, safety considerations and maintenance of the interconnection.

The criteria and requirements are applicable to all DG technologies, with aggregate capacity of 10 MVA or less at the point of common coupling, interconnected to electric power systems at typical primary and/or secondary distribution voltages. It is necessary to make clear that this standard does not define the maximum capacity of the DG to be connected to the point of common coupling (PCC).

#### ***General Requirements:***

- The distributed generation shall not actively regulate the voltage at the PCC and shall not cause the area power system service voltage at other local electric power systems to go outside the requirements of ANSI C84.1-1995, Range A.
- Apart from the effects in the power system voltage due to the DG, this shall not cause overvoltages that exceed the rating of the equipment connected to the area electric power system and shall not disrupt the coordination of the ground fault protection on the area electric power system.
- The DG unit shall synchronise with the electric power system without causing a voltage fluctuation at the PCC greater than  $\pm 5\%$ .
- The DG shall be able to detect and respond to abnormal conditions, which affect the voltage and frequency, as measured in the PCC.

The protection functions of the interconnection system shall detect the effective rms or fundamental frequency value of each phase-to-phase voltage. When any voltage is in a range given in Table 1.5, the DG shall cease to energise this area of the power system.

Voltage range (% of base voltage)	Clearing time (s)
$V < 50$	0.16
$50 \leq V < 88$	2.00
$110 < V < 120$	1.00
$V \geq 120$	0.16

Table 1.5: Interconnection system response to abnormal voltage.

## 1.9 ENERGY STORAGE

As in wind energy, the variability of the resource (wave/tidal) may in some cases limit the applicability of the generated power when these energy conversion systems are directly connected to the distribution grid in a Non-Integrated Area (NIA, known as an *Autonomous System* in some parts of the world). These variations influence the generated power in terms of constancy, which may cause an imbalance between local power demand and power generation. This disparity between consumption and generation may lead to adverse voltage variations and other effects regarding power quality. Integration of different types of renewable power generation (wind, wave, tidal, solar, etc., depending upon the resource availability in an area), energy storage options and other energy use (e.g., heating, cooling, transportation) could address the above imbalance for NIA/Autonomous systems.

For larger power systems with a large penetration of variable renewables and where the options to increase flexibility of the system do not exist, utilities are now looking into a range of energy storage technologies, as shown below:

- Compressed air energy storage: Off-peak electricity can be used to compress air and store the air in airtight underground caverns. When the air is released from storage, it expands through a combustion turbine-type generator to create electricity.
- Batteries
- Flywheels: A flywheel consists of a high-inertia, large-mass cylinder that spins at very high speeds, storing kinetic energy.
- Pumped hydro: Off-peak electricity is used to pump water from a lower reservoir into another one at a higher elevation, which is then used to provide on-peak energy by running the pump as a generator.
- Super capacitors: These offer a unique combination of high power and high energy compared with batteries.
- Superconducting magnetic energy storage: These store energy in the magnetic field created by the flow of direct current in a coil of superconducting material that has been cryogenically cooled.

The main parameters of interest with energy storage systems are power level, response time and storage capacity. Table 1.6 shows the properties of some relevant storage technologies.

	Capacity (MW)	Capacity (hours)
<b>Pumped hydro</b>	100...1000	>hours
<b>Compressed air</b>	0.1...1000	<few hours
<b>Flywheel</b>	0.1-10	0.1
<b>Battery</b>	0.1-10	0.1 >1
<b>Flow battery</b>	0.1-20	>1
<b>H<sub>2</sub>-Fuel cell</b>	0.1-1	>1

Table 1.6: Properties of some storage technologies [37].

As a system resource, the national electrical grid will benefit from energy storage technologies. To begin with, the power system already has storage in the form of hydroelectric reservoirs, gas pipelines, gas storage facilities and coal piles that can provide energy when needed.

Today, the storage of electricity is more expensive than using dispatchable generation, but in the future advances in technologies such as batteries and compressed air energy storage may make energy storage more cost-effective. The prospect of plug-in hybrid electric vehicles (PHEV) holds great promise, because they could provide many megawatts of storage for the overall electrical power system. PHEVs may assist renewable energy resources to directly displace consumption of transportation-related foreign oil. Yet, energy storage will be best used as a resource for the overall power system and not just a technology to manage variability on a per plant basis.

## 1.10 POWER SYSTEM SIMULATION TOOLS

There are a lot of simulation tools for power system analysis ([38], [39], [40], [41], [42], and others). Each simulation tool has its own advantages, capabilities and drawbacks.

The geographic location of the proposed generation project and the specific electric utility through which the ocean wave or tidal renewable energy generation developer plans to interconnect their generation project, will dictate which power system analysis software will be used by the electric utility for the feasibility, system impact, and facilities studies required as part of the small or large generation interconnection application procedure required by that utility ([43], [44], [45]).

The generation developer should be able to provide generator models and device data compatible with the system analysis software used by that utility, in order to facilitate completion of the required load flow, short circuit and transient stability studies in a timely manner.

It is highly recommended that ocean wave and tidal energy device manufacturers work with the developers of the software used by the various utilities to be certain that adequate modelling data is available for submittal to the utility with the generation interconnection/integration application.

Utilities around the world use various types of standardised power system analysis software for facilitating interconnection and integration of new generating plants as well as for planning infrastructure.

For the case studies reported in section 3 of this report, two different simulation tools DIgSILENT [41] and DSATools [42] have been used for distribution and transmission case studies, respectively. Scope of these two simulation tools is shown below.

PowerFactory [41]	
<b>Company</b>	DIgSILENT GmbH
<b>Address</b>	<a href="http://www.digsilent.de">http://www.digsilent.de</a>
<b>Description</b>	DIgSILENT PowerFactory is a leading high-end power system analysis tool for applications in transmission, distribution, generation, industrial and railway systems, wind power and Smart Grids.
<b>Overview</b>	<p>DIgSILENT PowerFactory is potentially economical solution, as data handling, modelling capabilities and overall functionality replace a set of other software systems, thereby minimising project execution costs and training requirements. The all-in-one PowerFactory solution promotes highly-optimised workflow. DIgSILENT PowerFactory is easy to use and caters for all standard power system analysis needs, including high-end applications in new technologies such as wind power and distributed generation and the handling of very large power systems. In addition to the stand-alone solution, the PowerFactory engine can be smoothly integrated into GIS, DMS and EMS supporting open system standards.</p> <p><i>Functional Integration and Applications</i></p> <ul style="list-style-type: none"> <li>▪ Implemented as a single software solution allowing for fast 'walk around' through the database and execution environment</li> <li>▪ No need to reload modules and update, transfer and convert data and results between different program applications</li> <li>▪ Vertically integrated power equipment model concept allowing models to be shared by all analysis functions</li> <li>▪ Support of transmission-, distribution- and industrial-system design and simulation</li> <li>▪ Modelling and simulation of railway systems</li> <li>▪ Simulation of any kind of wind turbines and wind parks</li> <li>▪ Smart Grid modelling including virtual power plants and distributed generation such as PV-panels, micro turbines, battery storage, CHP, etc.</li> </ul>

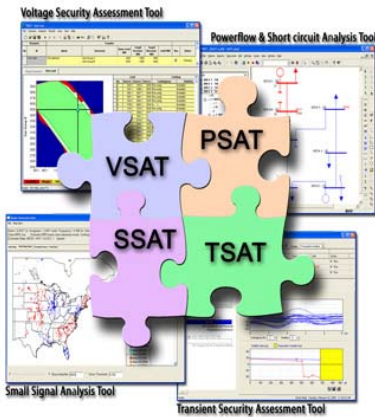
DSATools [42]	
<b>Company</b>	Powertech Labs
<b>Address</b>	<a href="http://www.dsatools.com">http://www.dsatools.com</a>
<b>Description</b>	Dynamic Security Assessment Software
<b>Overview</b>	<p>DSATools™ is a suite of state-of-the-art power system analysis tools and provides the capabilities for the comprehensive system security assessment including all forms of stability.</p> <p>DSATools™ includes necessary features and functions for power system planning and operational studies. In addition to rich modelling capabilities and leading-edge computational methods, the software package is loaded with many innovative application tools and can provide engineers with significant productivity improvements.</p> <p>This advanced software suite includes the following main components,</p> <ul style="list-style-type: none"> <li>▪ PSAT - Powerflow and Short Circuit Analysis Tool</li> <li>▪ VSAT - Voltage Security Assessment Tool</li> <li>▪ TSAT - Transient Security Assessment Tool</li> <li>▪ SSAT - Small Signal Analysis Tool</li> </ul> <p>The key components in this package, VSAT, TSAT and SSAT, have also been designed for on-line dynamic security assessment (DSA) when integrated to EMS through the DSA Manager module.</p> <div style="text-align: center;">  </div> <p><i>Impact assessment of renewable energy on system security</i></p> <p>Powertech has developed jointly with the Irish national grid company (EirGrid) a software solution to assess the impact of renewable energy on system security, the first of such technologies in the world. The Wind Security Assessment Tool (WSAT) is able to examine the security of a system with high level of renewable energy (wind, solar, battery, etc.) in terms of various criteria including thermal, voltage, transient and frequency performances. WSAT runs currently as a real-time tool at the National Control Center of EirGrid, providing EirGrid operators with valuable information on the security status of the system.</p> <p>As part of various concurrent projects, Powertech is aiming toward integrating various tidal and wave device models within its software offerings.</p>

## **2 GRID-CONNECTED PILOT PLANTS AND FUTURE GRID INTEGRATION ISSUES**

---



This chapter introduces operational characteristics of some current and future selective grid-connected wave and tidal current pilot projects and discusses predictability, dispatchability and capacity factor in relation to these plants. Then the chapter examines how different factors related to wave and tidal current energy systems affect potential grid integration issues such as:

- Voltage variations
- Flicker
- Fault ride-through capability
- Harmonics
- Short circuit, fault current contribution to system faults
- Transient stability during and after a system disturbance

### **2.1 GRID-CONNECTED PILOT PLANTS**

Ocean wave and tidal current power farms have some characteristics radically different from conventional power stations regarding predictability, dispatchability and capacity factor. Contrary to conventional power plants in which the power input is fully controlled, ocean farms cannot control the wave or tidal current energy input they harness to such an extent. These latter are very diverse in terms of dispatchability: they may range from partially dispatchable (e.g., tidal hydro-turbine with blade pitching capability) to non-dispatchable. As limited control is available at the primary power capture stage, resource predictability is a key factor in the operation of grid-connected ocean farms.

However, little literature is available on the topic as a very small number of devices have been operated for few years only and because some experimental data is confidential. In addition, the experience gained from these tests from a grid integration perspective has been limited for several reasons, sometimes including a small number of operating hours under nominal conditions. Some grid-connected wave and tidal current power plants are listed below.

WAVE POWER PLANTS	
<b>Pico OWC</b>	<p><i>Location: Portugal, Azores archipelago</i></p> <p><i>Starting year: 1999</i></p> <p><i>Power rating: 400 kW</i></p>
<p>Pico OWC was built in 1995-1999 with a rated power of 400 kW and has been operational since 2005, after several setbacks of the original project.</p> <p>The project was stopped in its first year of operation for several years due to an accidental inundation of the plant and some problems relative to the mechanical equipment. Its operating time has substantially increased over the last three years, reaching a total of 1,435 hours in 2010. [46]</p>	
<b>LIMPET</b>	<p><i>Location: Northern UK, Isle of Islay</i></p> <p><i>Starting year: 2000</i></p> <p><i>Power rating: 500 kW</i></p>
<p>The Islay Limpet is an OWC located on the Scottish Isle of Islay. It was commissioned in 2000 and has been operating remotely since then.</p>	
<b>Pelamis</b>	<p><i>Location: Portugal, Aguçadoura</i></p> <p><i>Starting year: 2008</i></p> <p><i>Power rating: 2.25 MW (3 devices of 750 kW each)</i></p>
<p>Pelamis attenuators were installed offshore in July 2008 and connected to the Portuguese grid in September of the same year. However, the wave farm was shut down few a months after in November 2008.</p>	







<b>Wave Dragon</b>	<i>Location: Denmark, Nissum Bredning</i> <i>Starting year: 2003</i> <i>Power rating: 20 kW</i>
<p>The Wave Dragon 1:4.5 small-scale prototype was tested continuously between March 2003 and January 2005. In 2006, a modified prototype was installed in the more energetic waters of Nissum Bredning and removed in 2008 for maintenance and repair. Globally, Wave Dragon claims it has an experience of 20,000 operating hours.</p>	
<b>OPT</b>	<i>Location: Kaneohe Bay, USA</i> <i>Starting year: 2009</i> <i>Power rating: 40 kW</i>
<p>A 40 kW point absorber was installed in 2009 in Kaneohe Bay, off the Big Island of Hawai'i. As of September 2010, it recorded 4,400 hours of operation.</p>	
<b>Oceanlinx</b>	<i>Location: Port Kembla, Australia</i> <i>Starting year: 2010</i> <i>Power rating: 2.5 MW</i>
<p>A third-scale prototype of the OWC was deployed for three months between February and May 2010. The device broke free from its moorings under extreme sea conditions in May of the same year [47].</p>	

Table 2.1: Examples of grid-connected pilot wave power plants

TIDAL CURRENT POWER PLANTS	
<b>SeaGen</b>	<p><i>Location: Northern Ireland, Strangford Lough</i></p> <p><i>Starting year: 2008</i></p> <p><i>Power rating: 1.2 MW</i></p>
<p>SeaGen is a system consisting of two twin tidal turbines. It was installed in Strangford Lough in 2008 and has been operating since then producing 3800 MWh/yr. [48]</p>	
<b>Uldolmok pilot plant</b>	<p><i>Location: Uldolmok Strait, Republic of Korea</i></p> <p><i>Starting year: 2009</i></p> <p><i>Power rating: 1 MW</i></p>
<p>Uldolmok Tidal Current pilot project is in the southwest coast of the Republic of Korea, where the tidal channel can exhibit a maximum water velocity of 6.5 m/s. Two 500 kW vertical helical turbine systems were installed in 2006. The tidal current power generating system is connected to a three-phase 22.9 kV electrical grid at the shore. [49]</p>	
<b>Enermar</b>	<p><i>Location: Messina Strait, Italy</i></p> <p><i>Starting year: 2005</i></p> <p><i>Power rating: 20 kW</i></p>
<p>The Enermar project consists of a 20 kW tidal turbine launched in the Strait of Messina. The turbine has undergone four years of testing from 2001 to 2005. After being modified to reach grid compliance with respect to the Sicilian requirements, it was redeployed in 2005. [50]</p>	



<b>Verdant Power Installation</b>	<i>Location: New York City, USA</i> <i>Starting year: 2006</i> <i>Power rating: 70 kW</i>
<p>Verdant Power installed two tidal turbines rated 35 kW each off Roosevelt Island in New York City. This demonstration project has delivered 70 MWh over around 9,000 operating hours. [51]</p>	
<b>Hammerfest Strøm</b>	<i>Location: Kvalsundet, Norway</i> <i>Starting year: 2003</i> <i>Power rating: 300 kW</i>
<p>The Hammerfest Strøm tidal turbine was installed in northern Norway in 2003 and has recorded 14,000 hours of operation as per December 2010.</p>	

Table 2.2: Examples of grid-connected pilot tidal current power plants

### ***Future Sites for Grid-Connected Wave and Tidal Current Power Plants***

The announced multiplication of grid-connected projects will hopefully provide the research community with more experimental data in the coming few years. Whereas some farms will be connected to already existing sites, other projects are underway in new locations. Table 2.3 shows some of these new grid-connected sites, currently under development.

Name	Location	Type
Irish national wave test site	Belmullet (Ireland)	wave
Wave Hub	Cornwall (UK)	wave
Bimep	Basque Country (Spain)	wave
Portuguese Pilot Zone	São Pedro Muel (Portugal)	wave
SEM-REV	Le Croisic (France)	wave
Jeju OWC	Jeju Island (Republic of Korea)	wave
Pentland Firth and Orkney Waters Project	Scotland (UK)	wave and tidal current
Bay of Fundy	Nova Scotia (Canada)	tidal current
Canoe Pass	British Columbia (Canada)	tidal current
Snohomish PUD	Washington (USA)	tidal current
Fromveur Strait	Ouessant Isle (France)	tidal current

Table 2.3: Selected future grid-connected sites/projects

## 2.1.1 Predictability, Dispatchability and Capacity Factor

### *Predictability*

Although tidal power variations, of semidiurnal/diurnal nature, are fully predictable, the level of accuracy currently achieved by wave energy forecasting methods varies significantly with respect to the timescale considered. In the range of 10 to 20 minutes, predicting sea-state averaged parameters, such as the significant wave height  $H_s$  and period  $T_z$ , involves lesser uncertainties than that of wind velocities owing to their slower frequency of variation. In addition, their direct dependence on wind conditions in the far-fetch still reduces the forecasting errors. Predicting such parameters can be achieved with a very reasonable accuracy with respect to the grid operator's potential future requirements [52], [53]. Tidal and wave energy can therefore be considered as more predictable than wind energy in a timeframe from tens of minutes to tens of hours. This good level of predictability is a considerable commercial advantage as, in the current electricity markets, the energy tariffs are determined on a one day-ahead basis. Also, grid operators demand that information on the power output of a power station be determined 48 hours to 72 hours ahead [54]. Hence, forecasting ocean power, and in particular wave power, at a time horizon of at least 48 hours will facilitate the large-scale integration of this new source of energy. Furthermore, the implications of forecasting quality are also economical for the ocean power plant managers whose income depends directly on the amount of electricity they inject into the grid. However, if the actual power output diverts from the schedule, financial penalties may be imposed on power plant managers.

Although wave power is relatively predictable on a sea-state timescale, forecasting wave power on a wave-to-wave basis is radically different. The prediction of the sea level elevation

over a given sea surface is almost impossible in practice, due to the huge computational effort. This wave-to-wave unpredictability may cause power quality and power system stability issues at a local level (such as flicker) if large ocean farms are connected to a weak, low-voltage network. Techniques are currently under development to predict sea level elevation at the precise location of a wave energy converter (WEC) [55], [56], [57], [58]. The objective of such local forecasting is to tune the device for each incoming wave in order to achieve resonance, which could dramatically increase its efficiency. However, it is not expected that such simulations will be utilised relative to local power quality purposes.

### ***Dispatchability***

The dispatchability of a power plant defines the ability of a grid operator to control its power output in order to regulate the electrical network, for instance for frequency control. Two types of dispatchability must be considered: short-term dispatchability, referred to as controllability and long-term dispatchability. The main difference between these two types is the amount of time given between the grid operator demand and the reaction of the power plant. Short-term dispatchability, or controllability, defines the ability of a power plant to adjust its power output at the request of the grid operator demand over a very short time scale of typically minutes. Power plants having a sufficient short-term dispatchability are utilised to balance the power system by reducing the discrepancy between power generation and real load demand. On the other hand, long-term dispatchability is characterised by the ability of the power plant to follow the daily power profile determined by the grid operator one to several days ahead.

The controllability level is not similar among all types of ocean devices, nor is their long-term dispatchability level. Some devices have a slowly varying input power (tidal devices), large storage and/or control means that can increase their dispatchability. By contrast, other devices have a fast varying power input (wave devices) and/or little control and storage means, which make them inherently less dispatchable. Most devices have some limited ability to respond to power constraint or power dispatch requests from the grid operator, as illustrated in Table 2.4.

As tidal current power is fully predictable, tidal turbines have hence the potential to become dispatchable. Their actual level of dispatchability therefore relies on the extent to which their power output may be controlled. In addition, if the resources are predicted accurately enough in the long term, tidal farms composed of fully controllable turbines may then become fully dispatchable. On the other hand, wave power is potentially less dispatchable due to the reduced time horizon available for wave power predictions. However, dispatchability, both short- and long-term, should not be considered only in the limited perspective of the characteristics of a single device. Ocean farms may be more dispatchable than their individual devices as the latter may be switched on or off in a farm to adjust with the power output demand. Dispatchability of marine farms must hence be discussed with respect to the variation of the input power, to the storage and control means, as well as to the number of devices included in a farm. However, very little literature is available on this topic and discussion in this field still remains relatively theoretical.

Device	Power Constraint	Power Increase
OWC	Blow-off valve	Turbine speed or blade pitch control
Point absorber	Ballast tank 'de-tuning'	Damping control through hydraulic system
Overtopper	Ramp level, buoyancy tanks, disabling turbines	Ramp level, buoyancy tanks, enabling turbines
Oscillating wave surge converter	Damping control through hydraulic system ('de-tuning')	Damping control through hydraulic system (tuning)
Submerged pressure differential	Damping control through hydraulic system ('de-tuning')	Damping control through hydraulic system (tuning)
Attenuator	Damping control through hydraulic system ('de-tuning')	Damping control through hydraulic system (tuning)
Tidal turbine	Blade pitch control	Turbine speed control
Oscillating hydrofoil	Blade pitch control, damping control through hydraulic system ('de-tuning')	Blade pitch control, damping control through hydraulic system (tuning)

Table 2.4: Response means to power dispatch requests

### ***Capacity Factor***

The capacity factor defines the ratio between the energy actually supplied by the power plant during a given period and the theoretical energy provided if the plant were operated at full rated power during this same time.

Some numerical values can be found in the literature regarding the capacity factor but their relevance should be discussed as no standard method was developed for evaluating this parameter. For instance, some developers define the rated power of a power plant as its peak power, whereas others determine it as the average power provided by the plant [3]. Then, although developers supply a majority of the numerical values found in the literature, few independent assessments were actually conducted. In addition, little literature on the methods or on the experimental data used for calculating those values is available.

Although important for knowledge of power plant characteristics, the experimental data obtained during testing must be considered carefully. The analysis of the experimental data over a certain period of time must consider whether the ocean farm was operated continuously over the whole duration of the period considered or not. There exist several reasons for operating an ocean farm discretely over time. The testing of specific features (e.g., control strategy under specific conditions) may need only a limited experimental time. Then, farms may be tested for a short duration during the year or shut down at very regular intervals for inspection, maintenance or even repair. In addition, they might also be tested in experimental conditions that can differ significantly from their nominal conditions and hence distort the results, as well as their interpretation, if considered in the perspective of nominal conditions. Hence, the context of the study must be borne in mind when analysing the capacity factor of an ocean farm and comparing it to that of other plants, such as wind farms. Numerical values for the capacity factor, as found in the literature, range between 8% and 40% for ocean farms. As a matter of comparison, the capacity factor for wind farms is usually

around 30% for onshore and 40% for offshore wind farms [59], [60]. Table 2.5 summarises the capacity factor of some pilot plants as found in the literature.

Pilot plant	Capacity factor
<b>WAVE POWER PLANTS</b>	
Pico OWC	8% [46]
Pelamis	25% to 40% [11]
Wave Star	16% to 34% [61]
Wave Dragon	23% [62] to 35 % [63]
<b>TIDAL CURRENT POWER PLANTS</b>	
SeaGen	36% [48]
Verdant Power	7% [51]

Table 2.5: Capacity factors for some pilot power plants

In the following sections of this chapter, three main aspects of generation, collection and offshore transmission of wave and tidal current power are explained in detail:

1. Layout of devices
2. Characteristics of conversion systems and control
3. Site selection

## 2.2 LAYOUT OF DEVICES

Existing marine energy converters rarely exceed several MW of maximum electric power. Therefore, the implementation of several hundred MW-rated wave energy farms implies the grouping together of many individual units. Tidal and wave energy farm layout studies deal with assessing optimal configurations in terms of profitability, energy efficiency and safe integration into the electric grid.

### 2.2.1 Basic Structures of Ocean Farm Electrical Systems

The electrical system of a marine energy farm can be considered as several levels of a set of equipment. Each level consists of many units of fundamentally similar equipment. Power can be thought of as flowing *down* through these levels from the power production to the grid system. Each level takes power from the preceding higher level in the system and delivers it to the next lower level in the system.

A generic farm layout normally consists of:

- Clusters (medium-voltage local collection system), collecting the power of several marine energy converters
- An integration system, raising if necessary, the voltage from medium to high voltage
- A transmission system (AC or DC) transferring the marine power to shore (to the grid integration point or point of common coupling)

Figure 2.1 shows three examples of potential wave farm spatial configurations.

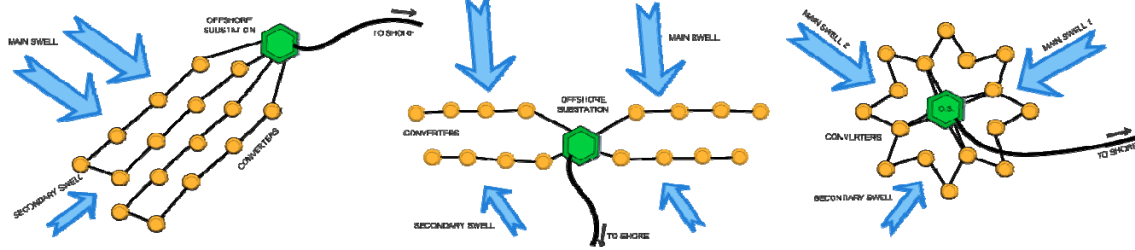

Figure 2.1: Examples of potential wave farms spatial configurations

The choice of spatial configuration might be motivated by technical requirements (expected power factor, voltage level and maximum power at feed-in point) and by economic considerations (Figure 2.2). Indeed, grid connection costs can actually be highly variable as depending on:

- The length of submarine cables from offshore (or nearshore) farm to shore
- The number of interconnecting power umbilical cables between generating units
- Potential need of offshore transformer substations
- Expected energy losses
- Potential requirements for subsea connection points

In the case of tidal turbines to be installed in shallow waters, layout configuration studies are expected to be very similar to offshore wind parks. Yet, when it comes to moored devices, e.g., most wave energy converters, the hydrodynamics of the whole anchored system would dictate the potential layout alternatives.



Figure 2.2: Interaction diagram: Main factors influencing the offshore farm layout design

The knowledge acquired in the offshore wind farm implementation has stressed that special attention must be paid to internal connections between the devices in the farm. Some configurations might be more suitable than others, depending on the specifications of voltage and power levels.



Concerning floating structures, inter-device flexible power umbilical cables must meet with mechanical requirements that may limit voltage levels to 6 kV or below, and prevent the use of oversized rated cross sections. A common reference voltage used in many pilot projects has been 3.3 kV.

Table 2.6 shows typical levels for offshore marine energy applications. The potential need of offshore substations for wave energy farms is stressed by the difference between the voltage levels used at the cluster system and those used at the transmission system, as well as the total power to be transmitted to shore.

Stage	Voltage Level [kV]	
Local Collection System (Cluster)	3, 6 (Umbilical cable) 10, 20, 33 (Static cable)	
Transmission Options	AC	33, 132, 150, 220
	DC	±80, ±150
Point of Common Coupling	Depends on the feed-in point (150, 220, 400)	

Table 2.6: Typical voltage levels for offshore marine energy applications [64]

### 2.2.2 Cluster Array Types

Connecting individually each device in a marine energy farm to shore would enable very flexible and reliable operation of the generator units. In most cases, this solution could lead to excessive costs for cabling and cable laying operations, even for small farms close to shore.

In addition, the number of devices connected to one circuit is limited as electrical barriers exist as a result of both the capacity of the collection cables and the voltage drop along their length. The maximum number of devices per circuit is therefore a function of the generator's rated capacity and adequate spacing between the different units of the farm. Therefore, generating units are grouped into medium-voltage electrical collection subsystems within the marine farm. Those arrangements, or clusters, are then integrated together via offshore platforms from where the transmission to shore is initiated.

#### *Types of Clustering*

The following types of clustering methods are considered in this work (Figure 2.3):

- String clustering without redundancy: The devices are connected in parallel along a single collection cable (C1 and C3).
- Star clustering: The devices are connected independently to a cluster nodal platform (C2).
- String clustering with redundancy: The devices are connected in parallel along a closed loop collection cable with a breaker controlling the power flow in the cluster (C4). Other redundancy designs might be implemented with this configuration.
- DC-series clustering: The devices are series-connected in several branches. This configuration can only be used in DC cluster technologies (C5).

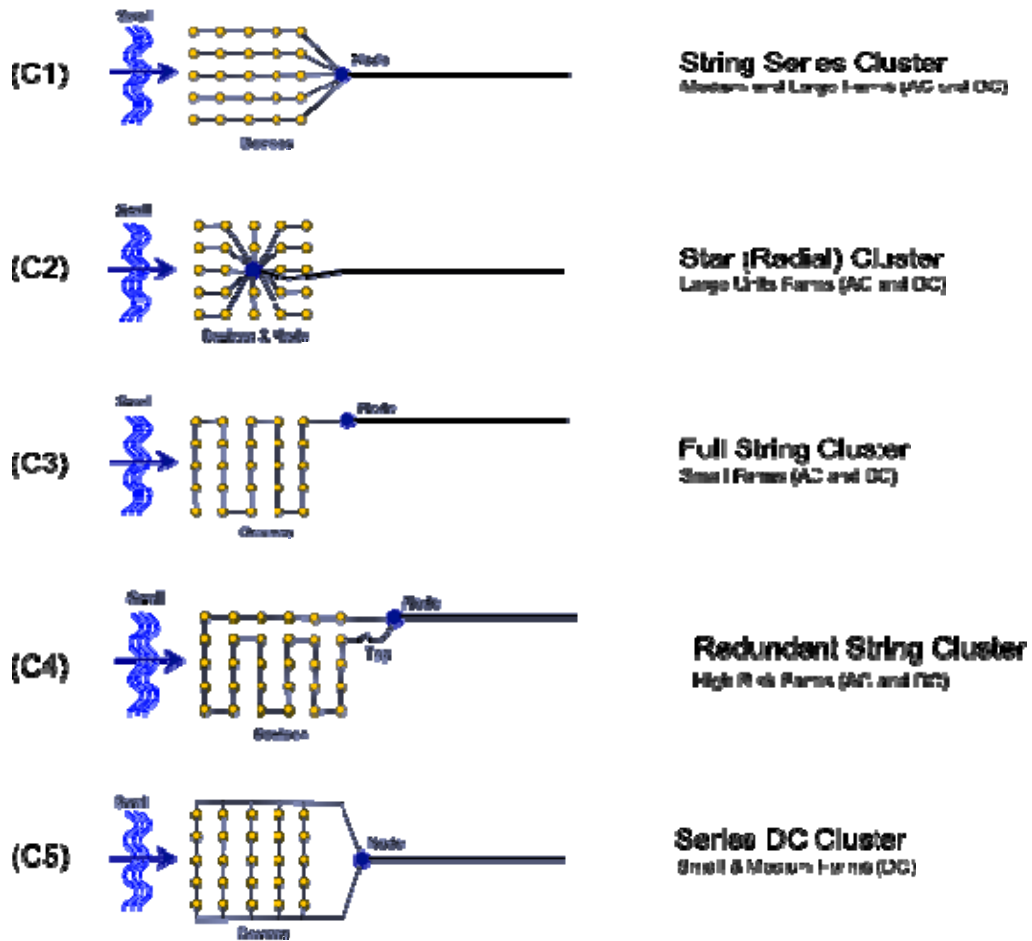

Figure 2.3: Main types of clustering for marine energy farms [64]

### *Number of Clusters per Farm*

The number of clusters determines the number of devices per cluster as the total installed power of the system is usually fixed because the licence for a wave farm is provided for a given power capacity. Different numbers of clusters imply different network topologies and, thus, result in different costs, power losses and reliability.

When the distance to an onshore connection point (PCC) is short enough and the total power flow reasonably low, considering independent transmission cables for each cluster can avoid the implementation of a complex offshore substation (Part 2.2.3).

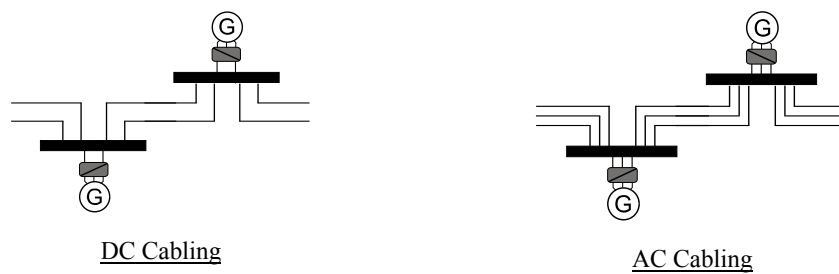

Figure 2.4: Interconnecting cables routes for AC and DC technology

Whether the distribution technology is AC or DC does not affect the cluster configuration, since the interconnecting cable routes are similar (Figure 2.4), except that in DC-series clusters, the devices are series-connected in order to raise the DC output voltage to a higher value at the node (see Figure 2.5).

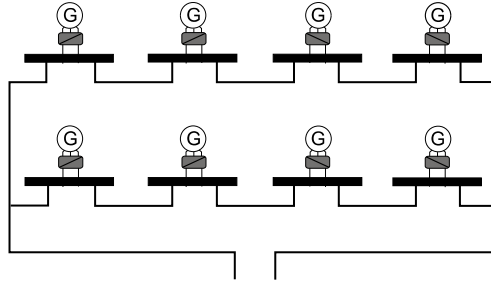

Figure 2.5: DC series cabling

The selection of cluster arrangements rely on the required availability level and on the faults of wave farms. In a fully linear cluster or string cluster (Figure 2.3), the main cable is the same for all devices. By contrast, the availability appears far better in the star configuration as devices are distributed over several cables. In comparison, each radial cluster often requires a nodal connection platform.

### 2.2.3 Integration Architectures

The voltage level of the transmission system could be medium- or high-voltage (MV or HV), and determines whether an offshore platform is required or not. If offshore platforms with transformers or converters (for AC/DC integrated network) are required, various ways can be considered for connecting the devices to the transmission system.

The following options are considered in terms of integration topologies (Figure 2.6):

- Option a: Devices are directly connected to shore.
- Option b: The farm consists of a single cluster, connected to shore by a single unique power cable.
- Option c: The farm is constituted by several clusters independently connected to shore.
- Option d: The different clusters of the farm are coupled together and share the same transmission cable to shore.

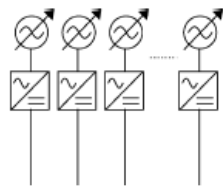

a) Individual transmission

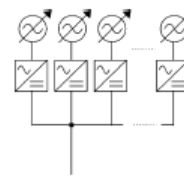

b) Single clustered farm transmission

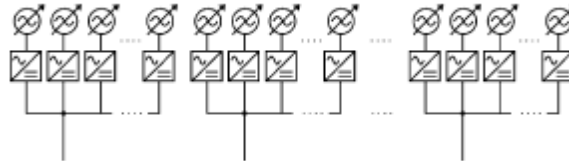

c) Clusters independent transmission

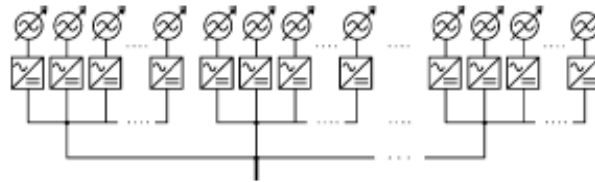

d) Multi-clustered farm single cable transmission

Figure 2.6: Integration topologies [65]

A combination of these architectures is possible, since for availability requirements the introduction of redundant components has to be envisaged. When an offshore platform is required, appropriate switchgear at certain locations can optimise the farm security of supply. A comparison of the different integration configurations is shown in Table 2.7.

Evaluation of connection configurations				
Concept	Configuration a	Configuration b	Configuration c	Configuration d
<b>Pros</b>	Very high availability Low losses Very simple configuration	Very low installation cost Simple maintenance.	High availability	Low installation cost
<b>Cons</b>	High installation cost Connections onshore necessary	Low availability May imply high losses	Connections onshore necessary	Difficult to find faults Complex system
<b>Possible installation option</b>	Very small farms close to grid	Small farms with low risk	Large farms with high risk	Large farms with low risk

Table 2.7: Comparison of the different integration configurations [64]

## 2.2.4 Electrical Transmission Options

To date, only a few grid-connected marine devices have been operating and always for a limited time and at a small scale (refer to section 2.1). Hence, the issues relative to the optimal design in terms of electrical configuration infrastructure have emerged only recently among the ocean energy community of researchers and developers.

Present projects mostly concern single ocean converters to be deployed at short distances from shore and are principally aimed at demonstrating the technology rather than maximising the power transmission [66].

Deployment sites are often chosen mainly for practical and economical reasons. These reasons include the availability of suitable grid connection points onshore, and the minimisation of additional electrical infrastructure to avoid additional costs.

A limited distance to shore allows reasonably efficient power transmission at low (LV) or medium voltage (MV). As the size of offshore farms increases, so does the need of higher voltage transmission.

Electrical cable connection is a key issue particularly for wave devices where the power take off is subject to tidal rise and fall, or where the device needs to re-orient itself to capture the tidal flow or the waves energy. In these cases, flexible cables are required. These issues have, to some degree, been solved for oil and gas applications. However, their applicability to marine energy is limited by the higher power and voltage ranges required in the case of wave energy farms.

Ensuring cable reliability remains an area of concern. It is not yet clear whether generic or standardised electrical connection techniques can be developed for all marine renewable technologies. Future economies of scale can be expected to reduce the impact of these components on the global cost of the installation.

Existing transmission alternatives for offshore power, namely high voltage alternating current (HVAC) and high voltage direct current (HVDC) voltage source converters (VSC) are described in the following sections.

### ***HVAC Transmission***

Most of the existing subsea transmission systems use HVAC transmission for the transport of electrical power between mainland and offshore stations. The main components of an HVAC system are:

- AC collection system at the platform
- Offshore and onshore transformation substations with AC transformers and reactive power compensation
- Three-phase submarine cable (generally cross-linked polyethylene (XLPE) three-conductor cable)

When the transmission line and the grid feed-in point voltage levels are equal, a transformer is not necessary. The distributed capacitance in submarine AC cables is far higher than in overhead lines. Thus, the allowable transmission length is dramatically reduced for marine applications. Since induced reactive power increases with voltage and length of the cable,

long distance transmission requires large reactive compensation equipment at both extremities of the line (refer to the section 2.3.2).

### Main Configurations [64]

*Small farms nearshore:* A first basic concept of an electrical transmission system might consider separate connection between each marine energy device and the onshore substation (see section 2.2.3). In this case, the installation of an offshore substation could be avoided.



Figure 2.7: HVAC transmission - small farm (T1).

This type of configuration is most likely to be applied to early stage marine farms or single devices, especially if placed at a limited distance from the PCC (e.g., EMEC or the Irish Belmullet test sites). Since the transformer should be installed on board (limited space) it is likely that only medium voltages are reachable (11 kV-33 kV).

This configuration has the clear advantage of avoiding the requirement for an offshore substation but the need for several cables and low to medium voltage transmission makes it suitable only for a very small number of devices and a very short distance to shore.

As commented before, another asset of this architecture is the higher availability provided by the independent connections to shore (a fault on one of the cables would not mean a complete loss of power production). In addition, in the case of test sites, where devices from different companies may be connected to each cable, this cluster configuration would make power metering significantly more straightforward.

*Large farms offshore:* Larger-scale farms would likely have an offshore substation with a shared transformer to raise the voltage level. Losses in the cables would be consistently reduced, due to higher voltage transmission.

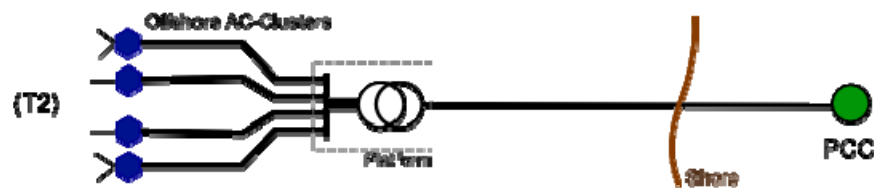

Figure 2.8: HVAC transmission – large farm (T2).

Yet, large distances from shore suggest the need for reactive power compensation in order to comply with power quality requirements. This equipment would be integrated into the offshore substations.

In addition, larger farms might allow the possibility of connecting different clusters of arrays so as to increase the availability of the whole plant (at the transmission level). Another advantage is the possibility to install different marine energy technologies in such a way that

each of them could generate on a different transmission line (open sea testing facilities take this advantage into account). This of course would require an additional cost in terms of transformers, protection systems and cable laying operations.

### ***HVDC Transmission***

The utilisation of HVDC technology for the offshore grid is very attractive since it offers the controllability needed to allow flexible and dynamic voltage support to AC onshore networks and therefore connections to both strong and weak grids.

There are two basic types of HVDC transmission links:

1. Conventional HVDC LCC (Line Commutated Converter)
2. HVDC VSC (Voltage Source Converter)

Today, offshore projects favour VSC technology as the best option. The technology is actually suitable for the range of capacities and distances usually involved in offshore applications with minimal losses. Its compactness (higher frequency switches and therefore smaller components) compared to LCC, is also an advantage when it comes to the environmental impact and offshore construction costs (platforms, etc.). For these reasons, LCC technology has not been considered in this document.

There are three major manufacturers of HVDC VSC technology:

1. ABB, using the brand name HVDC Light
2. Siemens, with its technology HVDC Plus
3. Areva

### **HVDC VSC Technology**

HVDC VSC is a recent technology, in which thyristors can be replaced by high power IGBTs with a switching frequency range of one to two kiloHertz, with much lower harmonic distortion than LCC systems, though with higher power losses.

HVDC VSC systems allow independent and total control of active and reactive power at each extremity of the HVDC line (which is not the case with LCC systems) and power transmission can be controlled with high flexibility.

For instance, reactive power can be supplied for marine energy generators at the offshore station and, at the onshore substation, reactive power can be used to regulate voltage at the Point of Common Coupling (PCC). Inline losses are consequently dramatically reduced.

A HVDC VSC system consists of the following main components:

- Transformers
- HVDC VSC converter substations (offshore and onshore, possibly hosting the transformer as well)
- Filters in both AC and DC sides
- DC voltage bus capacitors
- DC cables

VSC is a modular system. A staged development is possible as marine energy farms expand and stranded investments can be more easily avoided. Finally, it can be used to provide black

start capability, i.e. the process of restoring a power station to operation without relying on the external electric power transmission network [67] which makes it suitable for meshed grids [68].

Main Configurations

*AC-Cluster HVDC Transmission:* Assuming that all devices are equipped with a converter and a transformer, a first HVDC option would be power generation and transmission to an offshore substation at 11 kV, where a large transformer would raise the voltage up to 132 kV or more. The VSC converter would then rectify the current to transmit the energy along the cable. The onshore stations would include another converter and possibly a transformer to lower the voltage depending on the grid voltage at the connection point (Figure 2.9).

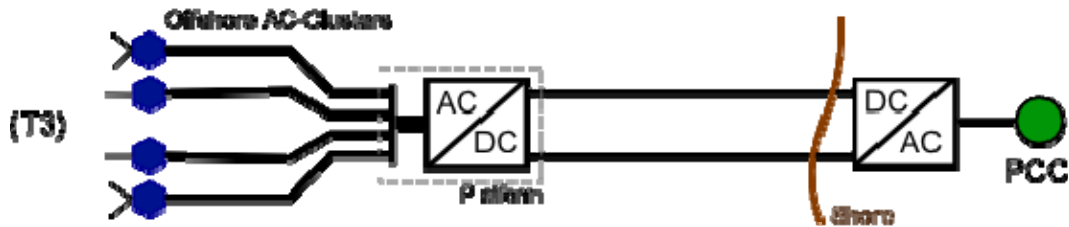

Figure 2.9: HVDC transmission – large AC-clustered farm (T3)

*DC-Cluster HVDC Transmission:* Several alternatives exist when the collection grid is in DC. One envisaged option particularly adapted to DC-star clusters consists of two offshore transformation steps to increase the voltage from the generators to a suitable level of transmission (Figure 2.10).

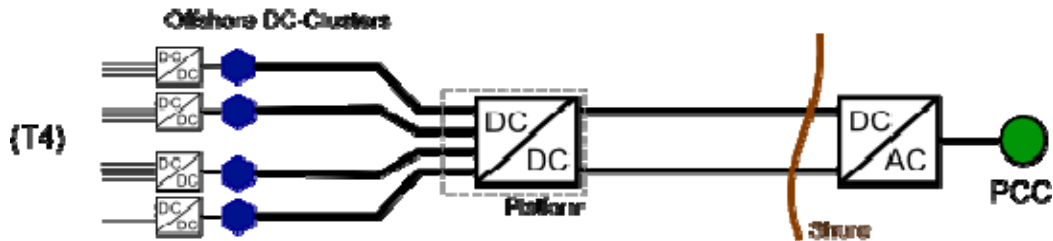

Figure 2.10: HVDC transmission – large DC-clustered farm 1 (T4)

This option would be particularly feasible if high voltage transformers (>132 kV) were installed on board the marine energy devices, avoiding too complex offshore substations and bringing drastic reduction of costs and energy losses. Higher voltage outputs can also be obtained by connecting the DC units in series [69], as was suggested for the DC-Series Cluster. This alternative is shown in Figure 2.11.

For significantly large farms, it might be relevant to notice that an offshore coupling substation would be necessary to provide a DC bus with appropriate and expensive switchgear equipment for high DC power.



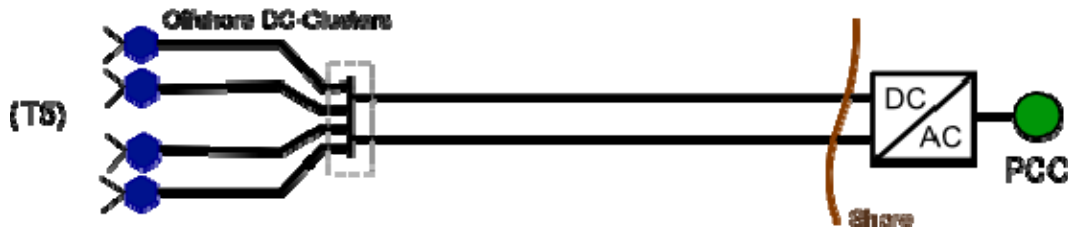

Figure 2.11: HVDC transmission – large DC-clustered farm 2 (T5)

For a small DC offshore farm (Figure 2.12), a topology similar to the HVAC transmission for AC farms may be feasible. The only difference would be the replacement of the onshore AC transformer by a DC transformer and a converter. Obviously, a rectifier would be embedded in each marine energy device (DC-clusters). Compared to large DC-parks, the advantage is that it does not require any offshore platform.



Figure 2.12: HVDC transmission – small DC-clustered farm (T6)

### ***Comparison of Transmission Systems***

HVAC systems are widely used. HVAC has lower costs than HVDC for short-transmission distances (distances shorter than 50 km, although this distance may be reduced in the near future). A major drawback of HVAC is limited maximum transmission distance, due to reactive power consumption compared to HVDC.

In addition, HVDC needs less cabling than equivalent HVAC. This results in a considerable cable and installation cost reduction, while the maintenance and fault rate are notably improved.

HVDC has many technical advantages that can be very important if the contribution of marine power generation is expected to be a major player in electrical energy generation and grid stability. The primary advantages are:

- HVDC cable losses are lower than in HVAC cable. HVDC VSC [70] systems have a power loss in the power converter of four to five per cent which may offset the gain in the cables.
- Asynchronous connection between the marine energy farm and the grid. The frequency and phase of both receiving ends do not have to be synchronised since the DC link decouples both ends. Grid voltage dips and other faults have no direct effect on the generators of the marine farm. There is more flexibility in the design of the generating units.
- HVDC allows almost instantaneous control of transmitted power and the system can contribute to the frequency control of the grid.
- HVDC VSC can control reactive power independently and voltage control is achieved, which is particularly important if the grid connection is weak.

- HVDC does not increase the short-circuit current of the system.

It is obvious that the main reason for the use of HVAC would be the lower cost at distances less than 50 km. This distance is being reduced with the decreasing cost of silicon power switches. If environmental and stability criteria are also included in the choice of the system, then HVDC may be a better choice in most cases [71].

### **2.2.5 Generation Units and Conversion Systems**

In this section, the main generation systems and possible basic structures of the electrical system for offshore marine farms are reviewed in order to understand how the specific devices, the cluster types, the integration system and the transmission configurations can work out in an optimal way.

#### ***Generation Units***

Marine generator technologies may be divided into two categories: fixed speed and variable speed. In the first category, power electronics play no active part; where in the second category, there may be partially-rated power electronics or full-scale power electronics used to interface between the generator and the grid.

A non-exhaustive list of typical generation units likely to be used in wave and tidal power are presented in Figure 2.13.

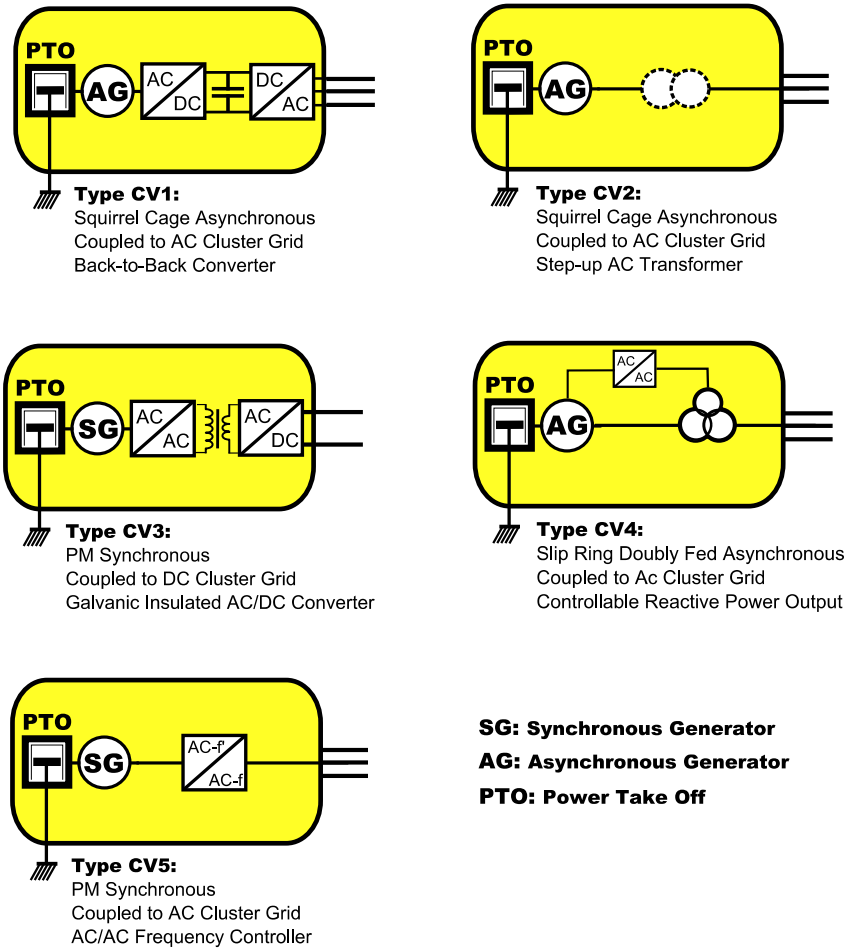

Figure 2.13: Generation units configurations used in marine offshore energy

Reliable information on asynchronous and synchronous generator technologies and their embedded regulation systems is widely available. In this section, the main purpose is to explain the relationships between those technologies and the farm layout design process.

### Speed Regulation

Sometimes, the power electronic converters are not isolated but shared by the whole cluster, or even the whole farm, mainly in order to reduce the number of power electronic converters and their associated overall costs.

*Fixed-speed system:* Fixed-speed generators are connected to the grid system directly without power electronics. The advantage of these systems is that they are robust and economical. Mechanical components must absorb significant torque pulsations. In fact, the rotating parts have an almost fixed speed and are unable to store any significant energy from the power pulsations.

These pulsations are also seen in the output power from a fixed speed generator and cause voltage flickers on the grid. Another drawback is that the reactive power cannot be controlled, except using a fixed-speed synchronous generator, so a reactive compensation (switched capacitors or static compensators) is required for such systems.

*Individual variable speed:* There is an embedded converter in each device. Thus, every generator can work at its optimum speed. There are various types of individual variable-speed configurations depending on the following options:

- With or without a high voltage direct current (HVDC) transmission system
- AC or DC integration system
- With or without a DC–DC converter to raise the DC voltage levels

*Cluster-coupled variable speed:* There is a common converter for each cluster. In such systems, the speed and electrical frequency vary proportionally with the average marine resource flow (tidal current speed, mean sea-state, etc.) in the cluster. The mechanical loads on the prime mover and the drive train are possibly higher than those in an individual variable speed system.

*Wave park-coupled variable speed:* All generators have the same electrical frequency, which can either be constant or can be controlled more or less in proportion to the average marine power in the farm. The mechanical loading will be higher than with the cluster-coupled variable speed. This option is feasible when supported by device-embedded energy storage systems (flywheels, hydraulic accumulators, super capacitors, etc.) to have a primary control of the mechanical torque fluctuations.

### ***Fixed versus Variable Speed***

The choice of appropriate generator-converter system is to a large extent determined by the type of control required of the wave energy farm. From the electrical point of view, constant-speed systems are preferred for their simplicity, robustness and low cost.

From the power take-off point of view, variable speed brings the following advantages:

- Lower mechanical stresses (smoothed torque spikes on the generator shaft)
- Higher energy yield (Maximum Power Point Tracking [MPPT] enabled)
- Quasi-constant electrical power (when the PTO works with an intermediate energy buffer such as a hydraulic accumulator or an inertial flywheel, for example)
- Reduced vibrations at lower speeds

In constant-speed systems, the use of two speeds allows keeping a good level of energy extraction, but still less than the total energy yielded by variable speed systems. The latter main disadvantage is the additional cost required for the power electronic converter.

## 2.3 CHARACTERISTICS OF CONVERSION SYSTEMS AND CONTROL

The conversion process can be broken as follows [3]:

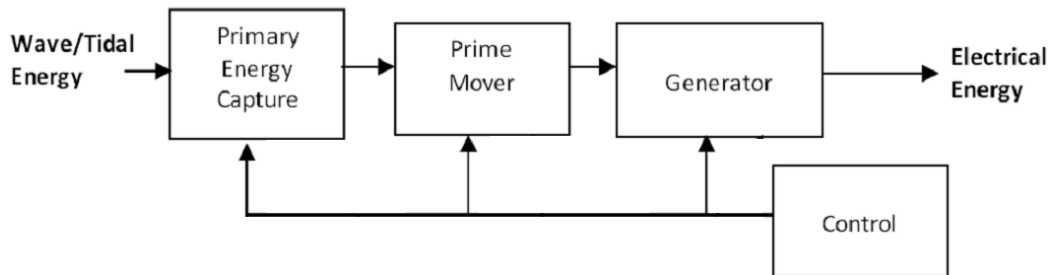

Figure 2.14: Typical ocean energy conversion process

Taking into account the primary energy capture, the reference [3] discusses major classifications of wave and tidal current conversion systems.

Due to the great variability of the wave resource, it is difficult to provide a continuous and stable supply to the grid. Apart from the presence of power electronics, the use of storage elements like accumulators, flywheels, or batteries may be necessary.

The prime mover can be generally seen as a power conversion stage between the low speed, high force primary PTO component and the high speed, lower force/torque generator. The output of wave energy converters is the output of the generator connected to the PTO. Apart from converting the energy from the primary power capture into mechanical power to be used by the generator, one important task of the PTO regarding power quality is the capacity of decoupling the mechanical torque from the motion in some wave energy converters (WECs). That is, the objective is to smooth the output and control the active and reactive power. To this aim, power electronics are very useful. Fully-rated power electronics can allow modelling of ocean energy converters by representing a back-to-back converter only, as the generator is in this case completely decoupled from the grid.

The effect of the wave energy conversion principle on power quality, in the case of a direct drive generator without power electronics, is very important since the variability of the waves is not smoothed with any kind of storage or compensation; therefore the output will have the same varying frequency and varying amplitude as the resource. This is the reason why power must be modified before the grid connection. Power electronics allows active and reactive control. For example, in [72], an oscillating buoy with a linear generator coupled to a rectifier and filter has been simulated and the need for the power electronics has been proven. The results show that the amplitude of the translator motion can be reduced by using a filter with a high capacitance.

Regarding control of reactive power, this can be done at farm level or at device level with a specific instantaneous reactive control. In the case of having a farm control, it may respond to the demand from Transmission System Operator (TSO) or Distribution System Operator (DSO).

### 2.3.1 System Modelling Detail Level

To evaluate the performance of a wave energy converter with realistic PTO configurations, moorings, control systems and other contributions, time-domain models are required to avoid the non-linearity arising from the different elements of the model. The developers, in order to give a correct estimation of the expected power output of their devices, will have to apply these models and will be asked about the accuracy they can provide, particularly on what concerns the performance of the device at a particular location [73].

Depending on the purpose of the analysis, the level of detail in the representation of the components of the system will vary. Thus, specific models, simulation software and simplifications are necessary in order to obtain valid and accurate simulation results [74]. An example of the kind of model required depending on the type of analysis desired is shown in Table 2.8:

Model	Type of analysis
<b>Steady-state static models</b>	Voltage variation
	Load flow
	Short-circuits
<b>Transient-state dynamic models</b> <b>Functional models</b>	Transient stability
	Small-signal stability
	Transient response
	Steady-state waveforms
	Synthesis of control
	Optimisation
<b>Transient-state dynamic models</b> <b>Mathematical physical models (power electronic)</b>	Start-up transient effects
	Load transient effects
	Fault operation
	Harmonics and sub harmonics
	Detailed synthesis of control
	Detailed optimisation

Table 2.8: Model types versus analysis type [75].

### **2.3.2 Control of Oscillating Wave Energy Converters**

The use of control engineering to optimise wave energy conversion was first proposed in the mid-1970s by Budal ([76], [77]) and independently by Salter ([78], [79]). For the practical implementation, it was proposed to use a controllable power take-off device, for instance a combined generator and motor. With this kind of continuous control, the objective is to achieve optimum phase and optimum amplitude of the oscillation ([80], [81]). It is important to note that in the case of the continuous phase control there is no reversal of power flow direction, which decreases the electrical stress on the electrical equipment.

For this purpose, it may be necessary that the instantaneous power conversion through the power take-off device be reversed during small fractions of the oscillation cycle. For this reason, the term “reactive control” has been used for continuous phase control. Later Budal proposed that approximate optimum phase control might be conveniently achieved by latching the wave absorber in a fixed position during certain intervals of the oscillation cycle. With this method, control action is applied at discrete instants of the cycle. This is an alternative to the continuous phase control realised through a combined generator-and-motor or turbine-and-pump.

In order to obtain the maximum energy from the waves, it is necessary to have optimum oscillation of the wave-energy converter for each wave climate. A single-mode oscillating system happens to have the optimum phase condition if it is at resonance with the wave. The wave frequency (reciprocal of the period) is the same as the natural frequency of the oscillating system. Then the oscillatory velocity of the system is in phase with the wave exciting force that acts on the system.

The control strategies can be defined and applied with reference to two different time scales. The first control option is to operate at a sea state level, that is to say, the properties of the system are modified depending on the sea statistical parameters over a relatively long time corresponding to the length of a sea state. The second control option can be called wave-by-wave control, meaning that the control is based on instantaneous measured wave properties, adapting the system properties to increase the efficiency.

#### ***Slow Tuning Control***

This control strategy consists of changing the device properties based on time-averaged sea state. In this case, the time is not as important as in the fast tuning control strategy [3] because the sea state changes much less frequently than individual waves. This strategy can involve adjusting the resonant frequency of the device [82].

#### ***Fast Tuning Control***

The wave energy converters that use this strategy are controlled based on real-time conditions. The system controller tunes the motion of the device to immediate wave amplitude.

Depending on the device, the control may be different. A typical example of wave-by-wave control is the use of valves in a hydraulic PTO. This is a typical energy conversion system used in many types of wave energy converters, usually consisting in a double-acting cylinder and two or more accumulators, reserving fluid at different pressures and linked between them by a hydraulic motor connected to an electric generator. For the purpose of control and

modulation of the power output, the hydraulic circuit might include a certain number of valves that can set the pressure levels within the accumulators.

The control of this system may be managed by means of control valves whose opening will depend on the sign of the velocity of the buoy and the pressure level of the accumulators. Different control variables can be used depending on the wave inputs considered in order to improve the power extraction of the converter. First, the torque of the electric generator can be used as a primary way to modify the load of the PTO. Extra accumulators can be used as storage devices to perform a kind of phase control on the buoy. The benefit of this effect will be dependent on the instant of activation of the valves that connect them to the circuit [83].

In the case of an OWC, the pressure valves can be used to optimise the pressure variation. In a variable speed turbine, the control to optimise the power extraction can be done by the variation of the torque of the generator that is coupled to the turbine.

For these types of control strategies, the timing of the control action is very important. If the control is applied in a wrong instant, the efficiency of the system can decrease.

Control strategies can have different objectives: maximisation of the average power output, stabilisation of the output (in terms of rotational velocity and/or electrical power) and stabilisation of the pressures inside the accumulators (for survivability of the hydraulic equipment).

### **2.3.3 Reactive Power Compensation Technologies for Control of Grid Integration**

The increasing penetration of distributed generation devices is changing the topology of the electrical grid. The impact of distributed generators is negligible nowadays, but it will become very important in a few years. The control of power quality can be done at two different levels: the first one will be the control of energy that is fed by a single device of the farm to the grid; and the second will consist of the control of the power given by the farm to the grid.

The problem of reactive power compensation can be divided in to two aspects: load compensation and voltage support. In load compensation, the main objectives are to increase the value of the system power factor, compensate voltage regulation and eliminate current harmonic components. Voltage support is generally required to reduce voltage fluctuation at a given terminal of a transmission line. Reactive power compensation in transmission systems improves the stability of the AC system by increasing the maximum active power that can be transmitted.

For example, in installations producing electricity from wind energy, the objective is to adapt reactive power in such a way that wind provides a maximum amount of support at any given moment to the electrical network. There are different technologies that are used for this objective according to the characteristics and specific needs of each farm [84]:

- Automatic switched capacitor banks
- Static VAR Compensators (SVC) -TCR/TCSC
- STATCOM (Static synchronous compensator)
- Power converters within the wind turbine (e.g, DFIG)



## ***Automatic Switched Capacitors Bank***

Automatic switched capacitor banks are used for power factor correction at main and group distribution buses. They consist of stages controlled by a reactive power controller, which ensures that the required capacitor power is always connected to the system.

## ***Static VAR Compensators***

Static VAR compensator (SVC) generators are used to improve voltage regulation, stability and power factor in AC transmission and distribution systems. VAR compensation is defined as the management of reactive power to improve the performance of AC power systems. The concept of VAR compensation embraces a wide and diverse field of both system and customer problems, especially related with power quality issues, since most of power quality problems can be attenuated or solved with an adequate control of reactive power [85].

The compensator normally includes a thyristor-controlled reactor (TCR), thyristor-switched capacitors (TSCs) and harmonic filters. It might also include mechanically switched shunt capacitors (MSCs). The harmonic filters (for the TCR-produced harmonics) are capacitive at fundamental frequency. The TCR is typically larger than the TSC blocks so that continuous control is realised [86]. In the next table (Table 2.9) a comparison of basic types of compensators can be seen:

	<b>Synchronous Condenser</b>	<b>TCR (with shunt capacitors if necessary)</b>	<b>TSC (with TCR if necessary)</b>	<b>Self-commutated Compensator</b>
<b>Accuracy of Compensation</b>	Good	Very good	Good, very good with TCR	Excellent
<b>Control Flexibility</b>	Good	Very good	Good, very good with TCR	Excellent
<b>Reactive power capability</b>	Leading / Lagging	Leading/Lagging indirect	Leading/Lagging indirect	Leading/Lagging
<b>Control</b>	Continuous	Continuous	Discontinuous (cont. with TCR)	Continuous
<b>Response time</b>	Slow	Fast 0.5 to 2 cycles	Fast 0.5 to 2 cycles	Very fast but depends on the control system and switching frequency
<b>Harmonics</b>	Very Good	Very high (Large size filters are needed)	Good, filters are necessary with TCR	Good, but depends on switching pattern
<b>Losses</b>	Moderate	Good, but increase in lagging mode	Good, but increase in leading mode	Very good, but increase with switching frequency
<b>Phase Balancing Ability</b>	Limited	Good	Limited	Very good with 1-0 units, limited with 3-0 units
<b>Cost</b>	High	Moderate	Moderate	Low to moderate

Table 2.9: Comparison of basic types of compensators [85]

## ***Static Synchronous Compensator***

Static synchronous compensators (STATCOM) include high power gate turn-off thyristors and transistor devices and is based on a solid-state voltage source, implemented with an inverter and connected in parallel to the power system through a coupling reactor, analogous to a synchronous machine, generating a balanced set of three sinusoidal voltages at the fundamental frequency, with controllable amplitude and phase-shift angle. This equipment, however, has no inertia and no overload capability [85].

## ***DFIG (Doubly Fed Induction Generator)***

The principle of the DFIG is that rotor windings are connected to the grid via slip rings and a back-to-back voltage source converter that controls the rotor and the grid currents. The rotor frequency can differ from the grid frequency. Controlling the rotor currents by the converter, it is possible to adjust the active and reactive power fed to the grid from the stator, independently of the generators rotational turning speed.

## **2.4 SITE**

Marine energy farms, like other renewable energy sources, will probably be connected to distribution grids. But one different aspect of marine energy is that it will only have access to the grid located near the shore, which makes the location and siting of the farm more important regarding grid connection issues. So, when a marine farm is planned, aspects like grid strength have a greater consideration.

The grid strength has influence on the ability of the farm to control the voltage level. Another important aspect to be taken into account is the ratio between the resistance and the impedance of the grid (X/R ratio).

### **2.4.1 Strong Grid and Weak Grid**

When a point of the grid is fed with a current, this causes an increase or decrease of the voltage at that point. The extent of this voltage variation depends on the grid impedance; when the grid has a high short-circuit power, the voltage change caused is small due to the small impedance of the grid, that is, the fed current does not cause a significant voltage increase. By contrast, in the case of a weak grid, the impedance is very large, so the feed current can cause important variations on voltage level.

Therefore, when a marine energy farm is connected to a weak grid, large variations of voltage level can be produced. A typical case of a connection to a weak grid is the case of a farm connected at the end of a transmission line. Differences between a weak and strong grid can be explained through Figure 2.15.

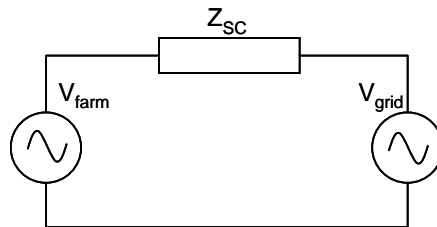

Figure 2.15: Short-circuit diagram

In this figure, the grid is represented by its equivalent Thevenin equivalent (a source  $V_{grid}$  and impedance  $Z_{sc}$ ). The voltage  $V_{farm}$  represents the farm voltage at the connection point. The grid short-circuit apparent power is defined as Eq. 2.1:

$$\underline{S}_{sc} = \underline{V}_{grid,nom} \underline{I}_{sc}^* \quad \text{Eq. 2.1}$$

Where the short-circuit current ( $\underline{I}_{sc}$ ) is defined as the current that flows at nominal voltage when a three-phase short-circuit occurs at the connection point. The short circuit impedance can be defined according to Eq. 2.2:

$$\underline{Z}_{sc} = \frac{\underline{V}_{grid,nom}}{\underline{I}_{sc}} \quad \text{Eq. 2.2}$$

When the feed-in voltage varies, the farm must provide reactive power to the grid to restore the voltage level. The compensation current required is:

$$\underline{I}_{farm,comp} = \frac{\Delta V}{\underline{Z}_{sc}} \quad \text{Eq. 2.3}$$

The compensation apparent power is obtained as:

$$\underline{S}_{farm,comp} = \Delta V \underline{I}_{farm,comp}^* = \frac{\Delta V \Delta V^*}{\underline{Z}_{sc}^*} \quad \text{Eq. 2.4}$$

The relation between the compensation apparent power and the short-circuit apparent power gives the farm voltage control ability.

$$\frac{\underline{S}_{farm,comp}}{\underline{S}_{sc}} = \frac{\Delta V}{\underline{V}_{nom}} \quad \text{Eq. 2.5}$$

Voltage variations produced by a farm are normally a consequence of active power variations. Reactive power is used to minimise such voltage fluctuations. Therefore, the ratio between the reactive and resistive components of the grid impedance is very important.

### ***X/R ratio***

The effectiveness of the voltage control by means of reactive power control depends heavily on the grid X/R ratio. In Figure 2.16 two voltage sources can be seen interconnected with an impedance ( $Z$ ); the voltage source  $V_1$  can be considered as the farm, while the impedance  $Z$  and the voltage source  $V_2$  represent the equivalent Thevenin of the grid. Voltage  $V_2$  is supposed to be constant and a reference value. Following the superposition principle, the increase of voltage  $V_1$  can be determined when a certain reactive current feeds the impedance  $Z$  (phasor diagram) of Figure 2.16.

In the phasor diagram, the left scheme represents a grid with a high X/R ratio. This diagram shows how the reactive current provides a relatively high voltage in the same direction as  $V_2$ , therefore the voltage  $V_1$  variation is high. The right scheme shows a grid with a small X/R ratio. In this case a greater voltage variation happens owing to resistance  $R$ . This voltage variation is perpendicular to  $V_2$ , so the effect in the increase of  $V_1$  module is much smaller than in the case with a high X/R ratio grid.

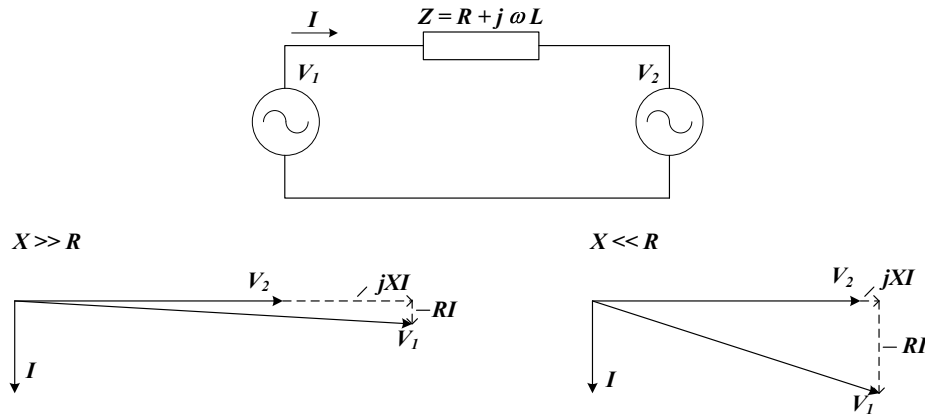

Figure 2.16: X/R ratio [87].

For instance, aerial transmission lines have a very high X/R ratio ( $>5$ ), and the required reactive power to achieve a certain voltage increase is relatively small. In the case of cables, these have a smaller X/R ratio, which makes the voltage control more difficult.

With a small X/R ratio, the effect of the active power generated by the farm in the grid increases as the capacity to control the voltage by means of reactive power reduces.

## 2.4.2 National Electric Power System Maps

In general, to reduce power losses due to transmission, it is desirable that consumption be near to generation. In the context of ocean energy, power will be delivered to the grid located near the shore. Therefore, it is useful to analyse the proximity of the population (i.e., the consumption) near to the shore and the grid associated.

Next, some examples of countries are presented, showing national electric power system maps and also the distribution of the population, which gives a general idea of the proximity of the resource to the end users.

### *United Kingdom*

United Kingdom is characterised by large coastal areas which offer a good marine resource. In particular, Scotland is widely acknowledged as one of the most promising sites in the world for the production of marine energy, but the best sites are remote, so getting the generated electricity back to the consumers requires a massive investment in infrastructure.

As can be seen in Figure 2.17, the population is concentrated in the South, that is, far from the resource. Consequently, the capacity density of the power transmission grid is smaller in the North, as shown on Figure 2.18.

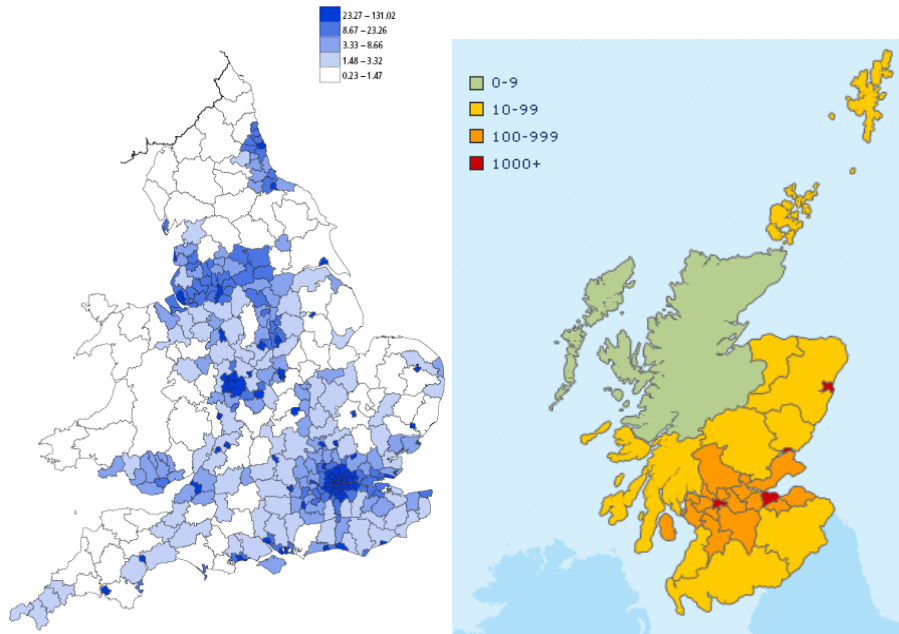

Figure 2.17: Population distribution in England and Wales [88] and in Scotland [89]



Figure 2.18: Electric power transmission grid in United Kingdom [90]

## Spain

In Spain there are many coastal provinces. In Figure 2.19, observe that the density of population of the provinces next to the sea is greater than in the majority of the rest of the country.

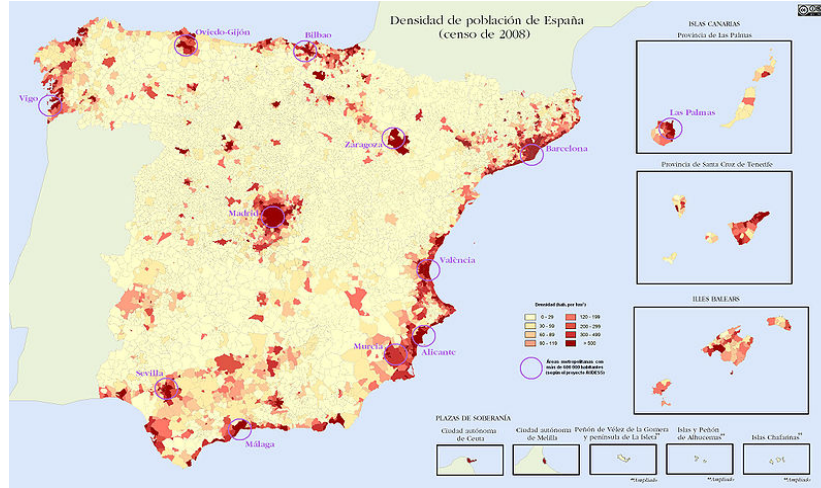

Figure 2.19: Population distribution in Spain [67]

The eastern coast (Mediterranean coast) is very densely populated but the wave energy potential of the sea in this area is not large enough to be considered cost-effective for the installation of wave energy devices. In contrast, the north coast (Cantabrian coast) can take better advantage of energy generated from wave energy, due to the predominant direction of the wind from the west.

Figure 2.20 shows the map of the transmission grid in Spain. There are a significant number of electrical substations on the Cantabrian coast, but most of them are placed nearer to the main metropolitan areas, therefore marine energy farms will likely be connected to the distribution grid.



Figure 2.20: Electric power transmission grid in Spain [91]

## Portugal

Portugal is probably the European country with the largest population nearest to the shore, as can be seen in Figure 2.21. As a consequence of this, the grid is along the coast, which is very favourable for a successful integration of marine energy (Figure 2.22).

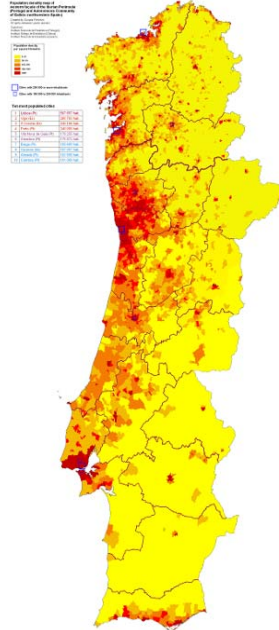

Figure 2.21: Population distribution in Portugal [92]



Figure 2.22: Electric power transmission grid in Portugal [93]

## Ireland

In Ireland the most populated areas are in the northeast (Figure 2.23). The wave energy resource in these areas is not very significant; nevertheless there is a great tidal resource, which will favour its development, due to the proximity to end-users (Figure 2.24). The wave energy resource is large off the western coast where the population is very scattered.

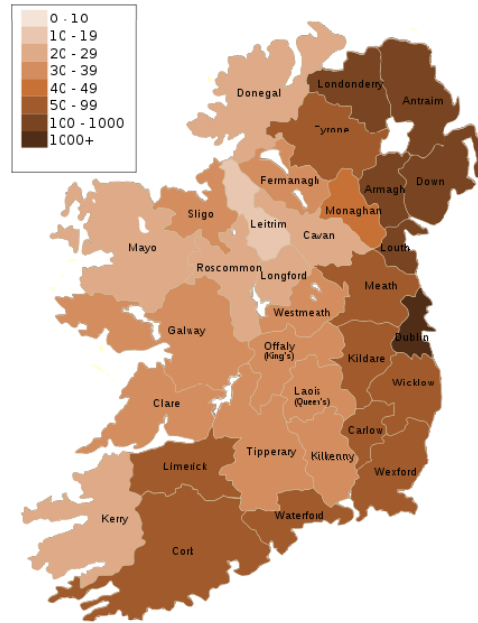

Figure 2.23: Population distribution in Ireland [67]

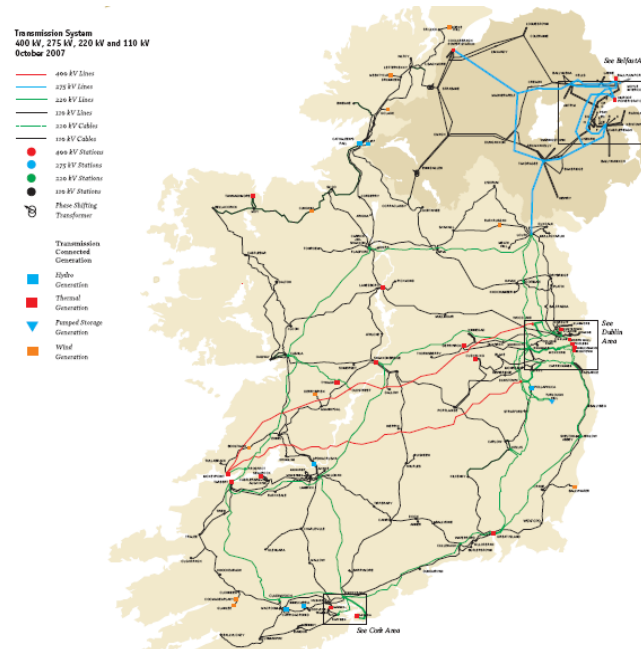

Figure 2.24: Electric power transmission grid in Ireland [94].



## Canada

The Canadian population distribution is, in general, very dispersed, with major electrical load centres in cities such as Toronto, Montreal, Vancouver, Calgary, etc. The electrical network is primarily oriented in north-south manner, facilitating flow to and from USA and Canada.

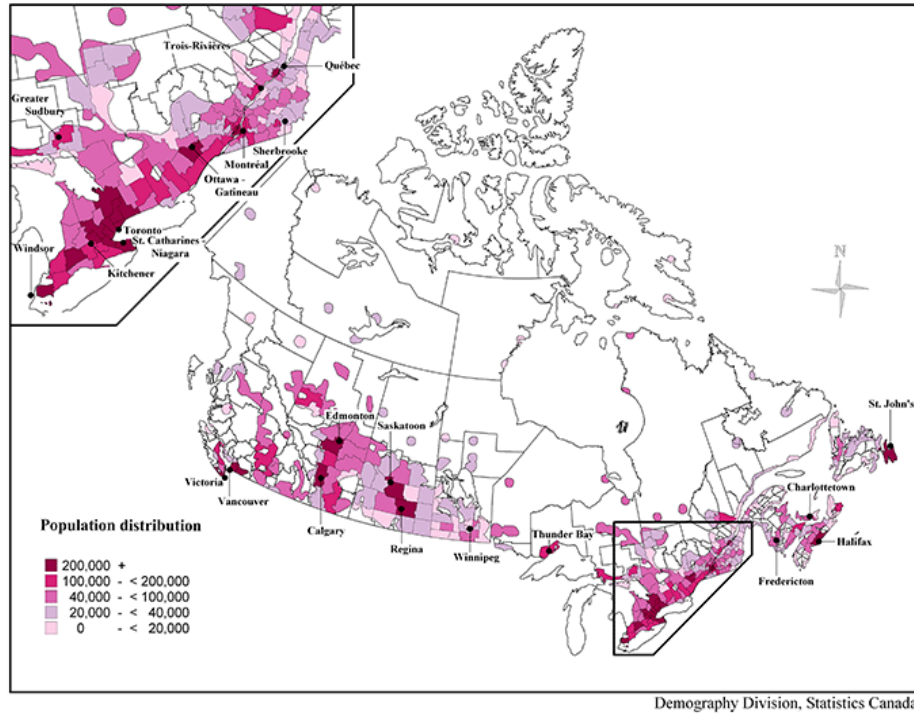
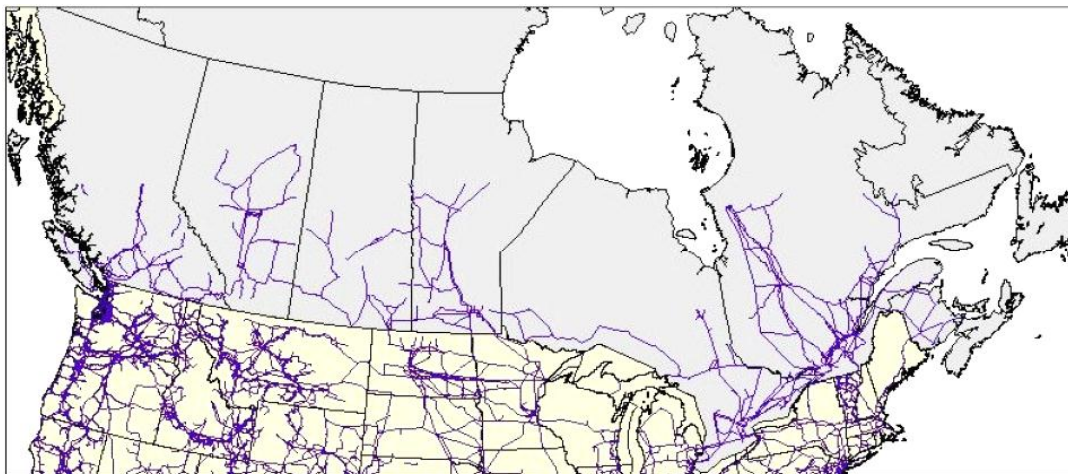

Figure 2.25: Population distribution as of July 1, 2007 in Canada [95]



Statistical Source: North American Electric Reliability Council (NERC)  
Map Source: Global Energy Network Institute (GENI)

Figure 2.26: Canada-USA interconnected electricity network [96]

## *United States of America*

In the case of the United States, the most populated states are located on the eastern coast. Nevertheless, most western states are densely populated near the coast (Figure 2.27). Wave energy climates are the most energetic for coasts facing west, where the existing electric power transmission grid is not as extensive as in the eastern half of the continent and on the eastern coast (Figure 2.28).

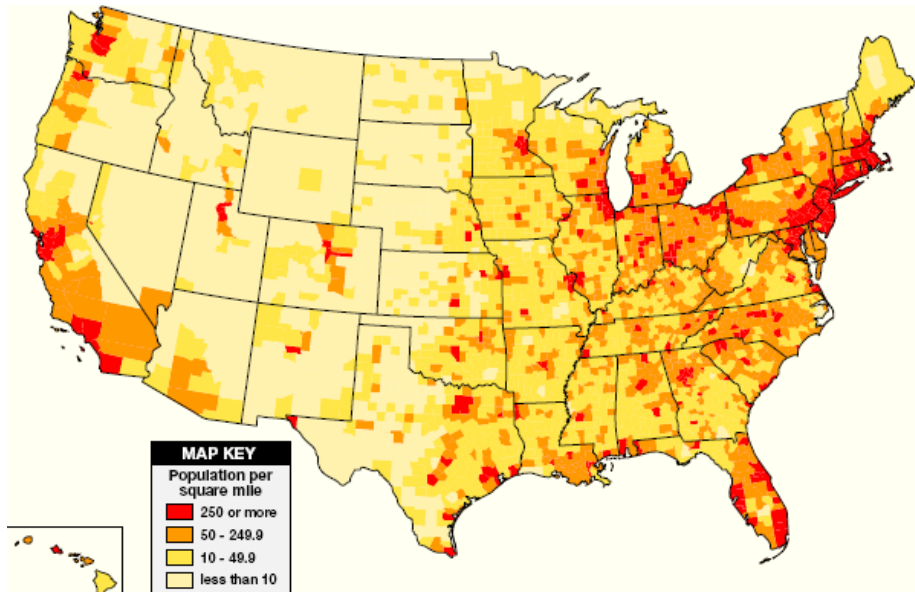

Figure 2.27: Population distribution in United States [97].

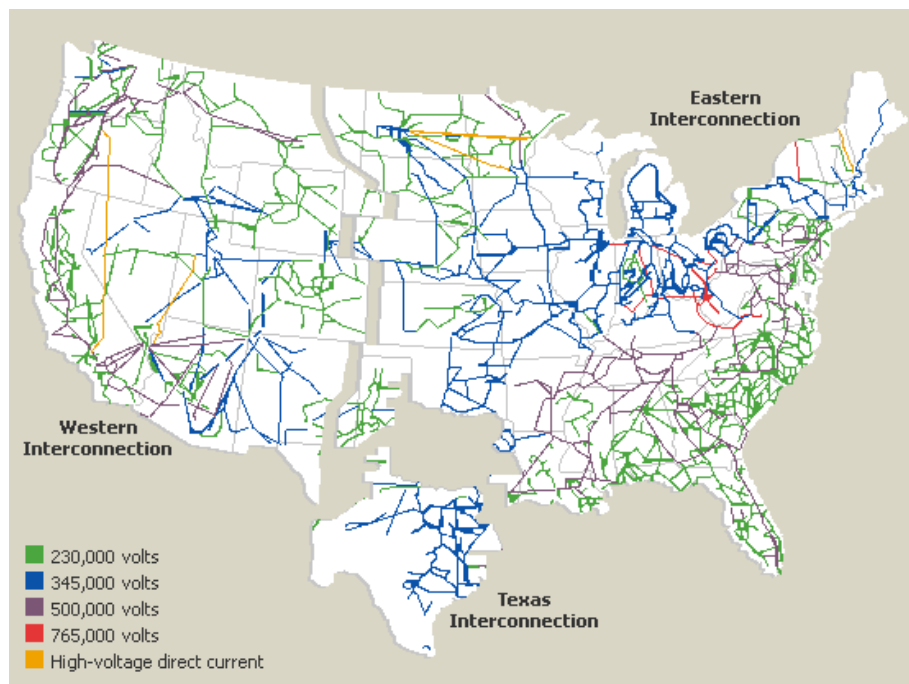

Figure 2.28: Electric power transmission grid in the United States [98].

## Republic of Korea

In the Republic of Korea, the most populated region is located around the capital, Seoul; therefore, a strong electrical grid exists in the northwestern coast. However, this is not a region with a very energetic marine resource. By contrast, on the south eastern coast there is another area with an important population density and consequently an electrical grid able to better support and manage the marine energy resource in the area.



Figure 2.29: Population distribution in the Republic of Korea [99].

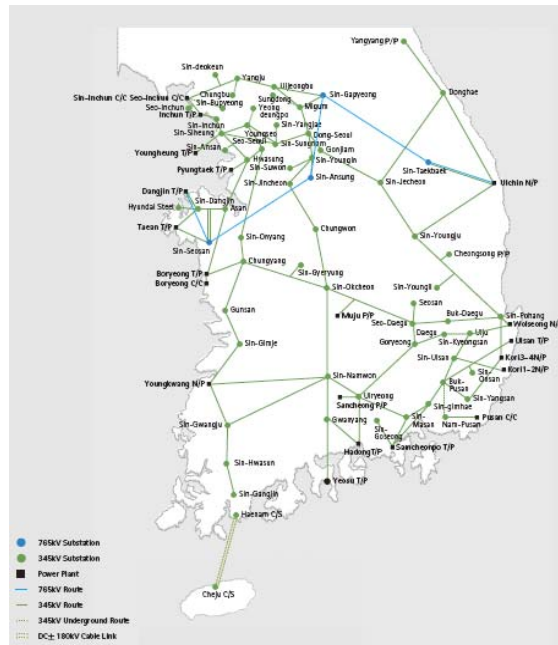

Figure 2.30: Electric power transmission grid in the Republic of Korea [100].

The following examples show the rest of the member countries of the OES-IA, shown with their respective electric power system grid maps and their population distribution maps.

### Denmark



Figure 2.31: Population distribution in Denmark [101].

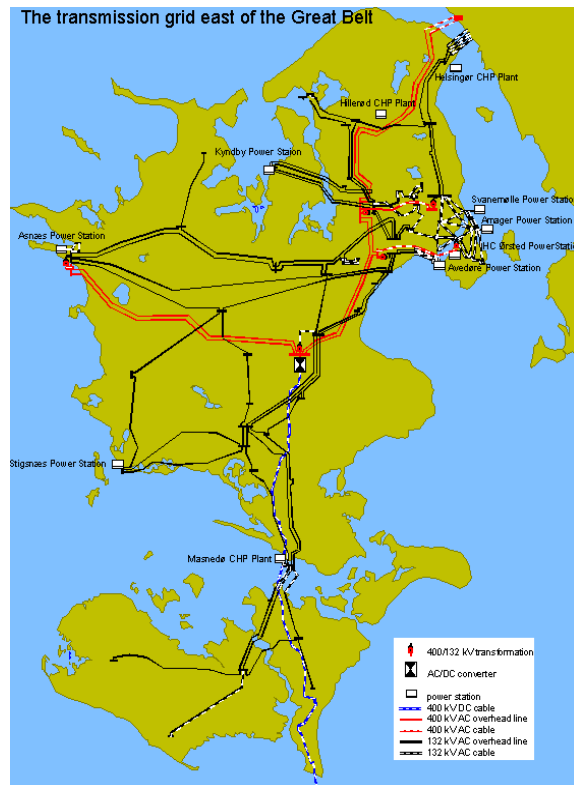

Figure 2.32: Electric power transmission grid in Denmark [98].

# Japan

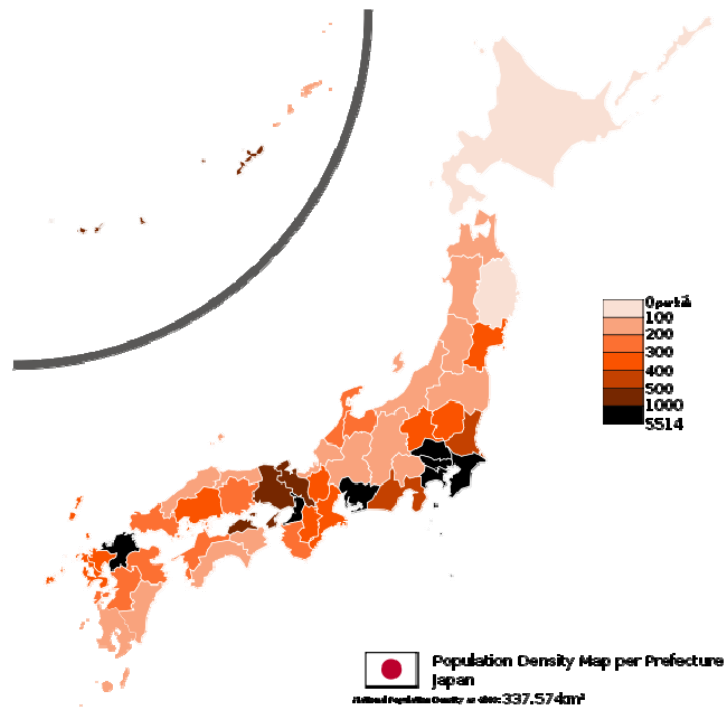

Figure 2.33: Population distribution in Japan [67].

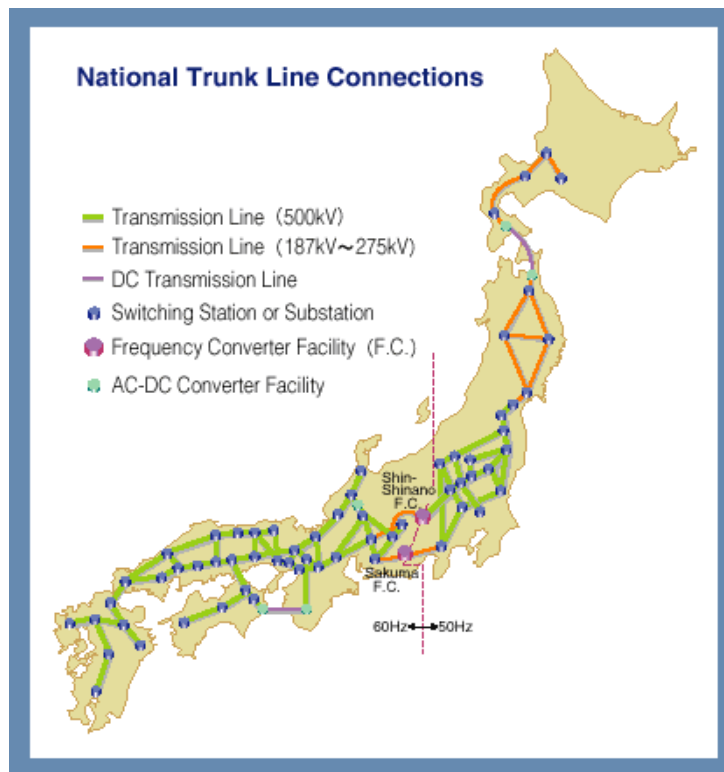

Figure 2.34: Electric power transmission grid in Japan [98].

## Belgium

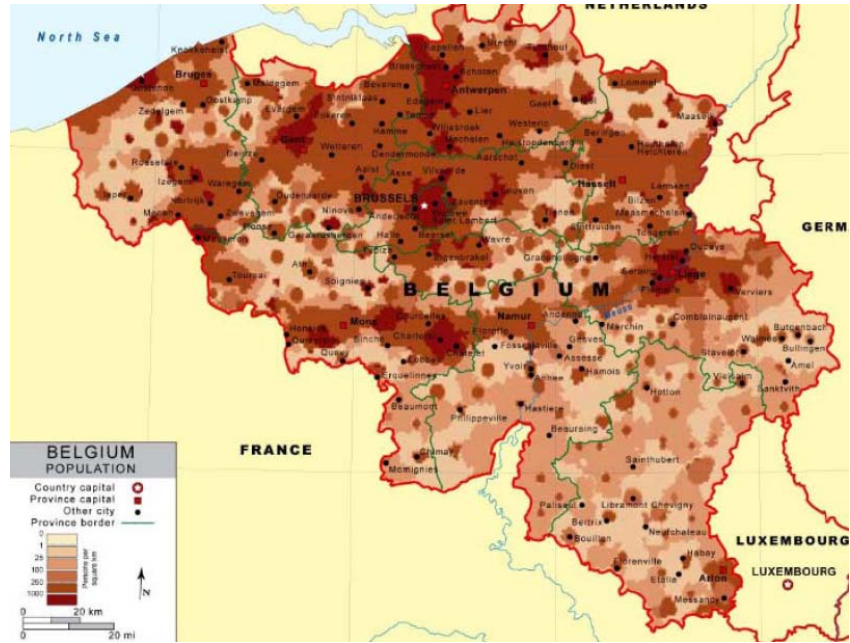

Figure 2.35: Population distribution in Belgium [101].

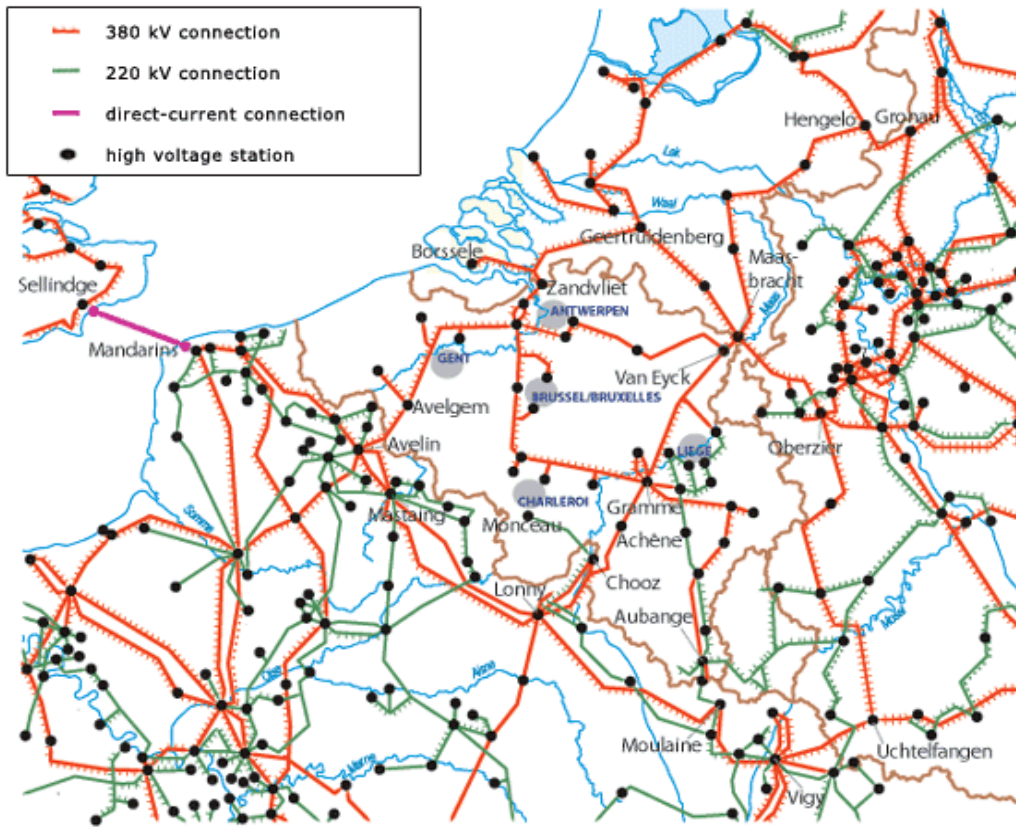

Figure 2.36: Electric power transmission grid in Belgium [102].

## Germany

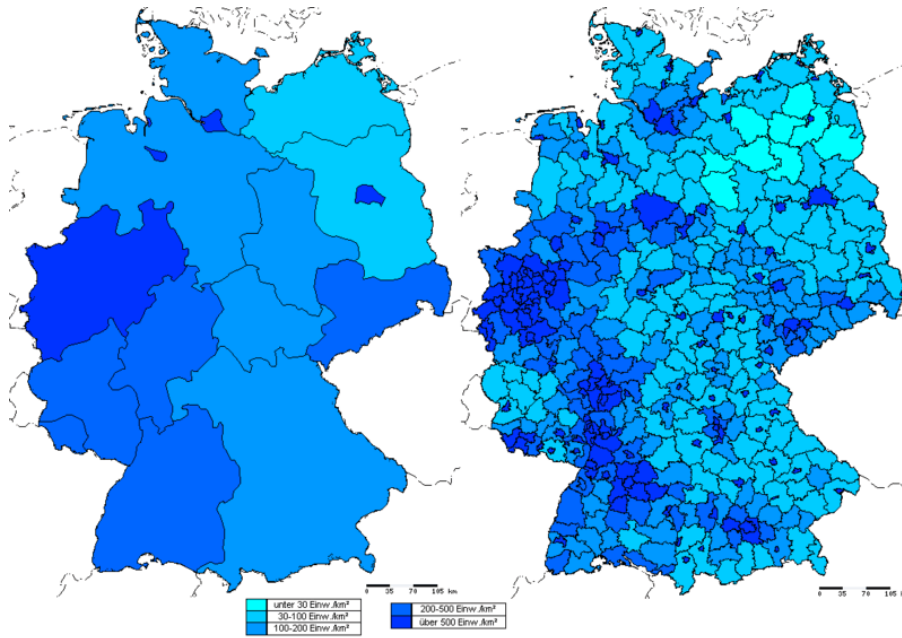

Figure 2.37: Population distribution in Germany [67]

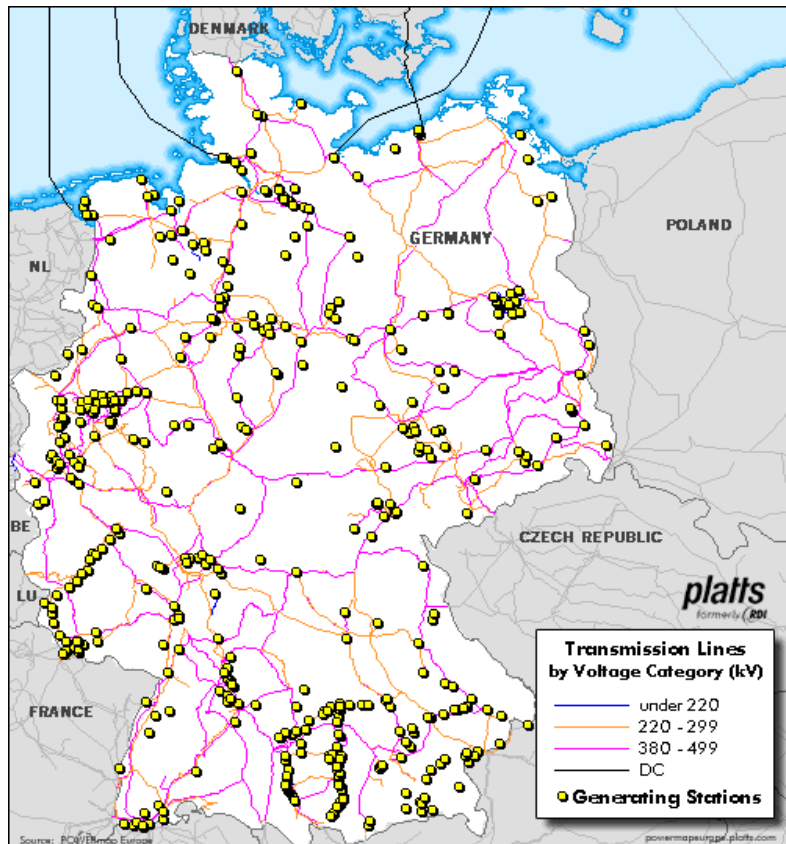

Figure 2.38: Electric power transmission grid in Germany [98].

*Mexico*

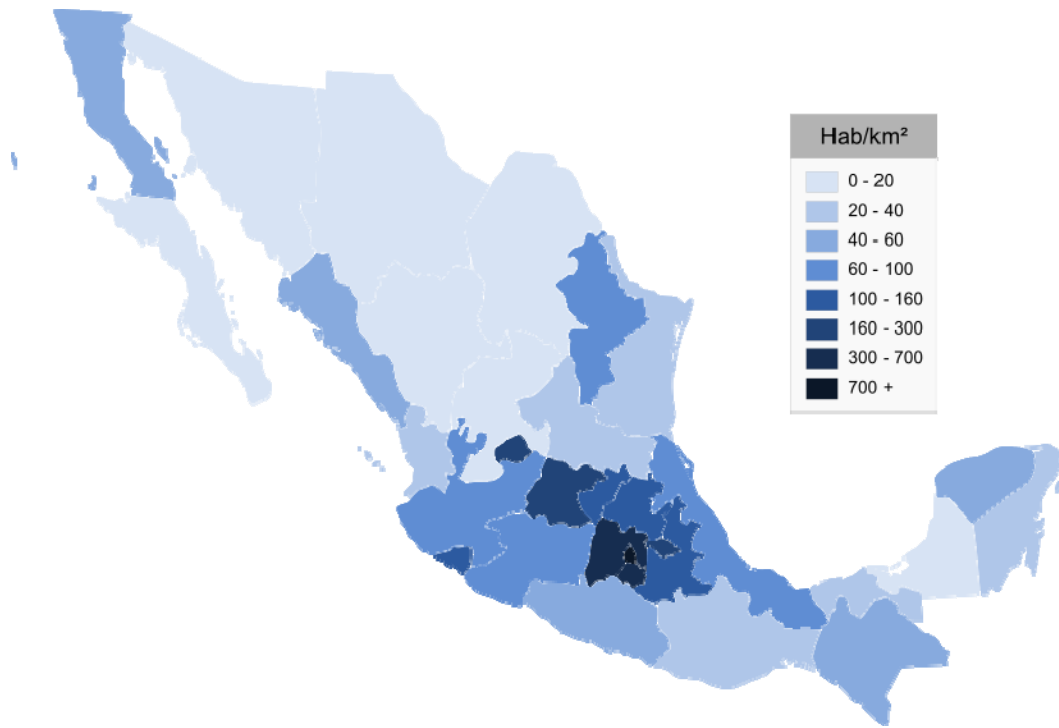

Figure 2.39: Population distribution in Mexico [67].

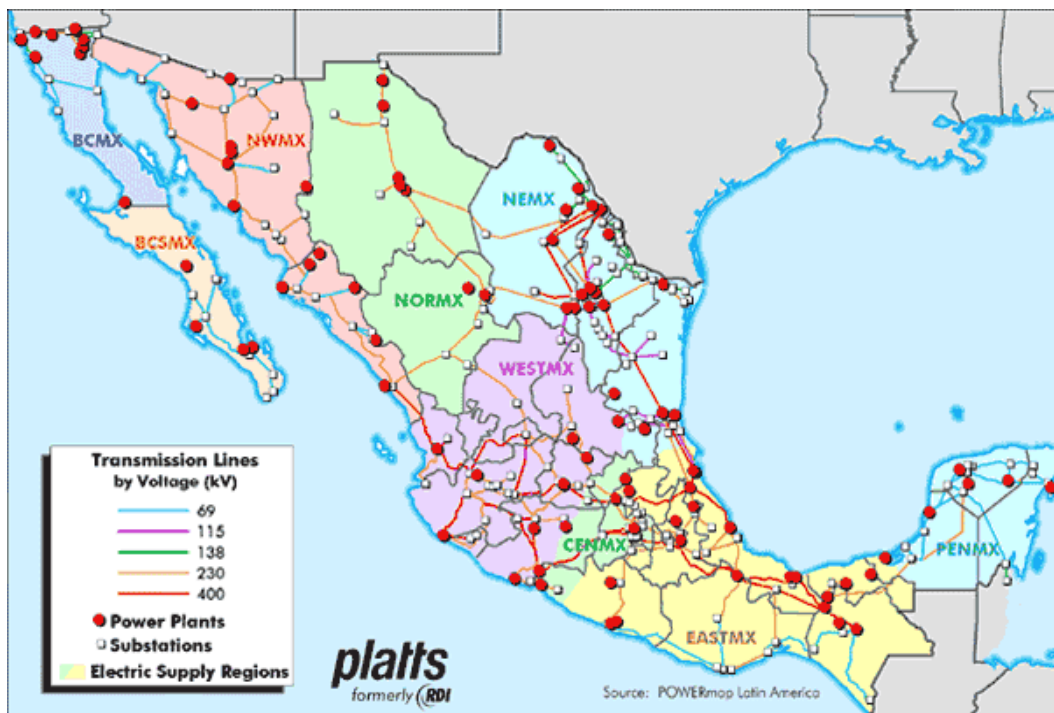

Figure 2.40: Electric power transmission grid in Mexico [98]



# Norway



Figure 2.41: Population distribution in Norway [101]

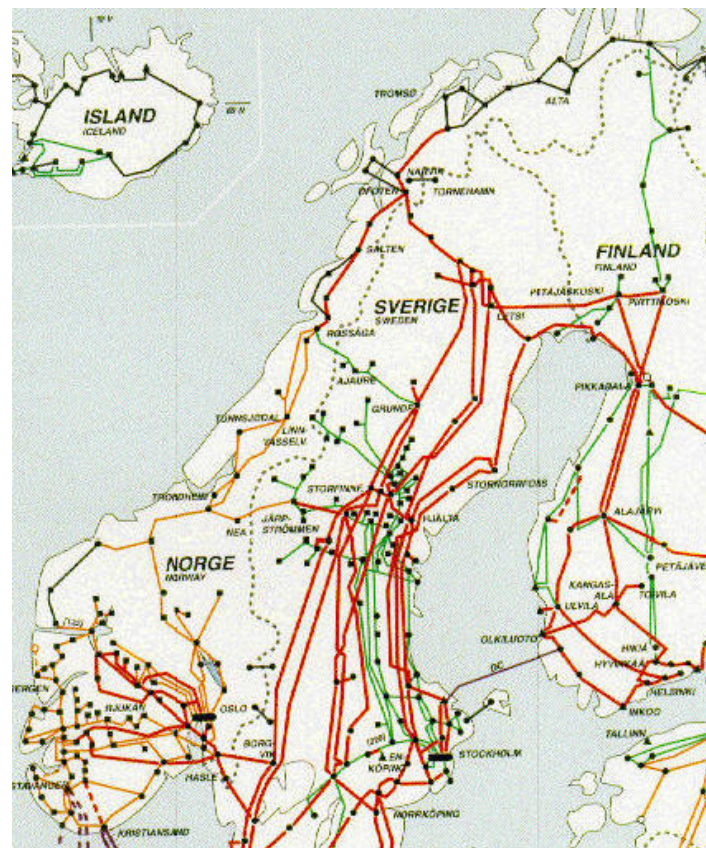

Figure 2.42: Electric power transmission grid in Norway [98]

# Italy

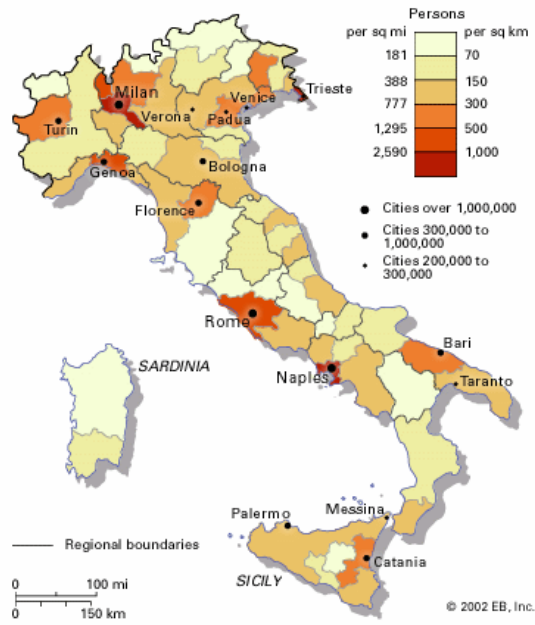

Figure 2.43: Population distribution in Italy [103]

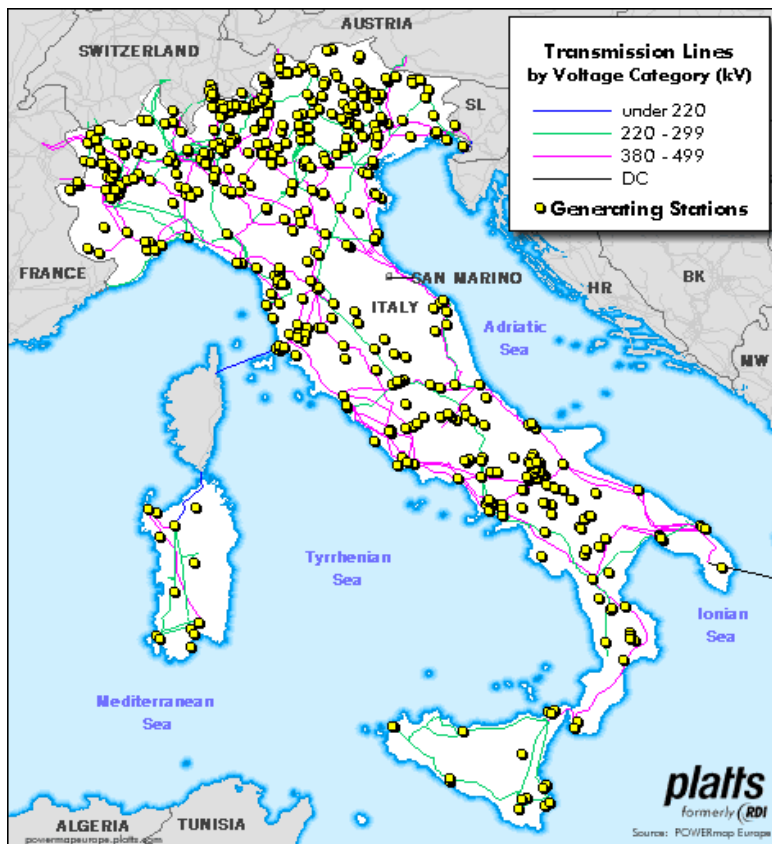

Figure 2.44: Electric power transmission grid in Italy [98]

*New Zealand*

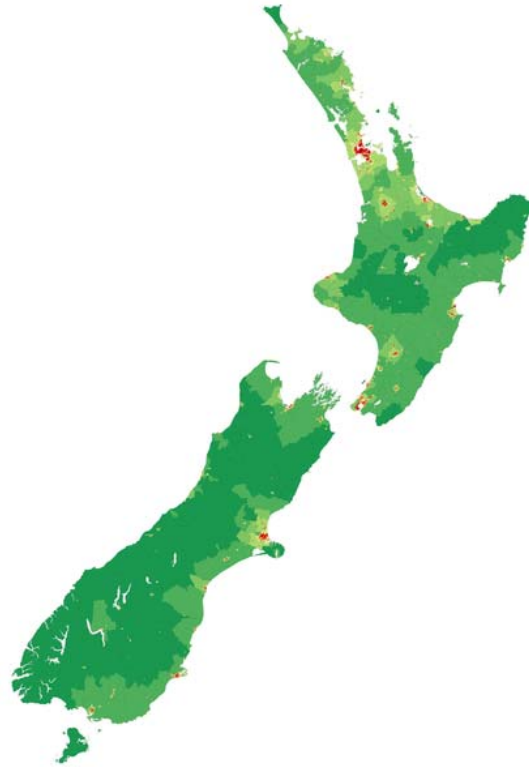

Figure 2.45: Population distribution in New Zealand [67]

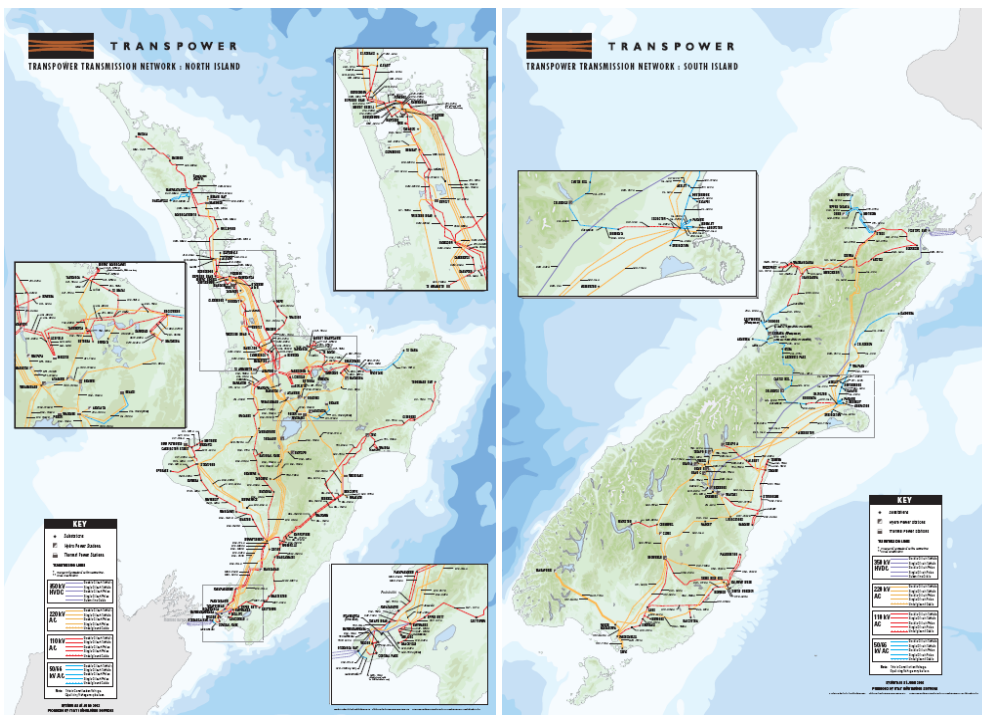

Figure 2.46: Electric power transmission grid in New Zealand [98]

# Sweden

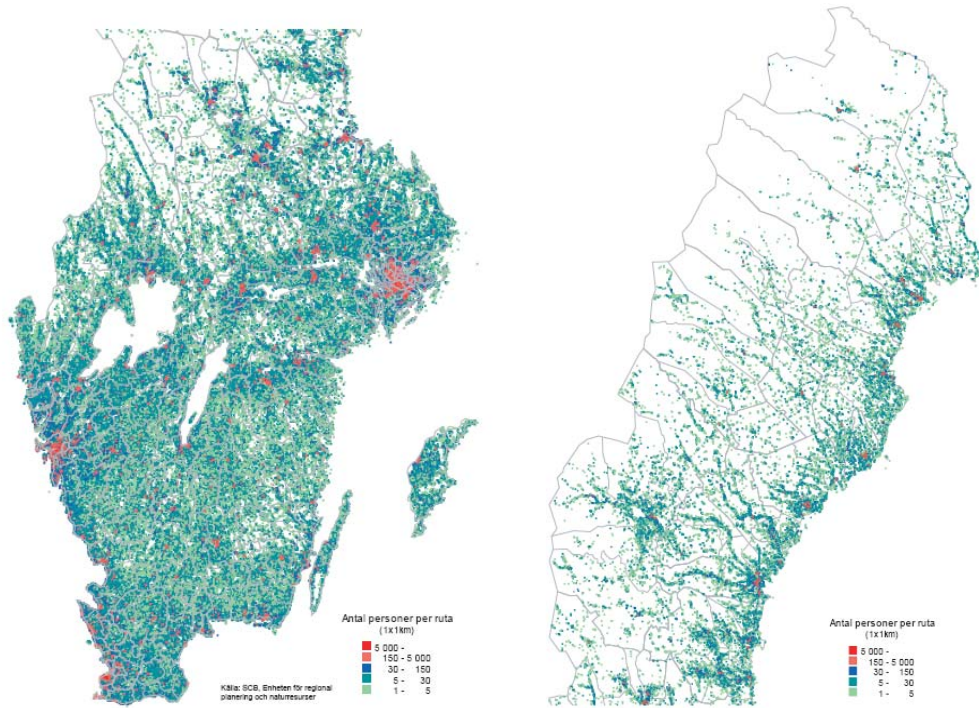

Figure 2.47: Population distribution in Sweden [104]

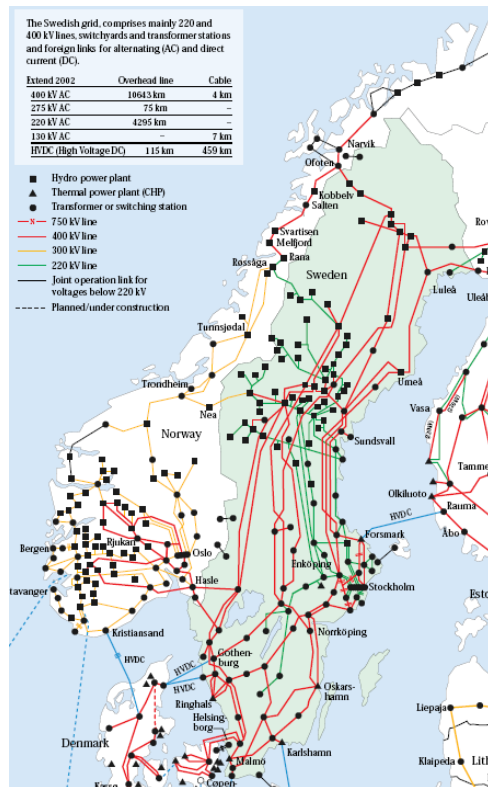

Figure 2.48: Electric power transmission grid in Sweden [105]

# Australia

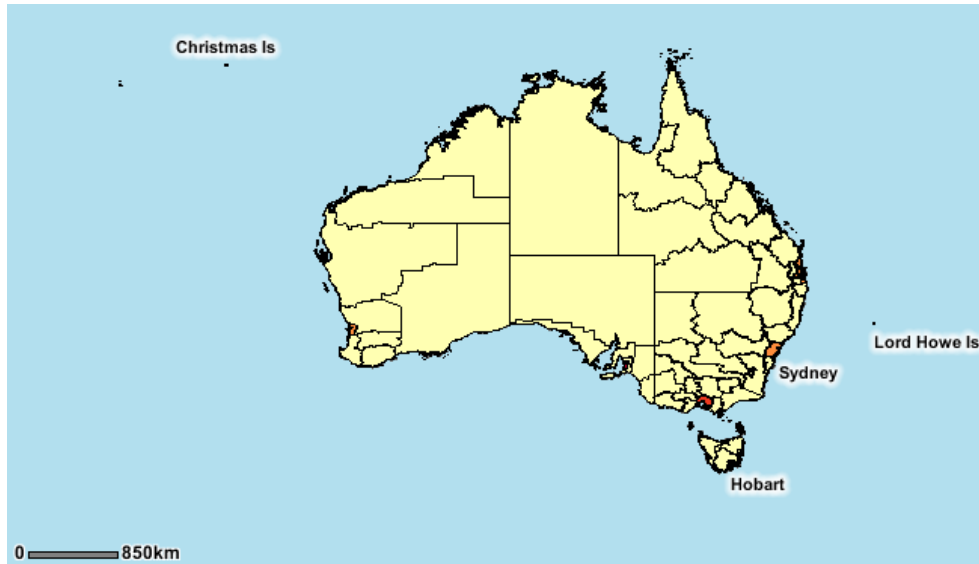

Figure 2.49: Population distribution in Australia [106]

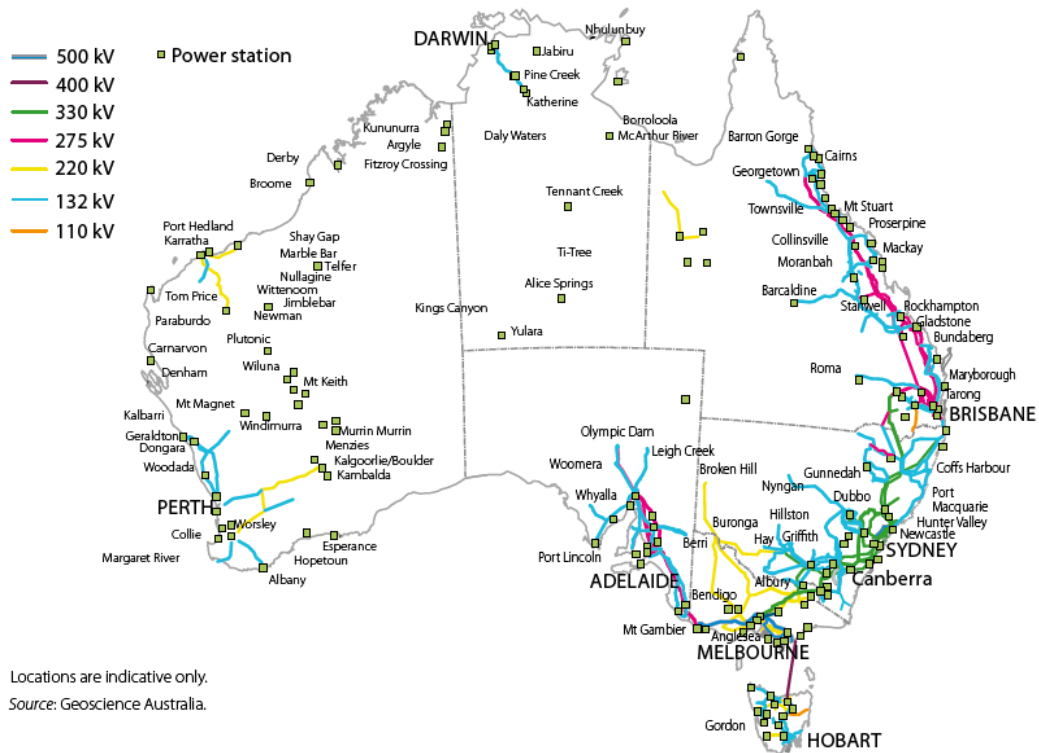

Figure 2.50: Electric power transmission grid in Australia [107]

## South Africa

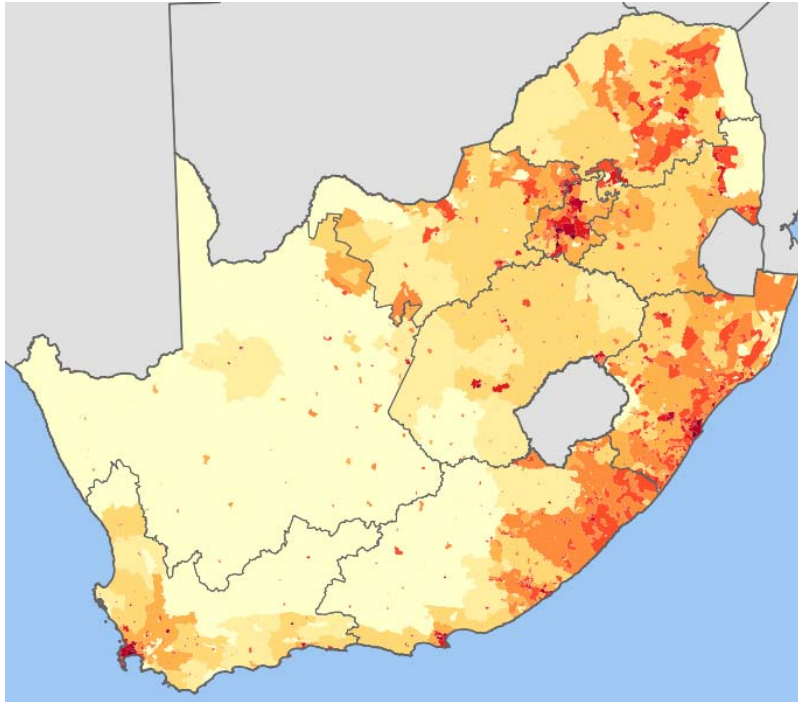

Figure 2.51: Population distribution in South Africa [67]

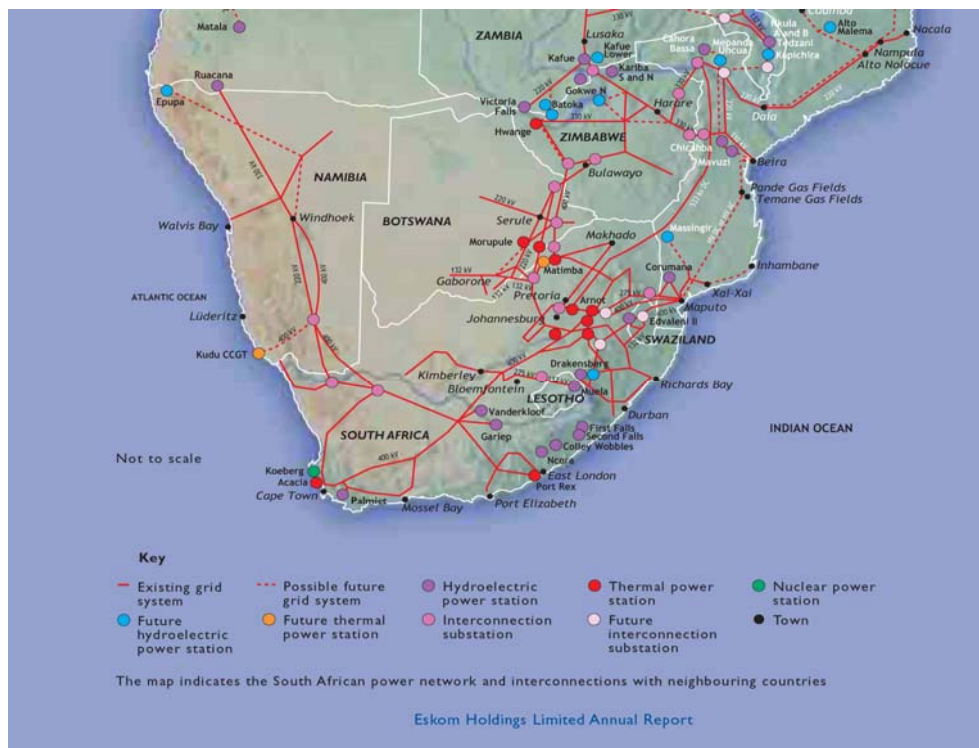

Figure 2.52: Electric power transmission grid in South Africa [98]

### 2.4.3 Biscay Marine Energy Platform

Marine energy farms will likely be connected to the distribution grid. To analyse the influence on power quality when connecting different wave energy converters to the grid, an offshore testing facility was developed.

The *bimep* (Biscay Marine Energy Platform) is an offshore facility for testing and demonstrating wave energy converters. It will be sited in the Basque Country, (north of Spain, southeast of the Bay of Biscay). The main purpose of the infrastructure is the research, demonstration and operation of real-scale offshore wave energy converters (Figure 2.54).

The facility has an overall power capacity of 20 MW, distributed in four berths or offshore connection points with a capacity of 5 MW each. Each berth is connected by means of a 13.2 kV line to a substation located on land by means of a 13.2 kV line.

The onshore substation houses the electrical protections, measurement systems and the power transformer to provide the connection of the berths to the national electric power system.

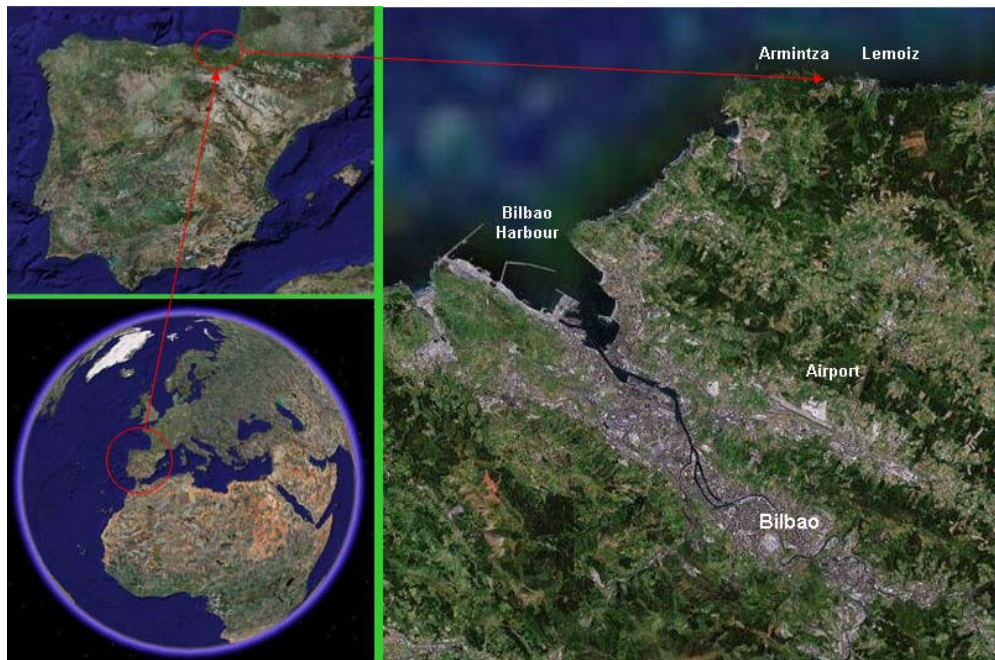

Figure 2.53: Location of *bimep*

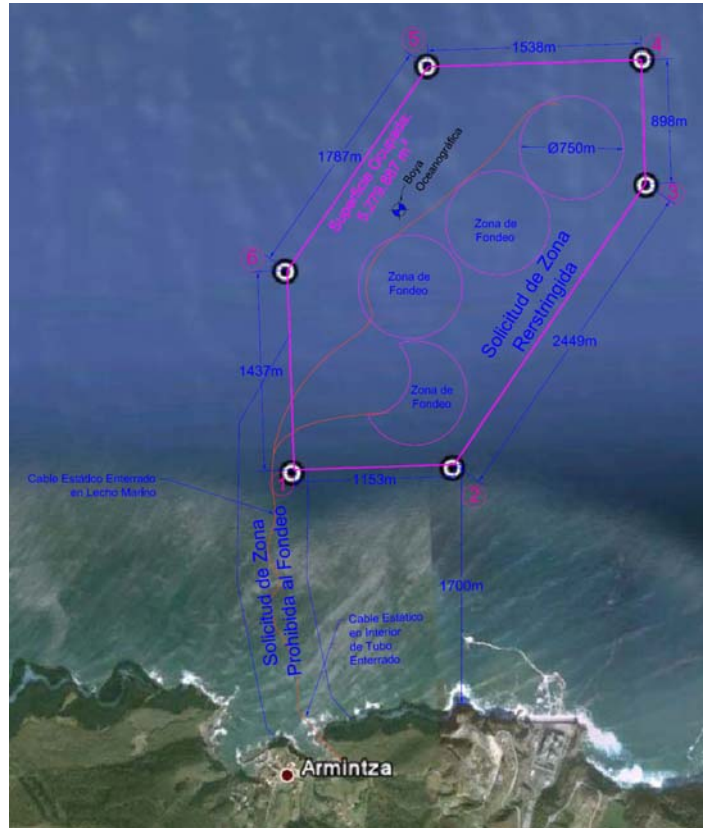

Figure 2.54: Aerial view of *bimep* test zone with planned cable routes [108].

#### 2.4.4 Belmullet Wave Energy Test Site

Another offshore facility for testing and demonstrating wave energy converters was developed off the coast of Ireland, which is the Belmullet Wave Energy Test Site. The purpose of this wave energy test site is to provide a location for the temporary mooring and deployment of wave energy machines so that their performance in generating electricity and their survivability can be tested and demonstrated in open ocean conditions. It is proposed to operate the site for up to 20 years with devices located on site throughout the year. To analyse the influence on power quality when connecting different wave energy converters to the grid, this offshore testing facility will provide important in-service data from devices installed at this site.

Belmullet was chosen in 2009 by the Irish government to become the national wave energy test site of the Republic of Ireland. The test site is expected to become operational in 2011 and is planned to have up to a maximum generating capacity of 20 MW.

It is proposed that four submarine electricity cables will be installed at a minimum of 1m below the seabed and will come ashore at Belderra beach. A small portion of the route near the 50m depth zone (about two miles out from Annagh Head) has a stony seabed and here the cables will be laid on top of the rock and protected using a rock berm or some form of matting.



An electricity substation will be located inland from the beach at Belderra and will be about the size of a domestic dwelling. The electricity cables mentioned above will continue underground to the substation. A dedicated overhead power line on wooden poles will transmit electricity from the substation to the electricity grid at Belmullet.

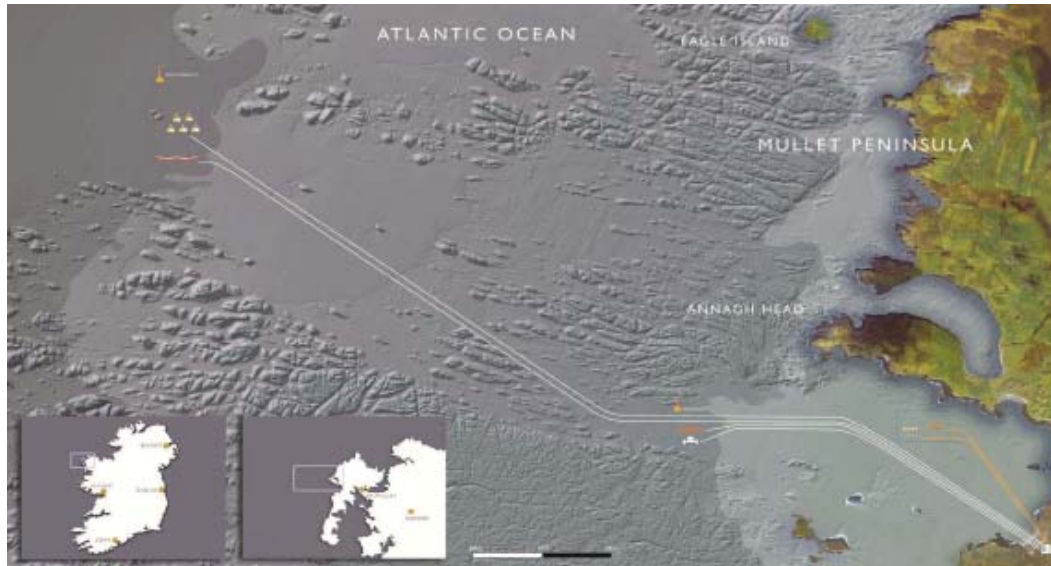

Figure 2.55: Conceptual layout of the facility [109].

### 3 CASE STUDY

---

This section presents case studies illustrating the integration of wave and tidal current power plants into distribution and transmission grids. The chapter consists of four sub-sections.

1. The first two sub-sections present two case studies illustrating the integration of wave energy plants into the distribution network (only non-proprietary information is presented).
2. The last two sub-sections present case studies illustrating integration of aggregate wave and tidal current power plants into a larger power system at transmission levels (only non-proprietary information is presented).

Power system simulations have been carried out using the DIGSILENT PowerFactory simulation tool and the DSATools<sup>TM</sup>. DIGSILENT PowerFactory is a specific high-end tool for applications in generation, transmission, distribution and industrial systems. The DSATools<sup>TM</sup> provide a complete tool set for off-line and on-line applications for system planning, operation and dynamic security assessment, including integration of variable renewable generations.

#### 3.1 DISTRIBUTION SYSTEM: BASQUE COUNTRY CASE STUDY<sup>1</sup>

The goal of this study is to assess power quality issues, such as voltage variations and grid faults related to the integration of wave energy farms into the distribution network. Computer simulations are performed and corresponding results included. In order to analyze a realistic scenario, this work considers the case study of a wave farm connected to the *bimep*.

The *bimep* is an offshore facility for testing and demonstrating wave energy converters. It will be sited in the Basque Country (north of Spain, southeast of the Bay of Biscay). The main aim of the infrastructure is the research, demonstration and operation of full-scale offshore wave energy converters.

The *bimep* project began in 2007 with a conceptual design of the infrastructure and a complete survey of the Basque coast to select the most suitable location. The preliminary project, a detailed design of the infrastructure and an environmental impact study, were completed in 2008. The process of obtaining licenses is now underway. The *bimep* is expected to be in operation by the end of 2011. Figure 3.1 shows the conceptual architecture of the infrastructure.

---

<sup>1</sup> The case study report is adapted from the ICOE 2010 article “Grid Integration of Wave Energy Farms: Basque Country Study” [110].

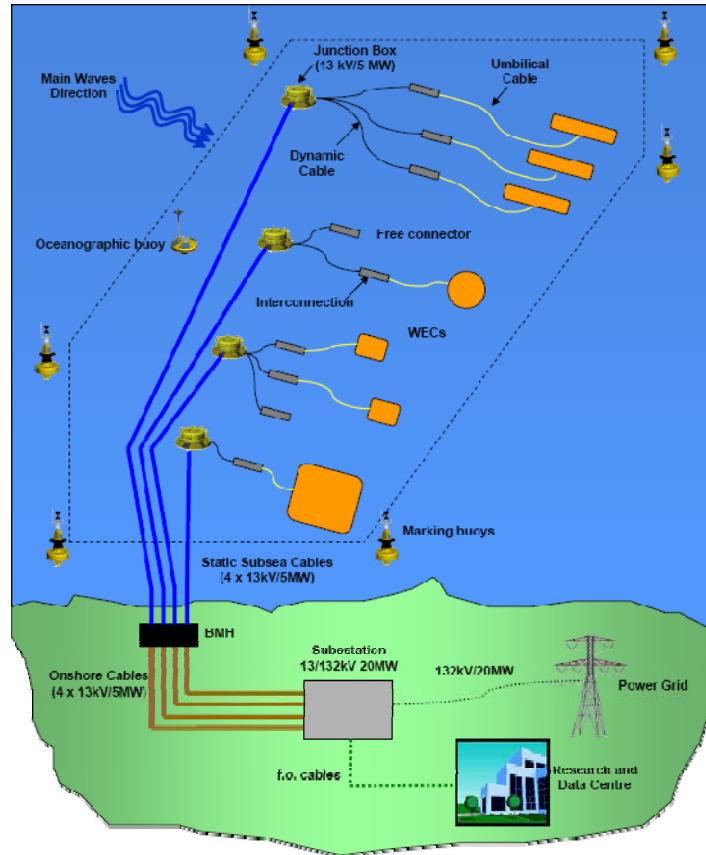

Figure 3.1: *bimep* architecture.

The purpose of this case study is to analyse the influence on power quality when connecting wave energy devices to the grid connection point of *bimep*. The impact of storage level, of the use of power electronics and of technology type on the power quality, and in particular on the voltage variations, will be discussed. Finally, different solutions will be proposed for each problem depending on the obtained results.

The case study includes a detailed model of *bimep* as well as different wave energy converter models. Generic device models have been implemented with the goal of assessing how different technologies impact the power quality. It is worth noting that specific technology feasibility is not part of this analysis.

### 3.1.1 Electrical Network Modelling

Both the structure of the grid and the parameters used for simulation correspond to the current plan of the project. Figure 3.2 shows grid model according to Figure 3.1.

Each wave energy converter (WEC) is connected to the shore through an offshore subsea cable. The model of each WEC includes a generator and a 0.69/13.2 kV transformer. Generators and transformers are numbered from left to right: 1, 2, 3, 4.

The subsea cables have different lengths to analyse the effect of the cable itself, both on power flow and on dynamic simulations. Those lengths correspond to the present planned *bimep* infrastructure. (Table 3.1).

Cable	Length (km)
1	3.4
2	3.7
3	5.0
4	5.9

Table 3.1: Subsea cables lengths

Once onshore, subsea cables are replaced by overhead lines up to the substation. The four overhead lines are identical. The substation consists of two 13.2/132 kV transformers. These transformers are connected to the PCC. The PCC is modelled with respect to its SCC given by the DSO, in this case Iberdrola [111].

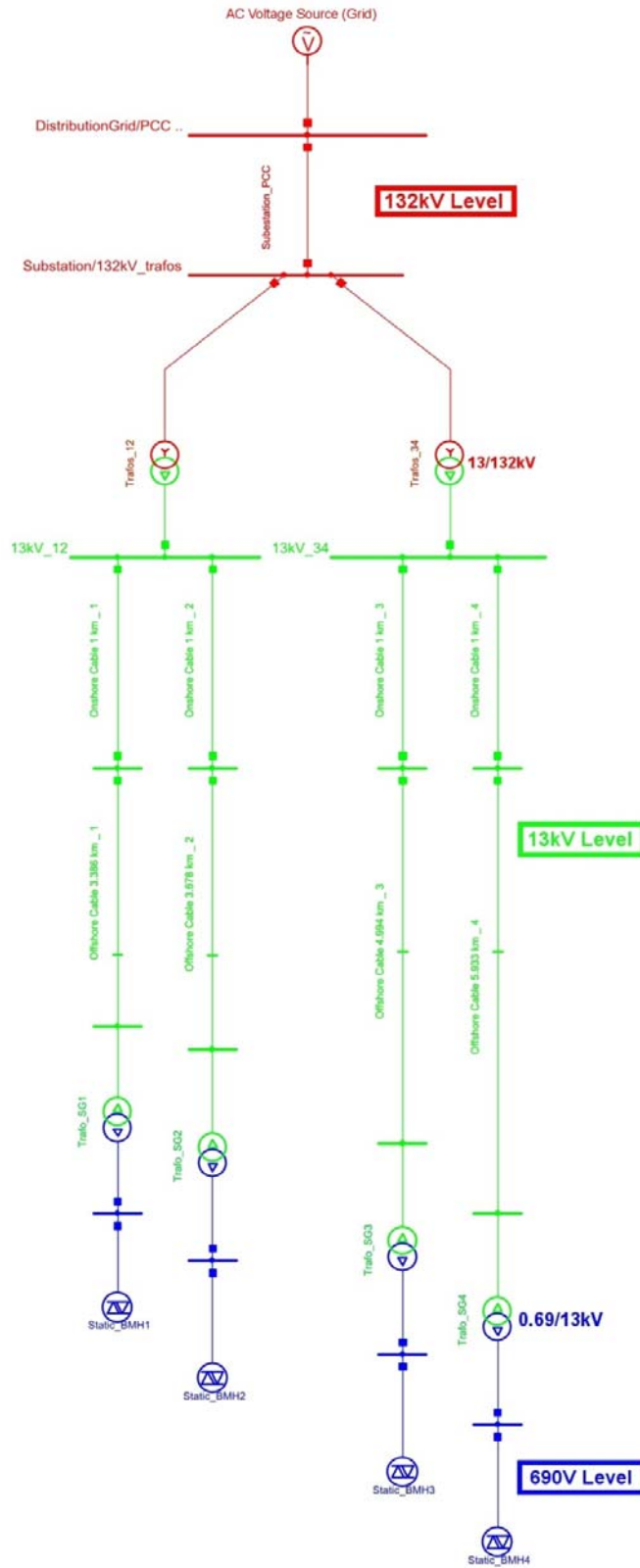

Figure 3.2: Simulated grid model

### 3.1.2 WEC Modelling

To evaluate the importance of inherent energy storage and power electronics in improving power quality, generic device models have been implemented. Note that specific technology feasibility is not part of this analysis.

#### *WECs and Generating Technologies*

Regarding storage issues, two different generation technologies, with and without inherent storage capacity, have been modelled.

- Attenuator: Hydrodynamic model based on linear wave theory of a single body attenuator without inherent storage in this case (direct-drive system). Only pitch motion has been taken into account. (Section 2.3).
- Point absorber: Hydrodynamic model of a buoy based on linear wave theory with hydraulic PTO (inherent storage capacity). Only heave motion has been taken into account. (Section 2.3).

In order to study how reactive power control affects power quality issues, two different models, with and without power electronics, have been used.

- SC: Direct-drive squirrel cage generator (without power electronic converter control) wave energy converters.
- SG: Full converter wave energy converter, modelled as a PQ node using the Static Gen (control current sources) component of DIgSILENT PowerFactory [41]. This component provides three control types: power factor control, voltage control and droop control, thus emulating a system with power electronics converters.

#### *Mechanical Torque Input*

The mechanical power generated by each WEC is modelled as a torque input to the generator. These torque values have been obtained in time domain simulations, in which the hydrodynamic behaviour of the different simulated WEC geometries are modelled in irregular waves.

For the solution of the hydrodynamic problem, linear water wave theory is adopted, based on the assumptions of incompressible irrotational flow and inviscid fluid. This allows the computation of the velocity potential in its components (radiated and diffracted wave fields) by applying the boundary element methods, from which the hydrodynamic coefficients and excitation forces are obtained.

On a general approach, the equation of motion for a single body oscillating in heave is:

$$m\ddot{x} = F_e + F_r + F_h + F_{PTO} \quad \text{Eq. 6}$$

where:

$m$ : mass of the body

$\ddot{x}$ : acceleration of the body

$F_e$ : wave excitation force

$F_r$ : wave radiation force

$F_h$ : hydrostatic force

$F_{PTO}$ : Power Take Off force

To take into account nonlinearities, particularly when they can be modelled as time-varying coefficients of a system of Ordinary Differential Equations (ODEs), it is useful to apply a linear time-domain model based on the Cummins equation [112], whose use is widespread in sea keeping applications. This is based on a vector integral-differential equation which involves convolution terms accounting for the radiation forces.

For the case of a single body floating in heave, the Cummins equation can be expressed in the form:

$$(m + A_\infty)\ddot{x}(t) + \int_{-\infty}^t K(t - \tau)\dot{x}(\tau)d\tau + \rho g S x(\tau) + F_{ext}(x, \dot{x}, t) = F_e(t) \quad \text{Eq. 7}$$

where  $A_\infty$  is the added mass ( $A(\omega)$ ) at infinite frequency, given by:

$$A_\infty = \lim_{\omega \rightarrow \infty} A(\omega) \quad \text{Eq. 8}$$

and  $K(t)$  is the radiation impulse response function, also called memory function because it actually represents a memory effect due to the radiation forces originated by the past motion of the body.

In this formulation all the possible nonlinearities are included in the term  $F_{ext}$ , which represents the external forces that are applied to the system. They can be due, for example, to the PTO or to the moorings and could be possibly linked to other independent variables that form a set of ODEs [113].

The hydrodynamic parameters like added mass and damping have been obtained using a boundary-element code while the excitation force coefficients can also be found through use of the Haskind relationship [114].

The convolution term has been represented as a polynomial transfer function obtained from a frequency-domain identification method [115].

### 3.1.3 Distribution Code Requirements

Due to the small size of marine energy plants and other generation farms connected to the distribution system in Spain, no specific grid code has been issued as yet. However, the Transmission System Operator, REE, has defined grid code requirements for the grid connection and operation of wind turbines.

The Ministerial Order, OM 2225/1985 [116], is a collection of technical and administrative details setting the connection conditions for small power plants, which is still used and is applicable for wave farms. It states that the maximum power transmitted from each point of connection to the system shall not exceed 5% of the minimum short-circuit power at the connection point.

This Ministerial Order is a document created when distributed generation was relatively rare, and it is expected to be replaced in the very near future. For this purpose, the Spanish National Energy Commission (CNE) has issued a proposal of operating procedure

(POD 9 [117]) outlining operating criteria for connection to the distribution grid. This proposal states the limits and quality requirements to be complied with at all voltage levels of the distribution grid. With respect to these regulations, voltage is allowed to vary up to  $\pm 10\%$  around its nominal level.

From the power quality standpoint, Spanish electrical installations, in general, must cope with the European Standard EN 50160 [118]. Standard EN 50160 defines the recommended characteristics of the voltage at the customer's supply terminals in the public low voltage and medium voltage distribution systems. In summary, the following values are allowed:

- Voltage variations: For a week period, 95% of voltage rms values (averaged over 10 min intervals) must be included in the interval  $U_n \pm 10\%$ . For every 10 min period, average rms values must be in the interval  $U_n = [+10\%; -15\%]$  (only in low voltage [LV] networks).
- Fast voltage variations: In normal operating conditions, fast variations should be under 5% of  $U_n$  for LV networks and 4% for medium voltage [MV] networks.

Behaviour during system disturbances is detailed in operating procedure 12.3 issued by REE [33]. WECs should remain connected whenever voltage stays within the grey area of Figure 3.3.

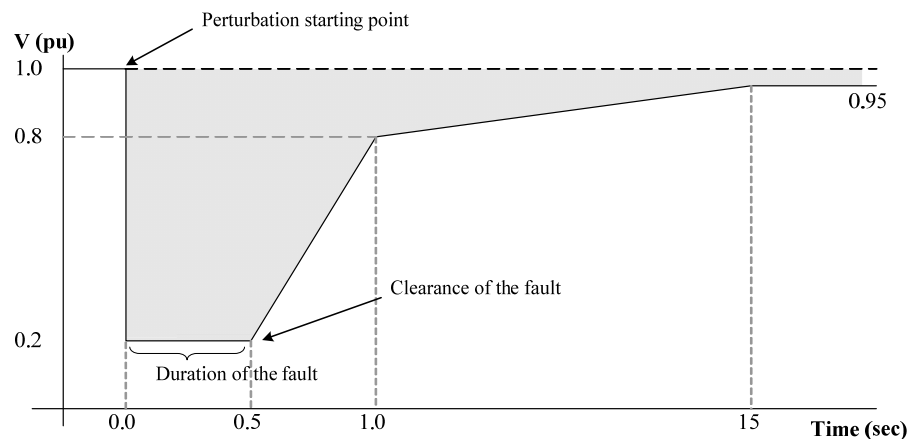

Figure 3.3: Fault ride-through capability

### 3.1.4 Load Flow

In a steady-state power flow analysis, the dynamic generation profile is not taken into account. Only the effect of reactive power control capacity is evaluated, namely the effect of using different generator configurations, in particular with or without the use of power electronics. Four different WECs have been defined for this power flow analysis.

1. Squirrel cage generator (SC) without reactive power control and power factor equal to 0.88. There is reactive power consumption due to the magnetisation of the machine.
2. Static generator (SG) with power factor control equal to one. There is no reactive power exchange between the machine and the rest of the grid.
3. SG with voltage control. Voltage control modifies reactive power exchange to fix the voltage level at the machine to one per unit.
4. SG with droop control. The control defines reactive power exchange depending on the voltage variation.



The main aim of this study is to determine the maximum voltage variation when connecting WECs based on a squirrel cage generator with no reactive control. Cases testing different power electronics interfaces and control strategies are analyzed and compared.

Even though the results for voltage control and droop control are nearly the same very small differences are to be appreciated. These differences are due to the behaviour of each control; in the case of voltage control, the reactive power exchange between the machines and the rest of the grid is intended to maintain the voltage at a fixed value at a given location within the grid. By contrast, in the case of droop control, the reactive power exchange depends on the voltage variation but may not assure that the voltage at the machine terminals remains necessarily equal to a specified value.

### ***Loading Level***

The loading level of the cables and overhead lines depends directly on the active power generated by each WEC and on the reactive power exchange.

For this study, the wave farm is supposed to be 20 MW rated, which is the maximum allowed power according to local grid codes. Figure 3.4 shows the results obtained. It can be observed that when power factor is set to 1 (SG), the loading level is lower than in the SC case. This comes from the effect of reactive power consumption by SC generators.

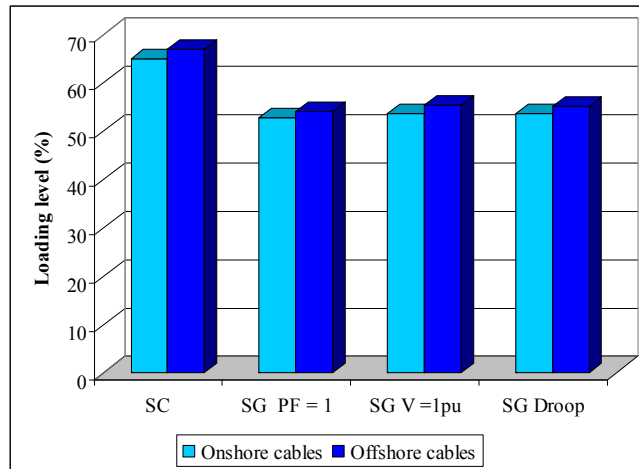

Figure 3.4: Maximum loading level

Hence, under steady-state conditions, none of the designed *bimep* electrical components (submarine cables) are overloaded as resulting values never exceed 67% of rated capacity.

### ***Voltage Profile***

Voltage variations can be influenced by reactive power control. For the studied cases, Figure 3.5 shows the maximum voltage variation from the WEC 1 to the PCC and Figure 3.6 depicts the same results for WEC 4 (Section 3.1.1).

As seen in Figure 3.5 and Figure 3.6, when SC generators are used (i.e., without reactive control), the voltage variation at the connection point is negligible.

Nevertheless, voltage difference within the *bimep* system range from 4% to 7%. This is due to the fact that SC generators consume reactive power. The lowest voltage (0.93pu) is obtained at Generator 1 (Figure 3.5). However, throughout the *bimep* grid, the voltage remains within allowed limits, as no value exceeds 10% voltage shift.

Figure 3.5 shows that the voltage profile depends on the implemented reactive power control. When power factor is set to 1 (i.e., reactive power equal to 0) a maximum variation of 2% is produced, whereas this variation remains under 1% when voltage control or droop control is implemented. In all cases, voltage at the PCC is maintained at 1.0 pu due to the strength of the distribution grid.

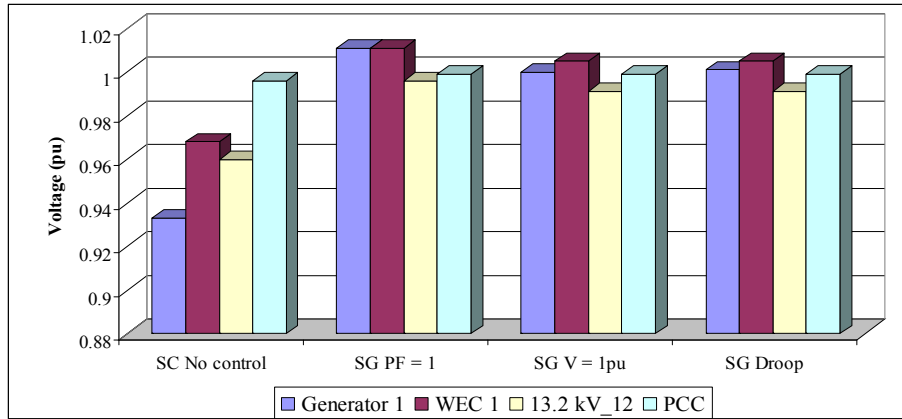

Figure 3.5: Voltage profile from the WEC 1 to the PCC for SC and SG

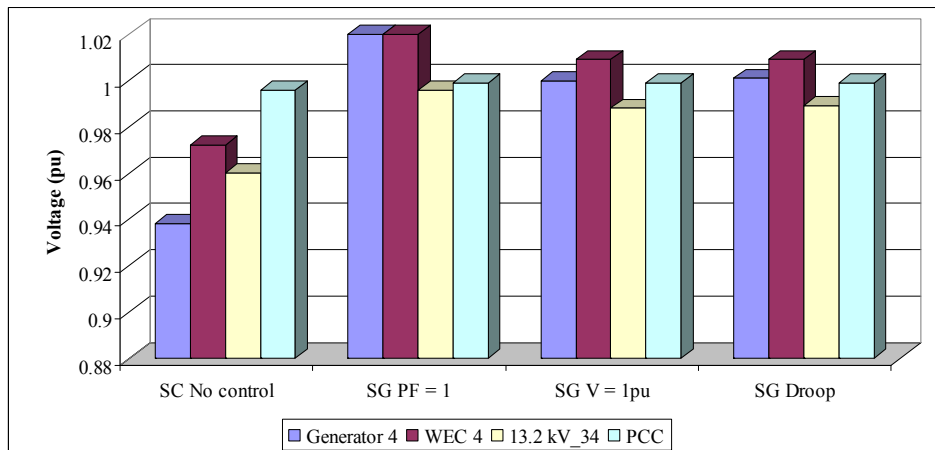

Figure 3.6: Voltage profile from the WEC 4 to the PCC for SC and SG

### 3.1.5 Power Losses

#### *Steady-State Losses*

There are two components of technical losses on a distribution network [119].

1. Load losses: These losses are proportional to the square of the current supplied to the loads. These losses are also known as copper losses or  $I^2R$  losses.
2. No-load losses: These losses are fixed and do not depend on the load. The no-load current occurs due to the magnetization of transformers, generators and motors. These losses arise as a result of eddy currents within these components.

Load Losses are calculated on the relevant part of the network under peak demand condition using DlgSILENT PowerFactory load flow package.

For the studied cases, Figure 3.7 (a) shows the total power losses, when the farm is producing its rated power 20 MW.

No-load losses are 10 kW when SC generators are used, and in the case of SG generators they reach 20 kW. However, when considering total losses, with SC generators the losses are higher, mostly due to the absence of reactive power compensation.

Similarly, power losses effect can be also analysed through efficiency, as shown in Figure 3.7 (b). In the cases of SG when power factor is set to 1, the efficiency is higher since the reactive power is equal to 0.

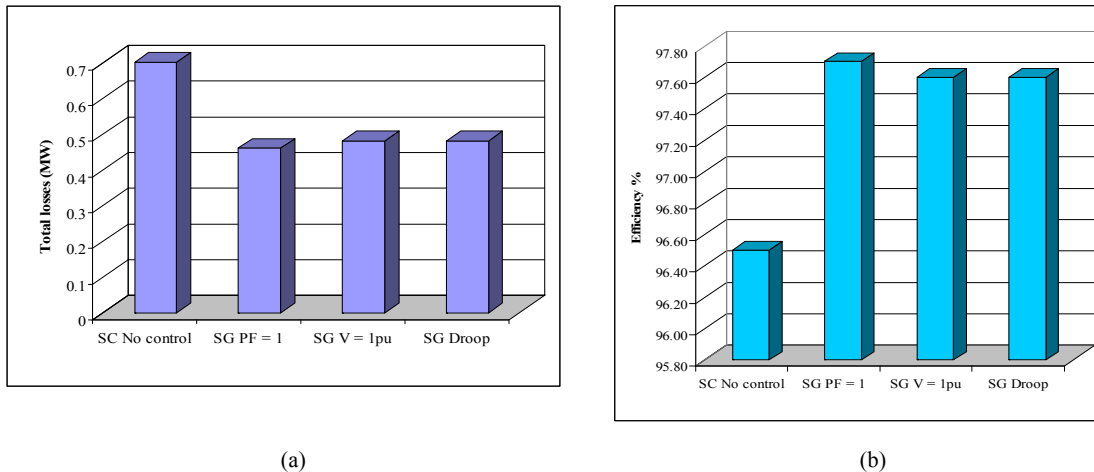

Figure 3.7: Total losses (MW) and efficiency (%).

### 3.1.6 Aggregation of Devices

Dynamic simulations have been carried out in order to assess the aggregation effect (grouping of devices), due to the fact that the waves do not reach the four WECs at the same time. Aggregated power of the farm is obtained considering a random phase lag (time delay in the resource) between the generated powers of each of the different units.

Figure 3.8 shows (a) the power generated by a wave farm based on attenuator-type devices with SC and (b) the voltage at the PCC, with and without aggregation effect.

As shown in the figure, in this analysis the peak value of both power and voltage decreases due to the smoothing effect. However the mean value is the same in both simulations.

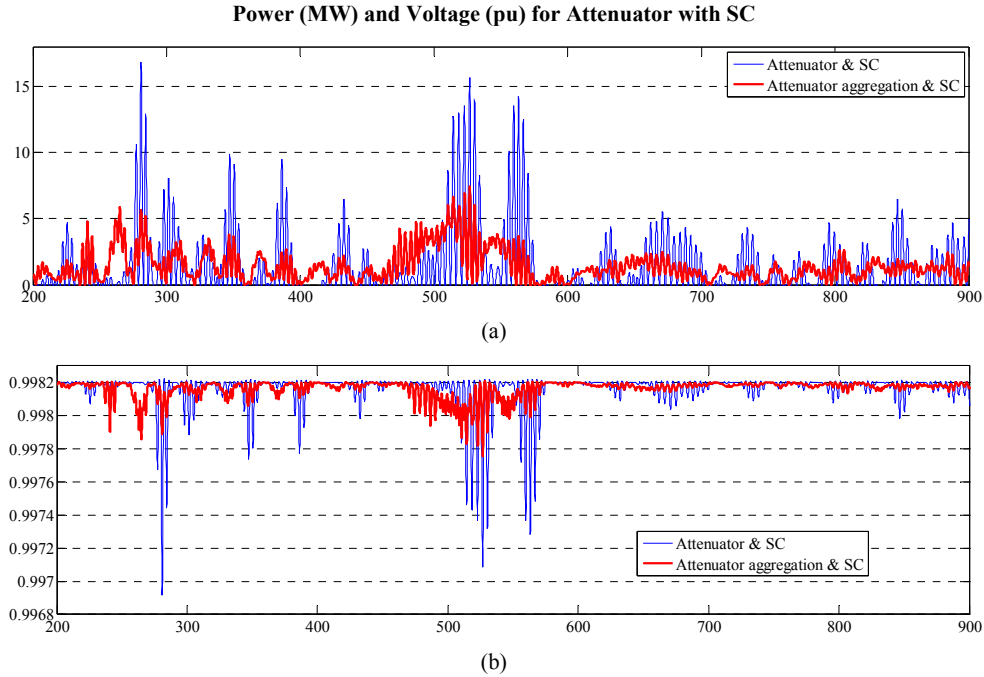

Figure 3.8: Power and voltage variations

As can be seen in Table 3.2, aggregation reduces the output power variance.

	Peak Value	Variance	Mean Value
Attenuator and SC	18.49	5.40	1.63
Attenuator aggregation and SC	8.06	1.39	1.62

Table 3.2: Power variance

### 3.1.7 Contingency Analysis

In this case study, the strength of the electric network at the *bimep* PCC made the contingency analysis irrelevant, since very small variations have been observed in terms of voltage and stability of the *bimep* infrastructure at the PCC.

### 3.1.8 Voltage Issues

Concerning voltage issues, special attention has been paid to the behaviour of the wave farm converters during a low-voltage event (fault) at the PCC.

#### ***Fault Ride-Through***

A voltage dip of 80% was applied at the PCC with the objective of analysing fault ride-through capability of the wave farm.

Three different WECs have been evaluated to assess the influence of reactive power control when a voltage dip occurs.

1. Attenuator + SC: without reactive power control
2. Point absorber + SC: without reactive power control
3. Attenuator + SG: with power factor control (set to 1)

When there is no reactive power control (1 and 2), the value of the generated active power determines the behaviour of the generators. As can be seen in Figure 3.9, within the dip a higher instantaneous power causes a lower voltage. Once the fault is cleared, the recovery time increases as the power generated is higher.

Notice that the WEC technology type, attenuator or point absorber, does not affect the response.

However, when a reactive power control is implemented, power factor is set to 1. In this case, neither the WEC technology nor the instantaneous active power affects the response (Figure 3.10).

Voltage at the PCC is nearly the same in all three cases; this is because the distribution grid is strong enough for the installed wave farm.

### 3.1.9 Conclusion

In this case study, detailed models for different WEC have been implemented in the DIgSILENT simulation tool. These models emulate the dynamic behaviour of the WECs in irregular waves. Concerning *bimep*, a detailed model has also been used.

Power flow analysis and dynamic simulations have been carried out. Results obtained show that in both cases the connection requirements regarding voltage variations at the PCC are satisfied ( $\pm 10\%$ ).

Nevertheless, the efficiency and the electrical behaviour inside *bimep* depend directly on the reactive power control strategy.

In this study, the effects of the wave farm on the connection point are not really significant since the associated distribution grid is strong with respect to the power level of the wave farm. However, with an increasing penetration level of marine renewable energies, satisfying power quality requirements will be more complex and specific studies on reactive power control and compensation (e.g., FACTS) will be mandatory.

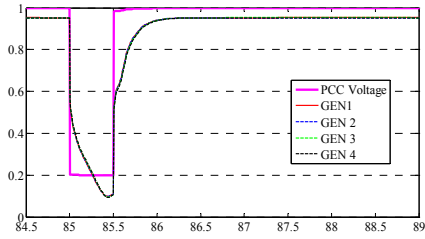

(a) 1.1 MW

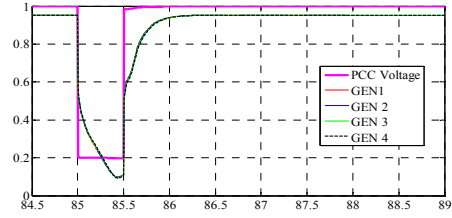

(b) 6 MW

**Voltage (pu) for Point absorber with SC**

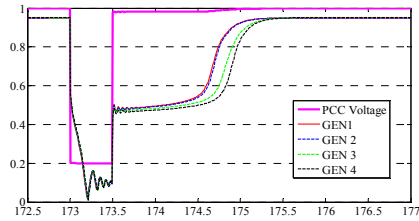

(c) 7.5 MW

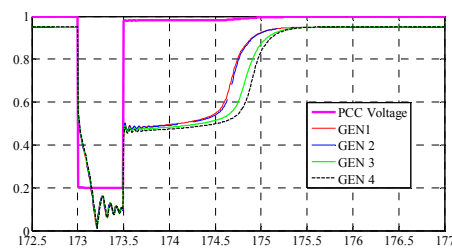

(d) 12 MW

Figure 3.9: Voltage profile (pu) when a voltage sag occurs at the PCC for different wave farm power (a) 1.1 MW (b) 6 MW (c) 7.5 MW (d) 12 MW

**Voltage (pu) for Attenuator with SG**

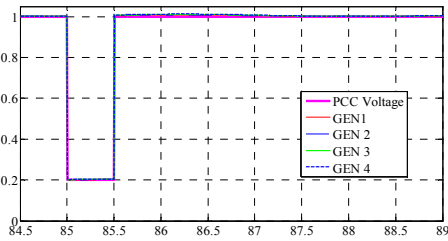

(a) 1.1 MW

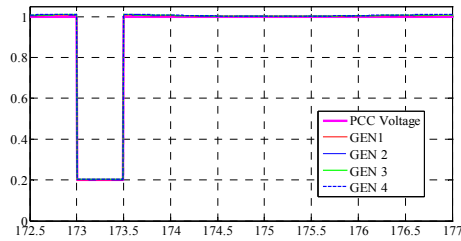

(b) 7.5 MW

Figure 3.10: Voltage profile (pu) when a voltage sag occurs at the PCC for different wave farm power (a) 1.1 MW (b) 7.5 MW

## 3.2 DISTRIBUTION SYSTEM: IRELAND CASE STUDY<sup>2</sup>

The goal of this study is to analyse the impact of electricity produced by wave energy converters on Belmullet's local electrical network. The converters are modelled by means of synchronous generators with a periodic mechanical power input block. Directly-connected synchronous generators (i.e. without power electronics or reactive power compensation) were used.

It was not intended to study the internal parameters of the generators, as the focus of the study was on the grid itself.

Belmullet was chosen in 2009 by the Irish government to become the national wave energy test site of the Republic of Ireland. The test site is expected to become operational in 2011 and is planned to have up to a maximum generating capacity of 20 MW. The geographical configuration of the wave farm and the electrical component ratings are modelled according to the design being implemented by the test site owner's engineers, ESBI.

### 3.2.1 Electrical Network Modelling

Power system simulators like "PowerFactory", "PSS/e" and others are generally designed so that the power output of generators is constant during a simulation, whose timeframe is usually of the order of seconds (one to ten seconds). In some wind turbine models, the wind speed is assumed to be constant and there is no way to modify it during the simulation [121]. A ramp or step increase/decrease of power generation is commonly used to model power generation fluctuation along with turbulence functions. However, the power fluctuations due to wave electricity cannot be modelled in such a way. Hence, the impact on the electrical network of a periodically-varying power source of significant amplitude is thus a new field of research.

The network model used in the current study is shown in Figure 3.11. Four synchronous generators represent the wave energy converters (or arrays of converters).

Each generator is connected to an offshore 0.4 kV/10 kV transformer. The generators are numbered (from left to right): SG 1, SG 2, SG 3, SG 4 (Figure 3.11). Four subsea cables connect the generators to the shore. The subsea cables connected to generators SG 1 and 2 are 6 km long, and the two others connected to generators SG 3 and 4 are 14 km long.

On the shore, there is a substation stepping the voltage up to 20 kV. A 20 kV, 5 km long overhead line connects the substation to the town of Belmullet. Then, a transformer steps the voltage up to 38 kV. The rest of the Irish electrical network is modelled by means of a fixed voltage source (whose voltage is set to 1.0 pu) in series with a reactor whose impedance represents the short circuit level at this point in the network.

---

<sup>2</sup> The case study report is adapted from the ICOE 2010 article, "Wave Energy Grid Integration in Ireland – A Case study" [120]

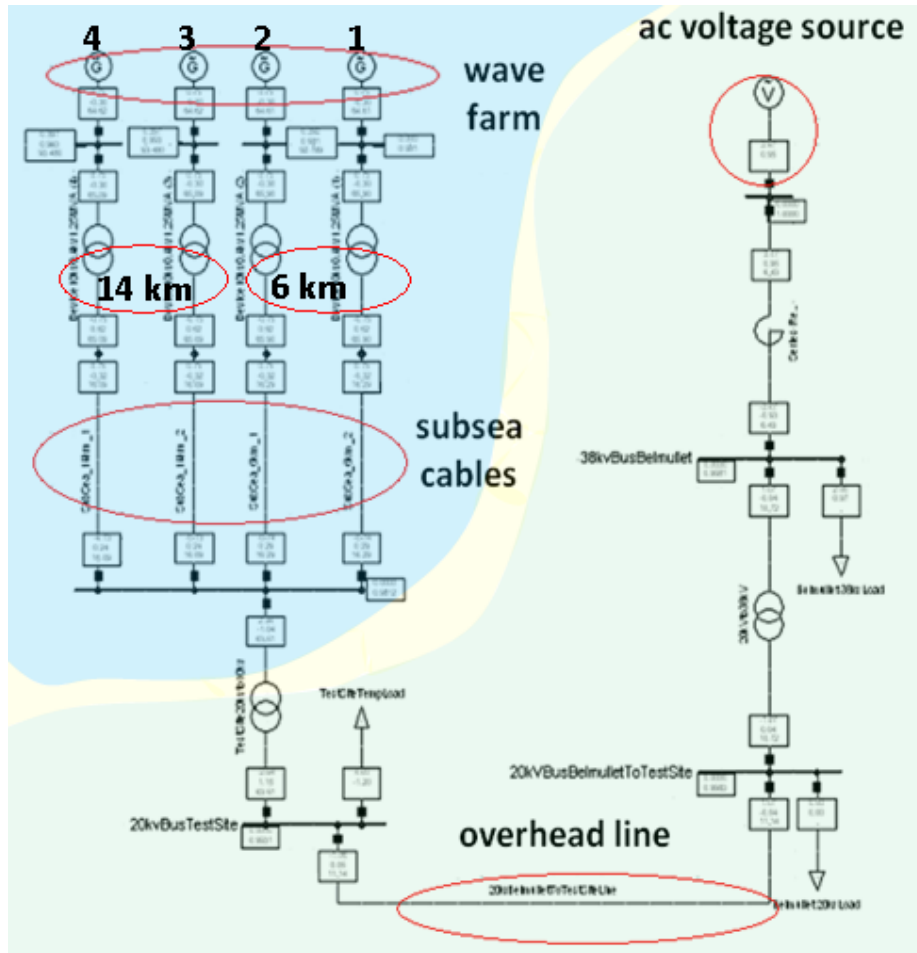

Figure 3.11: Grid model

### 3.2.2 WECs Modelling

The mechanical power input to each generator is modelled as:

$$P_{mech} = P_{avg} \quad \text{for load flow analysis}$$

$$P_{mech} = P_{avg} + \sum \alpha_i \sin(\omega_i t) \quad \text{for dynamic analysis}$$

It is hence the sum of a constant power ( $P_{avg}$ ), which is the power setting used in load flow analysis, and of one (or more) sinusoidal terms, used in dynamic analysis only. These sinusoidal terms represent the power fluctuations due to waves or due to groups of waves. For the purpose of the simulation, the mechanical power may include up to three sinusoidal terms. As the presence of larger amounts of energy storage results in smaller power fluctuations around the mean value, varying the amplitude of these sinusoidal terms models the effect of varying levels of energy storage within the device.

The reactive power output of each generator is set to be constant and equal to 0.93, according to the power factor limits (0.92-0.95 lagging) imposed by the Irish distribution code for wind turbines.



In this study, the maximum average power of the wave farm is equal to 5 MW. (This is explained more in detail in the “Distribution Code Requirements” section.)

### **3.2.3 Distribution Code Requirements**

No distribution code requirement has been issued for marine energy converters as yet, but it is thought that similar requirements will be applied for both wind turbines and marine energy converters, at least initially. Hence, the simulation results were compared to the requirements for wind turbines.

The Irish Distribution System Operator (ESB) refers to standard EN 50160 for voltage disturbances in its Distribution Code [122].

This standard states that rapid voltage changes should have a magnitude not exceeding 4% of rated voltage on the medium voltage system (from 10 kV up to 38 kV in the Irish system) for the supply voltage and under normal conditions.

In practice, a 3% voltage limit is commonly used so as to ensure that the new installation does not cause the flicker severity level to exceed the limits [123], [124]. In addition, these recommendations mention that the shape of the rapid voltage change does not matter: only its magnitude is important. This 3% limit was taken as the maximum limit for voltage change for the study.

However, it is thought that this limit is based on empirical experience and may not be perfectly suited in the case of the assessment of wave energy grid integration, especially on a weak grid. However, this study is a preliminary analysis: it is intended to study the flicker severity level created by the wave farm and cross-check it with the commonly used 3% voltage limit in future studies.

### **3.2.4 Load Flow**

A load flow study is initially performed setting the generator outputs at real power settings of 0.75 MW each, at a power factor equal to 0.93. The total wave farm power capacity is hence equal to 3 MW and consequently, it does not have to comply with more stringent distribution code requirements imposed on a wind farm exceeding 5 MW.

The load flow results indicate that none of the electrical components (e.g., line, transformer, etc.) are overloaded: in fact the loading does not exceed 65%.

The voltage requirements are explicitly specified for the higher limits only at the point of common coupling (PCC). The lower limits are not defined in the distribution code and are variable according to the operating conditions and to the location [125].

The PCC is located at the 20 kV bus connected to the 10 kV/20 kV transformer. The point of connection to the grid is located at the 10 kV bus. The voltage limits for the PCC are more detailed (and more stringent as well) than for the point of connection. Consequently, the requirements for the PCC were applied for both the point of connection and the PCC.

The highest allowed voltage limit is equal to 1.1 pu for nominal voltage levels in the range 230 V to 110 kV, and is hence 10% above rated voltage. It was assumed that the lowest limit was 10% below the rated voltage as well, resulting in a lowest limit of 0.90 pu. With respect

to these assumptions, the voltage throughout the grid remains within the allowed range (Figure 3.12).

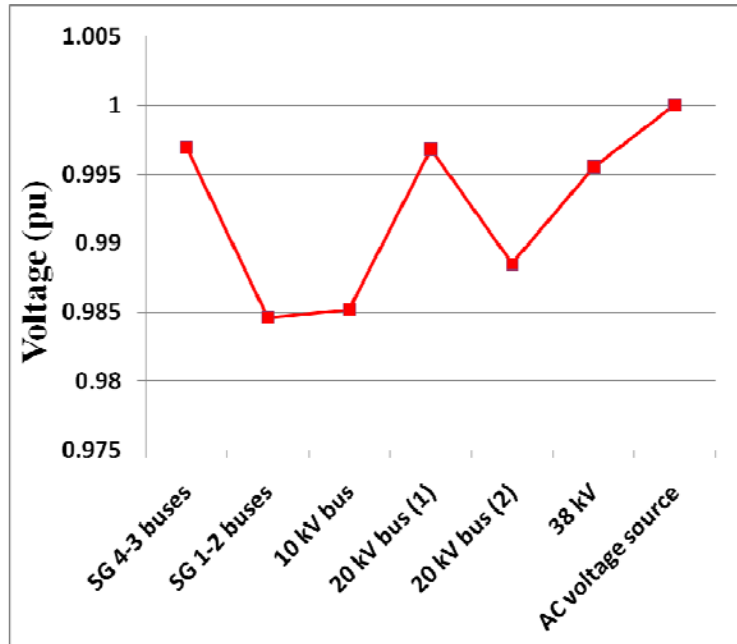

Figure 3.12: Voltage profile from the 10 kV bus to the AC voltage source

The lowest voltage is found at generator SG1 and SG2 buses (0.981pu) and the highest voltage is found at the AC voltage source, whose voltage is set at 1.0 pu.

### 3.2.5 Power Losses

The power losses are proportional to the square of the current. Consequently, the dynamic power losses in the network are expected to increase relative to the load flow solution at the same mean power level due to the varying current supplied by the wave farm. It is assumed that the impedance of the network is static. This assumption is valid provided that the temperature of the resistive components and the network frequency are constant (or do not vary significantly over a power fluctuation period). This is a reasonable assumption, since the thermal time constants of the components are much greater than the time length of the simulation.

### Steady-State Losses

Figure 3.13 shows the distribution of real power losses with respect to each resistive component for a wave farm power capacity of 3 MW.

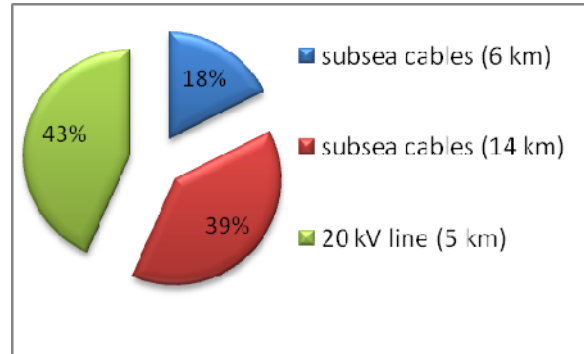

Figure 3.13: Distribution of power loss with respect to the electrical components (load flow)

The subsea cables and the overhead line are the only components to dissipate real power, as the transformers are assumed lossless. Both component types dissipate almost the same amount of power (43% for the overhead line, and 57% for the subsea cables).

Quantitatively, the real power losses represent 0.11 MW. For a wave farm of average capacity 3 MW, the efficiency of the network is thus equal to 96.3%. Losses are, as expected, not negligible considering the low X/R ratio and the low voltages of the system.

### Dynamic Losses

The study focuses on the effect of power fluctuations on the power losses and hence dynamic simulations were carried out for several fluctuation amplitudes. The mechanical power is described as:

$$P_{mech} = P_{avg} + \alpha_1 \sin(\omega_1 t) + \alpha_2 \sin(\omega_2 t) + \alpha_3 \sin(\omega_3 t) \quad \text{Eq. 9}$$

with  $\omega_i = 2\pi/T_i$

where:

$P_{avg}$  is the constant average power

$\alpha_i$  are the amplitudes of the power oscillations

$\omega_i$  are the pulsations

$T_i$  are the the periods of these oscillations

Hence, the sinusoidal terms represent the power fluctuations associated with individual waves or with a group of waves.

The individual period of sinusoidal term was kept constant during all the simulations (Table 3.3), the amplitudes only were changed (Table 3.4). These periods are reflective of the significant spectral components of typical sea states off the west coast of Ireland.

	$T_1$	$T_2$	$T_3$
Period (s)	10	7	9

Table 3.3: Period of the sinusoidal terms

One of the amplitude settings (in red in Table 3.4) is taken as a reference (100%), from which all the other amplitude settings are derived by proportionality. This method enables the power fluctuations to keep the same shape.

amplitude (% of $\alpha_{i\_ref}$ )	amplitudes (pu)		
	$\alpha_1$	$\alpha_2$	$\alpha_3$
<b>100</b>	<b>0.3</b>	<b>0.1</b>	<b>0.2</b>
90	0.27	0.09	0.18
80	0.24	0.08	0.16
70	0.21	0.07	0.14
60	0.18	0.06	0.12
50	0.15	0.05	0.10

Table 3.4: Amplitude sets for the simulations

Figure 3.14: shows the real power output of generator SG 1.

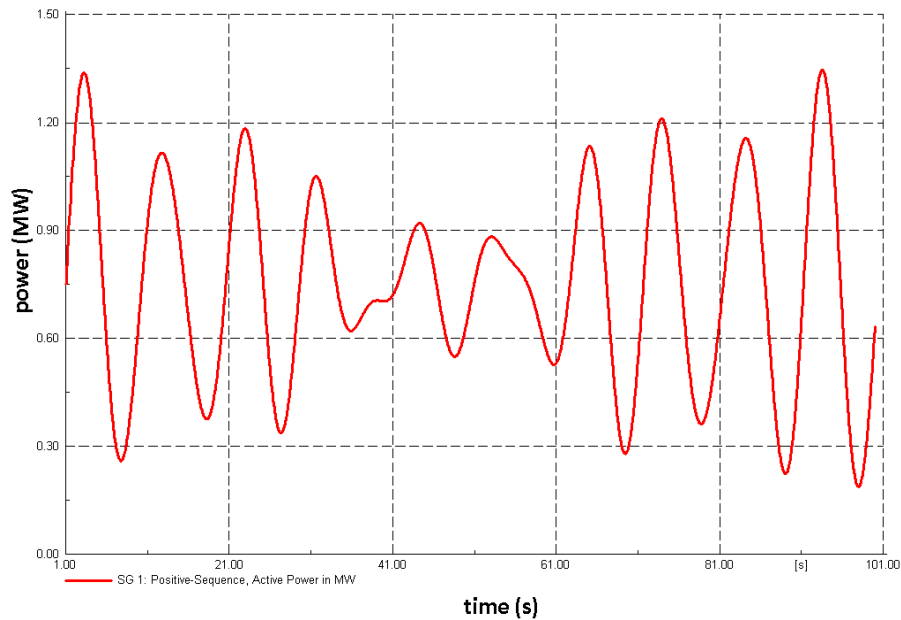

Figure 3.14: Power output of generator SG 1

In order to create a realistic wave farm power output, a phase shift was applied to each generator. The phase shifts for generators SG 2, 3 and 4 were created randomly under Matlab (Table 3.5).

Generators	SG 1	SG 2	SG 3	SG 4
Phase shift (°)	0	346.7	196.9	187.6

Table 3.5: Phase shifts

As mentioned earlier, the study focuses on the difference in power loss between two cases with either a constant or a variable current. This difference was calculated as:

$$\Delta P_{loss} = P_{variable} - P_{constant} = R[(I_{variable})^2 - (I_{constant})^2] \quad \text{Eq. 10}$$

where R is the resistive component of the series impedance.

Clearly, the instantaneous loss difference can be positive ( $(I_{variable})^2 > (I_{constant})^2$ ) or negative ( $(I_{constant})^2 < (I_{variable})^2$ ). However, the mean energy loss (i.e., the integral of the power loss over time) is positive: there are more losses for a varying current than with a constant current.

The extra power loss due to the varying current decreases the network mean efficiency. Figure 3.15 shows the network instantaneous efficiency for the reference amplitude set (100%) and for the 50% amplitude set.

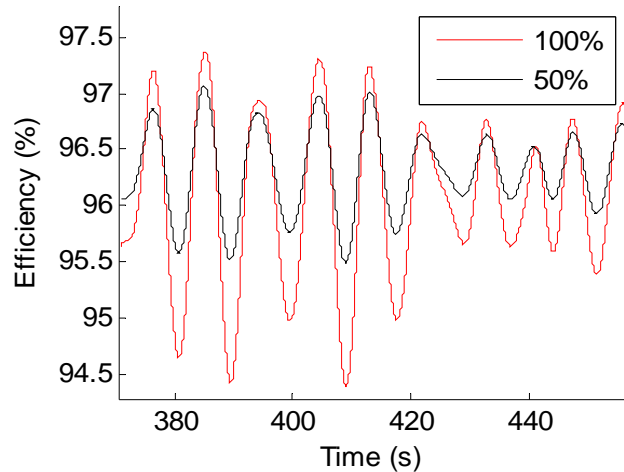

Figure 3.15: Efficiency of the network

The load flow results indicated that the network efficiency was equal to 96.3% (as 0.11 MW was lost over 3 MW). In the dynamic case, the efficiency oscillates around a mean value, which is smaller than the load flow efficiency.

As expected, the network mean efficiency decreases with respect to the power fluctuation amplitude. A maximum efficiency decrease of 0.2% is observed between the load flow (96.3%) and the dynamic case using the 100% amplitude set (96.1%). This may be considered as negligible but must still be noted: the efficiency may decrease significantly when the power capacity of the wave farm is higher.

In addition, the higher the instantaneous generated power, the higher the instantaneous power loss. Consequently, the efficiency is out-of-phase with respect to the generated power and as a result, the power exported to the rest of the network is smoother compared to the generated

power (input). Figure 3.16 shows the standard deviation of both the power exported by the generators (called  $P_{in}$ ) and the power absorbed by the AC voltage source (called  $P_{out}$ ).

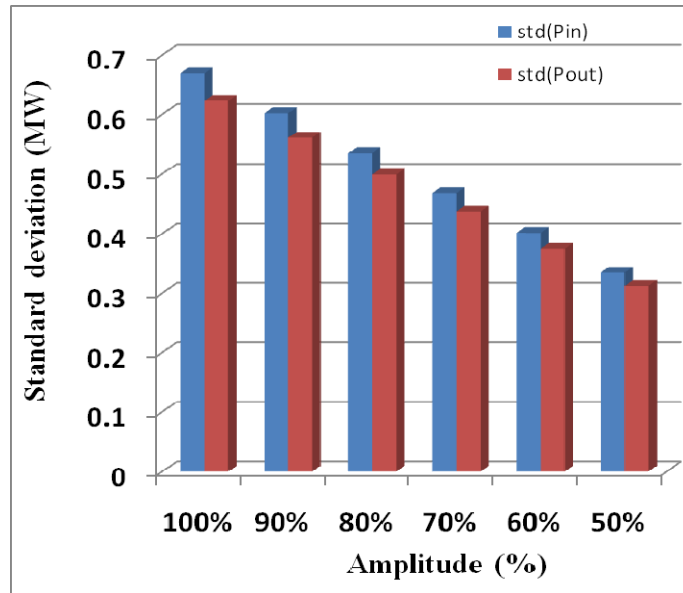

Figure 3.16: Standard deviation of  $P_{in}$  and  $P_{out}$

Figure 3.17 shows the difference between the standard deviation of  $P_{in}$  and  $P_{out}$  with respect to the fluctuation amplitude.

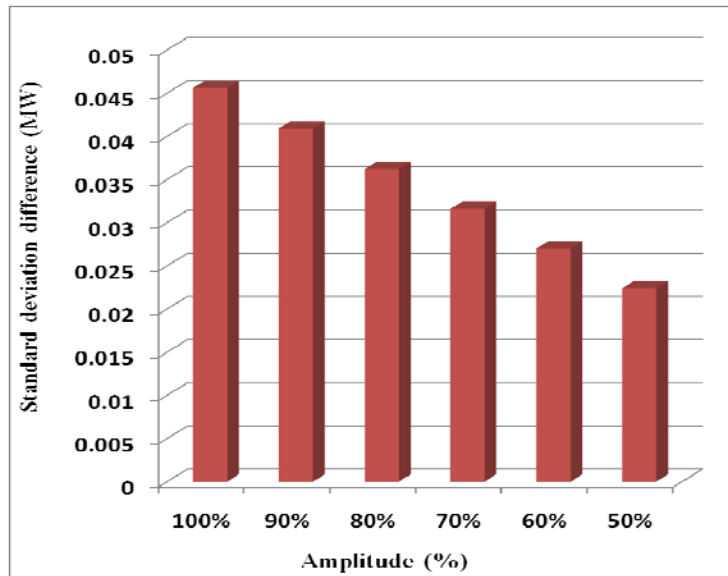

Figure 3.17: Difference between the standard deviation of  $P_{in}$  and  $P_{out}$

This difference is up to 0.025 MW for the 100% amplitude case, which is negligible. However, this power smoothing effect from the network might be significant for higher wave farm power capacities.

### 3.2.6 Aggregation of Devices

The aggregation of an array of devices can be modelled by phase shifting the power output of each device by a random phase shift. This dynamic study intends to investigate the power smoothing effect due to this device aggregation. The three sinusoidal terms have the following periods and amplitudes:

$\alpha_i$ (MW)	$T_i$ (s)
0.3	10
0.1	7
0.2	9

Table 3.6: Amplitudes and periods of the sinusoidal terms

The power output of generator SG 1 is shown in Figure 3.14. The random phase shifts between generators, with respect the phase of generator SG 1, are given in Table 3.7.

set #	Phase shift (°)			
	SG 1	SG 2	SG 3	SG 4
1	0	42.3	106.8	114.8
2	0	152.7	182.8	30.8
3	0	94.5	288.4	10.5
4	0	334.4	262.9	175.9
5	0	208.3	85.4	165.2
6	0	346.7	196.9	187.6
7	0	83.4	176.0	224.7
8	0	244.5	142.4	132.3
9	0	355.7	13.6	318.7
10	0	328.8	286.6	35.5
ref	0	0	0	0

Table 3.7: Random phase shifts

A reference case, in which no phase shift is applied, was also studied. It is the worst case, as all generator outputs are in phase and hence there is no power smoothing effect due to the device aggregation. Figure 3.18 shows the maximum voltage standard deviation versus the random phase shift sets. This maximum deviation occurs for every phase random shift set at the 10 kV bus.

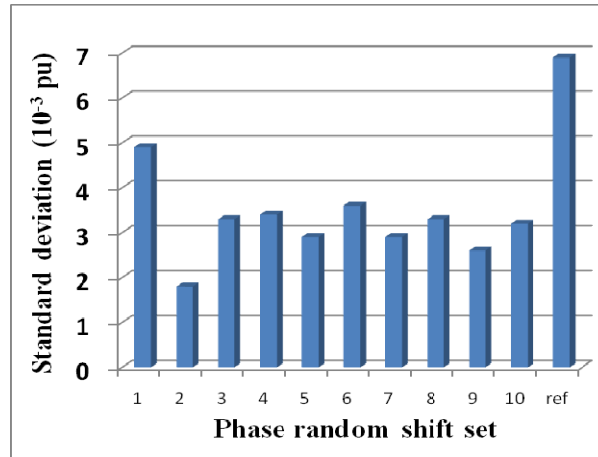

Figure 3.18: Maximum voltage standard deviation

It is clear from Figure 3.18 that the voltage standard deviation can be dramatically reduced thanks to aggregation. The range may be significant for flicker severity level.

### 3.2.7 Contingency Analysis

This load flow study analyses the impact of generation unit loss on the voltage of the 10 kV bus. The generation loss consists of the loss of one, two, three or even the four generators.

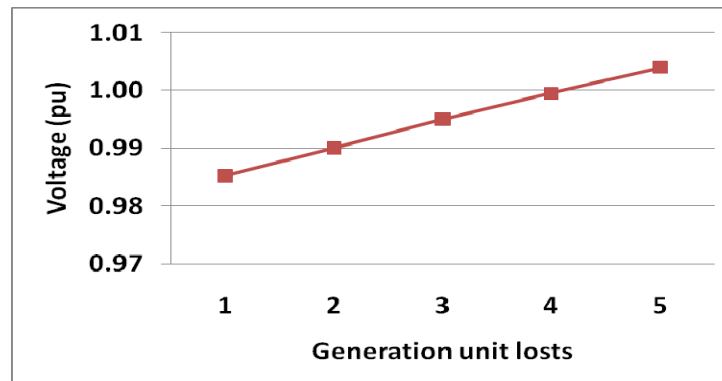

Figure 3.19: Voltage at the 10 kV bus versus number of generation units lost

It is clear from Figure 3.19 that the voltage remains in the allowed range (0.90 pu, 1.1 pu), even for a complete loss of the wave farm.

### 3.2.8 Voltage Limits and Voltage Variations

In this dynamic analysis, the power fluctuations are sinusoidal at a single frequency. The fluctuation period is equal to 10 s and there is no phase shift applied here (i.e., all the generator outputs are in phase). The average power and the power fluctuation amplitude are varied so as to analyse their impact on the grid voltages.



## Voltage Limits

The voltage limits study is performed for a range of wave farm power (average) capacity from 1 MW to 5 MW. Considering the power fluctuations, the maximum generated power is sometimes higher than 5 MW, sometimes lower. Having a power output higher than 5 MW implies that more stringent distribution code requirements have to be applied for the wave farm [126]. However, it is unclear how these regulations would actually be applied to the wave farm, considering the very oscillatory characteristics of the power output (e.g., would they be applied on the maximum average power or on the maximum instantaneous power?). In this study, it was thus considered that regulations for power plant of capacity less than 5 MW are still applicable in this situation.

According to the requirement of the Irish Distribution System Operator (ESB), the voltage should remain in the allowed range specified in the Irish Distribution Code. The maximum and minimum voltages were hence analysed with dynamic simulations at the 10 kV, 20 kV (connected to the 10 kV/20 kV transformer) and 38 kV buses.

The maximum voltage limits are not exceeded in the load flow case. Figure 3.20 shows the maximum voltage values at the 10 kV, the 20 kV and the 38 kV buses versus wave farm power capacity.

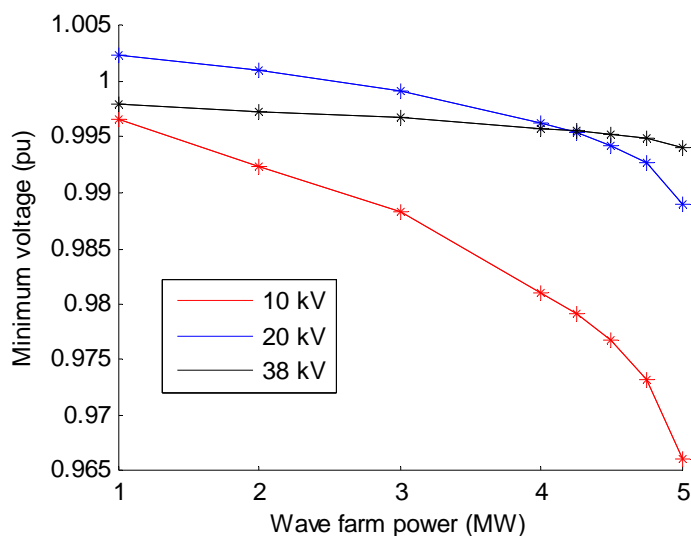

Figure 3.20: Maximum voltage values at the 10 kV, 20 kV and 38 kV buses

It is clear here that the highest voltage limit (1.1 pu) is not exceeded here.

It is also interesting to study the minimum voltages. Figure 3.21 shows the minimum voltages (in all cases at the 10 kV bus) for a range of power capacity from 1 MW to 5 MW.

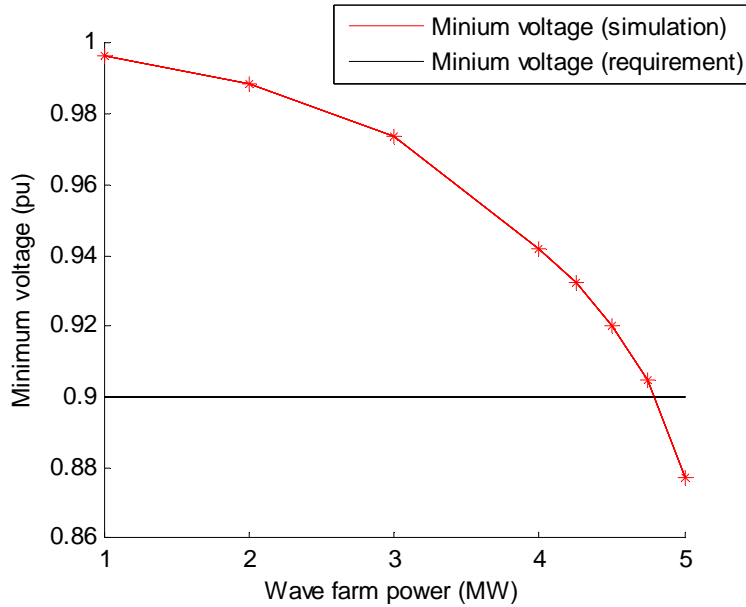

Figure 3.21: Minimum voltages

The minimum voltage is always greater than the lowest voltage limit for a power capacity from 1 MW to 4.75 MW. However, it goes below the limit for a power capacity of 5 MW with a fluctuation amplitude of 5 MW. For this power capacity, a fluctuation amplitude of 2.4 MW (i.e., 96% of the average power equal to 3 MW) must not be exceeded for the voltage to remain in the allowed range.

### ***Voltage Change***

As stated previously in the “Distribution Code Requirements” section, a 3% voltage limit is generally applied to voltage change magnitude to ensure that the flicker severity level is low enough across the network. This study intends to determine the limit of the power fluctuation amplitude that causes this voltage change magnitude to be exceeded. This study was carried out for several average power capacities from 1 MW to 5 MW.

Figure 3.22 shows the maximum amplitude allowed for power fluctuations (as a percentage of the total generating capacity of the wave farm). It is shown here that for a generation power up to 3 MW (included), the voltage changes induced on the grid have a magnitude smaller than 0.03 pu, even for extreme power fluctuations (from zero to peak value).

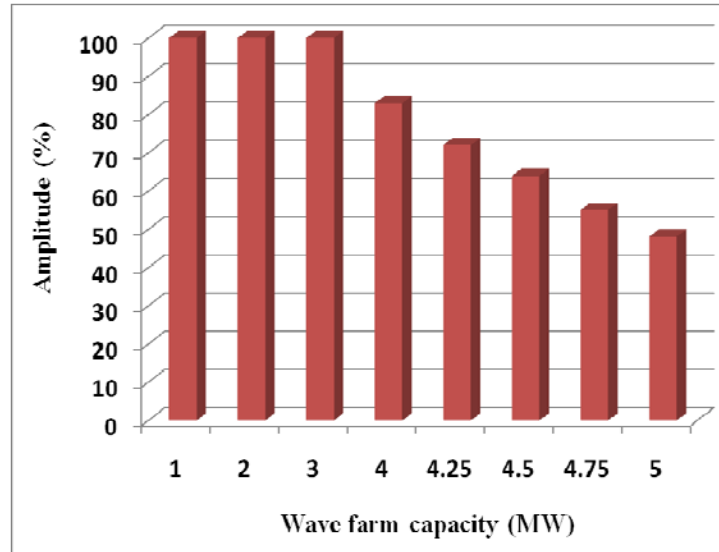

Figure 3.22: Maximum allowed power fluctuation amplitude

By contrast, when power is greater than or equal to 4 MW, the fluctuation amplitude must not be greater than a certain limit, shown in Figure 3.22. Hence, storage is needed to smooth the power variations if large power fluctuation amplitudes are to be expected.

The maximum allowed fluctuation amplitude (in %) follows an inverse exponential trend with respect to the power capacity (in MW) from  $P_{avg}=4$  MW.

### ***Fault Ride-Through***

The fault applied to the grid for the fault ride-through study is a short-circuit occurring at the PCC. The voltage was analysed at the PCC and at the generator terminals during and after the fault with respect to:

- Two different types of generators: squirrel-cage generator (scenario a), and synchronous generator with fully-rated power electronics (scenario b)
- The wave farm power capacity

The first type of generator used (scenario a) is an induction, squirrel-cage generator, which is typically directly-connected to the grid. The second type of generator used (scenario b) is modelled by means of a static generator. This built-in DIGSILENT model is suitable for representing wave farms connected to the grid via fully-rated power electronics.

For each type of generator, simulations were carried out with respect to an increasing wave farm power capacity from 1 MW, to 3 MW, to 5 MW.

In all simulations, the fault applied is a three-phase short circuit at the PCC, of duration 500 ms and of impedance  $R=1.4$  ohms. This fault results in a minimum voltage at the PCC of 0.23 pu in both cases.

Since the fault duration is an order of magnitude shorter than the period of the wave power variation, the mechanical power input to the generator can be maintained at a constant level for the duration of the fault.

## Scenario a

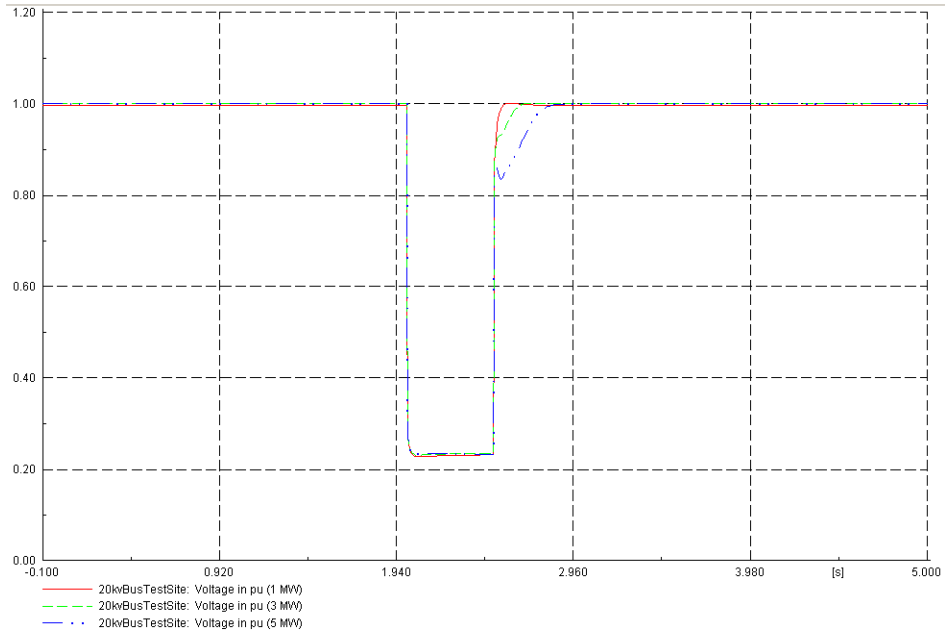

Figure 3.23: Voltage at the PCC for wave farm capacity of 1 MW, 3 MW and 5 MW (Scenario a)

The maximum voltage recovery duration, occurring in the 5 MW case because of the absorption of reactive power by the induction generators, is of the range of 300 ms.

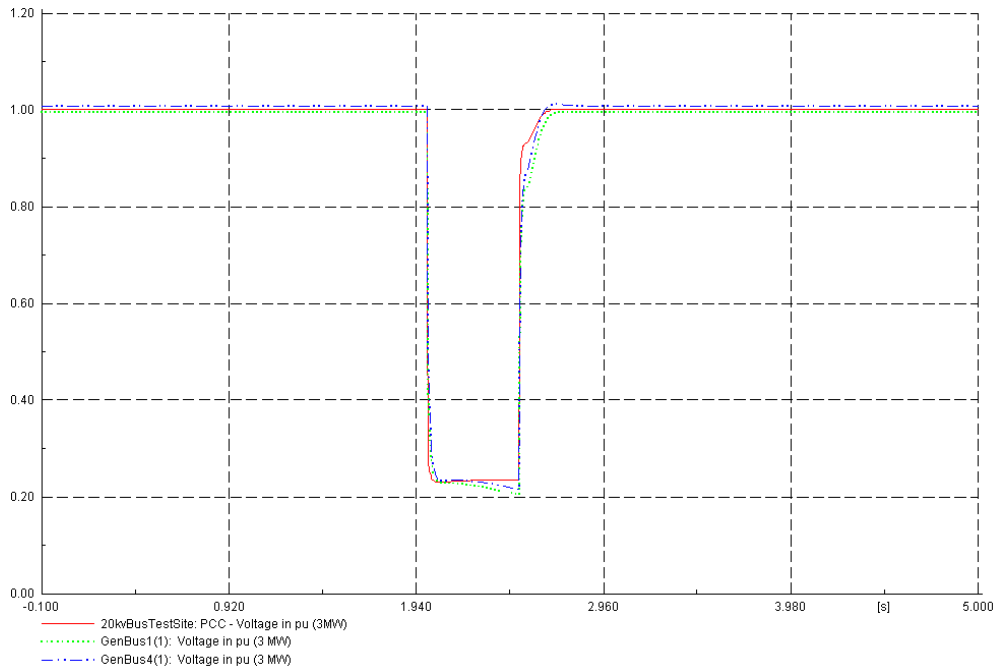

Figure 3.24: Voltage at the PCC and at two generator terminals for a wave farm capacity of 3 MW (Scenario a)

During the fault, the voltage at the generator terminals continues decreasing (Figure 3.24). A slight difference in voltage at the generator terminal is observed. As all the generators have the same internal machine parameters and load flow settings, this difference can be attributed to the difference in subsea cable length. Generator 1 is connected to the shore via a 6-km long subsea cable, whereas the length of the subsea cable linking Generator 4 to the shore is 14 km.

Figure 3.25 shows the same simulation as in Figure 3.24, with the difference that the short-circuit is not cleared in this case and that the simulation is run over 10 s instead of 5 s. This simulation is shown in order to provide a better insight into the voltage decrease at the generator terminals during the fault.

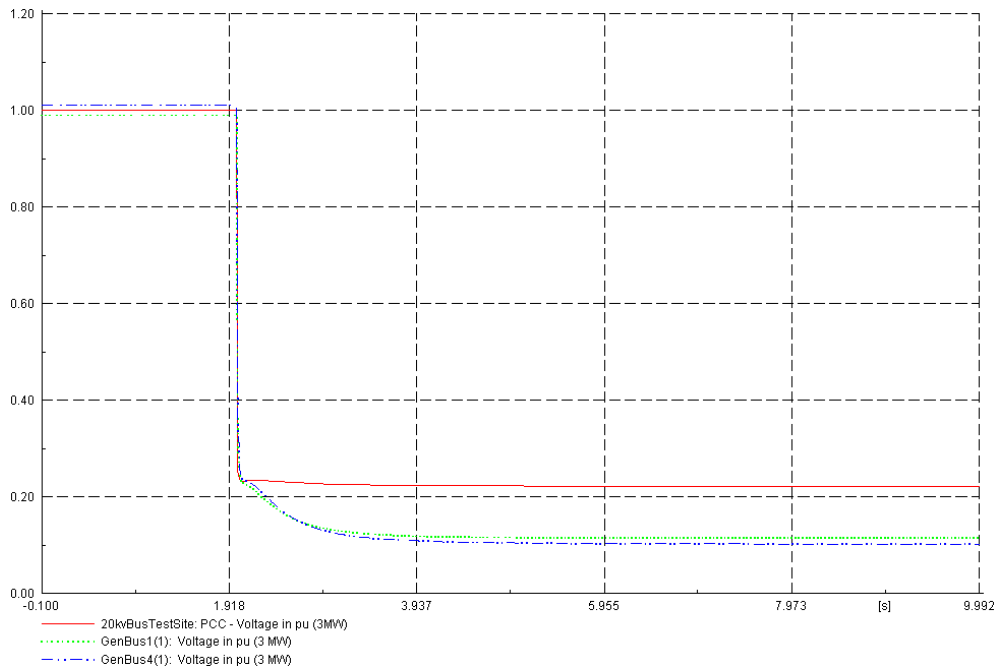

Figure 3.25: Voltage at the PCC and at two generator terminals with no short-circuit clearance for a wave farm capacity of 3 MW (scenario a)

The voltage decrease during the fault is due to an increasing reactive power absorption just after the fault, as illustrated in Figure 3.26.

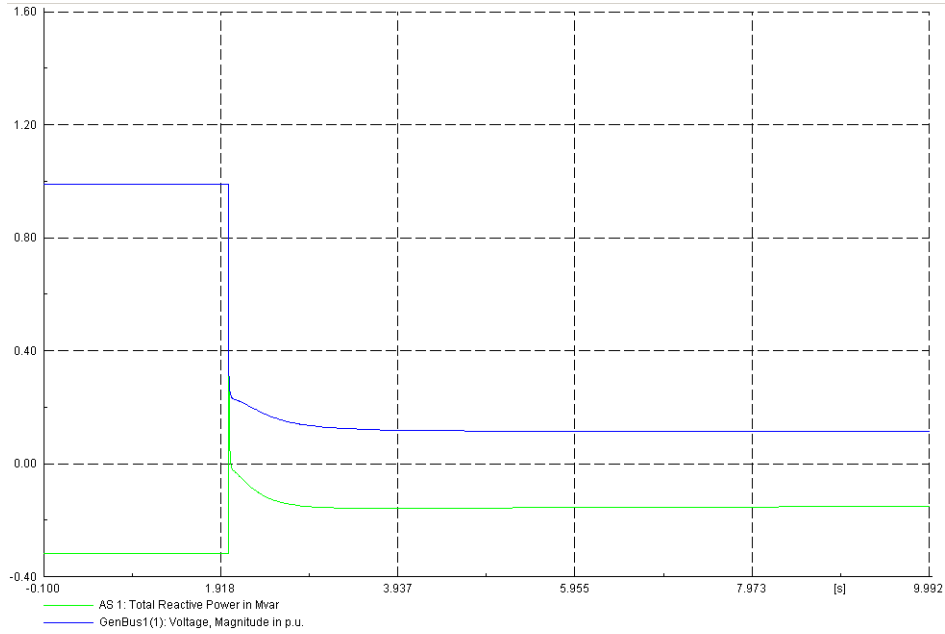

Figure 3.26: Reactive power in MVAR of a single generator and voltage at the PCC in pu

Once the fault is cleared, the voltage at the generator terminals recovers almost instantaneously with respect to the PCC voltage and without oscillations. However a small overshoot is visible for the voltage at the terminal of Generator 1 as depicted in Figure 3.24 and Figure 3.25.

The speed of Generator 1 returns to its steady-state value shortly after the fault clearance: the speed stabilisation time after fault clearance is equal to 600 ms as shown in Figure 3.27. The fault ride-through requirement is validated for this scenario.

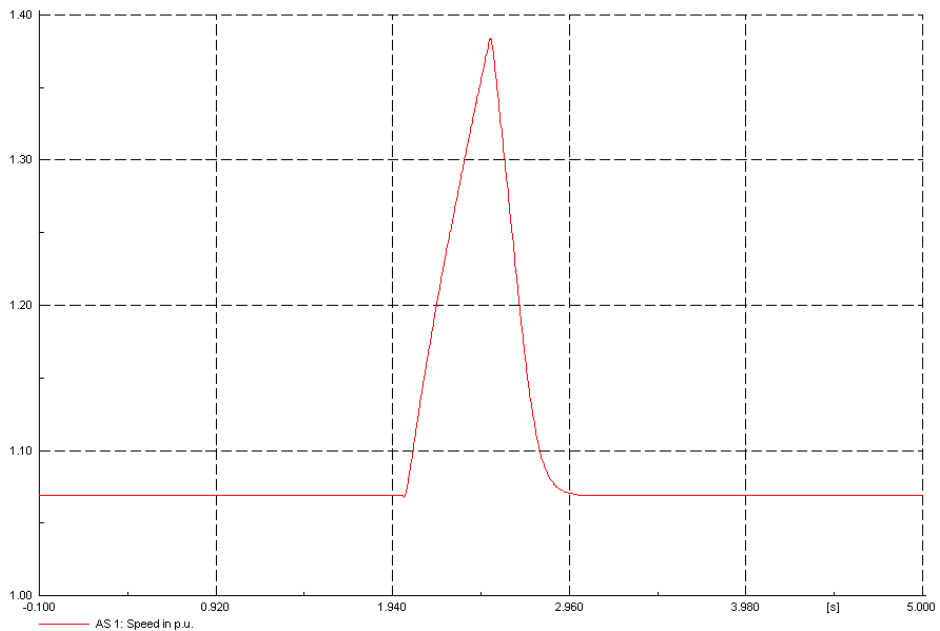

Figure 3.27: Speed in pu of Generator 1

## Scenario b

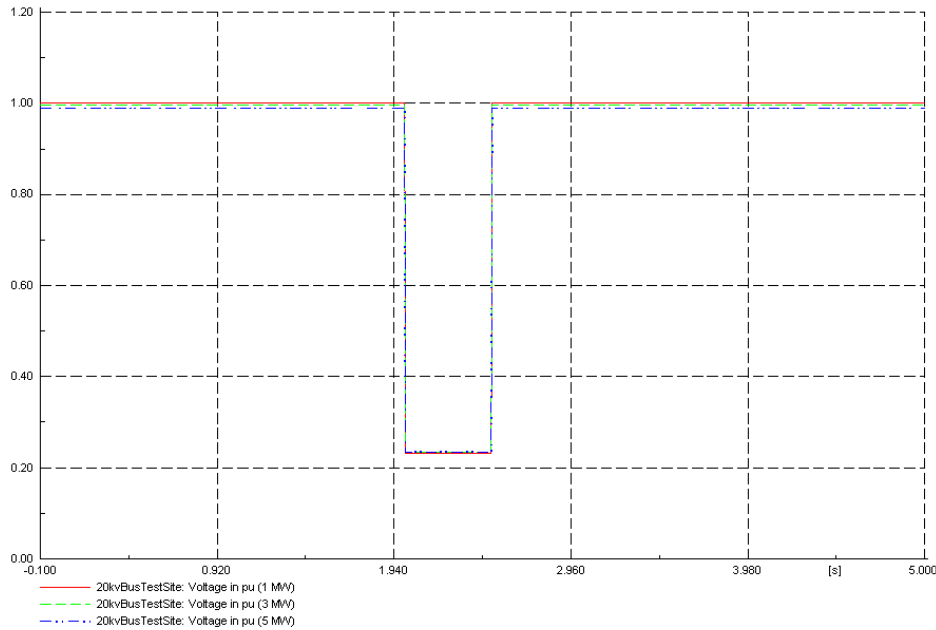

Figure 3.28: Voltage at the PCC for wave farm capacity of 1 MW, 3 MW and 5 MW (Scenario b)

In scenario b, the voltage recovery occurs in a very short time because of the decoupling between the generators and the grid provided by the pulse width modulation (PWM) converter. The fault is assumed to have very little impact on the generators because the short-circuit duration is short with respect to the time constant of the PWM capacitor. It has been assumed here that the generators do not contribute to the fault (assuming an appropriate control of the power electronics) and remain connected throughout the simulation. However, the exact detail of fault ride-through performance is determined by the controls within the power converters, and their ability to operate at reduced voltage levels. It is observed that the increasing wave farm capacity has no effect on the voltage recovery at the PCC.

Scenario b shows that voltage recovery at any buses of the grid is very fast according to the study performed here, even for a maximum power capacity of 5 MW. The squirrel-cage generators pass the fault ride-through requirement regarding speed stability.

The single simulation performed for scenario b illustrates the advantage of using fully-rated power electronics regarding voltage recovery duration after a short fault. It is, as expected, almost instantaneous, due to the assumed full-decoupling between the generators and the grid, thanks to the power electronics converters.

However, the study performed here for the fault ride-through is simple and does not take into account some of the more complex responses of controllers and regulators to a fault situation, as well as the control of DC bus voltage required in full power converters. Moreover, more detailed ocean energy device dynamic models are required, since the device response to the rapid prime mover acceleration that typically occurs during a fault needs to be taken into account.

Current investigations are in progress to explicitly model synchronous generators with PWM converters, including individual models of both rectifier and inverter, as well as a model of the intermediary capacitor. In addition, the modelling of a DFIG generator at a level suitable for short dynamic studies is also still under investigation.

### **3.2.9 Conclusion**

The case study indicated that there are no significant technical barriers to the grid connection of a 5 MW wave farm at the Belmullet ocean test site. This is a positive outcome especially as, apart from the study focusing on the effect of device aggregation, all the other studies were performed with no phase shift applied between the devices' power output, which represents the worst case scenario for power fluctuations.

However, some minor concerns in terms of power quality and voltage variation arise for a wave farm power capacity exceeding 3 MW and with extreme power fluctuations (zero to peak value at each cycle). This situation will occur for the connection of devices with no energy storage capacity and with minimal smoothing from device aggregation.

The system power losses were shown to be larger for a system with fluctuating power output when compared to a non-fluctuating system with the same mean output. This has an impact on component rating and care must be taken in the determination of thermal ratings in the presence of fluctuating power flows.

The local network of Belmullet is currently used to distribute power to a small population from remote power plants. Logically, the integration of a wave farm to this grid radically alters the operating envelope of the local circuit breakers, as shown by the fault study.

Further studies will be performed on the likely phase shift due to device aggregation and on the flicker level in the grid. A wave energy converter numerical model, which will use real wave data as input, is also intended to be built.



### 3.3 TRANSMISSION SYSTEM: OREGON (USA) CASE STUDY<sup>3</sup>

#### 3.3.1 Introduction

The ocean wave energy resources along the coast of Oregon, in the United States, bear tremendous potential for generation of electricity in a clean and environmentally friendly manner. To date, a number of resource assessments, technology evaluation and permitting activities have been conducted with a view to harnessing this untapped energy ([127], [128] [43]). In this regard, a high level electrical system scenario analysis coupled with steady state and dynamic network investigations could determine a practical level of ocean power that can be integrated and the corresponding system constraints considering current and future generation characteristics, local distribution and transmission control areas, cross-border networks, load growth and future network expansion plans. This assessment is structured to achieve this objective and the underlying goals, scope, assumptions and technical approach are highlighted in the proceeding discussion.

#### *Study Objective*

In the context of the state of Oregon (as well as the Pacific Northwest electrical system in the U.S.), the primary objective of this study is to assess the potential for longer-term large-scale wave power generation. In particular, this work aims at:

- Identifying the baseline wave power capacity, i.e., the amount of wave energy that can be added into the electrical system without requiring any significant onshore transmission resource additions.
- Determining the network bottlenecks, i.e., the constraining factors that may pose restrictions on further wave power generation beyond the baseline capacity
- Indicating the suitable points of interconnections (POIs), i.e., the target areas, substations and buses that have significant capacity for wave power addition (from an electrical system point of view)

It is expected that this work will be treated as a catalyst toward instigating necessary discussions within the realms of wave power and electrical networks, but not as a network planning study. Being a high-level analytical study, the underlying assumptions, criteria, scope and approach need also be considered alongside the study findings.

#### *Scope and Assumptions*

Given the current state of the ocean energy industry and associated trends, developments and uncertainties, this study is scoped such that longer-term large-scale wave power scenarios can be analyzed. In particular, multi-megawatt wave power plants and their effects on the transmission system are of highest relevance for this work. Additional assumptions are:

- A 10-year time horizon was accepted as the time frame of interest and it is assumed that the wave energy technologies, in general, will be commercially available during this period. For numerical model development purposes, only one class of generic wave energy converter (WEC) was considered.

---

<sup>3</sup> The case study report is adapted from the report [44] prepared by Powertech Labs.

- It is assumed that the powerflow models are representative of the actual system as identified by its time-tag (year 2019, in this case). This implies that projected load growth, generation growth, demand side management targets and network expansion/reinforcement plans are embedded within the base cases.
- The criteria violations existing in the base cases (without any new modification, i.e., addition of new generation) are assumed to be subject to further scrutiny and mitigation (by means of reinforcement or protection schemes) by the relevant authorities. Once addressed, the electrical network is expected to be more robust (allowing a greater share of wave power additions), which makes the outcome of this study to be of a conservative nature.

Even though the powerflow solutions are obtained by solving the western electrical system as a whole (i.e., no network reduction conducted), relevant parameters are monitored only for the Northwest area and the state of Oregon, in particular.

### ***Methodology***

The integrated scenario analysis being carried out is expected to provide input to a broad range of audiences and may need to be interpreted on a broader holistic scale. Keeping this in mind, two approaches were followed:

**Consultation:** At the onset of the project a scenario team was formed, which consists of representatives from relevant utilities along the coast of Oregon, such as PacifiCorp, Central Lincoln PUD, Tillamook PUD, PNGC Power, Douglas Electric Cooperative and Bonneville Power Administration (BPA). The scenario team facilitated data exchange, aided in defining the study scenarios, and provided necessary oversight toward conducting the study.

**Assessment:** The investigation commenced with sanity checking of powerflow and dynamic data files. Also, a set of suitable POI buses was identified for the addition of wave power plants. Subsequently, transfer scenarios, contingencies and criteria were established. The technical investigation falls within two broad classes:

- Steady-state analysis: This part of the study primarily aims at identifying the effects of wave power addition in the forms of overloading and voltage deviations/collapses that may occur in neighbouring lines and branches.
- Time-domain analysis: The time-domain study focuses on the angular stability and dynamic voltage recovery characteristics under various transfer conditions and contingencies. Development of a dynamic numerical model of ocean wave devices is also a pre-requisite for this analysis.

Powertech Labs Inc.'s commercial power system analysis software, DSATools™ (in particular VSAT and TSAT), was used in conducting this study [42].

### **3.3.2 Base Case Description**

A set of two powerflow base cases (heavy summer and heavy winter) was used throughout this study. In general, North American electricity consumption patterns are exhibited through these dominant peaks, which coincide with seasonal variations. Given that the electrical systems and associated components experience relatively higher stress during these conditions, network models reflective of summer/winter conditions are widely used for system planning studies.

## General Description

The base cases used here are of Western Electricity Coordinating Council (WECC) year 2019 [129] and reflect the projected load, generation and network conditions. The system and load data in these base cases is from the 2009 base case development cycle. In addition, two dynamic data file sets were used for the transient security analysis. Highlights of these cases are given in Table 3.8.

Elements in base case 2019	Summer	Winter
AC Buses	16797	16799
Generators	3470	3481
Loads	8129	7993
Fixed Shunts	726	578
Switchable Shunts	975	975
Lines	14828	14812
Adjustable Transformers	6528	6540
Three Winding Transformers	285	278
AC-DC and DC-AC Converters	8	8
Sectional Branches	272	270

Table 3.8: Summary of summer and winter powerflow base cases (year 2019)

The WECC 2019 heavy summer approved base case (June 10, 2009) and 2018-2019 heavy winter base case (August 7, 2009) consist of 21 areas, 415 zones, and 284 owners. For the purposes of this study where the coastal region in Oregon is of interest, Area # 40 (Northwest) and Zones 401 (Portland), 402 (Western Oregon) and 411 (PacifiCorp) are of highest relevance.

The Northwest area is neighbored by six other areas, which are: BC Hydro, Idaho, Montana, Pacific Gas and Electric, LA Department of Water and Power, and Sierra Pacific Power (Figure 3.29).

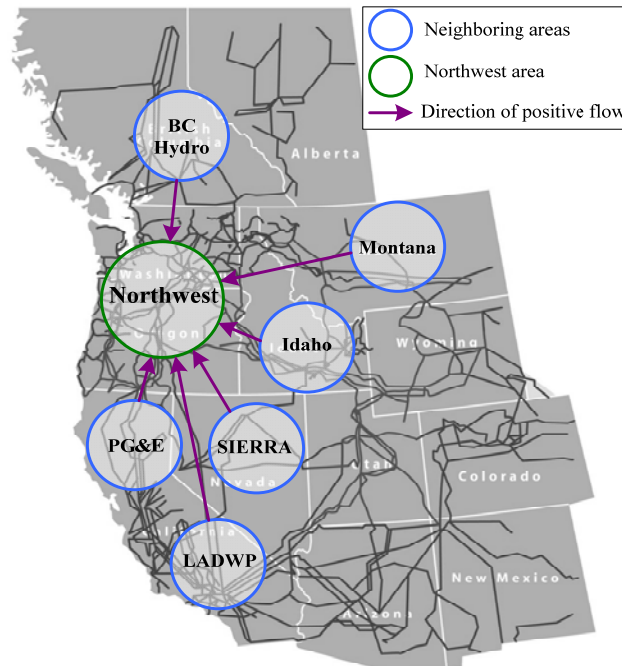

Figure 3.29: Northwest area and the neighbouring authorities

With the exceptions for interchange with BC Hydro and Idaho, the scheduled area interchanges are unidirectional (toward Northwest, except for Montana) for both summer and winter peak conditions. Corresponding flow directions and their magnitudes are listed in Table 3.9.

Control Area	Summer (MW)	Winter (MW)
Net with BC Hydro	-2300.0	1200.0
Net with Idaho Power	601.0	-161.0
Net with Los Angeles D.W.P. (at N.O.B)	2896.0	2522.0
Net with Montana/ Northwestern Energy	-1051.0	-1113.0
Net with Pacific Gas and Electric	4368.0	3599.0
Net with Sierra	210.0	81.0
<b>Total interchange schedule</b>	<b>4724.0</b>	<b>6128.0</b>

Table 3.9: Northwest area interchange summary

Within the Northwest area, the projected loads and resources are summarised in Table 3.10.

Loads and resources	Summer (MW)	Winter (MW)
Loads (100% of summer peak)	28864.4	34651.0
AC Interchange	1822.3	3616.3
DC Interchange	2901.9	2511.6
AC Losses	1366.3	1531.3
DC Losses	100.4	80.6
<b>Total Generation</b>	<b>35055.3</b>	<b>42390.8</b>

Table 3.10: Northwest Balancing Authority area loads and resources

As shown in Table 3.9 and Table 3.8, the WECC base models consist of both AC and DC systems. For the Northwest area, the projected loads for summer and winter peaking periods are around 29 GW and 35 GW, respectively. Corresponding generation capacities within this region are around 35 GW and 43 GW.

### ***Coastal Region***

As reflected by the 2019 base case models, the coastal regions are characterised by little or no generation sources. In other words, there is no expected or planned new generation from the coastal regions within a 10-year time horizon. The existing coastal main transmission network is shown in Figure 3.30.

The load centers along the coast of Oregon are primarily supplied by BPA’s 230 kV and 115 kV transmission network. Starting from the north-south 500 kV BPA backbone, the power flow direction is toward the west. Along the coastline this flow is generally directed to the south (Figure 3.31).

On a broader scale, generating stations in the north and in the northeast areas of the Pacific Northwest supply the major load centers in Oregon, whereas the flow is primarily through the I5 corridor (north-south) and cross-Cascade south interfaces (east-west). It was observed that the projected accumulated coastal load is in the range of 600 MW for the summer peak condition, and 850 MW for the heavy winter case. With the addition of wave power based generating stations along the coastline (target areas are indicated in Figure 3.31), it was anticipated that the general direction of power flow would face a reversal (within the coastal network).



Figure 3.30: Oregon coast and the transmission network (existing)

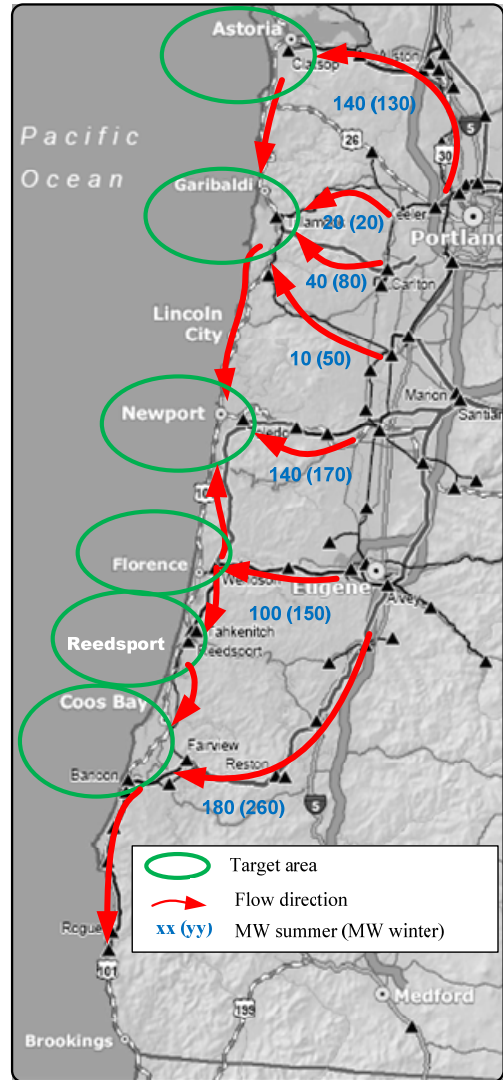

Figure 3.31: Coastal regions and power flow directions (projected, but no wave power generation added)

### Significant Changes

Considering the study focus on the Northwest region, significant additions from 2007 to 2019 period for this area are listed below (including but not limited to):

- Wind plant addition: Saddle Back 70 MW, Hey Canyon 200 MW, Miller Ranch 100 MW
- Thermal plant addition: Cherry Point combined cycle combustion turbine (CCCT) 560 MW
- Transmission line (230 kV): Connection of existing power substations at Walla Walla, Wallula, and McNary; Covington-Berrydale; Sedro Woolley-Horse Ranch #2; IP line converted from 115kV to 230 kV

- Transformer addition (230/115 kV): North King County (Novelty), Pierce County (Alderton), Thurston County (St Clair), Lake Tradition

Additional key changes for the neighbouring Balancing Authorities include:

- Gateway West (Idaho Power and PacifiCorp)
- Hemingway Boardman (Idaho to Northwest)
- Hemingway to Captain Jack (PacifiCorp)
- Montana Alberta Intertie

Further details of the base cases can be found through relevant authorities, such as Western Electricity Coordinating Council (WECC) [129] and Bonneville Power Administration [45].

### 3.3.3 Dynamic Modelling of Wave Energy Converter

There exists a wide diversity of wave energy conversion (WEC) systems at various levels of technological maturity. Availability of public domain information is scarce, and the industry has not matured enough such that model validation activities can be initiated [130]. On the other hand, planning studies that focus on short-circuit/fault analysis and transient stability aspects of such systems' integration into the electrical networks require these models to be responsive to certain features, which includes: (a) capability for fast simulation; (b) representation of electromechanical transients; and (c) similarity to traditional paradigms of modelling [13], [43].

The short-circuit/fault analysis based on the generator models calculates system fault currents with the added new generation, checks interrupting ratings of the existing fault interrupting devices, and is used to develop protective device settings of any new protective relays that would be required for interconnection and integration of the new generation.

A look at the underlying conversion principles indicates that wave induced motion at the front-end of various ocean wave devices can be manifested through one or multiple degrees of movement, such as, pitch, heave, sway, etc. ([130], [131], [3]). Another unique aspect of most ocean wave devices is that there exists an intermediate conversion stage, which primarily operates as a buffer for energy storage and translator for oscillatory-to-rotary motion.

For the purposes of simplicity and generality, the assumptions made throughout the model development activities are:

- Wave resource variation is considered to be reflective of fully developed, deep water conditions.
- The wave energy device is modelled only to reflect the real power contributions, whereas the end-block (containing the electrical machines/power electronics) will accommodate the reactive power aspects.
- The intermediate stage is considered to be a hydraulic system (reciprocating system accumulating pressurised fluids, which can be regulated to drive a hydraulic motor coupled to an electrical generator).
- Multiple wave energy devices are assumed to be arranged optimally, such that their cumulative spatial formation contributes toward smoothing out the overall output.

A high-level outline of the WEC system is given in Figure 3.32. The model takes significant wave height and wave power period as input variables and produces mechanical power output, which drives the grid-interface/end-blocks.

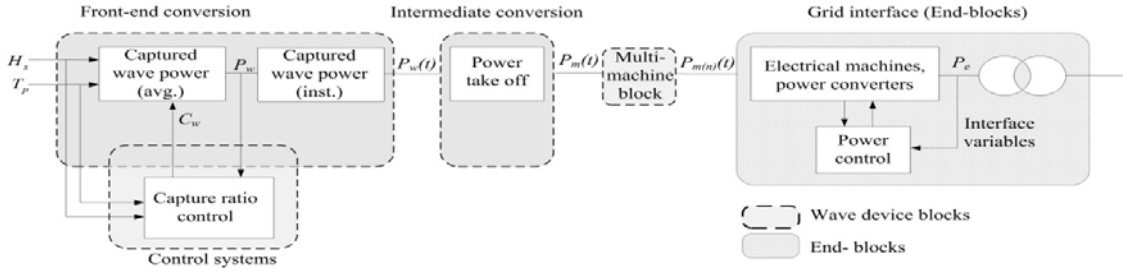

Figure 3.32: Outline of ocean wave energy converter model

These end-blocks are essentially electrical generator/power electronics models. such as induction generators, doubly-fed induction machines or full-converter interfaces. Further description of the model elements are given below.

It has been found [44] that this high-level model, albeit simplistic in nature, is sufficiently detailed and numerically robust to rely upon. However, there exists the need for further model refinement and validation, as well as development of models for other types of WEC, such as point absorber, oscillating water column or overtopping devices.

### Model Description

Under steady-state conditions, the power output of a device can be considered to be identical to the name-plate specifications. Typically, this information is provided in the form of a ‘power matrix’, which essentially maps the electrical power output as a function of significant wave height and wave period. The power matrix information in this regard is given as a function (look-up table) of significant wave height and wave period as:

$$P_m = f_{HT}(H_s, T_p) \quad \text{Eq. 11}$$

For irregular waves, the power (kilowatt per unit of wave crest) captured by the front-end wave power device is given by:

$$P_w = 0.5H_s^2 T_p L_w C_w \quad (\text{kW}) \quad \text{Eq. 12}$$

Here,  $T_p$  is the wave period in seconds, where wave frequency  $\omega_w$ (rad/s) is given by  $\omega_w = 2\pi f_w$  and  $f_w$ (Hz) can be found using  $f_w = 1/T_p$ . In addition,  $L_w$  and  $C_w$  correspond to physical dimension/length of the wave power device and capture width ratio, respectively.

Here the non-dimensional capture width ratio  $C_w$  stands as a measure of the wave energy device’s conversion efficiency. This quantity is in effect the ratio of effective wave field to the physical length of the converter. When the capture width ratio is multiplied with device length and is implemented in the power equation stated above, overall power output in kilowatts is realised.

The capture width ratio, in general, can be given as a function of wave frequency  $\omega_n$  and effective damping [132].

$$C_w = f_{cw}(\omega_n, R) \quad \text{Eq. 13}$$

A critical element that ensures satisfactory operation of the wave energy converter is the power control (such as, frequency tuning, latching control, etc.) [132]. Depending on the sea-state and internal operational conditions, the control scheme adjusts one or more control variables, such as damping, stiffness or effective mass. This, in other words, determines the effective dimension of the wave device (capture width) that is being utilised for energy harvesting.

For a simplistic/high-level analysis, the control block can be assumed to be capable of adjusting these parameters and the equivalent effect is reflected on the magnitude of the capture width ratio  $C_w$ . Considering the control reference is identical to the power matrix information (i.e, the device rating) as given by  $P_m^* = f_{HT}(H_s, T_p)$ , a PI type controller can be utilised in order to regulate the effective capture width ratio  $C_w$ .

$$G_{con}(s) = \frac{K_p s + K_i}{s} \quad \text{Eq. 14}$$

Here,  $K_p$  and  $K_i$  denote the proportional and integral constant within the PI controller. The actuating system that enforces the necessary changes in the damping resistance can be given as a first-order transfer function such as:

$$G_{act}(s) = \frac{1}{\tau_{act} s + 1} \quad \text{Eq. 15}$$

Here the associated time constant is given by  $\tau_{act}$ . The output of this controller, i.e., the effective damping, needs to be bound by an upper and lower limit ( $R_{up}, R_{lw}$ ).

Unlike the quasi-static model, the hydraulic power take-off within a full-order dynamic model can be represented as a function of this stage's efficiency  $\eta_s$ , fluid-transfer delay  $T_d$ , and time-constant  $T_s$  using the transfer function below:

$$P_m(s) = \frac{\eta_s}{T_s s + 1} e^{-T_d s} P_h(s) \quad \text{Eq. 16}$$

For multiple units placed in a lumped manner (several point absorber systems in an array, such as with the OPT<sup>TM</sup> devices or several machines within one wave device, such as in Pelamis<sup>TM</sup>), the cumulative mechanical power input to an equivalent electrical machine can be given as the algebraic summation of each individual machine.

$$P_m = \sum_{n=1}^N P_m^{(n)}, n = 1, 2, 3 \dots N \quad \text{Eq. 17}$$

However, since an optimum spacing is expected between the conversion units, their extracted power is also expected to contain a phase difference as shown in the expressions below. In order to introduce the time delay corresponding to the phase delay, the time domain notations are used.



$$P_m^{(n)} = P_m(t - T_\phi^{(n)}) \quad \text{Eq. 18}$$

Here the magnitude of time delay is found by using the total number of devices  $N$  and wave period  $T_p$  in the expression below:

$$T_\phi^{(n)} = T_p \frac{n-1}{N} \quad \text{Eq. 19}$$

In general, it is expected that the cumulative contribution of a number of optimally spaced wave energy devices (within an array) will result in time-averaged smoother electrical power output.

For the end-block/grid-interface, a standard squirrel cage induction generator model was used.

### ***Parameters***

Considering the availability of public domain information, in this exercise, a hinged contour device [11] type was chosen for modelling and simulation purposes. This device essentially maneuvers using multiple degrees of movements (heave and sway) and contains three identical power conversion units.

Multiple hydraulic rams capture these movements and direct pressurised hydraulic fluids into an accumulator. The control manifold releases this fluid into hydraulic motors that are coupled to induction generators. It has a physical length of 150 m and power rating around 750 kW. The power conversion modules are connected to a step-up transformer, which connects to a collection network for power delivery to the shore. The power matrix of this device is shown in Figure 3.33.

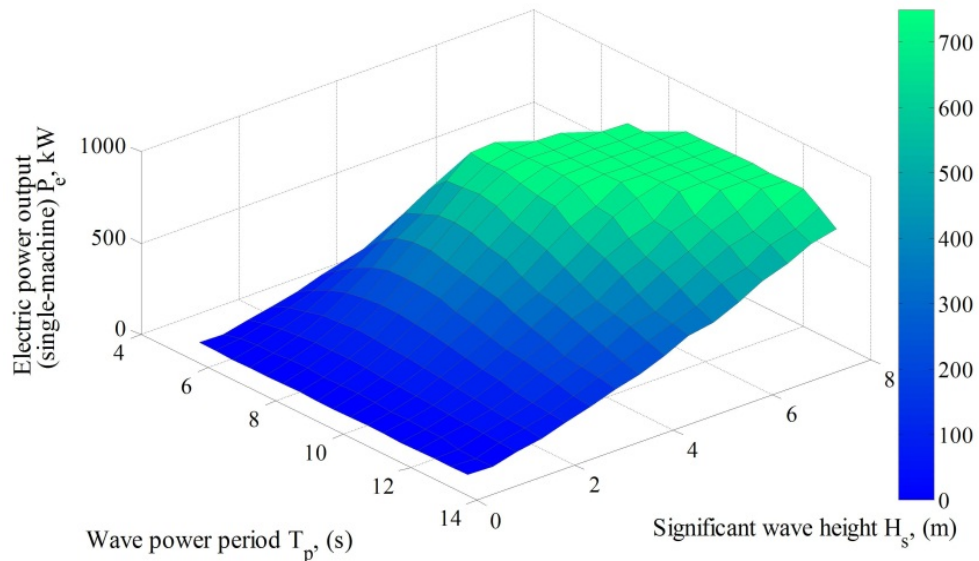

Figure 3.33 Example power matrix of a hinged contour device

Parameter	Symbol	Value
Effective device length	$L_w$	150 m
Proportional constant	$K_p$	0.1
Integral constant	$K_i$	0.001
Actuator time constant	$\tau_{act}$	5 s
Lower ceiling of effective damping resistance	$C_{wup}$	0.15
Lower ceiling of effective damping resistance	$C_{w/w}$	0.001
Intermediate stage fluid-transfer delay	$T_s$	10 s
Intermediate stage time-constant	$T_d$	7.25 s

Table 3.11: WEC parameter list

The induction machine parameters are: inertia constant  $H = 4.76$  s, magnetising reactance  $X_m = 5.89$  pu, stator resistance  $R_s = 0.0046$  pu, stator reactance  $X_s = 0.0589$  pu, rotor resistance  $R_r = 0.0039$  pu, rotor reactance  $X_r = 0.1453$  pu, with base frequency 60 Hz, base power 100 MVA (plant with 120 individual machines), and base voltage 0.6 kV. The WEC model is initialised at  $T_p = 9$  s using the WEC power matrix.

### 3.3.4 Scenario Setup

Prior to embarking upon the analysis, a set of sanity checking and case preparation activities were undertaken. This included POI identification, transfer scenario setup, contingency definition, criteria evaluation and monitor variable/parameter selection. The term ‘scenario’ is indicative of any combination of these POIs, transfers, contingencies and powerflow base cases studied under steady state (power flow, voltage stability) or time domain (angular stability) methods.

#### *Points of Interconnection (POI)*

The process of POI identification reflects the collective views of the project and scenario team, contemporary wave power projects being proposed (such as [127], [128]), as well as characteristics of the electrical network (expected weak/strong points). In many cases, POIs that provide distribution voltage levels closer to the shoreline are owned by the host utilities; whereas higher capacity connection points providing transmission voltage levels are generally further inland and owned by BPA.

POIs with voltage transformation are modelled with the summer and winter thermal ratings of the existing transformers. This study is based on existing facilities and does not include upgrades of transformers or addition of new transformers to increase ocean energy transfer capacity.

Subsequently, a set of six geographical target areas (consisting of 12 points of interconnection) was analyzed. These are shown in Figure 3.31.

#### *Transfers*

At any given instance, the total power generation must equal the total consumption (load and losses). In order to add new generation in certain locations, it is therefore necessary to

decrease the power production in other locations (or to increase the loads) in order to maintain the power balance.

In this study (with load levels pre-determined in the base cases), the transfers are established such that gradual increase in ocean power generation along the coastal POIs is balanced against similar decrease in conventional generation in a set of remotely located plants.

These plants are selected based on various criteria, such as plant location (relative to the intended transfer directions) and provisions for eliminating greenhouse emissions. Also, it is customary to select larger power plants for ease of defining the transfers.

Based on this selection, a set of coal and natural gas-based power plants have been chosen (Table 3.12, Figure 3.34). Typically, the coal-fired plants are expensive to operate, emit greenhouse gases, and are older in operational age. Therefore, these units are selected as priority units to be scheduled as shown in Table 3.12.

Transfer type	Plant (unit) for gen. reduction	Fuel type	Order	MW capacity
<b>East-West (EW) transfer</b>	Boardman	Coal	1	620
	Coyote Springs (S2, G2, S1, G1)	Natural gas	2, 3, 4, 5	80, 170, 80, 170
	Hermiston Power Project (S1, G1, G2)	Natural gas	6, 7, 8	190, 220, 220
	Hermiston Generating Project (1S, 2G, 2S)	Natural gas	9, 10, 11	180, 85, 180, 85
<b>North-South (NS) transfer</b>	Centralia (G1, G2)	Coal	1, 2	760, 760
	Chehalis (S1, G1, G2)	Natural gas	3, 4, 5	240, 200, 200
	Grays Harbor (S1, G1, G2)	Natural gas	6, 7, 8	315, 190, 190
<b>Combined North and East (CNE)</b>	Boardman	Coal	1	620
	Centralia (G1, G2)	Coal	2, 3	760, 760

Table 3.12: Transfer description and sink system plants (units)

The East-West (EW) transfer essentially represents flow along the West of Slatt flow gate, whereas the North-South (NS) transfer represents that of the South of Allston interface. The Combined North and East (CNE) interface consists of large coal-powered units belonging to both north and eastern locations. Under all transfer scenarios, the increase of power generation is introduced through the coastal ocean power plants.

The selected units under each transfer are dispatched using a pre-defined order (as against sharing the generation reduction amongst the units equally) as indicated in Table 3.12. An initial estimate indicated that the total wave power generation would be around 2000 MW and these units are selected such that this bulk power can be adequately consumed by the overall system.

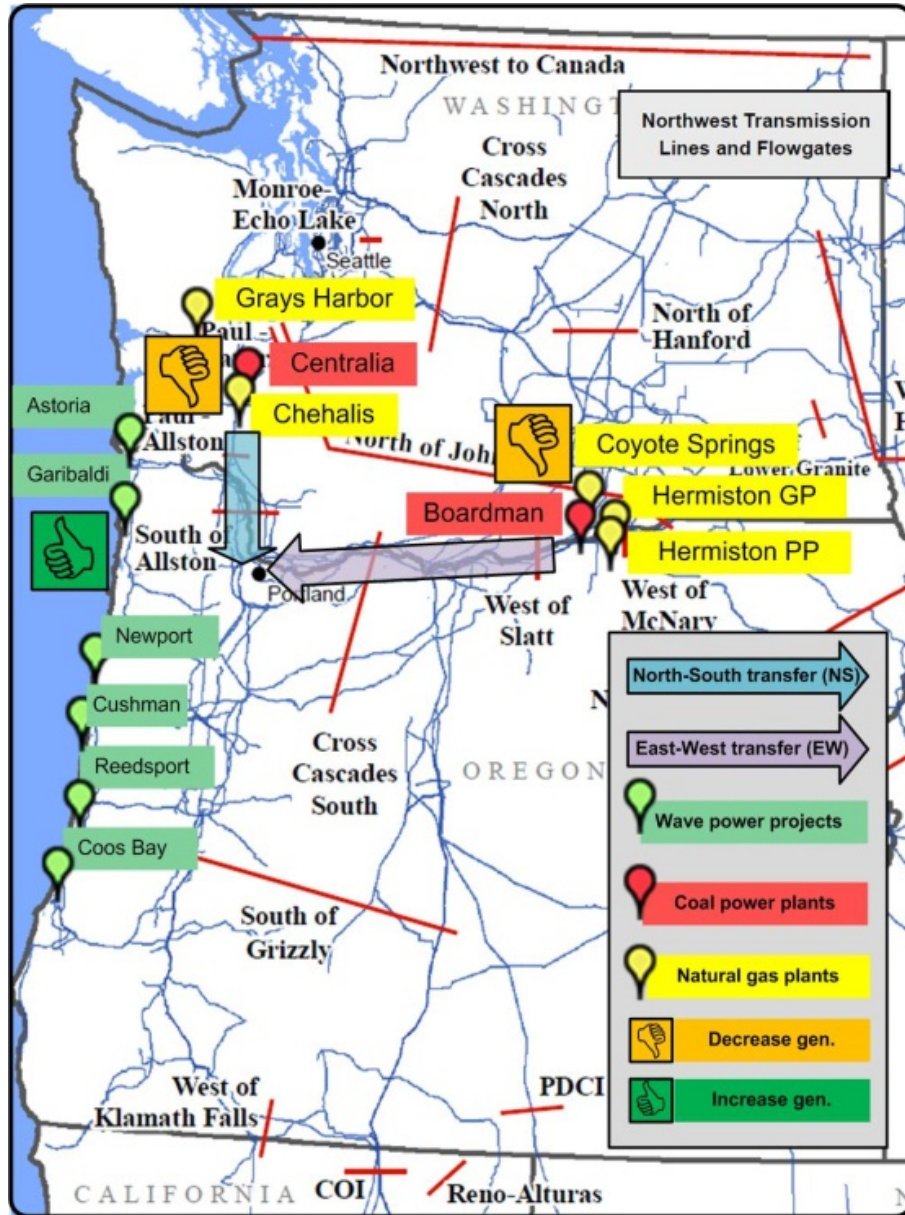

Figure 3.34: Transfers and points of interconnection

It should be pointed out that setting up various transfer scenarios is rather a requirement for conducting the study and not a pre-condition for wave power generation. This method allows a means for absorbing the power generated from wave plants in a systematic manner. In practice, various other factors (such as, cost, scheduling, ancillary services, etc.) will determine which units are to be adjusted (if any) in case of newer wave power addition. Also, the directions of power transfer are not expected to reverse and may only show reduction in power flow magnitude as a result of addition of newer wave power plants along the coast.

### ***Applied Contingencies***

In this study, in addition to the transfer scenarios discussed above, a set of contingencies (single element outages, i.e, N-1 contingencies) are used. From the POI buses, N-1 contingencies are considered up to five tiers (i.e., five buses away from the POIs, total 132

branch outage and 57 generator tripping contingencies) of the system. The contingencies include three-phase faults at buses cleared by single circuit tripping, and single generator tripping without fault.

The contingencies were applied for lines rated at 69 kV and above, and for generators of 50 MVA and above.

Voltage (kV L-L rms)	Interrupting Time (Cycles)
Below 100 kV	14
100 kV to 138 kV	9
161 kV to 230 kV	7
345 kV and up	4

Table 3.13: Typical relay and circuit breaker interrupting times

In the transient security analysis, fault clearing time for the line outage contingencies are specified using the information in Table 3.13, as found in BPA’s guideline on Technical Requirements for Interconnection [45].

### **Criteria**

Under the transfer scenarios and contingencies described earlier, the performance of the network elements need to be analyzed against a set of criteria. The criteria applied on steady-state (using VSAT) and time-domain (using TSAT) analysis is as follows:

- Steady-state/voltage security analysis criteria:
  - Voltage deviation (Decline or Rise): For single contingency, not to exceed 7% at any bus
  - Branch overload: For heavy summer case, 100% continuous rating for pre-contingency and 100% emergency rating for post-contingency conditions. For heavy winter case, similar ratings are used, except that different rate tables are used.

The branch overloading criteria are given higher priority than the voltage deviations, especially if the latter violation takes place at 69 kV and 115 kV buses. However, sufficient attention is paid toward evaluating the cause, effect and extent of such voltage deviations.

- Time-domain/transient security analysis:
  - Transient stability: System remains stable for all the specified contingencies
  - Transient voltage dip: For single contingencies, not to exceed 20% for more than 20 cycles at load buses

These criteria are in line with standard practices as specified by authorities such as WECC, BPA and others.

### **Monitors**

For all the scenarios and contingencies analyzed in this study, all the branches and units included in the nearby system to the POIs (Zones 401-Portland, 402-Western Oregon and 411-PacifiCorp) are monitored in order to identify any violation of the aforementioned criteria.

## Methodology

In order to achieve the study objectives outlined earlier, the following approach was taken:

- Step 1: Point of interconnection (POI) evaluation: Identify individual POI capacities through steady-state analysis (in VSAT platform) under N-1 contingencies, defined criteria (voltage rise/decline and branch overload), and one transfer scenario (East – West transfer, Table 3.12).
- Step 2: Aggregated capacity evaluation (preliminary): Identify aggregated coastal generation capacity from all POIs through steady-state analysis (in VSAT platform), using the limits found in step #1 under N-1 contingencies, defined criteria (voltage rise/decline and branch overload), and all transfers (EW, NS and CNE transfer).
- Step 3: Aggregated capacity evaluation (final): Further evaluate the aggregated coastal generation capacity from all POIs through dynamic analysis (in TSAT platform), using the limits found in Step #2 under N-1 contingencies, defined criteria (transient stability and voltage dip), and one transfer (EW transfer). This step incorporates the dynamic model of ocean wave energy converter (WEC).

As part of powerflow base case analysis and sanity checking (data quality, convergence, etc.), the above set of criteria was used to identify the inherent violations existing in the 2019 heavy summer and winter files. These violations are independent of issues related to ocean power integration. From a system reliability perspective, it is expected that these violations will be addressed by other means of reinforcement, reactive compensation and/or protection schemes. This implies that the 2019 electrical network will be more robust than the base cases being studied, allowing more wave power resources to be added into the system. In other words, the results of this assessment, albeit realistic, will be of a conservative nature.

### 3.3.5 Steady-State/Voltage-Security Analysis

The voltage security assessment is conducted in multiple steps under a number of scenarios (using various transfer conditions and individual/aggregated POIs).

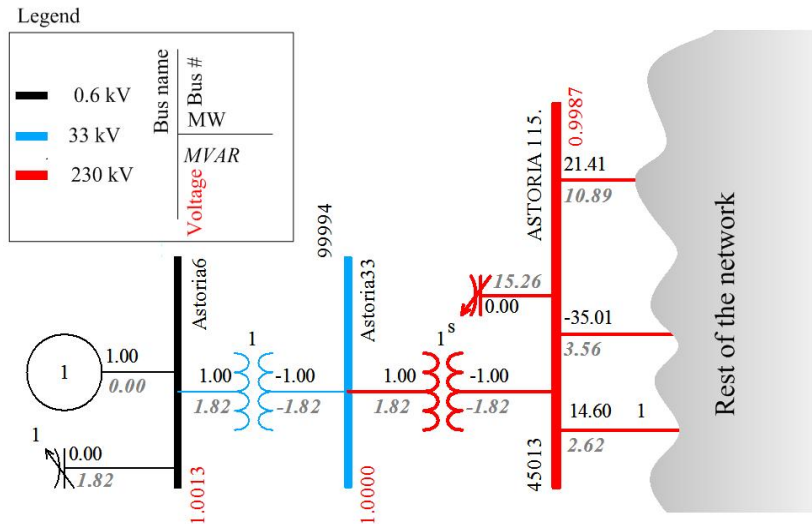

Figure 3.35: WEC implementation in powerflow base cases

At first, the powerflow base cases are modified to accommodate wave power generators. A total of 12 POIs (10 originally suggested and two considered as an outcome of preliminary analysis) have been implemented. Each WEC device is modelled as a combination of a generator (with  $Q_{max} = 0$  MVAR,  $Q_{min} = -60\%$  of MVA rating) and a shunt capacitor (with continuous control capability up to 60% of generator's MVA rating).

The WEC output is at 0.6 kV, and is connected to the transmission bus using a 33 kV collector bus (Figure 3.35). As a subsequent step, the transfer definitions are implemented in the VSAT platform. Also, the contingencies, criteria and monitor parameters are defined in accordance with the aforementioned setup.

### ***POI evaluation***

For the purposes of identifying the favorability and capacity of various POIs, at first the west to east (WE) transfer (Table 3.12) is considered. It should be mentioned that as long as the investigation is focused on the POIs themselves, the transfer option is immaterial. Maximum generation capacity for the WEC generators is set preliminarily around 300 MVA (exceptions: 500 MVA for Toledo and Tahkenitch, 700 MVA for Wendson POI). During the transfer analysis, this generation is increased with steps of 20 MW and corresponding impacts on the neighboring system are analyzed (with and without contingencies).

It has been established that even though line overloading and bus voltage violations were taken as limiting criteria, only overload conditions were reported in most cases.

Also, in spite of having higher level coastal load in the heavy winter case (Figure 3.31), the heavy summer case appeared to be more constraining. Primarily this is due to the fact that power flow directions are different and are more limiting to addition of new generation, due to the fact that summer ratings are lower than the winter ratings (owing to higher ambient temperature).

POIs such as Astoria (PAC), Clatsop (BPA), and Garibaldi (TPUD) have capacities in the range of 5 to 10 MW. These areas have been reviewed in detail, and the corresponding limits and observations are given in Table 3.14. A number of POIs such as Toledo (BPA), Tahkenitch (BPA) and Wendson (BPA) have significant capacities ranging from 300 MW to 500 MW. Other POIs such as Tillamook (BPA), Reedsport (BPA) and Houser (BPA) have limits around 120 MW to 180 MW. For the remaining POIs (Newport, Gardiner, Bandon), the capacity limits are between 40 MW and 80 MW.

Area name	Substation (Owner)	kV level	MW capacity
<b>Astoria</b>	Clatsop (BPA)	230	5
	Astoria (PAC)	115	10
<b>Tillamook</b>	Tillamook (BPA)	230	140
	Garibaldi (TPUD)	115	10
<b>Newport</b>	Toledo (BPA)	230	400
	Newport (CLPUD)	69	60
<b>Reedsport</b>	Reedsport (BPA)	115	180
	Gardiner (BPA)	115	80
	Tahkenitch (BPA)	230	320
<b>Coos Bay</b>	Hauser (BPA)	115	120
	Bandon (BPA)	115	40
<b>Cushman</b>	Wendson (BPA)	230	480

Table 3.14: POI capacities for added new wave power

### ***Aggregated Capacity Evaluation (Preliminary)***

A direct summation of wave power generation capacities (for each of the POIs, as identified in the previous step) does not necessarily determine the aggregated capacity from the coastal region, as a whole. This arises from the fact that with the addition of multiple plants throughout the coast, the power flow direction and magnitude are altered in unique ways. This relaxes or tightens the associated constraints on the network elements. Therefore a separate step needs to be undertaken where aggregated capacity limit can be evaluated (to be further scrutinised under a dynamic study platform).

Under this step, the maximum capacity of ocean power plants at each of the POIs is set according to their respective limits as identified in the previous step (POI evaluation). The transfer scenario is defined such that generation increase along the coastal POIs is incremented with steps of 20 MW, each POI reflecting a fraction of this generation based on its maximum allowed capacity. Also, generation decrease is scheduled for all three transfer scenarios (EW, NS, and CNE transfer, separately).

An inspection of the results indicated that the first bottleneck in the heavy summer case is exhibited in the form of line overloading of Glasgow 115 to Hauser 115 line under the contingency: Outage Branch = Alvey 500 Dixonvle 500. Corresponding maximum wave power generation capacity is 430 MW.

Under the pre-contingency condition, the same element is affected/overloaded. However, the maximum transfer limit is 200 MW higher. Similar observations can be made for the heavy winter case. It was also observed that the transfer scenarios do not affect the underlying findings and the bottlenecks are primarily localised within the coastal region (between Sumner C115 and Hauser 115).

### **3.3.6 Time Domain/Transient Security Analysis**

The transient security analysis was performed using the time-domain analysis tool TSAT with a view to gaining further insight into the capacity limits determined through steady-state analysis (in VSAT platform).

#### ***Case Preparation***

First, the bases cases were analyzed with an intention to identify existing transient security problems (irrespective of addition of newer/wave power plants) in the neighbourhood of the selected POIs. Subsequently, newer cases were set up accommodating the maximum transfer capacity identified in the steady-state study (430 MW considering wave generation at all POIs simultaneously).

This scenario analysis was performed with a view to identifying any new potential contingency that could cause transient security criteria violation (as a result of addition of the wave power plants). Dynamic models of the WEC devices were considered in this step. The selected transfer for the transient stability study is the NE transfer (considering only coal-fired plants).



### Aggregated Capacity Evaluation (Final)

Based on the results from TSAT, it was concluded that the heavy summer case did not exhibit any criteria violation with the addition of wave power plants along the coastal POIs (maximum aggregated capacity 430 MW). On the other hand, the winter case indicated only one contingency that caused a voltage criteria violation. Also, it was observed that this voltage criteria violation could be solved by adding additional shunt compensation at the critical buses.

This contingency is further analyzed in the following discussions and reflects observations only in the winter case, considering a maximum generation capacity of 430 MW from ocean power plants.

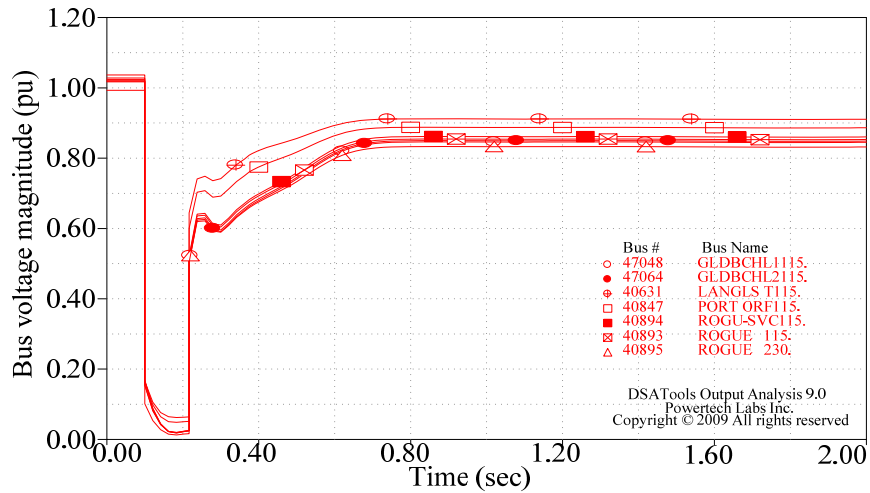

Figure 3.36: Bus voltage criteria violations observed at selected buses

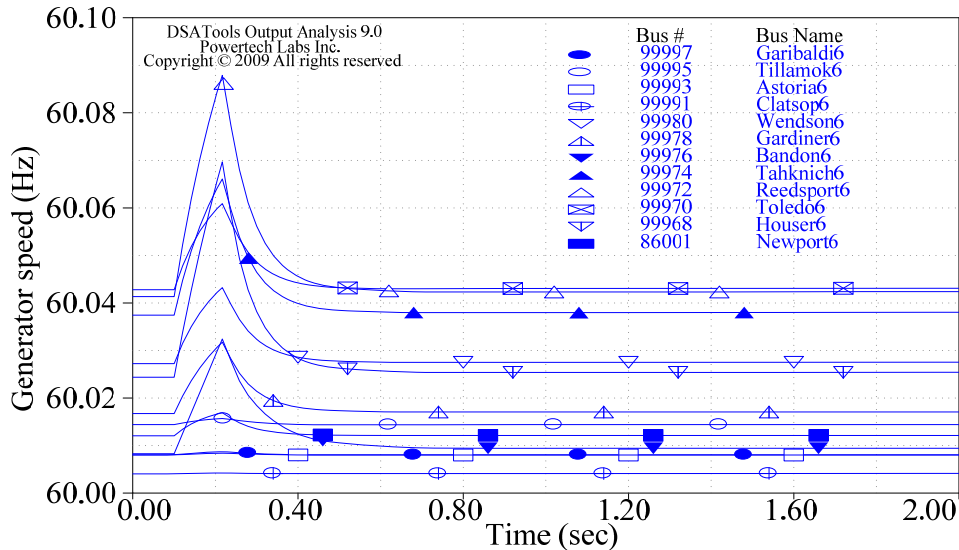

Figure 3.37: Ocean wave generator speed observed at all POIs

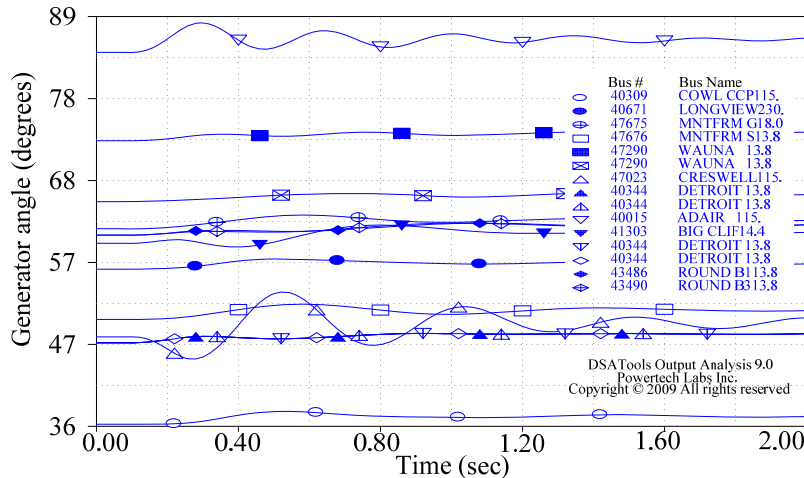

Figure 3.38: Generator relative rotor angles for units located near the wave power plants

Figure 3.37 shows the bus voltage criteria violation for the contingency: 3PHBF FAIRVIEW230 - ROGUE230 and the weakest voltage recovery is characterised by a rise up to 0.8 pu in 23 cycles (considered criteria=20 cycles). Also, the post-contingency steady-state voltage magnitudes are below 0.9 pu for the selected buses as shown in this figure. Additional shunt compensation on one or some of these critical buses can be an option to solve these voltage violations. With regard to the implementation of WEC device models, a set of generator speed curves are presented in Figure 3.37, which indicates successful model performance (~60 Hz rotor speed).

Figure 3.38 shows the generator relative rotor angles for a set of units located in the neighbourhood of the wave power units under the contingency 3PHBF FAIRVIEW230 - ROGUE230 and 3PHBF SANTIAM 230, which also indicates good transient stability characteristics. Considering these results, it can be concluded that from a transient security perspective, the addition of 430 MW wave power (as established in the steady-state study) is within the prescribed criteria.

According to this grid scenario analysis, the following results can be deduced:

#### *Baseline wave power capacity*

Considering simultaneous wave energy power generation from selected target areas along the coast of Oregon, the aggregated capacity transfer limit from west to east is found to be approximately 430 MW. This threshold of capacity addition is a conservative estimate. Further evaluation (refined/relaxed criteria and contingencies), wave resource specific POI selection (as against considering all the POIs simultaneously), and addressing the inherent network bottlenecks (as embedded within the 2019 network models) would undoubtedly indicate higher capacity for wave energy resource additions.

#### *Network bottlenecks*

Under the scope of this study, with its underlying assumptions and criteria, the primary limiting factor is line overloading. In order to address these limits, several transmission lines and/or transformers near several POIs may need reinforcement/addition. Also, the addition of reactive compensation may be deemed necessary at several substations in order to address possible voltage rise/decline issues. Such requirements would be identified

during the interconnection study and/or transmission service study process associated with a specific wave resource addition.

It is noteworthy that issues of line overloading were experienced in the base case analysis prior to the addition of any wave energy resources. These results indicate that localised system upgrades will be needed to address already anticipated changes in load and resources. Although it was not assumed in the studies, local transmission owners and distribution utilities will make system upgrades necessary to address these issues. Those changes may help to remove some of the limiting factors identified in this study and thereby increase the individual POI and simultaneous capacity transfer limits.

#### *Evaluation of points of interconnections (POIs)*

A set of twelve POIs were evaluated and the capacity levels shown in Table 3. 14 are representative of each of the POIs when considered separately. (Note: The resulting simultaneous capacity transfer limit is discussed under the 'Baseline Wave Power Capacity' heading.)

### **3.3.7 Conclusion**

The preceding analysis estimates the amount of wave power that can be interconnected to the electrical system at specific points without requiring any significant transmission infrastructure additions. Though local reactive compensation resource additions would likely be needed and are not trivial in cost, they do not rise to the level of transmission line additions in either scope or cost. The study also estimates the transfer capability of the electric system eastward from the coastal areas. However, depending on the amount of wave power being injected into the system at any given location, local system upgrades would be likely and interconnection facilities would be required to integrate the project. This baseline capacity limit accounts for the effects on the electrical network as a result of wave power generation at multiple locations throughout the Oregon coastline.

Major constraining factors that may pose restrictions on further wave power addition beyond this baseline capacity are also investigated. As a precursor to this step, a number of target areas and points of interconnection are analyzed toward determining their respective capacity limits and constraining factors.

### 3.4 TRANSMISSION SYSTEM: THE REPUBLIC OF KOREA CASE STUDY<sup>4</sup>

#### 3.4.1 Introduction

Considering the significant tidal current and wave energy resource potential in the Republic of Korea, a network impact assessment [133] was carried out as part of an Asia Pacific Partnership (APP) project [134], funded by Environment Canada. The main objective of this assessment is to demonstrate systematic consideration of emerging tidal current and wave energy resources within the future Korean electrical network. A map of the studied system in 2009 and the target areas for integrating tidal current and wave power are presented in Figure 3.39.

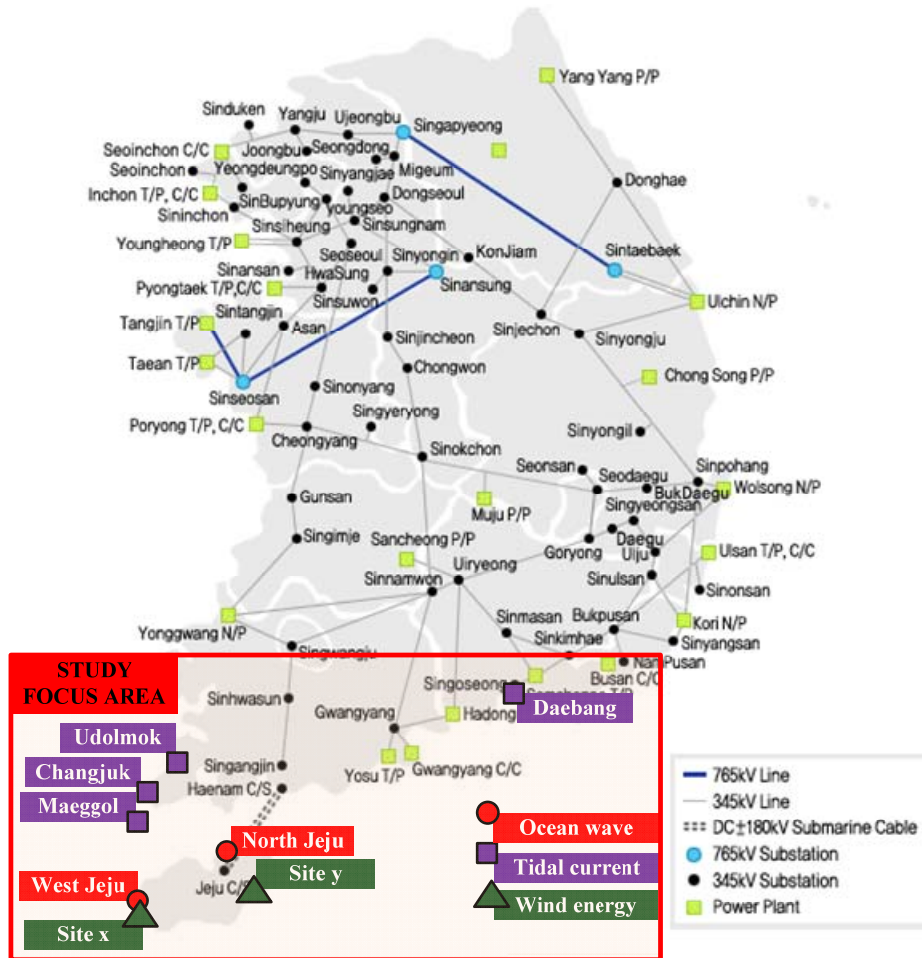

Figure 3.39: A map of the power grid of the Republic of Korea in 2009

<sup>4</sup> The case study report is adapted from the report [134], prepared by Powertech Labs for Environment Canada.

### Scope and assumption

Voltage security, transient security and small signal stability analyses on the Korean interconnected network for years 2017 and 2022, under both peak and light loading conditions are carried out. For the analyses, it is assumed that, before 2017, Jeju Island will be connected to the Korean Mainland through two high voltage direct current (HVDC) submarine transmission links, totalling a maximum capacity of 700 MW in either direction. Two locations of ocean wave energy generation off the Island and four locations of tidal current flow generation off the Mainland are considered. The maximum new generation injections in the Island and the Mainland are 1000 MW and 620 MW, respectively, to be dispatched against forecasted load increases in certain areas of the Mainland.

### Methodology

In this study, steady-state, eigenvalue and time domain analyses are performed. The model includes the whole Korean power system, where Jeju Island is interconnected with the Mainland through two conventional HVDC bipolar links.

The study is based on computer simulations using the following programs of Powertech Labs Inc. (PLI)'s DSATools™ software [42]: PSAT, VSAT, SSAT, TSAT.

### 3.4.2 Base Case Descriptions

The power flows of the Island and Mainland for 2017 and 2022, under light and peak loading conditions, were supplied to PLI separately. PLI combined the Island and Mainland models and created four interconnected base power flows as summarised in Table 3.15.

Power Flow Base Case	Jeju Island				Mainland			
	Generation		Load		Generation		Load	
	MW	MVAR	MW	MVAR	MW	MVAR	MW	MVAR
2017 Light	350	-50	506	174	47266	11156	46433	10402
2017 Peak	433	28	826	280	78962	16885	77337	33003
2022 Light	410	-116	566	194	48709	11149	47867	10816
2022 Peak	535	7	926	313	81311	16667	79636	34032

Table 3.15: Power flow summaries of the combined base cases

### 3.4.3 Dynamic Modelling of Tidal Current Energy Converter

Even with significant conceptual and structural similarity between wind turbines and tidal current devices, there exist a number of subtle differences between these two areas. For instance, unlike wind energy, the use of ducts, vertical turbines and rim-type generators is being widely explored in tidal current applications (Figure 3.40, Figure 3.41).

From the perspective of integration with an electrical network, the power converters, transformers and cables, as well as the electromechanical systems (generator, drive-train, etc.), are considered to be more critical than those of various front-end conversion subsystems (such as rotors, pitch mechanism, ducts, etc.).



Figure 3.40: Diversity of tidal current energy conversion systems

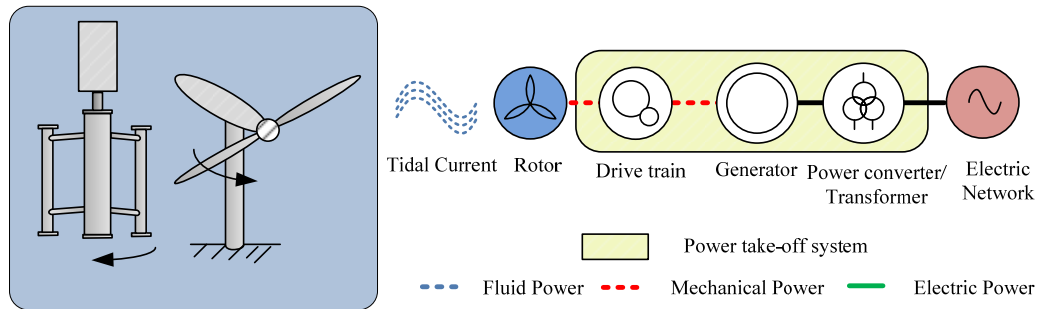

Figure 3.41: Tidal current device power conversion subsystems

In addition to the electrical subsystems, depending on the type of device, various auxiliary mechanisms, such as augmentation ducts, floating structures, blade pitching, etc., can be deployed. The rotary motion in the shaft is transferred to the electrical generator via a gear mechanism or it may have a direct transmission. The latter approach is more common for rim-type generators where the rotor/field is placed outside of the stator, which is connected to the turbine blades.

For a full-converter-based system (fully power electronically interfaced), the output of the generator is fed to the network through an AC-DC-AC conversion process. The primary function of the AC-DC stage is to convert the variable frequency/variable magnitude AC output into a constant DC voltage. This stage also incorporates the maximum power point tracking (MPPT) mode of control. The DC bus is controlled toward having a constant magnitude by injecting suitable amount of real power into the grid via the DC-AC stage. A braking resistor may also be placed in the DC bus for protection of the front-end systems. The DC-AC inverter ensures grid-quality power as well as additional blocking/control (reactive power) mechanisms (Figure 3.42).

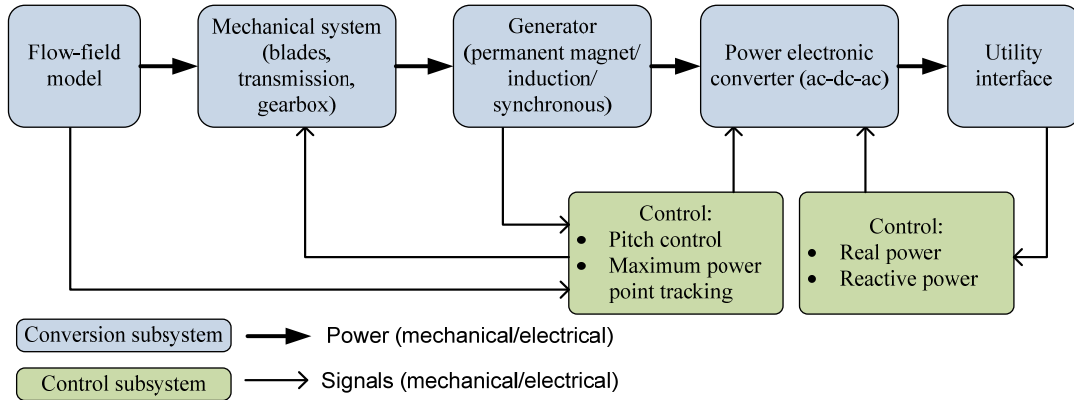

Figure 3.42: Model elements of a tidal current conversion system

In addition to the physical subsystems, the control and protection mechanisms are embedded within the tidal current device. Typically the front-end controllers perform tasks such as pitch control (power regulation with respect to tidal speed) or maximum power point tracking (MPPT), which regulates the turbine rotational speed at an optimum condition. The utility interface controllers ensure suitable measures for real and reactive power injection into the network. A braking controller activates the braking resistor in case of a situation where the machine needs to be shut down temporarily or permanently.

As part of this study, a tidal turbine model has been developed and used in the DSATools<sup>TM</sup>. User defined modelling (UDM) environment receives the initial conditions from the powerflow base case (PSAT) [134]. Various interface variables such as real power, terminal voltage and reactive power back-propagates elements into the model for initialisation.

Apart from the transient phenomenon as a result of the network contingencies, additional transient conditions may appear from various external (variations in water velocity, flow-field elements) or internal (activation of pitch angle reduction or braking resistor) model elements.

For the purposes of relating the tidal turbine system to a physical device, the front-end processes are developed using unitised conventions. On the other hand, to utilise available parameters/data and to follow the existing modelling norms, the converter and network interface is modelled in per unitised format (Figure 3.43).

The power electronic subsystems (machine side/grid side converters) are modelled as algebraic systems, with a first order transfer function having a small time constant in the order of  $\approx 0.02s$ . Available wind generator end-block (full-converter) has been used as the interface between the steady state (powerflow/PSAT) and dynamic (transient stability/TSAT) platforms.

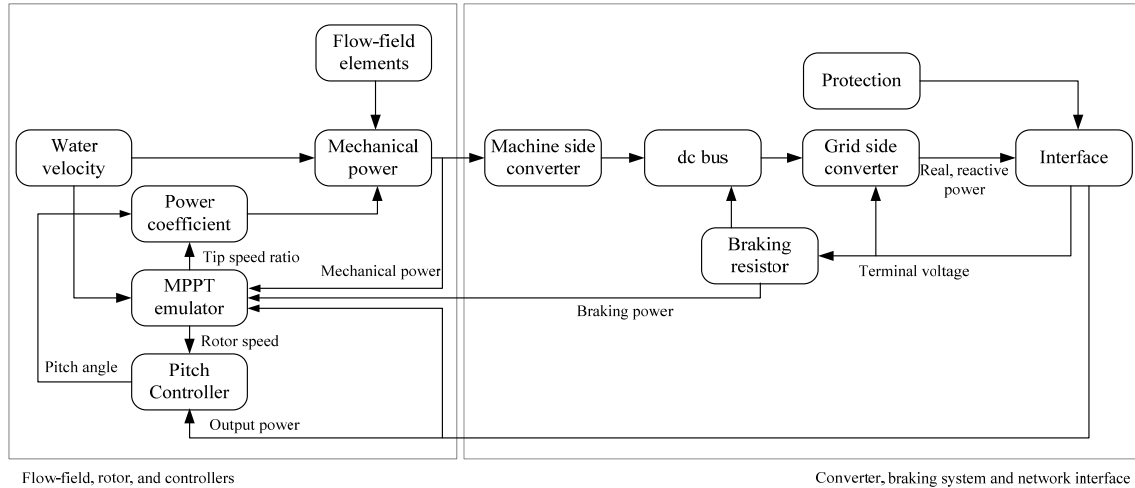

Figure 3.43: Tidal current device model blocks, as implemented in power system analysis software

### 3.4.4 Scenario Setup

#### Points of Interconnection (POI)

A total of 1620 MW tidal current and wave power generation is added at six new buses (as specified in Table 3.16), which are connected to the grid by 154 kV double circuit lines.

Location	Tidal Current and Wave Power Generation				Point of Interconnection (POI)			Line Length (km)
	MW	Bus #	Bus Name	kV	Bus #	Bus Name	kV	
Jeju Island	500	158	W_Jejug Ocea	154	150	Hanlim C	154	12
	500	318	N_Jejug Ocea	154	310	Seojeju	154	12
Mainland	300	7479	Maenggol Ocea	154	7475	Jindo	154	45
	200	7478	Changjuk Ocea	154	7475	Jindo	154	22
	100	7468	Udolmok Ocea	154	7465	Haenam	154	30
	20	10188	DaeBang Ocea	154	10185	Samcheonpo	154	5

Table 3.16: New renewable generation interconnection

#### Transfer

In order to assess the voltage stability margin of the system, the additional generation is increased in steps of 20 MW, first in the Island and then in the Mainland, which is offset by scaling up the load in areas 1 through 5 (i.e., Seoul, South Seoul, Incheon, North Geonggi, Geonggi). In transient and small signal simulations, the final power flows (i.e., after addition of all renewable generations, if applicable) are used. Note that in the light load cases, no more than 900 MW of new generation can be added in Jeju Island due to reaching the 700 MW limit of the HVDC capacity, resulting in total addition of 1520 MW.



## Applied Contingencies

In this study, the system is scanned for single contingencies. The resulting contingency numbers applicable to various types of studies are as specified in Table 3.17.

Case	Voltage Security Assessment		Transient Security Assessment	Small Signal Stability Analysis
	Single Generators (Above 100 MVA)	Single Branches (Above 100 kV + All 3-W Transformers)	Single Branches (Specified by KEPCO)	Single Branches (Above 200 kV)
2017 Light	73	2464+306	398	188
2017 Peak	210	2476+306	410	193
2022 Light	78	2618+315	426	202
2022 Peak	192	2618+315	426	202

Table 3.17: Number of applied contingencies to the four cases in various types of studies

## Criteria

The applied voltage security criteria in this study are as follows:

- Branch Overload: 120% of Rating A for pre-contingency and 120% of Rating B for post-contingency situations, applied to branches of greater than 100 kV buses
- Voltage Magnitude (Min/Max): Not to violate 0.95/1.1 pu at pre-contingency and 0.9/1.1 pu after single contingencies, applied to greater than 100 kV buses
- Voltage Change (Decline or Rise): Not to exceed 6% for single contingencies, applied to greater than 100 kV buses
- Voltage Stability (Collapse) Margin: Not less than 5% for single contingencies (i.e., 81 MW for 1620 MW new injection)

Switched shunt and under-Load Tap changer (ULTC) controls are activated in both pre- and post-contingency situations.

Also, the applicable transient security criteria are the following:

- Transient Stability: System remains stable for the specified contingencies having three-phase faults cleared after 5 cycles
- Transient Voltage Dip (TVD): For single contingencies not to exceed 20% for more than 20 cycles at load buses

For small signal stability, a minimum damping ratio of 3% is suggested.

### 3.4.5 Steady-State/Voltage-Security Assessments

The steady-state situation is analyzed from voltage security point of view, which consists of branch overload, bus voltage magnitude (min/max), bus voltage change (both decline and rise) and voltage stability (collapse) analyses. System loads are represented by constant power models for both active and reactive components.

The voltage stability margin is applied through PV (voltage versus active power) analysis of VSAT, namely by increasing the applied transfer in pre- and post-contingency situations,

until a converged power flow solution cannot be obtained. This is not dependent on any particular bus and can be seen on the corresponding curves of any bus. The 2017 light load case has been found to be of significance where, with all equipment in service, the total of 1520 MW renewable resources can be added without any voltage violation. With single contingencies, however, the security limit is 700 MW. The limiting contingency is Sinanseong 7765. [4010]–Singapyeon 7765. [1020]–1, which causes voltage collapse at 780 MW added renewable generation in the Island. The divergence occurs around the contingency buses. The corresponding PV curves are presented in Figure 3.44. At the security limit, there is no bus voltage violation, but there are branch overload violations, the maximum of which are listed in Table 3.18. Note that some of the overload violations exist before new generation additions or at pre-contingency, although at lower percentages.

No.	Overloaded Branch	Worst Contingency	%Load
1	150 Hanlim CC 154. 330 Hanlim 154. 1	Hanlim CC 154. [150] Seojeju CS 154. [310] '1'	196.5
2	160 Andeok 154. 330 Hanlim 154. 1	Hanlim CC 154. [150] Seojeju CS 154. [310] '1'	178.4
3	7475 Jindo 154. 7495 Jindo CS 154. 2	Jindo 154. [7475] Jindo CS 154. [7495] '1'	132.0

Table 3.18: Maximum overloads for 2017 light load case with 700 MW ocean renewable generation

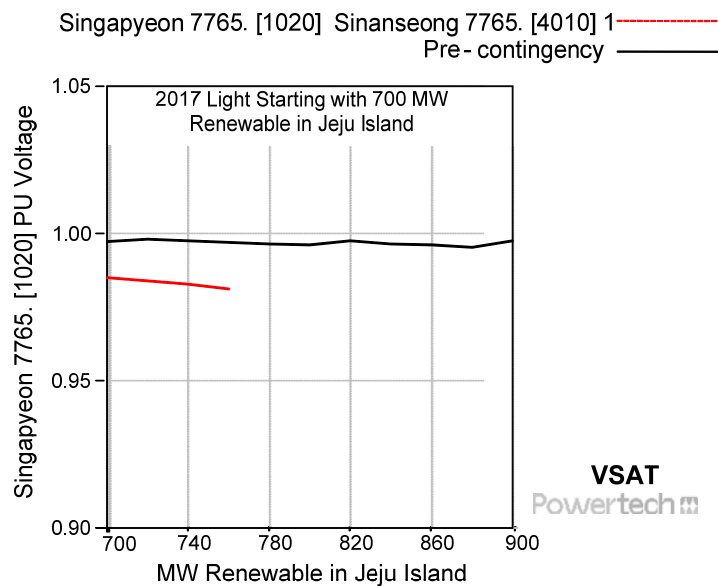

Figure 3.44: PV curves of 2017 light load case

### 3.4.6 Time Domain/Transient Security Assessment

Transient security studies are performed using 3-phase faults cleared after five cycles. System loads are represented according to the models of Table 3.19, as specified by KEPCO.

Load Model	Active Component	Reactive Component	Voltage Exponent	Frequency Coefficient
Constant Current	14%	29%	–	–
Constant Power	51%	26%	–	–
Voltage and Frequency Dependent	35%	–	1.5	0.03
Voltage and Frequency Dependent	–	45%	1.6	–0.1

Table 3.19: Load models for dynamic simulations

Time domain simulations further showed a locally unstable situation under all loading conditions even before adding any new generation. That is, the clearance of either Yeonggw NP#3345. [7152]–Singimje 3 345. [6450]–2 or Yeonggw NP#3345. [7152]–Sinnomwon 3 345. [7100]–2, after a 3-phase fault, resulted in rotor angle separation of Yeonggw #5G 22.0 [27155] ‘1’ and Yeonggw #6G 22.0 [27156] ‘1’ units. A Special Protection System (SPS), such as generation reduction/shedding of these units upon such contingencies, is recommended.

### 3.4.7 Small Signal Stability Analysis

Under small signal stability analysis, inter-area modes of the system were analyzed for single contingency screening. System loads are represented according to the models of Table 3.19, as specified by KEPCO. A relevant mode that is somewhat affected by the new generation addition is presented in Table 3.20 for all four cases. These results are for the worst contingency, namely, “Yeonggw NP#3345. [7152]–Singimje 3 345. [6450]–2”. The most dominant unit of the mode is either Sinkori 3G 24.0 [29013] ‘1’ or Sinkori 4G 24.0 [29014] ‘1’.

Case	Before Renewable Additions		After Renewable Additions	
	Frequency (Hz)	Damping Ratio (%)	Frequency (Hz)	Damping Ratio (%)
2017 Light	0.6032	3.96	0.5924	3.99
2017 Peak	0.5661	6.90	0.5621	6.24
2022 Light	0.5582	2.04	0.5455	1.44
2022 Peak	0.5212	4.30	0.5153	3.91

Table 3.20: Relevant inter-area mode for the worst contingency before and after renewable resources

Under light loading conditions of 2022, a 0.55 Hz mode was found to have lower than suggested criterion of 3% damping, namely about 2% damping before adding the new generation, which could deteriorate to less than 1.5% after addition of the renewable resources. The above recommended SPS, as well as the new 765 kV circuit, would improve the situation significantly. Generating units with the highest participation factors were also identified for addition of new Power System Stabilisers (PSS) and/or retuning of the existing PSS, if further enhancement is desired.

### 3.4.8 Conclusion

With regard to tidal power integration in the Korean electricity network, voltage security, transient security and small signal stability analyses for years 2017 and 2022, under both peak and light loading conditions, have been carried out. It was assumed that, before 2017,

Jeju Island would be connected to the Korean Mainland through two high voltage direct current (HVDC) submarine transmission links, totaling a maximum capacity of 700 MW in either direction. Two locations of ocean wave energy generation in the Island and four locations of tidal current flow generation in the Mainland were considered. The maximum new generation injections in the Island and Mainland were 1000 MW and 620 MW, respectively, to be dispatched against forecasted load increases in certain areas of the Mainland. In this case study, the voltage and transient security assessment revealed some limitations, e.g., the system could become unstable upon the loss of a particular line. Implementing a second circuit in parallel with this 765 kV line is expected to remove the corresponding voltage and transient security limitations both before and after addition of the new resources.

## **4 DISCUSSION AND RECOMMENDATIONS**

---

### **4.1 SUMMARY**

The report has described the state-of-the-art knowledge regarding the grid integration of ocean energy under various headings and from an electrical utility perspective. Each stage of the energy conversion and transmission process, ranging from the characteristics of ocean resources to the grid codes, has been addressed.

The variability and predictability of wave and tidal current have been discussed with respect to their potential impact on dispatchability and power quality. The general features of the energy conversion process in wave and tidal current devices have also been briefly described for each energy conversion stage. The potential impact of the various conversion concepts on power system stability and control have been explored and detailed. Several national grid codes have been described and compared to each other, and interconnection guidelines have been presented. Finally, the option of energy storage has been discussed in the perspective of power systems either autonomous or non-integrated to a large power system.

The second part of the report consists of four case studies and an accompanying discussion of their results. Two of these case studies were performed at the distribution level, in Spain and in Ireland respectively. The other two were carried out on the transmission grid of the west coast of the USA and of Republic of Korea. This last section intends to summarise the outputs of the accomplished studies. The knowledge gaps identified during the studies and recommendations for future collaboration and research activities are hence listed and detailed in the final section “Recommendations for Future Collaboration”.

#### **4.1.1 Predictability of Wave and Tidal Current Resources**

Wave and tidal current resources are considered as more predictable than wind from a grid operator point of view. Although tidal current velocities are fully predictable, the time horizon for wave power prediction is much more limited. However, the reasonable accuracy of 48-hour ahead forecasting methods for wave power is a very beneficial advantage from a grid integration perspective. Grid operators currently require wind farm managers to supply wind power forecasts two to three days ahead. However, contrary to the requirements regarding the time horizon for power prediction, some unknowns remain regarding the level of accuracy that will be demanded in the future by the grid operators. However, as the grid strength and interconnectivity and the penetration levels of ocean energy may vary largely from one country to another, so would the impact of different levels of accuracy in wave power forecasting on the required spinning reserve and power system stability. Case studies should be envisaged for assessing and analysing this impact on several representative electrical networks with differing characteristics and penetration levels of ocean energy. An output of such study may be an estimate of a range of reasonable accuracy levels linked to corresponding metrics related to grid interconnectivity and ocean energy penetration.

### **4.1.2 Dispatchability**

It was highlighted that short-term dispatchability of wave and tidal current power plants has to be discussed with respect to the variation of the input power, the storage and control means, as well as the number of devices in a farm. It has also been emphasised that accurate forecasts of the ocean wave and tidal current resources may considerably benefit ocean devices by increasing their long-term dispatchability. Being dispatchable, as generally demanded by grid operators, is necessary for a device to reach grid compliance and be eventually marketable. While some devices potentially have the means to control and constrain their power production, few of them explicitly regard these control means as related to grid dispatch. A comprehensive data collection on existing short-term dispatchability means would be two-fold. Firstly, it would provide grid operators with an overview of the current state of ocean devices with respect to short-term dispatchability. Secondly, this study could be utilised to disseminate knowledge regarding dispatchability requirements among device developers.

### **4.1.3 Capacity Factor of Wave and Tidal Current Power Plants**

The issues relative to the objective assessment and interpretation of pilot plant capacity factor were discussed, including the absence of external and independent evaluation methods. The information also come from the limited literature available on the experimental data due to the confidentiality status of some studies and to the limited number of grid-connected wave and tidal current power plants. In addition, the relevance of the existing publicly available data was discussed regarding the experimental conditions. It was argued that some plants are operated intermittently, for instance for performing various types of tests on the plants. However, the actual number of operating hours is generally unknown rendering an independent evaluation of the capacity factor extremely difficult. Further, some tests may be carried out under conditions that may differ significantly from the plants' nominal conditions. This difference in terms of operating conditions has an impact regarding the performance of the plant and has to be stressed to allow an objective interpretation of the capacity factor.

The capacity factor is a parameter usually taken into account for macro-level, techno-economical studies. An accurate and reliable assessment of the capacity factor of a power plant is hence of great importance for high-level decision-making. Hence, detailed analyses on the capacity factor of existing wave and tidal current power plants are necessary for improving the currently insufficient knowledge on this topic. These analyses should also include some discussion regarding the context in which the experimental data have been produced. The understanding of the context may be refined, for instance, by discussing the availability factor of the plant or the ratio of operating hours in nominal conditions with respect to the total number of hours. In addition, an analysis of the evolution in time of the capacity factor, or any other parameters characteristic of an ocean farm, may also be interesting to review technology maturation.

### **4.1.4 Power Quality**

The distribution case studies carried out have shown two different aspects of grid integration regarding the strength of the network connection point. The Spanish *bimet* wave farm, located off the coast of the Basque Country, will be connected to a strong connection point. Hence, the impact of this 20 MW wave farm on the rest of the grid

was shown to be negligible. However quite large voltage variations can be observed inside the farm when wave energy converters with no reactive power control are connected.

By contrast, the Irish Belmullet case study has shown the issues relative to the integration of a 5 MW wave farm to a weaker grid of the western coast of Ireland. In fact, some minor concerns in terms of power quality and voltage variations, arise for wave farms exceeding 3 MW in worst case conditions, that is, with devices having no storage means and with a minimal smoothing from device aggregation.

In both analyses, the smoothing effect due to device aggregation improves the power quality output of the farm by decreasing its variance. The reduction of power fluctuations implies fewer power losses inside the grid, hence improving the efficiency of the farm. Another benefit of device aggregation is the minimisation of voltage variations at the PCC. However, the modelling of device aggregation may need to be refined in order to obtain detailed and conclusive results.

Fault ride-through capability analysis shows the importance of reactive power control in weak grids. When a voltage dip occurs at the PCC in *bimep* the voltage recovery takes a very short time independently of the reactive power control option whereas this recovery can take up to 300 ms when wave energy converters based on squirrel cage generators are connected at Belmullet.

Those two case studies are deemed to be representative of extreme types of grid-connection in Europe, which can also be used benchmarks at an international level.

The impact of wave electricity on power quality is a recently emerging field of research. The Irish case study has shown that even a relatively small wave farm of 5 MW could have a significant impact on a medium voltage local network. Such a negative influence is generally thought to be negligible when a wave farm is connected at a higher voltage connection point. However, it is still uncertain whether power quality issues may occur or not on stronger grids at higher penetration levels.

In addition, the accuracy of the simulation results with respect to field measurement data has not yet been validated. This comparison between experimental and simulated results will become essential when it comes to numerical model validation. Models of ocean energy converters will actually be used by grid operators for assessing the impact of a device on their network. Grid connection may be allowed only on the grounds of grid compliance of the numerical dynamic model within the frame of a simulation. Moreover, having a reliable model is necessary for leading more detailed investigations, in particular regarding the impact of different technologies on the network as well as to study the power smoothing effect induced by device aggregation. It will be important to collect experimental data from pilot plants and utilise this data to validate dynamic simulation models of the pilot plants themselves. Such a research activity should be envisaged as part of the next step in the study of impact on power quality.

#### **4.1.5 Interconnection Guidelines**

Conventional power plants must comply with requirements, commonly known as standards or codes, in order for the grid manager to operate the power system in a reliable, economic and safe way. However, some pilot projects might not be able to reach grid compliance at a first stage due to the relative immaturity of the technology. At low penetration levels, these projects may be envisaged to be allowed grid

connection with less stringent requirements if complying with acknowledged best practices. Adopting such a support approach would greatly benefit the ocean energy industry.

However, these specific best practices or guidelines still remain to be developed. Existing standards and guidelines relative to grid connection of wind farms may be modified and adapted to the specific integration issues of ocean energy technology, such as resource variability, system diversity and use of relatively novel technologies. Particular attention needs to be paid to the ramp rate limitations, voltage variation guidelines and dynamic modelling requirements for ocean energy technologies. In addition, ocean energy could benefit significantly from technological solutions available from the wind energy industry once adapted to its own characteristics.

Flexible network interconnection guidelines are essential elements to integrate ocean energy technologies in the traditional marketplace. Also, adopting these best practices would make grid connection to immature ocean devices potentially possible. This would not only accelerate the optimisation of the ocean farm design process, but would also increase the knowledge on the grid impact of ocean energy converters and the ability to design suitable remedial solutions if eventually needed. The development of appropriate interconnection guidelines, based on a solid technical understanding of the grid impact of ocean devices, with respect to their power outputs and local grid constraints, will hence bring confidence amongst the network operators and pave the path for the market integration of ocean power.

#### **4.1.6 Integrated System Scenario Analyses**

The transmission case studies presented in this report demonstrate a systematic approach considering transmission system issues in an integrated manner to determine the level of large-scale integration of wave and tidal current power generation to larger power systems in a certain time frame. The analyses also highlighted constraints observed at a system level and identified corresponding infrastructure needs to address the constraints. Outputs from such types of integrated analysis could provide necessary mechanisms and inputs towards development of long-term resource and infrastructure portfolios for a region involving this emerging renewable resource option.

It is important to note that transmission case studies presented in the report are illustrative and it is unlikely that wave energy and/or tidal current energy resource additions would be made in exactly this fashion. To be compliant with the requirements of each individual transmission owner, resource specific interconnection studies will be needed to determine interconnection requirements. The case studies presented should not be considered as detailed support for interconnection request studies, transmission service request studies, feasibility studies, system impact studies, cost assessments or project deployment activities. Further economic analysis and technical assessment (particularly focusing on the distribution system and specific transmission reliability issues) should be conducted to support those decisions. However, these analyses are based on detailed technical inputs, and can be confidently treated as a reference for enabling longer-term wave and tidal power deployment targets and associated policy mechanisms.



#### **4.1.7 Integration of the Technologies with Storage into NIA/Autonomous Systems**

The limited discussion made on energy storage need was on the context of integration of these emerging resources for remote coastal areas that are not integrated to larger power systems. Many of these areas currently depend on oil or diesel fuel for electricity generation. Considering the emerging status of the conversion technologies and the limited flexibility of these smaller power systems, it would be necessary to determine the optimum size of any such wave and/or tidal current plants and the storage that can be integrated to such NIA/autonomous power systems.

## **4.2 RECOMMENDATIONS FOR FUTURE COLLABORATION**

Considering the current state of the marine energy technologies and their future potentials, subsequent relevant collaborative activities at an international level should be pursued. These activities should also be paralleled with concurrent project initiatives, technology development and standards development initiatives. With a view to further progress in the current systematic and collaborative task-shared investigations on the behaviour of grid-connected ocean power systems (ocean wave and tidal current), particularly focusing on pilot plants either in operation and/or soon to be built, the following items are recommended.

### **4.2.1 Pilot Project Information Collection and Dissemination**

This collaborative activity could provide a forum for national and international information exchange, with focuses on developing a better understanding of the design and operational characteristics of ocean power generators, as well as summarising various multi-disciplinary ‘lessons-learned’ highlights.

### **4.2.2 Power Quality Impact and System Design**

This activity may incorporate various pilot projects, marine devices and their influence on power quality and interactions with the power grids.

### **4.2.3 Dynamic Model Validation**

This activity involves the development of dynamic numerical models of pilot plant equipment, and would require agreed collaborative effort with the device developer(s) involved in the pilot plant(s) in order to develop the models. The models would then be validated experimentally through access to the plant operational data.

### **4.2.4 Device and Interconnection Guidelines**

This activity may investigate the synergies between ocean power and conventional power generation systems (particularly in the context of system modelling) and provide directions for generic device model developments, validated against field data.

This work could also look into analytical aspects of system security and provide direction for interconnection requirements.

### **4.2.5 Integrated System Scenario Assessment for a Larger Power System**

Further investigations may be deemed desirable, especially in the following context: incorporation of newer network changes, cross-border transmission resources, dynamic model development (device-specific), effects of longer-term resource variability, integrated system impact of the regions under longer time horizons, as well as use of Flexible AC transmission System (FACTS) devices, and effects of special contingencies and protection schemes.

#### **4.2.6 Development of Methodology to Optimise Size of Demonstration and Storage for NIA/Autonomous Systems**

A methodology could be developed that would include the present and future generation mix for the area, including characteristics of diesel generation, and target system reliability, load growth scenarios as well as cost/benefit analysis considering required system upgrades and the benefits from displaced diesel fuels and reduction in emission.

Any new international work should embark upon collaborative exercises that also realise the concurrent trends, state of the art and future direction.

## 5 BIBLIOGRAPHY

---

- [1] OES-IA Document No: T0311. *Potential Opportunities and Differences associated with Integration of Ocean Wave and Ocean Current Energy Plants in Comparison to Wind Energy*. March 2009.
- [2] OES-IA Document No: T0312. *Key Features and Identification of Needed Improvements to Existing Interconnection Guidelines for Facilitating Integration of Ocean Energy Pilot Projects*. March 2009.
- [3] OES-IA Document No: T0321. *Dynamic Characteristics of Wave and Tidal Energy Converters and a Recommended Structure for Development of a Generic Model for Grid Connection*. July 2010.
- [4] International Energy Agency. *Variability of Wind Power and Other Renewables: Management Options and Strategies*. [Online, Accessed: March 09]. Available: <http://www.iea.org/textbase/papers/2005/variability.pdf>.
- [5] *Variability of UK Ocean Resources. An Assessment of the Variability Characteristic of the UK's Wave and Tidal Current Power Resources and Their Implications for Large Scale Development Scenarios*. Commissioned by The Carbon Trust, produced by the Environmental Change Institute, July 2005.
- [6] Bryden, Ian G., Scott J. Couch. "ME1-Marine Energy Extraction: Tidal Resource Analysis, Renewable Energy," Volume 31, Issue 2, *Marine Energy*, February 2006, pp. 133-139, ISSN 0960-1481.
- [7] Marine Current Turbines Limited. [Online, Accessed on Feb 2010]. Available: <http://www.oceanturbines.com/6/background/14/seaflow/>.
- [8] Enermar System. [Online, Accessed on Feb 2010]. Available: [http://www.spok.dk/seminar/Enermar%20system\\_32.pdf](http://www.spok.dk/seminar/Enermar%20system_32.pdf).
- [9] DTI, Stingray Tidal Stream Energy Device Phase 3, 2005 <http://www.dti.gov.uk/renewables/publications/pdfs/T00211.pdf>.
- [10] Lunar Energy Power Limited. [Online, Accessed on Feb 2010]. Available: <http://www.lunarenergy.co.uk/>.
- [11] Pelamis Wave Power Ltd. [Online, Accessed on Feb 2010]. Available: <http://www.pelamiswave.com/>.
- [12] Equimar. *Deliverable D5.1 Guidance Protocols on Choosing of Electrical Connection Configurations*.
- [13] Kundur, Prabha. *Power System Stability and Control*. EPRI Editors, Neal J. Balu and Mark G. Lauby. ISBN 0-07-035958-X.
- [14] Kirby, B. J. *Frequency Control Concerns in the North American Electric Power System*, December 2002.
- [15] Kirby, B. J., J. Dyer, C. Martinez, D. Rahmat, A. Shoureshi, R. Guttromson, J. Dagle. *Frequency Control Concerns In the North American Electric Power System*.
- [16] Kundur, P., et al. *IEEE Transactions on Power Systems*, V. 19, No. 2, May 2004.

- [17] Bollen, M. H. J. "What is Power Quality?" *Electric Power Systems Research*, Volume 66, Issue 1, July 2003, pages 5-14.
- [18] Holttinen, H. "Estimating the Impacts of Wind On Power Systems." *Modern Power Systems*, 28 (5), 2008.
- [19] Molinas, M., O. Skjervheim, B. Sørby, P. Andreasen, S. Lundberg, T. Undeland. "Power Smoothing by Aggregation of Wave Energy Converters for Minimizing Electrical Energy Storage Requirements," *Proceedings of the 7th European Wave and Tidal Energy Conference*, 2007.
- [20] European Wind Energy Association (EWEA). *Large Scale Integration of Wind Energy in the European Power Supply: Analysis, Issues and Recommendations*. Available at : <http://www.ewea.org/>, December 2005.
- [21] E.ON Netz GmbH. *Grid Code, High and Extra High Voltage*. August 2003.
- [22] ESB National Grid. *Wind Farm Power Station Grid Code Provisions*. Ireland, July 2004.
- [23] ELTRA Transmission System Planning. *Specifications for Connecting Wind Farms to the Transmission Grid*. April 2000.
- [24] De Alegria, I.M., J. Andreu, J. L. Martín, P. Ibañez, J. L. Villate, H. Camblong. "Connection Requirements for Wind Farms: A Survey on Technical Requirements and Regulation." *Renewable and Sustainable Energy Reviews*, 11 pp. 1858-1872, 2007.
- [25] Slootweg, J.G., S. W. H. de Haan, H. Polinder, W. L. Kling. "Voltage Control Methods with Grid Connected Wind Turbines: A Tutorial Review." *Wind Engineering*, 25 (6): pp. 353-365, 2001.
- [26] Ledesma, P., J. Usaola. "Contribution of Variable-Speed Wind Turbines to Voltage Control." *Wind Engineering* 26 (6), pp. 347-358, 2002.
- [27] Robles, E. *Integración en la Red de la Energia Eolica, Suficiencia Investigadora*. Universidad del Pais Vasco, 2006.
- [28] Koch, F., I. Erlich, F. Shewarega, U. Bachmann. "The Effect of Large Offshore and Onshore Wind Farms on the Frequency of a National Power Supply System; Simulation Modelled on Germany." *Wind Engineering* 27 (5): pp. 3939-404, 2003.
- [29] Matevosyan, Julija, Thomas Ackermann, Sigrid Bolik and Lennart Söder. "Comparison of International Regulations for Connection of Wind Turbines to the Grid." *Nordic Wind Power Conference*, 1-2 March, 2004.
- [30] Jauch, Clemens, Poum Sorensen, Birgitte Bak-Jensen. "International Review of Grid Connection Requirements for Wind Turbines." *Nordic Wind Power Conference*, 1-2 March, 2004.
- [31] Scottish and Southern Energy plc. *Guidance note for the connection of wind farms*. Issue No. 2.1.4 2002 (Draft).
- [32] REE, P.O.12.2. *Instalaciones Conectadas a la Red de Transporte: Requisitos Mínimos de Diseño, Equipamiento, Funcionamiento y Seguridad y Puesta en Servicio*. March 2005.

- [33] REE, P.O.12.3. *Requisitos de Respuesta Frente a Huecos de Tensión de las Instalaciones de Producción de Régimen Especial*. October 2006.
- [34] Li, H.Y., P. A. Crossley and N. Jenkins, *Transient Directional Protection for Distribution Feeders with Embedded Generations PSSC*. Sevilla, June 24–28 (2002).
- [35] Funabashi, T., K. Koyanagi and R. Yokoyama. “A Review of Islanding Detection Methods for Distributed Resources.” *Power Tech Conference Proceedings*, 2003, IEEE, Bologna.
- [36] IEEE Std 1547-2003, *IEEE Standard for Interconnecting Distributed Resources with Electric Power Systems*.
- [37] Lund, P. D., and J. V. Paatero. *Energy Storage Options for Improving Wind Power Quality*. Helsinki University of Technology Advanced Energy Systems P.O. Box 4100, FI-02015 TKK (Espoo), Finland.
- [38] Power System Simulation Software List. [Online, Accessed on Dec 2010.] Available: <http://martinole.org/SimuSoft.html>.
- [39] Palma Behnke, Rodrigo. *Software y Multimedia*. [Online, Accessed on Dec 2010.] Available: <http://146.83.6.25/software.htm>.
- [40] Open Directory Project. [Online, Accessed on Dec 2010.] Available: [http://www.dmoz.org/Science/Technology/Software\\_for\\_Engineering/Electrical\\_Engineering/Power\\_Distribution/](http://www.dmoz.org/Science/Technology/Software_for_Engineering/Electrical_Engineering/Power_Distribution/).
- [41] DiGSILENT. Online, Accessed on Dec 2010. Available: <http://www.digsilent.de>.
- [42] DSATools, Powertech Labs Inc, 12388 - 88th Avenue, Surrey, British Columbia, Canada, V3W 7R7; URL: [www.dsatools.com](http://www.dsatools.com).
- [43] Khan, M. J., G. Bhuyan, A. Moshref, K. Morison. *An Assessment of Variable Characteristics of the Pacific Northwest Regions Wave and Tidal Current Power Resources, and their Interaction with Electricity Demand and Implications for Large Scale Development Scenarios for the Region*. Powertech Labs Inc., Tech. Rep. 17485-21-00 (Rep 3), Jan. 2008. [Online]. Available: <http://www.powertechlabs.com/cfm/index.cfm?It=106&Id=58>.
- [44] Khan, J., D. Leon, A. Moshref, G. Bhuyan. *A Scenario Analysis of Northwest Electrical System toward Determining the Level of Wave Power that Can be Integrated By 2019 In Oregon*. Available: [www.oregonwave.org](http://www.oregonwave.org), 2010.
- [45] Bonneville Power Administration (BPA), *Technical Req. for Interconnection to the BPA Trans. Grid*. STD-N-000001-00-01; URL: <http://www.transmission.bpa.gov>.
- [46] Le Crom, I., A. Brito-Melo, F. Neumann, A. J. N. A Sarmiento, “Portuguese Grid Connected OWC Power Plant: Monitoring Report”, *Proceedings of the 20th Int Offshore and Polar Eng Conf*, ISOPE, Beijing, China, June 2010.
- [47] Oceanlinx. [Online, Accessed on March 2011]. Available: [www.oceanlinx.com/](http://www.oceanlinx.com/)
- [48] SeaGen Fact sheet (SeaGen website) [Online, Accessed March 2011]
- [49] Lee, K.-S. “Tidal and Tidal Current Power Study in Korea”, *OREG 2006 Spring Symposium*, Victoria.

- [50] *Ponte di Archimede S.P.A., Research and Development.* [Online, Accessed on March 2011] [www.pontediarchimede.it/shared\\_uploads/Download/9\\_DOCUMENTO.pdf](http://www.pontediarchimede.it/shared_uploads/Download/9_DOCUMENTO.pdf).
- [51] *Roosevelt Island Tidal Energy Project.* FERC No. 12611, Final Kinetic Hydropower Pilot License Application.
- [52] Holmes, B., and Barrett, S. “Prediction for Ocean Energy Supply.” *2nd Renewable Energy in Maritime Island Climates (REMIC 2).* Dublin, Ireland, April 2006.
- [53] *Feasibility of Using WaveWatch III for Days-Ahead Output Forecasting in Grid-Connected Wave Energy Projects in Washington and Oregon.* EPRI, 2008
- [54] *ESB National Grid, Distribution Code.* October 2007, DCC11.5.3, Wind Power Forecasts.
- [55] Fusco, F., J. V. Ringwood. “Short-Term Wave Forecasting for Real-Time Control of Wave Energy Converters.” *IEEE Transactions on Sustainable Energy*, Vol. 1, No. 2, July 2010
- [56] Cretel, J., A. W. Lewis, G. Lightbody, G. Thomas. “An Application of Model Predictive Control to a Wave Energy Point Absorber.” *Proceedings of the IFAC Conference 2010.*
- [57] Zhang, Chen, Randall Ye. “Hybrid Wave Model for Unidirectional Irregular Waves.” *Applied Ocean Research* 18 (1996) II-92
- [58] Belmont, M. R. “Increases in the Average Power Output of Wave Energy Converters using Quiescent Period Predictive Control.” *Renewable Energy* 35 (2010) 2812e2820
- [59] *Wind Energy FAQ.* EWEA [Online, Accessed on March 2011], [www.ewea.org/index.php?id=1884](http://www.ewea.org/index.php?id=1884)
- [60] “Delivering Offshore Wind Power in Europe”, *Policy Recommendations for Large-Scale Deployment of Offshore Wind Power in Europe by 2020.* EWEA (2007)
- [61] *Wave Star Energy, Wave Star Bølgekraftmaskine 1:40 Skala Model.*
- [62] Soerensen, H. C. “Wave Dragon – from the 20 kW to the 7 MW prototype device.” *EU Contractors’ Meeting.* October 2006,
- [63] “Wave Dragon Pre-Commercial Demonstrator.” *Environmental Impact Assessment, Scoping Report, Rev 5.* December 2005
- [64] Zhao, M., Z. Chen, F. Blaabjerg. “Optimisation of Electrical System for Offshore Wind Farms via Genetic Algorithm.” *IET Renewable Power Generation*, 2009, Vol. 3, Iss. 2, p. 205-216.
- [65] Thorburn, Karin, Hans Berhoff, Mats Leijon. “Wave Energy Transmission System Concepts for Linear Generator Arrays.” *Ocean Engineering* 31 (2004) 1339-1349.
- [66] EMEC: The European Marine Energy Centre Ltd. [www.emec.org.uk](http://www.emec.org.uk).
- [67] Wikipedia. [Online, Accessed on Feb 2010]. Available: [www.wikipedia.com](http://www.wikipedia.com).

- [68] Jiang-Hafner, Ying, Hugo Duchon, Michael Karlsson, Leif Ronstrom, Bernt Abrahamsson. "HVDC with Voltage Source Converters - A Powerful Standby Black Start Facility." Paper presented at the IEEE PES T&D conference in Chicago, 2008.
- [69] Macken, K. J. P., L. J. Driesen, and R. J. M. Belmans. "A DC Bus System for Connecting Offshore Wind Turbines with the Utility System." *Proc. European Wind Energy Conf. 2001*, pp. 1030–1035.
- [70] Barberis Negra, N., J. Todorovic and T. Ackermann. "Loss Evaluation of HVAC and HVDC Transmission Solutions for Large Offshore Wind Farms." *Electric Power Systems Research*, Volume 76, Issue 11, July 2006, pp 916-927.
- [71] Martinez de Alegria, Inigo, Jose Luis Martin, Inigo Kortabarria, Jon Andreu, Pedro Ibanez Ereno. "Transmission Alternatives for Offshore Electrical Power." *Renewable and Sustainable Energy Reviews*, Volume 13, Issue 5, June 2009, pp 1027-1038.
- [72] Bostrom, C. et. al. "Experimental Results of Rectification and Filtration from an Offshore Wave Energy System." *Renewable Energy*, Elsevier 2008.
- [73] Ricci, P. et al. "Time Domain Models and Wave Energy Converters Performance Assessment." *Proceedings of the ASMET 27th International Conference on Offshore Mechanics and Arctic Engineering*. June 15-20, 2008, Estoril, Portugal.
- [74] Sudrià, A., M. Chindris, A. Sumper, G. Gross, F. Ferrer. "Wind Turbine Operation in Power Systems and Grid Connection Requirements." *International Conference on Renewable Energies and Power Quality*. ICREPQ'05 Zaragoza 16,17,18 of March, 2005.
- [75] Lubosny, Z. "Wind Turbine Operation." *Electric Power Systems*. Springer-Verlag Berlin, ISBN 3-540-40340-X.
- [76] Budal, K. and J. Falnes. "Optimum Operation of Improved Wave-Power Converter." *Marine Science Communications*, 3, 133-150. 1997.
- [77] Budal, K. and J. Falnes. *A System for the Conversion of Sea Wave Energy*. British patent No. 1522661 (Date of patent 2 July 1975). 1978.
- [78] Salter, S. H., D. C. Jeffery, and J. R. M. Taylor. "The Architecture of Nodding Duck Wave Power Generators." *The Naval Architect*, January 1976, pp. 21-24.
- [79] Salter, S. H. *Apparatus for Extracting Power from Waves on Water*. British patent No. 1571790 (Date of patent 20 January 1976). 1980.
- [80] Falnes, J. *Principles for Capture of Energy from Ocean Waves Phase Control and Optimum Oscillation*. Department of Physics, NTNU, N-7034 Trondheim, Norway.
- [81] Falnes, J. *Optimum Control of Oscillation of Wave Energy Converters*. Institut for fysikk, NTH Universitetet i Trondheim N-7034 Trondheim, Norway.
- [82] Wavebob. [Online, Accessed on Feb 2010]. Available: [http://www.wavebob.com/how\\_wavebob\\_works](http://www.wavebob.com/how_wavebob_works).
- [83] Ricci, P. et al. "Control Strategies for a Simple Point-Absorber Connected to a Hydraulic Power Take-off." *Proceedings of the 8th European Wave and Tidal Energy Conference*. Uppsala, Sweden, 2009.



- [84] Martínez, E., F. Sanz, J. Blanco, F. Daroca, E. Jiménez. *Economic Analysis of Reactive Power Compensation in a Wind Farm: Influence of Spanish Energy Policy*. Received 30 August 2006; accepted 29 November 2007 Available online 28 January 2008.
- [85] Dixon, Juan et. al. “Reactive Power Compensation Technologies, State of- the-Art Review.” *Proceedings of the IEEE*. ISSN: 0018-9219 (2005).
- [86] Noroozian, M. et. al. “Benefits of SVC and STATCOM for Electric Utility Application.” *Transmission and Distribution Conference and Exposition, 2003 IEEE PES*.
- [87] Santos, M. *Aportaciones al Control Centralizado de un Parque Eólico*. Tesis Doctoral, 2007, Universidad de Mondragon, Spain.
- [88] UK National Statistics. [Online, Accessed on Feb 2010]. Available: <http://www.statistics.gov.uk>.
- [89] Scotland, the Official Online Gateway. [Online, Accessed on Feb 2010]. Available: <http://www.scotland.org/about/fact-file/population/>.
- [90] National Grid (LSE: NG.; NYSE:NGG), International Electricity and Gas Company. [Online, Accessed on Feb 2010]. Available: <http://www.nationalgrid.com>.
- [91] REE, Red Eléctrica de España, Spain. [Online, Accessed on Feb 2010]. Available: [www.ree.es](http://www.ree.es).
- [92] Wikimedia Commons. [Online, Accessed on Feb 2010]. Available: <http://commons.wikimedia.org>.
- [93] REN. Rede Electrica Nacional, Portugal. [Online, Accessed on Feb 2010]. Available: <http://www.ren.pt>.
- [94] EirGrid, Ireland. [Online, Accessed on Feb 2010]. Available: <http://www.eirgrid.com>.
- [95] Statistics Canada: *Population Distribution as of July 1, 2007 by Census Division (CD)*, Canada, URL: <http://www.statcan.gc.ca/pub/91-214-x/2007000/4181396-eng.htm>
- [96] Canadian Electricity Association: *Canada’s Electricity Industry: Background and Challenges*. URL: [www.electricity.ca/electricity-101.php](http://www.electricity.ca/electricity-101.php)
- [97] U.S. Census Bureau. [Online, Accessed on Oct 2010]. Available: <http://www.census.gov/popesr/galley/maps/>.
- [98] Global Energy Network Institute. [Online, Accessed on Oct 2010]. Available: <http://www.geni.org>.
- [99] Best Country Reports. [Online, Accessed on Oct 2010]. Available: [http://www.bestcountryreports.com/Population\\_Map\\_South%20Korea.html](http://www.bestcountryreports.com/Population_Map_South%20Korea.html).
- [100] Kepco. *Annual Report, 2010*. [Online, Accessed on Oct 2010]. Available: [http://cyber.kepco.co.kr/kepco\\_new/invest/manage/annualReport.jsp](http://cyber.kepco.co.kr/kepco_new/invest/manage/annualReport.jsp).
- [101] Stock Map Agency, World Trade Press. [Online, Accessed on Dec 2010]. Available: <http://www.stockmapagency.com/index.php>.

- [102] Elia System Operator SA. [Online, Accessed on Dec 2010]. Available: <http://www.elia.be/repository/pages/a8647b8fabf84821ab39c16803125d3e.aspx>.
- [103] Italy Tour Guide. [Online, Accessed on Dec 2010]. Available: <http://italytourguide.blogspot.com/2008/08/08/italy-population/>.
- [104] Statistics Sweden. [Online, Accessed on Dec 2010]. Available: [http://www.scb.se/statistik/publikationer/OV0904\\_1750I04\\_BR\\_02\\_A01SA05\\_01.pdf](http://www.scb.se/statistik/publikationer/OV0904_1750I04_BR_02_A01SA05_01.pdf).
- [105] Svenska Kraftnät. [Online, Accessed on Mar 2010]. Available: <http://www.svk.se/Start/English/Energy-Market/Electricity/National-Grid/>
- [106] Australian Bureau of Statistics. [Online, Accessed on Dec 2010]. Available: <http://www.abs.gov.au/websitedbs/d3310114.nsf/Home/census>.
- [107] Department of Resources, Energy and Tourism, Australian Government. [Online, Accessed on Mar 2010]. Available: <http://www.ret.gov.au/energy/facts/Pages/EnergyFacts.aspx>.
- [108] Marqués, Javier, Yago Torre-Enciso, Iker Marino, Germán Pérez, Laura Zubiate. “*bimep* – Biscay Marine Energy Platform.” *2nd International Conference on Ocean Energy (ICOE 2008)*. 15th – 17th October 2008, Brest, France.
- [109] Sustainable Energy Authority of Ireland. [Online, Accessed on Dec 2010]. Available: [http://www.seai.ie/Renewables/Ocean\\_Energy/AMETS/Belmullet\\_Test\\_Site/](http://www.seai.ie/Renewables/Ocean_Energy/AMETS/Belmullet_Test_Site/).
- [110] Santos, M., D. Ben Haim, F. Salcedo, J. L Villate and Y. Torre-Enciso. “Grid Integration of Wave Energy Farms: Basque Country Study.” *3rd International Conference on Ocean Energy*. October 6, Bilbao, 2010.
- [111] *Iberdrola* [Online, Accessed on Dec 2010]. Available: <http://www.iberdrola.es/>.
- [112] Cummins, W. E., “The Impulse Response Function and Ship Motions.” *Schiffstechnik* 9 (1661), pp. 101-109. 1962.
- [113] Ricci, P., et. al. “Control Strategies for a Simple Point-Absorber Connected to a Hydraulic Power Take-off.” *Proceedings of the 8th European Wave and Tidal Energy Conference*, Uppsala, Sweden. 2009.
- [114] Falnes, J. “*Ocean Waves and Oscillating Systems*.” Cambridge University Press.
- [115] Perez, T., T. I. Fossen, “Time Domain versus Frequency Domain Identification of Parametric Radiation Force Models for Marine Structures at Zero Speed.” *Modelling, Identification and Control*, Vol. 29, No. 1, pp. 1-19. 2008.
- [116] OM 2225/1985. Orden Ministerial del 5 de Septiembre de 1985. *Normas Administrativas y Técnicas para el Funcionamiento y Conexión a las Redes Eléctricas de Centrales Hidroeléctricas de hasta 5000kVA y Centrales de Autogeneración Eléctrica*.
- [117] Propuesta de Procedimiento de Operación Básico de las Redes de Distribución. POD9. *Criterios de Funcionamiento y Operación de la Red de Distribución*. CNE. 2009.
- [118] *Standard EN 50160*. “Voltage Characteristics in Public Distribution System.”

- [119] Network Loss Factor Methodology 2010-2011. *Top Energy*. TePuna Hihiko. [Online, Accessed on March 2011]. Available: <http://www.topenergy.co.nz/pdf/Network%20Loss%20Factor%20Methodology%202010-2011.pdf>
- [120] Blavette, A., D. O’Sullivan, M. Egan, R. Alcorn, T. Lewis. “Wave Energy Grid Integration in Ireland – A Case Study.” *3rd International Conference on Ocean Energy*. October 6, Bilbao, 2010.
- [121] PSS/e Generic Wind Turbine Model WT3.
- [122] ESB. *Distribution Code version 2.0* (2007), section DCC6.8.1
- [123] *Engineering Recommendation P28*. “Planning Limits for Voltage Fluctuations Caused by Industrial, Commercial and Domestic Equipment in the United Kingdom,” 1989.
- [124] *IEC 61000-2-12*. “Electromagnetic Compatibility – Part 2-12”.
- [125] ESB. *Distribution Code version 2.0* (2007), section DPC4.2.2.
- [126] ESB. *Distribution Code version 2.0* (2007), section DCC11.1.2.
- [127] Hagerman, George, Roger Bedard, Mirko Previsic, “EPRI Survey and Characterization of Potential Offshore Wave Energy Sites in Oregon.” *Tech. Report: E21 EPRI WP-OR-003*, May 17, 2004.
- [128] Bedard, Roger, George Hagerman, Omar Siddiqui. “System Level Design, Performance and Costs – Oregon State Offshore Wave Power Plant.” *Tech. Report E21 EPRI Global – WP – 006 – OR- Rev1*, Nov. 30, 2004.
- [129] Western Electricity Coordinating Council. *Information Summary*. November 2008, <http://www.wecc.biz/>.
- [130] U.S. Department of Energy. (2009, Apr.) Marine and Hydrokinetic Technology Database. Available: <http://www1.eere.energy.gov/windandhydro/hydrokinetic/default.aspx>.
- [131] Khan, J., and G. Bhuyan. *Ocean Energy: Global Technology Development Status*. OES-IA Document No. T0104, 2009 [Online]. Available: <http://www.iea-oceans.org/index.asp>.
- [132] Falnes, Johannes. *Ocean Waves and Oscillating Systems*. Cambridge University Press, ISBN-10: 0521782112, 2002.
- [133] Arabi, S., “Impact Studies for Incorporating Tidal Current And Wave Resources in South Korean System.” *Powertech Project Report 19629-29*. 2010.
- [134] Powertech Labs. *Report on Enabling Accelerated Deployment of Tidal Current Energy Conversion Systems*. Asia Pacific Partnership (APP) Project No. RED-10-41, 2011, prepared for Environment Canada, 2011.