



HAL
open science

DYNAMIC CHARACTERISTICS OF WAVE AND TIDAL ENERGY CONVERTERS & A RECOMMENDED STRUCTURE FOR DEVELOPMENT OF A GENERIC MODEL FOR GRID CONNECTION

Dara O'Sullivan, Darren Mollaghan, Anne Blavette, Raymond Alcorn

► To cite this version:

Dara O'Sullivan, Darren Mollaghan, Anne Blavette, Raymond Alcorn. DYNAMIC CHARACTERISTICS OF WAVE AND TIDAL ENERGY CONVERTERS & A RECOMMENDED STRUCTURE FOR DEVELOPMENT OF A GENERIC MODEL FOR GRID CONNECTION. [Research Report] Ocean Energy Systems-Implementing Agreement (OES-IA), International Energy Agency. 2010. <hal-01265981>

HAL Id: hal-01265981

<https://hal.science/hal-01265981v1>

Submitted on 12 Jul 2016

HAL is a multi-disciplinary open access archive for the deposit and dissemination of scientific research documents, whether they are published or not. The documents may come from teaching and research institutions in France or abroad, or from public or private research centers.

L'archive ouverte pluridisciplinaire **HAL**, est destinée au dépôt et à la diffusion de documents scientifiques de niveau recherche, publiés ou non, émanant des établissements d'enseignement et de recherche français ou étrangers, des laboratoires publics ou privés.



HAL Authorization

International Energy Agency Implementing Agreement on
Ocean Energy Systems

**DYNAMIC CHARACTERISTICS OF WAVE AND
TIDAL ENERGY CONVERTERS & A
RECOMMENDED STRUCTURE FOR
DEVELOPMENT OF A GENERIC MODEL FOR
GRID CONNECTION**

July 2010

**A report prepared by HMRC-UCC for OES-IA under
ANNEX III - Integration of Ocean Energy Plants into
Distribution and Transmission Electrical Grids**

OES-IA Document No: T0321



DYNAMIC CHARACTERISTICS OF WAVE AND TIDAL ENERGY CONVERTERS & A RECOMMENDED STRUCTURE FOR DEVELOPMENT OF A GENERIC MODEL FOR GRID CONNECTION

Final Annex III Technical Report

OES-IA Document No: T0321

Authors:

Dara O’Sullivan, Darren Mollaghan, Anne Blavette and Raymond Alcorn.
Hydraulics & Maritime Research Centre (University College Cork)
Youngline Industrial Estate
Pouladuff Rd., Cork
Ireland

Disclaimer

The OES-IA, also known as the Implementing Agreement on Ocean Energy Systems, functions within a framework created by the International Energy Agency (IEA). Views, findings and publications of the OES-IA do not necessarily represent the views or policies of the IEA Secretariat or of all its individual member countries.

Neither the authors nor the participating organizations nor the funding organizations makes any warranty or representations, expressed or implied, with respect to use of any information contained in this report, or assumes any liabilities with respect to use of or for damages resulting from the use of any information disclosed in this document.

Suggested Citation

The suggested citation for this report is:

D. O’ Sullivan, D. Mollaghan, A.Blavette and R.Alcorn (2010). “*Dynamic characteristics of wave and tidal energy converters & a recommended structure for development of a generic model for grid connection*”, a report prepared by HMRC-UCC for the OES-IA Annex III. [Online], Available: www.iea-oceans.org.

Availability of Report

A PDF version of this report is available at:

www.iea-oceans.org

FORWARD

The International Energy Agency (IEA) is an autonomous body, within the framework of the Organization of Economic Co-operation and Development (OECD), which carries out a comprehensive program of energy co-operation among different countries. The Implementing Agreement on Ocean Energy Systems (OES-IA) is one of the several IEA collaborative agreements within the renewable energy domain.

This report has been prepared under the supervision of the Operating Agent for the OES-IA Annex III on Integration of Ocean Energy Plants into Distribution and Transmission Electrical Grids by

Gouri S. Bhuyan

Powertech Labs Inc.

12388-88th Ave, Surrey, British Columbia, Canada

In co-operating with experts of the following countries:

Canada, United Kingdom, Ireland, Spain and New Zealand

It has been approved by the Executive Committee of the OES-IA program.

This report summarizes the work performed in Work Package 2 of Annex III. The activities for this work package were led by HMRC-UCC. Other organizations contributing to this report are Powertech Labs of Canada, Tecnalia of Spain, and AWATEA of New Zealand.

ACKNOWLEDGEMENTS

Primary funding for this work package was provided by the Sustainable Energy Authority of Ireland (SEAI) and Science Foundation Ireland through the Charles Parsons Energy Research Awards. Funding for the overall management of the Annex activities was also provided by Powertech Labs, the UK Department of Energy and Climate Change (DECC), Tecnalia of Spain and AWATEA of New Zealand.

The authors of this report would like to acknowledge the valuable inputs provided by the following individuals to the report:

Mr. Jose Luis Villate and Dra. Mainer Santos Mugica of ROBOTIKER-Tecnalia, Spain

Dr. Gouri Bhuyan and Dr. Jahangir Khan of Powertech Labs, Canada

Dr. John Huckerby, AWATEA, New Zealand

EXECUTIVE SUMMARY

In order to connect an electricity generating plant to the electrical grid there are a series of rules and guidelines that must be adhered to. One of these is that the generator owner must provide a dynamic electrical model of their system that is compatible with the network planners and operators software. This model should take into account time series variation of the resources such as wave elevation and tidal flow velocity. The model should be usable in simulations of both normal operation and operation in the presence of grid faults.

These models are a requirement as they are used by the network operator to ensure that any new generation on their system

- Is stable under normal and faulted conditions
- Does not affect other users/generators
- Produces acceptable power quality
- Does not overload existing protection circuitry and power lines
- Allows Load Flow analysis to be performed

Currently, the only sustainable energy system models available are of those for wind and hydro. These existing models are highly confidential, proprietary and fully commercial.

The Ocean Energy Industry will require dynamic electrical models in order to procure grid connections and to demonstrate their technology at large scale. They also require knowledge of how their technology interacts with the grid, and what, if any, remedial design work needs to be carried out in order to procure a grid connection.

The OES –IA Executive Committee approved an Annex (Annex III) in 2007 with an overall aim: to provide a forum for information exchange and co-operative research related to the short-term and long-term integration of ocean energy into electrical systems. The Annex consisted of three work packages and co-ordination with other relevant initiatives within IEA. The overall aim of this Work Package is the development of a database of ocean energy device dynamic characteristics and the outlining of a generic structure that can be used to create grid connection dynamic models of ocean energy devices. This report presents the work carried out in Work Package 2 of the Annex.

The creation of a generic dynamic model is quite an onerous task given the plethora of wave and tidal energy devices currently in development. In this document, a common or generic power conversion chain representing the majority of ocean wave and tidal energy devices is identified. Brief examples of each stage of this conversion chain are provided for a range of device classifications. The dominant dynamic characteristics of each stage of the power conversion chain are also identified, and the importance of each stage in determining dynamic response and conversion efficiency is identified. This process is important in deciding the level of detail required in the modelling of each conversion stage.

The characterisation of each of these conversion stages is then addressed. This is based on the results of a questionnaire submitted to a range of ocean energy device. The main purpose of the questionnaire is to ascertain the type of test and specification data used by developers to characterise their device performance, with a view to utilising similar data for dynamic model characterisation.

Based on these responses, a full generic dynamic model structure is proposed, with recommendations on how each conversion stage should be represented and parameterised. Finally, a database of typical dynamic model time constants for the most important power conversion stages, and for a range of device types is generated.

Table of Contents

| | |
|---|----|
| 1. Introduction..... | 11 |
| 2. Ocean Energy Device Classification | 13 |
| 2.1 Energy Conversion Stages..... | 13 |
| 2.2 Overall Classifications..... | 14 |
| 2.2.1 Oscillating Water Column..... | 14 |
| 2.2.2 Attenuator..... | 15 |
| 2.2.3 Point Absorber | 15 |
| 2.2.4 Submerged Pressure Differential | 16 |
| 2.2.5 Oscillating Wave Surge Converter | 16 |
| 2.2.6 Overtopping Devices..... | 17 |
| 2.2.7 Tidal Turbines | 18 |
| 2.2.8 Oscillating Hydrofoils..... | 18 |
| 2.2.9 Tidal Sail Devices..... | 19 |
| 2.2.10 Venturi Effect Devices..... | 19 |
| 2.3 Primary Energy Capture Dynamics..... | 19 |
| 3. Prime Movers..... | 22 |
| 3.1 Air Turbines..... | 22 |
| 3.1.1 Wells Turbine | 22 |
| 3.1.2 Dennis-Auld Turbine | 23 |
| 3.1.3 Impulse Turbine | 23 |
| 3.2 Hydraulic Motors..... | 23 |
| 3.3 Hydro Turbines | 24 |
| 3.4 Direct Mechanical Drive..... | 25 |
| 3.5 Prime Mover Dynamics..... | 25 |
| 4. Generators and Power Electronics Converters..... | 27 |
| 4.1 Power Electronics Converters..... | 27 |
| 4.2 Synchronous Generators | 27 |
| 4.3 Asynchronous (Induction) Generators..... | 28 |
| 4.4 Linear Generators..... | 29 |
| 4.5 Generator and Power Converter Dynamics..... | 30 |
| 5. Energy Storage | 32 |
| 5.1 Energy Storage Dynamics | 32 |
| 6. Control..... | 34 |

| | | |
|-------|--|----|
| 6.1 | 'Fast' Tuning Control | 34 |
| 6.2 | 'Slow' Tuning Control..... | 35 |
| 7. | Generic Model Outline and Characterisation..... | 36 |
| 7.1 | 'Overall' Section..... | 39 |
| 7.1.1 | Conclusions from 'Overall' section..... | 42 |
| 7.2 | 'Primary Power Capture' Section..... | 44 |
| 7.2.1 | Conclusions from 'Primary Power Capture' Section | 47 |
| 7.3 | 'Storage' Section..... | 49 |
| 7.3.1 | Conclusions from 'Storage' Section..... | 50 |
| 7.4 | 'Prime Mover' Section..... | 51 |
| 7.4.1 | Conclusions from 'Prime Mover' Section | 53 |
| 7.5 | 'Generator' Section..... | 54 |
| 7.5.1 | Conclusions from 'Generator' Section | 55 |
| 7.6 | 'Control' section..... | 57 |
| 7.6.1 | Introduction | 57 |
| 7.6.2 | Tuning..... | 59 |
| 7.6.3 | Actively-controlled parameters | 63 |
| 7.6.4 | Conclusion of the 'Control' section | 67 |
| 8. | Generic Dynamic Model Structure and Database..... | 69 |
| 9. | Summary..... | 73 |

Table of Figures

| | |
|---|----|
| Figure 1: Typical Ocean Energy Conversion Process..... | 13 |
| Figure 2: OWC Illustration | 14 |
| Figure 3: Attenuator Illustration | 15 |
| Figure 4: Point Absorber Illustration | 16 |
| Figure 5: Submerged Pressure Differential Device Principle | 16 |
| Figure 6: OWSC Schematic | 17 |
| Figure 7: Overtopping Device Illustration..... | 17 |
| Figure 8: Horizontal and Vertical Axis Turbine Illustration..... | 18 |
| Figure 9: Oscillating Hydrofoil Illustration | 18 |
| Figure 10: Venturi Effect Device Illustration..... | 19 |
| Figure 11: Spring-mass-damper System | 20 |
| Figure 12: Wells Turbine and Blade Profile [25] | 22 |
| Figure 13: Impulse Turbine[27] | 23 |
| Figure 14: Radial Hydraulic Motor and Axial Hydraulic Motor [29] | 24 |
| Figure 15: Reaction Turbine [31] and Hydro Impulse Turbine [32]..... | 24 |
| Figure 16: Manchester Bobber Drive Train[33]..... | 25 |
| Figure 17: Linear Generator[39] | 29 |
| Figure 18: Linear Generator Configurations[16]..... | 30 |
| Figure 19: Colour Coded Model Reference..... | 36 |
| Figure 20: Colour Coded Model Reference (direct-drive systems)..... | 36 |
| Figure 21: Device Categories by Resource | 40 |
| Figure 22: Device Categorization | 40 |
| Figure 23: Ability to Provide a Power Matrix/Curve | 41 |
| Figure 24: Self-Alignment Capability for Wave Energy Devices..... | 41 |
| Figure 25: Directional Sensitivity of the Power Take-Off (Wave Energy Devices Only) | 42 |
| Figure 26: Summary of Directional Dependence of PTO (Wave Energy Devices Only) | 42 |
| Figure 27: Primary Power Capture Type | 45 |
| Figure 28: Linearity of Device Response to Changing Wave Height or Tidal Flow Speed..... | 45 |
| Figure 29: Characterisation Parameters (for both Wave and Tidal Stream Devices) | 46 |
| Figure 30: Tune-Ability Timeframes (for Wave Devices Only)..... | 46 |
| Figure 31: Power Constraint Mechanisms..... | 47 |
| Figure 32: Types of Storage | 49 |
| Figure 33: Energy Storage Parameterisation Data | 49 |
| Figure 34: Storage Strategy Timeframe (Wave Energy Devices Only) | 50 |
| Figure 35: Prime Mover Categories..... | 51 |
| Figure 36: Multiple Prime Mover Operation | 51 |
| Figure 37: Speed Characteristic of Prime Movers | 52 |
| Figure 38: Time Variability of Prime Mover Speed..... | 52 |
| Figure 39: Ability to Provide an Average Efficiency for a Range of Prime Mover Speeds and Input Conditions..... | 53 |
| Figure 40: Generator Types | 54 |
| Figure 41: Grid Connection and Power Electronics Approach..... | 54 |

| | |
|---|----|
| Figure 42: Presence of a Gearbox..... | 55 |
| Figure 43: Ability to Provide Efficiency Curves for the Generator | 55 |
| Figure 44: Power optimisation/limitation means..... | 57 |
| Figure 45: Ability to tune to prevailing sea conditions | 59 |
| Figure 46: Tuning phases | 60 |
| Figure 47: Decision parameters..... | 60 |
| Figure 48: Decision parameters (decoupled)..... | 60 |
| Figure 49: Ability to provide numerical values for T_d and N | 61 |
| Figure 50: Timescale of decision time T_d | 61 |
| Figure 51: Ability to provide tuning time T_t | 62 |
| Figure 52: Timescale of tuning time T_t | 62 |
| Figure 53: Actively-controlled parameters..... | 64 |
| Figure 54: Control of IPS, SCR and SDR | 64 |
| Figure 55 – Use of maximum power tracking curve (tidal devices only)..... | 66 |
| Figure 56 – Use of a maximum power tracking curve (wave devices only) | 67 |
| Figure 57: Dynamic Model Structure and Characterization Data | 70 |

List of Tables

| | |
|---|----|
| Table 1: Major Device Classifications | 14 |
| Table 2 - Example components, for each device category, at each stage of the conversion process | 37 |
| Table 3 - Dynamic characteristics of each conversion stage..... | 38 |
| Table 4: Storage stage controlled parameters with respect to the storage types..... | 65 |
| Table 5: Typical Dynamic Model Time Constants for Different Device Types and Power Conversion Stages..... | 71 |

1. INTRODUCTION

The technology for wave and tidal current energy conversion is still in its relative infancy. The installed capacity of ocean energy devices supplying to national grids worldwide is less than 10 MW as of 2010[1]. There are many challenges which must be overcome for wave and tidal energy to be both feasible and economical enough to compete with or complement more mature renewable sources such as wind energy[2, 3]. There are a multitude of designs for wave energy devices, at various stages of development, employing many means of energy conversion. Each device has its own particular advantages and disadvantages, but there is as of yet no clear indication which technology type or group of technologies will emerge as viable from an engineering and economic point of view.

Globally there are only a few devices that have exported power to national grids. Some examples of these are:

- Marine Current Turbines (tidal) in Strangford Lough, N. Ireland
- Pelamis Wave Power (wave) in Agucadoura, Portugal
- Pico Power Plant (wave) in the Azores islands
- Wavegen Power Plant (wave) in Islay, Scotland

However, quite a few pre-commercial developers are now approaching the point where they are investigating the grid connectivity of their technology. Simultaneously, electricity network operators and others are looking to assess the potential future impact on distribution and transmission networks of the large scale integration of ocean energy [4, 5].

Dynamic models provide a grid operator with a means of assessing the impact of renewable energy generators on the local and national grid from the point of view of system stability, dynamic voltage variation, and fault performance and ratings [6, 7]. Without such a model, device developers will be unable to procure a grid connection. Moreover, the process of developing a grid connection dynamic model also furnishes the device developer with a design tool to assess the grid compatibility of their technology.

A successful dynamic model should have the means to accept a time series resource input and provide a real and reactive power time series output to a connection point in a power systems simulator package, initially for a single device, but ultimately for an aggregated farm of devices. Operation under both normal operation and grid fault conditions must be modelled correctly. A distinction needs to be drawn between a grid connection dynamic model and a design level model, which usually includes full hydrodynamic parameters and strives to be highly accurate in its representation of device motions and performance. This level of detail is not required in a dynamic model for grid connection. However, power output variation, protection mechanisms, and generator and prime mover dynamics need to be modelled to a reasonable level of accuracy. Dynamic models exist for wind turbines [6-11], but there are no such models for wave or tidal current devices.

The overall aim of this Annex 3 Subtask (3.2) is the development of a database and a generic structure that can be used to create grid connection dynamic models of wave and tidal current energy devices. The creation of a generic dynamic model is quite an onerous task given the plethora of wave and tidal energy devices currently in development. This report summarises the results of an extensive review of the different ocean energy devices and attempts to categorise and classify devices according to common dynamic features in the individual devices. The various power take off (PTO) elements are also classified and grouped, and the more important dynamic modelling aspects of each element identified. This classification is then used to develop a generic dynamic model structure around which developer questionnaires have been constructed. The results of these questionnaires and some recommendations for the construction of such a generic dynamic model are presented, along with a database of typical dynamic time constants for a range of device types.

2. OCEAN ENERGY DEVICE CLASSIFICATION

There are many different methods for wave and tidal current energy conversion. The majority of devices, however, follow an approximately similar general outline in terms of energy conversion and capture. This chapter looks at the various stages in the energy conversion process and discusses the different methodologies used within each stage.

2.1 Energy Conversion Stages

The energy conversion process can be broken down as follows:-

- 1. Primary Energy Capture:** This is the means through which the device interacts with the energy source, transferring energy from the waves or tidal currents to a medium which can be captured by a 'prime mover'.
- 2. Prime Mover:** This is a component which can convert the energy captured at the primary energy capture stage to a more useful form of energy, usually mechanical energy, which can be connected to a generator. In some devices, such as tidal turbines, the primary energy capture and prime mover functions are embodied in the same component. In such a case, this component will be referred to as the primary energy capture component as this more completely describes its functionality.
- 3. Generator:** The generator converts the mechanical energy of the prime mover into electrical energy and can also act as one of the main control elements in the system.
- 4. Storage:** Energy storage is used to smooth the time variation of the output electrical power, thus enhancing the power quality of the device.
- 5. Control:** Control systems are required to optimise, coordinate and control the operating points of some, or all, of the power take off components and also to protect the device in undesirable operating conditions.

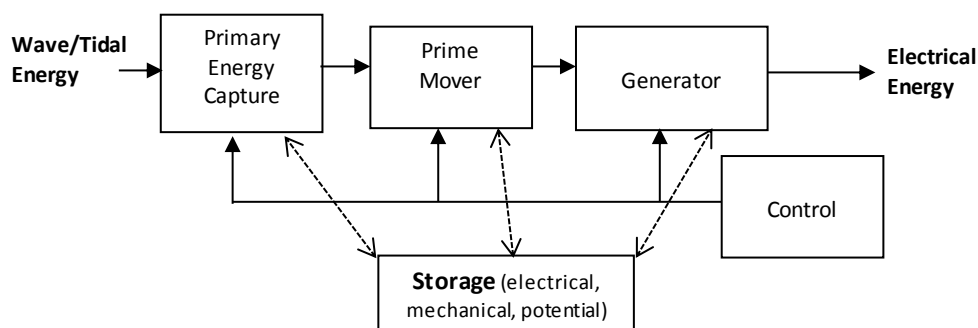

Figure 1: Typical Ocean Energy Conversion Process

2.2 Overall Classifications

In an attempt to group and classify ocean energy devices, the primary energy capture technique is typically used as a demarcation between device classes. Often, the same or similar prime movers and generators can be employed in very different devices, and so it is reasonable to classify devices according to the dynamics of the primary energy capture method. As mentioned previously, in some tidal current devices, the primary energy capture component can also be considered as a prime mover.

The following device classifications are representative of the majority of ocean energy devices.

Table 1: Major Device Classifications

| Wave Energy | Tidal Current Energy |
|----------------------------------|-----------------------|
| Oscillating Water Column (OWC) | Tidal Turbine |
| Attenuator | Oscillating Hydrofoil |
| Point Absorber | Tidal Sail Device |
| Submerged Pressure Differential | Venturi Effect Device |
| Oscillating Wave Surge Converter | |
| Overtopping Device | |

A brief description of each of these primary power capture processes is provided. Most of these technologies are described in more detail in other technology overview publications [1, 2]. The emphasis in this report is on the dynamic characteristics of the power conversion process, which are summarised at the end of the section.

2.2.1 Oscillating Water Column

The Oscillating Water Column (OWC) device [12, 13] converts wave motion into pneumatic energy within an enclosed chamber. The air is then passed through a turbine which is connected to a generator. The primary power capture converts wave energy into pneumatic energy. An illustration of a typical system is shown below:

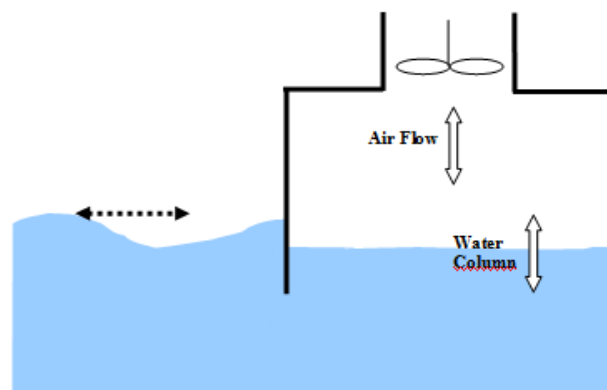

Figure 2: OWC Illustration

It is possible to use hydraulic PTO instead of pneumatic PTO in OWCs. The vast majority of OWCs use pneumatic PTO however, so only this type will be discussed in this report.

2.2.2 Attenuator

Attenuators [14] are floating devices aligned to the incident wave direction. Passing waves cause movements along the length of the device. Energy is extracted from this motion..

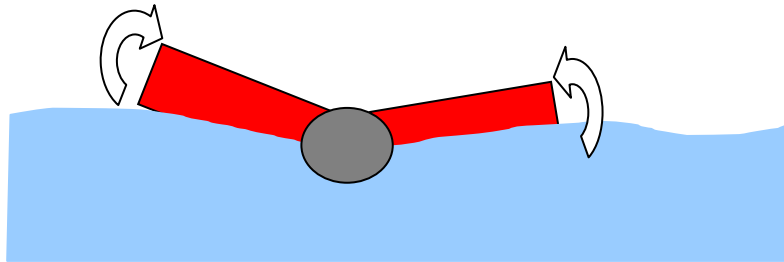

Figure 3: Attenuator Illustration

These types of devices are typically long multi-segment structures. The device motion follows the motion of the waves. Each segment, or pontoon, follows oncoming waves from crest to trough.

The floating pontoons are usually located either side of some form of power converting module. Passing waves create a relative motion between each pontoon. This relative motion can then be converted to mechanical power in the power module, through either a hydraulic circuit (most common) or some form of mechanical gear train.

2.2.3 Point Absorber

Point absorber devices [15] are generally axi-symmetric about a vertical axis. They are small in comparison to the incident wave length. Point Absorber devices usually consist of two main components – a displacer which is a buoyant body which moves with wave motion, and a stationary or slow moving reactor. Energy can be extracted through the relative motion between the displacer and the reactor. This can be accomplished using electromechanical or hydraulic energy converters.

An illustration of a typical point absorber is given in Figure 4.

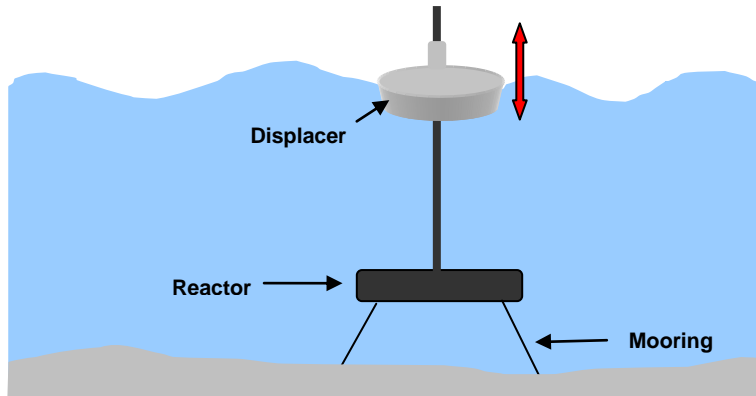

Figure 4: Point Absorber Illustration

2.2.4 Submerged Pressure Differential

This type of device can be considered to be a fully submerged point absorber [16]. The PTO for the device consists of two main components, a reactor and a displacer. Passing waves cause the sea surface elevation above the device to rise and fall. A pressure differential is created above the device as waves pass. This causes an air chamber within the displacer to decompress and compress, thus causing the displacer to rise and fall. The reactor is typically secured to the sea bed. Power can be extracted from the relative motion between the displacer and reactor, by using a hydraulic or electromechanical system connected between the displacer and reactor.

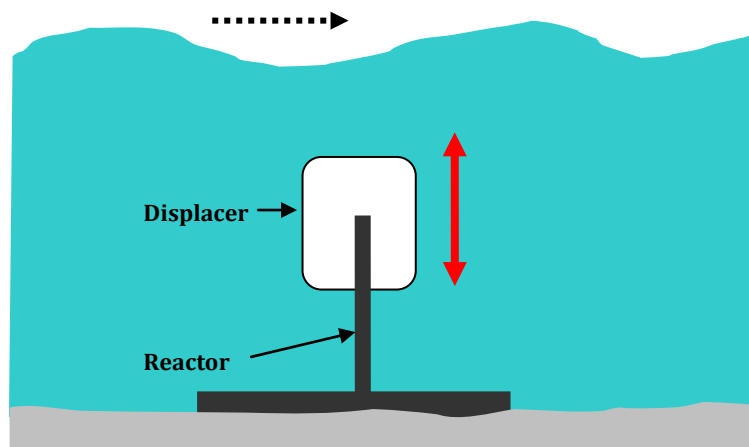

Figure 5: Submerged Pressure Differential Device Principle

2.2.5 Oscillating Wave Surge Converter

The Oscillating Wave Surge Converter (OWSC) [17] extracts the energy caused by wave surges and the movement of water particles with them. At the sea-bed, on or near the shore, the water particle motion becomes a back and forth motion. It is from this oscillating surge motion that the OWSC extracts energy. The devices can be secured to the sea bed, on or near the shore. They consist of a surge displacer which can be hinged at the top or bottom. Energy is typically extracted using hydraulic converters secured to a reactor.

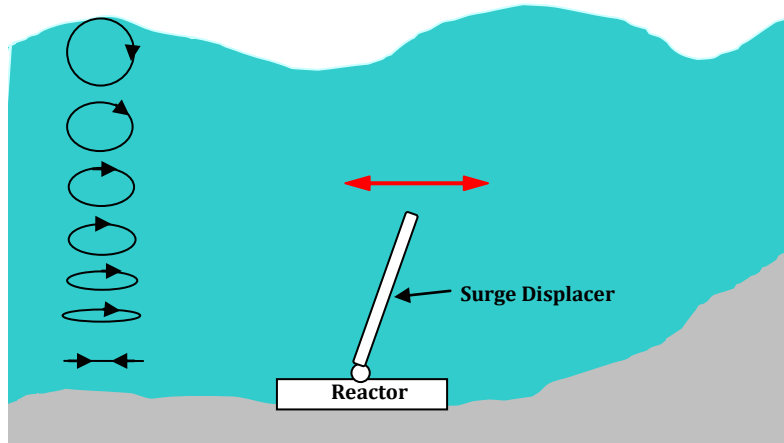

Figure 6: OWSC Schematic

It is also common to place the device on the shoreline and hinge the displacer above the water. Incoming surge waves first impact on the displacer and are then captured within the device to form a water column. This water column then empties, moving the displacer in the opposite direction, and the water is returned to the sea.

It is also possible to use the surge action of the waves to trap and compress air within a pneumatic chamber [18]. In this case, the OWSC is usually semi-submerged, to allow for the trapping of air at the surface of the wave troughs.

2.2.6 Overtopping Devices

Overtopping devices [19] extract energy from the sea by allowing waves to impinge on a structure such that they force water up over that structure thus raising its potential energy. The water can then be stored in some form of a reservoir. The potential energy of the water is converted to kinetic energy using a conventional hydro turbine. After exiting the turbine, the water is then returned to the sea.

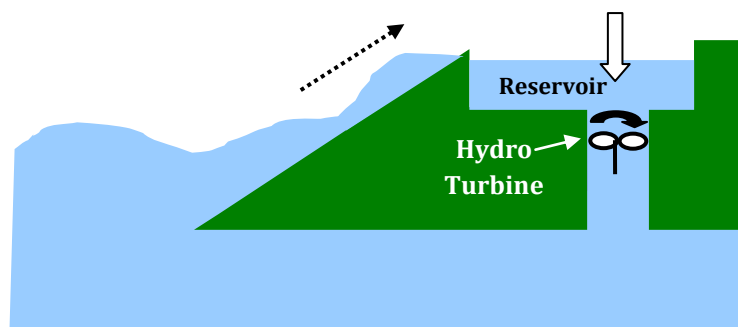

Figure 7: Overtopping Device Illustration

These devices are fundamentally low-head hydro power plants, except the source of water is from the sea rather than rivers or lakes. They tend to be typically much larger than other devices as significant volumes of water capture are necessary.

These devices have one clear advantage over other wave energy devices - the inclusion of a reservoir allows for inherent energy storage. This can be used to produce a more consistent level of power supplied to an electrical grid.

2.2.7 Tidal Turbines

Horizontal axis tidal turbines [20] are the marine equivalent of wind turbines, with energy being extracted through the lift forces of the moving water on the turbine blades. The significantly higher density of sea water relative to air results in significantly smaller diameter turbine blades than equivalent power rated wind turbines. Vertical axis turbines are typically cross flow turbines, whose rotation direction is perpendicular to the prevailing flow direction. In terms of energy conversion and dynamic performance, they are similar to horizontal axis turbines. Tidal energy is directly converted to mechanical energy putting them in the same category as prime movers.

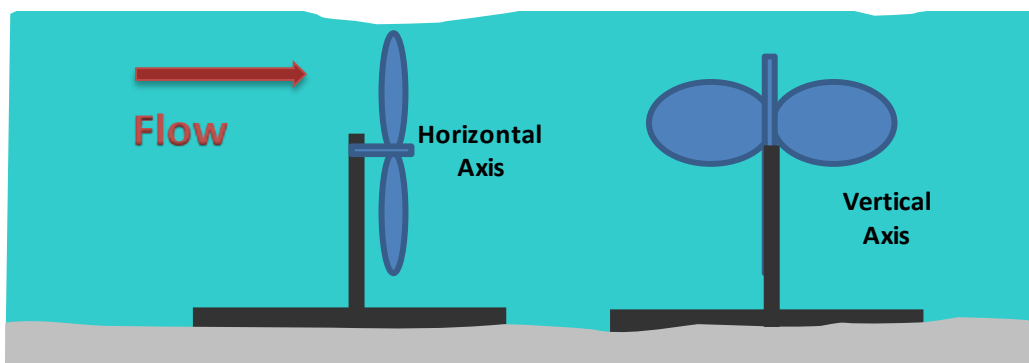

Figure 8: Horizontal and Vertical Axis Turbine Illustration

For power take-off, these devices are generally directly connected to a generator through a gearbox. Optimal tidal energy power take-off takes place at a relatively slow rotational speed, whereas optimal generator design and performance occurs at high rotational speeds, resulting in the desirability of a gearbox in the power train.

2.2.8 Oscillating Hydrofoils

Oscillating hydrofoils [21] utilize the aerodynamic principle of lift due to a moving fluid passing over a hydrofoil. The hydrofoil is typically fixed to a moving arm by which the lift force is transferred to a pumping mechanism for driving reciprocating hydraulic ram pumps which in turn power a prime mover such as a hydraulic motor. The angle of attack of the hydrofoil is actively controlled in order to maintain optimum power take-off throughout the stroke, and in order to reverse direction at the ends of the stroke.

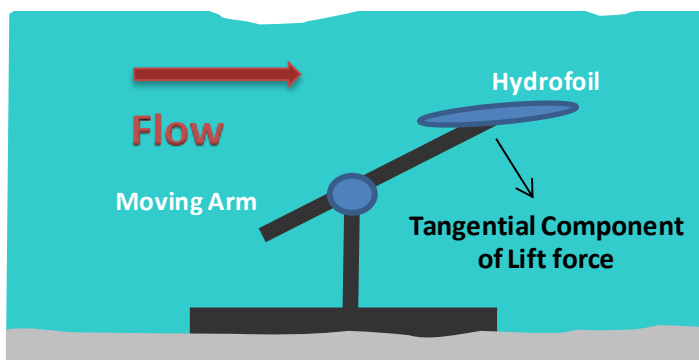

Figure 9: Oscillating Hydrofoil Illustration

2.2.9 Tidal Sail Devices

Tidal sail devices [22] involve a large number of submerged ‘sails’ mechanically connected together and strung across the tidal stream at an angle to the tidal flow. The movement of the flow across the surface area of the sails induces a lift force that moves the sails backwards and forwards. As the sails move, force is transmitted through the connecting wires to a shore-side prime mover and generator. The generator can be driven directly through a mechanical coupling system, or via a hydraulic based prime mover.

2.2.10 Venturi Effect Devices

These devices [23] are generally a variation on horizontal axis tidal turbines. The turbine is shrouded in a structure that focuses the flow towards a central section of tubing in which is housed the turbine. The effect of the funnel-like shroud is to significantly increase the flow velocity across the turbine blades, potentially enhancing the primary capture efficiency.

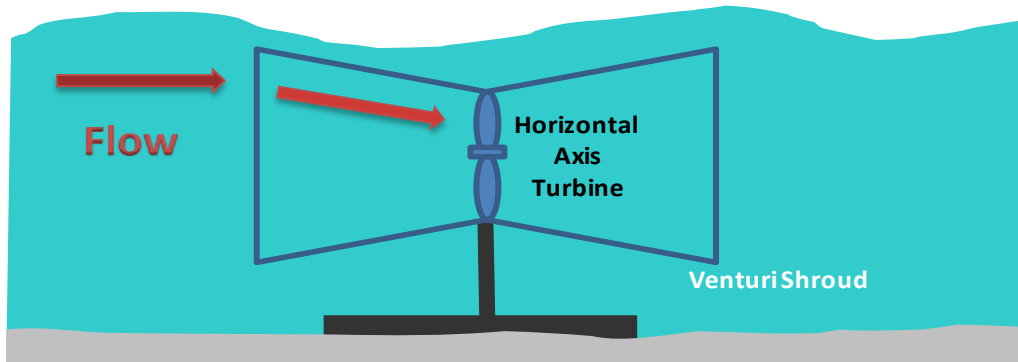

Figure 10: Venturi Effect Device Illustration

2.3 Primary Energy Capture Dynamics

The dynamics of most wave energy devices can be described by considering the device to be an oscillating body. The body is subject to a number of forces which can accelerate or decelerate its oscillations, with the power take-off mechanism being one of these time varying forces. The dynamics of overtopping devices are fundamentally different from the other categories of wave energy devices in that they are not considered to be an oscillating body.

In cases where the system can be represented by an oscillating body, the forces acting on the body can be summed to give an overall equation describing the motion of the device[24]:

$$m\ddot{X} = F_E(t) + F_R(t) + F_H(t) + F_L(t)$$

where m is the mass of the body, and the state variable X represents motion in a given degree of freedom. $F_E(t)$ represents the excitation force on the body due to wave action, $F_R(t)$ represents the radiation force experienced by the body due to its own motion in the water, $F_H(t)$ is the hydrostatic or buoyancy force experienced by the body, and $F_L(t)$ represents the externally applied load forces due to power take-off or constraints such as mooring forces.

This equation can be expressed in the following form:

$$m + A \ddot{X} + B \dot{X} + CX = F_e(t) + F_L(X, \dot{X}, t)$$

where A represents the added mass of the body in water, B represents the radiation damping coefficient and C represents the hydrostatic stiffness coefficient. This is analogous to a spring-mass-damper system as shown in Figure 11 where the power take off force is represented in a simplified fashion as a damper with damping coefficient D.

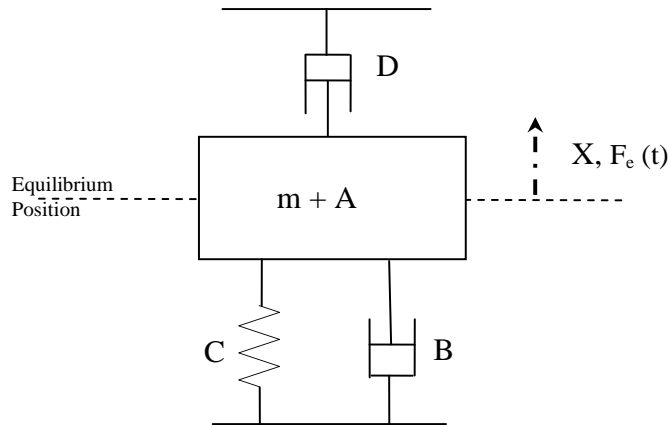

Figure 11: Spring-mass-damper System

The dynamic response of the primary energy capture of wave energy devices is thus typically a function of both wave amplitude and wave frequency, since the oscillating system will have a frequency dependent response curve. Since the power take-off is dependent on device motions (in oscillating systems), the power output will have similar frequency dependence. This frequency curve, when superimposed on the spectrum of the sea-state will give an indication of the power output.

In reality, wave energy devices will usually have motions in several degrees of freedom. Determining the dynamic coefficients of the device in each degree of freedom is a daunting task and is likely too complex to implement in a grid connection dynamic model. Moreover, implementation of a generic model is likely to be impossible using this approach. A simplified method of determining the dynamic response of the primary power capture stage is required. An approximation of the spectral response based on available test data may be the best approach.

Even though overtopping devices are, to a first order, not oscillating systems, their capture efficiency is still dependent somewhat on wave frequency as well as amplitude. Again, determining the efficiency and spectral response in the context of a generic model will likely be derived from device test data.

Tidal current device dynamic response is generally related to the tidal stream velocity only. Tidal turbine devices exhibit a response that matches quite closely with that of wind turbines, albeit with different time constants. Higher order blade dynamics can also be considered, particularly in the presence of turbulence, which can be significant in tidal streams.

The efficiency characteristic of the primary energy capture stage is usually the most significant in terms of overall device efficiency. It can be strongly influenced by control action, and it is important to model the impact of control action on primary energy capture performance. The time domain dynamics of this power conversion stage are generally the slowest in the system. In terms of dynamic modelling from grid connection point of view, accurately modelling the time phase shift between the ocean wave elevation time series and the power output time series of this stage is not as important as a reasonable representation of its capture efficiency performance. Time phase shifts become more important when summing power outputs from an array of devices, if the dynamic time phase response of individual devices differs significantly under differing wave input. However, this aspect is outside the scope of this work.

3. PRIME MOVERS

Prime movers convert the output of the primary power capture stage - typically a fluid power - to mechanical power. In the case of tidal turbines the prime mover is also the primary energy capture component and converts the energy in the tidal current directly to mechanical power. In this section, the different classifications of prime mover are described.

3.1 Air Turbines

Air turbines are used to convert air motion into mechanical torque, which drives the electrical generator. To date, air turbines have been used almost exclusively in OWC type devices. Standard unidirectional airflow turbines are not suited for OWCs as the air flow within the air chamber changes direction twice every wave cycle. If a standard turbine was used in an OWC, only energy from one direction could be captured, thus drastically lowering the efficiency of the device. Initially, these conventional turbines were used in early studies – and valves and ducts were used to rectify the flow. This method was quickly phased out when self-rectifying turbines were developed. Three of the most significant bidirectional turbine designs are:

- Wells Turbine
- Dennis-Auld Turbine
- Impulse Turbine

3.1.1 Wells Turbine

The Wells turbine [25] is currently the most common turbine in use in OWCs. It was invented in the late 1970's by Dr Alan Wells in Queens University, Belfast. It is a self-rectifying, axial flow turbine. This turbine utilises a number of symmetrical blades located on a rotor, perpendicular to the air-flow. Due to the symmetrical blades, the alternating air flow drives the rotor in a single direction of rotation.

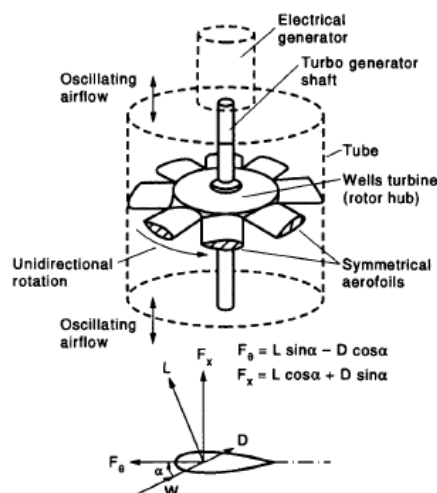

Figure 12: Wells Turbine and Blade Profile [25]

3.1.2 Dennis-Auld Turbine

This turbine is similar to a variable pitch Wells turbine. The blades are located on the periphery of the rotor hub in a neutral position, parallel to the axial direction of the flow rather than tangential to the direction of rotation as in the Wells and Impulse turbines. The Dennis-Auld turbine has a much larger pitching range than the variable pitch Wells turbine, allowing it have a much greater solidity (total blade area divided by turbine swept area) which increases the efficiency of the device.

3.1.3 Impulse Turbine

The impulse turbine [26] is a self-rectifying turbine with an axis of rotation aligned with the direction of an air flow. Air flow within a duct is directed onto the turbine blades using guide vanes. Fixed guide vanes are positioned both sides of the rotor, allowing air flow from two directions to be directed onto the turbine blades. The principle is shown in Figure 13.

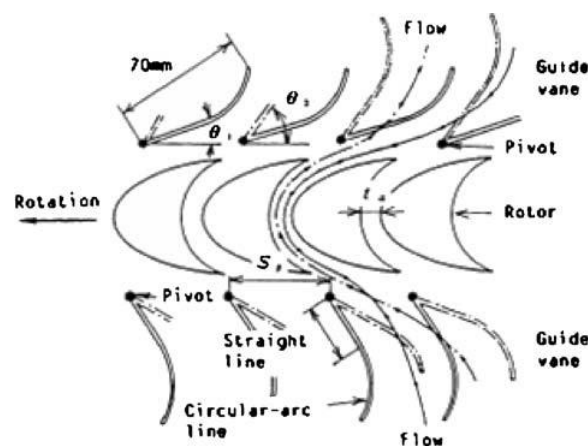

Figure 13: Impulse Turbine[27]

3.2 Hydraulic Motors

A hydraulic motor [28] is a required secondary element in a hydraulic circuit, and is the prime mover of choice in hydraulic power take-off systems. The motor is used to drive a generator at speeds usually in the range of 1000-3000rpm, a standard speed range for off-the-shelf generators. Hydraulic motors are essentially hydraulic pumps in reverse. There are two main types of hydraulic motor – radial piston type and axial piston type.

The radial piston consists of a cylindrical barrel attached to a driven shaft. The barrel contains a number of pistons that oscillate in radial bores. The outer piston ends bear against a thrust ring. Pressure fluid flows through a pintle in the centre of the cylinder barrel to drive the pistons outward. The pistons push against the thrust ring and the reaction forces rotate the barrel. These motors are very efficient and provide high torque at relatively low shaft speeds. However, they do not perform well at high speed and are very costly to manufacture.

Axial motors work on the same principle as radial motors – piston motion is used to rotate the output shaft; the piston motion is now axial rather than radial. Both fixed and variable displacement hydraulic motors can be utilised. A 'swash plate' is used to convert standard axial

motors to variable displacement motors. Axial motors have excellent high speed capabilities, and the bent-axis type motors can greatly improve the low speed capabilities.

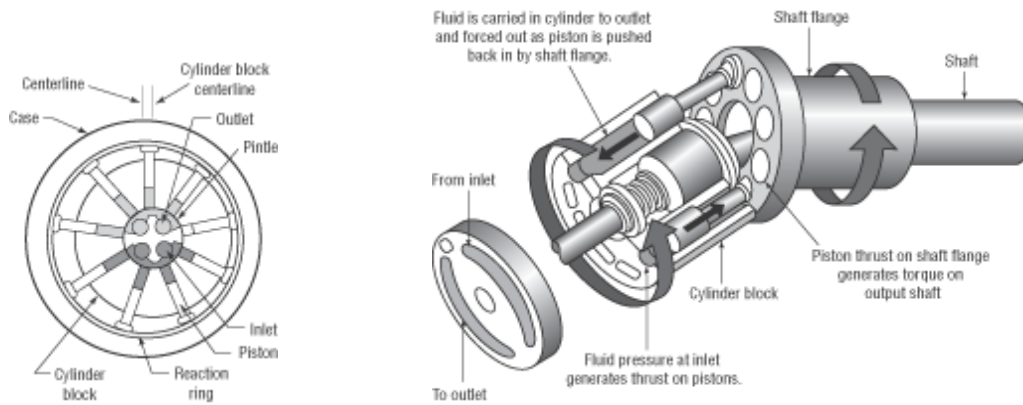

Figure 14: Radial Hydraulic Motor and Axial Hydraulic Motor [29]

3.3 Hydro Turbines

Hydro turbines [30] are used as the prime mover in overtopping type devices, and in other devices that pump water to a shore station reservoir, such as some oscillating wave surge type devices. Water flows from a reservoir through a draft tube and onto the turbine. The technology is well established and has been in use for many years in hydro-power generation plants. There are two main types of hydro turbines – reaction turbines and impulse turbines.

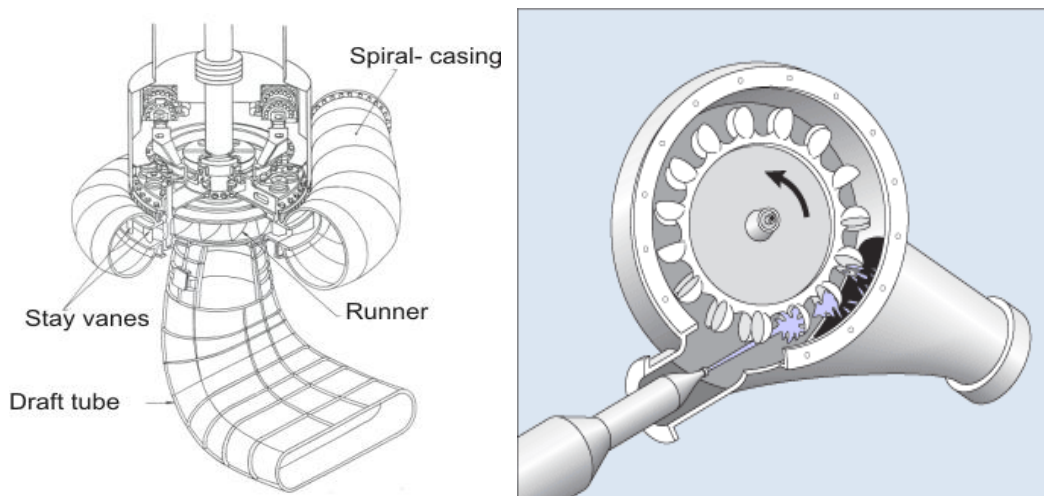

Figure 15: Reaction Turbine [31] and Hydro Impulse Turbine [32]

Reaction turbines are acted on by water, which changes pressure as it moves through the turbine and gives up its energy. They must be encased to contain the water pressure, or they must be fully submerged in the water flow. The two most common types of reaction turbines are the Francis and Kaplan turbines. Francis turbines are suited for high head applications, thus they are not typically suited to ocean energy applications. Kaplan turbines are more suited to ocean energy devices as they can produce highly efficient power output in low head applications. Kaplan turbines are positioned within a scroll case tube. As water flows through the tube the pressure increases, the water is then directed onto the turbine blades causing it to rotate. Water then returns to the sea, through the draft tube.

Impulse turbines extract energy from the change in momentum of a water jet. Water flows at a tangent to the turbine blades. Nozzles direct forceful streams of water against the blades. The blades are curved buckets mounted around the edge of the wheel. The inside of the bucket faces the incoming jet of water. The buckets are curved to allow the jet of water to change direction on impact. The momentum of the water jet is transferred to the turbine, and the turbine rotates. The most common type of impulse turbine is the Pelton Wheel. These turbines are very efficient in high head and low flow applications. Therefore, they may not be suited to overtopping type devices but may be suitable for pumping type prime movers such as oscillating wave surge devices.

3.4 Direct Mechanical Drive

The drive shaft of the generator can be directly connected to the prime mover via mechanical linkages such as belts, pulleys, gearboxes and clutch mechanisms. In this case the prime mover can be understood as the mechanical connection 'system' between the prime mover, and the rotating generator shaft. This type of prime mover [33] is suited to point absorber type wave energy devices.

An example of such a prime mover is illustrated in Figure 16. As the wave height falls, the displacer of the prime mover descends. This motion accelerates the rotational speed of the drive shaft on the displacer side. A gear-box connected to this shaft increases the rotational speed of the shaft on the generator side. Electrical power can then be extracted. As the wave height rises, the displacer ascends. A clutch is used to disengage the displacer side drive shaft from the generator side drive shaft. The inertia of the generator drive shaft allows the device to produce power during this period of displacer ascent, but at a rapidly decreasing rate. The clutch then re-engages both shafts when the displacer begins ascending again.

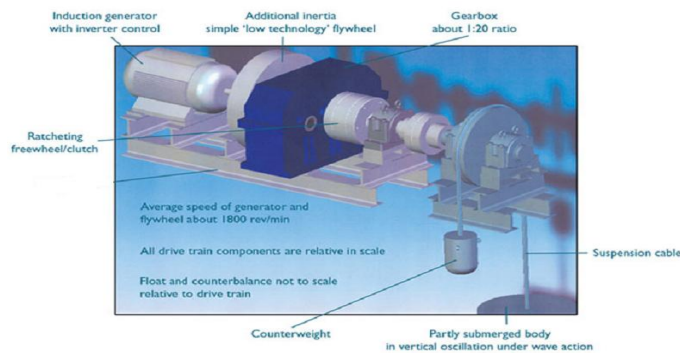

Figure 16: Manchester Bobber Drive Train[33]

This type of mechanism can be inefficient as maximum power can effectively only be extracted for half of a wave period. Also the rapidly changing wave climate will create large torques on the drive train, resulting in potential operation and maintenance problems.

3.5 Prime Mover Dynamics

From a dynamic point of view, prime movers can be generally seen as a power conversion stage between the low speed, high force primary PTO component and the high speed, lower force/torque generator, although this is not always the case in that low speed generators are

sometimes used. The operating point of the prime mover can be significant in terms of system efficiency. Consequently, maintaining the prime mover at an optimum operating point through the changing regime of the input energy variation can often be one of the chief system control objectives. The prime mover is also typically responsible for a significant conversion power loss, and this must be accounted for in a dynamic model. This conversion efficiency is generally highly operating-point dependent, and thus represents a significant non-linearity in the system.

The time domain dynamics of the prime mover tend to be dominated by mechanical inertia. This is usually collated with generator and other mechanical element inertia, into a lumped mechanical model. Typically, turbine-based prime movers will have significantly higher inertia than hydraulic motor based prime movers, and are more amenable to added inertia being built into the system if required. The prime mover dynamic response can thus be generally represented by the first order differential equation of rotational motion:

$$2H_m \frac{d\omega}{dt} + B_m \omega = T_m(\omega, X) - T_{gen}$$

where H_m is the total inertia constant of the rotating system, B_m is the coefficient of mechanical friction, and T_m is the mechanical torque output of the prime mover. This is typically itself a function of rotational speed and any device motions X , as the instantaneous efficiency of the prime mover is generally highly dependent on system operating point. T_{gen} is the generator electromagnetic torque, which is usually determined by the system controller. Where prime mover motion is linear, the corresponding linear motion terms can be used in the equation. Where gearboxes are present in the system, the rotational equation can be expanded to a full two mass rotating shaft model [7].

The dynamics of PTO fluids (air, water, oil) tend to be an order of magnitude faster and can be approximated as instantaneous, or as a first order time lag. Second order effects such as fluid flow hysteresis and directional asymmetry can usually be neglected.

The characterisation of the prime mover is difficult to accomplish in a generic manner, as again there are several different types of prime mover. It is relatively straightforward to assign a typical inertia figure or range to a given prime mover type, however, characterising the power conversion efficiency and consequently the mechanical torque output is more difficult due to the differing physical processes at work in different technologies. As in the case of primary power capture, the best approach may be to derive a set of efficiency or equivalent performance curves from developer test data or provided manufacturer data that can be utilised within the model in a generic manner.

In the case of electrical network faults, the mechanical inertia of the prime mover system generally dominates the acceleration response of the device. Control action may also be taken in adjusting the prime mover operating point in order to limit acceleration during a fault condition.

4. GENERATORS AND POWER ELECTRONICS CONVERTERS

The generator is a device common to all ocean energy devices. It is required to convert the mechanical energy, produced by the prime mover, into electrical energy for supply to the electrical power grid. The vast majority of generators are rotary, although linear generators are currently being developed for some wave energy devices. The generator machine types considered in this section are:

- Synchronous Generators
- Induction Generators
- Linear Generators

It is important that the output from the generator complies with the national grid codes [5, 34] as set out by the transmissions systems operator (TSO). These grid codes include the provisions that voltage and frequency variation is kept to a minimum, and that there is suitable operation during electrical faults.

4.1 Power Electronics Converters

Integral to both generator operation and grid connection are power electronics converters [35, 36] which are often connected between the generator terminals and the grid, particularly in renewable power generation systems. These converters enable wide ranging speed control of the generator. This can impact the entire device operation in that the generator speed is usually linked to the prime mover speed, which in turn will have some effect on the damping of the primary power capture stage and its consequent power production performance [36]. They also fulfil an important functionality in controlling fault current to the grid, regulating reactive power flow, and enabling low voltage ride-through of the generator system.

Some generator types such as linear generators in wave energy cannot be connected to the electricity network without power electronics converters, since the power produced by the generator is inherently varying in frequency and voltage. A power converter is required to interface between the fixed voltage-frequency interface of the electricity grid and the variable frequency-voltage characteristic of the generator.

Conceptually, the power electronics can be considered either as an integral part of the generator system or as a separate grid connection control block.

4.2 Synchronous Generators

Three-phase synchronous generators [37] are the generator of choice in the vast majority of conventional power plants. They operate in synchronism with the electricity grid. The armature windings of the generator, which are located in the stator, are connected directly to the electrical grid. The rotor can be a permanent magnet or a wound rotor electromagnet. The wound rotor has an exciter field generated by DC current flowing through its windings. The DC

current is provided from rectified AC current supplied from the grid. This exciter field rotates at synchronous speed. The exciter field can also be generated using a permanent magnet. Permanent magnet machines have the advantage of being self-exciting and thus more efficient as they do not require an external energy supply. However, the magnetic materials are expensive and they tend to lose their magnetic capabilities in strong magnetic fields over time.

Torque is applied to the rotor from the prime mover, creating a change in the magnetic field flux, thus inducing a current in the stator windings and a corresponding counter-torque in the generator. The electrical power generated is directly proportional to the applied torque, but the generator will still run at the same speed dictated by the frequency of the electrical grid.

Since the speed of a synchronous generator is fixed to the grid frequency, the rotational speed of the prime mover is essentially fixed also. This can represent a significant drawback for the use of synchronous generators in wave and tidal energy conversion. The frequency of the grid in Europe is 50Hz, this equates to 3000rpm for a two pole generator. A gearbox can be installed to bring the speed of the drive shaft (between the prime mover and the generator) closer to the generator speed. The number of poles on the rotor can also be increased to reduce the speed of the generator. However, increasing the amount of poles will also increase the size of the machine. Regardless, due to the varying nature of wave and tidal power, large torque variations will be produced on the drive shaft particularly in wave energy applications, unless significant energy storage is present in the device. Another potentially more serious drawback of this fixed speed generator option is the lack of flexibility in adjusting both the prime mover operating point and the damping applied to the primary energy conversion stage.

To overcome this problem, synchronous generators can be connected to the grid through a power electronic frequency converter, as mentioned previously. This allows the frequency of the AC current in the stator of the generator to be controlled; and therefore a variable speed prime mover can be connected to the generator. This enables more efficient power take-off and prime mover operation.

4.3 Asynchronous (Induction) Generators

Asynchronous, or induction, generators [37] are used widely in renewable energy applications. Asynchronous generators typically consist of cage type rotors, contained within a stator. The stator is connected to the electrical grid. The rotor magnetic field is provided via electromagnetic induction from the stator magnetic field.

The construction of asynchronous generators is less complicated than that of synchronous generators. Asynchronous generators require no brushes and are extremely rugged and reliable in operation. When directly connected to the electricity grid their speed of operation is only synchronous with the grid frequency under zero power input. The application of shaft torque from the prime mover moves the speed to a speed slightly higher than synchronous speed. This has the advantage of providing a certain amount of compliance in the mechanical response of the system and consequently reducing the torque stresses. However, in terms of prime mover and device operating point control, it is still essentially a fixed speed solution, as the speed range is generally only within about 5% of synchronous speed.

When connected to the electricity grid through a power electronics converter, the speed of the generator can be allowed to vary with the speed of the prime mover, again enhancing power take-off and prime mover performance. The cost and performance of an asynchronous generator is generally more attractive than the alternative systems using a synchronous generator, with somewhat reduced efficiency [38].

There are other configurations of induction generators which can be used also, including the wound rotor induction generator and the doubly fed induction generator.

4.4 Linear Generators

Linear generators [16] previously had little use in industry. There are few applications that require conversion of linear mechanical power to electrical power. Most traditional power conversion methods, such as coal, gas, nuclear, hydro power station and, more recently wind turbines; all use a rotating turbine and thus require a rotating generator. The recent growth in development in wave energy devices, particularly point absorber type devices, has led to a requirement for linear generators.

As described in Section 2.2, both the point absorber and the submerged pressure vessel type devices oscillate in a heaving motion. A linear generator can be utilised to convert this linear, heaving motion of the device directly into electrical energy. A device using a linear generator is known as a direct drive device, as the motion of the device is used to directly drive a generator i.e. no ancillary components are required (hydraulics, pneumatics, turbines etc).

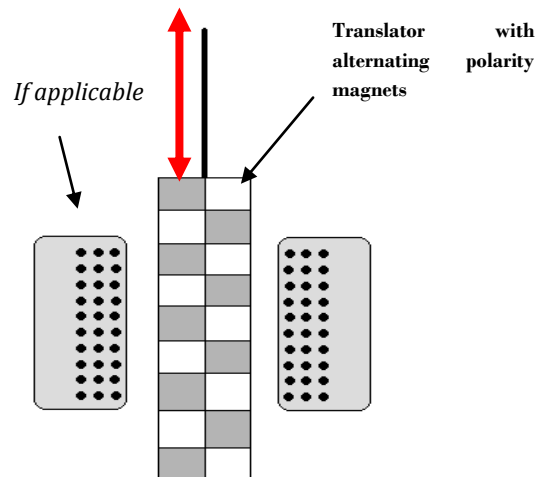

Figure 17: Linear Generator[39]

Linear generators operate using the same principle as conventional generators - voltage is induced in the stator due to a changing magnetic flux from translator motion, and current flows in the stator windings to oppose torque applied to the translator (the moving component). In a linear generator, magnets of alternating polarity are mounted on the translator. The translator moves linearly next to a stationary stator that contains the armature windings. A magnetic field exists within an air gap between the translator and stator. As the translator moves, this magnetic field changes and, as per Faraday's Law, this change in magnetic field induces a voltage in the stator windings. This configuration is depicted in Figure 17.

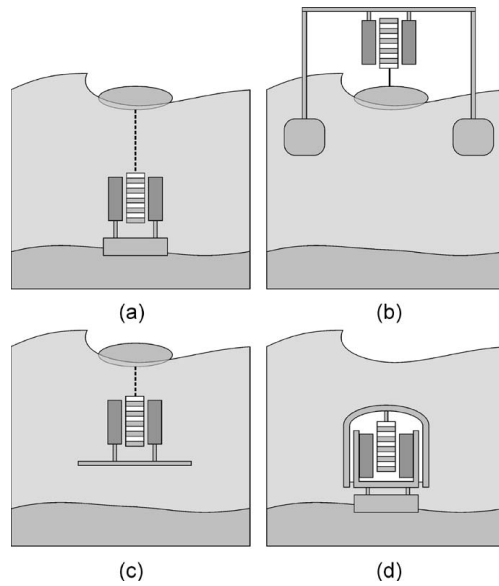

Figure 18: Linear Generator Configurations[16]

In wave energy devices, linear generators typically operate at high peak forces and low speed. The generator can be configured in a number of ways, including those shown in Figure 18. There are many challenges in implementing linear generator technology - construction of a generator with the required, small, air gap is quite difficult due to manufacturing tolerances and also the large attractive forces between the translator and stator can further complicate construction. Also, because of the irregular motion and varying speed of the translator, direct connection to the grid is not possible; power electronics converters are an absolute requirement.

4.5 Generator and Power Converter Dynamics

From a dynamic point of view, generators represent a distinct power conversion stage from mechanical input to electrical output. This power conversion step has a power loss associated with it, but by and large this stage has the highest conversion efficiency. Generator operation is typically closely coupled to the dynamics of the mechanical system, and is both influenced by it in terms of dynamic response, and also influences it. In many devices, the generator is the main control actuator in the system, and control actions in the generator can be used to directly influence the prime mover operating point, as well as the primary energy storage damping.

The time domain dynamics of generators are generally the fastest in the system. If a power electronics converter control is included in the generator system, the dynamics of the generator stator current response is usually regarded as dynamically instantaneous under normal operating conditions. Rotor flux dynamics typically have the slowest response characteristic, and can be included [40], particularly in fault studies where the electrical response of the generator flux can be important.

In considering network faults, the dynamic model of the generator, as well as its coupling into the mechanical system is of major importance, and dominates the fault response of the system. The ability to sustain fault current or to provide reactive power output during a fault is a direct

function of generator response and control, and that of its associated power electronics converters.

5. ENERGY STORAGE

Energy storage can be a very useful feature in ocean energy applications. Due to the highly varying nature of the resource, particularly the wave resource, designing a device that can deliver a relatively constant electrical power output at an optimum efficiency is an onerous task. Large scale electrical storage would be an ideal scenario as devices could store the varying power produced, and supply it to the electricity grid at a constant rate when required. This would not only improve the efficiency of the device but it would also enable grid code requirements to be met with greater ease. The injection of a rapidly varying power output into a weak electricity network can result in significant voltage deviation that may be in danger of breaching grid code requirements.

However, although the technology for large scale electrical storage currently exists it is extremely expensive and its use would render most ocean energy projects uneconomical. Despite this, developers continue to investigate other methods for some form of energy storage for their devices.

There are a number of wave energy devices that inherently contain energy storage methods. The most obvious is the overtopping device – this contains a reservoir which is essentially a large storage tank for potential energy. The reservoir is often an integral part of these devices, so it does not cost an energy loss to include this storage method. Also, devices containing an accumulator within a hydraulic circuit are inherently capable of storing energy, although, generally only relatively small amounts of energy can be stored within accumulators. Furthermore, energy is released over a relatively short periods of time. This factor means that accumulators are not good for long term energy storage, but can be used short term to reduce power fluctuations in the hydraulic circuit.

It is also worth noting that rotating turbines in both tidal and wave devices can contain significant mechanical inertia which is effectively a form of energy storage. When power to the turbine is reduced, the inertia of the turbine will maintain rotation for a short period of time. This can assist in reducing power fluctuations and in maintaining a turbine operating point but, again, cannot store large amounts of energy.

Devices without inherent energy storage are reliant on conventional energy storage techniques. These include compressed air storage, hydrogen storage, super capacitors, batteries (including flow batteries and fuel cells) and flywheels. These options all have their own advantages and limitations [41].

5.1 Energy Storage Dynamics

Energy storage can significantly modify the dynamics of a device and it is important that it is included in the dynamic model of the device. In general, it can be seen as having a low pass filtering effect in the power train, smoothing power fluctuations. It may also have a ‘charge-

discharge' loss component associated with it and depending on the magnitude of this loss component it may be important to model this.

Energy storage can also be an important focus of device control action, which can be applied to seek to maintain a device operating point, or to limit output power fluctuations, or a combination of both goals.

Under grid fault conditions, energy storage can play an important role, as it can assist in limiting the acceleration of the prime mover, and in general provide an energy sink for the power input.

6. CONTROL

It is clear from the preceding sections that control overlaps and influences most of the power conversion stages. Effective control strategies are used to optimise the power output under different input conditions, reduce the variability of the exported power, and protect the device in severe wave climates, or under faulted conditions.

Some wave energy devices can adjust their physical properties to tune their natural frequency to match the dominant wave frequency (sea-state control), other devices can tune the instantaneous motion of the device to optimise power take-off for each wave (wave-to-wave control) [15, 24, 42-44]. Most devices have some form of both of these control techniques. Devices that cannot employ either strategy are known as fixed tuning devices and tend to be less efficient than other, more controlled, devices.

In tidal devices, a similar matching can be applied between the tidal velocity and the primary energy capture in order to optimise power take-off. In similar fashion, this control can be applied to match the device to the average tidal velocity or to the instantaneous flow conditions.

6.1 'Fast' Tuning Control

Devices employing this strategy are controlled based on real-time sea or tidal conditions. The system controller tunes the motion, attack angle, or rotational speed of the device to the immediate wave amplitude or tidal velocity variation.

This control action can take a number of forms, depending on the device. For instance, a wave energy device utilising a hydraulic circuit PTO could apply a force on the hydraulic cylinders to optimise the motion of the device with respect to the instantaneous wave elevation. In the case of an OWC, for example, pressure valves can be used to optimise the instantaneous pressure variation within the air chamber. If a variable speed air turbine is used in the OWC, the control action could involve optimising the speed of the turbine for the incoming instantaneous air flow variation[45]. The turbine speed is reduced/increased by increasing/reducing the generator load torque, respectively. The time it takes to accomplish this is dependent on the inertia of the system. If the generator load torque is reduced to zero, and an increased turbine speed is required, a positive torque is necessary which means drawing power from the grid, which reduces the system's efficiency. The 'fast' control of angle of attack in a tidal sail or hydrofoil, or rotational speed in the case of a tidal turbine are analogous to these examples. Some of these 'fast' control strategies require power import at certain points in time, and this must be accounted for in a dynamic model in terms of overall power balance.

Note that for this type of control strategy, timing is critical- both the time the control action is applied and the time taken for the system to reach the desired state determine the effectiveness of this control strategy. If the control force is applied at the wrong time, or the system takes too long to respond, the control action can lead to a non-optimal or even reduced efficiency system.

6.2 'Slow' Tuning Control

This control strategy is based on time-averaged sea or tidal flow conditions, rather than the instantaneous control strategy. For a given sea state or tidal flow regime, the control variables within the device are tuned to that averaged operating point. They do not change again until the sea state or average tidal flow velocity changes. Slow tuning allows the device to be better matched to the resource over more time than is possible with fixed tuning. It therefore allows more energy to be captured in the long term.

The sea state or average tidal velocity changes much less frequently than individual waves or instantaneous flow velocity. As a result of this, the control variables in devices employing this strategy, change less frequently than in fast control. The speed of the control system and the dynamic response time of the system to control action are therefore not as critical. This makes slow control less susceptible to the problems associated with fast control. However, by only tuning the device to a sea state or average flow velocity, rather than to the instantaneous conditions, the power take-off is non-optimal for a significant portion of the instantaneous wave cycle or tidal flow velocity.

In wave energy devices, this strategy can involve adjusting the resonant frequency of the device [46], through variable ballasting, or, similarly to a tidal turbine, changing the average speed of a high inertia prime mover.

7. GENERIC MODEL OUTLINE AND CHARACTERISATION

As a result of the device survey outlined in the previous sections, an outline generic dynamic model structure is proposed for wave and tidal devices. This is illustrated in Figure 19. The solid arrows represent dynamic power flow, whereas the broken arrows represent control actions applied to the various elements of the model.

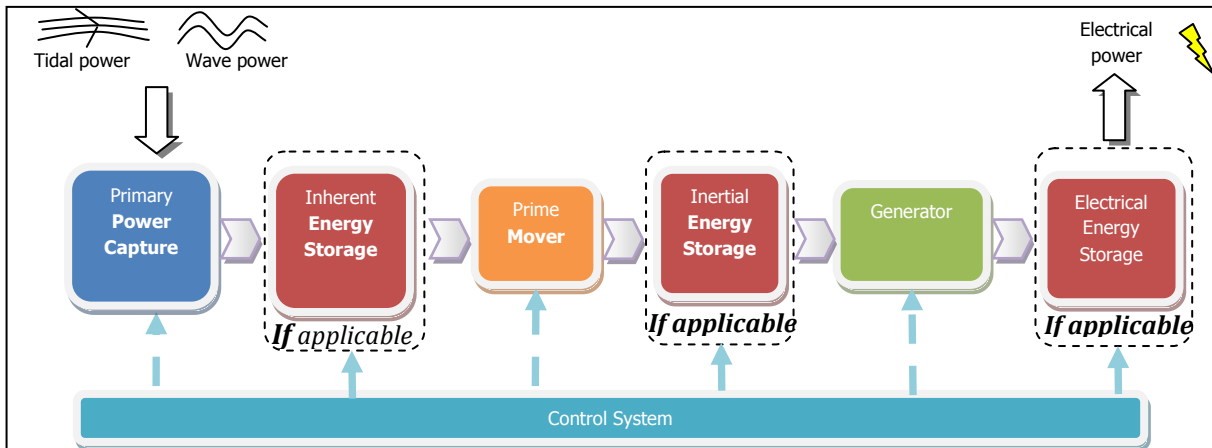

Figure 19: Colour Coded Model Reference

In the case of direct-drive systems, the primary power capture stage and the prime mover stage are merged and the inherent storage stage is suppressed from the energy conversion chain, as shown in Figure 20.

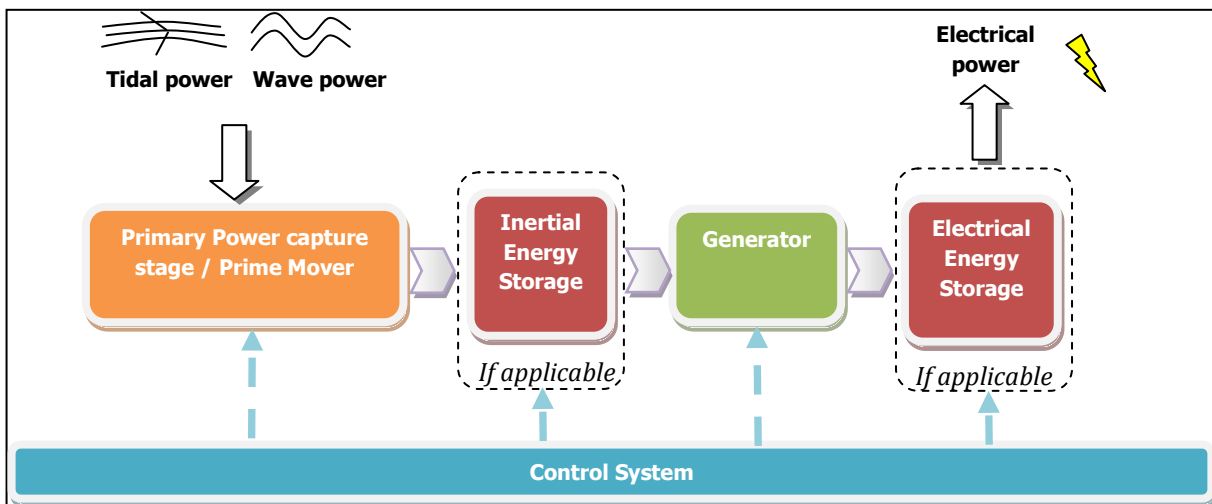

Figure 20: Colour Coded Model Reference (direct-drive systems)

A matrix of the different device classifications, coupled with their corresponding, colour coded, dynamic model blocks, is depicted in Table 2. Example components of each of the model blocks, corresponding to a particular device classification are also given.

Table 2 - Example components, for each device category, at each stage of the conversion process

| | Primary Power Capture | Storage | Prime Mover | Generators |
|---------------------------------------|------------------------------------|-------------|-------------------|---|
| Wave | | | | Squirrel Cage Induction PMSM DFIG Custom Linear Generator |
| Attenuator | Hydraulic Ram | Accumulator | Hydraulic Motor | |
| OWC | Pneumatic Chamber | Flywheel | Air Turbine | |
| Point Absorber | Hydraulic Ram(s) | Accumulator | Hydraulic Motor | |
| | | | Linear Translator | |
| Submerged Point Absorber | Hydraulic Ram(s) | Accumulator | Hydraulic Motor | |
| | | | Linear Translator | |
| Overtopping | Hydro power available in reservoir | Reservoir | Hydro Turbine | |
| Submerged Wave Surge Converter | Hydraulic Ram(s) | Accumulator | Hydraulic Motor | |
| | | Reservoir | Hydro Turbine | |
| | | | | |
| Tidal | | | | |
| Horizontal Axis Turbine | | | Turbine | |
| Vertical Axis Turbine | | | Turbine | |
| Oscillating Hydrofoil | Hydraulic Ram (if applicable) | Accumulator | Hydraulic Motor | |
| | | Reservoir | Hydro Turbine | |
| Venturi Effect Device | | | Turbine | |
| Tidal Sail Device | Hydraulic Ram | Accumulator | Hydraulic Motor | |

The principal dynamic characteristics of importance in a grid connection model of each conversion stage are outlined in Table 3.

Table 3 - Dynamic characteristics of each conversion stage

| | Primary Power Capture | Inherent Storage | Inertial Storage | Prime Mover | Generator |
|--------------------------------|---|--|---|---|--|
| Conversion Efficiency | Lowest efficiency – heavily influenced by control | High efficiency | High efficiency | Medium efficiency– influenced by control | Highest efficiency |
| Dynamic Characteristics | Strongly coupled to physical design of the device. | Filters power fluctuations. | Filters power fluctuations. Strongly coupled to prime mover and generator operating points. | Mechanical model strongly influences system dynamics. | Fast dynamic response. |
| Control Aspects | Can be modified by control for closer matching to resource conditions | Provides a measure of decoupling between primary power capture and output power control. | Has a significant effect on the ‘speed’ of the prime mover control that can be applied. | Operating point control strongly influences efficiency | Often the main controlling element. |
| Fault Operation | Can provide a means of energy spill during faults | Provides an energy buffer during faults – an important function | Limits acceleration rate during faults | Can be the limiting component due to rapid acceleration during faults | Ability to sustain fault current and provide reactive power during a fault is critical |

Several options for the mathematical and modelling implementation of the dynamic elements within each block have been considered. Clearly, a fully descriptive and exact dynamic model would require much of the following information, and more:

- Hydrodynamic coefficients in all degrees of freedom
- Hydrodynamic and thermodynamic models of the primary power capture stage
- Full geometric device information
- Prime mover dynamic pressure and flow characteristics
- Full knowledge of control strategy

It is most unlikely that such information will be available either from developers, or even within the capability of some developers. It is much more likely that empirical information, test results, and characteristic curves will be available. It is recommended that the implementation of the generic model be based on this level of information.

An ocean energy device developer questionnaire has been constructed around this generic model structure with a specific goal of identifying the characterisation information available from developers. The results of this questionnaire and some recommendations for the construction and parameterisation of such a generic dynamic model are outlined in this chapter and the following. The exact implementation will be dependent on the feedback received from developers on what information they will have the ability to provide. This approach is embodied in the questionnaire that has been devised for device developers. Developers are not being asked to provide information, rather *which information they would have the ability to provide*.

The questionnaire was circulated to the main wave and tidal energy device developers globally with the assistance of other members of the Annex Working Group. There were 17 respondents from approximately 50 questionnaires, yielding a respectable 34% response rate..

A follow-on developer survey was launched one year after the first edition to obtain a better understanding of the control means and strategies of ocean energy converters. The “Control” section of this report describes the results of this second survey in which 35 developers took part (22 wave energy converters and 13 tidal devices). Similarly to the first edition, questionnaires were received from various countries and regions including Europe, Canada, the USA, Australia and Russia. The device sample of the second survey has characteristics similar to those of the first survey sample, hence confirming the results and conclusions of the previous edition.

Several companies indicated that they would like to respond at a future date, but that their technology was not yet at a development stage where a response was possible.

The questionnaire was broken up into several sections:

1. Overall
2. Primary Power Capture
3. Energy Storage
4. Prime Mover
5. Generator
6. Control

The results of the questionnaire are subdivided into the corresponding questionnaire sections, with appropriate conclusions for the dynamic model provided for each section.

7.1 ‘Overall’ Section

The first section of the questionnaire addresses the overall device categorisation, its sensitivity to wave direction (if a wave energy device), and the ability of the developer to provide a power map or power curve. The abbreviations used in the graphing of the results from this section are:

- A Attenuator
- HAT Horizontal Axis Turbine

- OT Overtopping Device
- OWC Oscillating Water Column
- PA Point Absorber
- SWSC Submerged Wave Surge Converter
- SPD Submerged Pressure Differential
- VAT Vertical Axis Turbine

The breakdown of the respondents is illustrated in Figure 21. As expected the majority of respondents were wave energy developers.

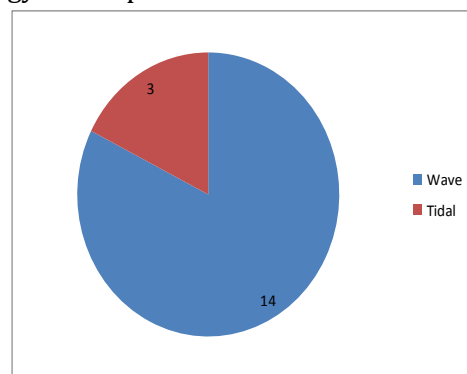

Figure 21: Device Categories by Resource

The categorisation of these devices according to primary power take-off mechanism is shown in Figure 22, employing the device categorisation developed in the associated report – “*Device Classification and Dynamic Structure*”. The same colour coding for wave and tidal as in Figure 21 is observed.

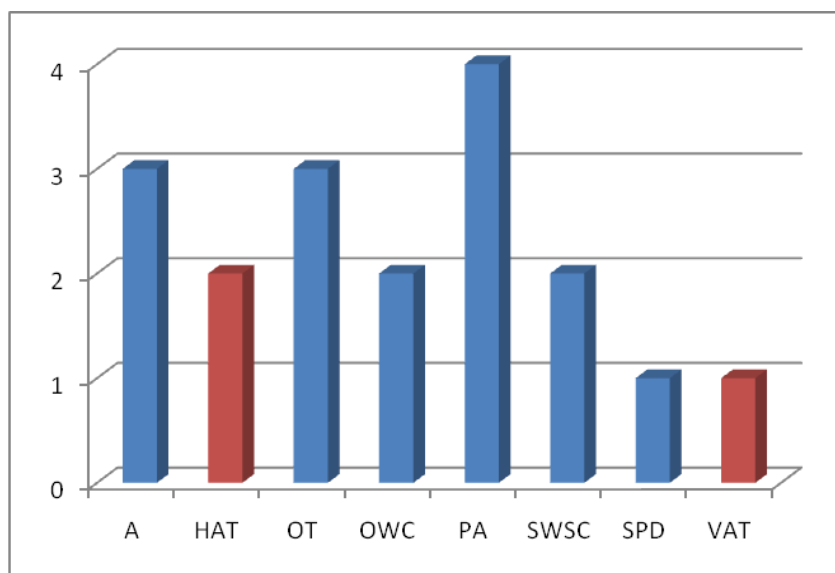

Figure 22: Device Categorization

The ability of developers to provide a power map (wave) or power curve (tidal stream) is depicted in Figure 23. This question provides an indication of the maturity of the technology development data in the survey. It can also provide for a ‘cross-check’ of the dynamic model power output against the developer power maps.

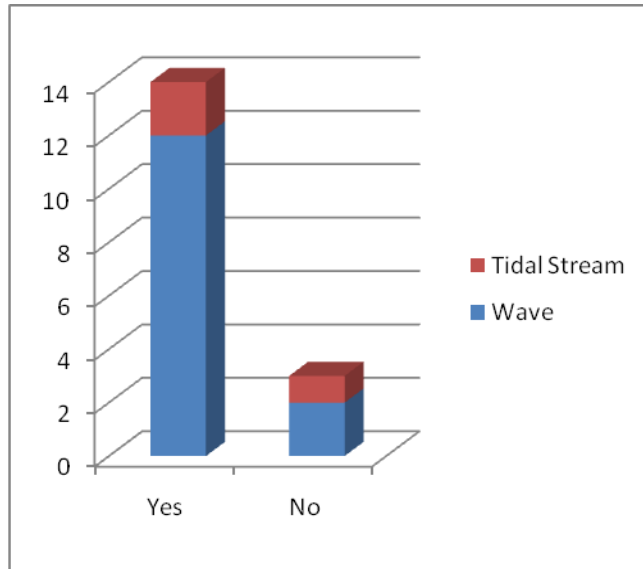

Figure 23: Ability to Provide a Power Matrix/Curve

The effect of the directionality of the resource input on the power output is illustrated in Figure 24 and Figure 25. Yes- and Yes+ refer to the level of sensitivity (i.e. minor or significant).

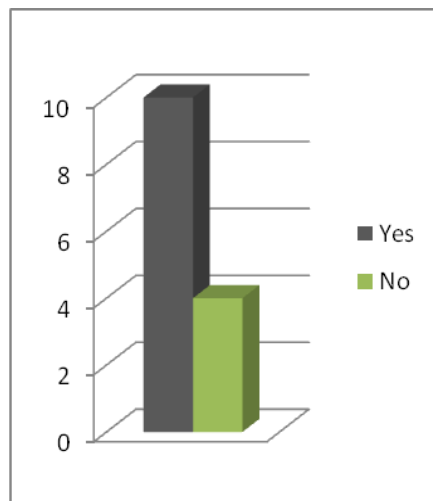

Figure 24: Self-Alignment Capability for Wave Energy Devices

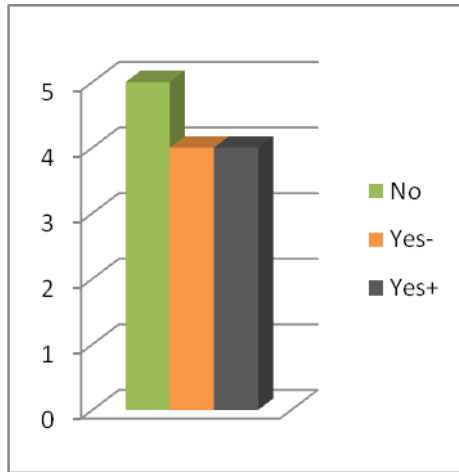

Figure 25: Directional Sensitivity of the Power Take-Off (Wave Energy Devices Only)

From these it can be seen that although the majority of devices have some directional sensitivity, the majority also have some means of self alignment with the prevailing wave direction. If this is the case then the net directional sensitivity of the power output from a modelling point of view is zero. This is summarized in Figure 26. A small number of the devices surveyed are dependent on resource direction and do not have a self-alignment mechanism.

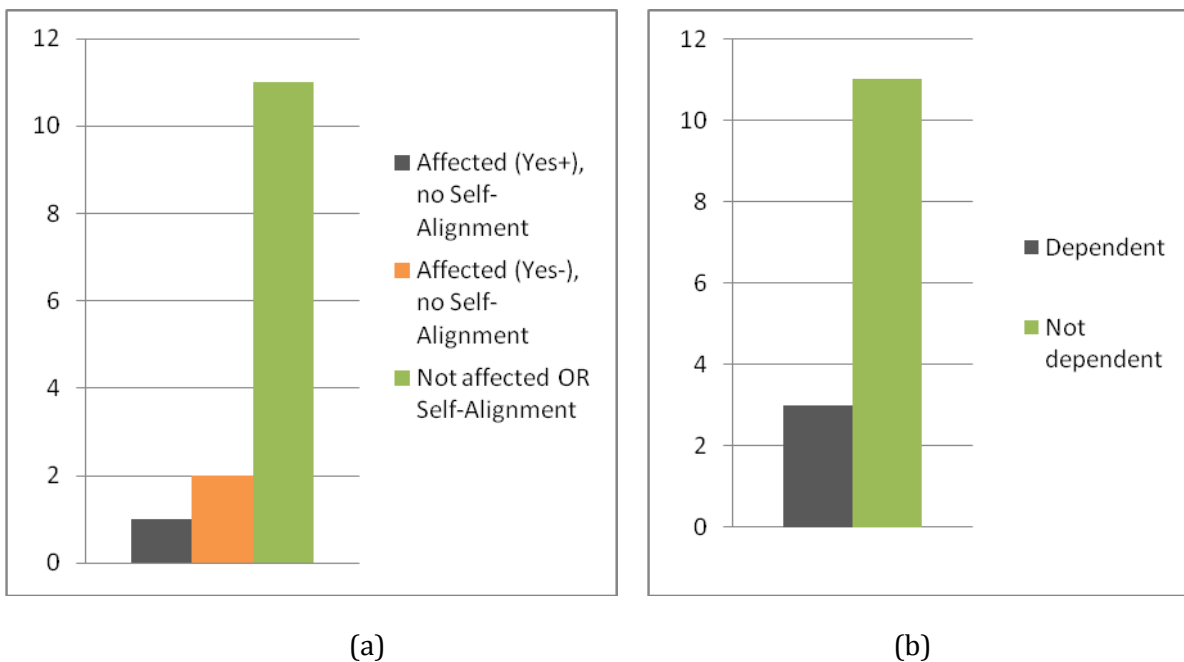

Figure 26: Summary of Directional Dependence of PTO (Wave Energy Devices Only)

7.1.1 Conclusions from 'Overall' section

As expected the majority of devices in the survey are wave energy converters. It is noticeable in Figure 21 that no device category dominates the field. The point absorber design is marginally in the majority. Although the number of questionnaires is relatively small, this is probably a fair reflection of the reality in the field.

The majority of devices either align themselves to the wave direction or are not affected by it if they do not align. This is an important result from a dynamic modelling point of view as it

implies that it may not be necessary to specify directional components of the wave elevation input in the model.

For devices where this is not the case it could be specified that the modelling is valid only under particular directional conditions.

7.2 'Primary Power Capture' Section

The abbreviations utilized in the graphs in this section are:

| | |
|-------|---|
| GYR | Gyroscopic |
| HAT | Horizontal Axis Turbine |
| HR | Hydraulic Ram |
| PC | Pneumatic Chamber |
| OT | Overtopping Device |
| RB | Rubber Bulge Tube |
| VAT | Vertical Axis Turbine |
| YY | Yo-yo system (ropes linked to a windlass) |
| TS | Primary power capture time series output |
| PAN | Panchromatic |
| MON | Monochromatic |
| FF | Fluid flow time series |
| FP | Fluid pressure time series |
| PCEff | Primary power capture efficiency |
| PCTS | Primary power capture output for a range of tidal flows |
| WW | Wave to wave |
| WG | Wave group |
| SS | Sea State |

Developers were asked to describe their primary power capture technique. The device primary power capture methods as described by the developers of non-direct-drive systems are graphed in Figure 27. The results related to direct-drive systems are treated in the "Prime mover" section, as for this type of device, the primary power capture stage and the prime mover stage are indistinguishable. In this survey, 12 of the 13 tidal devices were direct-drive systems. Hence, the results described in this section are only related to wave energy converters. Among them, the hydraulic ram is the most common technique followed by pneumatic chambers and overtopping reservoirs.

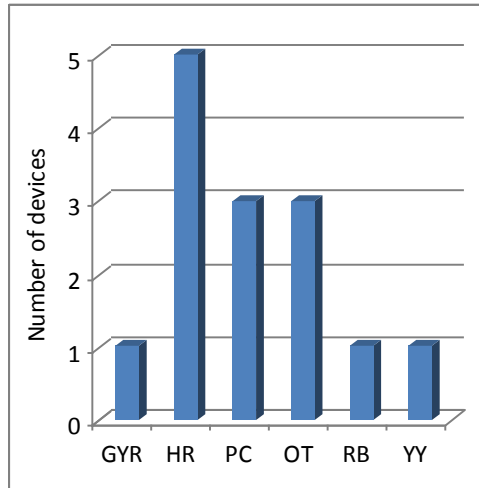

Figure 27: Primary Power Capture Type

In Figure 28, the linearity of response to the changing resource is shown. The abbreviations HL, QL, QNL, HNL refer respectively to highly-linear, quite linear, quite non linear, highly non linear.

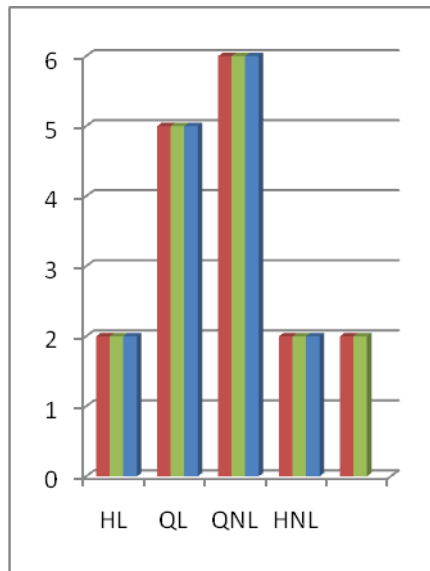

Figure 28: Linearity of Device Response to Changing Wave Height or Tidal Flow Speed

The data available from developers by which they characterize their devices are key to the dynamic model development approach. The results in this regard are plotted in Figure 29. The majority of developers utilize time series data of some description rather than efficiency curves for characterizing the primary power capture stage. Panchromatic data is used more commonly than monochromatic time series data, and the output of the primary power capture stage is characterized more often in terms of power than fluid flow or pressure, although it is probably a good assumption that one of these variables would require measurement in order to assess the output power of this conversion stage.

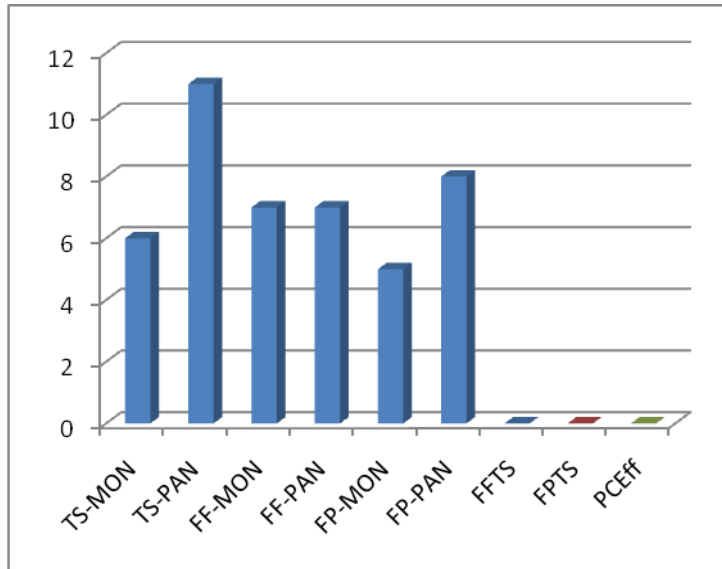

Figure 29: Characterisation Parameters (for both Wave and Tidal Stream Devices)

The graph also indicates that a slight majority utilise characterization data at a number of discrete tuned states, or damping levels, of operation. The dynamics of the primary power capture tune-ability are assessed in Figure 30 for wave energy devices. The majority of devices are tuned to the slow changing sea state – the remaining respondents tune either wave to wave or by wave group.

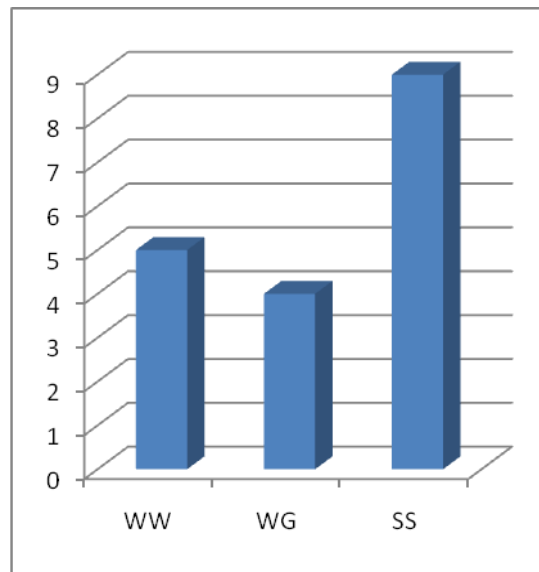

Figure 30: Tune-Ability Timeframes (for Wave Devices Only)

The grid codes requires that for power generation arrays greater than a minimum power level (e.g. 5MW), the grid operator can constrain the power output below that which is available from the resource, if it is deemed necessary for power system stability. The means by which power is constrained can vary significantly from device to device, and this should be accounted for in the dynamic model since it impacts on the power system.

These mechanisms have been categorized as illustrated in Figure 31.

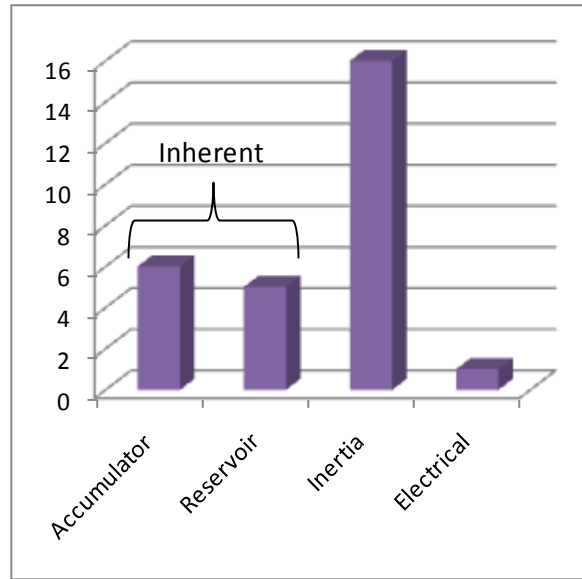

Figure 31: Power Constraint Mechanisms

The majority of respondents remove the action of the resource power by some method, where this is possible, for example through shutoff or bypass valves in a pneumatic chamber. Other developers store the excess energy, and the third predominant method is through control, or detuning of the device response or power take-off capability. Of course, these power limitation mechanisms do not only apply to situations of grid constraint. They may also be used to limit power during extreme resource conditions, and can be very important in maintaining the operation of equipment within rating.

7.2.1 Conclusions from ‘Primary Power Capture’ Section

An important output of this section for the dynamic model is the characterization data typically available from developers. The primary power capture stage of a device is generally the most analytically complex, and producing an acceptable approximation of this power conversion stage is one of the main challenges of the dynamic modelling process. It appears that primary power capture time series data of one form or other are widely used by developers in characterizing their device performance, and that this data is available for different tuned states. This is important as it will enable some flexibility in developing the model for this conversion stage. For devices that are not highly non-linear, and whose tuning dynamics are not wave-to-wave, it should be possible to construct an approximate frequency domain linear transfer function for the primary power capture stage. In the case of very non-linear devices and/or devices that are tuned wave to wave, a more complex model may be necessary. In this case, monochromatic time series data may be more useful, as input and output time series data could be more directly related, in the derivation of a time domain transfer function.

The availability of data for different tuned states is important in developing a table of transfer functions which can be discretely selected as the system tuning or damping changes as a result of control action.

The incorporation of the power limiting mechanism into the dynamic model will have to be catered for in several ways, depending on the mechanism utilized. Resource removal could be accomplished simply by attenuating the resource input power time series. Power reduction by control can be performed by incorporating the ‘de-tuned’ states into the control range of the

primary power capture model. Power reduction by storage will need to be included in the energy storage model block. The dynamics of response time and the capacity limits of each method will need to be included also.

7.3 'Storage' Section

The different types of energy storage mechanisms available are graphed in Figure 32. Inertial storage is available to some extent in most devices. Accumulator and reservoir storage come next, with only one respondent utilizing electrical storage.

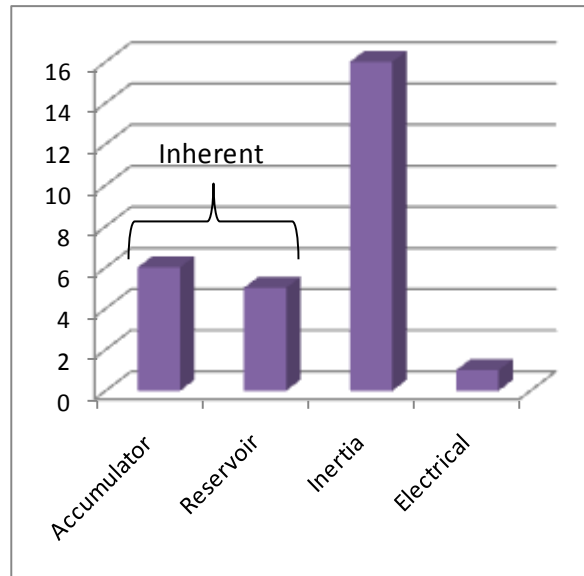

Figure 32: Types of Storage

The means by which developers can characterize the energy storage level available in their device is depicted in Figure 33. Capacity in seconds of rated power (CSP) is the most common method with capacity as a percentage of rated power (PRP) over a given time period also being quite common. A reasonable number of respondents possess data on the storage cycle efficiency (SCE). The average and maximum discharge and re-charge rates (ARR, ADR, MRR, MDR) are not quite as well served in terms of data availability.

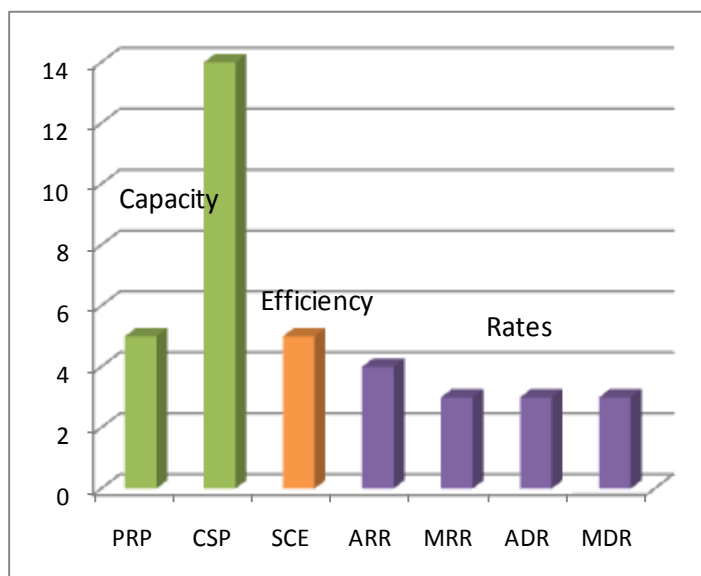

Figure 33: Energy Storage Parameterisation Data

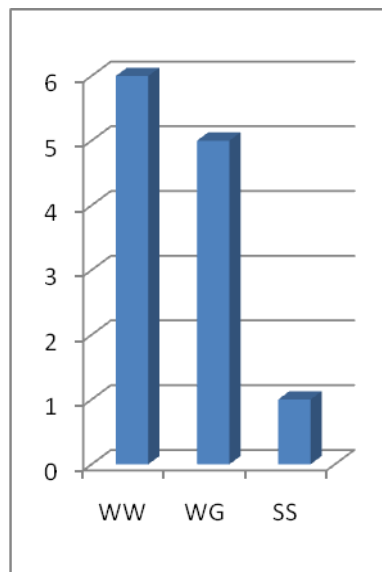

Figure 34: Storage Strategy Timeframe (Wave Energy Devices Only)

The typical time frames of energy storage capability are illustrated in Figure 34 for wave energy device responses. It is evident that the vast majority of storage capability is short term, this being almost evenly split being wave to wave storage and wave group storage.

7.3.1 Conclusions from 'Storage' Section

The majority of energy storage is short term (<30s), so there will be at least some absorption and release of energy during a typical dynamic model simulation run, thus it is important to model the dynamics of this power conversion stage. For devices with long term storage, this may not be necessary as it will come into play over the relatively short time scales used in grid simulation dynamic modelling.

The modelling of inertial energy storage is better placed as part of the prime mover model, since it is generally associated with the inertia of the prime mover itself, as well as other mechanical components. This modelling is usually quite straightforward and a standard rotating or moving mass model can be utilized.

The characterization of energy storage capacity appears to be relatively straightforward, given the data available from developers and equipment specifications. It may be important to also be able to parameterise the maximum charge and discharge rates for some energy storage techniques, and this may be a gap in the characterisation data currently. It should be relatively straightforward, however, to work with developers to arrive at these parameters.

7.4 'Prime Mover' Section

The types of prime movers in the devices surveyed are shown in Figure 35. The majority are hydro turbines, which the remainder distributed between air turbines, hydraulic motors and linear translators.

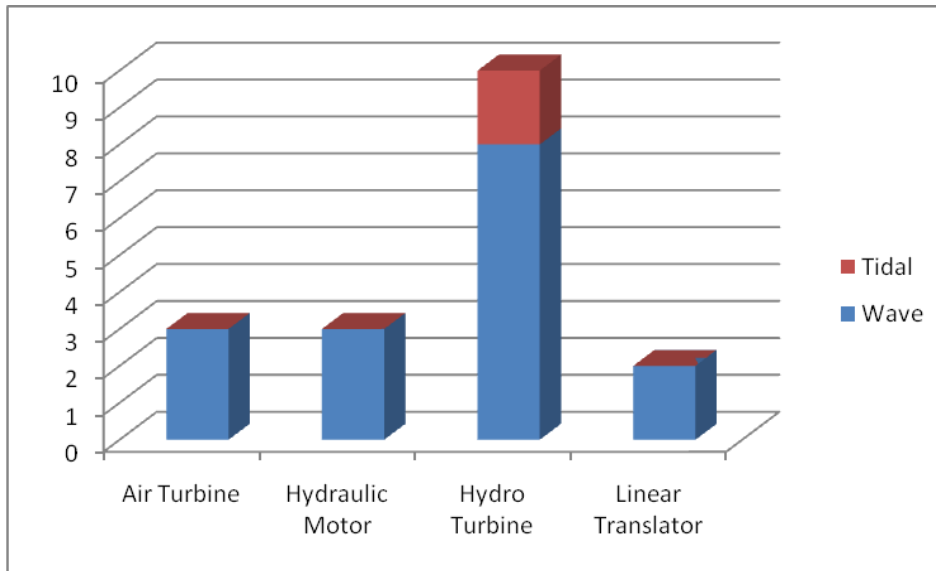

Figure 35: Prime Mover Categories

Most devices possess multiple prime movers and their mode of operation is explored in Figure 36. The majority operate simultaneously and independently of each other. There are several devices in which the power is unevenly distributed between the prime movers.

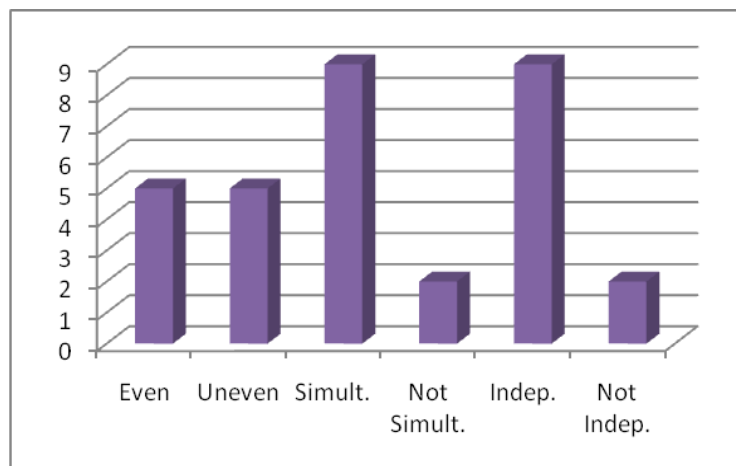

Figure 36: Multiple Prime Mover Operation

The speed variation in the prime mover is addressed in Figure 37 and Figure 38. Clearly, a significant majority of prime movers are variable speed in operation, with the speed being actively controlled (as opposed to simply changing as a passive outcome of power fluctuations). A measure of this variability over different time scales is illustrated in Figure 38, with a 10% speed change relative to rated speed used as the benchmark for variability.

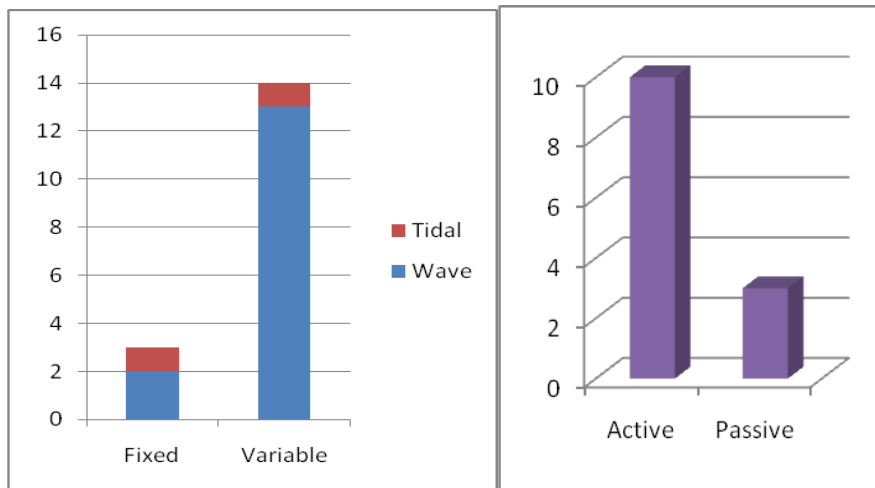

Figure 37: Speed Characteristic of Prime Movers

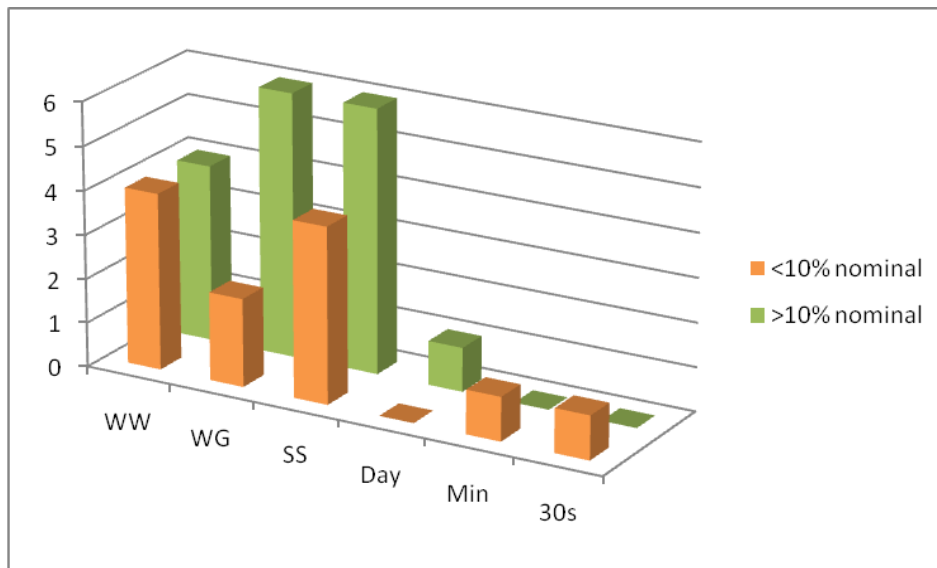

Figure 38: Time Variability of Prime Mover Speed

The characterisation of the prime mover can be difficult due to the varying nature of the resource input, particularly for wave energy devices, and also due to the wide variety of possible prime movers. Incorporating all of these options into a generic dynamic model is a challenge. One option is to specify a range of mean efficiencies for different operating points in terms of prime mover speed (EffS), and resource input magnitude (EffW, EffT). The ability to provide such data is plotted in Figure 39.

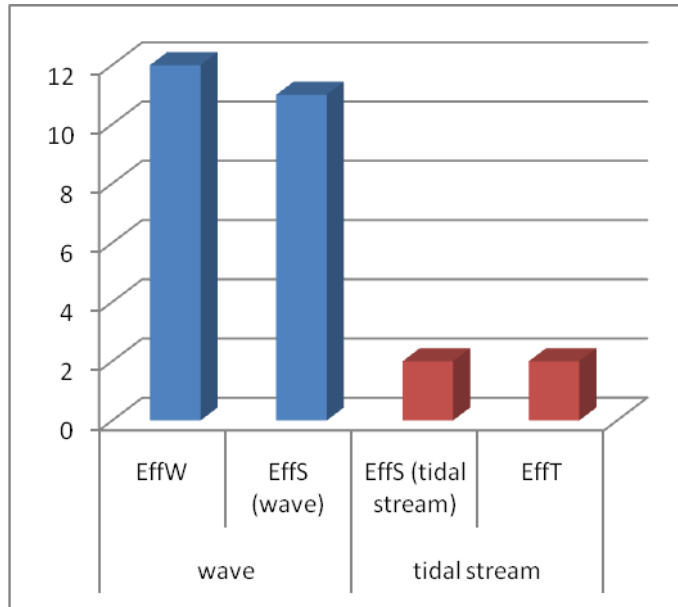

Figure 39: Ability to Provide an Average Efficiency for a Range of Prime Mover Speeds and Input Conditions

7.4.1 Conclusions from 'Prime Mover' Section

The majority of devices considered possess variable speed prime movers. It is important then that the mechanical model of the prime mover and drive train system be considered. This consideration overlaps into the storage section, as a variable speed mechanical system inherently possesses some level of inertial storage. The question of gearboxes is considered in the 'Generator' section, however, it is probably appropriate that the gearbox model should be included in the prime mover mechanical model. The standard drive train models utilized in wind turbine dynamic models should be adequate [6-8, 10].

The issue of multiple prime movers must also be taken into account in the dynamic model, as it appears that in many devices their operation is independent of each other, so it is unlikely that they can be lumped into a single equivalent prime mover model. To correctly model this situation, a more detailed understanding of the individual control strategies with respect to multiple prime mover operation will be required.

There appears to be significant knowledge of prime mover mean efficiency data for a range of speed conditions and input conditions. It is proposed to use this information to characterize the prime mover, rather than the specific technology-based performance curves of each prime mover type.

7.5 'Generator' Section

The abbreviations utilized in this section are:

- SCIG Squirrel Cage Induction Generator
- PM Permanent Magnet Generator
- DFIG Doubly Fed Induction Generator
- LG Linear Generator
- SG Synchronous Generator

The generator types utilized are shown in Figure 40, and the grid connection approach in terms of power electronics converters is illustrated in Figure 41.

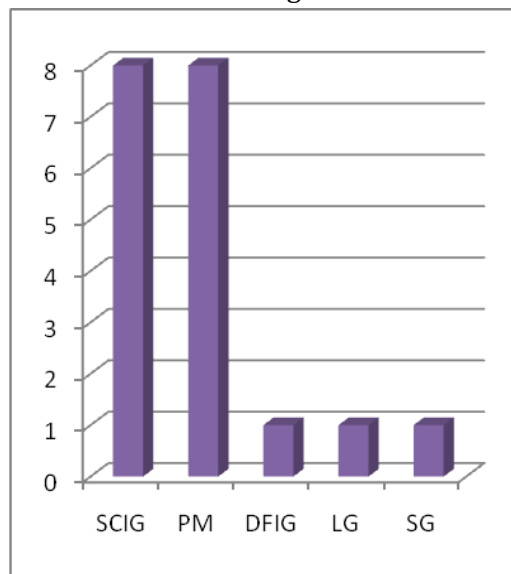

Figure 40: Generator Types

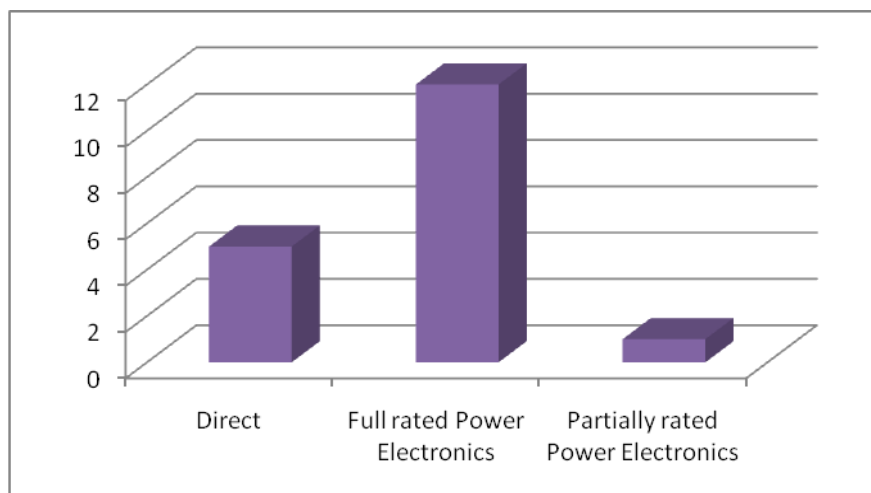

Figure 41: Grid Connection and Power Electronics Approach

The presence or absence of gearbox coupling to the generator is graphed in Figure 42.

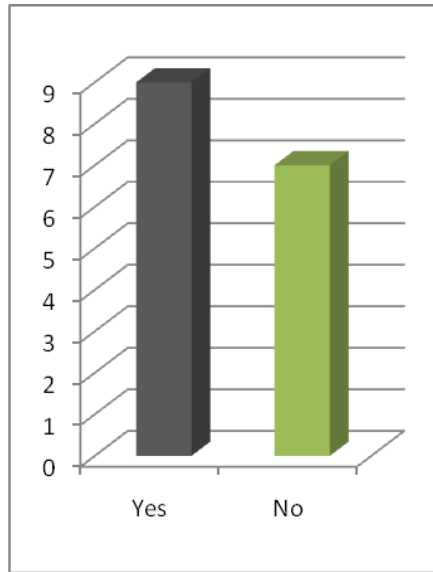

Figure 42: Presence of a Gearbox

The ability to provide generator efficiency data is shown in Figure 43.

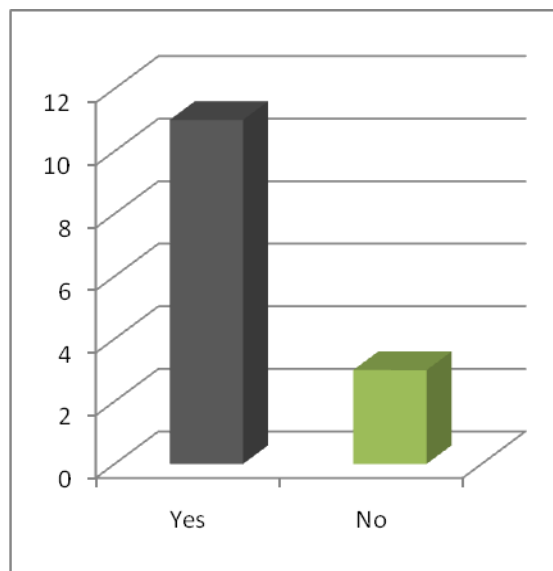

Figure 43: Ability to Provide Efficiency Curves for the Generator

7.5.1 Conclusions from 'Generator' Section

The majority of devices surveyed, due to their variable speed nature, will utilise power electronics coupled permanent magnet or squirrel cage induction generators. There are a significant number of generators that are gearbox-coupled to the prime mover and this will need to be taken in to account in the mechanical model of the prime mover block.

The use of fully rated power electronics in the generator power train considerably simplifies the generator modeling, and allows for simple first-order dynamic models, in which the only time element is the response time of the generator stator current loop. The generator is modelled simply as a torque source. The efficiency characteristic of the generator can also be included in the final calculation of power output to the grid connection point. In cases where the generator is a directly grid-connected induction machine, it is usually necessary to migrate to a third order

model in which the rotor flux dynamics are included in the model [40], and the stator current loop is modeled again by a first order response. These models are readily available in most power system simulation packages.

The grid connection and disconnection conditions, reactive power control and low voltage operation must also be included in the model. Much can be directly transferred from wind turbine models in this aspect [7, 8, 10, 11, 40, 47].

7.6 'Control' section

As mentioned at the beginning of this report, the results of the 'Control' section are based on the second survey only.

7.6.1 Introduction

A majority of both tidal and wave devices have some means for optimising and/or for limiting power conversion as shown in Figure 44. In the case of tidal converters, all of them have optimisation means and 12 out of 13 also have power limitation means. Among the 22 wave energy converters, 19 have optimisation means and 20 have the capability to limit their power outputs.

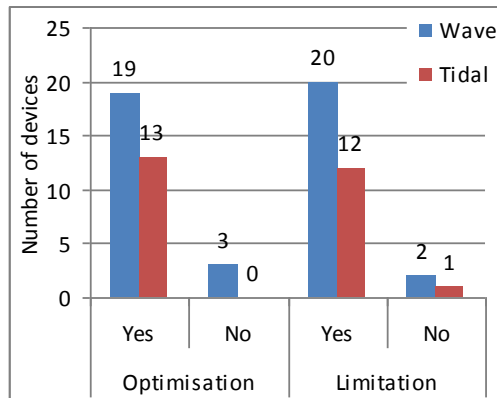

Figure 44: Power optimisation/limitation means

Power limitation can be applied in many different ways in practice and to almost all stages of the power conversion chain, from the primary power capture stage to the generator stage. It can be modelled at a very simple level by integrating an upper power limit to each block, above which the output power is kept constant to this limit regardless of the input power magnitude. It is also important to model the response time of the power limitation mechanism, e.g. blade pitching or de-tuning, and any constraints that may exist on the peak energy that can be dissipated, e.g. in a dump load.

Numerical values for these limits may be supplied by developers directly in terms of component power-time limits, or may need to be calculated from other parameters such as maximum fluid pressures or flows.

Power optimisation strategies are very diverse and are usually applied to the following stages:

- primary power capture: optimising the conversion between wave power and primary mechanical or fluid power by adapting the primary power capture stage component to changing sea conditions, for instance by tuning the device's motion to the dominant wave frequency. This type of optimisation will be referred to as "tuning".

- prime mover: optimising the conversion between the primary mechanical/fluid power and the prime mover power, for instance by controlling the input fluid flow to a hydraulic motor or varying the rotational speed of an air turbine
- prime mover/generator: optimising the conversion between mechanical and electrical power, by controlling the prime mover and generator magnetic fields interaction

Optimising power conversion may also be applicable at the storage stage by controlling the charge/discharge rates appropriately in order to minimize the charge/discharge losses respectively, for instance to limit friction losses in a fluid accumulator. However, although Figure 53 shows that some developers do control these rates, it is still unclear if they do so for optimising power conversion or for other purposes, e.g. limiting mechanical constraints on the storage means.

Optimisation may be modelled using either time series data sets at different control operating points or curves of optimum efficiencies with respect to sea conditions at the primary power capture stage or with respect to the prime mover/generator speed or torque at the prime mover/generator stage.

These optimum efficiency data must be determined with respect to the control strategies applied to the device: average efficiencies of the device in a stand-alone model without any influence of the control system are not sufficient. For instance, in the case of tidal turbines using control strategies similar to those used for wind turbines, several operating points may exist for a single value of tidal flow speed because of the multiplicity of pitch angle-rotor speed configurations. However, control strategies may exclude some of these potential operating points from the range of operation of the device e.g. prime mover speed restricted to a certain range for given sea conditions, etc. It is hence important that the efficiency data provided by the developers corresponds to the optimum efficiency at the operating points chosen with respect to the control strategies.

Optimum efficiency data sets or curves can be selected discretely within the model depending on, a range of inputs such as sea conditions, for instance tidal flow speed, wave frequency/height, or prime mover/generator speed and/or torque. At the primary power capture stage, these efficiency values or curves might be supplied by developers of non-direct-drive systems in terms other than power, for instance as pressure or flow, and may need then some conversion work to be implemented in the model.

From the survey data, it appears that average efficiencies of the primary power capture stage and prime mover are widely available from developer's "Primary power capture stage". It is still unclear whether this data comes from tests of the primary power capture component or the prime mover system in stand-alone mode or integrated in the whole converter system and thus including the impact of control strategies. If the control approach can be approximated as a set of slowly varying control parameters, then it is acceptable to utilise average efficiencies at discrete control operating points as the basis for modelling the effects of control. However, if the control variables change rapidly in time, as in for instance very non-linear wave-to-wave control, the modelling of the effect of the control system on the device power output becomes significantly more complex. In this case, the use of data sets indicating the averaged effect of the control variable mean value may be the best solution, particularly given the confidentiality issues surrounding control strategies.

7.6.2 Tuning

7.6.2.1 Introduction

The term “tuning” is widely used to characterise the adaptability of an oscillating wave device to match the dominant wave frequency as much as possible in order to achieve resonance. In the current ‘Control’ section, this definition is broadened to define the optimisation of the primary power capture component of any device, either wave or tidal, to changing sea conditions (wave frequency/height, tidal flow speed) for increasing its efficiency with respect to a de-tuned state. De-tuning can also be used by a device to reduce its power conversion efficiency deliberately in adverse sea conditions.

The analysis carried out in this section only applies to the modelling of devices tuning or de-tuning with respect to changing sea conditions. Considering the current lack of guidelines regarding the dynamic modelling of ocean energy converters, it is still unknown whether these changing sea conditions will be part of the required input conditions for grid connection models of ocean devices. However, the modelling of tuning will be essential for some devices tuned on a wave-to-wave basis. For devices tuning over a longer period of time, it may not be necessary to implement tuning for grid fault studies or for simulation during a single sea-state.

Figure 45 shows that a large majority of the 22 wave energy converters are tuneable. As for tidal converters, 8 devices out of 13 are adaptable to sea conditions as well.

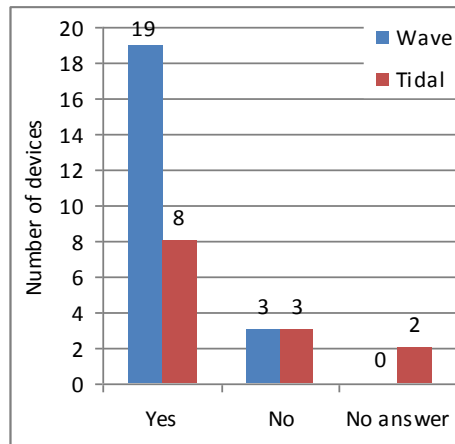

Figure 45: Ability to tune to prevailing sea conditions

Tuning to new prevailing sea conditions is achieved in many different ways and on various timescales. Moreover, the means by which a device transforms from one tuned state to another is highly dependent on its own geometric, hydrodynamic and mechanical characteristics, as well as on its control strategies, which are just as device-specific. Modelling tuning accurately enough is thus one of the main challenges of generic modelling of ocean energy converters.

It is proposed to model the process of tuning in two phases as illustrated in Figure 46. The establishment of new sea conditions is assumed to occur at time $t=0$. The first phase of tuning concerns time T_d (“decision time”) required for taking the decision for the device to tune after the establishment of new sea conditions. Once the decision is taken, another time delay T_t (“tuning time”) is needed for the device to complete tuning. At time $t= T_d + T_t$, the device’s characteristics are fully adapted to the new sea conditions.

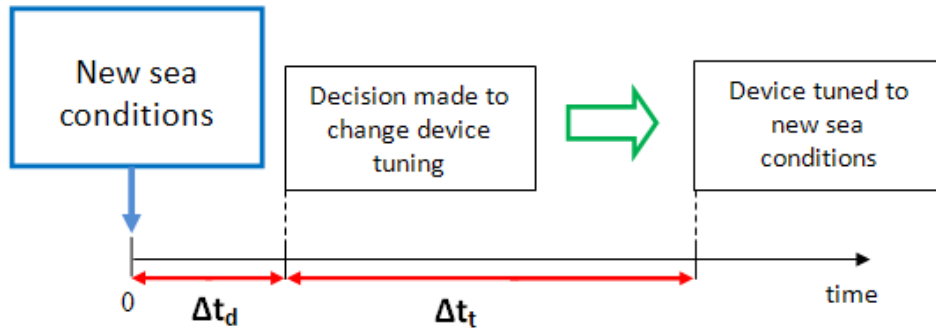

Figure 46: Tuning phases

7.6.2.2 Decision time T_d

A majority of wave and tidal devices can tune to new wave or tidal conditions almost instantaneously as depicted in Figure 47 with the label 'I'. An equal share tunes after a time delay T_d . A small number of wave devices tune after a specific number of waves N .

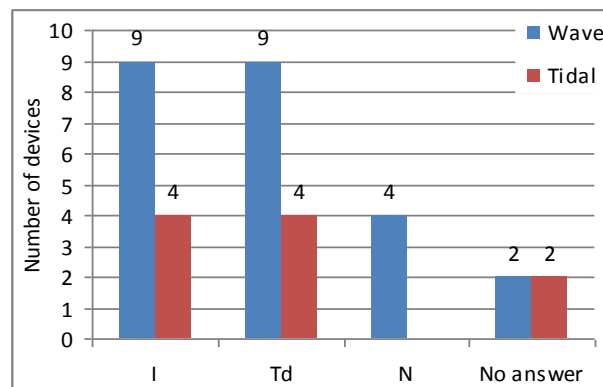

Figure 47: Decision parameters

Figure 48 shows that tuning delay is linked to a decision time T_d only for a majority of non-instantaneously tuneable devices. Some devices (3 of them) tune according to both time T_d and number of waves, N . However, only one device tunes according to the number of waves only. In conclusion, the predominant reaction is hence either instantaneous or relying on a parameterisable time delay.

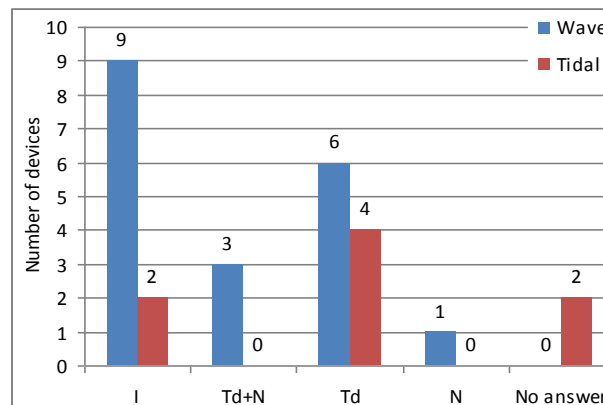

Figure 48: Decision parameters (decoupled)

During decision time T_d , no change is made to the characteristics of the device, such as blade angle or damping level. However, as the sea conditions have changed themselves, the device is no longer tuned optimally and hence its efficiency decreases. The non-optimal efficiency can be selected from the provided efficiency curves or efficiency maps with respect to the new sea conditions. The tuning characteristics, for instance damping level, remain at the levels optimal for the previous sea conditions.

Numerical values for time T_d can be provided by a majority of developers: 8/9 for wave converters and 4/4 for tidal converters as shown in Figure 49. If time T_d is not constant, an average value may be chosen.

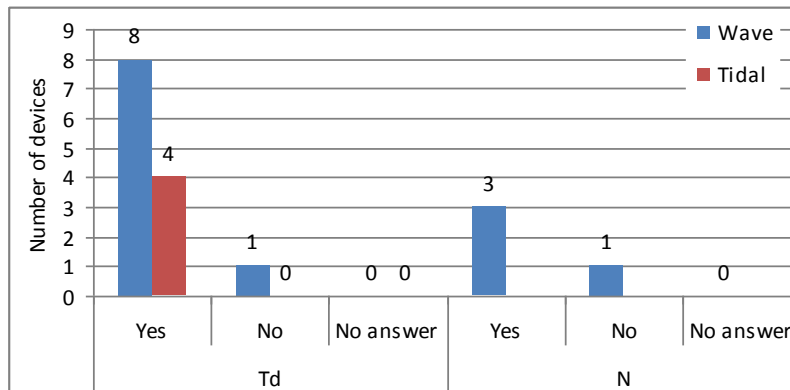

Figure 49: Ability to provide numerical values for T_d and N

Three wave developers out of 4 can also provide numerical values for the delay time as expressed in wave cycles N , but as mentioned earlier, decision time T_d is preferred to N as a first approach to generic modelling.

For a majority of devices, decision time T_d ranges from close to zero (almost instantaneous) to shorter than 30 s as shown in Figure 50. It confirms, as expected, that the decision time, being of the timescale range of dynamic simulations on power system stability study, must be implemented in a generic model if changing sea-states are required to be implemented as input conditions.

A non-negligible share of wave devices (6) also have a decision time T_d included between 30 s and 10 min. This may have to be taken into account as well, depending on the type of studies undertaken but does not need further refinements of the model.

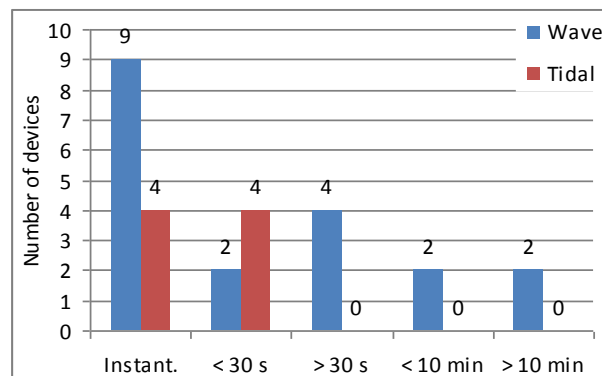

Figure 50: Timescale of decision time T_d

A minority of devices (2) have a decision time of the range of 10 minutes to more. If the power output of these types of devices is to be simulated for dynamic simulations shorter than a sea-state, there is no need for developers to provide tuning data.

7.6.2.3 Tuning time T_t

Another time delay must be taken into account besides decision time T_d . It concerns the tuning time T_t which elapses before the device actually completes tuning, once the decision to tune has been taken at time T_d .

A majority of developers whose device is tuneable can provide this tuning time T_t , as Figure 51 shows that 12 wave developers out of 19 and 6 tidal developers out of 8 are able to supply this time.

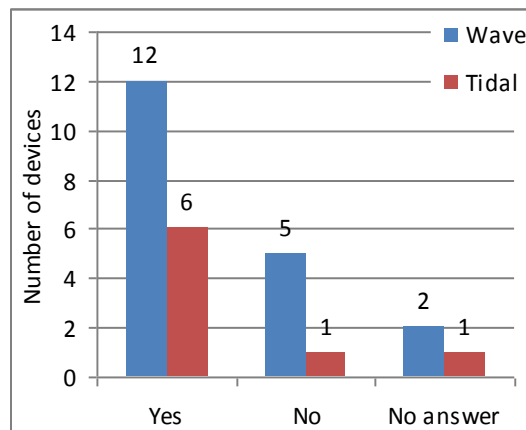

Figure 51: Ability to provide tuning time T_t

Tuning time T_t is, as expected, mostly shorter than 30 s (Figure 52). However, among this timescale category, there are two tuning types to be distinguished: mechanical and electrical tuning. Electrical tuning via generator control will be typically significantly faster in response than through control of mechanical elements.

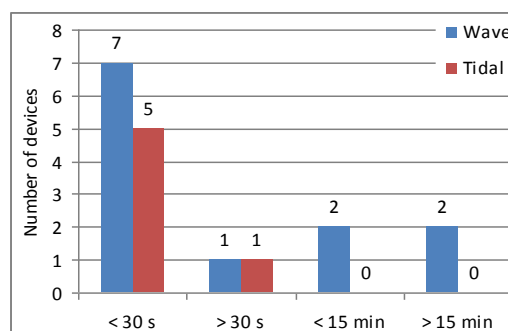

Figure 52: Timescale of tuning time T_t

In the case of generator control response time, this will be incorporated in the detail of standard generator models within the power system simulator. For devices using mechanical elements to achieving tuning, tuning time T_t is not negligible with respect to the simulation time scale and must be provided. Tuning may be taken into account or not for devices whose tuning time is greater than 30 s depending on the timescale of the planned studies. If the tuning involves control of elements within the main power train structure, such as the prime mover speed, then

the implementation of tuning will be seen in the changing of standard control variables as described in the previous section. However, sometimes device tuning can be implemented by means external to the main power train, such as ballast tanks. In this case, the tuning delay must be described by means of a separate time delay.

In terms of implementation of this delay time in the model, two options may be considered:

A first option is proposed for devices tuning quickly, for instance on a wave-to-wave basis. For these devices, it is recommended that the device efficiency is maintained at the de-tuned efficiency during time T_t and then changed to the optimum efficiency with respect to the new sea conditions once the tuning time has elapsed.

For devices whose tuning time is longer than few seconds, it may be relevant to include the evolution of the device efficiency over the tuning time. An alternative approach is proposed and consists in approximating linearly the device efficiency during period T_t with respect to the efficiency of the initial de-tuned state and of the final optimally tuned state.

7.6.3 Actively-controlled parameters

The abbreviations used in the graphs of this section are the following:

| | |
|-----|--|
| FP | Primary fluid pressure |
| FFR | Primary fluid flow rate |
| IPS | Minimum input power threshold for energy storage |
| SCR | Storage charge rate |
| SDR | Storage discharge rate |
| Q | Reactive power |
| SP | Prime mover speed |
| TQ | Prime mover/generator torque |

Figure 53 shows the actively-controlled parameters. A large majority of the 13 tidal converters control the prime mover speed as well as the prime mover/generator torque. The absence of storage for most tidal converters is the reason why control at the storage stage for the minimum input power threshold for storage (IPS) and for the storage charge rate (SCR) is marginal for those devices. The reactive power control (Q) will be addressed later in this section.

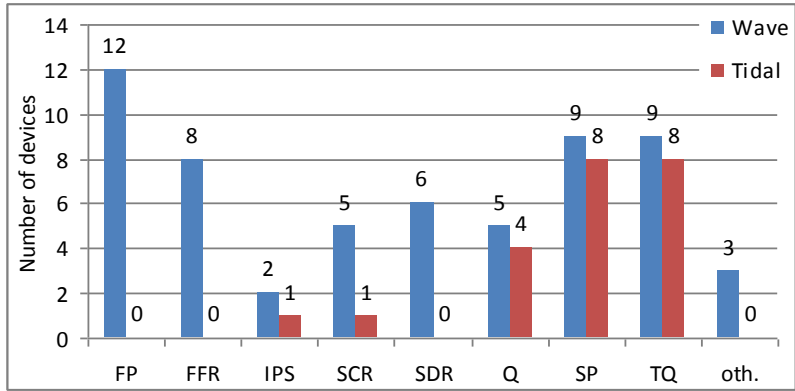

Figure 53: Actively-controlled parameters

Contrary to tidal devices, wave converters usually control more parameters. This difference stems from the fact that some form of fluid power is involved in a majority of wave devices, whereas tidal devices are predominantly direct-drive systems with fewer parts or energy conversion stages to control. Besides, large inherent energy storage is more likely to be implemented in wave systems due to the high variability of the wave power input over a short timescale, rather than in tidal devices which generally have a much smoother power input.

7.6.3.1 Storage control

Figure 54 shows the results regarding control at the storage stage. An interesting feature of this chart is the number of non-respondents to this question among the devices having some means of storage, either inherent, inertial or electrical (21 wave converters on 22 and all the 13 tidal converters). This leads to the conclusion that a majority of devices do not control storage actively.

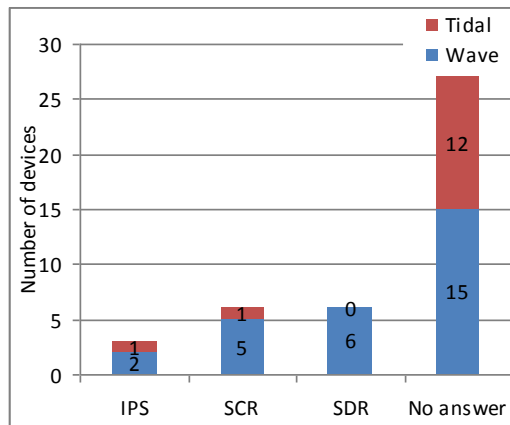

Figure 54: Control of IPS, SCR and SDR

Table 4 shows the storage stage controlled parameters with respect to the storage type combinations. Some devices have either inherent, inertial or electrical storage only, and others have a combination of at least two storage types. As a matter of comparison, the number of devices having some storage means and the ability to parameterise it is indicated. This number is thought to be an indicator of a certain level of achievement in the conception of storage and of the awareness of developers regarding device storage capacities.

It actually appeared in the survey that some components, not dedicated to storage but having a potential significant storage capacity, were not mentioned by many developers, such as hydraulic rams or large hydro-turbines. However, these components may have a very beneficial impact on the device behaviour during a fault and on power smoothing capability. These non-dedicated storage capacities must hence be modelled..

The number of developers able to parameterise their device storage capacity may give an idea of how many of them have potentially considered storage control as an option for their devices.

Table 4: Storage stage controlled parameters with respect to the storage types

| | Inherent only | Inertial only | Electrical only | Inherent and Inertial | Inherent and Electrical | Inertial and Electrical |
|--------------------------|---------------|---------------|-----------------|-----------------------|-------------------------|-------------------------|
| <i>Number of devices</i> | 7 | 1 | 2 | 5 | 0 | 1 |
| IPS | 1 | | 1 | 1 | | |
| SCR | 1 | | 2 | 2 | | 1 |
| SDR | 1 | | 2 | 2 | | 1 |

Inherent storage may be controlled, for instance for limiting fluid friction losses during the energy storage process. However, Table 4 shows that among the 12 devices having inherent storage means (either combined with inertial storage or not), only 2 to 3 devices control IPS, SCR or SDR. Thus a simple model of inherent storage control in terms of controllable charge and discharge rates, and storage thresholds is felt to be sufficient.

The results also show that inertial storage is not controlled. This is expected from most devices, but it may be possible and relevant for gyroscopic devices to have such a control. However, there was only one gyroscopic device among the survey sample and the results are inconclusive with such limited data. As a result, it is proposed to not specifically model active control of inertial storage in the generic model, although passive inertial storage will indeed be present in the prime mover section of the model due to the inertia of any rotating parts.

In Table 4 it can be seen that two respondents have electrical storage and both of them control SDR and IPS, with one controlling SCR. This type of control is generally implemented in order to improve the output power quality by reducing its short-term variability rather than for optimising the energy conversion efficiency of the storage element, which is typically quite high for electrical components. Given the likelihood the electrical storage may have an important role to play, particularly in wave energy systems due to the high short-term power fluctuations, it is important to include this feature in a generic model.

7.6.3.2 Reactive power control

Figure 53 showed that 5 wave developers out of 22 and 4 tidal developers out of 13 control reactive power. Since the majority of ocean energy devices will likely require either fully or partially-rated power converters (see ‘Generator’ section), the actual number of reactive power-controlling devices should hence be greater than the figures given above. Contrary to the other types of control mentioned in the previous sections, reactive power control is designed regarding grid-code requirements. As no specific grid code requirements have yet been issued

for ocean energy converters, the requirements applicable to wind farms are commonly taken as a benchmark for wave and tidal devices. Typically, it is required of wind turbines/farms that they maintain their power factor at a given value or within a given range. The standard models of reactive power control systems implemented in wind turbines models should be adequate and directly transferable to ocean energy generic models

7.6.3.3 Prime mover/generator speed and torque

The last controlled parameters addressed in Figure 53 are the prime mover/generator speed and torque. The control of these parameters is predominant for both wave and tidal converters: 9 wave converters out of 22 and 8 tidal converters out of 13 control at least one of these parameters.

Average values of optimum efficiencies (with respect to the control strategy) of the device must be used to characterise the prime mover for a range of speed conditions and input conditions, which most developers have the ability to provide. Figure 55 shows that a large majority of the 10 tidal converters controlling prime mover/generator speed and/or torque actually uses a maximum power tracking curve (either electrical power or torque with respect to prime mover speed).The ability of the control strategy to be expressed as function or control curve will greatly facilitate its implementation in a generic model.

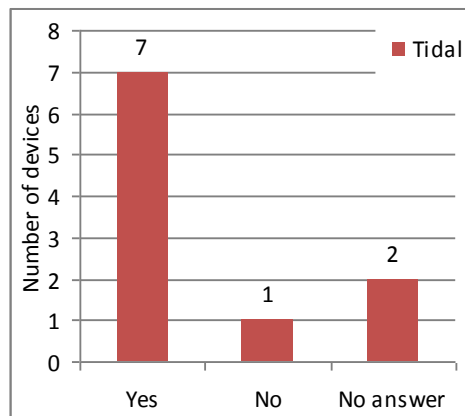

Figure 55 - Use of maximum power tracking curve (tidal devices only)

However, as mentioned in the ‘Prime mover’ section, the characterisation of optimum efficiencies with respect to input power/torque or sea conditions for wave devices should be more complex due to the varying nature of the resource input. First, unlike tidal developers, few wave developers (4) on the 12 whose device controls either prime mover/generator speed or torque can provide a power tracking curve as illustrated in Figure 56.

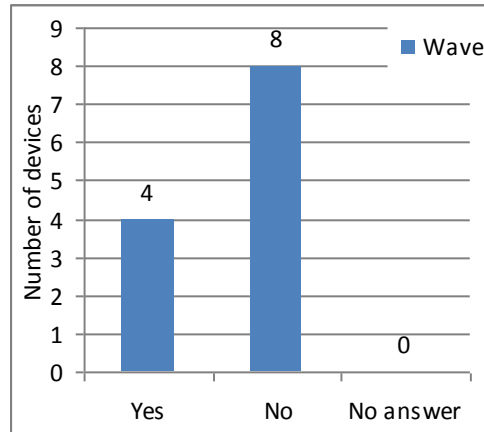

Figure 56 – Use of a maximum power tracking curve (wave devices only)

Besides, those curves may be simplistic if they do not take into account the variability of the generator efficiency induced by the prime mover speed. However, a large majority of developers are able to provide a generator efficiency curve: this should be used at a first stage to determine the efficiency at the prime mover/generator stage with respect to the prime mover speed.

7.6.4 Conclusion of the ‘Control’ section

Both power optimisation and limitation are commonly used in ocean energy devices and must play an integral part in a generic model. However, although power limitation can be implemented quite straightforwardly, the implementation of power optimisation will be more complex. Optimisation strategies and means are various, device-specific and often kept confidential by developers. It is recommended to model control for optimisation purposes from optimum and de-tuned states efficiency data sets or curves. This data supplies enough information to parameterise a generic model while not revealing the technical means for achieving optimisation. It would be discretely selected at a range of different inputs such as sea conditions, prime mover speed etc. and the model could step from one set of performance parameters to the next as the control variable changes.

An approach was proposed to distinguish two phases in tuning: decision phase and tuning phase. For the former phase, the efficiency must be selected by conserving the same tuning characteristics, such as blade angle or damping level for the new sea conditions. This efficiency is no longer optimum with respect to the new sea conditions. During the tuning phase, two approaches may be envisaged depending on the value of tuning time T_t . For devices tuning very quickly (over few seconds), the de-tuned characteristics selected during the decision phase are recommended to be maintained during the tuning phase as well. For devices whose tuning dynamics are slower, the evolution of the efficiency may have a significant impact on the output power. The efficiency is hence suggested to be approximated linearly between the initial and final efficiencies to reflect this evolution.

In summary, the following control elements should be implemented in a generic model:

- Power limitation limits, and response time of limitation mechanism
- Primary power capture efficiency changes at different control operating points

- Prime mover efficiency changes at different control operating points
- Response time of system tuning operating point changes
- Inherent and electrical storage controllable charge/discharge rates and limits
- Generator/power converter control

8. GENERIC DYNAMIC MODEL STRUCTURE AND DATABASE

In conclusion, the finalized conceptual structure of the dynamic model is illustrated in Figure 57. A resource input block and grid connect block have been added at either end of the generic structure shown previously. The general modeling approach of each block is shown in the centre of the block. The data used to characterize the block model is inside each block, at the top of the block. External parameters (which may pass between blocks) or control inputs are depicted as auxiliary inputs to the blocks.

The grid connect block, generator block and the mechanical system portion of the prime mover/mechanical system block will be broadly similar to those utilized in existing wind turbine dynamic models [6-8, 10], with the notable exception of linear generator type converters, in which the generator model will be somewhat different in terms of how the current and flux are controlled, and also in the motion aspects of the system.

The remaining blocks are those which tend to be very device specific. The particular model structure and characterization approach represents a generic approach to these dynamic model blocks, which should be independent of technology.

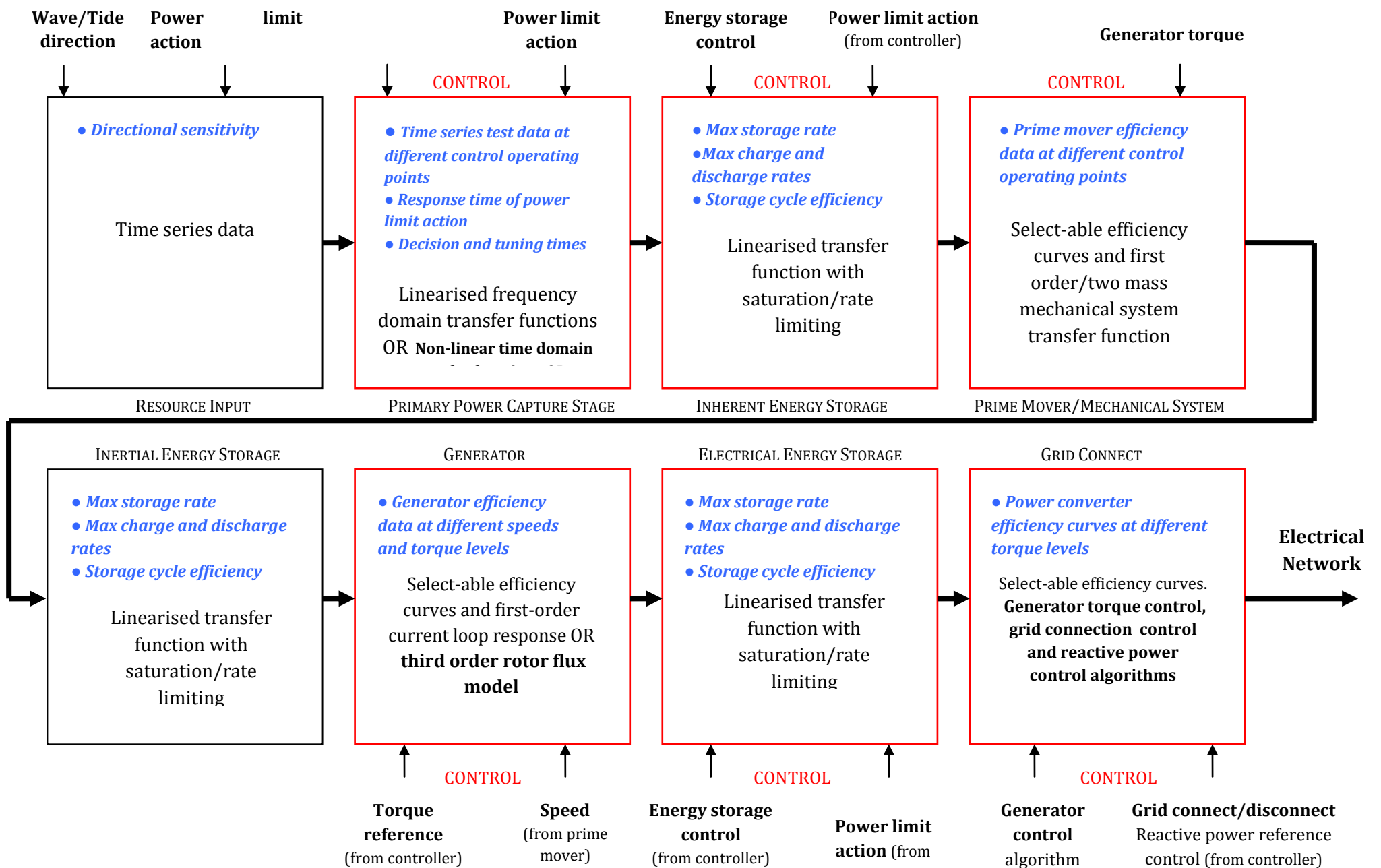

Figure 57: Dynamic Model Structure and Characterization Data

Finally, a database of typical dynamic model time constants for some of the different model components is given in Table 5. Most of these are highly dependent on the device design and can have a range of variation dependent on the design approach. Moreover, it is extremely difficult to obtain actual values for most of these time constants due to the proprietary nature of the device designs. Hence, the approach taken has been to utilize available information from developers in conjunction with calculations based on known or likely designs and equipment. Where possible, published data is utilised to calculate the model time constants. It should be noted that in the case of the primary power capture stage, the time constant in question is the approximate resonance period of the device, or the range of response periods of the device in the case of non-resonant OECs, or the oscillation cycle period in the case of oscillatory tidal devices such as the hydrofoil. In other cases, the commonly understood inertia constant (or its energy equivalent) is utilized. The inertia contribution of the generator is included in the prime mover inertia calculations.

Table 5: Typical Dynamic Model Time Constants for Different Device Types and Power Conversion Stages

| Primary Power Capture | Resonant/Response/Cycle Period | Comments |
|--|--------------------------------|--|
| Resonant Devices (PA/OWC/OWSC) | 6-10 s | Depends on wave climate for which device is designed [48]. |
| Overtopping Device | <12 s | Communication with WaveDragon |
| Tidal Hydrofoil | 22-28 s | Stingray 150kW device [49] |
| Inherent Energy Storage | Inertia Time Constant | |
| Hydraulic Accumulator | 2 s | Using one 50L accumulator at 10-35 MPa [50]. Can be designed to be larger/smaller. |
| Reservoir | 44 s | 7000 m3 reservoir [39] |
| Prime Mover | | |
| Tidal Turbine | 0.9 s | [51] |
| Wells Turbine | 3.4 s | Calculated from full scale turbine design concept |
| Wells Turbine with integrated flywheel inertia | 27 s | LIMPET assembly [52] |

| | | |
|-----------------|-------|---|
| Hydraulic Motor | 0.3 s | Denison Hydraulics Specifications |
| Impulse Turbine | 1.7 s | Calculated from full scale turbine design concept |

9. SUMMARY

This report has presented a comprehensive review of the major classes of wave and tidal energy devices currently in operation or under development. These devices have been categorized by their primary energy capture method. Such a classification is reasonable and intuitive, since many of the secondary power take off elements overlap from device to device. Moreover, this classification method usually corresponds to the chief visual difference between devices.

The various power conversion stages have been presented with representative examples of each of these stages. The significant characteristics of each of these stages from a grid connect dynamic model context have also been summarized.

This information has been summarized into an outline generic model structure, based on the concept of energy conversion stages. The characterisation of this model has been investigated, and information from device developers is utilized to provide a match between available data and model implementation.

A final generic model structure has been outlined, with recommendations for the implementation of each power conversion stage of the model, and for the model characterisation, based on feedback from a developer survey conducted during the course of the work.

References

- [1] "The World Wave & Tidal Market Report 2009-2013," Douglas Westwood Ltd 2008,
- [2] Khan, J. and Bhuyan, G., "Ocean Energy: Global Technology Development Status," Report prepared by Powertech Labs for the OES-IA. [Online] 2009, Available: www.iea-oceans.org.
- [3] Khan, J., Bhuyan, G., and Moshref, A., "Potential Opportunities and Differences Associated with Integration of Ocean Wave and Marine Current Energy Plants in Comparison to Wind Energy," a report prepared by Powertech Labs for the OES-IA Annex III. [Online] 2009, Available: www.iea-oceans.org.
- [4] "All Island Grid Study Work Stream 4: Analysis of impacts and benefits," Department of Communications, Energy and Natural Resources (Ireland) & Department of Enterprise, Trade and Investment (UK) 2008, Available online: <http://www.dcenr.gov.ie/Energy/North-South+Co-operation+in+the+Energy+Sector/All+Island+Electricity+Grid+Study.htm>, Accessed July 2010.
- [5] Khan, J., Bhuyan, G., and Moshref, A., "Key Features and Identification of Needed Improvements to Existing Interconnection Guidelines for Facilitating Integration of Ocean Energy Pilot Projects," a report prepared by Powertech Labs for the OES-IA Annex III, [Online] 2009, Available: www.iea-oceans.org.
- [6] Buchholz, B. M., Styczynski, Z. A., and Winter, W., "Dynamic simulation of renewable energy sources and requirements on fault ride through behavior," in *Power Engineering Society General Meeting, 2006. IEEE*, 2006, p. 7 pp.
- [7] Estanqueiro, A. I., "A Dynamic Wind Generation Model for Power Systems Studies," *Power Systems, IEEE Transactions on*, vol. 22, pp. 920-928, 2007.
- [8] Joris Soens, J. D. a. R. B., "Equivalent Transfer Function For A Variable Speed Wind Turbine In Power System Dynamic Simulations," *International Journal of Distributed Energy Resources*, vol. 1, April-June 2005.
- [9] Seul-Ki, K. and Eung-Sang, K., "PSCAD/EMTDC-Based Modeling and Analysis of a Gearless Variable Speed Wind Turbine," *Energy Conversion, IEEE Transactions on*, vol. 22, pp. 421-430, 2007.
- [10] Slootweg, J. G., de Haan, S. W. H., Polinder, H., and Kling, W. L., "General model for representing variable speed wind turbines in power system dynamics simulations," *Power Systems, IEEE Transactions on*, vol. 18, pp. 144-151, 2003.
- [11] Tabesh, A. and Iravani, R., "Small-signal dynamic model and analysis of a fixed-speed wind farm - a frequency response approach," *Power Delivery, IEEE Transactions on*, vol. 21, pp. 778-787, 2006.
- [12] Evans, D. V., "The Oscillating Water Column Wave-energy Device," *IMA J Appl Math*, vol. 22, pp. 423-433, 1978.
- [13] Falcão, A. F. d. O., "Control of an oscillating-water-column wave power plant for maximum energy production," *Applied Ocean Research*, vol. 24, pp. 73-82, 2002.
- [14] Henderson, R., "Design, simulation, and testing of a novel hydraulic power take-off system for the Pelamis wave energy converter," *Renewable Energy*, vol. 31, pp. 271-283, 2006.
- [15] Ricci, P., Lopez, J., Santos, M., Villate, J. L., Ruiz-Minguela, P., Salcedo, F., and O.Falcão, A. F. d., "Control Strategies for a simple Point-Absorber Connected to a Hydraulic Power Take-off," in *European Wave and Tidal Energy Conference*, 2009.

- [16] Polinder, H., Damen, M. E. C., and Gardner, F., "Linear PM Generator system for wave energy conversion in the AWS," *Energy Conversion, IEEE Transactions on*, vol. 19, pp. 583-589, 2004.
- [17] Chaplin, R. V., Rahmati, M. T., Gunura, K., Ma, X., and Aggidis, G. A., "Control systems for Wraspa," in *Clean Electrical Power, 2009 International Conference on*, 2009, pp. 93-97.
- [18] Kemp, J., "The Owel Wave Energy Converter," <http://www.owel.co.uk/owel.htm>, (Link to News and Press Releases), Accessed July 2010.
- [19] Jasinski, M., Knapp, W., Faust, M., and Fris-Madsen, E., "The Power Takeoff System of the Multi-MW Wave Dragon Wave Energy Converter," in *European Wave and Tidal Energy Conference*, 2007.
- [20] DTI, "Variable Pitch Foil Vertical Axis Tidal Turbine," Edinburgh Designs Ltd. March 2006, Available online: <http://www.bis.gov.uk/files/file30557.pdf>, Accessed July 2010.
- [21] "Technology: Oscillating Hydrofoil," http://www.esru.strath.ac.uk/EandE/Web_sites/05-06/marine_renewables/technology/oshydro.htm, Accessed July 2010.
- [22] "Tidal Sails ", <http://www.tidalsails.com/>, Accessed July 2010.
- [23] "Technical Animations - Venturi Effect Tidal Energy Converter," <http://www.aquatera.co.uk/studio/panorama/TidalAnim2.html>, Accessed July 2010.
- [24] Vantorre, M., Banasiak, R., and Verhoeven, R., "Modelling of hydraulic performance and wave energy extraction by a point absorber in heave," *Applied Ocean Research*, vol. 26, pp. 61-72, 2004.
- [25] Raghunathan, S., "The Wells air turbine for wave energy conversion," *Progress in Aerospace Sciences*, vol. 31, pp. 335-386, 1995.
- [26] Setoguchi, T. and Takao, M., "Current status of self rectifying air turbines for wave energy conversion," *Energy Conversion and Management*, vol. 47, pp. 2382-2396, 2006.
- [27] Setoguchi, T., Santhakumar, S., Maeda, H., Takao, M., and Kaneko, K., "A review of impulse turbines for wave energy conversion," *Renewable Energy*, vol. 23, pp. 261-292, 2001.
- [28] Merritt, H. E., *Hydraulic Control Systems*: John Wiley & Sons, 1967.
- [29] "Hydraulic Motors," in *Hydraulics and Pneumatics (2009)* online magazine available: <http://www.hydraulicspneumatics.com/200/FPE/MotorsActuators/Article/True/6428/MotorsActuators>, Accessed July 2010.
- [30] Boyle, G., *Renewable Energy: Power for a Sustainable Future*: Oxford University Press, 2004.
- [31] NPTEL(2009): online image, http://nptel.iitm.ac.in/courses/Webcourse-contents/IIT-ANPUR/machine/ui/Course_home-lec28.htm, Accessed July 2010.
- [32] US Dept of Energy(2009): online image, http://apps1.eere.energy.gov/consumer/images/pelton_wheel.gif, Accessed July 2010.
- [33] Manchester Bobber(2009), <http://www.manchesterbobber.com/>, Accessed July 2010.
- [34] "Distribution Code," ESB Networks October 2007, http://www.esb.ie/esbnetworks/en/about-us/our_networks/distribution_code.jsp, Accessed July 2010.
- [35] Mohan, N., Undeland, T., and Robbins, W., *Power Electronics: Converters, Applications, and Design*, 2 ed.: Wiley, 1995.

- [36] Molinas, M., Skjervheim, O., Andreasen, P., Undeland, T., Hals, J., Moan, T., and Sorby, B., "Power electronics as grid interface for actively controlled wave energy converters," in *Clean Electrical Power, 2007. ICCEP '07. International Conference on*, 2007, pp. 188-195.
- [37] Wildi, T., *Electrical Machines, Drives, and Power Systems*, 6 ed.: Pearson/Prentice Hall, 2006.
- [38] O'Sullivan, D. and Lewis, A. W., "Generator Selection for Offshore Oscillating Water Column Wave Energy Converters," in *European Power Electronics and Motion Control (EPE-PEMC) Conference*, 2008.
- [39] Cruz, J., *Ocean Wave Energy: Current Status and Future Perspectives*: Springer, 2008.
- [40] Thiringer, T. and Luomi, J., "Comparison of reduced-order dynamic models of induction machines," *Power Systems, IEEE Transactions on*, vol. 16, pp. 119-126, 2001.
- [41] D.B. Murray, Egan, M. G., Hayes, J. G., and O'Sullivan, D. L., "Applications of Supercapacitor Energy Storage for a Wave Energy Converter System," in *European Wave and Tidal Energy Conference*, 2009.
- [42] Garcia-Rosa, P. B., Cunha, J. P. V. S., Lizarralde, F., Estefen, S. F., and Costa, P. R., "Efficiency optimization in a wave energy hyperbaric converter," in *Clean Electrical Power, 2009 International Conference on*, 2009, pp. 68-75.
- [43] Plummer, A. R. and Schlotter, M., "Investigating the Performance of a Hydraulic Power Take-Off," in *European Wave and Tidal Energy Conference*, 2009.
- [44] Nolan, G., "Modelling and Optimisation of a Heaving Buoy Wave Energy Converter for Potable Water Production," Ph.D., National University of Ireland, Maynooth, 2006
- [45] Justino, P. A. P. and Falcao, A. F. d. O., "Rotational Speed Control of an OWC Wave Power Plant," *Journal of Offshore Mechanics and Arctic Engineering*, vol. 121, pp. 65-70, 1999.
- [46] "How Wavebob Works," http://www.wavebob.com/how_wavebob_works/, Accessed July 2010.
- [47] Sørensen, P., Hansen, A. D., Lund, T., and Bindner, H., "Reduced models of doubly fed induction generator system for wind turbine simulations," *Wind Energy*, vol. 9, pp. 299-311, 2006.
- [48] Nielsen, K. and Pontes, T., "Report T02-1.1 OES IA Annex II Task 1.2 Generic and site related wave data," 2010, Available online: <http://www.iea-oceans.org/>.
- [49] "Stingray Tidal Stream Energy Device - Phase 3," The Engineering Business Ltd 2005, <http://www.berr.gov.uk/files/file17507.pdf>, Accessed July 2010.
- [50] "Olaer Accumulators: Standard Range," <http://www.olaer.fr/en/gammes-standards-accumulateurs.php>, Accessed July 2010.
- [51] Mullane, A., Bryans, G., and O'Malley, M., "Kinetic energy and frequency response comparison for renewable generation systems," in *Future Power Systems, 2005 International Conference on*, 2005, pp. 6 pp.-6.
- [52] Wavegen, "Islay LIMPET Monitoring: Final Report," ETSU V/06/00180/00/Rep, 2002, <http://www.wavegen.co.uk/pdf/art.1707.pdf>, Accessed July 2010.