



HAL
open science

Wave Energy Grid Integration in Ireland – A Case Study

A Blavette, D O’Sullivan, M Egan, R Alcorn, T Lewis

► **To cite this version:**

A Blavette, D O’Sullivan, M Egan, R Alcorn, T Lewis. Wave Energy Grid Integration in Ireland – A Case Study. 3rd International Conference on Ocean Energy (ICOE), Oct 2010, Bilbao, Spain. hal-01265853

HAL Id: hal-01265853

<https://hal.science/hal-01265853>

Submitted on 12 Jul 2016

HAL is a multi-disciplinary open access archive for the deposit and dissemination of scientific research documents, whether they are published or not. The documents may come from teaching and research institutions in France or abroad, or from public or private research centers.

L’archive ouverte pluridisciplinaire **HAL**, est destinée au dépôt et à la diffusion de documents scientifiques de niveau recherche, publiés ou non, émanant des établissements d’enseignement et de recherche français ou étrangers, des laboratoires publics ou privés.

Wave Energy Grid Integration in Ireland – A Case Study

A. Blavette¹, D. O’Sullivan¹, M. Egan²,
R. Alcorn¹, T. Lewis¹

¹Hydraulics and Maritime Research Centre,
University College Cork,
Pouladuff Road, Cork City, Ireland
E-mail: hmrc@ucc.ie

²Department of Electrical Engineering,
University College Cork
College Road, Cork City, Ireland
E-mail: eleceng@ucc.ie

Abstract

Wave energy provides a variable, intermittent source of electrical power with significant power fluctuations occurring over short time scales of seconds. Because of these inherent features, the electricity generated from wave power plants may have a negative impact on the power quality of a local electricity grid. Hence, before large scale wave farms can be allowed to connect to the grid, the impact of these devices on both distribution and transmission networks needs to be well understood.

This paper shows a case study performed on the Belmullet region on the west coast of Ireland. Simulations were carried out using DIGSILENT simulation tool “Power Factory”. In this case study, the impact of a wave farm on the distribution network around Belmullet is studied. Static load flow and dynamic analysis for normal and contingency conditions are presented. The analysis was carried out within the framework of the IEA-OES Collaborative Annex III – “Integration of Ocean Energy Plants into Distribution and Transmission Electrical Grids”.

Keywords: dynamic and load flow simulations, case study, grid integration, wave energy

1. Introduction

Belmullet was chosen in 2009 by the Irish government to become the national wave energy test site of the Republic of Ireland. The test site is expected to become operational in 2011 and is planned up to a maximum generating capacity of 20 MW. The geographical configuration of the wave farm and the electrical components ratings are modelled accordingly to the design being implemented by the test site operator, ESBI.

The goal of this study is to analyse the impact of electricity produced by wave energy converters on

Belmullet’s local electrical network. The converters are modelled by means of synchronous generators with a periodic mechanical power input block. Directly-connected synchronous generators (i.e. without power electronics or reactive power compensation) were used.

It was not intended to study the internal parameters of the generators, as the focus of the study was on the grid itself.

1.1 Electrical Network Modelling

Power system simulators like “Power Factory”, “PSS/e”, ... are generally designed so that the power output of generators is constant during a simulation, whose timeframe is usually a couple of seconds (1 s to tens of seconds). In some wind turbine models, the wind speed is assumed to be constant and there is no way to modify it during the simulation [1]. A ramp or step increase/decrease of power generation is commonly used to model power generation fluctuation along with turbulence functions. However, the power fluctuations due to wave electricity cannot be modelled in such a way. Hence, the impact on the electrical network of a periodically-varying power source of significant amplitude is thus a new field of research.

The network model used in the current study is shown in Fig. 1. Four synchronous generators represent the wave energy converters (or arrays of converters).

Each generator is connected to an offshore 0.4 kV/10 kV transformer. The generators are numbered (from left to right): SG 1, SG 2, SG 3, SG 4 (Fig. 1). Four subsea cables connect the generators to the shore. The subsea cables connected to generators SG 1 and 2 are 6 km long, and the two others connected to generators SG 3 and 4 are 14 km long.

On the shore, there is a substation stepping the voltage up to 20 kV. A 20 kV, 5 km long, overhead line connects the substation to Belmullet town. Then, a transformer steps the voltage up to 38 kV. The rest of the Irish electrical network is modelled by means of a

fixed voltage source (whose voltage is set to 1.0 pu) in series with a reactor.

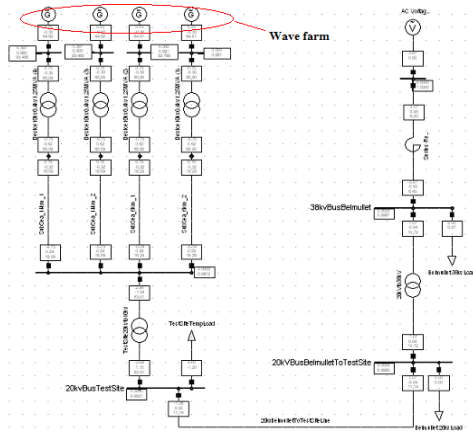

Figure 1 Grid model

The mechanical power input to each generator is modelled as:

$$P_{mech} = P_{avg} + \sum \alpha_i \sin(\omega_i t)$$

It is hence the sum of a constant power (P_{avg}) and of one (or more) sinusoidal terms. These sinusoidal terms represent the power fluctuations due to waves or to groups of waves. For the purpose of the simulation, the mechanical power may include up to three sinusoidal terms. As the presence of larger amounts of energy storage results in smaller power fluctuations around the mean value, varying the amplitude of these sinusoidal terms models the effect of varying levels of energy storage within the device.

In this study, the maximum average power of the wave farm is equal to 5 MW (this is explained more in detail in the “Grid code requirements” section).

2. Grid code requirements

No grid code requirement has been issued for marine energy converters as yet, but it is thought that similar requirements will be applied for both wind turbines and marine energy converters, at least initially. Hence, the simulation results were compared to the requirements for wind turbines.

The Irish Distribution System Operator (ESB) refers to standard EN 50160 for voltage disturbances in its Distribution Code [2].

This standard states that rapid voltage changes should have a magnitude not exceeding 4% of rated voltage on the medium voltage system (from 10 kV up to 38 kV in the Irish system) for the supply voltage and under normal conditions [3].

In practice, a 3% voltage limit is commonly used so as to ensure that the new installation does not cause the flicker severity level to exceed the limits [4-5]. Besides, these recommendations mention that the shape of the

rapid voltage change does not matter: its *magnitude* only is important. This 3% limit was taken as the maximum limit for voltage change for the study.

However, it is thought that this limit is based on empirical experience and may not be perfectly suited in the case of the assessment of wave energy grid integration, especially on a weak grid. However, this study is a preliminary analysis: it is intended to study the flicker severity level created by the wave farm and cross-check it with the commonly used 3% voltage limit in the coming future.

3. Load flow

None of the electrical components (e.g. line, transformer, etc.) are overloaded: the loading never exceeds 65 %.

The voltage requirements are explicitly specified for the higher limits only at the point of common coupling. The lower limits are not defined in the Distribution Code and are variable according to the operating conditions and to the location [6].

The point of common coupling is located at the 20 kV bus connected to the 10 kV/20 kV transformer. The point of connection to the grid is located at the 10 kV bus. The voltage limits for the point of common coupling are more stringent and detailed than for the point of connection. Consequently, the requirements for the PCC were applied for both the point of connection and the PCC for an ease of analyse.

The highest voltage limit is equal to 1.1 pu from 230 V to 110 kV, and is hence 10% above rated voltage. It was assumed that the lowest limit was 10 % below the rated voltage as well, resulting in a lowest limit of 0.90 pu. With respect to these assumptions, the voltage throughout the grid remains within the allowed range (Fig. 2).

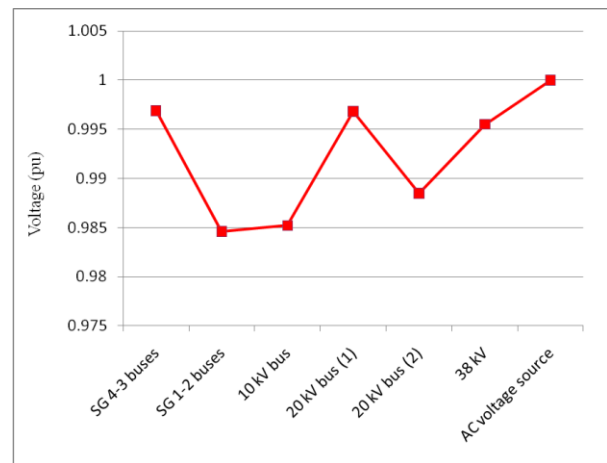

Figure 2 Voltage profile from the 10 kV bus to the ac voltage source

The lowest voltage is found at generator SG 1 and SG 2 busses (0.981 pu) and the highest voltage is found at the ac voltage source, whose voltage is set at 1.0 pu.

4. Power losses

The power losses are proportional to the square of current. Consequently, the power losses across the network are expected to increase relative to the load flow solution due to the varying current supplied by the wave farm. It is assumed that the impedance of the network is constant. However, this assumption is valid provided that the temperature of the resistive components and the network frequency are constant (or do not vary significantly over a power fluctuation period).

4.1 Load flow

Fig. 3 shows the distribution of real power losses with respect to each resistive component for the load flow.

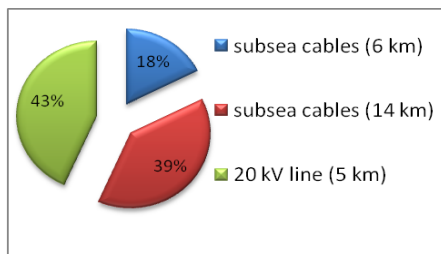

Figure 3 Distribution of power loss with respect to the electrical components (load flow)

The subsea cables and the overhead line are the only components to dissipate real power, as the transformers are assumed lossless. Both component types dissipate almost the same amount of power (43% for the overhead line, and 57% for the subsea cables).

Quantitatively, the real power losses represent 0.11 MW. For a wave farm of average capacity 3 MW, the efficiency of the network is thus equal to 96.3%. Losses are, as expected, not negligible considering the low X/R ratio and the low voltages of the system.

4.2 Dynamic simulations

The study focuses on the effect of power fluctuations on the power losses and hence dynamic simulations were carried out for several fluctuation amplitudes. The mechanical power is described as:

$$P_{mech} = P_{avg} + \alpha_1 \sin(\omega_1 t) + \alpha_2 \sin(\omega_2 t) + \alpha_3 \sin(\omega_3 t)$$

where the sinusoidal terms represent the power fluctuations associated with individual waves or with a group of waves.

The period of each sinusoidal term was kept constant during all the simulations (Table 1), the amplitudes only were changed (Table 2).

	T ₁	T ₂	T ₃
Period (s)	10	7	9

Table 1 Period of the sinusoidal terms

One of the amplitude set is taken as a reference (100%), from which all the other amplitude sets are derived by proportionality. This method enables the power fluctuations to keep the same shape.

% / amplitude (MW)	α_1	α_2	α_3
100 %	0.3	0.1	0.2
90 %	0.27	0.09	0.18
80 %	0.24	0.08	0.16
70 %	0.21	0.07	0.14
60 %	0.18	0.06	0.12
50 %	0.15	0.05	0.10

Table 2 Amplitude sets for the simulations

Fig. 4 shows the real power output of generator SG 1.

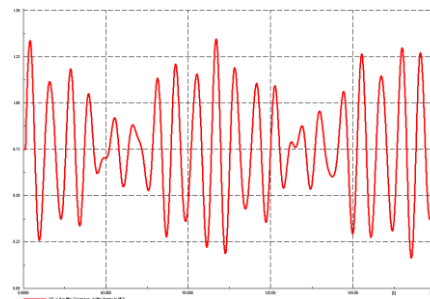

Figure 4 Power output of generator SG 1

In order to use a realistic wave farm power output, a phase shift was applied to each generator. The phase shifts for generators SG 2, 3 and 4 were created randomly under Matlab (Table 3).

Generators	SG 1	SG 2	SG 3	SG 4
Phase shift (°)	0	346.7	196.9	187.6

Table 3 Phase shifts

As mentioned earlier, the study focuses on the difference in power loss between two cases with either a constant or a variable current. This difference was calculated as:

$$\Delta P_{loss} = P_{variable} - P_{constant} = R(I_{variable}^2 - I_{constant}^2)$$

where R is the resistive component of the series impedance.

Clearly, the instantaneous loss difference can be positive ($I_{variable}^2 > I_{constant}^2$) or negative ($I_{variable}^2 < I_{constant}^2$). However, the mean energy loss (i.e. the integral of the power loss over time) is positive: there are more losses for a varying current than with a constant current.

The extra power loss due to the varying current decreases the network mean efficiency. Fig. 5 shows the network instantaneous efficiency for the reference amplitude set (100%) and for the 50% amplitude set.

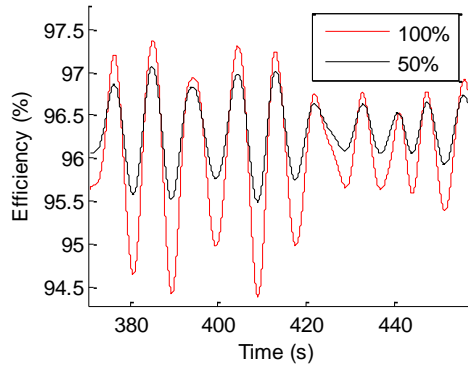

Figure 5 Efficiency of the network

The load flow results indicated that the network efficiency was equal to 96.3% (as 0.11 MW was lost over 3 MW). In the dynamic case, the efficiency oscillates around a mean value, which is smaller than the load flow efficiency.

As expected, the network mean efficiency decreases with respect to the power fluctuation amplitude. A maximum efficiency decrease of 0.2% is observed between the load flow (96.3%) and the dynamic case using the 100% amplitude set (96.1%). This may be considered as negligible but must still be noted: the efficiency may decrease significantly when the power capacity of the wave farm is higher.

Besides, the higher the instantaneous generated power, the higher the instantaneous power loss. Consequently, the efficiency is out-of-phase with respect to the generated power and as a result, the power exported to the rest of the network is smoother compared to the generated power (input). Fig. 6 shows the standard deviation of both the power exported by the generators (called P_{in}) and the power absorbed by the ac voltage source (called P_{out}).

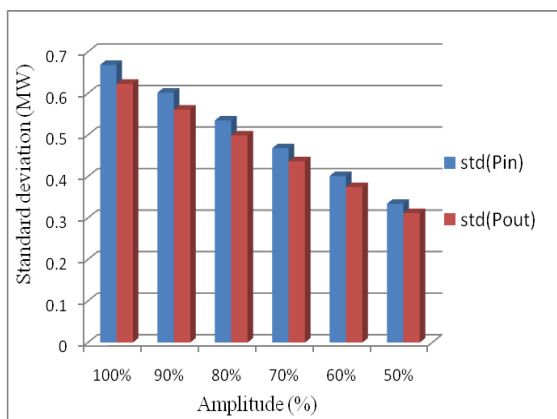

Figure 6 Standard deviation of P_{in} and P_{out}

Fig. 7 shows the difference between the standard deviation of P_{in} and P_{out} with respect to the fluctuation amplitude.

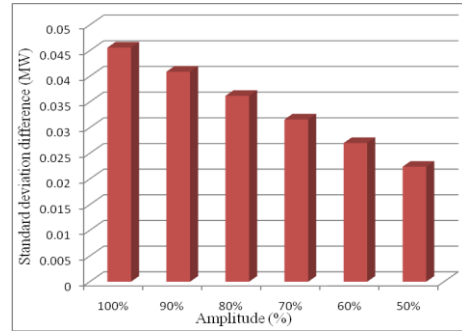

Figure 7 Difference between the standard deviation of P_{in} and P_{out}

This difference is up to 0.025 MW for the 100% amplitude case, which is negligible. However, this power smoothing effect from the network might be significant for higher wave farm power capacities.

5. Aggregation of devices

Aggregation of array of devices is often modelled by shifting the power output of each device by a random phase shift. This study intends to investigate the power smoothing effect due to this device aggregation. In this analysis, the mechanical power consists of a sum of an average power and of three sinusoidal terms as:

$$P_{mech} = P_{avg} + \alpha_1 \sin(\omega_1 t) + \alpha_2 \sin(\omega_2 t) + \alpha_3 \sin(\omega_3 t)$$

The three sinusoidal terms have the following periods and amplitudes:

α_i (MW)	T_i (s)
0.3	10
0.1	7
0.2	9

Table 4 Amplitudes and periods of the sinusoidal terms

The power output of generator SG 1 is shown in Fig. 4. The phase random shifts between generators, with respect the phase of generator SG 1, are given in Table 5.

set #	SG 1	SG 2	SG 3	SG 4
1	0°	42.3°	106.8°	114.8°
2	0°	152.7°	182.8°	30.8°
3	0°	94.5°	288.4°	10.5°
4	0°	334.4°	262.9°	175.9°
5	0°	208.3°	85.4°	165.2°
6	0°	346.7°	196.9°	187.6°
7	0°	83.4°	176.0°	224.7°
8	0°	244.5°	142.4°	132.3°
9	0°	355.7°	13.6°	318.7°
10	0°	328.8°	286.6°	35.5°
ref	0°	0°	0°	0°

Table 5 Phase random shifts

A reference case, in which no phase shift is applied, was also studied. It is the worst case as all generator outputs are in phase and hence there is no power smoothing effect due to the device aggregation. Fig. 8 shows the maximum voltage standard deviation versus

the random phase shift sets. This maximum deviation occurs for every phase random shift set at the 10 kV bus.

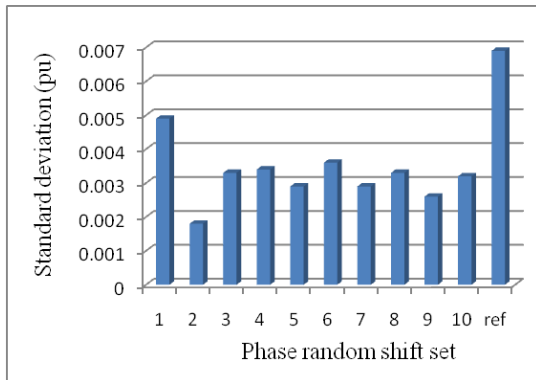

Figure 8 Maximum voltage standard deviation

It is clear from Fig. 8 that the voltage standard deviation can be dramatically reduced thanks to aggregation. The range may be significant for flicker severity level.

6. Contingency analysis

This study analyses the impact of generation unit loss on the voltage of the 10 kV bus. The generation loss consists of the loss of one, two, three or even the four generators.

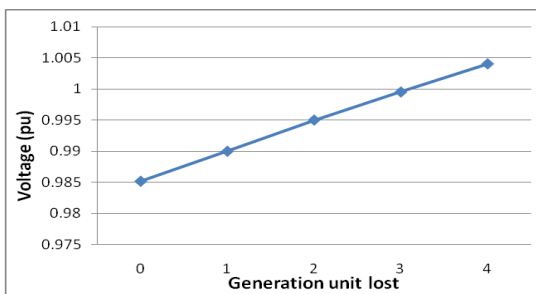

Figure 9 Voltage at the 10 kV bus versus number of generation unit lost

It is clear from Fig. 9 that the voltage remains in the allowed range [0.90 pu, 1.1 pu], even for a complete loss of the wave farm.

7. Voltage limits and voltage change

In this analysis, the power fluctuations are sinusoidal at a single frequency. The fluctuation period is equal to 10 s and there is no phase shift applied here (i.e. all the generator outputs are in phase). The average power and the power fluctuation amplitude are varied so as to analyse their impact on the grid voltages.

7.1 Voltage limits

The voltage limits study is performed for a range of wave farm power (average) capacity from 1 MW to 5 MW. Considering the power fluctuations, the maximum generated power is sometimes higher than

5 MW, sometimes lower. Having a power output higher than 5 MW implies that more stringent grid code requirements have to be applied for the wave farm [7]. However, it is unclear how these regulations would actually be applied to the wave farm, considering the very oscillatory characteristics of the power output (e.g. would they be applied on the maximum average power or on the maximum instantaneous power?). In this study, it was thus considered that regulations for power plant of capacity less than 5 MW are still applicable in this situation.

According to the requirement of the Irish Distribution System Operator (ESB), the voltage should remain in the allowed range specified in the Irish Distribution Code. The maximum and minimum voltages were hence analysed with dynamic simulations at the 10 kV, 20 kV (connected to the 10 kV/20 kV transformer) and 38 kV busses.

As mentioned earlier, the voltage of the ac voltage source is set at 1.0 pu. The per-unit voltage decreases progressively in direction of the wave farm, and thus the maximum voltage limits are not exceeded in the load flow case. Fig. 10 shows the maximum voltage values at the 10 kV, the 20 kV and the 38 kV busses versus wave farm power capacity.

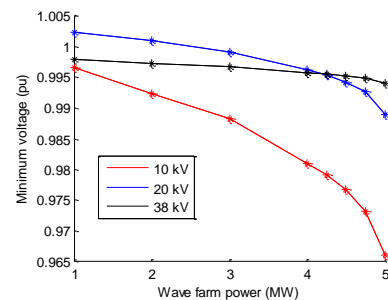

Figure 10 Maximum voltage values at the 10 kV, 20 kV and 38 kV busses

It is clear here that the highest voltage limit (1.1 pu) is not exceeded here.

It is also interesting to study the minimum voltages. Fig. 11 shows the minimum voltages (always occurring at the 10 kV bus) for a range of power capacity from 1 MW to 5 MW.

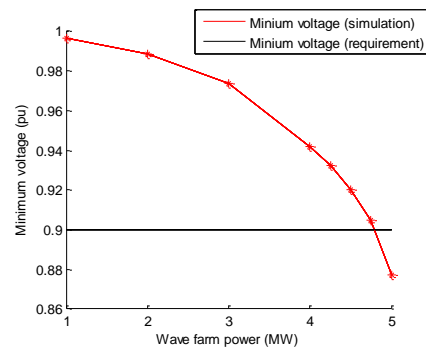

Figure 11 Minimum voltages

The minimum voltage is always greater than the lowest voltage limit for a power capacity from 1 MW

to 4.75 MW. However, it goes below the limit for a power capacity of 5 MW with a fluctuation amplitude of 5 MW. For this power capacity, a fluctuation amplitude of 2.4 MW (i.e. 96% of the average power equal to 3 MW) must not be exceeded for the voltage to remain in the allowed range.

7.2 Voltage change

As stated previously in the “Grid code requirements” section, a 3% voltage limit is generally applied to voltage change magnitude to ensure that the flicker severity level is low enough across the network. This study intends to determine the limit of the power fluctuation amplitude that causes this voltage change magnitude to be exceeded. This study was carried out for several average power capacities from 1 MW to 5 MW.

Fig. 12 shows the maximum amplitude allowed for power fluctuations (as a percentage of the total generating capacity of the wave farm). It is shown here that for a generation power up to 3 MW (included), the voltage changes induced on the grid have a magnitude smaller than 0.03 pu, even for extreme power fluctuations (from zero to peak value).

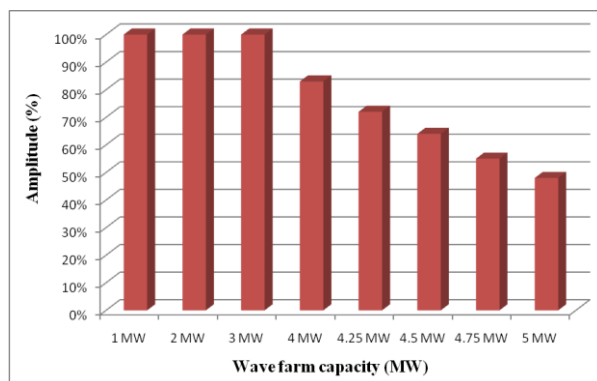

Figure 12 Maximum allowed power fluctuation amplitude

On the contrary, when power is greater than or equal to 4 MW, the fluctuation amplitude must not be greater than a certain limit, shown in Fig. 12. Hence, storage is needed to smooth the power variations if large power fluctuation amplitudes are to be expected.

The maximum allowed fluctuation amplitude (in %) follows an inverse exponential trend with respect to the power capacity (in MW) from $P_{avg}=4$ MW.

8. Conclusion

The modelling approach for implementing a varying source of power was detailed.

Both load flow and dynamic simulations were carried out, and the results compared to the Distribution Code requirements (for voltage limits and voltage change magnitude). Studies focusing on power losses and the effect of devices aggregation on the electrical power were also performed.

Acknowledgements

The authors wish to acknowledge the Charles Parsons Initiative funding agency. They also wish to thank James Griffiths for his technical help.

References

- [1] PSS/e generic wind turbine model WT3
- [2] ESB’s Distribution Code version 2.0 (2007), section DCC6.8.1
- [3] Standard EN 50160, “Voltage characteristics in public distribution system”
- [4] Engineering Recommendation P28, “Planning limits for voltage fluctuations caused by industrial, commercial and domestic equipment in the United Kingdom”, 1989
- [5] IEC 61000-2-12, “Electromagnetic compatibility – Part 2-12”
- [6] ESB’s Distribution Code version 2.0 (2007), section DPC4.2.2
- [7] ESB’s Distribution Code version 2.0 (2007), section DCC11.1.2