

## Modeling and control of Rankine based waste heat recovery systems for heavy duty trucks

Vincent GRELET<sup>1,2,3</sup>, Thomas REICHE<sup>1</sup>, Madiha NADRI<sup>2</sup>, Pascal DUFOUR<sup>2</sup> and Vincent LEMORT<sup>3</sup>

<sup>1</sup>Volvo Group Trucks Technology Advanced Technology and Research, 1 avenue Henri Germain, 69800 Saint Priest, France

<sup>2</sup>Université de Lyon, Lyon F-69003, Université Lyon 1, CNRS UMR 5007, Laboratory of Process Control and Chemical Engineering (LAGEP), Villeurbanne 69100, France

<sup>3</sup>LABOTHAP, University of Liege, Campus du Sart Tilman Bat. B49 B4000 Liege, Belgium

International Symposium on Advanced Control of Chemical Processes  
7-10 June, Whistler, British Columbia, Canada

## Table of contents

- 1 Context and motivations
- 2 Waste heat recovery Rankine cycle based
- 3 Studied system
- 4 Control oriented modeling
  - Model assumptions and governing equations
  - Heat transfer
  - Working fluid properties
  - Discretization
- 5 Controller development
  - Implementation constraint
  - Model identification
  - State of the art PID controller
  - Nonlinear model inversion
  - Controllers structure
- 6 Simulation results
- 7 Conclusion and next steps
- 8 Contacts and discussion

## Context and motivations

In nowadays heavy duty engines, a major part of the chemical energy contained in the fuel is released to the ambient through heat.

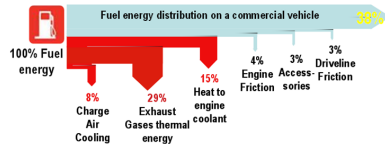

## Context and motivations

- In nowadays heavy duty engines, a major part of the chemical energy contained in the fuel is released to the ambient through heat.
- Waste heat recovery based on the Rankine cycle is a promising technique to increase fuel efficiency.

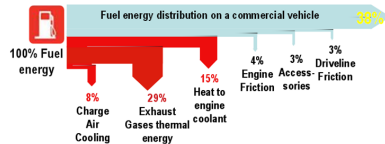

## Context and motivations

- 🔴 In nowadays heavy duty engines, a major part of the chemical energy contained in the fuel is released to the ambient through heat.
- 🟢 Waste heat recovery based on the Rankine cycle is a promising technique to increase fuel efficiency.
- 🔴 Long and frequent transient behavior of the heat sources makes good control strategies mandatory.

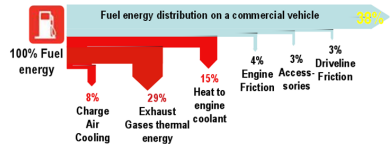

## Waste heat recovery Rankine cycle based

- Rankine cycle is widely known and used for power generation.
- It is based on four basic transformations:

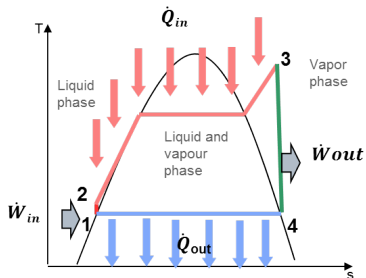

## Waste heat recovery Rankine cycle based

- Rankine cycle is widely known and used for power generation.
- It is based on four basic transformations:
  - The liquid is compressed from condensing to evaporating pressure ( $1 \rightarrow 2$ ).

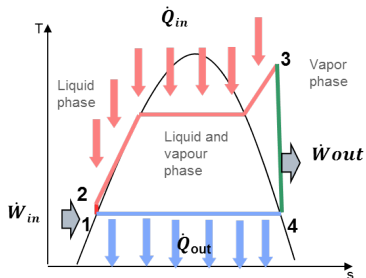

## Waste heat recovery Rankine cycle based

- Rankine cycle is widely known and used for power generation.
- It is based on four basic transformations:
  - The liquid is compressed from condensing to evaporating pressure ( $1 \rightarrow 2$ ).
  - It is then pre-heat, vaporize and superheat ( $2 \rightarrow 3$ ).

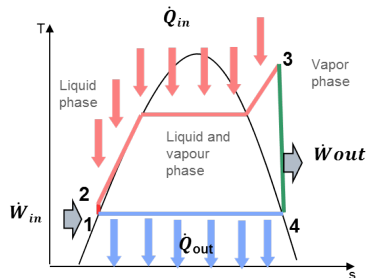



## Waste heat recovery Rankine cycle based

- Rankine cycle is widely known and used for power generation.
- It is based on four basic transformations:
  - The liquid is compressed from condensing to evaporating pressure ( $1 \rightarrow 2$ ).
  - It is then pre-heat, vaporize and superheat ( $2 \rightarrow 3$ ).
  - It expands from evaporating to condensing pressure ( $3 \rightarrow 4$ ).

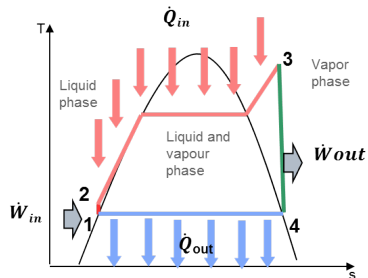

## Waste heat recovery Rankine cycle based

- Rankine cycle is widely known and used for power generation.
- It is based on four basic transformations:
  - The liquid is compressed from condensing to evaporating pressure ( $1 \rightarrow 2$ ).
  - It is then pre-heat, vaporize and superheat ( $2 \rightarrow 3$ ).
  - It expands from evaporating to condensing pressure ( $3 \rightarrow 4$ ).
  - It condenses and goes back to liquid state ( $4 \rightarrow 1$ ).

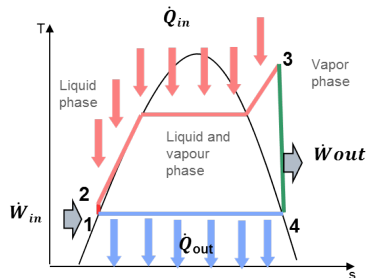

## Studied system

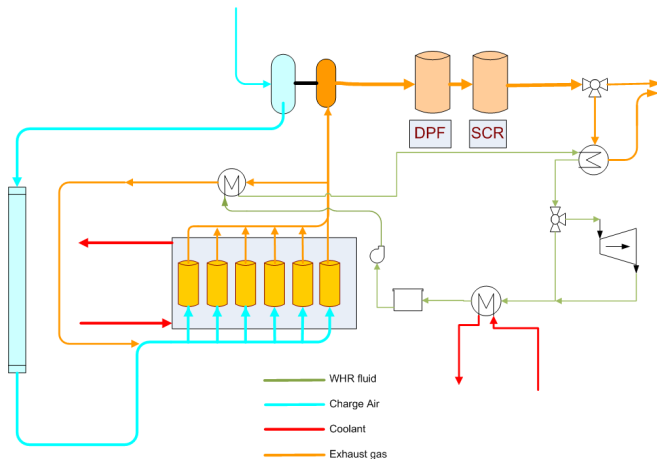

## Model assumptions and governing equations

### Model assumptions

- Geometry is reduced to a single pipe in pipe HEX.
- Secondary (or transfer) fluid always in single phase.
- Conduction is neglected.
- Pressure drops are neglected.
- Pressure dynamic is neglected.
- Fluid properties are evaluated at the outlet of each node.
- Mass flow rates are supposed constant along the HEX.

### Governing equation

- Internal fluid

$$A_{cross,f} \frac{\partial \rho_f h_f}{\partial t} + \frac{\partial \dot{m}_f h_f}{\partial z} + \dot{q}_{f,int} = 0. \quad (1)$$

- Internal pipe wall

$$\dot{q}_{f,int} + \dot{q}_{g,int} = \frac{\partial m_{w,int} c_{p_w,int} T_{w,int}}{\partial t}. \quad (2)$$

- External fluid

$$\frac{\partial \dot{m}_g c_{p_g} T_g}{\partial z} + \frac{\partial \dot{m}_g c_{p_g} T_g}{\partial t} + \dot{q}_{g,int} + \dot{q}_{g,ext} = 0. \quad (3)$$

- External pipe wall

$$\dot{q}_{g,ext} + \dot{q}_{amb,ext} = \frac{\partial m_{w,ext} c_{p_w,ext} T_{w,ext}}{\partial t}. \quad (4)$$

## Heat transfer

### Heat transfer coefficients

$$\alpha_g = \alpha_{ref,g} \dot{m}_g^{n_g} \quad (5)$$

$$\alpha_{f,liq} = \alpha_{ref,f,liq} \dot{m}_f^{n_{f,liq}} \quad (6)$$

$$\alpha_{f,2\varphi} = \alpha_{f,liq} \dots$$

$$\dots \left\{ (1-q)^{0.01} \left[ (1-q) + 1.2q^{0.4} \frac{\rho_{f,sat,liq}^{0.37}}{\rho_{f,sat,vap}} \right]^{-2.2} + \dots \right. \\ \left. \dots q^{0.01} \left[ \frac{\alpha_{f,vap}}{\alpha_{f,liq}} \left( 1 + 8(1-q)^{0.7} \frac{\rho_{f,sat,liq}^{0.67}}{\rho_{f,sat,vap}} \right) \right]^{-2} \right\}^{-0.5} \quad (7)$$

$$\alpha_{f,vap} = \alpha_{ref,f,vap} \dot{m}_f^{n_{f,vap}} \quad (8)$$

## Heat transfer

### Heat transfer EGR boiler

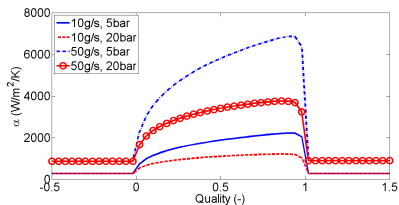

### Heat transfer exhaust boiler

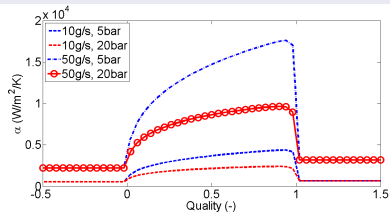

## Working fluid properties

### Working fluid properties models

- Temperature:

$$T_f = \begin{cases} a_{T,liq} h_f^2 + b_{T,liq} h_f + c_{T,liq} & \text{if } h_f \leq h_{sat,liq} \\ T_{sat,liq} + q (T_{sat,vap} - T_{sat,liq}) & \text{if } h_{sat,liq} \geq h_f \geq h_{sat,vap} \\ a_{T,vap} h_f^2 + b_{T,vap} h_f + c_{T,vap} & \text{if } h_f \geq h_{sat,vap} \end{cases} \quad (9)$$

- Density

$$\rho_f = \begin{cases} a_{\rho,liq} h_f^2 + b_{\rho,liq} h_f + c_{\rho,liq} & \text{if } h_f \leq h_{sat,liq} \\ \frac{1}{a_{\rho,2\varphi} h_f + b_{\rho,2\varphi}} & \text{if } h_{sat,liq} \geq h_f \geq h_{sat,vap} \\ a_{\rho,vap} h_f^2 + b_{\rho,vap} h_f + c_{\rho,vap} & \text{if } h_f \geq h_{sat,vap} \end{cases} \quad (10)$$

## Working fluid properties

### Temperature model validation

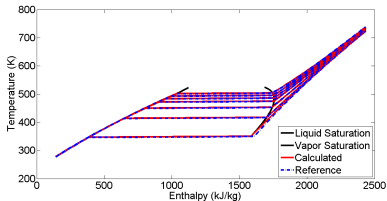

### Density model validation

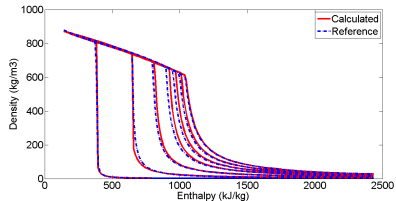



## Discretization

- The continuous set of equation (1,2,3,4) is discretized with respect to space based finite differences.
- A finite volume approach is chosen where the HEX is split into  $n$  longitudinal cell.
- The vector  $u$  contains the manipulated variable  $\dot{m}_{f,0}$  and the input disturbances:  $\dot{m}_{g,L}$ ,  $T_{g,L}$ ,  $h_{f,0}$ ,  $P_{f,0}$ .

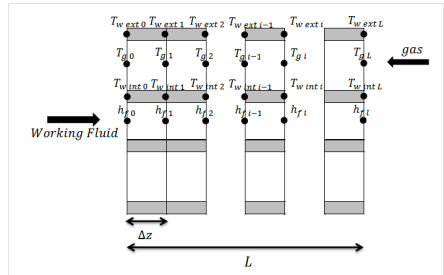

## Discretization

- The system of equations defining the response of the  $i^{\text{th}}$  cell of the discretized model is:

$$\dot{x}_i = f_i(x_i, u), \quad (11)$$

$$\text{where: } u = [\dot{m}_{f,0} \quad P_{f,0} \quad h_{f,0} \quad \dot{m}_{g,L} \quad T_{g,L}], \quad (12)$$

$$x_i = [h_{f,i} \quad T_{w,int,i} \quad T_{g,i} \quad T_{w,ext,i}], \quad (13)$$

$$f_i(x_i, u) = \left[ \begin{array}{c} \frac{\dot{m}_f (h_{f,i-1} - h_{f,i}) - \alpha_{f,i} A_{exch,f,int} (T_{f,i} - T_{w,int,i})}{\rho_{f,i} V_f} \\ \frac{\alpha_{f,i} A_{exch,f,int} (T_{f,i} - T_{w,int,i}) + \alpha_{g,i} A_{exch,g,int} (T_{g,i} - T_{w,int,i})}{\rho_{w,int} V_{w,int}} \\ \frac{\dot{m}_g c_{p,g} (T_{g,i-1} - T_{g,i}) - \alpha_{g,i} [A_{exch,g,int} (T_{g,i} - T_{w,int,i}) - A_{exch,g,ext} (T_{g,i} - T_{w,ext,i})]}{\rho_{g,i} V_g c_{p,g}} \\ \frac{\alpha_{amb} A_{exch,amb,ext} (T_{amb} - T_{w,ext,i}) + \alpha_{g,i} A_{exch,g,ext} (T_{g,i} - T_{w,ext,i})}{\rho_{w,ext} V_{w,ext}} \end{array} \right] \quad (14)$$

## Implementation constraint

Classical automotive electronic control unit (ECU) constrains the implementation of controllers:

- Simulink based environment.
- Controller must be discretized in time.
- Backward Euler integration scheme has to be used with a sample time of 20ms.
- Calculation must stay as simple as possible (problems have to be rescaled to avoid the use of high computational capacity demand functions).

## Model identification

- First order plus time delay models are identified in open loop around several operating points with output error minimization algorithm.
- The dynamic relation between the working fluid temperature and mass flow variations is:

$$\frac{\Delta T_{f,L}}{\Delta \dot{m}_f} = \frac{G}{1 + \tau S} e^{-D_s} \quad (15)$$

- According to the non linearity of model 11 FOPTD parameters vary a lot.

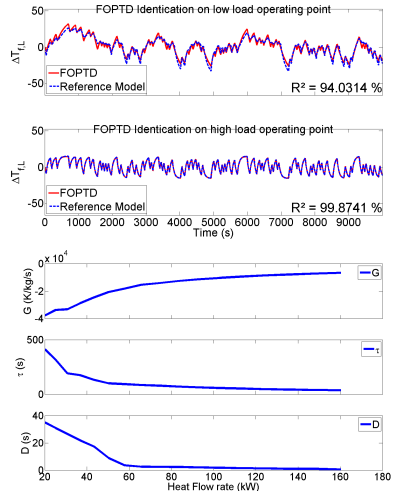

## State of the art PID controller

- State of the art controller in the automotive industry is the PID controller.
- A well known improvement is the gain scheduling approach.
  - Gains are calculated offline and linearly interpolated according to the mass flow sensor signal.
- Several PID tuning methods have been compared on a load step change.

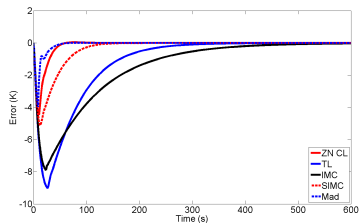
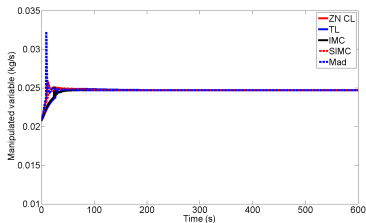

## Nonlinear model inversion

- Fastest dynamics (i.e. fluid and gas) are canceled.
- Single phases working fluid heat transfer coefficients are assumed constant.
- The system of equations defining the response of the  $i^{\text{th}}$  cell can be written:

$$\left\{ \begin{array}{l} 0 \\ \frac{\partial T_{w_{int}i}}{\partial t} \\ 0 \\ \frac{\partial T_{w_{ext}i}}{\partial t} \end{array} \right. = \begin{array}{l} \dot{m}_f (h_{f_{i-1}} - h_{f_i}) + \dot{Q}_{f_{int}i} \\ \dot{Q}_{f_{int}i} + \dot{Q}_{g_{int}i} \\ \dot{m}_g c_{p_g} (T_{g_{i-1}} - T_{g_i}) + \dot{Q}_{g_{int}i} + \dot{Q}_{g_{ext}i} \\ \dot{Q}_{g_{ext}i} + \dot{Q}_{amb_{ext}i} \end{array} \quad (16)$$

- The expression of the feedforward term  $U_{feedforward}$  is then straightforward:

$$U_{feedforward} = \frac{\sum_{i=1}^N \dot{Q}_{f_{int}i}}{h_{f_0} - h_{f_L}} \quad (17)$$

## Controllers structure

### Feedback controller

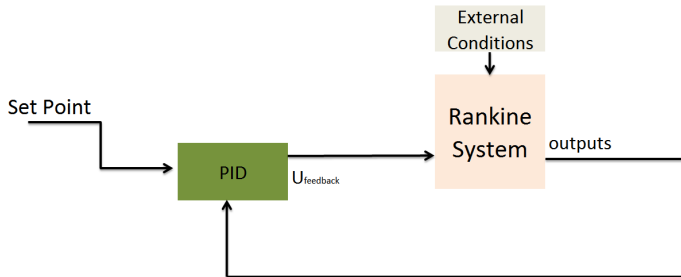

## Controllers structure

### Nonlinear controller

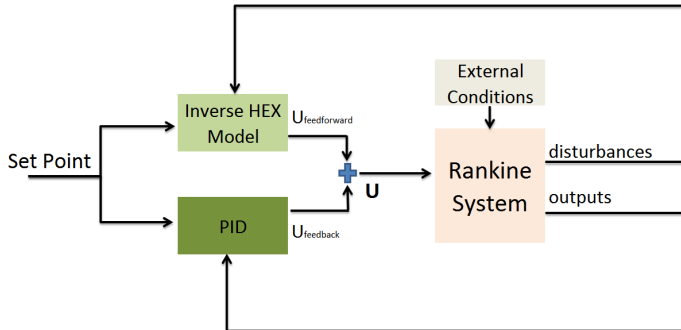



## Simulation environment

Pump and expansion machine models are added to represent the high pressure part of the Rankine system.

- Pump model:

$$\dot{m}_f = \rho_{f,in} \frac{N_{pump}}{60} C_{c,pump} \eta_{vol,pump} \cdot (18)$$

- Expansion machine:

$$\dot{m}_f = k_{eq} \sqrt{\rho_{f,in} P_{f,in} \left( 1 - \frac{P_{f,in}}{P_{f,out}} \right)^{-2}} \cdot (19)$$

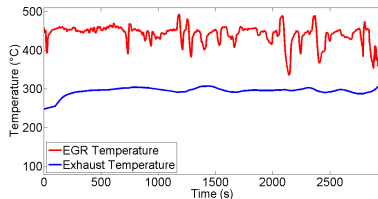
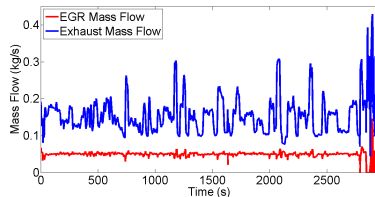

## Controller comparison

- Initial set point and disturbances change are not handle by PID controller.
- The non linear controller reduce the deviation from  $\pm 10^{\circ}\text{C}$  with the PID to  $\pm 3^{\circ}\text{C}$ .

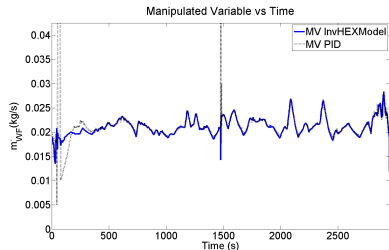
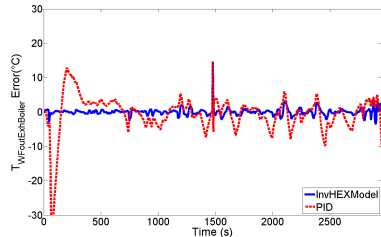

## Conclusion and next steps

### Conclusion

- A control strategy for temperature management of WHRS Rankine cycle based is presented.
- Main objective to stabilize the temperature around a given set point is better achieved by using a non linear controller.
- Non linear controller is compliant with implementation constraint relative to automotive industry.

### Next steps

- Controller sensitivity to parameters mismatch.
- Controller robustness.
- Optimal high level control strategy (set points generation).

## Contacts and discussion

### Authors

- Vincent GRELET: [vincent.grelet@volvo.com](mailto:vincent.grelet@volvo.com)
- Thomas REICHE: [thomas.reiche@volvo.com](mailto:thomas.reiche@volvo.com)
- Madiha NADRI: [nadri@lagep.univ-lyon1.fr](mailto:nadri@lagep.univ-lyon1.fr)
- Pascal DUFOUR: [dufour@lagep.univ-lyon1.fr](mailto:dufour@lagep.univ-lyon1.fr)
- Vincent LEMORT: [vincent.lemort@ulg.ac.be](mailto:vincent.lemort@ulg.ac.be)

### Acknowledgement

This PhD thesis is collaboration between UCBL1, ULg and Volvo Trucks which is gratefully acknowledged for the funding. The French ministry of higher education and research for the financial support of the CIFRE PhD thesis 2012/549 is also acknowledged.