



HAL
open science

Grooved Laminated Waveguides in LTCC for mm-wave packaging

Camilla Kärnfelt, Pascal Coant, Maïna Sinou, Jean-Philippe Coupez, Daniel Bourreau, Alain Peden

► **To cite this version:**

Camilla Kärnfelt, Pascal Coant, Maïna Sinou, Jean-Philippe Coupez, Daniel Bourreau, et al.. Grooved Laminated Waveguides in LTCC for mm-wave packaging. MiNaPAD 2015 : Micro/Nano-electronics Packaging and Assembly, Design and manufacturing Forum, Apr 2015, Grenoble, France. hal-01264389

HAL Id: hal-01264389

<https://hal.science/hal-01264389>

Submitted on 29 Jan 2016

HAL is a multi-disciplinary open access archive for the deposit and dissemination of scientific research documents, whether they are published or not. The documents may come from teaching and research institutions in France or abroad, or from public or private research centers.

L'archive ouverte pluridisciplinaire **HAL**, est destinée au dépôt et à la diffusion de documents scientifiques de niveau recherche, publiés ou non, émanant des établissements d'enseignement et de recherche français ou étrangers, des laboratoires publics ou privés.

Grooved Laminated Waveguides in LTCC for mm-wave Packaging

Camilla Kärnfelt, Pascal Coant, Maina Sinou, Jean-Philippe Coupez,
Daniel Bourreau, and Alain Péden

Microwave department, Télécom-Bretagne/Institut Mines-Télécom, Lab-Sticc UMR 6285,
Technopôle Brest-Iroise CS83818-29238 Brest Cedex 3 - France

Phone: +33 (0)2 29 00 14 82, fax: +33 (0)2 29 00 13 43, E-mail: camilla.karnfelt@telecom-bretagne.eu

Abstract

The Laminated Waveguide (LWG) has earned lots of attention recently in its one-layer form referred to as Substrate Integrated Waveguide (SIW). This paper reports on the fabrication and measurement results of a type of LWG, the Grooved Laminated Waveguide (GLWG) which is implemented in Low Temperature Co-fired Ceramics (LTCC). Results are given on the fabrication issues and measurements for GLWG devices realized in one and four LTCC layers, working in four distinct frequency bands; U, V, W and G, i.e. from 40 to 220 GHz.

Key words: Grooved laminated waveguide, GLWG, LTCC, millimeter wave circuit

Introduction

The development of components in frequency bands above 100 GHz is presently in progress in order to fulfill tomorrow's need of communication systems. One enabling factor for this development is that foundries have accomplished a great progress recently and are now capable of proposing Microwave Monolithic Integrated Circuits (MMIC) processes that allow for chip design up to near THz range and even beyond [1].

Today, no high volume packaging off the shelf solution exists for such mm-wave MMICs why they have to be integrated into a custom designed package. Several such examples are presented in [1] where mm-wave MMICs are placed into a waveguide structure with radiating probes to feed the signal from the chip into the waveguide. This is viable for components where a given frequency band is used, however this concept is neither low-cost nor mass-producible, thus, other approaches are needed. Hence, the aim to use mm-wave frequencies for high volume products challenges the packaging community to come up with new solutions for a successful integration of such chips.

Whichever solution might be used, different transmission line concepts for an "above-100 GHz use" should be studied since planar lines such as microstrip line, stripline and coplanar waveguide are less appropriate at higher frequencies. This is because unwanted modes such as the parallel plate mode, dielectric slab mode, and other higher order modes may propagate at mm-wave frequencies depending on the geometry of the transmission line and substrate parameters [2]. One interesting, rather

new, transmission line type that could compete with the planar lines is the Laminated Waveguide (LWG) which is fabricated on a multilayer substrate. It was first proposed and patented in 1992 followed by a scientific publication in 1998 [3]. This type of transmission line acts as a classical dielectric filled waveguide and can, if used within the fundamental mode's bandwidth, be advantageous with better control of propagating modes, smaller losses and better isolation between adjacent lines as compared to the planar transmission lines. Since it was first published, the use of LWGs as microwave transmission line support has been greatly adopted.

Common for the LWG and SIW (a single layer LWG) is that they are implemented using rows of metallized vias to make up the lateral walls of the guiding structures. In order to limit the unwanted radiation out from these walls, these vias must be kept small compared to the guided wavelength, λ_g , and placed within a center-to-center distance less than twice the via diameter [4]. Since the wavelength is inversely proportional to the frequency, these dimensions must be decreased with increased frequency. This is difficult to obtain for fabrication reasons and it is one of the main causes why the LWG/SIW with vias is restricted for use at frequencies below 100 GHz. This frequency limitation is removed if the lateral walls instead are made up of metallized grooves, as was realized and tested in [5]. This type of LWG, henceforth referred to as Grooved Laminated Waveguides (GLWG), is the subject of this paper. Different GLWG elements that could be included in a foreseen low-cost, low-weight and small form-factor packaging solution have been designed, fabricated and measured. In this

paper we report on the results of the feasibility of the GLWG for frequencies from U-band (40-60 GHz), V-band (50-75 GHz), W-band (75-110 GHz), up to G-band (140-220 GHz).

Design

The GLWG design is rather straight-forward. Since we use metallized grooves, the cut-off frequency for the fundamental TE_{10} mode of the GLWG is calculated as:

$$f_{cTE10} = \frac{c}{\sqrt{\epsilon_r} 2a} \quad \text{Eq.1}$$

where a denotes the inside width of the GLWG, c the speed of light and ϵ_r the relative permittivity.

Table 1 gives the dimensions of U-, V-, W- and G-band GLWGs using the ESL41110 LTCC tape from ElectroScience Laboratories¹. This tape has a relative permittivity, ϵ_r , of 4.2 to 4.7 depending on the frequency according to the manufacturer.

Losses in GLWGs are metallic and dielectric, denoted α_c and α_d respectively. The total loss α_{GLWG} is equal to the sum of α_c and α_d , however α_d is normally the most significant contributor. It can be easily proven that an inner height of the GLWG close to $0.5 \times a$ is preferable to minimize the losses in the GLWG. Since the ESL41110 tape is only 75 μm thick this means that a multilayered GLWG would be better in terms of transmission performance.

GLWG lines

To compare theory with measurements on the GLWGs' loss performance, we designed V-, W- and G-band lines in one-layered and four-layered versions. This is also in order to test the producibility of multilayered GLWG. On a second prototype, we also designed a U-band line as a reference to be compared to other structures.

Table 1: Dimensions of GLWG using ESL41110 tape. All dimensions are in μm ; a and b denotes the inner width and height respectively.

Band→	U	V	W	G
a	2250	1770	1200	600
b	75	75	75	75
		300	300	300
Length GLWG	8500	4000	4000	4000
Length CPW (each)	1000	1000	1000	1000
f_{cTE10} GHz	31.391	39.785	59.015	115.75

CPW to GLWG transitions

In order to measure the GLWG devices, a CPW to GLWG transition was designed for each

¹http://www.electroscience.com/ceramic_tapes_systems.html

type of line, inspired by the one proposed in [6]. The coplanar line at the ends of the devices under test is then accessible by Ground Signal Ground (GSG) probes. We use such probes from Picoprobe with 150 μm pitch for the U-band devices and 100 μm pitch for the V-, W-, and G-band devices. No special calibration kit were designed, instead the CS5 calibration kit from Picoprobe was used and the reference plane is always positioned at the probe tips, thus the impact of the transition itself is embedded in the measurement results.

Bends

Bends are one type of component that will be needed in any future GLWG based system. We have designed two types of bends: a smoothly rounded 90° bend and a 90° bend with a mitered external corner and a right angled inner corner. Fig. 1 shows the design parameters of the two bends, both designed for the U-band using a one-layered GLWG structure.

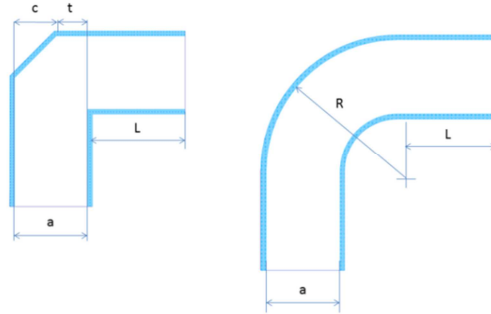

Figure 1: Mitered bend (left) and rounded bend (right). The design dimensions are: $t=965 \mu\text{m}$, $c=1285 \mu\text{m}$, $L=2850 \mu\text{m}$, $R=4000 \mu\text{m}$.

Tees

Tees are important elements in many devices such as power dividers, combiners and couplers. In a tee structure, an input signal is divided in two equal-amplitude and equally-phased parts. Two versions of a U-band tee were designed in this project: the first having a metallized via placed centrally to divide the incoming signal and guide it into the two branches and a second one where the groove is formed as a V-shaped peak inside the tee, for the same reason of dividing and guiding the incoming signal. They were both designed for U-band as a one layered GLWG structure. Fig. 2 shows the design dimensions.

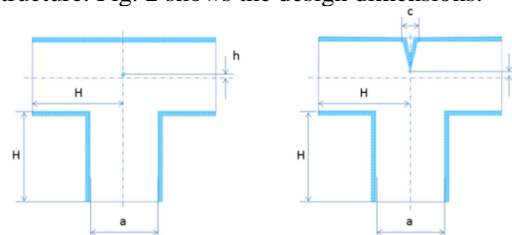

Figure 2: Tee designs: tee with metallized central via (left) and tee with a grooved peak (right). The design dimensions are: $H=3000 \mu\text{m}$, $t=135 \mu\text{m}$ and $c=500 \mu\text{m}$.

Loads

A load is a component that terminates a line with, ideally, no reflections of an electromagnetic wave that enters into the load. This type of component is interesting to terminate a line properly and also to allow the use of only two ports when measuring a three-port device, the third port is then terminated by such a load.

Our design is an open ended GLWG where an open tapered cavity is placed between the grooves where an absorbing or resistive material is inserted. Fig. 3 shows the design.

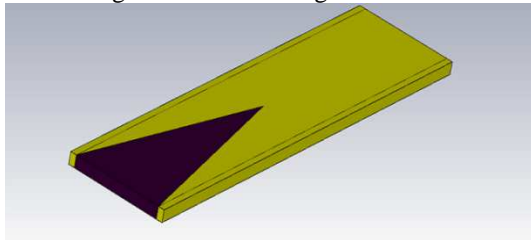

Figure 3: Load design. The tapered resistive/absorbing material is inserted in a cavity opening of the open ended GLWG. The taper length is $2 \times a$.

Prototype 1 and Prototype 2

Two prototypes are fabricated, "Prototype 1" with the GLWG lines for V-, W- and G-band and "Prototype 2" including U-band one-layer GLWG devices such as line, bends, tees and loads. The two prototypes can be seen in Fig. 4 where the different test devices are indicated by numbers placed above them.

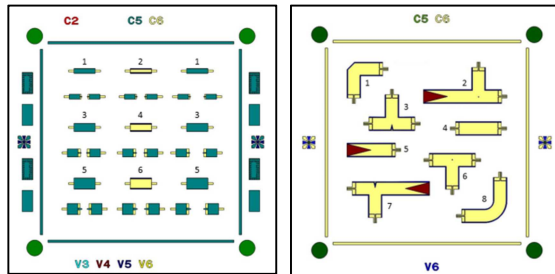

Figure 4: Left: Prototype 1 with GLWG lines. 1) G-band one layer, 2) G-band four layers, 3) W-band one layer, 4) W-band four layers, 5) V-band one layer, and 6) V-band four layers **Right: Prototype 2 with U-band GLWG devices on one layer.** 1) Mitered bend, 2) Tee with via and load on the third access, 3) Tee with grooved peak and three access ports, 4) GLWG line, 5) Load, 6) Tee with via and three access ports, 7) Tee with via and load on the third access, and 8) Rounded bend.

A more thorough description of the devices from an electrical point of view with simulation and measurement data is given in [7].

Fabrication procedure

To manufacture these GLWG devices, the regular LTCC production scheme was used as proposed by the tape supplier. Our LTCC process is

an all-gold system where ESL802 is used for vias and grooves and ESL803 is used for the metallization on top of each layer. The green state tapes are always cut into 50.8 by 50.8 mm² tapes. The sintering is performed in a static oven where the profile is programmed according to ESL's proposed profile. During this process step, the substrate shrinks by 15 % in x- and y-direction. In order to have an even shrink in both x- and y-direction it is important to dispose the devices over the substrate in such a manner that the layout is as symmetric as possible in terms of metallization, holes, grooves and other elements.

To realize these GLWG devices, some not so main-stream process steps had to be included in our manufacturing process. These are laser cutting of the grooves, filling the grooves, laser cutting of cavities after screen-printing, resistive paste filling and finally laser ablation.

Substrate stack-up

For both the one- and the four-layered GLWG structures the final LTCC substrate is a six layer stack where the top layers are used for the GLWGs. This is done since the device is fragile and the stack of six layers (which makes a total thickness of 450 μm) improves the mechanical strength. The substrate stack-up cross section is shown in Fig. 5.

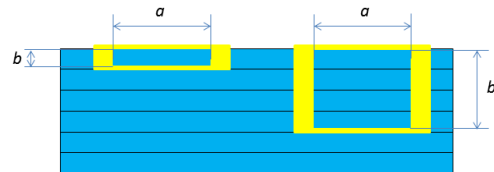

Figure 5: One layer and four layers GLWG stack up. In total, six LTCC layers are used.

Cutting of grooves

A micromachining station, Astree 250 from Novalase, based on a 1064 nm Nd:YAG laser, is used for all cutting work. The DPSSL laser "Aion Industrial-V" has a 25 μm beam diameter. Two modes of displacement are possible: the platinum displacement where the work holder moves and the laser beam is fixed and the deflection of the laser beam by galvanometric control of mirrors. To cut the grooves the second option is the only one that is useable since it allows a faster displacement of the beam and thus a sharper cut. The process parameters used to cut out the grooves in the 100 to 130 μm thick green tape were: a frequency set to 20 kHz, a power of 6 W, a displacement speed of 8 mm/s and one single pass. This mode allows cutting out motives in an area of 10 \times 10 mm only. Some of the GLWGs on Prototype 2, as the tees with a load on the third branch, are larger than this size, and thus the grooves had to be cut out in a two-step procedure, i.e. using two dxf-files and launching one after the other. Actually, the complete layout was divided into several sub-areas, for which a dxf-file was generated. The different sub-area dxf-files for a

specific substrate layer were loaded in a laser-procedure called "process" with their individual coordinate displacement indicated. The laser then uses the platinum displacement to position the work-holder for each smaller area and then the galvanometer deflection to cut out the grooves in each sub-area. Fig. 6 shows the sixth layer of Prototype 1 with the grooves cut out.

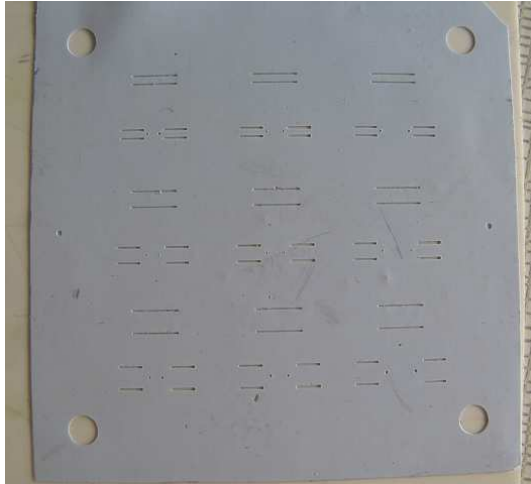

Figure 6: Prototype 1. The sixth layer after cutting the grooves with the micromachining laser. The tape size is $50.8 \times 50.8 \text{ mm}^2$. The four circular holes in the corners are for alignment on the stacking fixture, and the two smaller holes at half the substrate height are used for alignment during screen printing.

Screen printing filling the grooves

The GLWG grooves were filled using a regular screen printer Presco $7'' \times 8''$ and a 325 meshed screen with $25 \mu\text{m}$ stainless steel wires. The grooves are designed to be $150 \mu\text{m}$ wide after firing which means $180 \mu\text{m}$ in green state. This is a bit larger than the green state substrate thickness. The printing pattern was enlarged by $50 \mu\text{m}$ outside the grooves in order to bring some extra gold paste to the grooves and to ease on the precision requirement of the screen printer. Prototype 1 included the GLWG lines where the grooves were less well cut which resulted in grooves sometimes larger than designed, especially at the ends of the grooves. This was due to our learning of the process. Thus, for this prototype, the filling of the grooves was less good and some manual filling had to be done in order to assure the correct functioning of the GLWG lines. Prototype 2 included the U-band devices in the sixth layer. This was the first time that bends and angled grooves were fabricated and a certain uncertainty to how the filling would work out prevailed before the actual realization. However, these grooves were of a better laser cutting quality with more even width. Finally, the screen-printing worked fine for most parts using a print-print pass of the squeegee.

Fig.7 and Fig.8 show some layers of the two prototypes after screen-printing. The partially non-filled grooves are more evident on Prototype 1, Fig.

6. Some manual filling was also done on Prototype 2.

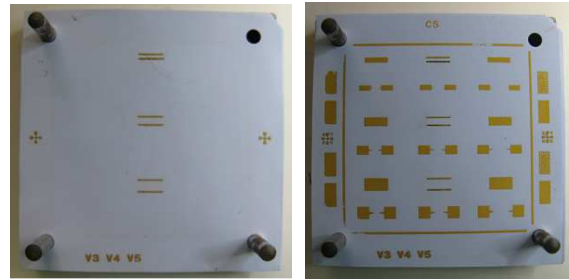

Figure 7: Prototype 1. The third and fourth layer look alike (left), the fifth layer (right) after groove filling and screen printing. The substrates are placed on the stacking support to obtain alignment between layers.

Once the grooves were filled with ESL802 paste, ESL803 paste was screen printed to make up the top metallization of the GLWGs. The bottom metallization was screen printed on the fifth layer or the second layer on the one layered and four layered GLWGs respectively. The four layered GLWGs thus have grooves in the third, fourth, fifth and sixth layer.

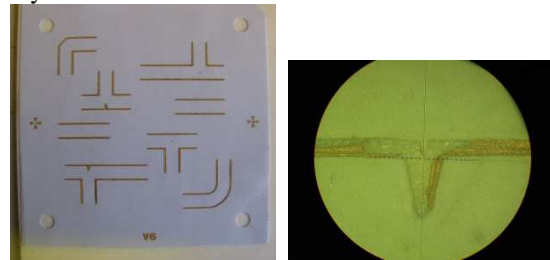

Figure 8: Prototype 2's sixth layer where the grooves are filled using screen-printing (left), and a detail of a part (the grooved peak to be exact) where the grooves were not filled (right). Manual filling had to be used to complete some parts of the grooves.

Cavity cut-out

On Prototype 2, a load is implemented in two different ways: a first one using an absorbent material, the Eccosorb MMI-SA, and a second one using a resistive paste. In the regular process we do screen printing after laser cutting and then we need a $150 \mu\text{m}$ clearance from the cut edge to the metallization in order to not soil the screen printer support. This is too large for a good functioning of the load. In order to realize the needed tapered opening inside the GLWG grooves, an additional laser cutting step had to be performed after screen printing. This allows for a minimal the distance between the metallization and the cavity.

Laser cutting is done using the same parameters as when the cutting of the grooves. A certain difficulty in correct positioning was observed but, all in all, a good cutting could be made although the cut was running into the edge of the top gold instead of, as was planned, at a distance of $50 \mu\text{m}$.

Nevertheless, the laser cut was well done and the tapered cavity was satisfying.

Before lamination and firing, the tapered cavities were filled with fugitive tape, ESL49000, having the same triangular shape as the cavity, Fig.9. The fugitive tape ensures that the cavity's shape remains unaltered during the lamination.

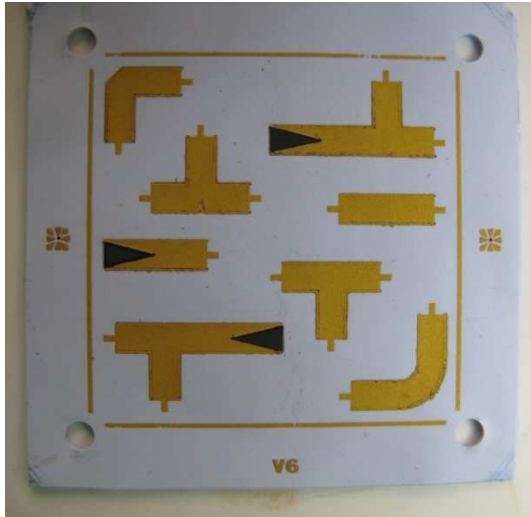

Figure 9: U-band prototype laminated stack with fugitive tape inserted inside the three cavities.

Resistive paste filling

The $1000 \Omega/\square$ resistive paste used here is the ESL2713, intended for use on thick film alumina substrate. It was manually filled in the tapered cavities after sintering, since it is not intended for co-firing. A post-firing step was performed using the profile as proposed by ESL, i.e. a rise from ambient temperature to 850°C during 80 minutes, then a hold at 850°C for 20 minutes. In our case, the temperature fall took 12 hours instead of the required 90 minutes, due to non-forced cooling.

Fig. 10 shows two U-band prototypes, one that has only been fired once using the ESL41110 profile, and the other substrate that has been exposed to the resistive paste post-firing.

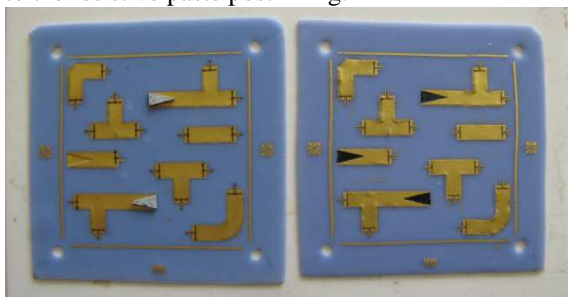

Figure 10: The finalized U-band prototypes. The prototype with Eccosorb MMI-SA absorbents (left) and the post-fired with resistive paste (right).

During this post-firing step the substrate shrunk, surprisingly, an additional 3 %. The additional shrink is visible from the photo where some wrinkles in the corners are observed.

Ablation

An ablation process is used to form the coplanar lines of the CPW to GLWG transition. These CPW lines must have a gap of $30 \mu\text{m}$ so that the impedance of the CPW line matches the 50Ω impedance of the probe station GSG probes. Such a small gap is not screen printable and we have therefore chosen to screen print a rectangular shape where we, after firing, proceed with laser ablation to form the non-gold gaps. This process is done using the same micromachining station as before, controlling its movement from a dxf-file, but this time using the following parameters found to agree with the wanted removal of the $6 \mu\text{m}$ thick gold: a frequency set to 40 kHz, a power of 4W, a displacement speed of 1 mm/s and 3 repetitions descending $3 \mu\text{m}$ each time. The resulting gap traces after ablation are about $15 \mu\text{m}$ deep.

Some variations occur in the dimensions of the transitions as they are designed for different bands and for different GLWG thickness, but the same laser parameters are always used. A typical ablation result is presented in Fig.11. We have been able to perform this laser ablation with an excellent yield.

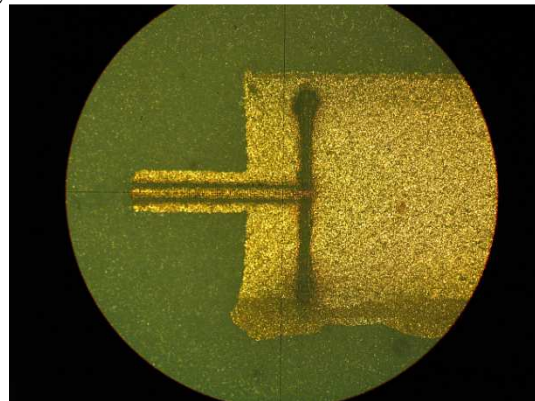

Figure 11: Microphotograph of a CPW to GLWG transition where laser ablation is used to form the opening gaps in the $6 \mu\text{m}$ thick gold. The uneven form of the gold metallization at the lower edge of the GLWG is due to the manual filling of the grooves and some unintentional spill-over. This, however, has no impact on the GLWGs performance.

Measurement results

These devices have been measured in a probe station using an Anritsu 37397C VNA (Vector Network Analyzer) and a Rohde Schwartz ZVT20 VNA with external multipliers, ZVA-Z110E and ZVA-Z170. Some results for the U-band and G-band GLWG lines are shown in Fig 12. These GLWG lines perform well, except the one-layered G-band line which was already not very good in simulation.

Analyzing the results one can see that the transmission losses are very well predicted, especially at the higher end of the designed- for frequency-band where. At the lower end, a several dB higher transmission loss is measured than

simulated. Some of this difference can be explained by a frequency shift between simulations and measurements that could be accounted for by a not accurate relative permittivity at all frequency points, a non 50 ohm coplanar line and a slight difference in dimensions between the simulated and the manufactured case. Nevertheless, even with these disagreements, we can conclude that the GLWG topology is a suitable choice for mm-wave transmission lines as we have achieved an excellent first time yield. For a more thorough analysis, and results from the other devices, please refer to [7].

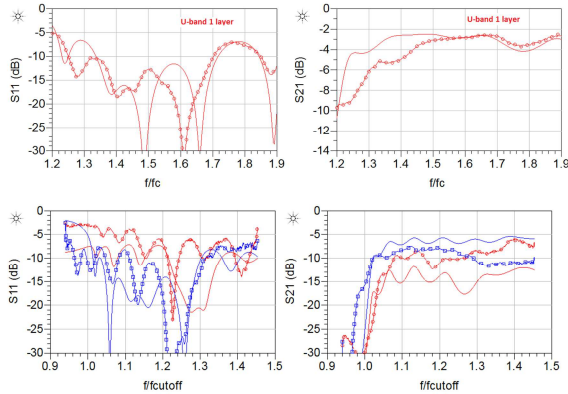

Figure 12: Simulated (-) and measured (-o-, -□-) results from the GLWG lines. U-band one-layer (upper plots), one-layered G-band (lower plots, red) and four-layered G-band (lower plots, blue). The frequency is normalized with the cut off frequency of the band.

The load, as presented in Fig.13, was the less successful device. Only the load with resistive paste was simulated, since no material data was available at the time for the MMI-SA material. However, other Eccosorb absorbers (GDF and MSF-124) were used in simulation and showed a better performance than the resistive paste version. In measurement, a slightly better result is achieved for the resistive paste version, but in no case the result is satisfactory.

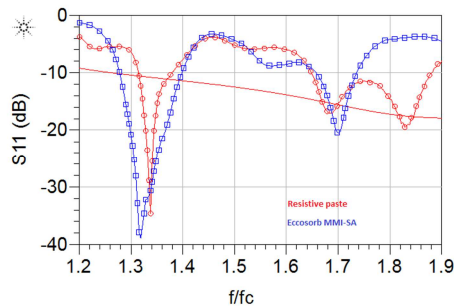

Figure 13: Simulated (-) and measured (-o-, -□-) results from U-band loads. Resistive paste (red, -o-) and the Eccosorb MMI-SA (blue, -□-).

Conclusions

We have designed different millimeter wave devices based on a GLWG topology. These devices were manufactured using ESL41110 LTCC tape as

one- and four-layer structures. Measurements show a satisfactory agreement with simulation data.

Additional LTCC production steps have been developed to assure the fabrication of the GLWG devices and have been validated as conformal to the needed requirements. It has been confirmed that four-layered and one-layered GLWG structures can be adequately fabricated on LTCC material for devices up to G-band frequencies.

The GLWG topology removes the high-end frequency limitation of LWGs (and SIWs), which has hindered their use for frequencies above 100 GHz. The GLWG topology has been proven to work up to 170 GHz.

Acknowledgements

The authors like to thank the Microwave department and Scientific direction at Télécom-Bretagne/Institut Mines Télécom for sponsoring this work. Thanks to Mr. Michel Bilinski from ESL Europe for precious advice throughout our LTCC work. Thanks to students Lamyae Khibabi and Benoit Fauré for their work on the U-band bends and tees, to Dr. Khodor Rida for his Ph.D. thesis work, that paved the way in setting up our in-house LTCC procedure, and finally to Mr. Raymond Jézéquel for help with the measurement setups.

References

- [1] L. A. Samoska, "An overview of solid-state integrated circuit amplifiers in the submillimeter-wave and THz regime," *Transactions on Terahertz Science and Technology, IEEE*, vol. 1, no 1, pp. 9-24, sept. 2011.
- [2] M. Steer, "Extraordinary Transmission Line Effects," in *Microwave and RF design - A system approach*, pp. 245-286 (984).
- [3] H. Uchimura, T. Takenoshita, and M. Fujii, "Development of a laminated waveguide," *IEEE Transactions on Microwave Theory and Techniques*, vol. 46, no 12, pp. 2438 -2443, dec. 1998.
- [4] K. Wu, D. Deslandes, and Y. Cassivi, "The Substrate Integrated Circuits - A New Concept for High-Frequency Electronics and Optoelectronics," *Mikrotalasna revija*, pp. 2-9, dec-2003.
- [5] M. F. Shafique and I. D. Robertson, "Laser machining of microvias and trenches for substrate integrated waveguides in LTCC technology," in *Microwave Conference, 2009. EuMC 2009. European, 2009*, pp. 272-275.
- [6] D. Deslandes and K. Wu, "Integrated transition of coplanar to rectangular waveguides," in *Microwave Symposium Digest, 2001 IEEE MTT-S International, 2001*, vol. 2, pp. 619-622 vol.2.
- [7] C. Kärfelt, P. Coant, M. Sinou, J.-P. Coupeze, D. Bourreau, and A. Péden, "Grooved Laminated Waveguide Devices for U-, V-, W- and G-band Applications," submitted to *EuMW2015, Paris, France, 2015*.