



HAL
open science

Towards an Automatic-optimized tool selection for milling process, based on data from Sandvik Coromant

Hanae Zarkti, Abdelilah El Mesbahi, Ahmed Rechia, Oussama Jaider

► To cite this version:

Hanae Zarkti, Abdelilah El Mesbahi, Ahmed Rechia, Oussama Jaider. Towards an Automatic-optimized tool selection for milling process, based on data from Sandvik Coromant. Xème Conférence Internationale: Conception et Production Intégrées, Dec 2015, Tanger, Morocco. hal-01260788

HAL Id: hal-01260788

<https://hal.science/hal-01260788v1>

Submitted on 22 Jan 2016

HAL is a multi-disciplinary open access archive for the deposit and dissemination of scientific research documents, whether they are published or not. The documents may come from teaching and research institutions in France or abroad, or from public or private research centers.

L'archive ouverte pluridisciplinaire **HAL**, est destinée au dépôt et à la diffusion de documents scientifiques de niveau recherche, publiés ou non, émanant des établissements d'enseignement et de recherche français ou étrangers, des laboratoires publics ou privés.

Towards an Automatic-optimized tool selection for milling process, based on data from Sandvik Coromant

Hanae Zarkti¹, Abdelilah El Mesbahi¹, Ahmed Rechia¹, Oussama Jaider¹

¹: Department of Mechanical Engineering
Faculty of Sciences and Technics
Tangier, Morocco

zarktihanae@gmail.com, elmesbahi_abdelilah@hotmail.com, rechia@hotmail.com, Jaider.oussama@gmail.com

Computer Aided Process Planning (CAPP) is one of the most important advances in the area of manufacturing engineering which plays a critical role, linking Computer Aided Design (CAD) and Computer Aided Manufacturing (CAM) activities. CAPP determines automatically the use of available resources, including machines, cutting inserts, holders, appropriate machining parameters such as cutting speed, feed rate, depth of cut, and generates automatic sequences of operations and instructions to convert a raw material into a required product with good surface finish. The production cost of a manufacturing component depends upon cost of workpiece material, tooling cost, and recurring expenses. Thus, it is clear that the only scope to reduce the overall cost of a workpiece is to focus on the tooling cost and machining time. Selecting an optimum insert, optimum cutting conditions, and optimum sequencing of operations affect directly the workpiece cost. The main aim of this paper is to select from recent cutting data of world's leading manufacturer tools Sandvik Coromant, adequate cutters, optimal inserts, and optimal cutting conditions for prismatic manufacturing features, extracted by a feature recognizer module that we developed earlier, and which takes STEP file as input to the system. The final objective of this work consists in generating an optimal process plan defined according to ISO 14649.

Keywords— CAD/CAM; CAPP; Manufacturing Feature Recognition; Automatic cutting-tool selection for milling.

I. INTRODUCTION

Modern manufacturing enterprises are built from facilities spread around the globe, which contain equipment from many different manufacturers. Immense volumes of product information are transferred between the various facilities and machines. Today's digital communications standards have solved the problem of reliably transferring information across global networks. For mechanical parts, the description of product data has been standardized by the STandard for the Exchange of Product model data STEP defined as ISO 10303 [1]. This leads to the possibility of using standard data throughout the entire process chain in the manufacturing enterprise. Impediments to realizing this principle are the data formats used at the machine level. Most computer numerical control (CNC) machines are programmed in the ISO 6983 "G and M code" language [2]. Programs are typically generated by computer-aided manufacturing (CAM) systems that use computer-aided design (CAD) information. However, ISO 6983 limits program portability for three reasons. First, the language

focuses on programming the tool centre path with respect to machine axes, rather than the machining process with respect to the part. Second, ISO 6983 defines the syntax of program statements, but in most cases leaves the semantics ambiguous. Third, vendors usually supplement the language with extensions that are not covered in the limited scope of ISO 6983. ISO 14649 is a new model of data transfer between CAD/CAM systems and CNC machines, which replaces ISO 6983. It remedies the shortcomings of ISO 6983 by specifying machining processes rather than machine tool motion, using the object-oriented concept of Workingsteps. Workingsteps correspond to high-level machining features and associated process parameters. CNCs are responsible for translating Workingsteps to axis motion and tool operation. A major benefit of ISO 14649 is its use of existing data models from ISO 10303. As ISO 14649 provides a comprehensive model of the manufacturing process, it can also be used as the basis for a bi- and multi-directional data exchange between CAD, CAPP, and CAM systems. In this work, we have adopted ISO 14649 for process planning activities. This standard is divided into a series of parts; ISO 14649-10 [3], ISO 14649-11[4], ISO 14649-111[5], and so on. These parts include information about manufacturing features (MFs), machining operations, machining strategies, cutting tools, and so on. Information in these parts is modeled in EXPRESS language [6] in term of entities. These entities can be converted to C++ Classes using STEP Class Library developed by NIST [7]. By this way, machining process data are structured in object-oriented data structures, and can be used for downstream activities of the present work.

II. PREVIOUS WORKS

In the early 1980s, research work was undertaken in the area of computer-aided manufacturing and process planning systems have been developed to select a tool or a set of tools for a specific operation or a set of operations.

Carpenter and Maropoulos [8] developed a flexible tool selection decision support system for milling operations, the system is called OPTIMUM (Optimized Planning of Tooling and Intelligent Machinability evaluation for Milling).It combine a knowledge based logic and statistical methods.

The authors implemented a module of machinability assessment that produces initial cutting conditions for a wide range of materials and tools. The system also proposes a new optimization criterion related to initial average chip thickness called harshness.

Roshan [9] has developed a graph based algorithm to find the optimal sequence for machining an entire setup that contains a set of features with precedence constraints.

The author presented four extensions to the basic algorithm: feature level optimization, composite graph method, constrained graph method and sub-graph method.

In the first method, tool sequence graphs are built individually for each feature.

In the second method, a composite tool sequence graph is generated for all features in a sibling level.

The constrained graph and subgraph approaches have been developed for situation where different features in the setup have distinct critical tools.

Mookhrejee and Bhattacharyya [10] developed an expert system Extool which automatically selects the turning tool/insert or milling insert, the material and geometry.

The machining time calculation function of the program requires the feed, cutting speed, depth of cut, length of job and the initial and required finished diameter of the job as input. The outputs are cutting time and number of passes of the tool.

Edalew, Abdalla and Nash [11] developed a system for the selection of cutting tools. It's a dynamic programming based system that utilizes mathematical modules and heuristic data to determine and calculate cutting parameters and total component cost.

The system contains the following modules: the knowledge acquisition module, the knowledge base module, the inference engine, the user interface and the database.

Arezoo, Ridgway and Al-Ahmari [12] developed a knowledge-based system for selection of cutting tools and conditions of turning operations. It contains an inference engine, a user interface and explanation facility, a knowledge base and an optimization module for machining conditions.

III. PROPOSED METHODOLOGY

In a previous work, we have focused on the development of an automatic feature recognition system for prismatic parts, which adopted the STEP AP203 Ed2 [13], as input to the system. The system recognizes features using a graph-based approach, based on a Chain of Faces and Base of Faces CF-BF graph [14], and is capable of generating multiple interpretations of interacting features. A library which consists of milling-pre-defined manufacturing features is elaborated to enable the automatic extraction of manufacturing features. However, GD&T was not considered in that work since STEP AP203 Ed2 includes GD&T only as drawing [15]. To overcome this issue, we have used a STEP AP238 physical file generated by STEP-NC Machine [16], as input to the system. The advantage of STEP AP238, is that it contains both the geometric and topological data

defined according to STEP AP203 Ed2, necessary for feature recognition purposes, as well as, G&DT, and surface roughness. Thus, these technical data are extracted from STEP AP238, and used for downstream activities such as automatic tool selection.

After a rigorous study of Sandvik Coromant catalog and handling of the proposed manual method for cutting-tools choice [17], the first obstacle to overcome was the collection of all data from the Constructor and to follow all his instructions without information's loss, and the second was mainly how to integrate them into the new Manufacturing Feature concept which is the core of our CAPP automated system [18]. In fact, Sandvik tools selection approach was focused essentially on the operations to be performed, and not on features to be manufactured. For the purpose, a relational database was seized with MySQL Workbench, from the milling cutting tool catalogue of Sandvik database [17], which is composed of several tables including characteristics of inserts, cutters, cutting conditions and materials grades. These tables are connected by relational links in such a way that relations between data of the manufacturer are respected. This database will be used for the automatic extraction of all data necessary, required to form tool packages for candidate machining features.

Recall that the overall goal of our work is to provide the user with an automatic-integrated tools choice system that can form the adequate tools package required for machining all the manufacturing features of a part. However, giving the large number of machining process parameters that drive the choice of cutting tools, it becomes almost impossible to force a unique tool without fixing optimization criteria. Also, the manufacturer proposes large varieties of cutting tools that can make the same machining operation. Moreover, the choice problem become more difficult when several interacting features arise, resulting in more than one sequencing in which tool itself was among the studied-parameters to select the best sequencing. Then, firstly, this paper plans to identify and study different parameters that influence the choice of the cutting tools by regarding the concept of the MF used, and secondly it plans to provide the use of an operational research tool to help the right decision concerning this choice, respecting optimization criteria.

IV. SYSTEM ARCHITECTURE

The system under development aims to provide the user with an automatic and optimized solution for cutting tool selection taking into account a number of parameters that are related to MF and cutting tools. The system consists of four modules:

- A cutting tool database that allows management of milling cutters, tool-holders, inserts and cutting conditions.
- A Sub-system for recognition of MF and extraction their technical data such as GD&T.
- A method for affecting semi-optimal tools to MF.
- A method for optimizing cutting conditions.

The system should also have the flexibility to enable the user to feed his own shop floor experience into the system and adapt it to specific requirements.

The system architecture and representation of its modules is depicted in figure 1. The system was represented with SADT diagram. Inputs of the system are part specifications and technical data. The output is a set of optimal cutters with optimal cutting conditions.

After designing the 3D model of the part (A1), the STEP AP203 file is generated, it describes the part to be produced in term of geometric and topologic data, then technical data are used to define constraints and specifications related to the part and the process (A2) in order to generate the STEP AP238 file that describe features with tolerances to be considered.

The functionalities of the four principal modules are as following:

- The First module (A3) consists on one hand, in recognizing manufacturing features by the use of CFBF graph [14]. Data are extracted from step AP238 file, reordered and stored in a database. Then the recognition system use specified rules through the stored data to recognize and extract features. On the other hand, it consists in extracting technical data from the same STEP AP238 file, and affecting these data to features.
- The second module (A4) deals with the design of cutting tool database in order to allow management and choice of tools during the whole process of tool selection and optimization of cutting conditions.
- The third module (A5) consists in affecting semi-optimal milling cutters (from the database) to MF.
- The final module (A6) provides the optimization of machining condition to minimize production cost and maximize production efficiency.

V. STUDY OF INFLUENCING PARAMETERS

The first task is to build the data base from Sandvik Coromant catalogue and to examine the process of milling and influencing parameters that lead to the choice of cutters and optimal cutting conditions.

In fact, milling is principally metal cutting performed with a rotating, multi-edge cutting tool which performs programmed feed movements against a workpiece in almost any direction. It is this cutting action that makes milling such an efficient machining method. Each of the cutting edges remove a certain amount of metal, with a limited in-cut engagement, making chip formation and evacuation a secondary concern [19].

Table 1 illustrates types of milling operations as seen from the effect on the component or from a tool path point of view.

To set-up the milling operation, cutting parameters should be taken into account and a number of definitions should be established. These define the dynamics of the rotating milling tool, with a specified diameter (D_c) "Fig 2-a", having largest diameters (D_{c2} or D_3), moving against the workpiece, with an effective cutting diameter (D_e), the basis for the cutting speed.

As mentioned above, our system propose an automatic tool selection method based on manufacturing features which take Sandvik Coromant database as a knowledge base.

According to the manufacturer sandvik coromant, selection of milling cutters is done manually and goes through six stages:







- 1) Define the operation: The first is to identify the type of operation (Facemilling, Shoulder milling, Profile milling, Slot milling) then select the most suitable tool considering productivity, reliability and quality.
- 2) Define the material: Secondly material of the workpiece is defined according to ISO;
Steel (P) – Stainless steel (M) – Cast iron (K) – Aluminum (N) – Heat resistant and titanium alloy (S) – Hardened material (H).
- 3) Select cutter concept: Assess which concept is the most productive for the application (CoroMill 245, CoroMill 210, CoroMill 390, CoroMill 290).
- 4) Select the milling cutter: By choosing the cutter pitch and type of mounting. Following rules are used to select the pitch:
 - Use a close pitch cutter as first choice.
 - Use a coarse pitch cutter for long overhang and unstable conditions.
 - Use an extra close pitch cutter for short chipping materials and super alloys.
- 5) Select the insert: by choosing the insert geometry for your operation and selecting insert grade for optimum productivity. Use Geometry L for light cuts when low forces or power are required, Geometry M for mixed production and Geometry H for rough operations, forging, cast skin and vibrations.
- 6) Define the start values: Cutting speeds and feeds for different materials are given on the insert dispensers and in the tables. The values should be optimized according to machine and conditions.

In fact, the manual method presents some drawbacks; on one hand, it depends on the expertise of the user who must manually select parameters and criteria through the machining handbook for a given application, which is time consuming. On the other hand, the choice of tools provided by this method depends essentially on the operations to be performed and not on features to manufacture.

Thus, we focused in our study on defining parameters related to manufacturing features in order to automate the process of tool selection. These features are firstly associated to their appropriate operations as shown in Table 2.

In general, Influencing parameters are those related to the part features: geometry and dimensions of the feature, its position and orientation, surface roughness, part material and extrinsic tolerances of the manufacturing features.

Table 1: Representation of major milling operations

Milling operation	Explanation
1) Face milling 	It's the most common milling operation. Cutters with a 45° entering angle are most frequently used.
2) Square-shoulder milling. 	This operation generates two faces simultaneously, which requires peripheral milling in combination with face milling. Shoulder milling can be performed by traditional square shoulder cutters, and also by using end milling cutters, long edge cutters and side and face milling cutters. Due to these numerous options, it is essential to consider the operational requirements carefully to make an optimal choice.
3) Profile Milling. 	Profile milling covers multi-axis milling of convex and concave shapes in two and three dimensions. The larger the component and the more complicated the configuration to machine, the more important the process planning becomes.
4) Slot milling 	Machining a groove or slot, often called full slotting, involves three machined faces: <ul style="list-style-type: none"> • Slots closed at both ends are pockets, requiring end mills that can work in the axial direction. • Full slotting with an end mill is a demanding operation. The axial cutting depth should be generally reduced to around 70% of the edge length. Machine rigidity and chip evacuation should also be considered in determining the best method for the operation. • End mills are sensitive to the effects of cutting forces. Deflection and vibration may be limiting factors, especially at high machining rates and with long overhangs.
5) Turn milling. 	Turn milling is defined as the milling of a curved surface while rotation the workpiece around its center point. The method allows for high metal removal with superb chip control.
6) Thread milling. 	Thread milling produces threads with the circular ramping movement of a rotating tools. The lateral movement of the tool in one revolution creates the thread pitch.

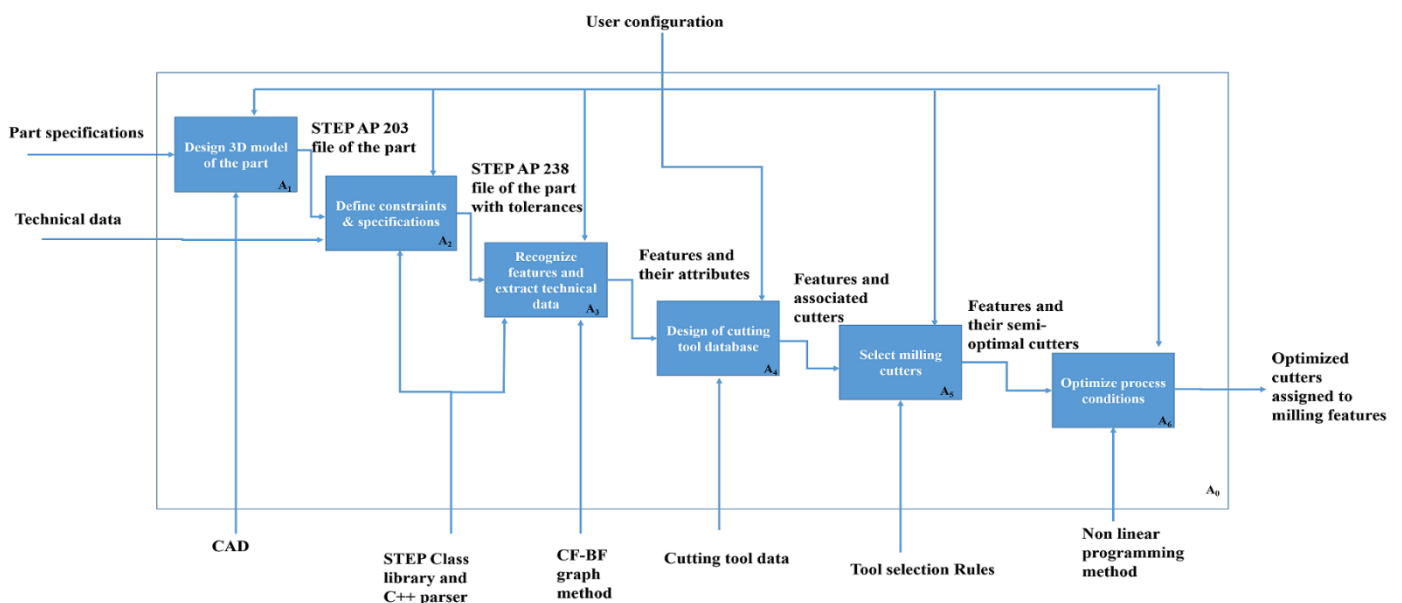

Figure 1: SADT Diagram of the proposed system

Table 2: Type of features and their associated operations

MF	Surfacic feature	Appropriate operations
Horizontal face		
Vertical face		
Through step		
Blind step		
Through slot		
Blind slot		
Blind hole		
Through hole		
Blind pocket		
Through pocket		
Boss		
Slope face		
Freeform surface		

Feature type: The type of feature is considered as a decisive parameter when selecting cutters. Suitable tools are selected by feature category. Indeed, machining features can be divided into two categories, simple features and complex features. Simple features are realized by using one machining operation, for example, a face and a shoulder can be performed by face milling and shoulder milling respectively. Complex features require at least two machining operations such as curved surfaces and freeform surfaces (features), which require roughing and profiling operations.

Surface roughness: Surface roughness is considered as a critical parameter to select tools and number of applications. For example, a feature having surface roughness of 0.8 ($R_a = 0.8$) have to be machined in three applications, roughing, semi-finishing, and finishing application. In finishing operations, surface roughness is also influenced by some parameters depending on the surface generated such as feed per revelation and wiper land.

Material of the workpiece: Material of work piece is a determinant factor for selecting the type of the cutter, the insert grade and the machining parameters. The manufacturer gives the designations of materials and their characteristics such as Specific cutting force and Brinell hardness. Depending on the insert grade and the type of material, the manufacturer gives the maximum chip thickness and the recommended cutting speed.

Dimensions of the feature: Dimensions of the feature represent an important parameter that lead the choice of milling tool. In fact, the depth of the feature is critical to determine the type of the cutter and the insert size, on the other hand the length of the feature represents an indicator of which diameter to choose.

Taking the fact that features parameters are known, another category of parameters should be determined according feature parameters, which are related to the tool and the process, the following section represent a study of the most of them.

VI. STUDY OF INFLUENCED PARAMETERS

In general, influenced parameters are those in concern with the tool: such as tool life, tool cost and structure, geometry and material of the tool. And those related to the process: such as machining cost, machining time and the process efficiency.

Influenced parameters can be evaluated by a number of parameters. The following paragraphs define the most influenced parameters in milling process.

- **Cutting speed (vc):** “fig 2-b”, in m/min indicates the surface speed at which the cutting edge machines the workpiece. This is a tool oriented value and part of the cutting data which ensures that the operation is carried out efficiently and within the recommended scope of the tool material.
- **Spindle speed (n):** in rpm is the number of revolutions the milling tool on the spindle makes per minute. This is a machine oriented value which is calculated from the recommended cutting speed value for an operation.
- **Feed per minute (f):** also known as the table feed, machine feed or feed speed, “fig 2-b”, in mm/min is the feed of the

tool in relation to the workpiece in distance per time-unit related to feed per tooth and number of teeth in the cutter.

- **Maximum chip thickness (h_{max}):** in mm is the most important limitation indicator for a tool, for an actual operation. A cutting edge on a milling cutter has been designed and tested to have a recommended starting value and a minimum and maximum value.
- **Feed per tooth (f_z):** “fig 2-b)” in mm/tooth is a value in milling for calculating the table feed. As the milling cutter is a multi-edge tool, a value is needed to ensure that each edge machines under satisfactory conditions. It is the linear distance moved by the tool while one particular tooth is engaged in cut. The feed per tooth value is calculated from the recommended maximum chip thickness value.
- **Zn:** The number of available cutter teeth in the tool varies considerably and is used to determine the table feed while the effective number of teeth (z_c) is the number of effective teeth. The material, width of component, stability, power, surface finish influence how many teeth are suitable.
- **Feed per revolution (f_n):** in mm/rev is a value used specifically for feed calculations and often to determine the finishing capability of a cutter. It is an auxiliary value indicating how far the tool moves during the rotation.
- **Depth of cut (a_p):** “fig 2-b)”, in mm (axial) is what the tool removes in metal on the face from the workpiece. This is the distance the tool is set below the un-machined surface.
- **Cutting width (a_e):** “fig 2-b)”, in mm (radial) is the width of the component engaged in cut by the diameter of the cutter. It is distance across the surface being machined or, if the tool diameter is smaller, that covered by the tool.
- **The average chip thickness (h_m):** “fig 2-b)”, is a useful value in determining specific cutting force and subsequently power calculations. It is calculated in relation to the type of cutter engagement involved.
- **The removal rate (Q)** is volume of metal removed per time in cubic-mm and can be established using values for cutting depth, width and feed.
- **The machining time (T_c)** or period of cutter engagement is the machining length (l_m) divided by the table feed.
- **The specific cutting force (k_{ct})** is a power calculating factor taking into account the material in question and for a chip thickness value. It relates to machinability as well as feed rate and cutting speed.
- **Power (P_c) and efficiency (η)** are machine tool oriented values where the net power can be calculated to ensure that the machine in question can cope with the cutter and operation.
- **Entering angle:** As regards cutting geometry in milling, the entering angle (κ_r) “fig 2-c)”, or the major cutting edge angle, of the cutter is the dominant factor affecting the cutting force direction and chip thickness. The choice of insert geometry has been simplified into three practical

areas of varying cutting action effects: Light (L), general purpose (M) and tough (H) geometries fig.2- d).

- **The pitch (u):** fig 2-e), it is the distance between teeth on the cutter. It is the distance between one point on one cutting edge to the same point on the next edge. Milling cutters are mainly classified into coarse (L), close (M) and extra close (H) pitches, as well as extra, extra close pitch. The different pitches affect operational stability, power consumption and suitable workpiece material. A differential pitch means an unequal spacing of teeth on the cutter and is a very effective means with which to counter vibration tendencies.

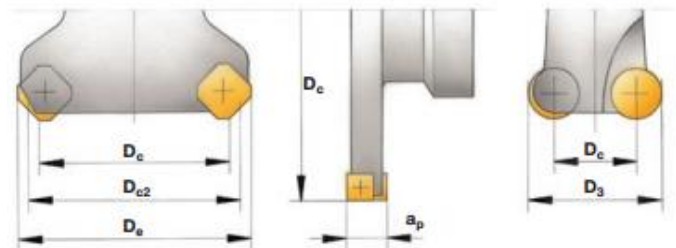

Figure 2-a) Type of diameter of milling cutter

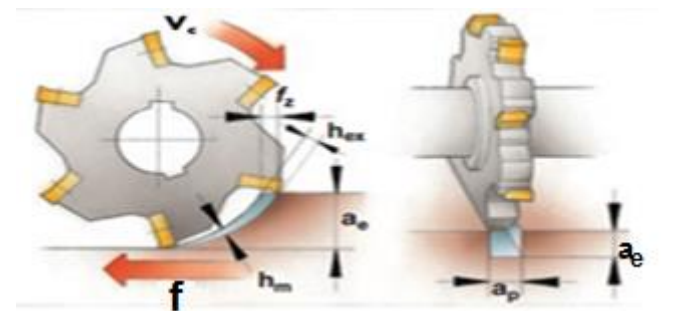

Figure 2-b) general influenced parameters on tool selection

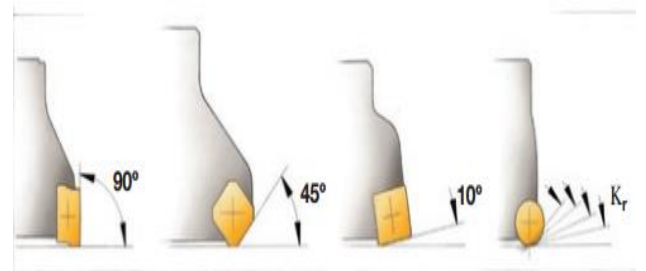

Figure 2-c) Type of entering angle of the cutter

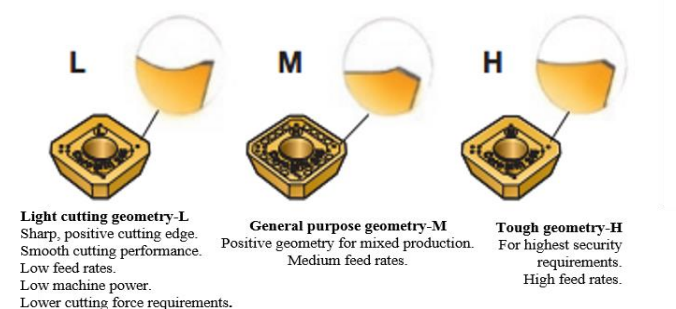

Figure 2-d) type of insert geometry

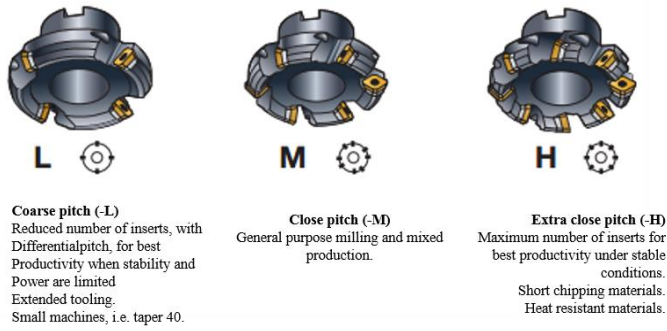

Figure 2-e) categories of pitch and their utility

Taking into account influencing and influenced parameters, the automatic tool selection method is based on influencing parameters (part feature data) and influenced parameters related to cutting tools and conditions. When a feature including its technical data is available, its attributes and parameters are transferred to a rules-based systems that analyses these data on one hand. On the other hand, this system searches what is the parameter or what are the parameters to be determined for cutters and inserts adding to that the determination of cutting conditions, according to each parameter of the feature. Figure 3 illustrates the modules of the proposed tool selection system.

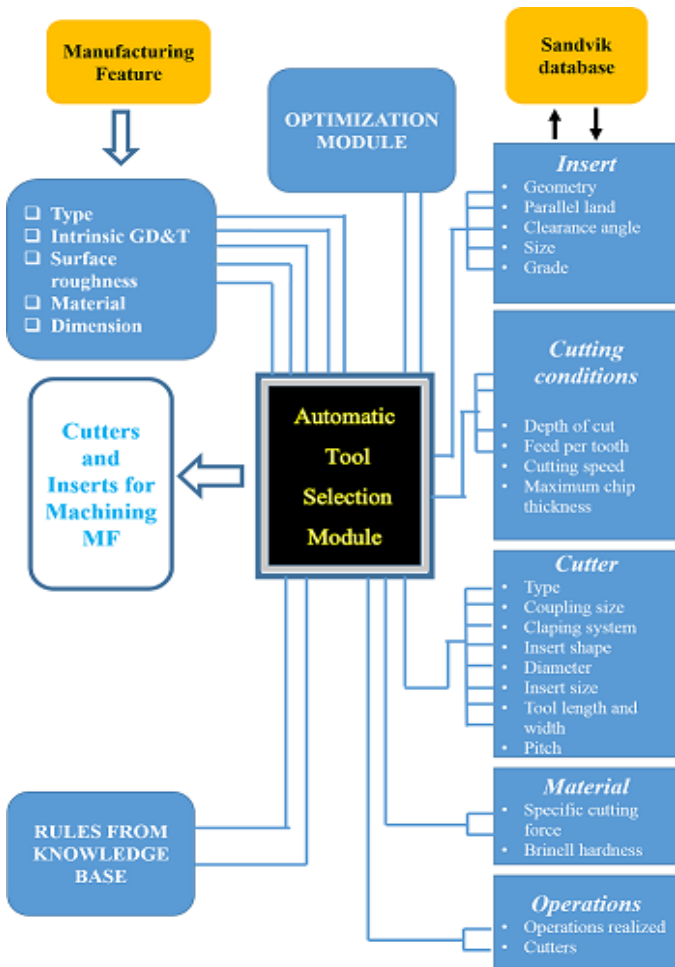

Figure 3. Automatic tool selection module

Taking the fact that cutters are selected for each feature, and taking the fact that each cutter has appropriate cutting conditions (proposed by Sandvik Coromant), these cutting parameters are used by an optimization module, which is responsible for optimizing machining process and cutting conditions particularly for an horizontal face feature. The following section represent the method proposed of machining process and parameters optimization.

VII. OPTIMIZATION OF MACHINING PROCESS

A machining process removes excessive material from a form of raw stock to generate a desired shape. The effectiveness of this process is generally evaluated by the volume of the material being removed in a given time, often denoted as the material removal rate. Machining process optimization is the selection of machining parameters for a given process to achieve the maximum material removal rates and minimum production cost within the process and machine limitations.

In fact, machining parameters, tool wear and surface quality are three metal cutting conditions that are strongly interrelated. While machining parameters contribute to tool wear, the quality of surface finish is affected by tool wear. At higher cutting speed, tool wear increases causing shorter tool life. On the other hand, due to tool wear, the width of tool nose increases leading to inferior quality of part surface. In order to achieve effective and efficient machining operation, better tool usage as well as improved product quality, it is essential to integrate the decisions of machining parameters, tool wear and surface quality altogether. The optimization of machining parameters such as cutting speed, feed rate, and depth of cut is a critical step in the planning of machining operations to achieve higher machining efficiency. We proposed a non-linear programming model to optimize machining time and machining cost for face milling process considering the horizontal face feature.

A. Definition of the optimization module

The first task was to determine the process of optimization with inputs and output parameters. As shown in figure 4, inputs parameters are related to the feature (width, length, surface roughness etc..), the milling cutter (diameter, tooth number, tool life, width of tool nose etc..) and machining parameters (depth of cut, minimum and maximum cutting speed, minimum and maximum feed...). Outputs parameters are machining cost, machining time, cutting force, and other optimal machining parameters (optimal cutting speed, optimal feed per tooth...).

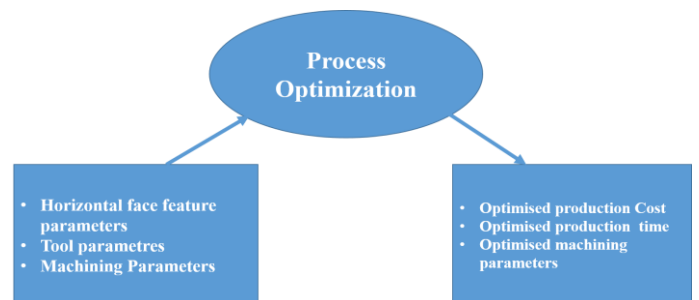

Figure 4. Process optimization for horizontal face feature

B. Machining time for face milling process

Before drawing up production cost and production time equations, we will first calculate machining time for face milling feature.

Machining time (t_m) is defined as the time required for machining a surface and is expressed in minutes. It depends essentially on two parameters: the feed rate (f) and the total length of the face feature travel (L_m) and is given by the following equation:

$$t_m = \frac{L_m}{f} \quad (1)$$

- Total Length Of The face feature Travel

The total length of the face feature travel is the distance between point A and A' (Figure 5) that indicate the tool travel of the face feature.

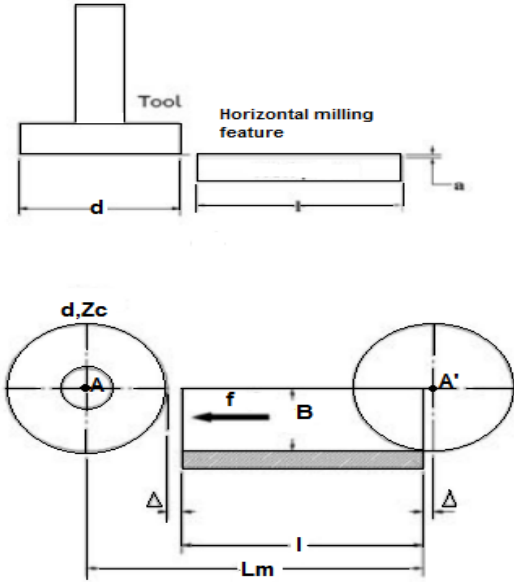

Figure 5. Schematic diagram of face milling horizontal feature

L_m is given by:

$$L_m = \frac{d}{2} + l + 2\Delta \quad (2)$$

Where d is the diameter of the tool, l is the length of the face feature and Δ is an arbitrary distance to avoid possible accidents and damages.

- Feed rate equation

As we discussed earlier the feed rate is related to the feed per tooth and number of teeth in the cutter and is given by:

$$f = f_z Z_c N = f_z Z_c \frac{1000V}{\pi d} \quad (3)$$

Where Z_c is the number of teeth on the cutter, f_z is the feed per tooth (mm/tooth), N is the spindle speed and V is cutting speed, therefore equation (1) can be written as:

$$t_m = \frac{\pi d L_m}{1000 V f_z Z_c} \quad (4)$$

C. Production cost and production time estimation

- Unit production cost UC

Unit production cost is related to the cost of machining and those of tools. If material cost is excluded, unit production cost UC (\$/piece) can be expressed by:

$$UC = CM + CI + CR + CT \quad (5)$$

Where CM , CI , CR , and CT are actual machining cost, machine idle cost, tool replacement cost, and tool cost respectively.

The actual machining cost (CM) is given by:

$$CM = K_0 t_m = k_0 \frac{\pi d L_m}{1000 V f_z Z_c} \quad (6)$$

Where k_0 is the direct labor cost plus overhead (\$/min).

The machine idle cost CI is given by:

$$CI = k_0 t_l \quad (7)$$

Where t_l is the Machine Idling time and it can be divided into preparation time t_p due to loading and unloading operations and idle tool motion time t_i due to tool idle motion,

$$t_l = t_p + t_i = t_p + (h_1 L_m + h_2)$$

then,

$$CI = k_0 [t_p + (h_1 L_m + h_2)] \quad (8)$$

Where h_1 is the tool return time (min/mm) and h_2 is the tool advance/ return time (min).

Tool replacement cost CR and tool cost CT can be respectively written as

$$CR = k_0 t_e Z_c \frac{t_m}{T} \quad (9)$$

And

$$CT = k_t Z_c \frac{t_m}{T} \quad (10)$$

Where t_e is the tool change time per edge (min), k_t is the cost of cutting edge (\$/edge) and T is the tool life (min).

- Unit production time UT

The unit time (UT) is the sum of set-up (t_p), machining (t_m) and tool changing times (t_e). In single tool milling operations only a worn tool needs to be changed, tool changing time for each part is calculated based on the machining time of the part to the tool life. Therefore, unit time was shown as the following:

$$UT = t_p + t_m + t_e \left(\frac{t_m}{T} \right) = t_p + \left(1 + \frac{t_e}{T} \right) \frac{\pi d L_m}{1000 V f_z Z_c} \quad (11)$$

D. Objective functions and constraints

- Objective functions

The objective functions to minimize the production cost and the production time are the following:

$$UC = \left(k_0 + \frac{k_t Z_c}{T} + \frac{k_0 Z_c t_e}{T}\right) \frac{\pi d L_m}{1000 V f_z Z_c} + k_0 (h_1 L_m + h_2) + k_0 t_p \quad (12)$$

$$UT = t_p + \left(1 + \frac{t_e}{T}\right) \frac{\pi d L_m}{1000 V f_z Z_c} \quad (13)$$

- Constraints

To minimize the objective function, the following constraints that impose restrictions on the machining conditions should be considered. Machine tool, cutting tool and face feature specifications are the sources of this restrictions. The factors that are taken into consideration in this study are as follows.

- Cutting speed V:

$$V_{min} \leq V \leq V_{max} \quad (14)$$

- Feed rate f_z :

$$f_{zmin} \leq f_z \leq f_{zmax} \quad (15)$$

- Depth of cut (a) :

$$a_{min} \leq a \leq a_{max} \quad (16)$$

- Tool life

The cutting tool life T can be expressed by the following expended Taylor equations:

$$T = \frac{K_e}{V^\alpha f_z^\beta a^\gamma} \quad (17)$$

Where K_e is constant and α , β , γ are exponents in tool life equation.

In practice, it is desired to change the cutting tool after machining n pieces. So the constraints on the tool life can be expressed as:

$$T \geq n t_m \quad (18)$$

- Surface finish R_a

Surface finish is one of the most important factors in a finish cutting operation because it directly affects the machining quality. It is given by [20]:

$$R_a = \frac{0.0321 f_z^2}{r_e} \quad (19)$$

Where r_e is the nose-radius of the cutting-edge. Surface finish constraint on face milling can be expressed by:

$$f_z \leq \sqrt{r_e R_a / 0.0321} \quad (20)$$

Combining Equation (15) and (20), the following result is:

$$f_{zmax} \leq f_z \leq \min \left(f_{zmax}, \left(\frac{r_e R_a}{0.0321} \right)^{1/2} \right) \quad (21)$$

- Cutting force:

The cutting force is given by [21]:

$$F_Z = C_F a^{x_F} f_z^{y_F} \left[\frac{B^s F Z_c^{p_F}}{d^{q_F} N^{w_F}} \right] K_F \quad (22)$$

Where B is the width of the face feature, C_F and K_F are constants, and p_F , q_F , x_F , w_F and s_F are exponent constants.

The cutting force constraint is expressed by:

$$F_Z \leq F_{Zmax} \quad (23)$$

Optimization model developed in this work is non-linear, multivariable and multi-constrained model of a complex nature. Objective functions are minimum production cost and minimum production time (equations 12 & 13) and constraints are presented by equations 14, 16, 18, 21 & 23. Recalling that the proposed model is for horizontal face milling feature. To employ an appropriate optimization method for solving this model, care must be taken and a number of solving methods should be studied. This will be the object of a future work in which we aim to solve the problem and to study the possibility of generalizing it on other milling features.

CONCLUSION AND FUTUR WORKS

In the present work, we proposed an automated cutting tool selection system for milling based on manufacturing feature concept. This system uses STEP file as input and is capable of extracting features via recognition module. The system also offers the possibility to extract tolerances of the part to be produced, to interpret them, and to assign each manufacturing feature an adequate milling tool. This can be done by examination of a number of influencing parameters related to MF that influence the choice of tools. Finally, we have studied the process of milling and its influenced parameters, and proposed a tool selection module and a mathematical model to optimize machining conditions, leading to maximize process efficiency by minimizing production cost and production time.

Our future work will be axed on real implementation of the system with development of a solid software based on C++ language that is capable of generating a process plan as a STEP-NC file where the whole milling process is specified. This software should communicate with the Sandvik Coromant database and other modules of the system such as manufacturing feature recognition and machining conditions optimization.

REFERENCES

- [1] ISO 10303: STEP, Standard for the Exchange of Product Model Data.
- [2] ISO 6983: Automation systems and integration -- Numerical control of machines -- Program format and definitions of address words
- [3] ISO 14649-10: Industrial automation systems and integration — Physical device control — Data model for computerized numerical controllers — Part 10: General process data.
- [4] ISO 14649-11: Industrial automation systems and integration — Physical device control — Data model for computerized numerical controllers — Part 10: Process data for milling

- [5] ISO 14649-111: Industrial automation systems and integration — Physical device control — Data model for computerized numerical controllers — Part 10: Tools for milling machines.
- [6] ISO 10303-11: Industrial automation systems and integration — Product data representation and exchange — Part 11: Description methods: The EXPRESS language reference manual.
- [7] <http://www.nist.gov/el/msid/scl.cfm>
- [8] I.D.Carpenter,P.G.Maropoulos, A flexible tool selection decision support system for milling operations, Journal of Materials Processing technology 107 (2000) 143-152.
- [9] Roshan M.D'Souza, On setup level tool sequence selection for 2.5-D pocket machining, Robotics and Computer Integrated Manufacturing 22 (2006) 256-266.
- [10] R.Mookherejee, B.Bhattacharyya, Development of an expert system for turning and rotating tool selection in a dynamic environment, Journal of Materials Processing Technology 113 (2001) 306- 311.
- [11] K.O. Edalew, H.S. Abdalla, R.J.Nash, A computer- based intelligent system form automatic tool selection, Materials and design 22 (2001) 337-351.
- [12] B. Arezoo, K.Ridgway, A.M.A. Al-Ahmari, Selection of cutting tools and conditions of machining operations using an expert system, Computers in industry 42 (2000) 43-58.
- [13] ISO 10303-203: Industrial automation systems and integration -- Product data representation and exchange -- Part 203: Application protocol: Configuration controlled 3D design of mechanical parts and assemblies.
- [14] Abdelilah El Mesbahi, Oussama Jaider , Ahmed Rechia, “Automatic Recognition of IsolatedAnd InteractingManufacturing Features InMilling Process”, Int. Journal of Engineering Research and Applications (IJERA), ISSN : 2248 - 9622, Vol. 4, Issue 10(Part - 2), October 2014, pp.57-72.
- [15] Jaider Oussama, Elmesbahi Abdelilah, Rechia Ahmed, “Manufacturing Computer Aided Process Planning For Rotational Parts. Part 1: Automatic Feature Recognition From STEP AP203 Ed2”, Int. Journal of Engineering Research and Applications (IJERA) ISSN : 2248-9622, Vol. 4, Issue 5(Version 6), May 2014, pp.14-25.
- [16] <http://www.steptools.com/products/stepncmachine/>
- [17] Tool Catalog, rotating tools. Milling tools, Sandvik Coromant, 2012.
- [18] Abdelilah Elmesbahi, Ahmed Rechia, and Oussama Jaider, “optimized-automated choice of cutting tool machining manufacturing features in milling process”, proceeding of the 11th World Congress on Computational Mechanics (WCCM XI), Barcelone, 2014.
- [19] Metalcutting technical guide , Milling (D), Sandvik Coromant, 2012.
- [20] Boothroyd G (1985) Fundamentals of Metal Machining and Machine Tools. McGraw-Hill, New Delhi.
- [21] Nefedov N, Osipov K (1987) Typical Examples and Problems in Metal Cutting and Tool Design. Mir Publishers, Moscow.