



**HAL**  
open science

# Introduction to High Performance Scientific Computing

Victor Eijkhout

► **To cite this version:**

| Victor Eijkhout. Introduction to High Performance Scientific Computing. 2015. hal-01257189

**HAL Id: hal-01257189**

**<https://hal.science/hal-01257189v1>**

Submitted on 19 Jan 2016

**HAL** is a multi-disciplinary open access archive for the deposit and dissemination of scientific research documents, whether they are published or not. The documents may come from teaching and research institutions in France or abroad, or from public or private research centers.

L'archive ouverte pluridisciplinaire **HAL**, est destinée au dépôt et à la diffusion de documents scientifiques de niveau recherche, publiés ou non, émanant des établissements d'enseignement et de recherche français ou étrangers, des laboratoires publics ou privés.



Distributed under a Creative Commons Attribution 4.0 International License

# Introduction to High Performance Scientific Computing

**Evolving Copy - open for comments**

Victor Eijkhout

with

Edmond Chow, Robert van de Geijn

2nd edition, revision 2016



Introduction to High-Performance Scientific Computing © Victor Eijkhout, distributed under a Creative Commons Attribution 3.0 Unported (CC BY 3.0) license and made possible by funding from The Saylor Foundation <http://www.saylor.org>.

## Preface

The field of high performance scientific computing lies at the crossroads of a number of disciplines and skill sets, and correspondingly, for someone to be successful at using high performance computing in science requires at least elementary knowledge of and skills in all these areas. Computations stem from an application context, so some acquaintance with physics and engineering sciences is desirable. Then, problems in these application areas are typically translated into linear algebraic, and sometimes combinatorial, problems, so a computational scientist needs knowledge of several aspects of numerical analysis, linear algebra, and discrete mathematics. An efficient implementation of the practical formulations of the application problems requires some understanding of computer architecture, both on the CPU level and on the level of parallel computing. Finally, in addition to mastering all these sciences, a computational scientist needs some specific skills of software management.

While good texts exist on numerical modeling, numerical linear algebra, computer architecture, parallel computing, performance optimization, no book brings together these strands in a unified manner. The need for a book such as the present became apparent to the author working at a computing center: users are domain experts who not necessarily have mastery of all the background that would make them efficient computational scientists. This book, then, teaches those topics that seem indispensable for scientists engaging in large-scale computations.

The contents of this book are a combination of theoretical material and self-guided tutorials on various practical skills. The theory chapters have exercises that can be assigned in a classroom, however, their placement in the text is such that a reader not inclined to do exercises can simply take them as statement of fact.

The tutorials should be done while sitting at a computer. Given the practice of scientific computing, they have a clear Unix bias.

**Public draft** This book is open for comments. What is missing or incomplete or unclear? Is material presented in the wrong sequence? Kindly mail me with any comments you may have.

You may have found this book in any of a number of places; the authoritative download location is <http://www.tacc.utexas.edu/~eijkhout/istc/istc.html>. That page also links to [lulu.com](http://lulu.com) where you can get a nicely printed copy.

Victor Eijkhout [eijkhout@tacc.utexas.edu](mailto:eijkhout@tacc.utexas.edu)  
Research Scientist  
Texas Advanced Computing Center  
The University of Texas at Austin

**Acknowledgement** Helpful discussions with Kazushige Goto and John McCalpin are gratefully acknowledged. Thanks to Dan Stanzione for his notes on cloud computing, Ernie Chan for his notes on scheduling of block algorithms, and John McCalpin for his analysis of the top500. Thanks to Elie de Brauwier, Susan Lindsey, and Lorenzo Pesce for proofreading and many comments. Edmond Chow wrote the chapter on Molecular Dynamics. Robert van de Geijn contributed several sections on dense linear algebra.

## Introduction

Scientific computing is the cross-disciplinary field at the intersection of modeling scientific processes, and the use of computers to produce quantitative results from these models. It is what takes a domain science and turns it into a computational activity. As a definition, we may posit

The efficient computation of constructive methods in applied mathematics.

This clearly indicates the three branches of science that scientific computing touches on:

- Applied mathematics: the mathematical modeling of real-world phenomena. Such modeling often leads to implicit descriptions, for instance in the form of partial differential equations. In order to obtain actual tangible results we need a constructive approach.
- Numerical analysis provides algorithmic thinking about scientific models. It offers a constructive approach to solving the implicit models, with an analysis of cost and stability.
- Computing takes numerical algorithms and analyzes the efficacy of implementing them on actually existing, rather than hypothetical, computing engines.

One might say that ‘computing’ became a scientific field in its own right, when the mathematics of real-world phenomena was asked to be constructive, that is, to go from proving the existence of solutions to actually obtaining them. At this point, algorithms become an object of study themselves, rather than a mere tool.

The study of algorithms became especially important when computers were invented. Since mathematical operations now were endowed with a definable time cost, complexity of algorithms became a field of study; since computing was no longer performed in ‘real’ numbers but in representations in finite bitstrings, the accuracy of algorithms needed to be studied. Some of these considerations in fact predate the existence of computers, having been inspired by computing with mechanical calculators.

A prime concern in scientific computing is efficiency. While to some scientists the abstract fact of the existence of a solution is enough, in computing we actually want that solution, and preferably yesterday. For this reason, in this book we will be quite specific about the efficiency of both algorithms and hardware. It is important not to limit the concept of efficiency to that of efficient use of hardware. While this is important, the difference between two algorithmic approaches can make optimization for specific hardware a secondary concern.

This book aims to cover the basics of this gamut of knowledge that a successful computational scientist needs to master. It is set up as a textbook for graduate students or advanced undergraduate students; others can use it as a reference text, reading the exercises for their information content.

## Contents

I	<b>Theory</b>	11
1	<b>Single-processor Computing</b>	12
1.1	<i>The Von Neumann architecture</i>	12
1.2	<i>Modern processors</i>	14
1.3	<i>Memory Hierarchies</i>	21
1.4	<i>Multicore architectures</i>	35
1.5	<i>Locality and data reuse</i>	39
1.6	<i>Programming strategies for high performance</i>	46
1.7	<i>Power consumption</i>	61
1.8	<i>Review questions</i>	63
2	<b>Parallel Computing</b>	64
2.1	<i>Introduction</i>	64
2.2	<i>Functional parallelism versus data parallelism</i>	67
2.3	<i>Quantifying parallelism</i>	68
2.4	<i>Parallel Computers Architectures</i>	77
2.5	<i>Different types of memory access</i>	81
2.6	<i>Granularity of parallelism</i>	83
2.7	<i>Parallel programming</i>	87
2.8	<i>Topologies</i>	119
2.9	<i>Multi-threaded architectures</i>	132
2.10	<i>Co-processors</i>	133
2.11	<i>Remaining topics</i>	138
3	<b>Computer Arithmetic</b>	152
3.1	<i>Integers</i>	152
3.2	<i>Real numbers</i>	154
3.3	<i>Round-off error analysis</i>	161
3.4	<i>Compilers and round-off</i>	168
3.5	<i>More about floating point arithmetic</i>	169
3.6	<i>Conclusions</i>	171
4	<b>Numerical treatment of differential equations</b>	172
4.1	<i>Initial value problems</i>	172
4.2	<i>Boundary value problems</i>	179
4.3	<i>Initial boundary value problem</i>	186

5	<b>Numerical linear algebra</b>	191
5.1	<i>Elimination of unknowns</i>	191
5.2	<i>Linear algebra in computer arithmetic</i>	194
5.3	<i>LU factorization</i>	196
5.4	<i>Sparse matrices</i>	204
5.5	<i>Iterative methods</i>	216
5.6	<i>Further Reading</i>	234
6	<b>High performance linear algebra</b>	235
6.1	<i>Collective operations</i>	235
6.2	<i>Parallel dense matrix-vector product</i>	238
6.3	<i>LU factorization in parallel</i>	248
6.4	<i>Matrix-matrix product</i>	250
6.5	<i>Sparse matrix-vector product</i>	252
6.6	<i>Computational aspects of iterative methods</i>	259
6.7	<i>Parallel preconditioners</i>	262
6.8	<i>Ordering strategies and parallelism</i>	265
6.9	<i>Operator splitting</i>	275
6.10	<i>Parallelism and implicit operations</i>	276
6.11	<i>Grid updates</i>	281
6.12	<i>Block algorithms on multicore architectures</i>	284
II	<b>Applications</b>	289
7	<b>Molecular dynamics</b>	290
7.1	<i>Force Computation</i>	291
7.2	<i>Parallel Decompositions</i>	295
7.3	<i>Parallel Fast Fourier Transform</i>	301
7.4	<i>Integration for Molecular Dynamics</i>	304
8	<b>Combinatorial algorithms</b>	308
8.1	<i>Sorting</i>	308
8.2	<i>Prime number finding</i>	313
9	<b>Graph analytics</b>	315
9.1	<i>Traditional graph algorithms</i>	315
9.2	<i>'Real world' graphs</i>	320
9.3	<i>Hypertext algorithms</i>	321
9.4	<i>Large-scale computational graph theory</i>	323
10	<b>N-body problems</b>	325
10.1	<i>The Barnes-Hut algorithm</i>	326
10.2	<i>The Fast Multipole Method</i>	327
10.3	<i>Full computation</i>	327
10.4	<i>Implementation</i>	328
11	<b>Monte Carlo Methods</b>	330
11.1	<i>Motivation</i>	330

---

11.2	<i>Parallel Random Number Generation</i>	332
11.3	<i>Examples</i>	333
III Appendices 335		
12	<b>Linear algebra</b>	337
12.1	<i>Norms</i>	337
12.2	<i>Gram-Schmidt orthogonalization</i>	338
12.3	<i>The power method</i>	340
12.4	<i>Nonnegative matrices; Perron vectors</i>	342
12.5	<i>The Gershgorin theorem</i>	342
12.6	<i>Householder reflectors</i>	343
13	<b>Complexity</b>	344
14	<b>Partial Differential Equations</b>	345
14.1	<i>Partial derivatives</i>	345
14.2	<i>Poisson or Laplace Equation</i>	345
14.3	<i>Heat Equation</i>	346
14.4	<i>Steady state</i>	346
15	<b>Taylor series</b>	347
16	<b>Graph theory</b>	350
16.1	<i>Definitions</i>	350
16.2	<i>Common types of graphs</i>	351
16.3	<i>Graph colouring and independent sets</i>	352
16.4	<i>Graphs and matrices</i>	352
16.5	<i>Spectral graph theory</i>	356
17	<b>Automata theory</b>	359
17.1	<i>Finite State Automata</i>	359
17.2	<i>General discussion</i>	359
18	<b>Parallel Prefix</b>	361
18.1	<i>Parallel prefix</i>	361
18.2	<i>Sparse matrix vector product as parallel prefix</i>	362
IV Tutorials 365		
19	<b>Unix intro</b>	367
19.1	<i>Files and such</i>	367
19.2	<i>Text searching and regular expressions</i>	373
19.3	<i>Command execution</i>	375
19.4	<i>Scripting</i>	379
19.5	<i>Expansion</i>	382
19.6	<i>Startup files</i>	384
19.7	<i>Shell interaction</i>	385
19.8	<i>The system and other users</i>	385
19.9	<i>The sed and awk tools</i>	386



19.10	<i>Review questions</i>	387
20	<b>Compilers and libraries</b>	388
20.1	<i>An introduction to binary files</i>	388
20.2	<i>Simple compilation</i>	388
20.3	<i>Libraries</i>	390
21	<b>Managing projects with Make</b>	392
21.1	<i>A simple example</i>	392
21.2	<i>Variables and template rules</i>	397
21.3	<i>Miscellanea</i>	400
21.4	<i>Shell scripting in a Makefile</i>	402
21.5	<i>Practical tips for using Make</i>	403
21.6	<i>A Makefile for L<sup>A</sup>T<sub>E</sub>X</i>	404
22	<b>Source code control</b>	406
22.1	<i>Workflow in source code control systems</i>	406
22.2	<i>Subversion or SVN</i>	408
22.3	<i>Mercurial or hg</i>	415
23	<b>Scientific Data Storage</b>	420
23.1	<i>Introduction to HDF5</i>	420
23.2	<i>Creating a file</i>	421
23.3	<i>Datasets</i>	422
23.4	<i>Writing the data</i>	426
23.5	<i>Reading</i>	428
24	<b>Scientific Libraries</b>	430
24.1	<i>The Portable Extendable Toolkit for Scientific Computing</i>	430
24.2	<i>Libraries for dense linear algebra: BLAS, Lapack, Scalapack</i>	440
25	<b>Plotting with GNUplot</b>	447
25.1	<i>Usage modes</i>	447
25.2	<i>Plotting</i>	448
25.3	<i>Workflow</i>	449
26	<b>Good coding practices</b>	450
26.1	<i>Defensive programming</i>	450
26.2	<i>Guarding against memory errors</i>	454
26.3	<i>Testing</i>	457
27	<b>Debugging</b>	458
27.1	<i>Invoking gdb</i>	458
27.2	<i>Finding errors</i>	460
27.3	<i>Memory debugging with Valgrind</i>	463
27.4	<i>Stepping through a program</i>	464
27.5	<i>Inspecting values</i>	466
27.6	<i>Breakpoints</i>	466
27.7	<i>Parallel debugging</i>	467
27.8	<i>Further reading</i>	469
28	<b>C/Fortran interoperability</b>	470

---

28.1	<i>Linker conventions</i>	470
28.2	<i>Arrays</i>	473
28.3	<i>Strings</i>	474
28.4	<i>Subprogram arguments</i>	476
28.5	<i>Input/output</i>	476
28.6	<i>Fortran/C interoperability in Fortran2003</i>	476
29	<b>LaTeX for scientific documentation</b>	477
29.1	<i>The idea behind L<sup>A</sup>T<sub>E</sub>X, some history of T<sub>E</sub>X</i>	477
29.2	<i>A gentle introduction to LaTeX</i>	478
29.3	<i>A worked out example</i>	484
29.4	<i>Where to take it from here</i>	490
V	<b>Projects, codes, index</b>	491
30	<b>Class projects</b>	492
30.1	<i>Cache simulation and analysis</i>	492
30.2	<i>Evaluation of Bulk Synchronous Programming</i>	494
30.3	<i>Heat equation</i>	495
30.4	<i>The memory wall</i>	498
31	<b>Codes</b>	499
31.1	<i>Preliminaries</i>	499
31.2	<i>Cache size</i>	500
31.3	<i>Cachelines</i>	502
31.4	<i>Cache associativity</i>	504
31.5	<i>TLB</i>	506
31.6	<i>Unrepresentable numbers</i>	509
32	<b>Bibliography, index, and list of acronyms</b>	510
32.1	<i>Bibliography</i>	510
32.2	<i>List of acronyms</i>	519
32.3	<i>Index</i>	520



**PART I**

**THEORY**

# Chapter 1

## Single-processor Computing

In order to write efficient scientific codes, it is important to understand computer architecture. The difference in speed between two codes that compute the same result can range from a few percent to orders of magnitude, depending only on factors relating to how well the algorithms are coded for the processor architecture. Clearly, it is not enough to have an algorithm and ‘put it on the computer’: some knowledge of computer architecture is advisable, sometimes crucial.

Some problems can be solved on a single CPU, others need a parallel computer that comprises more than one processor. We will go into detail on parallel computers in the next chapter, but even for parallel processing, it is necessary to understand the individual CPUs.

In this chapter, we will focus on what goes on inside a CPU and its memory system. We start with a brief general discussion of how instructions are handled, then we will look into the arithmetic processing in the processor core; last but not least, we will devote much attention to the movement of data between memory and the processor, and inside the processor. This latter point is, maybe unexpectedly, very important, since memory access is typically much slower than executing the processor’s instructions, making it the determining factor in a program’s performance; the days when ‘flop<sup>1</sup> counting’ was the key to predicting a code’s performance are long gone. This discrepancy is in fact a growing trend, so the issue of dealing with memory traffic has been becoming more important over time, rather than going away.

This chapter will give you a basic understanding of the issues involved in CPU design, how it affects performance, and how you can code for optimal performance. For much more detail, see an online book about PC architecture [95], and the standard work about computer architecture, Hennesey and Patterson [84].

### 1.1 The Von Neumann architecture

While computers, and most relevantly for this chapter, their processors, can differ in any number of details, they also have many aspects in common. On a very high level of abstraction, many architectures can be described as *von Neumann architectures*. This describes a design with an undivided memory that stores both program and data (‘stored program’), and a processing unit that executes the instructions, operating on the data in ‘fetch, execute, store’ cycle<sup>2</sup>.

---

1. Floating Point Operation.

2. This model with a prescribed sequence of instructions is also referred to as *control flow*. This is in contrast to *data flow*, which we will see in section 6.12.

This setup distinguishes modern processors for the very earliest, and some special purpose contemporary, designs where the program was hard-wired. It also allows programs to modify themselves or generate other programs, since instructions and data are in the same storage. This allows us to have editors and compilers: the computer treats program code as data to operate on<sup>3</sup>. In this book we will not explicitly discuss compilers, the programs that translate high level languages to machine instructions. However, on occasion we will discuss how a program at high level can be written to ensure efficiency at the low level.

In scientific computing, however, we typically do not pay much attention to program code, focusing almost exclusively on data and how it is moved about during program execution. For most practical purposes it is as if program and data are stored separately. The little that is essential about instruction handling can be described as follows.

The machine instructions that a processor executes, as opposed to the higher level languages users write in, typically specify the name of an operation, as well as of the locations of the operands and the result. These locations are not expressed as memory locations, but as *registers*: a small number of named memory locations that are part of the CPU<sup>4</sup>. As an example, here is a simple C routine

```
void store(double *a, double *b, double *c) {
    *c = *a + *b;
}
```

and its X86 assembler output, obtained by<sup>5</sup> `gcc -O2 -S -o - store.c`:

```
.text
.p2align 4,,15
.globl store
.type    store, @function
store:
movsd   (%rdi), %xmm0 # Load *a to %xmm0
addsd   (%rsi), %xmm0 # Load *b and add to %xmm0
movsd   %xmm0, (%rdx) # Store to *c
ret
```

The instructions here are:

- A load from memory to register;
- Another load, combined with an addition;
- Writing back the result to memory.

Each instruction is processed as follows:

- **Instruction fetch:** the next instruction according to the *program counter* is loaded into the processor. We will ignore the questions of how and from where this happens.

3. At one time, the stored program concept was include as an essential component the ability for a running program to modify its own source. However, it was quickly recognized that this leads to unmaintainable code, and is rarely done in practice [41].

4. Direct-to-memory architectures are rare, though they have existed. The Cyber 205 supercomputer in the 1980s could have 3 data streams, two from memory to the processor, and one back from the processor to memory, going on at the same time. Such an architecture is only feasible if memory can keep up with the processor speed, which is no longer the case these days.

5. This is 64-bit output; add the option `-m64` on 32-bit systems.

- Instruction decode: the processor inspects the instruction to determine the operation and the operands.
- Memory fetch: if necessary, data is brought from memory into a register.
- Execution: the operation is executed, reading data from registers and writing it back to a register.
- Write-back: for store operations, the register contents is written back to memory.

The case of array data is a little more complicated: the element loaded (or stored) is then determined as the base address of the array plus an offset.

In a way, then, the modern CPU looks to the programmer like a von Neumann machine. There are various ways in which this is not so. For one, while memory looks randomly addressable<sup>6</sup>, in practice there is a concept of *locality*: once a data item has been loaded, nearby items are more efficient to load, and reloading the initial item is also faster.

Another complication to this story of simple loading of data is that contemporary CPUs operate on several instructions simultaneously, which are said to be ‘in flight’, meaning that they are in various stages of completion. Of course, together with these simultaneous instructions, their inputs and outputs are also being moved between memory and processor in an overlapping manner. This is the basic idea of the *superscalar* CPU architecture, and is also referred to as *Instruction Level Parallelism (ILP)*. Thus, while each instruction can take several clock cycles to complete, a processor can complete one instruction per cycle in favourable circumstances; in some cases more than one instruction can be finished per cycle.

The main statistic that is quoted about CPUs is their Gigahertz rating, implying that the speed of the processor is the main determining factor of a computer’s performance. While speed obviously correlates with performance, the story is more complicated. Some algorithms are *cpu-bound*, and the speed of the processor is indeed the most important factor; other algorithms are *memory-bound*, and aspects such as bus speed and cache size, to be discussed later, become important.

In scientific computing, this second category is in fact quite prominent, so in this chapter we will devote plenty of attention to the process that moves data from memory to the processor, and we will devote relatively little attention to the actual processor.

## 1.2 Modern processors

Modern processors are quite complicated, and in this section we will give a short tour of what their constituent parts. Figure 1.1 is a picture of the *die* of an *Intel Sandy Bridge* processor. This chip is about an inch in size and contains close to a billion transistors.

### 1.2.1 The processing cores

In the Von Neuman model there is a single entity that executes instructions. This has not been the case in increasing measure since the early 2000s. The Sandy Bridge pictured in figure 1.1 has eight *cores*, each of which is an independent unit executing a stream of instructions. In this chapter we will mostly discuss aspects of a single core; section 1.4 will discuss the integration aspects of the multiple cores.

---

6. There is in fact a theoretical model for computation called the ‘Random Access Machine’; we will briefly see its parallel generalization in section 2.3.2.

### 1.2.1.1 Instruction handling

The Von Neuman model is also unrealistic in that it assumes that all instructions are executed strictly in sequence. Increasingly, over the last twenty years, processors have used *out-of-order* instruction handling, where instructions can be processed in a different order than the user program specifies. Of course the processor is only allowed to re-order instructions if that leaves the result of the execution intact!

In the block diagram (figure 1.2) you see various units that are concerned with instruction handling: This cleverness actually costs considerable energy, as well as sheer amount of transistors. For this reason, processors such as the *Intel Xeon Phi* use *in-order* instruction handling.

### 1.2.1.2 Floating point units

In scientific computing we are mostly interested in what a processor does with floating point data. Computing with integers or booleans is typically of less interest. For this reason, cores have considerable sophistication for dealing with numerical data.

For instance, while past processors had just a single Floating Point Unit (FPU), these days they will have multiple, capable of executing simultaneously.

For instance, often there are separate addition and multiplication units; if the compiler can find addition and multiplication operations that are independent, it can schedule them so as to be executed simultaneously, thereby doubling the performance of the processor. In some cases, a processor will have multiple addition or multiplication units.

Another way to increase performance is to have a *Fused Multiply-Add (FMA)* unit, which can execute the instruction  $x \leftarrow ax + b$  in the same amount of time as a separate addition or multiplication. Together with pipelining (see below), this means that a processor has an asymptotic speed of several floating point operations per clock cycle.

Incidentally, there are few algorithms in which division operations are a limiting factor. Correspondingly, the division operation is not nearly as much optimized in a modern CPU as the additions and multiplications

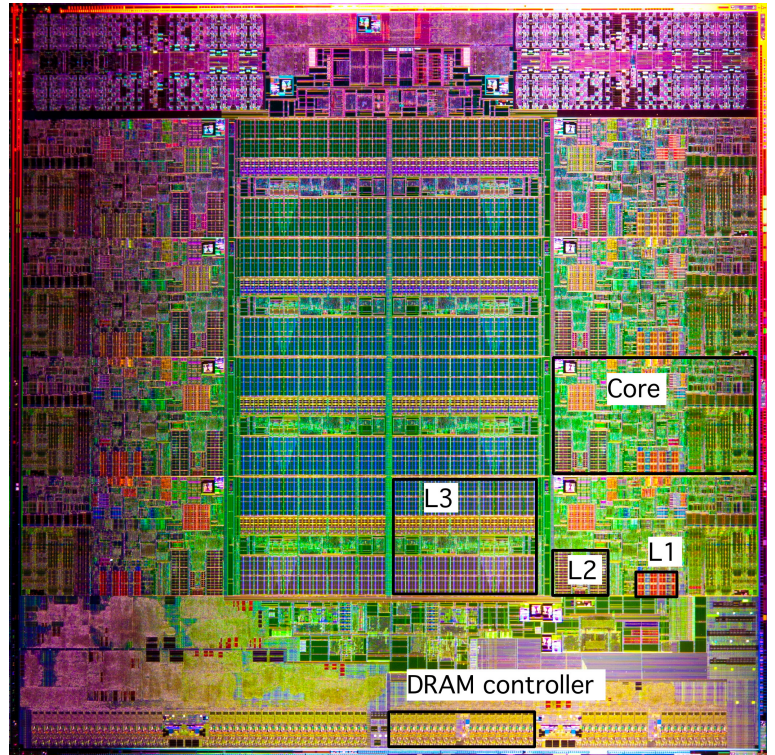

Figure 1.1: The Intel Sandybridge processor die



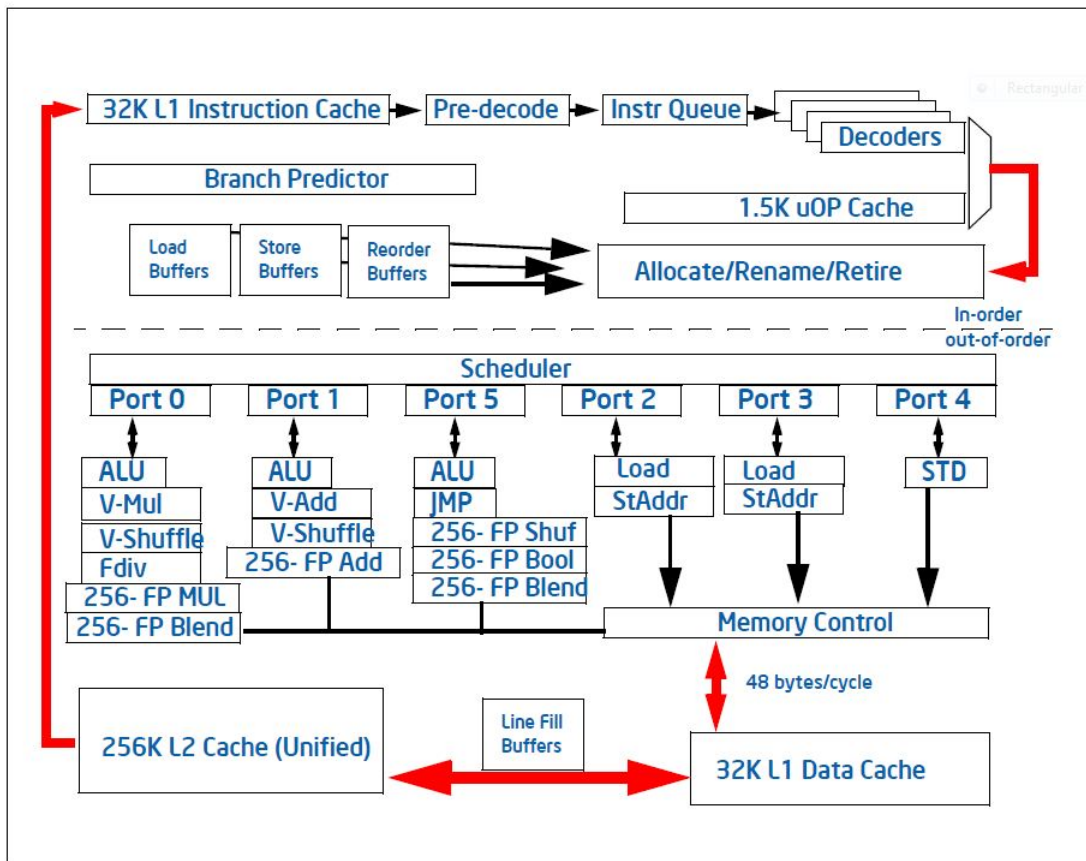

Figure 2-1. Intel microarchitecture code name Sandy Bridge Pipeline Functionality

Figure 1.2: Block diagram of the Intel Sandy Bridge core

are. Division operations can take 10 or 20 clock cycles, while a CPU can have multiple addition and/or multiplication units that (asymptotically) can produce a result per cycle.

### 1.2.1.3 Pipelining

The floating point add and multiply units of a processor are pipelined, which has the effect that a stream of independent operations can be performed at an asymptotic speed of one result per clock cycle.

The idea behind a pipeline is as follows. Assume that an operation consists of multiple simpler operations, and that for each suboperation there is separate hardware in the processor. For instance, an addition instruction can have the following components:

- Decoding the instruction, including finding the locations of the operands.
- Copying the operands into registers ('data fetch').
- Aligning the exponents; the addition  $.35 \times 10^{-1} + .6 \times 10^{-2}$  becomes  $.35 \times 10^{-1} + .06 \times 10^{-1}$ .
- Executing the addition of the mantissas, in this case giving .41.

Processor	year	add/mult/fma units (count×width)	daxpy cycles (arith vs load/store)
MIPS R10000	1996	$1 \times 1 + 1 \times 1 + 0$	8/24
Alpha EV5	1996	$1 \times 1 + 1 \times 1 + 0$	8/12
IBM Power5	2004	$0 + 0 + 2 \times 1$	4/12
AMD Bulldozer	2011	$2 \times 2 + 2 \times 2 + 0$	2/4
Intel Sandy Bridge	2012	$1 \times 4 + 1 \times 4 + 0$	2/4
Intel Haswell	2014	$0 + 0 + 2 \times 4$	1/2

Table 1.1: Floating point capabilities (per core) of several processor architectures, and DAXPY cycle number for 8 operands

- Normalizing the result, in this example to  $.41 \times 10^{-1}$ . (Normalization in this example does not do anything. Check for yourself that in  $.3 \times 10^0 + .8 \times 10^0$  and  $.35 \times 10^{-3} + (-.34) \times 10^{-3}$  there is a non-trivial adjustment.)
- Storing the result.

These parts are often called the ‘stages’ or ‘segments’ of the pipeline.

If every component is designed to finish in 1 clock cycle, the whole instruction takes 6 cycles. However, if each has its own hardware, we can execute two operations in less than 12 cycles:

- Execute the decode stage for the first operation;
- Do the data fetch for the first operation, and at the same time the decode for the second.
- Execute the third stage for the first operation and the second stage of the second operation simultaneously.
- Et cetera.

You see that the first operation still takes 6 clock cycles, but the second one is finished a mere 1 cycle later.

Let us make a formal analysis of the speedup you can get from a pipeline. On a traditional FPU, producing  $n$  results takes  $t(n) = n\ell\tau$  where  $\ell$  is the number of stages, and  $\tau$  the clock cycle time. The rate at which results are produced is the reciprocal of  $t(n)/n$ :  $r_{\text{serial}} \equiv (\ell\tau)^{-1}$ .

On the other hand, for a pipelined FPU the time is  $t(n) = [s + \ell + n - 1]\tau$  where  $s$  is a setup cost: the first operation still has to go through the same stages as before, but after that one more result will be produced each cycle. We can also write this formula as

$$t(n) = [n + n_{1/2}]\tau.$$

**Exercise 1.1.** Let us compare the speed of a classical FPU, and a pipelined one. Show that the result rate is now dependent on  $n$ : give a formula for  $r(n)$ , and for  $r_\infty = \lim_{n \rightarrow \infty} r(n)$ . What is the asymptotic improvement in  $r$  over the non-pipelined case? Next you can wonder how long it takes to get close to the asymptotic behaviour. Show that for  $n = n_{1/2}$  you get  $r(n) = r_\infty/2$ . This is often used as the definition of  $n_{1/2}$ .

Since a vector processor works on a number of instructions simultaneously, these instructions have to be independent. The operation  $\forall_i: a_i \leftarrow b_i + c_i$  has independent additions; the operation  $\forall_i: a_{i+1} \leftarrow$

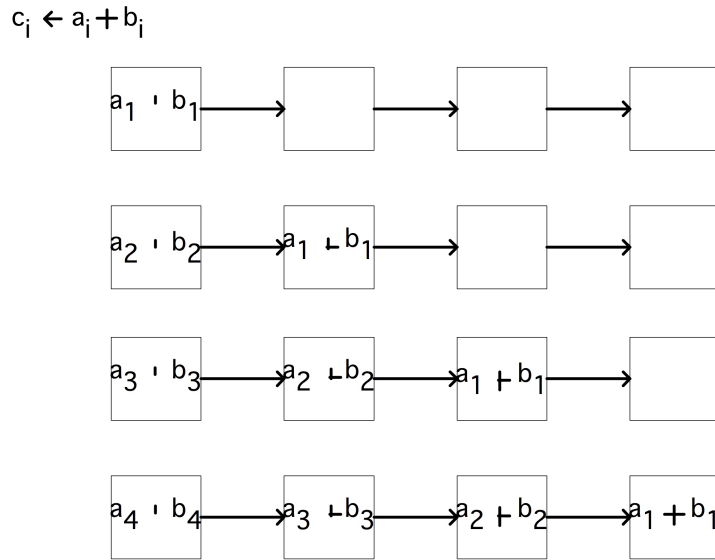

Figure 1.3: Schematic depiction of a pipelined operation

$a_i b_i + c_i$  feeds the result of one iteration ( $a_i$ ) to the input of the next ( $a_{i+1} = \dots$ ), so the operations are not independent.

A pipelined processor can speed up operations by a factor of 4, 5, 6 with respect to earlier CPUs. Such numbers were typical in the 1980s when the first successful vector computers came on the market. These days, CPUs can have 20-stage pipelines. Does that mean they are incredibly fast? This question is a bit complicated. Chip designers continue to increase the clock rate, and the pipeline segments can no longer finish their work in one cycle, so they are further split up. Sometimes there are even segments in which nothing happens: that time is needed to make sure data can travel to a different part of the chip in time.

The amount of improvement you can get from a pipelined CPU is limited, so in a quest for ever higher performance several variations on the pipeline design have been tried. For instance, the Cyber 205 had separate addition and multiplication pipelines, and it was possible to feed one pipe into the next without data going back to memory first. Operations like  $\forall_i: a_i \leftarrow b_i + c \cdot d_i$  were called ‘linked triads’ (because of the number of paths to memory, one input operand had to be scalar).

**Exercise 1.2.** Analyse the speedup and  $n_{1/2}$  of linked triads.

Another way to increase performance is to have multiple identical pipes. This design was perfected by the NEC SX series. With, for instance, 4 pipes, the operation  $\forall_i: a_i \leftarrow b_i + c_i$  would be split module 4, so that the first pipe operated on indices  $i = 4 \cdot j$ , the second on  $i = 4 \cdot j + 1$ , et cetera.

**Exercise 1.3.** Analyze the speedup and  $n_{1/2}$  of a processor with multiple pipelines that operate in parallel. That is, suppose that there are  $p$  independent pipelines, executing the same instruction, that can each handle a stream of operands.

(You may wonder why we are mentioning some fairly old computers here: true pipeline supercomputers hardly exist anymore. In the US, the Cray X1 was the last of that line, and in Japan only NEC still makes them. However, the functional units of a CPU these days are pipelined, so the notion is still important.)

**Exercise 1.4.** The operation

```
for (i) {
    x[i+1] = a[i]*x[i] + b[i];
}
```

can not be handled by a pipeline because there is a *dependency* between input of one iteration of the operation and the output of the previous. However, you can transform the loop into one that is mathematically equivalent, and potentially more efficient to compute. Derive an expression that computes  $x[i+2]$  from  $x[i]$  without involving  $x[i+1]$ . This is known as *recursive doubling*. Assume you have plenty of temporary storage. You can now perform the calculation by

- Doing some preliminary calculations;
- computing  $x[i], x[i+2], x[i+4], \dots$ , and from these,
- compute the missing terms  $x[i+1], x[i+3], \dots$ .

Analyze the efficiency of this scheme by giving formulas for  $T_0(n)$  and  $T_s(n)$ . Can you think of an argument why the preliminary calculations may be of lesser importance in some circumstances?

#### 1.2.1.4 Peak performance

Thanks to pipelining, for modern CPUs there is a simple relation between the *clock speed* and the *peak performance*. Since each FPU can produce one result per cycle asymptotically, the peak performance is the clock speed times the number of independent FPUs. The measure of floating point performance is ‘floating point operations per second’, abbreviated *flops*. Considering the speed of computers these days, you will mostly hear floating point performance being expressed in ‘gigaflops’: multiples of  $10^9$  flops.

### 1.2.2 8-bit, 16-bit, 32-bit, 64-bit

Processors are often characterized in terms of how big a chunk of data they can process as a unit. This can relate to

- The width of the path between processor and memory: can a 64-bit floating point number be loaded in one cycle, or does it arrive in pieces at the processor.
- The way memory is addressed: if addresses are limited to 16 bits, only 64,000 bytes can be identified. Early PCs had a complicated scheme with segments to get around this limitation: an address was specified with a segment number and an offset inside the segment.
- The number of bits in a register, in particular the size of the integer registers which manipulate data address; see the previous point. (Floating point register are often larger, for instance 80 bits in the x86 architecture.) This also corresponds to the size of a chunk of data that a processor can operate on simultaneously.

- The size of a floating point number. If the arithmetic unit of a CPU is designed to multiply 8-byte numbers efficiently (‘double precision’; see section 3.2.2) then numbers half that size (‘single precision’) can sometimes be processed at higher efficiency, and for larger numbers (‘quadruple precision’) some complicated scheme is needed. For instance, a quad precision number could be emulated by two double precision numbers with a fixed difference between the exponents.

These measurements are not necessarily identical. For instance, the original Pentium processor had 64-bit data busses, but a 32-bit processor. On the other hand, the Motorola 68000 processor (of the original Apple Macintosh) had a 32-bit CPU, but 16-bit data busses.

The first Intel microprocessor, the 4004, was a 4-bit processor in the sense that it processed 4 bit chunks. These days, 64 bit processors are becoming the norm.

### 1.2.3 Caches: on-chip memory

The bulk of computer memory is in chips that are separate from the processor. However, there is usually a small amount (typically a few megabytes) of on-chip memory, called the *cache*. This will be explained in detail in section 1.3.4.

### 1.2.4 Graphics, controllers, special purpose hardware

One difference between ‘consumer’ and ‘server’ type processors is that the consumer chips devote considerable real-estate on the processor chip to graphics. Processors for cell phones and tablets can even have dedicated circuitry for security or mp3 playback. Other parts of the processor are dedicated to communicating with memory or the *I/O subsystem*. We will not discuss those aspects in this book.

### 1.2.5 Superscalar processing and instruction-level parallelism

In the von Neumann model processors operate through *control flow*: instructions follow each other linearly or with branches without regard for what data they involve. As processors became more powerful and capable of executing more than one instruction at a time, it became necessary to switch to the *data flow* model. Such *superscalar* processors analyze several instructions to find data dependencies, and execute instructions in parallel that do not depend on each other.

This concept is also known as *Instruction Level Parallelism (ILP)*, and it is facilitated by various mechanisms:

- multiple-issue: instructions that are independent can be started at the same time;
- pipelining: already mentioned, arithmetic units can deal with multiple operations in various stages of completion;
- branch prediction and speculative execution: a compiler can ‘guess’ whether a conditional instruction will evaluate to true, and execute those instructions accordingly;
- out-of-order execution: instructions can be rearranged if they are not dependent on each other, and if the resulting execution will be more efficient;
- prefetching: data can be speculatively requested before any instruction needing it is actually encountered (this is discussed further in section 1.3.5).

Above, you saw pipelining in the context of floating point operations. Nowadays, the whole CPU is pipelined. Not only floating point operations, but any sort of instruction will be put in the *instruction pipeline* as soon as possible. Note that this pipeline is no longer limited to identical instructions: the notion of pipeline is now generalized to any stream of partially executed instructions that are simultaneously “in flight”.

As clock frequency has gone up, the processor pipeline has grown in length to make the segments executable in less time. You have already seen that longer pipelines have a larger  $n_{1/2}$ , so more independent instructions are needed to make the pipeline run at full efficiency. As the limits to instruction-level parallelism are reached, making pipelines longer (sometimes called ‘deeper’) no longer pays off. This is generally seen as the reason that chip designers have moved to *multicore* architectures as a way of more efficiently using the transistors on a chip; section 1.4.

There is a second problem with these longer pipelines: if the code comes to a branch point (a conditional or the test in a loop), it is not clear what the next instruction to execute is. At that point the pipeline can *stall*. CPUs have taken to *speculative execution* for instance, by always assuming that the test will turn out true. If the code then takes the other branch (this is called a *branch misprediction*), the pipeline has to be *flushed* and restarted. The resulting delay in the execution stream is called the *branch penalty*.

## 1.3 Memory Hierarchies

We will now refine the picture of the Von Neuman architecture, in which data is loaded immediately from memory to the processors, where it is operated on. This picture is unrealistic because of the so-called *memory wall* [166]: the memory is too slow to load data into the process at the rate the processor can absorb it. Specifically, a single load can take 1000 cycles, while a processor can perform several operations per cycle. (After this long wait for a load, the next load can come faster, but still too slow for the processor. This matter of wait time versus throughput will be addressed below in section 1.3.2.)

In reality, there will be various memory levels in between the FPU and the main memory: the registers and the caches, together called the *memory hierarchy*. These try to alleviate the memory wall problem by making recently used data available quicker than it would be from main memory. Of course, this presupposes that the algorithm and its implementation allow for data to be used multiple times. Such questions of *data reuse* will be discussed in more detail in section 1.5.1.

Both registers and caches are faster than main memory to various degrees; unfortunately, the faster the memory on a certain level, the smaller it will be. These differences in size and access speed lead to interesting programming problems, which we will discuss later in this chapter, and particularly section 1.6.

We will now discuss the various components of the memory hierarchy and the theoretical concepts needed to analyze their behaviour.

### 1.3.1 Busses

The wires that move data around in a computer, from memory to cpu or to a disc controller or screen, are called *busses*. The most important one for us is the *Front-Side Bus (FSB)* which connects the processor

to memory. In one popular architecture, this is called the ‘north bridge’, as opposed to the ‘south bridge’ which connects to external devices, with the exception of the graphics controller.

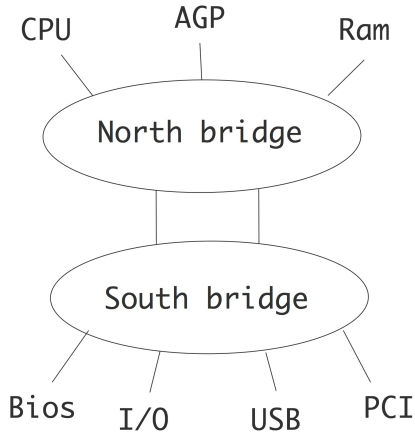

Figure 1.4: Bus structure of a processor

The bus is typically slower than the processor, operating with clock frequencies slightly in excess of 1GHz, which is a fraction of the CPU clock frequency. This is one reason that caches are needed; the fact that a processors can consume many data items per clock tick contributes to this. Apart from the frequency, the bandwidth of a bus is also determined by the number of bits that can be moved per clock cycle. This is typically 64 or 128 in current architectures. We will now discuss this in some more detail.

### 1.3.2 Latency and Bandwidth

Above, we mentioned in very general terms that accessing data in registers is almost instantaneous, whereas loading data from memory into the registers, a necessary step before any operation, incurs a substantial delay. We will now make this story slightly more precise.

There are two important concepts to describe the movement of data: *latency* and *bandwidth*. The assumption here is that requesting an item of data incurs an initial delay; if this item was the first in a stream of data, usually a consecutive range of memory addresses, the remainder of the stream will arrive with no further delay at a regular amount per time period.

**Latency** is the delay between the processor issuing a request for a memory item, and the item actually arriving. We can distinguish between various latencies, such as the transfer from memory to cache, cache to register, or summarize them all into the latency between memory and processor. Latency is measured in (nano) seconds, or clock periods.

If a processor executes instructions in the order they are found in the assembly code, then execution will often *stall* while data is being fetched from memory; this is also called *memory stall*. For this reason, a low latency is very important. In practice, many processors have ‘out-of-order execution’ of instructions, allowing them to perform other operations while waiting for the requested data. Programmers can take this into account, and code in a way that achieves *latency*

*hiding*; see also section 1.5.1. Graphics Processing Units (GPUs) (see section 2.10.3) can switch very quickly between threads in order to achieve latency hiding.

**Bandwidth** is the rate at which data arrives at its destination, after the initial latency is overcome. Bandwidth is measured in bytes (kilobytes, megabytes, gigabytes) per second or per clock cycle. The bandwidth between two memory levels is usually the product of the cycle speed of the channel (the *bus speed*) and the *bus width*: the number of bits that can be sent simultaneously in every cycle of the bus clock.

The concepts of latency and bandwidth are often combined in a formula for the time that a message takes from start to finish:

$$T(n) = \alpha + \beta n$$

where  $\alpha$  is the latency and  $\beta$  is the inverse of the bandwidth: the time per byte.

Typically, the further away from the processor one gets, the longer the latency is, and the lower the bandwidth. These two factors make it important to program in such a way that, if at all possible, the processor uses data from cache or register, rather than from main memory. To illustrate that this is a serious matter, consider a vector addition

```
for (i)
  a[i] = b[i]+c[i]
```

Each iteration performs one floating point operation, which modern CPUs can do in one clock cycle by using pipelines. However, each iteration needs two numbers loaded and one written, for a total of 24 bytes<sup>7</sup> of memory traffic. Typical memory bandwidth figures (see for instance figure 1.5) are nowhere near 24 (or 32) bytes per cycle. This means that, without caches, algorithm performance can be bounded by memory performance. Of course, caches will not speed up every operations, and in fact will have no effect on the above example. Strategies for programming that lead to significant cache use are discussed in section 1.6.

The concepts of latency and bandwidth will also appear in parallel computers, when we talk about sending data from one processor to the next.

### 1.3.3 Registers

Every processor has a small amount of memory that is internal to the processor: the *registers*, or together the *register file*. The registers are what the processor actually operates on: an operation such as

```
a := b + c
```

is actually implemented as

- load the value of  $b$  from memory into a register,
- load the value of  $c$  from memory into another register,
- compute the sum and write that into yet another register, and
- write the sum value back to the memory location of  $a$ .

7. Actually,  $a[i]$  is loaded before it can be written, so there are 4 memory access, with a total of 32 bytes, per iteration.



## 1. Single-processor Computing

---

Looking at assembly code (for instance the output of a compiler), you see the explicit load, compute, and store instructions.

Compute instructions such as add or multiply only operate on registers. For instance, in *assembly language* you will see instructions such as

```
addl %eax, %edx
```

which adds the content of one register to another. As you see in this sample instruction, registers are not numbered, as opposed to memory addresses, but have distinct names that are referred to in the assembly instruction. Typically, a processor has 16 or 32 floating point registers; the *Intel Itanium* was exceptional with 128 floating point registers.

Registers have a high bandwidth and low latency because they are part of the processor. You can consider data movement to and from registers as essentially instantaneous.

In this chapter you will see stressed that moving data from memory is relatively expensive. Therefore, it would be a simple optimization to leave data in register when possible. For instance, if the above computation is followed by a statement

```
a := b + c
d := a + e
```

the computed value of *a* could be left in register. This optimization is typically performed as a *compiler optimization*: the compiler will simply not generate the instructions for storing and reloading *a*. We say that *a* stays *resident in register*.

Keeping values in register is often done to avoid recomputing a quantity. For instance, in

```
t1 = sin(alpha) * x + cos(alpha) * y;
t2 = -cos(alpha) * x + sin(alpha) * y;
```

the sine and cosine quantity will probably be kept in register. You can help the compiler by explicitly introducing temporary quantities:

```
s = sin(alpha); c = cos(alpha);
t1 = s * x + c * y;
t2 = -c * x + s * y
```

Of course, there is a limit to how many quantities can be kept in register; trying to keep too many quantities in register is called *register spill* and lowers the performance of a code.

Keeping a variable in register is especially important if that variable appears in an inner loop. In the computation

```
for i=1,length
  a[i] = b[i] * c
```

the quantity *c* will probably be kept in register by the compiler, but in

```

for k=1,nvectors
  for i=1,length
    a[i,k] = b[i,k] * c[k]

```

it is a good idea to introduce explicitly a temporary variable to hold  $c[k]$ . In C, you can give a hint to the compiler to keep a variable in register by declaring it as a *register variable*:

```
register double t;
```

### 1.3.4 Caches

In between the registers, which contain the immediate input and output data for instructions, and the main memory where lots of data can reside for a long time, are various levels of *cache* memory, that have lower latency and higher bandwidth than main memory and where data are kept for an intermediate amount of time. Caches typically consist of *Static Random-Access Memory (SRAM)*, which is faster than then *Dynamic Random-Access Memory (DRAM)* used for the main memory, but is also more expensive.

Data from memory travels through the caches to wind up in registers. The advantage to having cache memory is that if a data item is reused shortly after it was first needed, it will still be in cache, and therefore it can be accessed much faster than if it would have to be brought in from memory.

#### 1.3.4.1 A motivating example

As an example, let's suppose a variable  $x$  is used twice, and its uses are too far apart that it would stay *resident in register*:

```

... = ... x ..... // instruction using x
.....           // several instructions not involving x
... = ... x ..... // instruction using x

```

The assembly code would then be

- load  $x$  from memory into register; operate on it;
- do the intervening instructions;
- load  $x$  from memory into register; operate on it;

With a cache, the assembly code stays the same, but the actual behaviour of the memory system now becomes:

- load  $x$  from memory into cache, and from cache into register; operate on it;
- do the intervening instructions;
- request  $x$  from memory, but since it is still in the cache, load it from the cache into register; operate on it.

Since loading from cache is faster than loading from main memory, the computation will now be faster. Caches are fairly small, so values can not be kept there indefinitely. We will see the implications of this in the following discussion.

There is an important difference between cache memory and registers: while data is moved into register by explicit assembly instructions, the move from main memory to cache is entirely done by hardware. Thus cache use and reuse is outside of direct programmer control. Later, especially in sections 1.5.2 and 1.6, you will see how it is possible to influence cache use indirectly.

### 1.3.4.2 Cache levels, speed and size

The caches are called ‘level 1’ and ‘level 2’ (or, for short, L1 and L2) cache; some processors can have an L3 cache. The L1 and L2 caches are part of the *die*, the processor chip, although for the L2 cache that is a relatively recent development; the L3 cache is off-chip. The L1 cache is small, typically around 16Kbyte. Level 2 (and, when present, level 3) cache is more plentiful, up to several megabytes, but it is also slower. Unlike main memory, which is expandable, caches are fixed in size. If a version of a processor chip exists with a larger cache, it is usually considerably more expensive.

Data needed in some operation gets copied into the various caches on its way to the processor. If, some instructions later, a data item is needed again, it is first searched for in the L1 cache; if it is not found there, it is searched for in the L2 cache; if it is not found there, it is loaded from main memory. Finding data in cache is called a *cache hit*, and not finding it a *cache miss*.

Figure 1.5 illustrates the basic facts of the *cache hierarchy*, in this case for the *Intel Sandy Bridge* chip: the closer caches are to the FPUs, the faster, but also the smaller they are. Some points about this figure.

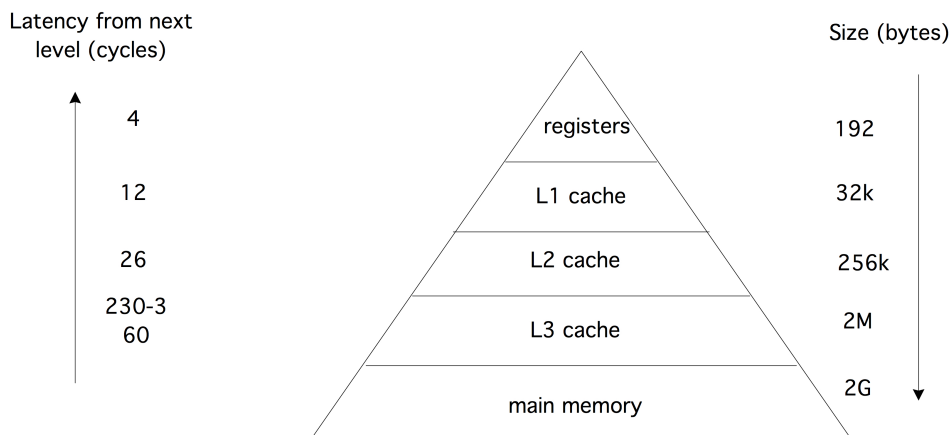

Figure 1.5: Memory hierarchy of an Intel Sandy Bridge, characterized by speed and size.

- Loading data from registers is so fast that it does not constitute a limitation on algorithm execution speed. On the other hand, there are few registers. Each core has 16 general purpose registers, and 16 SIMD registers.
- The L1 cache is small, but sustains a bandwidth of 32 bytes, that is 4 double precision number, per cycle. This is enough to load two operands each for two operations, but note that the core can actually perform 4 operations per cycle. Thus, to achieve peak speed, certain operands need to stay in register: typically, L1 bandwidth is enough for about half of peak performance.

- The bandwidth of the L2 and L3 cache is nominally the same as of L1. However, this bandwidth is partly wasted on coherence issues.
- Main memory access has a latency of more than 100 cycles, and a bandwidth of 4.5 bytes per cycle, which is about 1/7th of the L1 bandwidth. However, this bandwidth is shared by the multiple cores of a processor chip, so effectively the bandwidth is a fraction of this number. Most clusters will also have more than one *socket* (processor chip) per node, typically 2 or 4, so some bandwidth is spent on maintaining *cache coherence* (see section 1.4), again reducing the bandwidth available for each chip.

On level 1, there are separate caches for instructions and data; the L2 and L3 cache contain both data and instructions.

You see that the larger caches are increasingly unable to supply data to the processors fast enough. For this reason it is necessary to code in such a way that data is kept as much as possible in the highest cache level possible. We will discuss this issue in detail in the rest of this chapter.

**Exercise 1.5.** The L1 cache is smaller than the L2 cache, and if there is an L3, the L2 is smaller than the L3. Give a practical and a theoretical reason why this is so.

#### 1.3.4.3 Types of cache misses

There are three types of cache misses.

As you saw in the example above, the first time you reference data you will always incur a cache miss. This is known as a *compulsory cache miss* since these are unavoidable. Does that mean that you will always be waiting for a data item, the first time you need it? Not necessarily: section 1.3.5 explains how the hardware tries to help you by predicting what data is needed next.

The next type of cache misses is due to the size of your working set: a *capacity cache miss* is caused by data having been overwritten because the cache can simply not contain all your problem data. (Section 1.3.4.5 discusses how the processor decides what data to overwrite.) If you want to avoid this type of misses, you need to partition your problem in chunks that are small enough that data can stay in cache for an appreciable time. Of course, this presumes that data items are operated on multiple times, so that there is actually a point in keeping it in cache; this is discussed in section 1.5.1.

Finally, there are *conflict misses* caused by one data item being mapped to the same cache location as another, while both are still needed for the computation, and there would have been better candidates to evict. This is discussed in section 1.3.4.9.

In a *multicore* context there is a further type of cache miss: the *invalidation miss*. This happens if an item in cache has become invalid because another core changed the value of the corresponding memory address. The core will then have to reload this address.

#### 1.3.4.4 Reuse is the name of the game

The presence of one or more caches is not immediately a guarantee for high performance: this largely depends on the *memory access pattern* of the code, and how well this exploits the caches. The first time that an item is referenced, it is copied from memory into cache, and through to the processor registers. The

latency and bandwidth for this are not mitigated in any way by the presence of a cache. When the same item is referenced a second time, it may be found in cache, at a considerably reduced cost in terms of latency and bandwidth: caches have shorter latency and higher bandwidth than main memory.

We conclude that, first, an algorithm has to have an opportunity for data reuse. If every data item is used only once (as in addition of two vectors), there can be no reuse, and the presence of caches is largely irrelevant. A code will only benefit from the increased bandwidth and reduced latency of a cache if items in cache are referenced more than once; see section 1.5.1 for a detailed discussion.. An example would be the matrix-vector multiplication  $y = Ax$  where each element of  $x$  is used in  $n$  operations, where  $n$  is the matrix dimension.

Secondly, an algorithm may theoretically have an opportunity for reuse, but it needs to be coded in such a way that the reuse is actually exposed. We will address these points in section 1.5.2. This second point especially is not trivial.

Some problems are small enough that they fit completely in cache, at least in the L3 cache. This is something to watch out for when *benchmarking*, since it gives a too rosy picture of processor performance.

### 1.3.4.5 Replacement policies

Data in cache and registers is placed there by the system, outside of programmer control. Likewise, the system decides when to overwrite data in the cache or in registers if it is not referenced in a while, and as other data needs to be placed there. Below, we will go into detail on how caches do this, but as a general principle, a Least Recently Used (LRU) cache replacement policy is used: if a cache is full and new data needs to be placed into it, the data that was least recently used is *flushed*, meaning that it is overwritten with the new item, and therefore no longer accessible. LRU is by far the most common replacement policy; other possibilities are FIFO (first in first out) or random replacement.

**Exercise 1.6.** Sketch a simple scenario, and give some (pseudo) code, to argue that LRU is preferable over FIFO as a replacement strategy.

### 1.3.4.6 Cache lines

Data movement between memory and cache, or between caches, is not done in single bytes, or even words. Instead, the smallest unit of data moved is called a *cache line*, sometimes called a *cache block*. A typical cache line is 64 or 128 bytes long, which in the context of scientific computing implies 8 or 16 double precision floating point numbers. The cache line size for data moved into L2 cache can be larger than for data moved into L1 cache.

It is important to acknowledge the existence of cache lines in coding, since any memory access costs the transfer of several words (see section 1.6.4 for some examples). An efficient program then tries to use the other items on the cache line, since access to them is effectively free. This phenomenon is visible in code that accesses arrays by *stride*: elements are read or written at regular intervals.

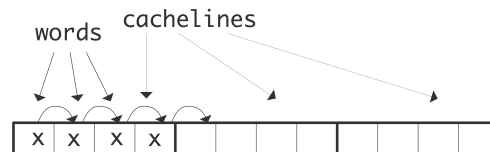

Figure 1.6: Accessing 4 elements at stride 1

Stride 1 corresponds to sequential access of an array:

```
for (i=0; i<N; i++)
    ... = ... x[i] ...
```

Let us use as illustration a case with 4 words per cacheline. Requesting the first elements loads the whole cacheline that contains it into cache. A request for the 2nd, 3rd, and 4th element can then be satisfied from cache, meaning with high bandwidth and low latency.

A larger stride

```
for (i=0; i<N; i+=stride)
    ... = ... x[i] ...
```



Figure 1.7: Accessing 4 elements at stride 3

implies that in every cache line only certain elements are used. We illustrate that with stride 3: requesting the first elements loads a cacheline, and this cacheline also contains the second element. However, the third element is on the next cacheline, so loading this incurs the latency and bandwidth of main memory. The same holds for the fourth element. Loading four elements now needed loading three cache lines instead of one, meaning that two-thirds of the available bandwidth has been wasted. (This second case would also incur three times the latency of the first, if it weren't for a hardware mechanism that notices the regular access patterns, and pre-emptively loads further cachelines; see section 1.3.5.)

Some applications naturally lead to strides greater than 1, for instance, accessing only the real parts of an array of complex numbers (for some remarks on the practical realization of complex numbers see section 3.5.5). Also, methods that use *recursive doubling* often have a code structure that exhibits non-unit strides

```
for (i=0; i<N/2; i++)
    x[i] = y[2*i];
```

In this discussion of cachelines, we have implicitly assumed the beginning of a cacheline is also the beginning of a word, be that an integer or a floating point number. This need not be true: an 8-byte floating point number can be placed straddling the boundary between two cachelines. You can imagine that this is not good for performance. Section 31.1.3 discusses ways to address *cacheline boundary alignment* in practice.

#### 1.3.4.7 Cache mapping

Caches get faster, but also smaller, the closer to the FPUs they get, yet even the largest cache is considerably smaller than the main memory size. We already noted that this has implications for the cache replacement strategy. Another issue we need to address in this context is that of *cache mapping*, which is the question of ‘if an item is placed in cache, where does it get placed’. This problem is generally addressed by mapping the (main memory) address of the item to an address in cache, leading to the question ‘what if two items get mapped to the same address’.

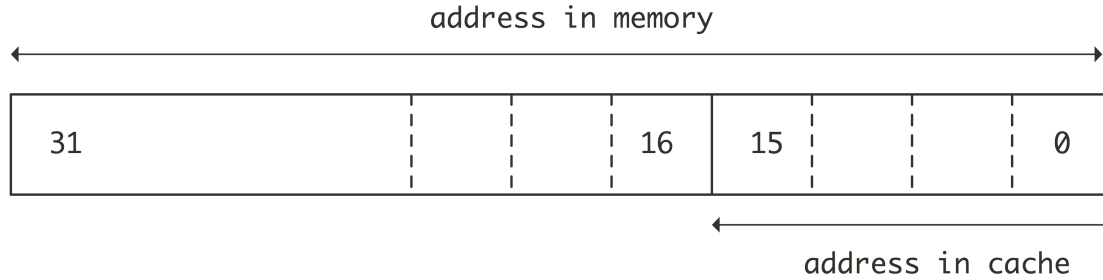

Figure 1.8: Direct mapping of 32-bit addresses into a 64K cache

#### 1.3.4.8 Direct mapped caches

The simplest cache mapping strategy is *direct mapping*. Suppose that memory addresses are 32 bits long, so that they can address 4G bytes<sup>8</sup>; suppose further that the cache has 8K words, that is, 64K bytes, needing 16 bits to address. Direct mapping then takes from each memory address the last (‘least significant’) 16 bits, and uses these as the address of the data item in cache; see figure 1.8.

Direct mapping is very efficient because its address calculations can be performed very quickly, leading to low latency, but it has a problem in practical applications. If two items are addressed that are separated by 8K words, they will be mapped to the same cache location, which will make certain calculations inefficient.

Example:

```
double A[3][8192];
for (i=0; i<512; i++)
    a[2][i] = ( a[0][i]+a[1][i] )/2.;
```

or in Fortran:

```
real*8 A(8192, 3);
do i=1, 512
    a(i, 3) = ( a(i, 1)+a(i, 2) )/2
end do
```

Here, the locations of  $a[0][i]$ ,  $a[1][i]$ , and  $a[2][i]$  (or  $a(i, 1)$ ,  $a(i, 2)$ ,  $a(i, 3)$ ) are 8K from each other for every  $i$ , so the last 16 bits of their addresses will be the same, and hence they will be mapped to the same location in cache. The execution of the loop will now go as follows:

- The data at  $a[0][0]$  is brought into cache and register. This engenders a certain amount of latency. Together with this element, a whole cache line is transferred.
- The data at  $a[1][0]$  is brought into cache (and register, as we will not remark anymore from now on), together with its whole cache line, at cost of some latency. Since this cache line is mapped to the same location as the first, the first cache line is overwritten.

8. We implicitly use the convention that K,M,G suffixes refer to powers of 2 rather than 10: 1K=1024, 1M=1,048,576, 1G=1,073,741,824.

- In order to write the output, the cache line containing  $a[2][0]$  is brought into memory. This is again mapped to the same location, causing flushing of the cache line just loaded for  $a[1][0]$ .
- In the next iteration,  $a[0][1]$  is needed, which is on the same cache line as  $a[0][0]$ . However, this cache line has been flushed, so it needs to be brought in anew from main memory or a deeper cache level. In doing so, it overwrites the cache line that holds  $a[2][0]$ .
- A similar story hold for  $a[1][1]$ : it is on the cache line of  $a[1][0]$ , which unfortunately has been overwritten in the previous step.

If a cache line holds four words, we see that each four iterations of the loop involve eight transfers of elements of  $a$ , where two would have sufficed, if it were not for the cache conflicts.

**Exercise 1.7.** In the example of direct mapped caches, mapping from memory to cache was done by using the final 16 bits of a 32 bit memory address as cache address. Show that the problems in this example go away if the mapping is done by using the first ('most significant') 16 bits as the cache address. Why is this not a good solution in general?

#### 1.3.4.9 Associative caches

The problem of cache conflicts, outlined in the previous section, would be solved if any data item could go to any cache location. In that case there would be no conflicts, other than the cache filling up, in which case a cache replacement policy (section 1.3.4.5) would flush data to make room for the incoming item. Such a cache is called *fully associative*, and while it seems optimal, it is also very costly to build, and much slower in use than a direct mapped cache.

For this reason, the most common solution is to have a *k-way associative cache*, where  $k$  is at least two. In this case, a data item can go to any of  $k$  cache locations. Code would have to have a  $k + 1$ -way conflict before data would be flushed prematurely as in the above example. In that example, a value of  $k = 2$  would suffice, but in practice higher values are often encountered. Figure 1.9 illustrates the mapping of

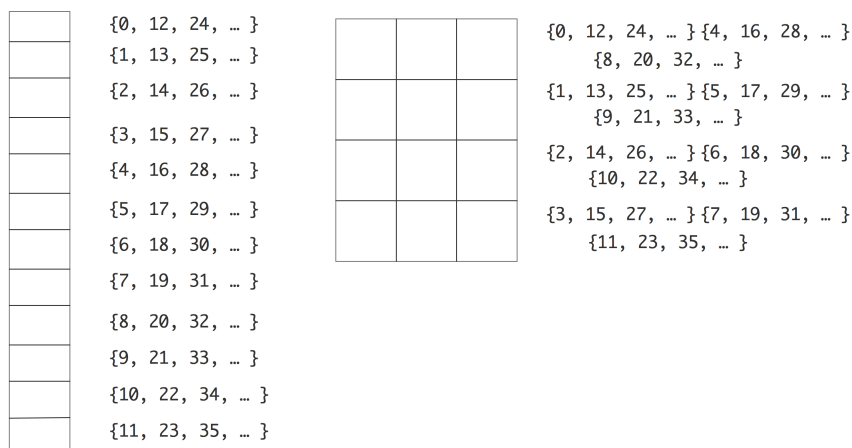

Figure 1.9: Two caches of 12 elements: direct mapped (left) and 3-way associative (right)



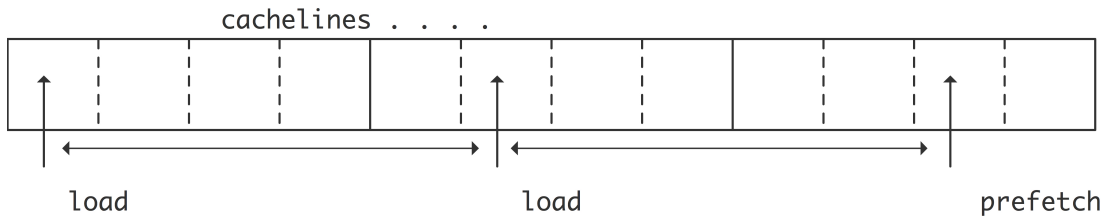

Figure 1.10: Prefetch stream generated by equally spaced requests

memory addresses to cache locations for a direct mapped and a 3-way associative cache. Both caches has 12 elements, but addressed differently. The direct mapped cache (left) will have a conflict between memory address 0 and 12, but in the 3-way associative cache these two addresses can be mapped to any of three elements.

As a practical example, the *Intel Woodcrest* processor has an L1 cache of 32K bytes that is 8-way set associative with a 64 byte cache line size, and an L2 cache of 4M bytes that is 8-way set associative with a 64 byte cache line size. On the other hand, the *AMD Barcelona* chip has 2-way associativity for the L1 cache, and 8-way for the L2. A higher associativity (‘way-ness’) is obviously desirable, but makes a processor slower, since determining whether an address is already in cache becomes more complicated. For this reason, the associativity of the L1 cache, where speed is of the greatest importance, is typically lower than of the L2.

**Exercise 1.8.** Write a small cache simulator in your favourite language. Assume a  $k$ -way associative cache of 32 entries and an architecture with 16 bit addresses. Run the following experiment for  $k = 1, 2, 4, \dots$ :

1. Let  $k$  be the associativity of the simulated cache.
2. Write the translation from 16 bit memory addresses to  $32/k$  cache addresses.
3. Generate 32 random machine addresses, and simulate storing them in cache.

Since the cache has 32 entries, optimally the 32 addresses can all be stored in cache. The chance of this actually happening is small, and often the data of one address will be evicted from the cache (meaning that it is overwritten) when another address conflicts with it. Record how many addresses, out of 32, are actually stored in the cache at the end of the simulation. Do step 3 100 times, and plot the results; give median and average value, and the standard deviation. Observe that increasing the associativity improves the number of addresses stored. What is the limit behaviour? (For bonus points, do a formal statistical analysis.)

### 1.3.5 Prefetch streams

In the traditional von Neumann model (section 1.1), each instruction contains the location of its operands, so a CPU implementing this model would make a separate request for each new operand. In practice, often subsequent data items are adjacent or regularly spaced in memory. The memory system can try to detect such data patterns by looking at cache miss points, and request a *prefetch data stream* (figure 1.10).

In its simplest form, the CPU will detect that consecutive loads come from two consecutive cache lines, and automatically issue a request for the next following cache line. This process can be repeated or extended if the code makes an actual request for that third cache line. Since these cache lines are now brought from memory well before they are needed, prefetch has the possibility of eliminating the latency for all but the first couple of data items.

The concept of *cache miss* now needs to be revisited a little. From a performance point of view we are only interested in *stalls* on cache misses, that is, the case where the computation has to wait for the data to be brought in. Data that is not in cache, but can be brought in while other instructions are still being processed, is not a problem. If an ‘L1 miss’ is understood to be only a ‘stall on miss’, then the term ‘L1 cache refill’ is used to describe all cacheline loads, whether the processor is stalling on them or not.

Since prefetch is controlled by the hardware, it is also described as *hardware prefetch*. Prefetch streams can sometimes be controlled from software, though often it takes assembly code, for instance *inline assembly* instructions in your C code, to do so. On the *IBM BlueGene Q* prefetch can be activated by program directives.

### 1.3.6 Concurrency and memory transfer

In the discussion about the memory hierarchy we made the point that memory is slower than the processor. As if that is not bad enough, it is not even trivial to exploit all the bandwidth that memory offers. In other words, if you don’t program carefully you will get even less performance than you would expect based on the available bandwidth. Let’s analyze this.

The memory system typically has a bandwidth of more than one floating point number per cycle, so you need to issue that many requests per cycle to utilize the available bandwidth. This would be true even with zero latency; since there is latency, it takes a while for data to make it from memory and be processed. Consequently, any data requested based on computations on the first data has to be requested with a delay at least equal the memory latency.

For full utilization of the bandwidth, at all times a volume of data equal to the bandwidth times the latency has to be in flight. Since these data have to be independent, we get a statement of *Little’s law* [116]:

$$\text{Concurrency} = \text{Bandwidth} \times \text{Latency}.$$

This is illustrated in figure 1.11. The problem with maintaining this concurrency is not that a program does not have it; rather, the program is to get the compiler and runtime system recognize it. For instance, if a loop traverses a long array, the compiler will not issue a large number of memory requests. The prefetch mechanism (section 1.3.5) will issue some memory requests ahead of time, but typically not enough. Thus, in order to use the available bandwidth, multiple streams of data need to be under way simultaneously. Therefore, we can also phrase Little’s law as

$$\text{Effective throughput} = \text{Expressed concurrency} / \text{Latency}.$$

### 1.3.7 Memory banks

Above, we discussed issues relating to bandwidth. You saw that memory, and to a lesser extent caches, have a bandwidth that is less than what a processor can maximally absorb. The situation is actually even worse

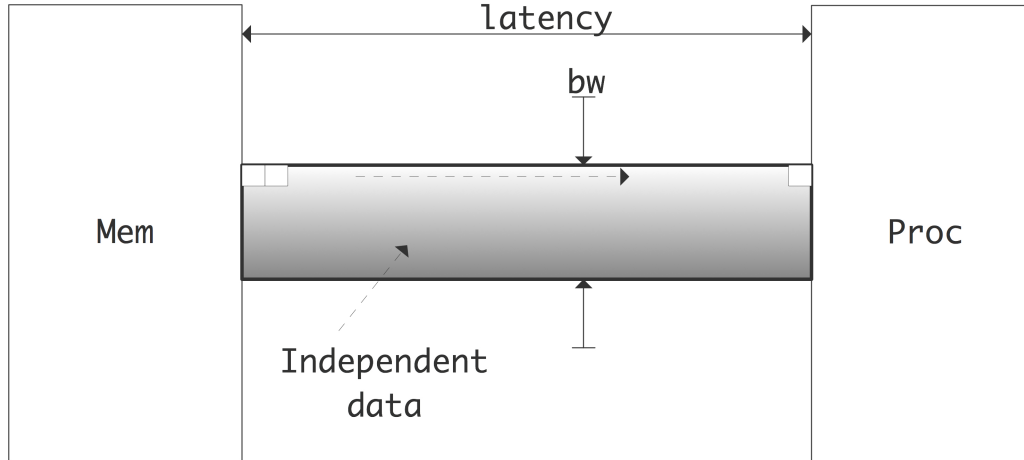

Figure 1.11: Illustration of Little's Law that states how much independent data needs to be in flight

than the above discussion made it seem. For this reason, memory is often divided into *memory banks* that are interleaved: with four memory banks, words 0, 4, 8, . . . are in bank 0, words 1, 5, 9, . . . are in bank 1, et cetera.

Suppose we now access memory sequentially, then such 4-way interleaved memory can sustain four times the bandwidth of a single memory bank. Unfortunately, accessing by stride 2 will halve the bandwidth, and larger strides are even worse. In practice the number of memory banks will be higher, so that strided memory access with small strides will still have the full advertised bandwidth.

This concept of banks can also apply to caches. For instance, the cache lines in the L1 cache of the *AMD Barcelona* chip are 16 words long, divided into two interleaved banks of 8 words. This means that sequential access to the elements of a cache line is efficient, but strided access suffers from a deteriorated performance.

### 1.3.8 TLB and virtual memory

All of a program's data may not be in memory simultaneously. This can happen for a number of reasons:

- The computer serves multiple users, so the memory is not dedicated to any one user;
- The computer is running multiple programs, which together need more than the physically available memory;
- One single program can use more data than the available memory.

For this reason, computers use *Virtual memory*: if more memory is needed than is available, certain blocks of memory are written to disc. In effect, the disc acts as an extension of the real memory. This means that a block of data can be anywhere in memory, and in fact, if it is *swapped* in and out, it can be in different locations at different times. Swapping does not act on individual memory locations, but rather on *memory pages*: contiguous blocks of memory, from a few kilobytes to megabytes in size. (In an earlier generation of operating systems, moving memory to disc was a programmer's responsibility. Pages that would replace each other were called *overlays*.)

For this reason, we need a translation mechanism from the memory addresses that the program uses to the actual addresses in memory, and this translation has to be dynamic. A program has a ‘logical data space’ (typically starting from address zero) of the addresses used in the compiled code, and this needs to be translated during program execution to actual memory addresses. For this reason, there is a *page table* that specifies which memory pages contain which logical pages.

However, address translation by lookup in this table is slow, so CPUs have a *Translation Look-aside Buffer (TLB)*. The TLB is a cache of frequently used Page Table Entries: it provides fast address translation for a number of pages. If a program needs a memory location, the TLB is consulted to see whether this location is in fact on a page that is remembered in the TLB. If this is the case, the logical address is translated to a physical one; this is a very fast process. The case where the page is not remembered in the TLB is called a *TLB miss*, and the page lookup table is then consulted, if necessary bringing the needed page into memory. The TLB is (sometimes fully) associative (section 1.3.4.9), using an LRU policy (section 1.3.4.5).

A typical TLB has between 64 and 512 entries. If a program accesses data sequentially, it will typically alternate between just a few pages, and there will be no TLB misses. On the other hand, a program that access many random memory locations can experience a slowdown because of such misses.

Section 1.6.5 and appendix 31.5 discuss some simple code illustrating the behaviour of the TLB.

[There are some complications to this story. For instance, there is usually more than one TLB. The first one is associated with the L2 cache, the second one with the L1. In the *AMD Opteron*, the L1 TLB has 48 entries, and is fully (48-way) associative, while the L2 TLB has 512 entries, but is only 4-way associative. This means that there can actually be TLB conflicts. In the discussion above, we have only talked about the L2 TLB. The reason that this can be associated with the L2 cache, rather than with main memory, is that the translation from memory to L2 cache is deterministic.]

## 1.4 Multicore architectures

In recent years, the limits of performance have been reached for the traditional processor chip design.

- Clock frequency can not be increased further, since it increases energy consumption, heating the chips too much; see section 1.7.
- It is not possible to extract more Instruction Level Parallelism (ILP) from codes, either because of compiler limitations, because of the limited amount of intrinsically available parallelism, or because branch prediction makes it impossible (see section 1.2.5).

One of the ways of getting a higher utilization out of a single processor chip is then to move from a strategy of further sophistication of the single processor, to a division of the chip into multiple processing ‘cores’<sup>9</sup>. The separate cores can work on unrelated tasks, or, by introducing what is in effect data parallelism (section 2.4.1), collaborate on a common task at a higher overall efficiency.

This solves the above two problems:

9. Another solution is Intel’s *hyperthreading*, which lets a processor mix the instructions of several instruction streams. The benefits of this are strongly dependent on the individual case. However, this same mechanism is exploited with great success in GPUs; see section 2.10.3. For a discussion see section 2.7.1.10

- Two cores at a lower frequency can have the same throughput as a single processor at a higher frequency; hence, multiple cores are more energy-efficient.
- Discovered ILP is now replaced by explicit task parallelism, managed by the programmer.

While the first multicore CPUs were simply two processors on the same die, later generations incorporated L3 or L2 caches that were shared between the two processor cores; see figure 1.12 This design makes it

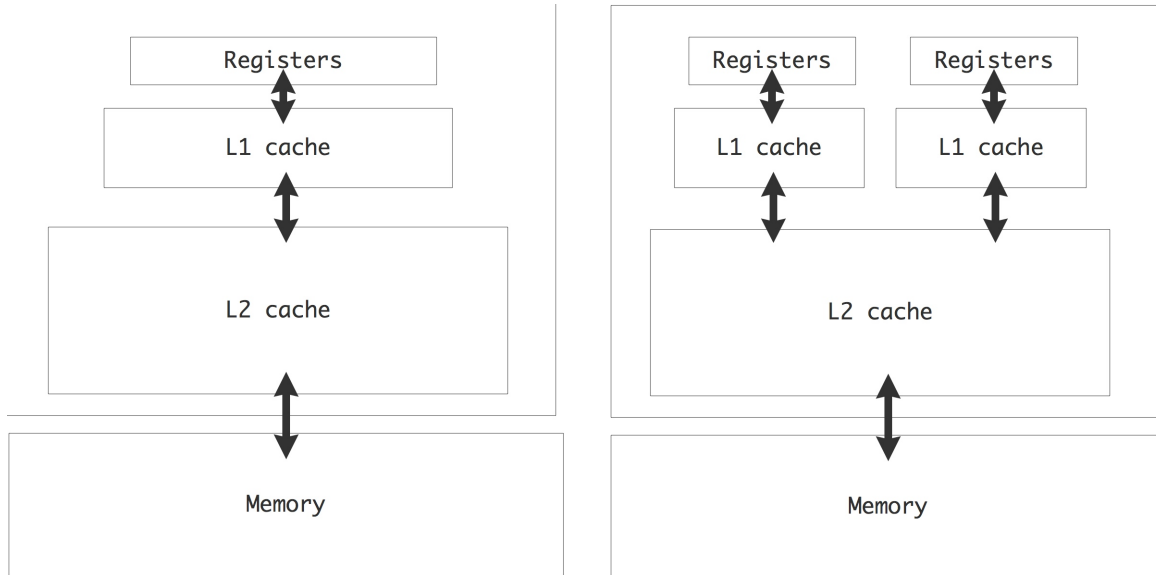

Figure 1.12: Cache hierarchy in a single-core and dual-core chip

efficient for the cores to work jointly on the same problem. The cores would still have their own L1 cache, and these separate caches lead to a *cache coherence* problem; see section 1.4.1 below.

We note that the term ‘processor’ is now ambiguous: it can refer to either the chip, or the processor core on the chip. For this reason, we mostly talk about a *socket* for the whole chip and *core* for the part containing one arithmetic and logic unit and having its own registers. Currently, CPUs with 4 or 6 cores are common, even in laptops, and Intel and AMD are marketing 12-core chips. The core count is likely to go up in the future: Intel has already shown an 80-core prototype that is developed into the 48 core ‘Single-chip Cloud Computer’, illustrated in fig 1.13. This chip has a structure with 24 dual-core ‘tiles’ that are connected through a 2D mesh network. Only certain tiles are connected to a memory controller, others can not reach memory other than through the on-chip network.

With this mix of shared and private caches, the programming model for multicore processors is becoming a hybrid between shared and distributed memory:

*Core* The cores have their own private L1 cache, which is a sort of distributed memory. The above mentioned Intel 80-core prototype has the cores communicating in a distributed memory fashion.

*Socket* On one socket, there is often a shared L2 cache, which is shared memory for the cores.

*Node* There can be multiple sockets on a single ‘node’ or motherboard, accessing the same shared memory.

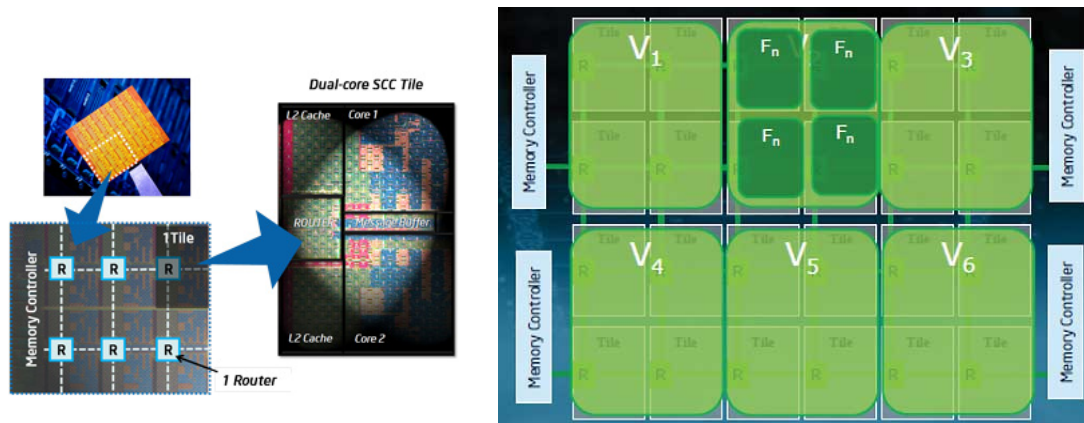

Figure 1.13: Structure of the Intel Single-chip Cloud Computer chip

*Network* Distributed memory programming (see the next chapter) is needed to let nodes communicate. Historically, multicore architectures have a precedent in multiprocessor shared memory designs (section 2.5.1) such as the *Sequent Symmetry* and the *Alliant FX/8*. Conceptually the program model is the same, but the technology now allows to shrink a multiprocessor board to a multicore chip.

### 1.4.1 Cache coherence

With parallel processing, there is the potential for a conflict if more than one processor has a copy of the same data item. The problem of ensuring that all cached data are an accurate copy of main memory, is referred to as *cache coherence*: if one processor alters its copy, the other copy needs to be updated.

In distributed memory architectures, a dataset is usually partitioned disjointly over the processors, so conflicting copies of data can only arise with knowledge of the user, and it is up to the user to deal with the problem. The case of shared memory is more subtle: since processes access the same main memory, it would seem that conflicts are in fact impossible. However, processor typically have some private cache, which contains copies of data from memory, so conflicting copies can occur. This situation arises in particular in multicore designs.

Suppose that two cores have a copy of the same data item in their (private) L1 cache, and one modifies its copy. Now the other has cached data that is no longer an accurate copy of its counterpart: the processor will *invalidate* that copy of the item, and in fact its whole cacheline. When the process needs access to the item again, it needs to reload that cacheline. The alternative is for any core that alters data to send that cacheline to the other cores. This strategy probably has a higher overhead, since other cores are not likely to have a copy of a cacheline.

This process of updating or invalidating cachelines is known as *maintaining cache coherence*, and it is done on a very low level of the processor, with no programmer involvement needed. (This makes updating memory locations an *atomic operation*; more about this in section 2.7.1.5.) However, it will slow down the computation, and it wastes bandwidth to the core that could otherwise be used for loading or storing operands.

The state of a cache line with respect to a data item in main memory is usually described as one of the following:

- Scratch: the cache line does not contain a copy of the item;
- Valid: the cache line is a correct copy of data in main memory;
- Reserved: the cache line is the *only* copy of that piece of data;
- Dirty: the cache line has been modified, but not yet written back to main memory;
- Invalid: the data on the cache line is also present on other processors (it is not *reserved*), and another process has modified its copy of the data.

A simpler variant of this is the Modified-Shared-Invalid (MSI) coherence protocol, where a cache line can be in the following states on a given core:

- Modified: the cacheline has been modified, and needs to be written to the backing store. This writing can be done when the line is *evicted*, or it is done immediately, depending on the write-back policy.
- Shared: the line is present in at least one cache and is unmodified.
- Invalid: the line is not present in the current cache, or it is present but a copy in another cache has been modified.

These states control the movement of cachelines between memory and the caches. For instance, suppose a core does a read to a cacheline that is invalid on that core. It can then load it from memory or get it from another cache, which may be faster. (Finding whether a line exists (in state M or S) on another cache is called *snooping*; an alternative is to maintain cache directories.) If the line is Shared, it can now simply be copied; if it is in state M in the other cache, that core first needs to write it back to memory.

**Exercise 1.9.** Consider two processors, a data item  $x$  in memory, and cachelines  $x_1, x_2$  in the private caches of the two processors to which  $x$  is mapped. Describe the transitions between the states of  $x_1$  and  $x_2$  under reads and writes of  $x$  on the two processors. Also indicate which actions cause memory bandwidth to be used. (This list of transitions is a *Finite State Automaton (FSA)*; see section 17.)

Variants of the MSI protocol add an ‘Exclusive’ or ‘Owned’ state for increased efficiency.

### 1.4.1.1 Snooping

The *snooping* mechanism can also be used as follows: if a core ‘listens in’ on all bus traffic, it can invalidate or update its own cacheline copies when another core modifies its copy. Invalidating is cheaper than updating since it is a bit operation, while updating involves copying the whole cacheline.

**Exercise 1.10.** When would updating pay off? Write a simple cache simulator to evaluate this question.

### 1.4.1.2 False sharing

The cache coherence problem can even appear if the cores access different items. For instance, a declaration

```
double x, y;
```

will likely allocate  $x$  and  $y$  next to each other in memory, so there is a high chance they fall on the same cacheline. Now if one core updates  $x$  and the other  $y$ , this cacheline will continuously be moved between the cores. This is called *false sharing*—underline. The most common case of false sharing happens when threads update consecutive locations of an array:

```
local_results[thread_num] = ....
```

### 1.4.2 Computations on multicore chips

Multicore chips offer a form of shared memory parallelism and can be programmed as such, for instance using OpenMP (section 2.7.2). We will go discuss in some detail the scheduling of linear algebra operations on multicore chips; section 6.12.

## 1.5 Locality and data reuse

By now it should be clear that there is more to the execution of an algorithm than counting the operations: the data transfer involved is important, and can in fact dominate the cost. Since we have caches and registers, the amount of data transfer can be minimized by programming in such a way that data stays as close to the processor as possible. Partly this is a matter of programming cleverly, but we can also look at the theoretical question: does the algorithm allow for it to begin with.

It turns out that in scientific computing there is often data often interacts mostly with data that is close by in some sense, which will lead to data locality; section 1.5.2. Often such locality derives from the nature of the application, as in the case of the Partial Differential Equations (PDEs) you will see in chapter 4. In other cases such as molecular dynamics (chapter 7) there is no such intrinsic locality because all particles interact with all others, and considerable programming cleverness is needed to get high performance.

### 1.5.1 Data reuse and arithmetic intensity

In the previous sections you learned that processor design is somewhat unbalanced: loading data is slower than executing the actual operations. This imbalance is large for main memory and less for the various cache levels. Thus we are motivated to keep data in cache and keep the amount of *data reuse* as high as possible.

Of course, we need to determine first if the computation allows for data to be reused. For this we define the *arithmetic intensity* of an algorithm as follows:

If  $n$  is the number of data items that an algorithm operates on, and  $f(n)$  the number of operations it takes, then the arithmetic intensity is  $f(n)/n$ .

(We can measure data items in either floating point numbers or bytes. The latter possibility makes it easier to relate arithmetic intensity to hardware specifications of a processor.)

Arithmetic intensity is also related to *latency hiding*: the concept that you can mitigate the negative performance impact of data loading behind computational activity going on. For this to work, you need more computations than data loads to make this hiding effective. And that is the very definition of computational intensity: a high ratio of operations per byte/word/number loaded.



### 1.5.1.1 Examples

Consider for example the vector addition

$$\forall_i: x_i \leftarrow x_i + y_i.$$

This involves three memory accesses (two loads and one store) and one operation per iteration, giving a arithmetic intensity of  $1/3$ . The *axy* (for ‘a times x plus y’) operation

$$\forall_i: x_i \leftarrow x_i + a \cdot y_i$$

has two operations, but the same number of memory access since the one-time load of  $a$  is amortized. It is therefore more efficient than the simple addition, with a reuse of  $2/3$ .

The inner product calculation

$$\forall_i: s \leftarrow s + x_i \cdot y_i$$

is similar in structure to the *axy* operation, involving one multiplication and addition per iteration, on two vectors and one scalar. However, now there are only two load operations, since  $s$  can be kept in register and only written back to memory at the end of the loop. The reuse here is 1.

Next, consider the *matrix-matrix product*:

$$\forall_{i,j}: c_{ij} = \sum_k a_{ik} b_{kj}.$$

This involves  $3n^2$  data items and  $2n^3$  operations, which is of a higher order. The arithmetic intensity is  $O(n)$ , meaning that every data item will be used  $O(n)$  times. This has the implication that, with suitable programming, this operation has the potential of overcoming the bandwidth/clock speed gap by keeping data in fast cache memory.

**Exercise 1.11.** The matrix-matrix product, considered as *operation*, clearly has data reuse by the above definition. Argue that this reuse is not trivially attained by a simple implementation. What determines whether the naive implementation has reuse of data that is in cache?

[In this discussion we were only concerned with the number of operations of a given *implementation*, not the mathematical *operation*. For instance, there are ways of performing the matrix-matrix multiplication and Gaussian elimination algorithms in fewer than  $O(n^3)$  operations [151, 134]. However, this requires a different implementation, which has its own analysis in terms of memory access and reuse.]

The matrix-matrix product is the heart of the *LINPACK benchmark* [43]; see section 2.11.5. Using this as the solve measure of *benchmarking* a computer may give an optimistic view of its performance: the matrix-matrix product is an operation that has considerable data reuse, so it is relatively insensitive to memory bandwidth and, for parallel computers, properties of the network. Typically, computers will attain 60–90% of their *peak performance* on the Linpack benchmark. Other benchmark may give considerably lower figures.

### 1.5.1.2 The roofline model

There is an elegant way of talking about how arithmetic intensity, which is a statement about the ideal algorithm, not its implementation, interacts with hardware parameters and the actual implementation to determine performance. This is known as the *roofline model* [165], and it expresses the basic fact that performance is bounded by two factors, illustrated in the left graph of figure 1.14.

1. The *peak performance*, indicated by the horizontal line at the top of the graph, is an absolute bound on the performance<sup>10</sup>, achieved only if every aspect of a CPU (pipelines, multiple floating point units) are perfectly used. The calculation of this number is purely based on CPU properties and clock cycle; it is assumed that memory bandwidth is not a limiting factor.
2. The number of operations per second is also limited by the product of the bandwidth, an absolute number, and the arithmetic intensity:

$$\frac{\text{operations}}{\text{second}} = \frac{\text{operations}}{\text{data item}} \cdot \frac{\text{data items}}{\text{second}}$$

This is depicted by the linearly increasing line in the graph.

The roofline model is an elegant way of expressing that various factors lower the ceiling. For instance, if an algorithm fails to use the full *SIMD width*, this imbalance lowers the attainable peak. The second graph in figure 1.14 indicates various factors that lower the ceiling. There are also various factors that lower the available bandwidth, such as imperfect data hiding. This is indicated by a lowering of the sloping roofline in the third graph.

For a given arithmetic intensity, the performance is determined by where its vertical line intersects the roof line. If this is at the horizontal part, the computation is called *compute-bound*: performance is determined by characteristics of the processor, and bandwidth is not an issue. On the other hand, if that vertical line intersects the sloping part of the roof, the computation is called *bandwidth-bound*: performance is determined by the memory subsystem, and the full capacity of the processor is not used.

**Exercise 1.12.** How would you determine whether a given program kernel is bandwidth or compute bound?

## 1.5.2 Locality

Since using data in cache is cheaper than getting data from main memory, a programmer obviously wants to code in such a way that data in cache is reused. While placing data in cache is not under explicit programmer control, even from assembly language, in most CPUs<sup>11</sup>, it is still possible, knowing the behaviour of the caches, to know what data is in cache, and to some extent to control it.

The two crucial concepts here are *temporal locality* and *spatial locality*. Temporal locality is the easiest to explain: this describes the use of a data element within a short time of its last use. Since most caches have a LRU replacement policy (section 1.3.4.5), if in between the two references less data has been referenced than the cache size, the element will still be in cache and therefore be quickly accessible. With other replacement policies, such as random replacement, this guarantee can not be made.

10. An old joke states that the peak performance is that number that the manufacturer guarantees you will never exceed

11. Low level memory access can be controlled by the programmer in the Cell processor and in some GPUs.

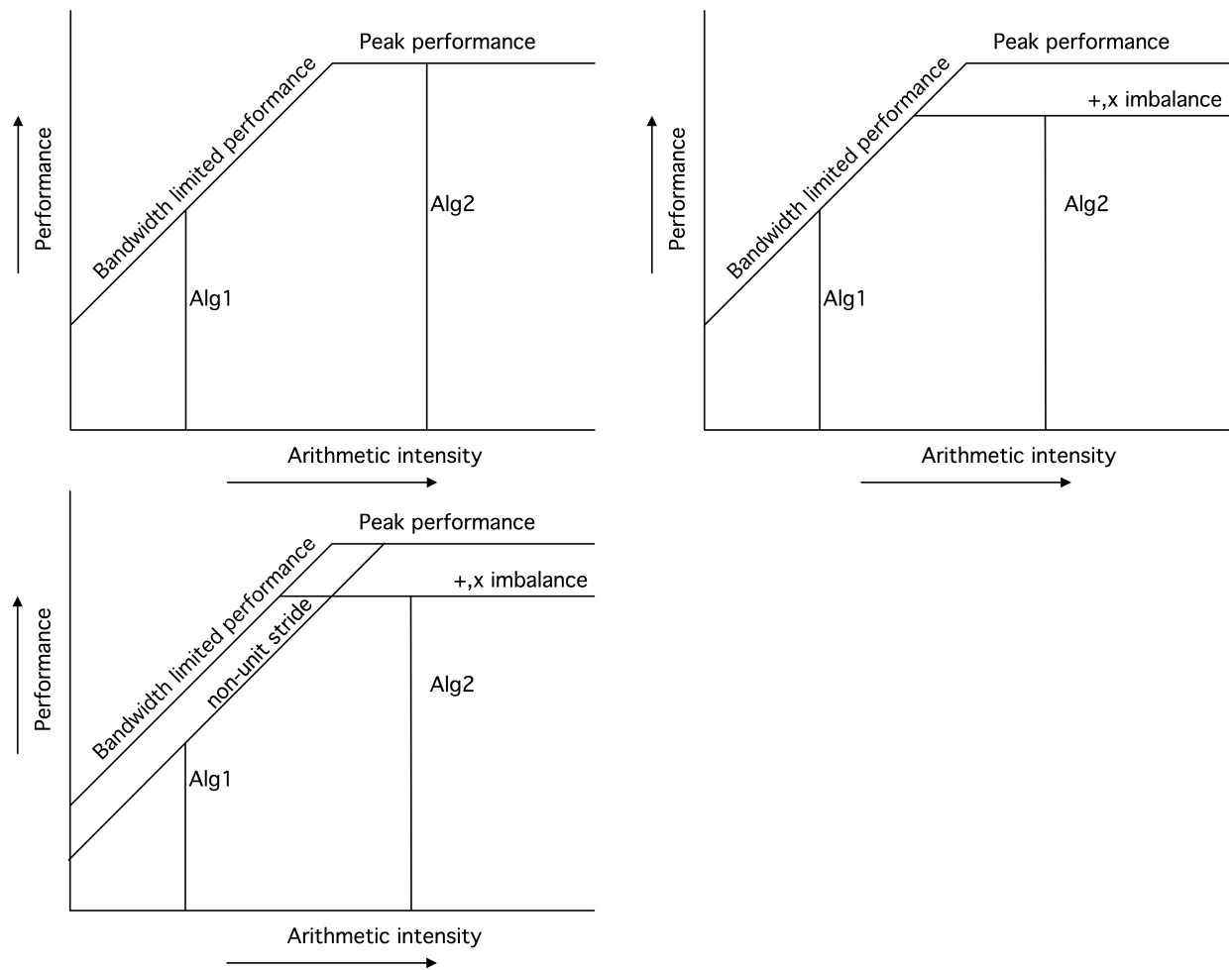

Figure 1.14: Illustration of factors determining performance in the roofline model

### 1.5.2.1 Temporal locality

As an example of temporal locality, consider the repeated use of a long vector:

```
for (loop=0; loop<10; loop++) {
    for (i=0; i<N; i++) {
        ... = ... x[i] ...
    }
}
```

Each element of  $x$  will be used 10 times, but if the vector (plus other data accessed) exceeds the cache size, each element will be flushed before its next use. Therefore, the use of  $x[i]$  does not exhibit temporal locality: subsequent uses are spaced too far apart in time for it to remain in cache.

If the structure of the computation allows us to exchange the loops:

```
for (i=0; i<N; i++) {
    for (loop=0; loop<10; loop++) {
        ... = ... x[i] ...
    }
}
```

the elements of  $x$  are now repeatedly reused, and are therefore more likely to remain in the cache. This rearranged code displays better temporal locality in its use of  $x[i]$ .

### 1.5.2.2 Spatial locality

The concept of *spatial locality* is slightly more involved. A program is said to exhibit spatial locality if it references memory that is ‘close’ to memory it already referenced. In the classical von Neumann architecture with only a processor and memory, spatial locality should be irrelevant, since one address in memory can be as quickly retrieved as any other. However, in a modern CPU with caches, the story is different. Above, you have seen two examples of spatial locality:

- Since data is moved in *cache lines* rather than individual words or bytes, there is a great benefit to coding in such a manner that all elements of the cacheline are used. In the loop

```
for (i=0; i<N*s; i+=s) {
    ... x[i] ...
}
```

spatial locality is a decreasing function of the *stride*  $s$ .

Let  $S$  be the cacheline size, then as  $s$  ranges from  $1 \dots S$ , the number of elements used of each cacheline goes down from  $S$  to 1. Relatively speaking, this increases the cost of memory traffic in the loop: if  $s = 1$ , we load  $1/S$  cachelines per element; if  $s = S$ , we load one cacheline for each element. This effect is demonstrated in section 1.6.4.

- A second example of spatial locality worth observing involves the TLB (section 1.3.8). If a program references elements that are close together, they are likely on the same memory page, and address translation through the TLB will be fast. On the other hand, if a program references

many widely disparate elements, it will also be referencing many different pages. The resulting TLB misses are very costly; see also section 1.6.5.

**Exercise 1.13.** Consider the following pseudocode of an algorithm for summing  $n$  numbers  $x[i]$  where  $n$  is a power of 2:

```
for s=2, 4, 8, ..., n/2, n:
  for i=0 to n-1 with steps s:
    x[i] = x[i] + x[i+s/2]
sum = x[0]
```

Analyze the spatial and temporal locality of this algorithm, and contrast it with the standard algorithm

```
sum = 0
for i=0, 1, 2, ..., n-1
  sum = sum + x[i]
```

**Exercise 1.14.** Consider the following code, and assume that `nvectors` is small compared to the cache size, and `length` large.

```
for (k=0; k<nvectors; k++)
  for (i=0; i<length; i++)
    a[k,i] = b[i] * c[k]
```

How do the following concepts relate to the performance of this code:

- Reuse
- Cache size
- Associativity

Would the following code where the loops are exchanged perform better or worse, and why?

```
for (i=0; i<length; i++)
  for (k=0; k<nvectors; k++)
    a[k,i] = b[i] * c[k]
```

### 1.5.2.3 Examples of locality

Let us examine locality issues for a realistic example. The matrix-matrix multiplication  $C \leftarrow A \cdot B$  can be computed in several ways. We compare two implementations, assuming that all matrices are stored by rows, and that the cache size is insufficient to store a whole row or column.

```
for i=1..n
  for j=1..n
    for k=1..n
      c[i,j] += a[i,k]*b[k,j]
for i=1..n
  for k=1..n
    for j=1..n
      c[i,j] += a[i,k]*b[k,j]
```

These implementations are illustrated in figure 1.15 The first implementation constructs the  $(i, j)$  element

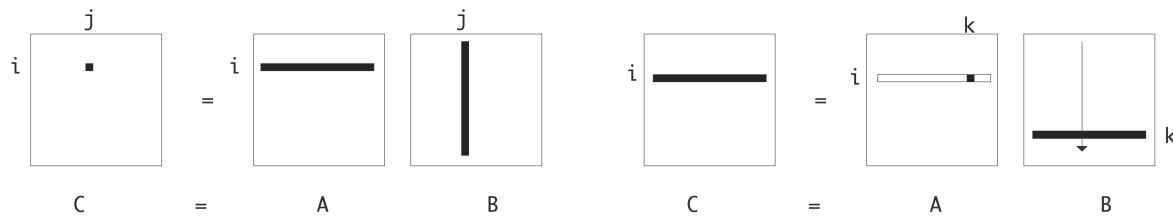
Figure 1.15: Two loop orderings for the  $C \leftarrow A \cdot B$  matrix-matrix product

of  $C$  by the inner product of a row of  $A$  and a column of  $B$ , in the second a row of  $C$  is updated by scaling rows of  $B$  by elements of  $A$ .

Our first observation is that both implementations indeed compute  $C \leftarrow C + A \cdot B$ , and that they both take roughly  $2n^3$  operations. However, their memory behaviour, including spatial and temporal locality is very different.

- $c[i, j]$  In the first implementation,  $c[i, j]$  is invariant in the inner iteration, which constitutes temporal locality, so it can be kept in register. As a result, each element of  $C$  will be loaded and stored only once.  
In the second implementation,  $c[i, j]$  will be loaded and stored in each inner iteration. In particular, this implies that there are now  $n^3$  store operations, a factor of  $n$  more than the first implementation.
- $a[i, k]$  In both implementations,  $a[i, k]$  elements are accessed by rows, so there is good spatial locality, as each loaded cacheline will be used entirely. In the second implementation,  $a[i, k]$  is invariant in the inner loop, which constitutes temporal locality; it can be kept in register. As a result, in the second case  $A$  will be loaded only once, as opposed to  $n$  times in the first case.
- $b[k, j]$  The two implementations differ greatly in how they access the matrix  $B$ . First of all,  $b[k, j]$  is never invariant so it will not be kept in register, and  $B$  engenders  $n^3$  memory loads in both cases. However, the access patterns differ.  
In second case,  $b[k, j]$  is access by rows so there is good spatial locality: cachelines will be fully utilized after they are loaded.  
In the first implementation,  $b[k, j]$  is accessed by columns. Because of the row storage of the matrices, a cacheline contains a part of a row, so for each cacheline loaded, only one element is used in the columnwise traversal. This means that the first implementation has more loads for  $B$  by a factor of the cacheline length. There may also be TLB effects.

Note that we are not making any absolute predictions on code performance for these implementations, or even relative comparison of their runtimes. Such predictions are very hard to make. However, the above discussion identifies issues that are relevant for a wide range of classical CPUs.

**Exercise 1.15.** There are more algorithms for computing the product  $C \leftarrow A \cdot B$ . Consider the following:

```

for k=1..n:
  for i=1..n:
    for j=1..n:

```

$$c[i, j] += a[i, k] * b[k, j]$$

Analyze the memory traffic for the matrix  $C$ , and show that it is worse than the two algorithms given above.

### 1.5.2.4 Core locality

The above concepts of spatial and temporal locality were mostly properties of programs, although hardware properties such as cacheline length and cache size play a role in analyzing the amount of locality. There is a third type of locality that is more intimately tied to hardware: *core locality*.

A code's execution is said to exhibit core locality if write accesses that are spatially or temporally close are performed on the same core or processing unit. The issue here is that of *cache coherence* (section 1.4.1) where two cores both have a copy of a certain cacheline in their local stores. If they both read from it there is no problem. However, if one of them writes to it, the coherence protocol will copy the cacheline to the other core's local store. This takes up precious memory bandwidth, so it is to be avoided.

Core locality is not just a property of a program, but also to a large extent of how the program is executed in parallel.

## 1.6 Programming strategies for high performance

In this section we will look at how different ways of programming can influence the performance of a code. This will only be an introduction to the topic; for further discussion see the book by Goedecker and Hoisie [66].

The full listings of the codes and explanations of the data graphed here can be found in appendix 31. All performance results were obtained on the *AMD Opteron* processors of the Ranger computer [139].

### 1.6.1 Peak performance

For marketing purposes, it may be desirable to define a 'top speed' for a CPU. Since a pipelined floating point unit can yield one result per cycle asymptotically, you would calculate the theoretical *peak performance* as the product of the clock speed (in ticks per second), number of floating point units, and the number of cores; see section 1.4. This top speed is unobtainable in practice, and very few codes come even close to it. The *Linpack benchmark* is one of the measures how close you can get to it; the parallel version of this benchmark is reported in the 'top 500'; see section 2.11.5.

### 1.6.2 Pipelining

In section 1.2.1.3 you learned that the floating point units in a modern CPU are pipelined, and that pipelines require a number of independent operations to function efficiently. The typical pipelineable operation is a vector addition; an example of an operation that can not be pipelined is the inner product accumulation

```
for (i=0; i<N; i++)
    s += a[i]*b[i]
```

The fact that `s` gets both read and written halts the addition pipeline. One way to fill the *floating point pipeline* is to apply *loop unrolling*:

```
for (i = 0; i < N/2-1; i ++) {
    sum1 += a[2*i] * b[2*i];
    sum2 += a[2*i+1] * b[2*i+1];
}
```

Now there are two independent multiplies in between the accumulations. With a little indexing optimization this becomes:

```
for (i = 0; i < N/2-1; i ++) {
    sum1 += *(a + 0) * *(b + 0);
    sum2 += *(a + 1) * *(b + 1);

    a += 2; b += 2;
}
```

A first observation about this code is that we are implicitly using associativity and commutativity of addition: while the same quantities are added, they are now in effect added in a different order. As you will see in chapter 3, in computer arithmetic this is not guaranteed to give the exact same result.

In a further optimization, we disentangle the addition and multiplication part of each instruction. The hope is that while the accumulation is waiting for the result of the multiplication, the intervening instructions will keep the processor busy, in effect increasing the number of operations per second.

```
for (i = 0; i < N/2-1; i ++) {
    temp1 = *(a + 0) * *(b + 0);
    temp2 = *(a + 1) * *(b + 1);

    sum1 += temp1; sum2 += temp2;

    a += 2; b += 2;
}
```

Finally, we realize that the furthest we can move the addition away from the multiplication, is to put it right in front of the multiplication *of the next iteration*:

```
for (i = 0; i < N/2-1; i ++) {
    sum1 += temp1;
    temp1 = *(a + 0) * *(b + 0);

    sum2 += temp2;
```



```
temp2 = *(a + 1) * *(b + 1);  
  
a += 2; b += 2;  
}  
s = temp1 + temp2;
```

Of course, we can unroll the operation by more than a factor of two. While we expect an increased performance because of the longer sequence of pipelined operations, large unroll factors need large numbers of registers. Asking for more registers than a CPU has is called *register spill*, and it will decrease performance.

Another thing to keep in mind is that the total number of operations is unlikely to be divisible by the unroll factor. This requires *cleanup code* after the loop to account for the final iterations. Thus, unrolled code is harder to write than straight code, and people have written tools to perform such *source-to-source transformations* automatically.

Cycle times for unrolling the inner product operation up to six times are given in table 1.2. Note that the timings do not show a monotone behaviour at the unrolling by four. This sort of variation is due to various memory-related factors.

1	2	3	4	5	6
6794	507	340	359	334	528

Table 1.2: Cycle times for the inner product operation, unrolled up to six times

### 1.6.3 Cache size

Above, you learned that data from L1 can be moved with lower latency and higher bandwidth than from L2, and L2 is again faster than L3 or memory. This is easy to demonstrate with code that repeatedly access the same data:

```
for (i=0; i<NRUNS; i++)  
  for (j=0; j<size; j++)  
    array[j] = 2.3*array[j]+1.2;
```

If the size parameter allows the array to fit in cache, the operation will be relatively fast. As the size of the dataset grows, parts of it will evict other parts from the L1 cache, so the speed of the operation will be determined by the latency and bandwidth of the L2 cache. This can be seen in figure 1.16. The full code is given in section 31.2.

**Exercise 1.16.** Argue that with a large enough problem and an LRU replacement policy (section 1.3.4.5) essentially all data in the L1 will be replaced in every iteration of the outer loop. Can you write an example code that will let some of the L1 data stay resident?

Often, it is possible to arrange the operations to keep data in L1 cache. For instance, in our example, we could write

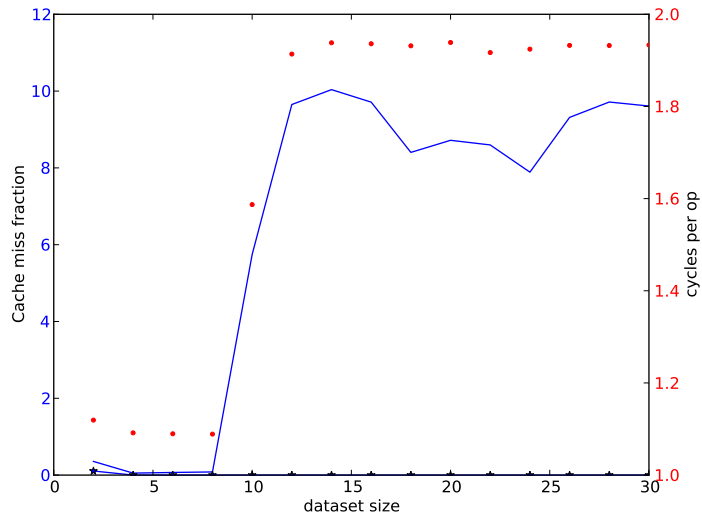

Figure 1.16: Average cycle count per operation as function of the dataset size

```

for (b=0; b<size/llsize; b++) {
  blockstart = 0;
  for (i=0; i<NRUNS; i++) {
    for (j=0; j<llsize; j++)
      array[blockstart+j] = 2.3*array[blockstart+j]+1.2;
    }
  blockstart += llsize;
}

```

assuming that the L1 size divides evenly in the dataset size. This strategy is called *cache blocking* or *blocking for cache reuse*.

**Exercise 1.17.** To arrive at the blocked code, the loop over  $j$  was split into a loop over blocks and an inner loop over the elements of the block; the outer loop over  $i$  was then exchanged with the loop over the blocks. In this particular example you could also simply exchange the  $i$  and  $j$  loops. Why may this not be optimal for performance?

#### 1.6.4 Cache lines

Since data is moved from memory to cache in consecutive chunks named cachelines (see section 1.3.4.6), code that does not utilize all data in a cacheline pays a bandwidth penalty. This is born out by a simple code

```

for (i=0, n=0; i<L1WORDS; i++, n+=stride)
  array[n] = 2.3*array[n]+1.2;

```

Here, a fixed number of operations is performed, but on elements that are at distance `stride`. As this `stride` increases, we expect an increasing runtime, which is born out by the graph in figure 1.17.

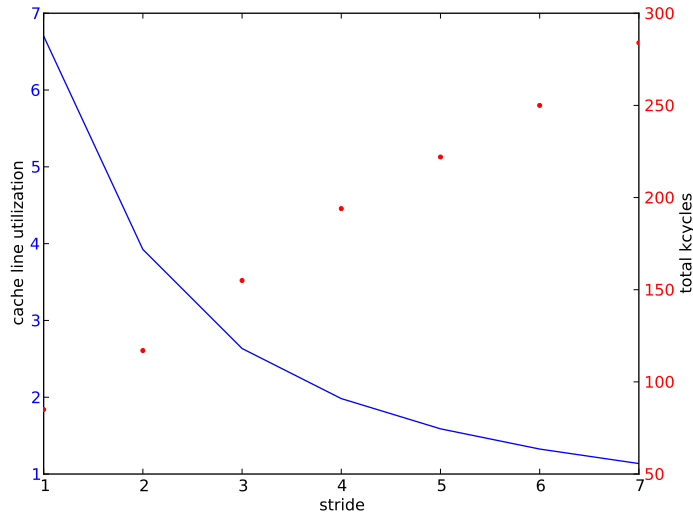

Figure 1.17: Run time in kcycles and L1 reuse as a function of stride

The graph also shows a decreasing reuse of cachelines, defined as the number of vector elements divided by the number of L1 misses (on stall; see section 1.3.5).

The full code is given in section 31.3.

### 1.6.5 TLB

As explained in section 1.3.8, the Translation Look-aside Buffer (TLB) maintains a small list of frequently used memory pages and their locations; addressing data that are location on one of these pages is much faster than data that are not. Consequently, one wants to code in such a way that the number of pages accessed is kept low.

Consider code for traversing the elements of a two-dimensional array in two different ways.

```
#define INDEX(i, j, m, n) i+j*m
array = (double*) malloc(m*n*sizeof(double));

/* traversal #1 */
for (j=0; j<n; j++)
  for (i=0; i<m; i++)
    array[INDEX(i, j, m, n)] = array[INDEX(i, j, m, n)]+1;

/* traversal #2 */
```

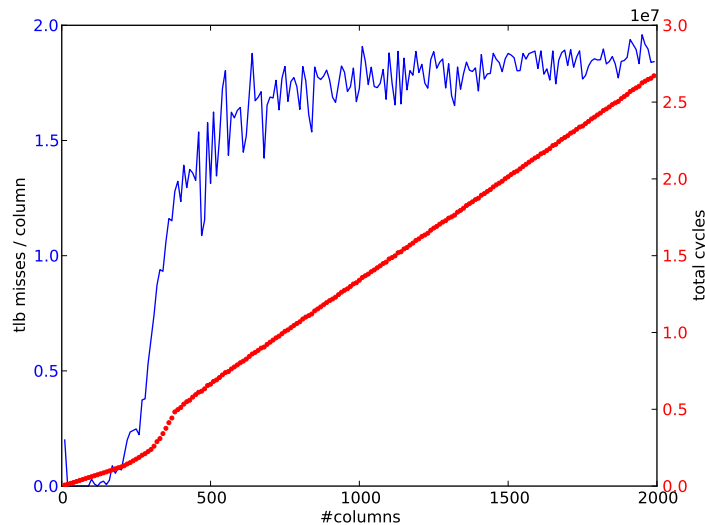

Figure 1.18: Number of TLB misses per column as function of the number of columns; columnwise traversal of the array.

```
for (i=0; i<m; i++)
  for (j=0; j<n; j++)
    array[INDEX(i, j, m, n)] = array[INDEX(i, j, m, n)]+1;
```

The results (see Appendix 31.5 for the source code) are plotted in figures 1.19 and 1.18.

Using  $m = 1000$  means that, on the *AMD Opteron* which has pages of 512 doubles, we need roughly two pages for each column. We run this example, plotting the number ‘TLB misses’, that is, the number of times a page is referenced that is not recorded in the TLB.

1. In the first traversal this is indeed what happens. After we touch an element, and the TLB records the page it is on, all other elements on that page are used subsequently, so no further TLB misses occur. Figure 1.19 shows that, with increasing  $n$ , the number of TLB misses per column is roughly two.
2. In the second traversal, we touch a new page for every element of the first row. Elements of the second row will be on these pages, so, as long as the number of columns is less than the number of TLB entries, these pages will still be recorded in the TLB. As the number of columns grows, the number of TLB increases, and ultimately there will be one TLB miss for each element access. Figure 1.18 shows that, with a large enough number of columns, the number of TLB misses per column is equal to the number of elements per column.

### 1.6.6 Cache associativity

There are many algorithms that work by recursive division of a problem, for instance the *Fast Fourier Transform (FFT)* algorithm. As a result, code for such algorithms will often operate on vectors whose

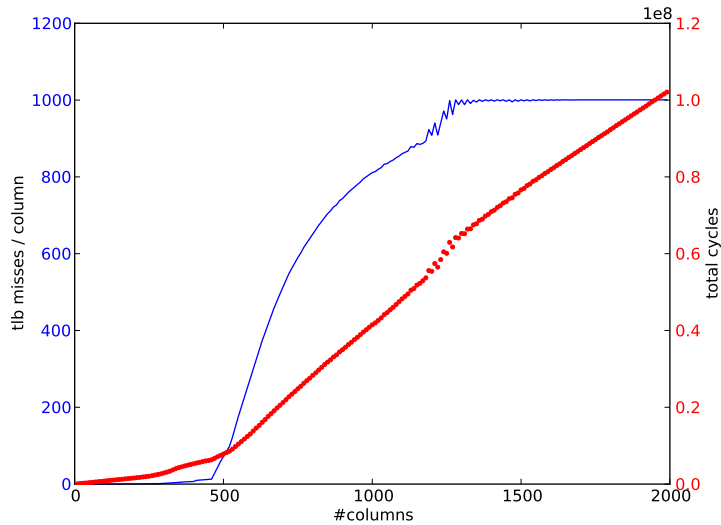

Figure 1.19: Number of TLB misses per column as function of the number of columns; rowwise traversal of the array.

length is a power of two. Unfortunately, this can cause conflicts with certain architectural features of a CPU, many of which involve powers of two.

In section 1.3.4.8 you saw how the operation of adding a small number of vectors

$$\forall_j : y_j = y_j + \sum_{i=1}^m x_{i,j}$$

is a problem for direct mapped caches or set-associative caches with associativity.

As an example we take the *AMD Opteron*, which has an L1 cache of 64K bytes, and which is two-way set associative. Because of the set associativity, the cache can handle two addresses being mapped to the same cache location, but not three or more. Thus, we let the vectors be of size  $n = 4096$  doubles, and we measure the effect in cache misses and cycles of letting  $m = 1, 2, \dots$

First of all, we note that we use the vectors sequentially, so, with a cacheline of eight doubles, we should ideally see a cache miss rate of  $1/8$  times the number of vectors  $m$ . Instead, in figure 1.20 we see a rate approximately proportional to  $m$ , meaning that indeed cache lines are evicted immediately. The exception here is the case  $m = 1$ , where the two-way associativity allows the cachelines of two vectors to stay in cache.

Compare this to figure 1.21, where we used a slightly longer vector length, so that locations with the same  $j$  are no longer mapped to the same cache location. As a result, we see a cache miss rate around  $1/8$ , and a smaller number of cycles, corresponding to a complete reuse of the cache lines.

Two remarks: the cache miss numbers are in fact lower than the theory predicts, since the processor will use prefetch streams. Secondly, in figure 1.21 we see a decreasing time with increasing  $m$ ; this is probably due

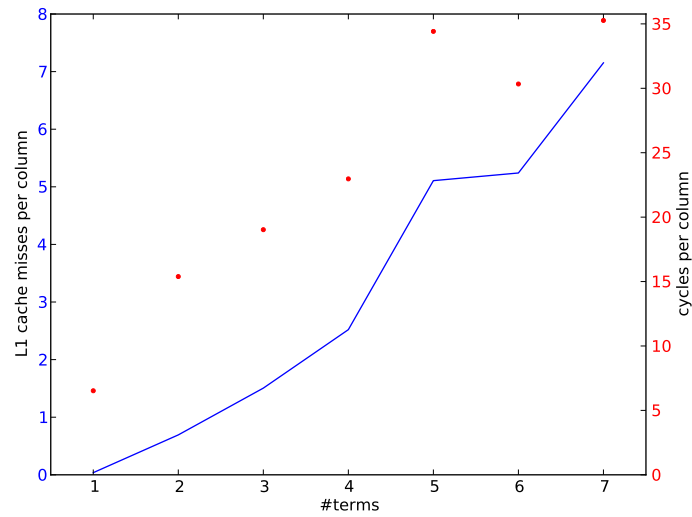

Figure 1.20: The number of L1 cache misses and the number of cycles for each  $j$  column accumulation, vector length 4096

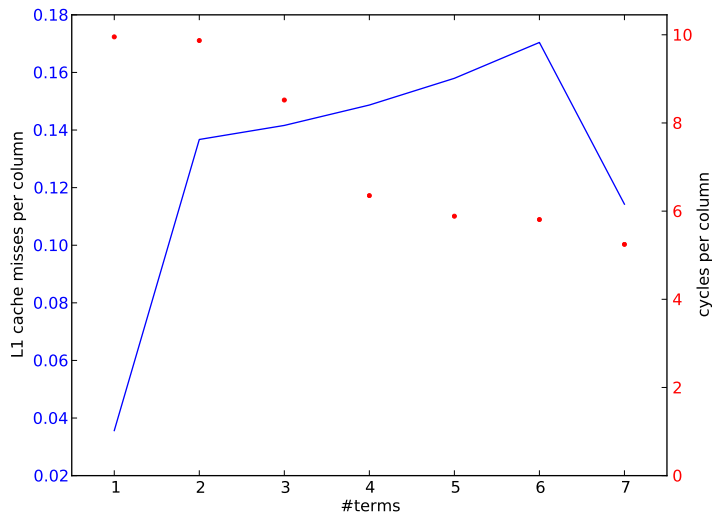

Figure 1.21: The number of L1 cache misses and the number of cycles for each  $j$  column accumulation, vector length 4096 + 8

to a progressively more favourable balance between load and store operations. Store operations are more expensive than loads, for various reasons.

### 1.6.7 Loop tiling

In some cases performance can be increased by breaking up a loop into two nested loops, an outer one for the blocks in the iteration space, and an inner one that goes through the block:

```
for (i=0; i<n; i++)
    ...
```

becomes

```
bs = ... /* the blocksize */
nblocks = n/bs /* assume that n is a multiple of bs */
for (b=0; b<nblocks; b++)
    for (i=b*bs, j=0; j<bs; i++, j++)
        ...
```

For a single loop this may not make any difference, but given the right context it may. For instance, if an array is repeatedly used, but it is too large to fit into cache:

```
for (n=0; n<10; n++)
    for (i=0; i<100000; i++)
        ... = ...x[i] ...
```

then loop tiling may lead to a situation where the array is divided into blocks that will fit in cache:

```
bs = ... /* the blocksize */
for (b=0; b<100000/bs; b++)
    for (n=0; n<10; n++)
        for (i=b*bs; i<(b+1)*bs; i++)
            ... = ...x[i] ...
```

For this reason, loop tiling is also known as *cache blocking*. The block size depends on how much data is accessed in the loop body; ideally you would try to make data reused in L1 cache, but it is also possible to block for L2 reuse. Of course, L2 reuse will not give as high a performance as L1 reuse.

**Exercise 1.18.** Analyze this example. When is  $x$  brought into cache, when is it reused, and when is it flushed? What is the required cache size in this example? Rewrite this example, using a constant

```
#define L1SIZE 65536
```

In section 1.5.2 we looked at the matrix-matrix multiplication, and concluded that little data could be kept in cache. With loop tiling we can improve this situation. For instance, the standard way of writing this product

```

for i=1..n
  for j=1..n
    for k=1..n
      c[i,j] += a[i,k]*b[k,j]

```

can only be optimized to keep  $c[i, j]$  in register:

```

for i=1..n
  for j=1..n
    s = 0
    for k=1..n
      s += a[i,k]*b[k,j]
    c[i,j] += s

```

Using loop tiling we can easily keep parts of  $a[i, :]$  in cache, assuming that  $a$  is stored by rows:

```

for kk=1..n/bs
  for i=1..n
    for j=1..n
      s = 0
      for k=(kk-1)*bs+1..kk*bs
        s += a[i,k]*b[k,j]
      c[i,j] += s

```

### 1.6.8 Optimization strategies

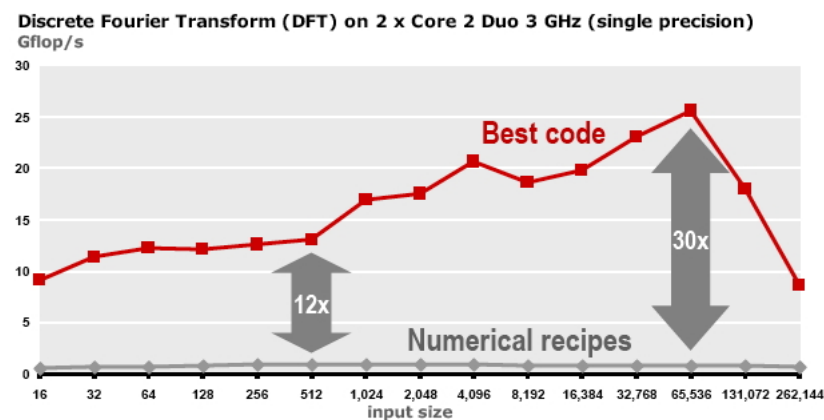

Figure 1.22: Performance of naive and optimized implementations of the Discrete Fourier Transform

Figures 1.22 and 1.23 show that there can be wide discrepancy between the performance of naive implementations of an operation (sometimes called the ‘reference implementation’), and optimized implementations. Unfortunately, optimized implementations are not simple to find. For one, since they rely on blocking, their



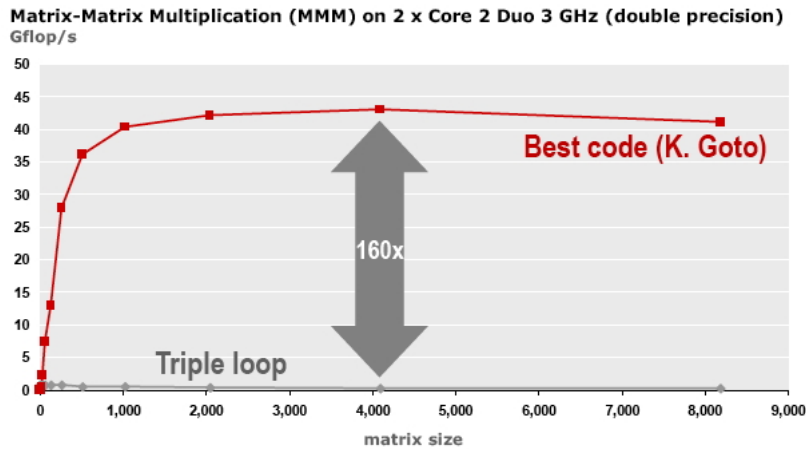

Figure 1.23: Performance of naive and optimized implementations of the matrix-matrix product

loop nests are double the normal depth: the matrix-matrix multiplication becomes a six-deep loop. Then, the optimal block size is dependent on factors like the target architecture.

We make the following observations:

- Compilers are not able to extract anywhere close to optimal performance<sup>12</sup>.
- There are *autotuning* projects for automatic generation of implementations that are tuned to the architecture. This approach can be moderately to very successful. Some of the best known of these projects are Atlas [162] for Blas kernels, and Spiral [138] for transforms.

### 1.6.9 Cache aware and cache oblivious programming

Unlike registers and main memory, both of which can be addressed in (assembly) code, use of caches is implicit. There is no way a programmer can load data explicitly to a certain cache, even in assembly language.

However, it is possible to code in a ‘cache aware’ manner. Suppose a piece of code repeatedly operates on an amount of data that less data than the cache size. We can assume that the first time the data is accessed, it is brought into cache; the next time it is accessed it will already be in cache. On the other hand, if the amount of data is more than the cache size<sup>13</sup>, it will partly or fully be flushed out of cache in the process of accessing it.

We can experimentally demonstrate this phenomenon. With a very accurate counter, the code fragment

```
for (x=0; x<NX; x++)
  for (i=0; i<N; i++)
    a[i] = sqrt(a[i]);
```

12. Presenting a compiler with the reference implementation may still lead to high performance, since some compilers are trained to recognize this operation. They will then forego translation and simply replace it by an optimized variant.

13. We are conveniently ignoring matters of set-associativity here, and basically assuming a fully associative cache.

will take time linear in  $N$  up to the point where  $a$  fills the cache. An easier way to picture this is to compute a normalized time, essentially a time per execution of the inner loop:

```
t = time();
for (x=0; x<NX; x++)
    for (i=0; i<N; i++)
        a[i] = sqrt(a[i]);
t = time()-t;
t_normalized = t/(N*NX);
```

The normalized time will be constant until the array  $a$  fills the cache, then increase and eventually level off again. (See section 1.6.3 for an elaborate discussion.)

The explanation is that, as long as  $a[0] \dots a[N-1]$  fit in L1 cache, the inner loop will use data from the L1 cache. Speed of access is then determined by the latency and bandwidth of the L1 cache. As the amount of data grows beyond the L1 cache size, some or all of the data will be flushed from the L1, and performance will be determined by the characteristics of the L2 cache. Letting the amount of data grow even further, performance will again drop to a linear behaviour determined by the bandwidth from main memory.

If you know the cache size, it is possible in cases such as above to arrange the algorithm to use the cache optimally. However, the cache size is different per processor, so this makes your code not portable, or at least its high performance is not portable. Also, blocking for multiple levels of cache is complicated. For these reasons, some people advocate *cache oblivious programming* [61].

Cache oblivious programming can be described as a way of programming that automatically uses all levels of the *cache hierarchy*. This is typically done by using a *divide-and-conquer* strategy, that is, recursive subdivision of a problem.

As a simple example of cache oblivious programming is the *matrix transposition* operation  $B \leftarrow A^t$ . First we observe that each element of either matrix is accessed once, so the only reuse is in the utilization of cache lines. If both matrices are stored by rows and we traverse  $B$  by rows, then  $A$  is traversed by columns, and for each element accessed one cacheline is loaded. If the number of rows times the number of elements per cacheline is more than the cachesize, lines will be evicted before they can be reused.

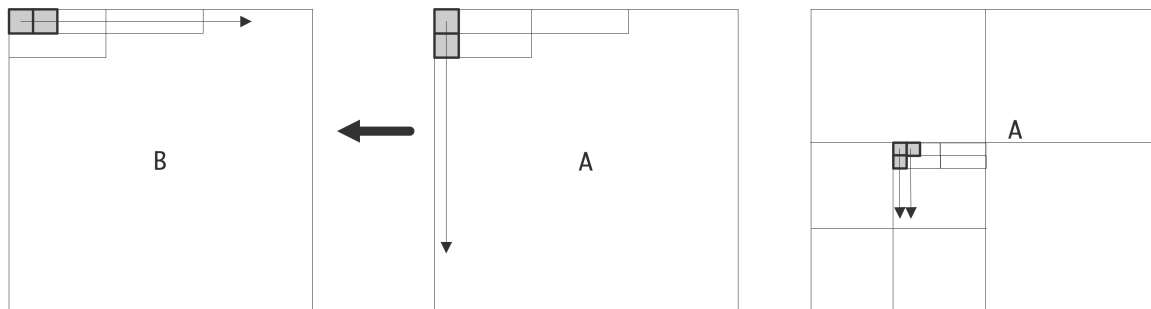

Figure 1.24: Matrix transpose operation, with simple and recursive traversal of the source matrix

In a cache oblivious implementation we divide  $A$  and  $B$  as  $2 \times 2$  block matrices, and recursively compute  $B_{11} \leftarrow A_{11}^t$ ,  $B_{12} \leftarrow A_{21}^t$ , et cetera; see figure 1.24. At some point in the recursion, blocks  $A_{ij}$  will now be small enough that they fit in cache, and the cachelines of  $A$  will be fully used. Hence, this algorithm improves on the simple one by a factor equal to the cacheline size.

The cache oblivious strategy can often yield improvement, but it is not necessarily optimal. In the matrix-matrix product it improves on the naive algorithm, but it is not as good as an algorithm that is explicitly designed to make optimal use of caches [72].

### 1.6.10 Case study: Matrix-vector product

Let us consider in some detail the *matrix-vector product*

$$\forall_{i,j}: y_i \leftarrow a_{ij} \cdot x_j$$

This involves  $2n^2$  operations on  $n^2 + 2n$  data items, so reuse is  $O(1)$ : memory accesses and operations are of the same order. However, we note that there is a double loop involved, and the  $x, y$  vectors have only a single index, so each element in them is used multiple times.

Exploiting this theoretical reuse is not trivial. In

```
/* variant 1 */
for (i)
  for (j)
    y[i] = y[i] + a[i][j] * x[j];
```

the element  $y[i]$  seems to be reused. However, the statement as given here would write  $y[i]$  to memory in every inner iteration, and we have to write the loop as

```
/* variant 2 */
for (i) {
  s = 0;
  for (j)
    s = s + a[i][j] * x[j];
  y[i] = s;
}
```

to ensure reuse. This variant uses  $2n^2$  loads and  $n$  stores.

This code fragment only exploits the reuse of  $y$  explicitly. If the cache is too small to hold the whole vector  $x$  plus a column of  $a$ , each element of  $x$  is still repeatedly loaded in every outer iteration.

Reversing the loops as

```
/* variant 3 */
for (j)
  for (i)
    y[i] = y[i] + a[i][j] * x[j];
```

exposes the reuse of  $x$ , especially if we write this as

```
/* variant 3 */
for (j) {
    t = x[j];
    for (i)
        y[i] = y[i] + a[i][j] * t;
}
```

but now  $y$  is no longer reused. Moreover, we now have  $2n^2+n$  loads, comparable to variant 2, but  $n^2$  stores, which is of a higher order.

It is possible to get reuse both of  $x$  and  $y$ , but this requires more sophisticated programming. The key here is split the loops into blocks. For instance:

```
for (i=0; i<M; i+=2) {
    s1 = s2 = 0;
    for (j) {
        s1 = s1 + a[i][j] * x[j];
        s2 = s2 + a[i+1][j] * x[j];
    }
    y[i] = s1; y[i+1] = s2;
}
```

This is also called *loop unrolling*, or *strip mining*. The amount by which you unroll loops is determined by the number of available registers.

### 1.6.11 Case study: Goto matrix-matrix product

In section 1.5.1 we already argued that the *matrix-matrix product* (or *dgemm* in Blas terms) has a large amount of possible data reuse: there are  $O(n^3)$  operations on  $O(n^2)$  data. We will now consider an implementation, due to *Kazushige Goto* [72], that indeed achieves close to peak performance.

The matrix-matrix algorithm has three loops, each of which we can block, giving a six-way nested loop. Since there are no recurrences on the output elements, all resulting loop exchanges are legal. Combine this with the fact that the loop blocking introduces three blocking parameters, and you'll see that the number of potential implementations is enormous. Here we present the global reasoning that underlies the Goto implementation; for a detailed discussion see the paper cited.

We start by writing the product  $C \leftarrow A \cdot B$  (or  $C \leftarrow C + AB$  according to the Blas standard) as a sequence of low-rank updates:

$$C_{**} = \sum_k A_{*k} B_{k*}$$

See figure 1.25. Next we derive the ‘block-panel’ multiplication by multiplying a block of  $A$  by a ‘sliver’ of  $B$ ; see figure 1.26. Finally, the inner algorithm accumulates a small row  $C_{i,*}$ , typically of small size such as 4, by accumulating:

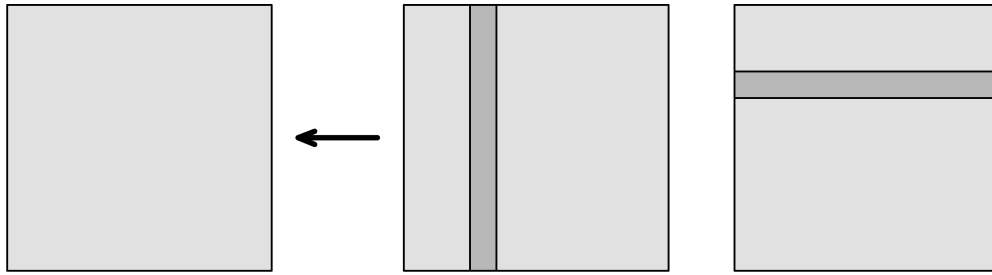

Figure 1.25: Matrix-matrix multiplication as a sequence of low-rank updates

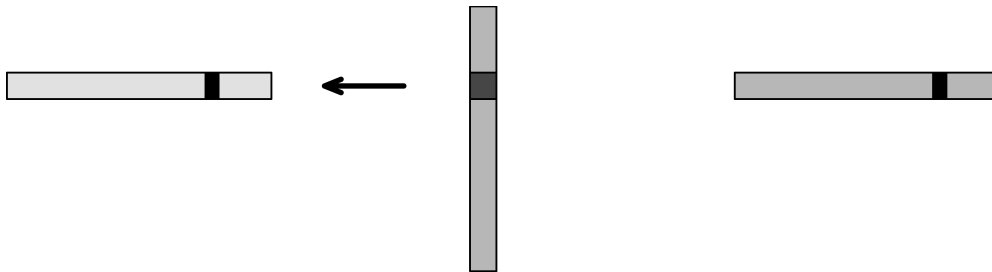

Figure 1.26: The block-panel multiplication in the matrix-matrix algorithm

```
// compute C[i, *] :
for k:
    C[i, *] = A[i, k] * B[k, *]
```

See figure 1.27. Now this algorithm is tuned.

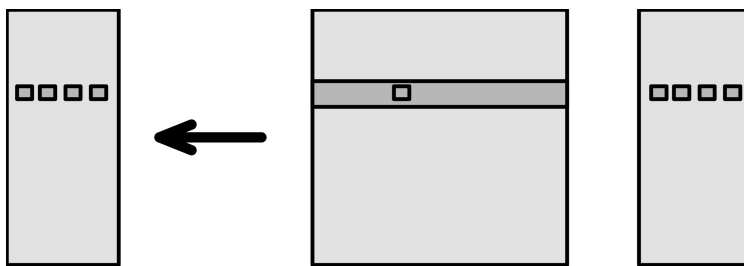

Figure 1.27: The register-resident kernel of the matrix-matrix multiply

- We need enough registers for  $C[i, *]$ ,  $A[i, k]$  and  $B[k, *]$ . On current processors that means that we accumulate four elements of  $C$ .
- Those elements of  $C$  are accumulated, so they stay in register and the only data transfer is loading of the elements of  $A$  and  $B$ ; there are no stores!
- The elements  $A[i, k]$  and  $B[k, *]$  stream from L1.
- Since the same block of  $A$  is used for many successive slivers of  $B$ , we want it to stay resident; we choose the blocksize of  $A$  to let it stay in L2 cache.

- In order to prevent TLB problems,  $A$  is stored by rows. If we start out with a matrix in (Fortran) *column-major* storage, this means we have to make a copy. Since copying is of a lower order of complexity, this cost is amortizable.

## 1.7 Power consumption

Another important topic in high performance computers is their power consumption. Here we need to distinguish between the power consumption of a single processor chip, and that of a complete cluster.

As the number of components on a chip grows, its power consumption would also grow. Fortunately, in a counter acting trend, miniaturization of the chip features has simultaneously been reducing the necessary power. Suppose that the feature size  $\lambda$  (think: thickness of wires) is scaled down to  $s\lambda$  with  $s < 1$ . In order to keep the electric field in the transistor constant, the length and width of the channel, the oxide thickness, substrate concentration density and the operating voltage are all scaled by the same factor.

### 1.7.1 Derivation of scaling properties

The properties of *constant field scaling* or *Dennard scaling* [15, 37] are an ideal-case description of the properties of a circuit as it is miniaturized. One important result is that power density stays constant as chip features get smaller, and the frequency is simultaneously increased.

The basic properties derived from circuit theory are that, if we scale feature size down by  $s$ :

Feature size	$\sim s$
Voltage	$\sim s$
Current	$\sim s$
Frequency	$\sim s$

Then we can derive that

$$\text{Power} = V \cdot I \sim s^2,$$

and because the total size of the circuit also goes down with  $s^2$ , the power density stays the same. Thus, it also becomes possible to put more transistors on a circuit, and essentially not change the cooling problem.

This result can be considered the driving force behind *Moore's law*, which states that the number of transistors in a processor doubles every 18 months.

The frequency-dependent part of the power a processor needs comes from charging and discharging the capacitance of the circuit, so

Charge	$q = CV$	(1.1)
Work	$W = qV = CV^2$	
Power	$W/\text{time} = WF = CV^2F$	

This analysis can be used to justify the introduction of multicore processors.

### 1.7.2 Multicore

At the time of this writing (circa 2010), miniaturization of components has almost come to a standstill, because further lowering of the voltage would give prohibitive leakage. Conversely, the frequency can not be scaled up since this would raise the heat production of the chip too far. Figure 1.28 gives a dramatic

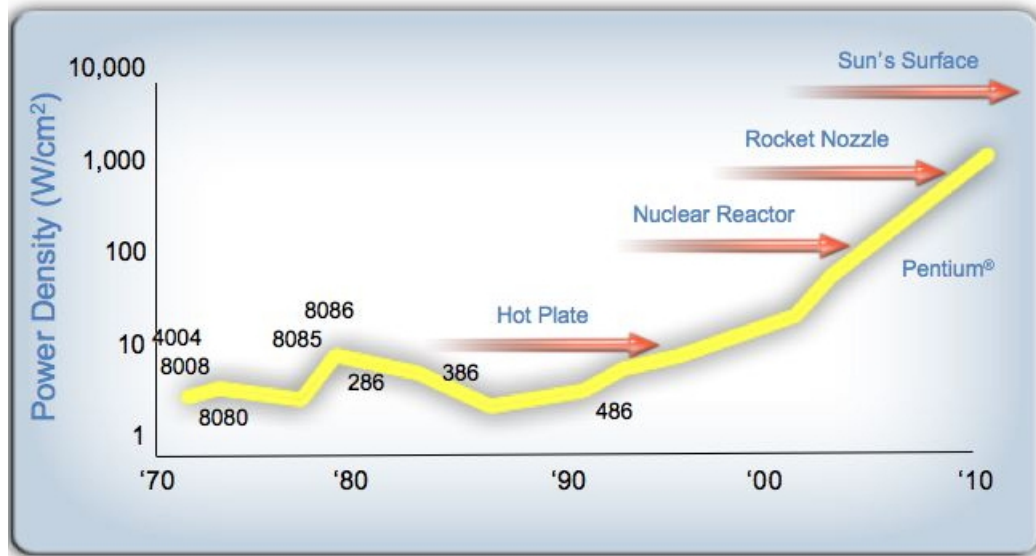

Figure 1.28: Projected heat dissipation of a CPU if trends had continued – this graph courtesy Pat Helsing illustrates the heat that a chip would give off, if single-processor trends had continued.

One conclusion is that computer design is running into a *power wall*, where the sophistication of a single core can not be increased any further (so we can for instance no longer increase *ILP* and *pipeline depth*) and the only way to increase performance is to increase the amount of explicitly visible parallelism. This development has led to the current generation of *multicore* processors; see section 1.4. It is also the reason GPUs with their simplified processor design and hence lower energy consumption are attractive; the same holds for Field-Programmable Gate Arrays (FPGAs). One solution to the power wall problem is introduction of *multicore* processors. Recall equation 1.1, and compare a single processor to two processors at half the frequency. That should have the same computing power, right? Since we lowered the frequency, we can lower the voltage if we stay with the same process technology.

The total electric power for the two processors (cores) is, ideally,

$$\left. \begin{array}{l} C_{\text{multi}} = 2C \\ F_{\text{multi}} = F/2 \\ V_{\text{multi}} = V/2 \end{array} \right\} \Rightarrow P_{\text{multi}} = P/4.$$

In practice the capacitance will go up by a little over 2, and the voltage can not quite be dropped by 2, so it is more likely that  $P_{\text{multi}} \approx 0.4 \times P$  [23]. Of course the integration aspects are a little more complicated in practice [16]; the important conclusion is that now, in order to lower the power (or, conversely, to allow further increase in performance while keeping the power constant) we now have to start programming in parallel.

### 1.7.3 Total computer power

The total power consumption of a parallel computer is determined by the consumption per processor and the number of processors in the full machine. At present, this is commonly several Megawatts. By the above reasoning, the increase in power needed from increasing the number of processors can no longer be offset by more power-effective processors, so power is becoming the overriding consideration as parallel computers move from the petascale (attained in 2008 by the *IBM Roadrunner*) to a projected exascale.

In the most recent generations of processors, power is becoming an overriding consideration, with influence in unlikely places. For instance, the Single Instruction Multiple Data (SIMD) design of processors (see section 2.4.1, in particular section 2.4.1.2) is dictated by the power cost of instruction decoding.

## 1.8 Review questions

For the true/false questions, give short explanation if you choose the ‘false’ answer.

Exercise 1.19. True or false. The code

```
for (i=0; i<N; i++)
    a[i] = b[i]+1;
```

touches every element of *a* and *b* once, so there will be a cache miss for each element.

Exercise 1.20. Give an example of a code fragment where a 3-way associative cache will have conflicts, but a 4-way cache will not.

Exercise 1.21. Consider the matrix-vector product with an  $N \times N$  matrix. What is the needed cache size to execute this operation with only compulsory cache misses? Your answer depends on how the operation is implemented: answer separately for rowwise and columnwise traversal of the matrix, where you can assume that the matrix is always stored by rows.



## Chapter 2

### Parallel Computing

The largest and most powerful computers are sometimes called ‘supercomputers’. For the last two decades, this has, without exception, referred to parallel computers: machines with more than one CPU that can be set to work on the same problem.

Parallelism is hard to define precisely, since it can appear on several levels. In the previous chapter you already saw how inside a CPU several instructions can be ‘in flight’ simultaneously. This is called *instruction-level parallelism*, and it is outside explicit user control: it derives from the compiler and the CPU deciding which instructions, out of a single instruction stream, can be processed simultaneously. At the other extreme is the sort of parallelism where more than one instruction stream is handled by multiple processors, often each on their own circuit board. This type of parallelism is typically explicitly scheduled by the user.

In this chapter, we will analyze this more explicit type of parallelism, the hardware that supports it, the programming that enables it, and the concepts that analyze it.

#### 2.1 Introduction

In scientific codes, there is often a large amount of work to be done, and it is often regular to some extent, with the same operation being performed on many data. The question is then whether this work can be sped up by use of a parallel computer. If there are  $n$  operations to be done, and they would take time  $t$  on a single processor, can they be done in time  $t/p$  on  $p$  processors?

Let us start with a very simple example. Adding two vectors of length  $n$

```
for (i=0; i<n; i++)
    a[i] = b[i] + c[i];
```

can be done with up to  $n$  processors. In the idealized case with  $n$  processors, each processor has local scalars  $a, b, c$  and executes the single instruction  $a=b+c$ . This is depicted in figure 2.1.

In the general case, where each processor executes something like

```
for (i=my_low; i<my_high; i++)
    a[i] = b[i] + c[i];
```

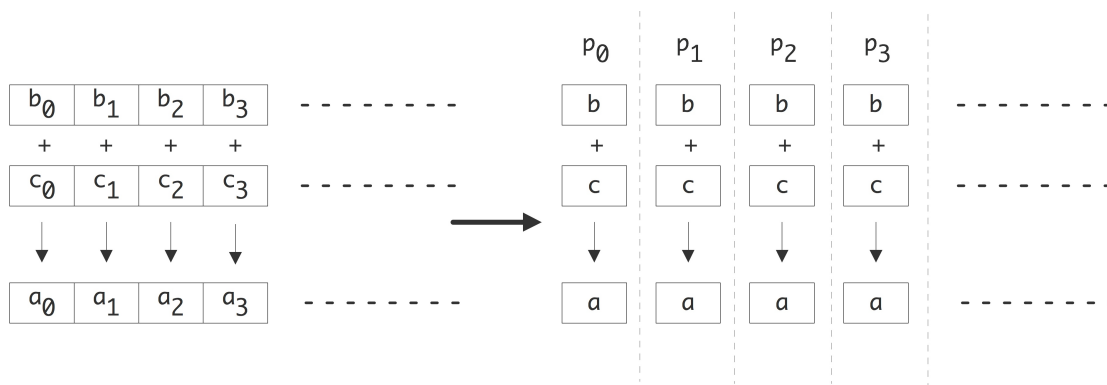

Figure 2.1: Parallelization of a vector addition

execution time is linearly reduced with the number of processors. If each operation takes a unit time, the original algorithm takes time  $n$ , and the parallel execution on  $p$  processors  $n/p$ . The parallel algorithm is faster by a factor of  $p$ <sup>1</sup>.

Next, let us consider summing the elements of a vector. We again assume that each processor contains just a single array element. The sequential code:

```
s = 0;
for (i=0; i<n; i++)
    s += x[i]
```

is no longer obviously parallel, but if we recode the loop as

```
for (s=2; s<2*n; s*=2)
    for (i=0; i<n-s/2; i+=s)
        x[i] += x[i+s/2]
```

there is a way to parallelize it: every iteration of the outer loop is now a loop that can be done by  $n/s$  processors in parallel. Since the outer loop will go through  $\log_2 n$  iterations, we see that the new algorithm has a reduced runtime of  $n/p \cdot \log_2 n$ . The parallel algorithm is now faster by a factor of  $p/\log_2 n$ . This is depicted in figure 2.2.

Even from these two simple examples we can see some of the characteristics of parallel computing:

- Sometimes algorithms need to be rewritten slightly to make them parallel.
- A parallel algorithm may not show perfect speedup.

There are other things to remark on. In the first case, if each processors has its  $x_i, y_i$  in a local store the algorithm can be executed without further complications. In the second case, processors need to *communicate* data among each other and we haven't assigned a cost to that yet.

1. We ignore lower order errors in this result when  $p$  does not divide perfectly in  $n$ . We will also, in general, ignore matters of loop overhead.

## 2. Parallel Computing

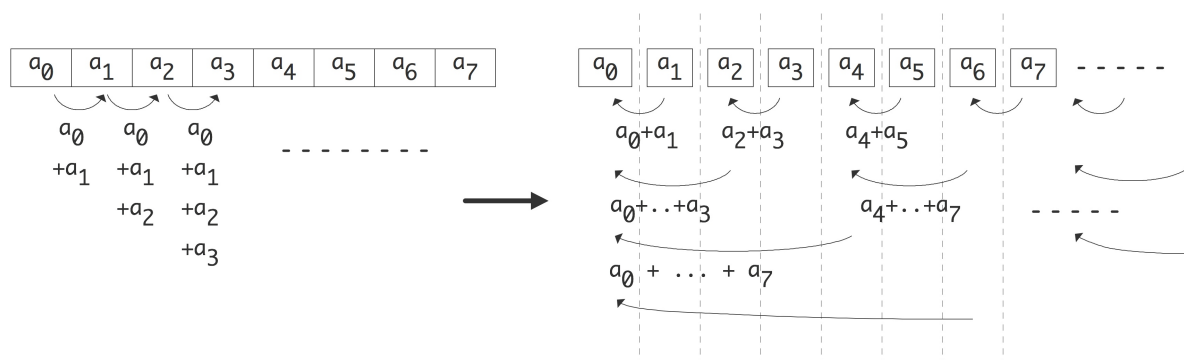

Figure 2.2: Parallelization of a vector addition

First let us look systematically at communication. We can take the parallel algorithm in the right half of figure 2.2 and turn it into a tree graph (see Appendix 16) by defining the inputs as leaf nodes, all partial sums as interior nodes, and the root as the total sum. There is an edge from one node to another if the first is input to the (partial) sum in the other. This is illustrated in figure 2.3. In this figure nodes are horizontally aligned with other computations that can be performed simultaneously; each level is sometimes called a *superstep* in the computation. Nodes are vertically aligned if they are computed on the same processors, and an arrow corresponds to a communication if it goes from one processor to another. The vertical alignment

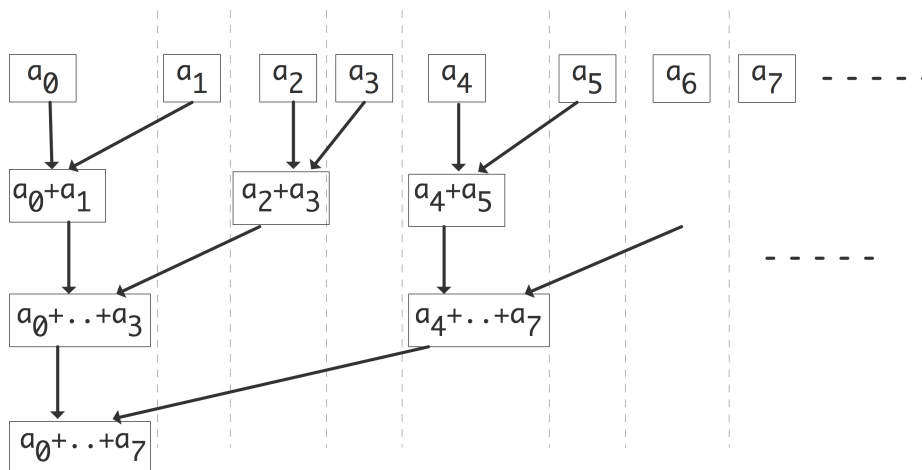

Figure 2.3: Communication structure of a parallel vector addition

in figure 2.3 is not the only one possible. If nodes are shuffled within a superstep or horizontal level, a different communication pattern arises.

**Exercise 2.1.** Consider placing the nodes within a superstep on random processors. Show that, if no two nodes wind up on the same processor, at most twice the number of communications is performed from the case in figure 2.3.

**Exercise 2.2.** Can you draw the graph of a computation that leaves the sum result on each processor? There is a solution that takes twice the number of supersteps, and there

is one that takes the same number. In both cases the graph is no longer a tree, but a more general Directed Acyclic Graph (DAG).

Processors are often connected through a network, and moving data through this network takes time. This introduces a concept of distance between the processors. This is easily seen in figure 2.3 where the processors are linearly ordered. If the network only connects a processor with its immediate neighbours, each iteration of the outer loop increases the distance over which communication takes place.

**Exercise 2.3.** Assume that an addition takes a certain unit time, and that moving a number from one processor to another takes that same unit time. Show that the communication time equals the computation time.

Now assume that sending a number from processor  $p$  to  $p \pm k$  takes time  $k$ . Show that the execution time of the parallel algorithm now is of the same order as the sequential time.

The summing example made the unrealistic assumption that every processor initially stored just one vector element: in practice we will have  $P < N$ , and every processor stores a number of vector elements. The obvious strategy is to give each processor a consecutive stretch of elements, but sometimes the obvious strategy is not the best.

**Exercise 2.4.** Consider the case of summing 8 elements with 4 processors. Show that some of the edges in the graph of figure 2.3 no longer correspond to actual communications.

Now consider summing 16 elements with, again, 4 processors. What is the number of communication edges this time?

These matters of algorithm adaptation, efficiency, and communication, are crucial to all of parallel computing. We will return to these issues in various guises throughout this chapter.

## 2.2 Functional parallelism versus data parallelism

From the above introduction we can describe parallelism as finding independent operations in the execution of a program. In all of the examples these independent operations were in fact identical operations, but applied to different data items. We could call this *data parallelism*: the same operation is applied in parallel to many data elements. This is in fact a common scenario in scientific computing: parallelism often stems from the fact that a data set (vector, matrix, graph, ...) is spread over many processors, each working on its part of the data.

The term data parallelism is traditionally mostly applied if the operation is a single instruction; in the case of a subprogram it is often called *task parallelism*.

It is also possible to find independence, not based on data elements, but based on the instructions themselves. Traditionally, compilers analyze code in terms of ILP: independent instructions can be given to separate floating point units, or reordered, for instance to optimize register usage (see also section 2.6.2). ILP is one case of *functional parallelism*; on a higher level, functional parallelism can be obtained by considering independent subprograms, often called *task parallelism*; see section 2.6.3.

Some examples of functional parallelism are Monte Carlo simulations, and other algorithms that traverse a parametrized search space, such as boolean *satisfiability* problems.

### 2.3 Quantifying parallelism

There are two important reasons for using a parallel computer: to have access to more memory or to obtain higher performance. It is easy to characterize the gain in memory, as the total memory is the sum of the individual memories. The speed of a parallel computer is harder to characterize. This section will have an extended discussion on theoretical measures for expressing and judging the gain in execution speed from going to a parallel architecture.

#### 2.3.1 Definitions

##### 2.3.1.1 *Speedup and efficiency*

A simple approach to defining speedup is to let the same program run on a single processor, and on a parallel machine with  $p$  processors, and to compare runtimes. With  $T_1$  the execution time on a single processor and  $T_p$  the time on  $p$  processors, we define the *speedup* as  $S_p = T_1/T_p$ . (Sometimes  $T_1$  is defined as ‘the best time to solve the problem on a single processor’, which allows for using a different algorithm on a single processor than in parallel.) In the ideal case,  $T_p = T_1/p$ , but in practice we don’t expect to attain that, so  $S_p \leq p$ . To measure how far we are from the ideal speedup, we introduce the *efficiency*  $E_p = S_p/p$ . Clearly,  $0 < E_p \leq 1$ .

There is a practical problem with this definition: a problem that can be solved on a parallel machine may be too large to fit on any single processor. Conversely, distributing a single processor problem over many processors may give a distorted picture since very little data will wind up on each processor. Below we will discuss more realistic measures of speed-up.

There are various reasons why the actual speed is less than  $P$ . For one, using more than one processors necessitates communication, which is overhead that was not part of the original computation. Secondly, if the processors do not have exactly the same amount of work to do, they may be idle part of the time (this is known as *load unbalance*), again lowering the actually attained speedup. Finally, code may have sections that are inherently sequential.

Communication between processors is an important source of a loss of efficiency. Clearly, a problem that can be solved without communication will be very efficient. Such problems, in effect consisting of a number of completely independent calculations, is called *embarrassingly parallel*; it will have close to a perfect speedup and efficiency.

**Exercise 2.5.** The case of speedup larger than the number of processors is called *superlinear speedup*. Give a theoretical argument why this can never happen.

In practice, superlinear speedup can happen. For instance, suppose a problem is too large to fit in memory, and a single processor can only solve it by swapping data to disc. If the same problem fits in the memory of two processors, the speedup may well be larger than 2 since disc swapping no longer occurs. Having less, or more localized, data may also improve the cache behaviour of a code.

##### 2.3.1.2 *Critical path*

The above definitions of speedup and efficiency made an implicit assumption that parallel work can be arbitrarily subdivided. As you saw in the summing example in section 2.1, this may not always be the

case: there can be dependencies between operations, which limits the amount of parallelism that can be employed.

In order to take this into account, we define the following concepts:

**Definition 1**

- $T_1$  : the time the computation takes on a single processor
- $T_p$  : the time the computation takes with  $p$  processors
- $T_\infty$  : the time the computation takes if unlimited processors are available
- $P_\infty$  : the value of  $p$  for which  $T_p = T_\infty$

With these concepts, we can define the *average parallelism* of an algorithm as  $T_1/T_\infty$ .

We will now give a few illustrations by showing a graph of tasks and their dependencies. We assume for simplicity that each node is a unit time task.

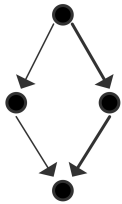

The maximum number of processors that can be used is 2 and the average parallelism is 4/3:

$$T_1 = 4, \quad T_\infty = 3 \quad \Rightarrow \quad T_1/T_\infty = 4/3$$

$$T_2 = 3, \quad S_2 = 4/3, \quad E_2 = 2/3$$

$$P_\infty = 2$$

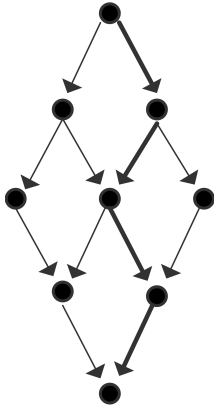

The maximum number of processors that can be used is 3 and the average parallelism is 9/5; efficiency is maximal for  $p = 2$ :

$$T_1 = 9, \quad T_\infty = 5 \quad \Rightarrow \quad T_1/T_\infty = 9/5$$

$$T_2 = 6, \quad S_2 = 3/2, \quad E_2 = 3/4$$

$$T_3 = 5, \quad S_3 = 9/5, \quad E_3 = 3/5$$

$$P_\infty = 3$$

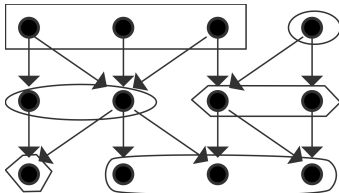

The maximum number of processors that can be used is 4 and that is also the average parallelism; the figure illustrates a parallelization with  $P = 3$  that has efficiency  $\equiv 1$ :

$$T_1 = 12, \quad T_\infty = 4 \quad \Rightarrow \quad T_1/T_\infty = 3$$

$$T_2 = 6, \quad S_2 = 2, \quad E_2 = 1$$

$$T_3 = 4, \quad S_3 = 3, \quad E_3 = 1$$

$$T_4 = 3, \quad S_4 = 4, \quad E_4 = 1$$

$$P_\infty = 4$$

Based on these examples, you probably see that there are two extreme cases:

- If every task depends on precisely on other, you get a chain of dependencies, and  $T_p = T_1$  for any  $p$ .
- On the other hand, if all tasks are independent (and  $p$  divides their number) you get  $T_p = T_1/p$  for any  $p$ .
- In a slightly less trivial scenario than the previous, consider the case where the critical path is of length  $m$ , and in each of these  $m$  steps there are  $p - 1$  independent tasks, or at least: dependent only on tasks in the previous step. There will then be perfect parallelism in each of the  $m$  steps, and we can express  $T_p = T_1/p$  or  $T_p = m + (T_1 - m)/p$ .

That last statement actually holds in general. This is known as *Brent's theorem*:

**Theorem 1** *Let  $m$  be the total number of tasks,  $p$  the number of processors, and  $t$  the length of a critical path. Then the computation can be done in*

$$T_p = t + \frac{m - t}{p}.$$

*Proof.* Divide the computation in steps, such that tasks in step  $i + 1$  are independent of each other, and only dependent on step  $i$ . Let  $s_i$  be the number of tasks in step  $i$ , then the time for that step is  $\lceil \frac{s_i}{p} \rceil$ . Summing over  $i$  gives

$$T_p = \sum_i \lceil \frac{s_i}{p} \rceil \leq \sum_i \frac{s_i + p - 1}{p} = t + \sum_i \frac{s_i - 1}{p} = t + \frac{m - t}{p}.$$

### 2.3.2 Asymptotics

If we ignore limitations such as that the number of processors has to be finite, or the physicalities of the interconnect between them, we can derive theoretical results on the limits of parallel computing. This section will give a brief introduction to such results, and discuss their connection to real life high performance computing.

Consider for instance the matrix-matrix multiplication  $C = AB$ , which takes  $2N^3$  operations where  $N$  is the matrix size. Since there are no dependencies between the operations for the elements of  $C$ , we can perform them all in parallel. If we had  $N^2$  processors, we could assign each to an  $(i, j)$  coordinate in  $C$ , and have it compute  $c_{ij}$  in  $2N$  time. Thus, this parallel operation has efficiency 1, which is optimal.

**Exercise 2.6.** Show that this algorithm ignores some serious issues about memory usage:

- If the matrix is kept in shared memory, how many simultaneous reads from each memory locations are performed?
- If the processors keep the input and output to the local computations in local storage, how much duplication is there of the matrix elements?

Adding  $N$  numbers  $\{x_i\}_{i=1\dots N}$  can be performed in  $\log_2 N$  time with  $N/2$  processors. As a simple example, consider the sum of  $n$  numbers:  $s = \sum_{i=1}^n a_i$ . If we have  $n/2$  processors we could compute:

1. Define  $s_i^{(0)} = a_i$ .
2. Iterate with  $j = 1, \dots, \log_2 n$ :

3. Compute  $n/2^j$  partial sums  $s_i^{(j)} = s_{2i}^{(j-1)} + s_{2i+1}^{(j-1)}$

We see that the  $n/2$  processors perform a total of  $n$  operations (as they should) in  $\log_2 n$  time. The efficiency of this parallel scheme is  $O(1/\log_2 n)$ , a slowly decreasing function of  $n$ .

**Exercise 2.7.** Show that, with the scheme for parallel addition just outlined, you can multiply two matrices in  $\log_2 N$  time with  $N^3/2$  processors. What is the resulting efficiency?

It is now a legitimate theoretical question to ask

- If we had infinitely many processors, what is the lowest possible time complexity for matrix-matrix multiplication, or
- Are there faster algorithms that still have  $O(1)$  efficiency?

Such questions have been researched (see for instance [82]), but they have little bearing on high performance computing.

A first objection to these kinds of theoretical bounds is that they implicitly assume some form of shared memory. In fact, the formal model for these algorithms is called a *Parallel Random Access Machine (PRAM)*, where the assumption is that every memory location is accessible to any processor. Often an additional assumption is made that multiple access to the same location are in fact possible<sup>2</sup>. These assumptions are unrealistic in practice, especially in the context of scaling up the problem size and the number of processors. A further objection to the PRAM model is that even on a single processor it ignores the memory hierarchy; section 1.3.

But even if we take distributed memory into account, theoretical results can still be unrealistic. The above summation algorithm can indeed work unchanged in distributed memory, except that we have to worry about the distance between active processors increasing as we iterate further. If the processors are connected by a linear array, the number of ‘hops’ between active processors doubles, and with that, asymptotically, the computation time of the iteration. The total execution time then becomes  $n/2$ , a disappointing result given that we throw so many processors at the problem.

What if the processors are connected with a hypercube topology? It is not hard to see that the summation algorithm can then indeed work in  $\log_2 n$  time. However, as  $n \rightarrow \infty$ , can we build a sequence of hypercubes of  $n$  nodes and keep the communication time between two connected constant? Since communication time depends on latency, which partly depends on the length of the wires, we have to worry about the physical distance between nearest neighbours.

The crucial question here is whether the hypercube (an  $n$ -dimensional object) can be embedded in 3-dimensional space, while keeping the distance (measured in meters) constant between connected neighbours. It is easy to see that a 3-dimensional grid can be scaled up arbitrarily while maintaining a unit wire length, but the question is not clear for a hypercube. There, the length of the wires may have to increase as  $n$  grows, which runs afoul of the finite speed of electrons.

We sketch a proof (see [56] for more details) that, in our three dimensional world and with a finite speed of light, speedup is limited to  $\sqrt[4]{n}$  for a problem on  $n$  processors, no matter the interconnect. The argument goes as follows. Consider an operation that involves collecting a final result on one processor. Assume that each processor takes a unit volume of space, produces one result per unit time, and can send one data

2. This notion can be made precise; for instance, one talks of a CREW-PRAM, for Concurrent Read, Exclusive Write PRAM.



item per unit time. Then, in an amount of time  $t$ , at most the processors in a ball with radius  $t$ , that is,  $O(t^3)$  processors can contribute to the final result; all others are too far away. In time  $T$ , then, the number of operations that can contribute to the final result is  $\int_0^T t^3 dt = O(T^4)$ . This means that the maximum achievable speedup is the fourth root of the sequential time.

Finally, the question ‘what if we had infinitely many processors’ is not realistic as such, but we will allow it in the sense that we will ask the *weak scaling* question (section 2.3.4) ‘what if we let the problem size and the number of processors grow proportional to each other’. This question is legitimate, since it corresponds to the very practical deliberation whether buying more processors will allow one to run larger problems, and if so, with what ‘bang for the buck’.

### 2.3.3 Amdahl’s law

One reason for less than perfect speedup is that parts of a code can be inherently sequential. This limits the parallel efficiency as follows. Suppose that 5% of a code is sequential, then the time for that part can not be reduced, no matter how many processors are available. Thus, the speedup on that code is limited to a factor of 20. This phenomenon is known as *Amdahl’s Law* [2], which we will now formulate.

Let  $F_s$  be the *sequential fraction* and  $F_p$  be the *parallel fraction* (or more strictly: the ‘parallelizable’ fraction) of a code, respectively. Then  $F_p + F_s = 1$ . The parallel execution time  $T_P$  on  $p$  processors is the sum of the part that is sequential  $T_1 F_s$  and the part that can be parallelized  $T_1 F_p / P$ :

$$T_P = T_1(F_s + F_p/P). \quad (2.1)$$

As the number of processors grows  $P \rightarrow \infty$ , the parallel execution time now approaches that of the sequential fraction of the code:  $T_P \downarrow T_1 F_s$ . We conclude that speedup is limited by  $S_P \leq 1/F_s$  and efficiency is a decreasing function  $E \sim 1/P$ .

The sequential fraction of a code can consist of things such as I/O operations. However, there are also parts of a code that in effect act as sequential. Consider a program that executes a single loop, where all iterations can be computed independently. Clearly, this code is easily parallelized. However, by splitting the loop in a number of parts, one per processor, each processor now has to deal with loop overhead: calculation of bounds, and the test for completion. This overhead is replicated as many times as there are processors. In effect, loop overhead acts as a sequential part of the code.

**Exercise 2.8.** Let’s do a specific example. Assume that a code has a setup that takes 1 second and a parallelizable section that takes 1000 seconds on one processor. What are the speedup and efficiency if the code is executed with 100 processors? What are they for 500 processors? Express your answer to at most two significant digits.

**Exercise 2.9.** Investigate the implications of Amdahl’s law: if the number of processors  $P$  increases, how does the parallel fraction of a code have to increase to maintain a fixed efficiency?

#### 2.3.3.1 Amdahl’s law with communication overhead

In a way, Amdahl’s law, sobering as it is, is even optimistic. Parallelizing a code will give a certain speedup, but it also introduces *communication overhead* that will lower the speedup attained. Let us refine our model

of equation (2.1) (see [108, p. 367]):

$$T_p = T_1(F_s + F_p/P) + T_c,$$

where  $T_c$  is a fixed communication time.

To assess the influence of this communication overhead, we assume that the code is fully parallelizable, that is,  $F_p = 1$ . We then find that

$$S_p = \frac{T_1}{T_1/p + T_c}. \quad (2.2)$$

For this to be close to  $p$ , we need  $T_c \ll T_1/p$  or  $p \ll T_1/T_c$ . In other words, the number of processors should not grow beyond the ratio of scalar execution time and communication overhead.

### 2.3.3.2 Gustafson's law

Amdahl's law was thought to show that large numbers of processors would never pay off. However, the implicit assumption in Amdahl's law is that there is a fixed computation which gets executed on more and more processors. In practice this is not the case: typically there is a way of scaling up a problem (in chapter 4 you will learn the concept of 'discretization'), and one tailors the size of the problem to the number of available processors.

A more realistic assumption would be to say that there is a sequential fraction independent of the problem size, and parallel fraction that can be arbitrarily replicated. To formalize this, instead of starting with the execution time of the sequential program, let us start with the execution time of the parallel program, and say that

$$T_p = T(F_s + F_p) \quad \text{with } F_s + F_p = 1.$$

Now we have two possible definitions of  $T_1$ . First of all, there is the  $T_1$  you get from setting  $p = 1$  in  $T_p$ . (Convince yourself that that is actually the same as  $T_p$ .) However, what we need is  $T_1$  describing the time to do all the operations of the parallel program. This is:

$$T_1 = F_s T + p \cdot F_p T.$$

This gives us a speedup of

$$S_p = \frac{T_1}{T_p} = \frac{F_s + p \cdot F_p}{F_s + F_p} = F_s + p \cdot F_p = p - (p - 1) \cdot F_s.$$

That is, speedup is now a function that decreases from  $p$ , linearly with  $p$ .

As with Amdahl's law, we can investigate the behaviour of Gustafson's law if we include communication overhead. Let's go back to equation (2.2) for a perfectly parallelizable problem, and approximate it as

$$S_p = p \left(1 - \frac{T_c}{T_1} p\right).$$

Now, under the assumption of a problem that is gradually being scaled up,  $T_c, T_1$  become functions of  $p$ . We see that if  $T_1(p) \sim pT_c(p)$ , we get linear speedup that is a constant fraction away from 1. In general we can not take this analysis further; in section 6.2.2 you'll see a detailed analysis of an example.

### 2.3.3.3 Amdahl's law and hybrid programming

Above, you learned about hybrid programming, a mix between distributed and shared memory programming. This leads to a new form of Amdahl's law.

Suppose we have  $p$  nodes with  $c$  cores each, and  $F_p$  describes the fraction of the code that uses  $c$ -way thread parallelism. We assume that the whole code is fully parallel over the  $p$  nodes. The ideal speed up would be  $pc$ , and the ideal parallel running time  $T_1/(pc)$ , but the actual running time is

$$T_{p,c} = T_1 \left( \frac{F_s}{p} + \frac{F_p}{pc} \right) = \frac{T_1}{pc} (F_s c + F_p) = \frac{T_1}{pc} (1 + F_s(c - 1)).$$

**Exercise 2.10.** Show that the speedup  $T_1/T_{p,c}$  can be approximated by  $p/F_s$ .

In the original Amdahl's law, speedup was limited by the sequential portion to a fixed number  $1/F_s$ , in hybrid programming it is limited by the task parallel portion to  $p/F_s$ .

### 2.3.4 Scalability

Above, we remarked that splitting a given problem over more and more processors does not make sense: at a certain point there is just not enough work for each processor to operate efficiently. Instead, in practice, users of a parallel code will either choose the number of processors to match the problem size, or they will solve a series of increasingly larger problems on correspondingly growing numbers of processors. In both cases it is hard to talk about speedup. Instead, the concept of *scalability* is used.

We distinguish two types of scalability. So-called *strong scalability* is in effect the same as speedup, discussed above. We say that a program shows strong scalability if, partitioned over more and more processors, it shows perfect or near perfect speedup. Typically, one encounters statements like 'this problem scales up to 500 processors', meaning that up to 500 processors the speedup will not noticeably decrease from optimal. It is not necessary for this problem to fit on a single processors: often a smaller number such as 64 processors is used as the baseline from which scalability is judged.

More interestingly, *weak scalability* is a more vaguely defined term. It describes that, as problem size and number of processors grow in such a way that the amount of data per processor stays constant, the speed in operations per second of each processor also stays constant. This measure is somewhat hard to report, since the relation between the number of operations and the amount of data can be complicated. If this relation is linear, one could state that the amount of data per processor is kept constant, and report that parallel execution time is constant as the number of processors grows.

**Exercise 2.11.** We can formulate strong scaling as a runtime that is inversely proportional to the number of processors:

$$t = c/p.$$

Show that on a log-log plot, that is, you plot the logarithm of the runtime against the logarithm of the number of processors, you will get a straight line with slope  $-1$ .

Can you suggest a way of dealing with a non-parallelizable section, that is, with a runtime  $t = c_1 + c_2/p$ ?

**Exercise 2.12.** Suppose you are investigating the weak scalability of a code. After running it for a couple of sizes and corresponding numbers of processes, you find that in each case the flop rate is roughly the same. Argue that the code is indeed weakly scalable.

**Exercise 2.13.** In the above discussion we always implicitly compared a sequential algorithm and the parallel form of that same algorithm. However, in section 2.3.1 we noted that sometimes speedup is defined as a comparison of a parallel algorithm with the **best** sequential algorithm for the same problem. With that in mind, compare a parallel sorting algorithm with runtime  $(\log n)^2$  (for instance, *bitonic sort*; section 8.1) to the best serial algorithm, which has a running time of  $n \log n$ . Show that in the weak scaling case of  $n = p$  speedup is  $p/\log p$ . Show that in the strong scaling case speedup is a descending function of  $n$ .

Although in industry parlance the term ‘scalability’ is sometimes applied to architectures or whole computer systems<sup>3</sup>, in scientific computing scalability is a property of an algorithm and the way it is parallelized on an architecture, in particular noting the way data is distributed. In section 6.2.2 you will find an analysis of the matrix-vector product operation: distributing a matrix by block rows turns out not to be scalable, but a two-dimensional distribution by submatrices is.

### 2.3.5 Simulation scaling

In most discussions of weak scaling we assume that the amount of work and the amount of storage are linearly related. This is not always the case; for instance the operation complexity of a matrix-matrix product is  $N^3$  for  $N^2$  data. If you linearly increase the number of processors, the work will go up with a higher power.

A similar effect comes into play if you simulate time-dependent PDEs<sup>4</sup>. Here, the total work is a product of the work per time step and the number of time steps. These two numbers are related; in section 4.1.2 you saw that the time step has a certain minimum size as a function of the space discretization. Thus, the number of time steps will go up as the work per time step goes up.

Rather than investigating scalability from the point of the running of an algorithm, in this section we will look at the case where the simulated time  $S$  and the running time  $T$  are constant, and we look at how this influences the amount of memory we need. This corresponds to the following real-life scenario: you have a simulation that models a certain amount of real-world time in a certain amount of running time; now you buy a bigger computer, and you wonder what size problem you can solve in the same running time and maintaining the same simulated time.

Let  $m$  be the memory per processor, and  $P$  the number of processors, giving:

$$M = Pm \quad \text{total memory.}$$

3. “A scalable computer is a computer designed from a small number of basic components, without a single bottleneck component, so that the computer can be incrementally expanded over its designed scaling range, delivering linear incremental performance for a well-defined set of scalable applications. General-purpose scalable computers provide a wide range of processing, memory size, and I/O resources. Scalability is the degree to which performance increments of a scalable computer are linear” [8].

4. This uses concepts from chapter 4.

If  $d$  is the number of space dimensions of the problem, typically 2 or 3, we get

$$\Delta x = 1/M^{1/d} \quad \text{grid spacing.}$$

For stability this limits the time step  $\Delta t$  to

$$\Delta t = \begin{cases} \Delta x = 1 / M^{1/d} & \text{hyperbolic case} \\ \Delta x^2 = 1 / M^{2/d} & \text{parabolic case} \end{cases}$$

(noting that the hyperbolic case was not discussed in chapter 4.) With a simulated time  $S$ , we find

$$k = S/\Delta t \quad \text{time steps.}$$

If we assume that the individual time steps are perfectly parallelizable, that is, we use explicit methods, or implicit methods with optimal solvers, we find a running time

$$T = kM/P = \frac{S}{\Delta t}m.$$

Setting  $T/S = C$ , we find

$$m = C\Delta t,$$

that is, the amount of memory per processor goes down as we increase the processor count. (What is the missing step in that last sentence?)

Further analyzing this result, we find

$$m = C\Delta t = c \begin{cases} 1 / M^{1/d} & \text{hyperbolic case} \\ 1 / M^{2/d} & \text{parabolic case} \end{cases}$$

Substituting  $M = Pm$ , we find ultimately

$$m = C \begin{cases} 1 / P^{1/(d+1)} & \text{hyperbolic} \\ 1 / P^{2/(d+2)} & \text{parabolic} \end{cases}$$

that is, the memory per processor that we can use goes down as a higher power of the number of processors.

### 2.3.6 Other scaling measures

Amdahl's law above was formulated in terms of the execution time on one processor. In many practical situations this is unrealistic, since the problems executed in parallel is too large for any single processor. Some formula manipulation gives us quantities that are to an extent equivalent, but that do not rely on this single-processor number [127].

For starters, applying the definition  $S_p(n) = \frac{T_1(n)}{T_p(n)}$  to strong scaling, we observe that  $T_1(n)/n$  is the sequential time per operation, and its inverse  $n/T_1(n)$  can be called the sequential *computational rate*, denoted  $R_1(n)$ . Similarly defining a 'parallel computational rate'

$$R_p(n) = n/T_p(n) \tag{2.3}$$

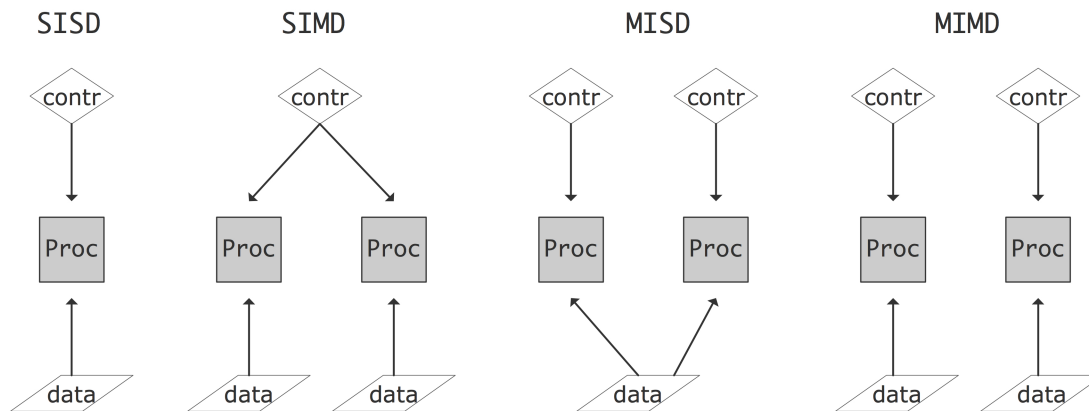

Figure 2.4: The four classes of the Flynn's taxonomy

we find that

$$S_p(n) = R_p(n)/R_1(n)$$

In strong scaling  $R_1(n)$  will be a constant, so we make a logarithmic plot of speedup, purely based on measuring  $T_p(n)$ .

## 2.4 Parallel Computers Architectures

For quite a while now, the top computers have been some sort of parallel computer, that is, an architecture that allows the simultaneous execution of multiple instructions or instruction sequences. One way of characterizing the various forms this can take is due to Flynn [57]. *Flynn's taxonomy* characterizes architectures by whether the *data flow* and *control flow* are shared or independent. The following four types result (see also figure 2.4):

**SISD** Single Instruction Single Data: this is the traditional CPU architecture: at any one time only a single instruction is executed, operating on a single data item.

**SIMD** Single Instruction Multiple Data: in this computer type there can be multiple processors, each operating on its own data item, but they are all executing the same instruction on that data item. Vector computers (section 2.4.1.1) are typically also characterized as SIMD.

**MISD** Multiple Instruction Single Data. No architectures answering to this description exist; one could argue that redundant computations for safety-critical applications are an example of MISD.

**MIMD** Multiple Instruction Multiple Data: here multiple CPUs operate on multiple data items, each executing independent instructions. Most current parallel computers are of this type.

We will now discuss SIMD and MIMD architectures in more detail.

### 2.4.1 SIMD

Parallel computers of the SIMD type apply the same operation simultaneously to a number of data items. The design of the CPUs of such a computer can be quite simple, since the arithmetic unit does not need

## 2. Parallel Computing

separate logic and instruction decoding units: all CPUs execute the same operation in lock step. This makes SIMD computers excel at operations on arrays, such as

```
for (i=0; i<N; i++) a[i] = b[i]+c[i];
```

and, for this reason, they are also often called *array processors*. Scientific codes can often be written so that a large fraction of the time is spent in array operations.

On the other hand, there are operations that can not be executed efficiently on an array processor. For instance, evaluating a number of terms of a recurrence  $x_{i+1} = ax_i + b_i$  involves that many additions and multiplications, but they alternate, so only one operation of each type can be processed at any one time. There are no arrays of numbers here that are simultaneously the input of an addition or multiplication.

In order to allow for different instruction streams on different parts of the data, the processor would have a ‘mask bit’ that could be set to prevent execution of instructions. In code, this typically looks like

```
where (x>0) {  
    x[i] = sqrt(x[i])  
}
```

The programming model where identical operations are applied to a number of data items simultaneously, is known as *data parallelism*.

Such array operations can occur in the context of physics simulations, but another important source is graphics applications. For this application, the processors in an array processor can be much weaker than the processor in a PC: often they are in fact bit processors, capable of operating on only a single bit at a time. Along these lines, ICL had the 4096 processor DAP [92] in the 1980s, and Goodyear built a 16K processor MPP [7] in the 1970s.

Later, the *Connection Machine* (CM-1, CM-2, CM-5) were quite popular. While the first Connection Machine had bit processors (16 to a chip), the later models had traditional processors capable of floating point arithmetic, and were not true SIMD architectures. All were based on a hyper-cube interconnection network; see section 2.8.5. Another manufacturer that had a commercially successful array processor was *MasPar*; figure 2.5 illustrates the architecture. You clearly see the single control unit for a square array of processors, plus a network for doing global operations.

Supercomputers based on array processing do not exist anymore, but the notion of SIMD lives on in various guises. For instance, GPUs are SIMD-based, enforced through their *CUDA* programming language. Also, the *Intel Xeon Phi* has a strong SIMD component. While early SIMD architectures were motivated by minimizing the number of transistors necessary, these modern co-processors are motivated by power efficiency considerations. Processing instructions (known as *instruction*

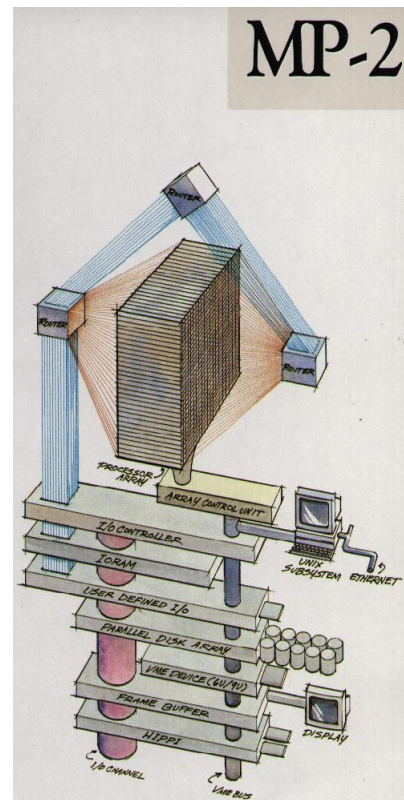

*issue*) is actually expensive compared to a floating point operation, in time, energy, and chip real estate needed. Using SIMD is then a way to economize on the last two measures.

#### 2.4.1.1 Pipelining

A number of computers have been based on a *vector processor* or *pipeline processor* design. The first commercially successful supercomputers, the Cray-1 and the Cyber-205 were of this type. In recent times, the Cray-X1 and the NEC SX series have featured vector pipes. The ‘Earth Simulator’ computer [143], which led the TOP500 (section 2.11.5) for 3 years, was based on NEC SX processors. The general idea behind pipelining was described in section 1.2.1.3.

While supercomputers based on pipeline processors are in a distinct minority, pipelining is now mainstream in the superscalar CPUs that are the basis for *clusters*. A typical CPU has pipelined floating point units, often with separate units for addition and multiplication; see section 1.2.1.3.

However, there are some important differences between pipelining in a modern superscalar CPU and in, more old-fashioned, vector units. The pipeline units in these vector computers are not integrated floating point units in the CPU, but can better be considered as attached vector units to a CPU that itself has a floating point unit. The vector unit has *vector registers*<sup>5</sup> with a typical length of 64 floating point numbers; there is typically no ‘vector cache’. The logic in vector units is also simpler, often addressable by explicit vector instructions. Superscalar CPUs, on the other hand, are fully integrated in the CPU and geared towards exploiting data streams in unstructured code.

#### 2.4.1.2 True SIMD in CPUs and GPUs

True SIMD array processing can be found in modern CPUs and GPUs, in both cases inspired by the parallelism that is needed in graphics applications.

Modern CPUs from Intel and AMD, as well as PowerPC chips, have *vector instructions* that can perform multiple instances of an operation simultaneously. On Intel processors this is known as *SIMD Streaming Extensions (SSE)* or *Advanced Vector Extensions (AVX)*. These extensions were originally intended for graphics processing, where often the same operation needs to be performed on a large number of pixels. Often, the data has to be a total of, say, 128 bits, and this can be divided into two 64-bit reals, four 32-bit reals, or a larger number of even smaller chunks such as 4 bits.

The AVX instructions are based on up to 512-bit wide SIMD, that is, eight floating point numbers can be processed simultaneously. Just as single floating point operations operate on data in registers (section 1.3.3), vector operations use *vector registers*. The locations in a vector register are sometimes referred to as *SIMD lanes*.

The use of SIMD is mostly motivated by power considerations. Decoding instructions is actually more power consuming than executing them, so SIMD parallelism is a way to save power.

Current compilers can generate SSE or AVX instructions automatically; sometimes it is also possible for the user to insert pragmas, for instance with the Intel compiler:

5. The Cyber205 was an exception, with direct-to-memory architecture.



```
void func(float *restrict c, float *restrict a,
         float *restrict b, int n)
{
    #pragma vector always
    for (int i=0; i<n; i++)
        c[i] = a[i] * b[i];
}
```

Use of these extensions often requires data to be aligned with cache line boundaries (section 1.3.4.6), so there are special `allocate` and `free` calls that return aligned memory.

Version 4 of *OpenMP* also has directives for indicating SIMD parallelism.

Array processing on a larger scale can be found in *GPUs*. A GPU contains a large number of simple processors, ordered in groups of 32, typically. Each processor group is limited to executing the same instruction. Thus, this is true example of SIMD processing. For further discussion, see section 2.10.3.

### 2.4.2 MIMD / SPMD computers

By far the most common parallel computer architecture these days is called Multiple Instruction Multiple Data (MIMD): the processors execute multiple, possibly differing instructions, each on their own data. Saying that the instructions differ does not mean that the processors actually run different programs: most of these machines operate in *Single Program Multiple Data (SPMD)* mode, where the programmer starts up the same executable on the parallel processors. Since the different instances of the executable can take differing paths through conditional statements, or execute differing numbers of iterations of loops, they will in general not be completely in sync as they were on SIMD machines. If this lack of synchronization is due to processors working on different amounts of data, it is called *load unbalance*, and it is a major source of less than perfect *speedup*; see section 2.11.1.

There is a great variety in MIMD computers. Some of the aspects concern the way memory is organized, and the network that connects the processors. Apart from these hardware aspects, there are also differing ways of programming these machines. We will see all these aspects below. Many machines these days are called *clusters*. They can be built out of custom or commodity processors (if they consist of PCs, running Linux, and connected with Ethernet, they are referred to as *Beowulf clusters* [77]); since the processors are independent they are examples of the MIMD or SPMD model.

### 2.4.3 The commoditization of supercomputers

In the 1980s and 1990s supercomputers were radically different from personal computer and mini or super-mini computers such as the DEC PDP and VAX series. The SIMD vector computers had one (*CDC Cyber205* or *Cray-1*), or at most a few (*ETA-10*, *Cray-2*, *Cray X/MP*, *Cray Y/MP*), extremely powerful processors, often a vector processor. Around the mid-1990s clusters with thousands of simpler (micro) processors started taking over from the machines with relative small numbers of vector pipes (see <http://www.top500.org/lists/1994/11>). At first these microprocessors (*IBM Power series*, *Intel i860*, *MIPS*, *DEC Alpha*) were still much more powerful than ‘home computer’ processors, but later

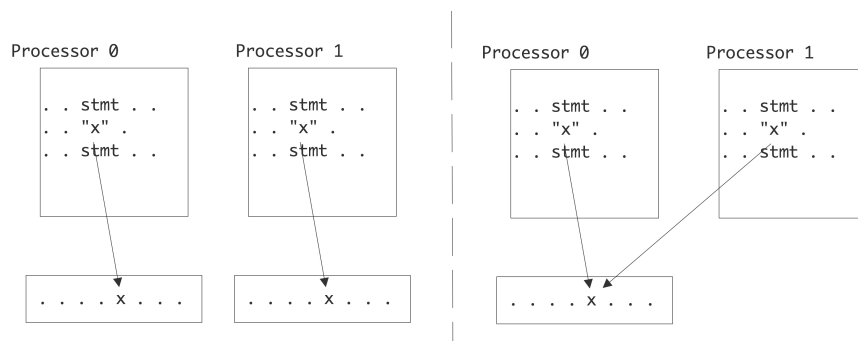

Figure 2.6: References to identically named variables in the distributed and shared memory case

this distinction also faded to an extent. Currently, many of the most powerful clusters are powered by essentially the same Intel Xeon and AMD Opteron chips that are available on the consumer market. Others use IBM Power Series or other ‘server’ chips. See section 2.11.5 for illustrations of this history since 1993.

## 2.5 Different types of memory access

In the introduction we defined a parallel computer as a setup where multiple processors work together on the same problem. In all but the simplest cases this means that these processors need access to a joint pool of data. In the previous chapter you saw how, even on a single processor, memory can have a hard time keeping up with processor demands. For parallel machines, where potentially several processors want to access the same memory location, this problem becomes even worse. We can characterize parallel machines by the approach they take to the problem of reconciling multiple accesses, by multiple processes, to a joint pool of data.

The main distinction here is between *distributed memory* and *shared memory*. With distributed memory, each processor has its own physical memory, and more importantly its own *address space*. Thus, if two processors refer to a variable  $x$ , they access a variable in their own local memory. On the other hand, with shared memory, all processors access the same memory; we also say that they have a *shared address space*. Thus, if two processors both refer to a variable  $x$ , they access the same memory location.

### 2.5.1 Symmetric Multi-Processors: Uniform Memory Access

Parallel programming is fairly simple if any processor can access any memory location. For this reason, there is a strong incentive for manufacturers to make architectures where processors see no difference between one memory location and another: any memory location is accessible to every processor, and the access times do not differ. This is called *Uniform Memory Access (UMA)*, and the programming model for architectures on this principle is often called *Symmetric Multi Processing (SMP)*.

There are a few ways to realize an SMP architecture. Current desktop computers can have a few processors accessing a shared memory through a single memory bus; for instance Apple markets a model with 2 six-core processors. Having a memory bus that is shared between processors works only for small numbers of

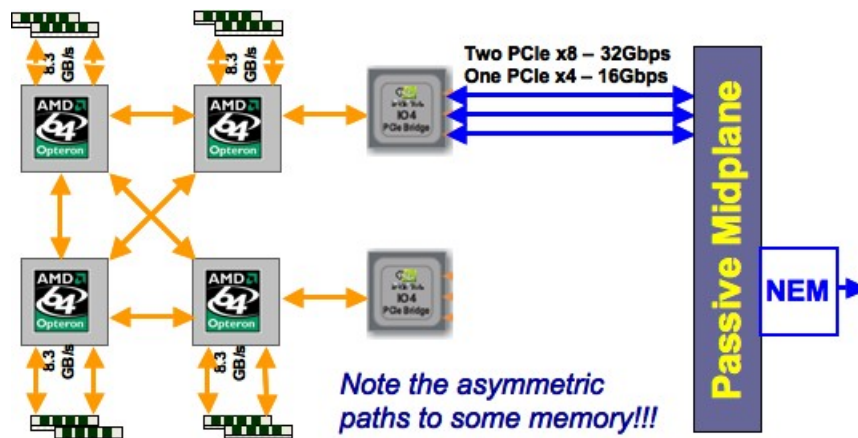

Figure 2.7: Non-uniform memory access in a four-socket motherboard

processors; for larger numbers one can use a *crossbar* that connects multiple processors to multiple memory banks; see section 2.8.6.

On *multicore* processors there is uniform memory access of a different type: the cores typically have a *shared cache*, typically the L3 or L2 cache.

### 2.5.2 Non-Uniform Memory Access

The UMA approach based on shared memory is obviously limited to a small number of processors. The crossbar networks are expandable, so they would seem the best choice. However, in practice one puts processors with a local memory in a configuration with an exchange network. This leads to a situation where a processor can access its own memory fast, and other processors' memory slower. This is one case of so-called *Non-Uniform Memory Access (NUMA)*: a strategy that uses physically distributed memory, abandoning the uniform access time, but maintaining the logically shared address space: each processor can still access any memory location.

Figure 2.7 illustrates NUMA in the case of the four-socket motherboard of the Ranger supercomputer. Each chip has its own memory (8Gb) but the motherboard acts as if the processors have access to a shared pool of 32Gb. Obviously, accessing the memory of another processor is slower than accessing local memory. In addition, note that each processor has three connections that could be used to access other memory, but the rightmost two chips use one connection to connect to the network. This means that accessing each other's memory can only happen through an intermediate processor, slowing down the transfer, and tying up that processor's connections.

While the NUMA approach is convenient for the programmer, it offers some challenges for the system. Imagine that two different processors each have a copy of a memory location in their local (cache) memory. If one processor alters the content of this location, this change has to be propagated to the other processors. If both processors try to alter the content of the one memory location, the behaviour of the program can become undetermined.

Keeping copies of a memory location synchronized is known as *cache coherence* (see section 1.4.1 for further details); a multi-processor system using it is sometimes called a ‘cache-coherent NUMA’ or *ccNUMA* architecture.

Taking NUMA to its extreme, it is possible to have a software layer that makes network-connected processors appear to operate on shared memory. This is known as *distributed shared memory* or *virtual shared memory*. In this approach a *hypervisor* offers a shared memory API, by translating system calls to distributed memory management. This shared memory API can be utilized by the *Linux kernel*, which can support 4096 threads.

Among current vendors only SGI (the *UV* line) and Cray (the *XE6*) market products with large scale NUMA. Both offer strong support for *Partitioned Global Address Space (PGAS)* languages; see section 2.7.5. There are vendors, such as *ScaleMP*, that offer a software solution to distributed shared memory on regular clusters.

### 2.5.3 Logically and physically distributed memory

The most extreme solution to the memory access problem is to offer memory that is not just physically, but that is also logically distributed: the processors have their own address space, and can not directly see another processor’s memory. This approach is often called ‘distributed memory’, but this term is unfortunate, since we really have to consider the questions separately whether memory *is* distributed and whether it *appears* distributed. Note that NUMA also has physically distributed memory; the distributed nature of it is just not apparent to the programmer.

With logically *and* physically distributed memory, the only way one processor can exchange information with another is through passing information explicitly through the network. You will see more about this in section 2.7.3.3.

This type of architecture has the significant advantage that it can scale up to large numbers of processors: the *IBM BlueGene* has been built with over 200,000 processors. On the other hand, this is also the hardest kind of parallel system to program.

Various kinds of hybrids between the above types exist. In fact, most modern clusters will have NUMA nodes, but a distributed memory network between nodes.

## 2.6 Granularity of parallelism

Let us take a look at the question ‘how much parallelism is there in a program execution’. There is the theoretical question of the absolutely maximum number of actions that can be taken in parallel, but we also need to wonder what kind of actions these are and how hard it is to actually execute them in parallel, as well as how efficient the resulting execution is.

The discussion in this section will be mostly on a conceptual level; in section 2.7 we will go into some detail on how parallelism can actually be programmed.

### 2.6.1 Data parallelism

It is fairly common for a program that have loops with a simple body, that gets executed for all elements in a large data set:

```
for (i=0; i<1000000; i++)
    a[i] = 2*b[i];
```

Such code is considered an instance of *data parallelism* or *fine-grained parallelism*. If you had as many processors as array elements, this code would look very simple: each processor would execute the statement

```
a = 2*b
```

on its local data.

If your code consists predominantly of such loops over arrays, it can be executed efficiently with all processors in lockstep. Architectures based on this idea, where the processors can in fact *only* work in lockstep, have existed, see section 2.4.1. Such fully parallel operations on arrays appear in computer graphics, where every pixel of an image is processed independently. For this reason, GPUs (section 2.10.3) are strongly based on data parallelism.

Continuing the above example for a little bit, consider the operation

```
for  $0 \leq i < \text{max}$  do
     $i_{\text{left}} = \text{mod}(i - 1, \text{max})$ 
     $i_{\text{right}} = \text{mod}(i + 1, \text{max})$ 
     $a_i = (b_{i_{\text{left}}} + b_{i_{\text{right}}})/2$ 
```

On a data parallel machine, that could be implemented as

```
bleft ← shiftright(b)
bright ← shiftright(b)
a ← (bleft + bright)/2
```

where the `shiftright/left` instructions cause a data item to be sent to the processor with a number lower or higher by 1. For this second example to be efficient, it is necessary that each processor can communicate quickly with its immediate neighbours, and the first and last processor with each other.

In various contexts such a ‘blur’ operations in graphics, it makes sense to have operations on 2D data:

```
for  $0 < i < m$  do
    for  $0 < j < n$  do
         $a_{ij} \leftarrow (b_{ij-1} + b_{ij+1} + b_{i-1j} + b_{i+1j})$ 
```

and consequently processors have be able to move data to neighbours in a 2D grid.

### 2.6.2 Instruction-level parallelism

In *ILP*, the parallelism is still on the level of individual instructions, but these need not be similar. For instance, in

$$\begin{aligned} a &\leftarrow b + c \\ d &\leftarrow e * f \end{aligned}$$

the two assignments are independent, and can therefore be executed simultaneously. This kind of parallelism is too cumbersome for humans to identify, but compilers are very good at this. In fact, identifying ILP is crucial for getting good performance out of modern *superscalar* CPUs.

### 2.6.3 Task-level parallelism

At the other extreme from data and instruction-level parallelism, *task parallelism* is about identifying whole subprograms that can be executed in parallel. As an example, searching in a tree data structure could be implemented as follows:

```

if optimal (root) then
  exit
else
  parallel: SearchInTree (leftchild), SearchInTree (rightchild)
  Procedure SearchInTree(root)

```

The search tasks in this example are not synchronized, and the number of tasks is not fixed: it can grow arbitrarily. In practice, having too many tasks is not a good idea, since processors are most efficient if they work on just a single task. Tasks can then be scheduled as follows:

```

while there are tasks left do
  wait until a processor becomes inactive;
  spawn a new task on it

```

(There is a subtle distinction between the two previous pseudo-codes. In the first, tasks were self-scheduling: each task spawned off two new ones. The second code is an example of the *master-worker paradigm*: there is one central task which lives for the duration of the code, and which spawns and assigns the worker tasks.)

Unlike in the data parallel example above, the assignment of data to processor is not determined in advance in such a scheme. Therefore, this mode of parallelism is most suited for thread-programming, for instance through the OpenMP library; section 2.7.2.

Let us consider a more serious example of task-level parallelism.

A finite element mesh is, in the simplest case, a collection of triangles that covers a 2D object. Since angles that are too acute should be avoided, the *Delauney mesh refinement* process can take certain triangles, and replace them by better shaped ones. This is illustrated in figure 2.8: the black triangles violate some angle condition, so either they themselves get subdivided, or they are joined with some neighbouring ones (rendered in grey) and then jointly redivided.

In pseudo-code, this can be implemented as in figure 2.9. (This figure and code are to be found in [103],

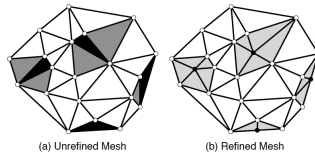

Figure 2.8: A mesh before and after refinement

```
Mesh m = /* read in initial mesh */
WorkList wl;
wl.add(mesh.badTriangles());
while (wl.size() != 0) do
  Element e = wl.get(); //get bad triangle
  if (e no longer in mesh) continue;
  Cavity c = new Cavity(e);
  c.expand();
  c.retriangulate();
  mesh.update(c);
  wl.add(c.badTriangles());
```

Figure 2.9: Task queue implementation of Delauney refinement

which also contains a more detailed discussion.)

It is clear that this algorithm is driven by a worklist (or *task queue*) data structure that has to be shared between all processes. Together with the dynamic assignment of data to processes, this implies that this type of *irregular parallelism* is suited to shared memory programming, and is much harder to do with distributed memory.

### 2.6.4 Conveniently parallel computing

In certain contexts, a simple, often single processor, calculation needs to be performed on many different inputs. Since the computations have no data dependencies and need not be done in any particular sequence, this is often called *embarrassingly parallel* or *conveniently parallel* computing. This sort of parallelism can happen at several levels. In examples such as calculation of the *Mandelbrot set* or evaluating moves in a *chess* game, a subroutine-level computation is invoked for many parameter values. On a coarser level it can be the case that a simple program needs to be run for many inputs. In this case, the overall calculation is referred to as a *parameter sweep*.

### 2.6.5 Medium-grain data parallelism

The above strict realization of data parallelism assumes that there are as many processors as data elements. In practice, processors will have much more memory than that, and the number of data elements is likely to be far larger than the processor count of even the largest computers. Therefore, arrays are grouped onto processors in subarrays. The code then looks like this:

```

my_lower_bound = // some processor-dependent number
my_upper_bound = // some processor-dependent number
for (i=my_lower_bound; i<my_upper_bound; i++)
    // the loop body goes here

```

This model has some characteristics of data parallelism, since the operation performed is identical on a large number of data items. It can also be viewed as task parallelism, since each processor executes a larger section of code, and does not necessarily operate on equal sized chunks of data.

### 2.6.6 Task granularity

In the previous subsections we considered different level of finding parallel work, or different ways of dividing up work so as to find parallelism. There is another way of looking at this: we define the *granularity* of a parallel scheme as the amount of work (or the task size) that a processing element can perform before having to communicate or synchronize with other processing elements.

In ILP we are dealing with very fine-grained parallelism, on the order of a single instruction or just a few instructions. In true task parallelism the granularity is much coarser.

The interesting case here is data parallelism, where we have the freedom to choose the task sizes. On SIMD machines we can choose a granularity of a single instruction, but, as you saw in section 2.6.5, operations can be grouped into medium-sized tasks. Thus, operations that are data parallel can be executed on distributed memory clusters, given the right balance between the number of processors and total problem size.

**Exercise 2.14.** Discuss choosing the right granularity for a data parallel operation such as averaging on a two-dimensional grid. Show that there is a *surface-to-volume* effect: the amount of communication is of a lower order than the computation. This means that, even if communication is much slower than computation, increasing the task size will still give a balanced execution.

Unfortunately, choosing a large task size to overcome slow communication may aggravate another problem: aggregating these operations may give tasks with varying running time, causing *load unbalance*. One solution here is to use an *overdecomposition* of the problem: create more tasks than there are processing elements, and assign multiple tasks to a processor (or assign tasks dynamically) to even out irregular running times. This is known as *dynamic scheduling*, and the examples in section 2.6.3 illustrate this; see also section 2.7.2.1. An example of *overdecomposition* in linear algebra is discussed in section 6.3.2.

## 2.7 Parallel programming

Parallel programming is more complicated than sequential programming. While for sequential programming most programming languages operate on similar principles (some exceptions such as functional or logic languages aside), there is a variety of ways of tackling parallelism. Let's explore some of the concepts and practical aspects.

There are various approaches to parallel programming. First of all, there does not seem to be any hope of a *parallelizing compiler* that can automagically transform a sequential program into a parallel one. Apart



from the problem of figuring out which operations are independent, the main problem is that the problem of locating data in a parallel context is very hard. A compiler would need to consider the whole code, rather than a subroutine at a time. Even then, results have been disappointing.

More productive is the approach where the user writes mostly a sequential program, but gives some indications about what computations can be parallelized, and how data should be distributed. Indicating parallelism of operations explicitly is done in OpenMP (section 2.7.2); indicating the data distribution and leaving parallelism to the compiler and runtime is the basis for PGAS languages (section 2.7.5). Such approaches work best with shared memory.

By far the hardest way to program in parallel, but with the best results in practice, is to expose the parallelism to the programmer and let the programmer manage everything explicitly. This approach is necessary in the case of distributed memory programming. We will have a general discussion of distributed programming in section 2.7.3.1; section 2.7.3.3 will discuss the MPI library.

### 2.7.1 Thread parallelism

As a preliminary to OpenMP (section 2.7.2), we will briefly go into ‘threads’.

To explain what a *thread* is, we first need to get technical about what a *process* is. A unix process corresponds to the execution of a single program. Thus, it has in memory:

- The program code, in the form of machine language instructions;
- A *heap*, containing for instance arrays that were created with *malloc*;
- A stack with quick-changing information, such as the *program counter* that indicates what instruction is currently being executed, and data items with local scope, as well as intermediate results from computations.

This process can have multiple threads; these are similar in that they see the same program code and heap, but they have their own stack. Thus, a thread is an independent ‘strand’ of execution through a process.

Processes can belong to different users, or be different programs that a single user is running concurrently, so they have their own data space. On the other hand, threads are part of one process and therefore share the process heap. Threads can have some private data, for instance by have their own data stack, but their main characteristic is that they can collaborate on the same data.

#### 2.7.1.1 The fork-join mechanism

Threads are dynamic, in the sense that they can be created during program execution. (This is different from the MPI model, where every processor run one process, and they are all created and destroyed at the same time.) When a program starts, there is one thread active: the *master thread*. Other threads are created by *thread spawning*, and the master thread can wait for their completion. This is known as the *fork-join* model; it is illustrated in figure 2.10. A group of threads that is forked from the same thread and active simultaneously is known as a *thread team*.

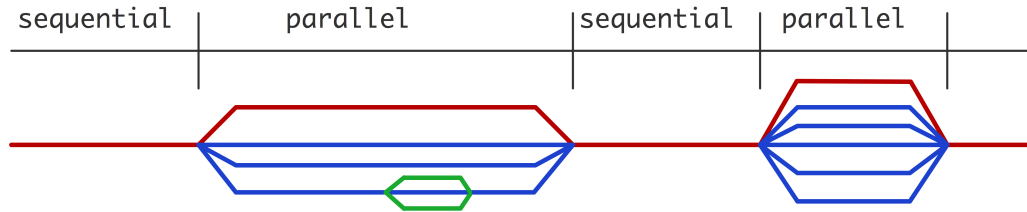

Figure 2.10: Thread creation and deletion during parallel execution

### 2.7.1.2 Threads and parallel computing

Since threads share data, they are one possible mechanism for parallel programming. Of course, for this to be faster than sequential single-threaded execution, this assumes that the hardware can work on more than one thread at the same time. This can happen in two main circumstances: a multicore processor can accommodate one thread per core, and secondly, some cores have hardware support for executing more than one thread.

The thread mechanism has long existed, even on a single processor. By having more than one thread on a single processor, a higher processor utilization can result, since the instructions of one thread can be processed while another thread is waiting for data. On traditional CPUs, switching between threads is somewhat expensive (an exception is the *hyper-threading* mechanism) but on GPUs it is not, and in fact they *need* many threads to attain high performance.

In the context of parallel processing we are also interested in threads, since in a shared memory context multiple threads running on multiple processors or processor cores can be an easy way to parallelize a computation. The shared memory allows the threads to all see the same data. This can also lead to problems; see section [2.7.1.5](#).

### 2.7.1.3 Threads example

The following example<sup>6</sup> is a clear illustration of the *fork-join* model. It uses the *pthread* library to spawn a number of tasks that all update a global counter. Since threads share the same memory space, they indeed see and update the same memory location.

```
#include <stdlib.h>
#include <stdio.h>
#include "pthread.h"

int sum=0;

void adder() {
    sum = sum+1;
    return;
}
```

6. This is strictly Unix-centric and will not work on Windows.

## 2. Parallel Computing

---

```
#define NTHREADS 50
int main() {
    int i;
    pthread_t threads[NTHREADS];
    printf("forking\n");
    for (i=0; i<NTHREADS; i++)
        if (pthread_create(threads+i, NULL, &adder, NULL) != 0) return i+1;
    printf("joining\n");
    for (i=0; i<NTHREADS; i++)
        if (pthread_join(threads[i], NULL) != 0) return NTHREADS+i+1;
    printf("Sum computed: %d\n", sum);

    return 0;
}
```

The fact that this code gives the right result is a coincidence: it only happens because updating the variable is so much quicker than creating the thread. (On a multicore processor the chance of errors will greatly increase.) If we artificially increase the time for the update, we will no longer get the right result:

```
void adder() {
    int t = sum; sleep(1); sum = t+1;
    return;
}
```

Now all threads read out the value of `sum`, wait a while (presumably calculating something) and then update.

This can be fixed by having a *lock* on the code region that should be ‘mutually exclusive’:

```
pthread_mutex_t lock;

void adder() {
    int t, r;
    pthread_mutex_lock(&lock);
    t = sum; sleep(1); sum = t+1;
    pthread_mutex_unlock(&lock);
    return;
}

int main() {
    ....
    pthread_mutex_init(&lock, NULL);
}
```

The lock and unlock commands guarantee that no two threads can interfere with each other's update.

For more information on pthreads, see for instance <https://computing.llnl.gov/tutorials/pthreads>.

#### 2.7.1.4 Contexts

In the above example and its version with the `sleep` command we glanced over the fact that there were two types of data involved. First of all, the variable `s` was created outside the thread spawning part. Thus, this variable was *shared*.

On the other hand, the variable `t` was created once in each spawned thread. We call this *private* data.

The totality of all data that a thread can access is called its *context*. It contains private and shared data, as well as temporary results of computations that the thread is working on<sup>7</sup>.

It is quite possible to create more threads than a processor has cores, so a processor may need to switch between the execution of different threads. This is known as a *context switch*.

Context switches are not for free on regular CPUs, so they only pay off if the *granularity* of the threaded work is high enough. The exceptions to this story are:

- CPUs that have hardware support for multiple threads, for instance through *hyperthreading* (section 2.7.1.10), or as in the *Intel Xeon Phi* (section 2.10);
- GPUs, which in fact rely on fast context switching (section 2.10.3);
- certain other 'exotic' architectures such as the *Cray XMT* (section 2.9).

#### 2.7.1.5 Data races, thread safety, sequential consistency, and atomic operations

Shared memory makes life easy for the programmer, since every processor has access to all of the data: no explicit data traffic between the processor is needed. On the other hand, multiple processes/processors can also write to the same variable, which is a source of potential problems.

Suppose that two processes both try to increment an integer variable `I`:

process 1: `I=I+2`

process 2: `I=I+3`

This is a legitimate activity if the variable is an accumulator for values computed by independent processes. The result of these two updates depends on the sequence in which the processors read and write the variable. Here are three scenarios:

7. It also contains the program counter and stack pointer. If you don't know what those are, don't worry.

## 2. Parallel Computing

---

scenario 1.	scenario 2.	scenario 3.
I = 0		
read I = 0 compute I = 2 write I = 2	read I = 0 compute I = 2 write I = 2	read I = 0 compute I = 2 write I = 2
	read I = 0 compute I = 3 write I = 3	read I = 2 compute I = 5 write I = 5
	write I = 3	
	write I = 2	
I = 3	I = 2	I = 5

Such a scenario, where the final result depends on which thread executes first, is known as a *race condition* or *data race*.

A very practical example of such conflicting updates is the inner product calculation:

```
for (i=0; i<1000; i++)
    sum = sum+a[i]*b[i];
```

Here the products are truly independent, so we could choose to have the loop iterations do them in parallel, for instance by their own threads. However, all threads need to update the same variable `sum`.

Code that behaves the same whether it's executed sequentially or threaded is called *thread safe*. As you can see from the above examples, a lack of thread safety is typically due to the treatment of shared data. This implies that the more your program uses local data, the higher the chance that it is thread safe. Unfortunately, sometimes the threads need to write to shared/global data, for instance when the program does a *reduction*.

There are essentially two ways of solving this problem. One is that we declare such updates of a shared variable a *critical section* of code. This means that the instructions in the critical section (in the inner product example 'read `sum` from memory, update it, write back to memory') can be executed by only one thread at a time. In particular, they need to be executed entirely by one thread before any other thread can start them so the ambiguity problem above will not arise. Of course, the above code fragment is so common that systems like OpenMP (section 2.7.2) have a dedicated mechanism for it, by declaring it a *reduction* operation.

Critical sections can for instance be implemented through the *semaphore* mechanism [39]. Surrounding each critical section there will be two atomic operations controlling a semaphore, a sign post. The first process to encounter the semaphore will lower it, and start executing the critical section. Other processes see the lowered semaphore, and wait. When the first process finishes the critical section, it executes the second instruction which raises the semaphore, allowing one of the waiting processes to enter the critical section.

The other way to resolve common access to shared data is to set a temporary *lock* on certain memory areas. This solution may be preferable, if common execution of the critical section is likely, for instance if it implements writing to a database or hash table. In this case, one process entering a critical section would prevent any other process from writing to the data, even if they might be writing to different locations; locking the specific data item being accessed is then a better solution.

The problem with locks is that they typically exist on the operating system level. This means that they are relatively slow. Since we hope that iterations of the inner product loop above would be executed at the speed of the floating point unit, or at least that of the memory bus, this is unacceptable.

One implementation of this is *transactional memory*, where the hardware itself supports atomic operations; the term derives from database transactions, which have a similar integrity problem. In transactional memory, a process will perform a normal memory update, unless the processor detects a conflict with an update from another process. In that case, the updates (‘transactions’) are aborted and retried with one processor locking the memory and the other waiting for the lock. This is an elegant solution; however, aborting the transaction may carry a certain cost of *pipeline flushing* (section 1.2.5) and cache line invalidation (section 1.4.1).

### 2.7.1.6 Memory models and sequential consistency

The above signaled phenomenon of a *race condition* means that the result of some programs can be non-deterministic, depending on the sequence in which instructions are executed. There is a further factor that comes into play, and which is called the *memory model* that a processor uses. The memory model controls how the activity of one thread or core is seen by other threads or cores.

As an example, consider

initially:  $A=B=0$ ; , then

process 1:  $A=1$ ;  $x = B$ ;

process 2:  $B=1$ ;  $y = A$ ;

As above, we have three scenarios, which we describe by giving a global sequence of statements:

scenario 1.	scenario 2.	scenario 3.
$A \leftarrow 1$	$A \leftarrow 1$	$B \leftarrow 1$
$x \leftarrow B$	$B \leftarrow 1$	$y \leftarrow A$
$B \leftarrow 1$	$x \leftarrow B$	$A \leftarrow 1$
$y \leftarrow A$	$y \leftarrow A$	$x \leftarrow B$
$x = 0, y = 1$	$x = 1, y = 1$	$x = 1, y = 0$

(In the second scenario, statements 1,2 can be reversed, as can 3,4, without change in outcome.)

The three different outcomes can be characterized as being computed by a global ordering on the statements that respects the local orderings. This is known as *sequential consistency*: the parallel outcome is consistent with a sequential execution that interleaves the parallel computations, respecting their local statement orderings.

Maintaining sequential consistency is expensive: it means that any change to a variable immediately needs to be visible on all other threads, or that any access to a variable on a thread needs to consult all other threads. We discussed this in section 1.4.1.

In a *relaxed memory model* it is possible to get a result that is not sequentially consistent. Suppose, in the above example, the instructions  $A \leftarrow 1, B \leftarrow 1$  are executed first, but these changes are not immediately visible to the other threads. Then subsequent instructions  $x \leftarrow B, y \leftarrow A$  can receive the result  $x = 0, y = 0$ , which was not possible under the sequentially consistent model above.

Sequential consistency implies that

```
integer n
n = 0
!$omp parallel shared(n)
n = n + 1
!$omp end parallel
```

should have the same effect as

```
n = 0
n = n+1 ! for processor 0
n = n+1 ! for processor 1
        ! et cetera
```

With sequential consistency it is no longer necessary to declare atomic operations or critical sections; however, this puts strong demands on the implementation of the model, so it may lead to inefficient code.

**Exercise 2.15.** In section [2.7.1.5](#) you saw an example that needed a critical section to get the right final result. Argue that having a critical section is not enough for sequential consistency.

- Write a piece of sequential code that, when executed in parallel, corresponds to the example in section [2.7.1.5](#).
- Show that, using a critical section, there are two execution orderings that give the correct result.
- Show that one of these orderings is not sequentially consistent.

### 2.7.1.7 Affinity

Thread programming is very flexible, effectively creating parallelism as needed. However, a large part of this book is about the importance of data movement in scientific computations, and that aspect can not be ignored in thread programming.

In the context of a multicore processor, any thread can be scheduled to any core, and there is no immediate problem with this. The problem in cases where we have two subsequent regions that are handled with thread-level parallelism. If the first region computes data, and the second uses that data, then we have to make sure that the thread producing a particular data item and the thread consuming (or updating) it are scheduled to the same core.

We call *affinity* the maintaining of a fixed mapping between threads (*thread affinity*) or processes (*process affinity*) and cores.

Maintaining thread affinity is easy in some cases. If the loop structure that is being parallelized stays the same, a fixed mapping of threads to cores makes sense:

```
for (i=0; i<ndata; i++) // this loop will be done by threads
    x[i] = ....
for (i=0; i<ndata; i++) // as will this one
```

```
... = .... x[i] ...
```

In other cases a fixed mapping is not the right solution:

```
for (i=0; i<ndata; i++) // produces loop
  x[i] = ....
for (i=0; i<ndata; i+=2) // use even indices
  ... = ... x[i] ...
for (i=1; i<ndata; i+=2) // use odd indices
  ... = ... x[i] ...
```

In this second example, either the program has to be transformed, or the programmer has to maintain in effect a *task queue*.

It is natural to think of affinity to think in terms of ‘put the execution where the data is’. However, in practice the opposite view sometimes makes sense. For instance, figure 2.7 showed how the shared memory of a cluster node can actually be distributed. Thus, a thread can be attached to a socket, but data can be allocated by the Operating System (OS) on any of the sockets. The mechanism that is often used by the OS is called the *first-touch policy*:

- When the program allocates data, the OS does not actually create it;
- instead, the memory area for the data is created the first time a thread accesses it;
- thus, the first thread to touch the area in effect causes the data to be allocated on the memory of its socket.

**Exercise 2.16.** Explain the problem with the following code:

```
// serial initialization
for (i=0; i<N; i++)
  a[i] = 0.;
#pragma omp parallel for
for (i=0; i<N; i++)
  a[i] = b[i] + c[i];
```

### 2.7.1.8 Concurrency

In this book, we discuss threads in the context of scientific computing. However, threads also facilitate parallelism in other contexts, such as Operating Systems (OSs). In this case, the term *concurrency* is often used, rather than ‘parallelism’. Concurrent tasks are tasks that are not dependent on each other; therefore, they can be executed in any order, or indeed in parallel. Parallel tasks, on the other hand, are tasks that are indeed running simultaneously.

Concurrency has been studied for a long time. Since a lot of this research came from OS research, the question addressed is that of *resource contention*: what if two processes, for instance users on the same system, request access to the same resource, for instance a printer. This means that the system call to print is another example of a critical section of code; see section 2.7.1.5 above. Another problem with concurrency is that two processes can both request access to *two* devices with exclusive use, for instance



a printer and some hardware input device. If one process gets hold of the one resource first, and the other process the other resource, we have another case of *deadlock*.

### 2.7.1.9 Cilk Plus

Other programming models based on threads exist. For instance, Intel *Cilk Plus* (<http://www.cilkplus.org/>) is a set of extensions of C/C++ with which a programmer can create threads.

<pre>Sequential code: int fib(int n){     if (n&lt;2) return 1;     else {         int rst=0;         rst += fib(n-1);         rst += fib(n-2);         return rst;     } }</pre>	<pre>Cilk code: cilk int fib(int n){     if (n&lt;2) return 1;     else {         int rst=0;         rst += cilk_spawn fib(n-1);         rst += cilk_spawn fib(n-2);         cilk_sync;         return rst;     } }</pre>
---	---

In this example, the variable `rst` is updated by two, potentially independent threads. The semantics of this update, that is, the precise definition of how conflicts such as simultaneous writes are resolved, is defined by *sequential consistency*; see section 2.7.1.5.

### 2.7.1.10 Hyperthreading versus multi-threading

In the above examples you saw that the threads that are spawned during one program run essentially execute the same code, and have access to the same data. Thus, at a hardware level, a thread is uniquely determined by a small number of local variables, such as its location in the code (the *program counter*) and intermediate results of the current computation it is engaged in.

Hyperthreading is an Intel technology to let multiple threads use the processor truly simultaneously, so that part of the processor would be optimally used.

If a processor switches between executing one thread and another, it saves this local information of the one thread, and loads the information of the other. The cost of doing this is modest compared to running a whole program, but can be expensive compared to the cost of a single instruction. Thus, hyperthreading may not always give a performance improvement.

Certain architectures have support for *multi-threading*. This means that the hardware actually has explicit storage for the local information of multiple threads, and switching between the threads can be very fast. This is the case on GPUs (section 2.10.3), and on the *Intel Xeon Phi* architecture, where each core can support up to four threads.

## 2.7.2 OpenMP

*OpenMP* is an extension to the programming languages C and Fortran. Its main approach to parallelism is the parallel execution of loops: based on *compiler directives*, a preprocessor can schedule the parallel

execution of the loop iterations.

Since OpenMP is based on *threads*, it features *dynamic parallelism*: the number of execution streams operating in parallel can vary from one part of the code to another. Parallelism is declared by creating parallel regions, for instance indicating that all iterations of a loop nest are independent, and the runtime system will then use whatever resources are available.

OpenMP is not a language, but an extension to the existing C and Fortran languages. It mostly operates by inserting directives into source code, which are interpreted by the compiler. It also has a modest number of library calls, but these are not the main point, unlike in MPI (section 2.7.3.3). Finally, there is a runtime system that manages the parallel execution.

OpenMP has an important advantage over MPI in its programmability: it is possible to start with a sequential code and transform it by *incremental parallelization*. By contrast, turning a sequential code into a distributed memory MPI program is an all-or-nothing affair.

Many compilers, such as GCC or the Intel compiler, support the OpenMP extensions. In Fortran, OpenMP directives are placed in comment statements; in C, they are placed in `#pragma` CPP directives, which indicate compiler specific extensions. As a result, OpenMP code still looks like legal C or Fortran to a compiler that does not support OpenMP. Programs need to be linked to an OpenMP runtime library, and their behaviour can be controlled through environment variables.

For more information about OpenMP, see [25] and <http://openmp.org/wp/>.

### 2.7.2.1 OpenMP examples

The simplest example of OpenMP use is the parallel loop.

```
#pragma omp for
for (i=0; i<ProblemSize; i++) {
    a[i] = b[i];
}
```

Clearly, all iterations can be executed independently and in any order. The pragma CPP directive then conveys this fact to the compiler.

Some loops are fully parallel conceptually, but not in implementation:

```
for (i=0; i<ProblemSize; i++) {
    t = b[i]*b[i];
    a[i] = sin(t) + cos(t);
}
```

Here it looks as if each iteration writes to, and reads from, a shared variable `t`. However, `t` is really a temporary variable, local to each iteration. Code that should be parallelizable, but is not due to such constructs, is called not *thread safe*.

OpenMP indicates that the temporary is private to each iteration as follows:

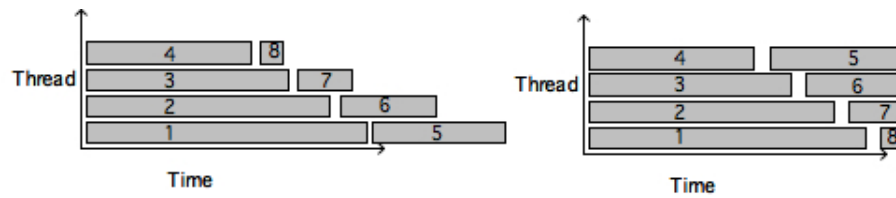

Figure 2.11: Static or round-robin (left) vs dynamic (right) thread scheduling; the task numbers are indicated.

```
#pragma parallel for shared(a,b), private(t)
for (i=0; i<ProblemSize; i++) {
    t = b[i]*b[i];
    a[i] = sin(t) + cos(t);
}
```

If a scalar  $s$  is indeed shared, OpenMP has various mechanisms for dealing with that. For instance, shared variables commonly occur in *reduction operations*:

```
s = 0;
#pragma parallel for reduction(+:sum)
for (i=0; i<ProblemSize; i++) {
    s = s + a[i]*b[i];
}
```

As you see, a sequential code can be easily parallelized this way.

The assignment of iterations to threads is done by the runtime system, but the user can guide this assignment. We are mostly concerned with the case where there are more iterations than threads: if there are  $P$  threads and  $N$  iterations and  $N > P$ , how is iteration  $i$  going to be assigned to a thread?

The simplest assignment uses *round-robin task scheduling*, a *static scheduling* strategy where thread  $p$  get iterations  $p \times (N/P), \dots, (p+1) \times (N/P) - 1$ . This has the advantage that if some data is reused between iterations, it will stay in the data cache of the processor executing that thread. On the other hand, if the iterations differ in the amount of work involved, the process may suffer from *load unbalance* with static scheduling. In that case, a *dynamic scheduling* strategy would work better, where each thread starts work on the next unprocessed iteration as soon as it finishes its current iteration. The example in figure 2.11 shows static versus dynamic scheduling of a number of tasks that gradually decrease in individual running time. In static scheduling, the first thread gets tasks 1 and 4, the second 2 and 5, et cetera. In dynamic scheduling, any thread that finishes its task gets the next task. This clearly gives a better running time in this particular example. On the other hand, dynamic scheduling is likely to have a higher overhead.

You can control OpenMP scheduling of loop iterations with the `schedule` keyword; its values include `static` and `dynamic`. It is also possible to indicate a `chunksize`, which controls the size of the block of iterations that gets assigned together to a thread. If you omit the `chunksize`, OpenMP will divide the iterations into as many blocks as there are threads.

Exercise 2.17. Let's say there are  $t$  threads, and your code looks like

```
for (i=0; i<N; i++) {
    a[i] = // some calculation
}
```

If you specify a chunksize of 1, iterations  $0, t, 2t, \dots$  go to the first thread,  $1, 1+t, 1+2t, \dots$  to the second, et cetera. Discuss why this is a bad strategy from a performance point of view. Hint: look up the definition of *false sharing*. What would be a good chunksize?

### 2.7.3 Distributed memory programming through message passing

While OpenMP programs, and programs written using other shared memory paradigms, still look very much like sequential programs, this does not hold true for message passing code. Before we discuss the Message Passing Interface (MPI) library in some detail, we will take a look at this shift the way parallel code is written.

#### 2.7.3.1 The global versus the local view in distributed programming

There can be a marked difference between how a parallel algorithm looks to an observer, and how it is actually programmed. Consider the case where we have an array of processors  $\{P_i\}_{i=0..p-1}$ , each containing one element of the arrays  $x$  and  $y$ , and  $P_i$  computes

$$\begin{cases} y_i \leftarrow y_i + x_{i-1} & i > 0 \\ y_i \text{ unchanged} & i = 0 \end{cases} \quad (2.4)$$

The global description of this could be

- Every processor  $P_i$  except the last sends its  $x$  element to  $P_{i+1}$ ;
- every processor  $P_i$  except the first receive an  $x$  element from their neighbour  $P_{i-1}$ , and
- they add it to their  $y$  element.

However, in general we can not code in these global terms. In the SPMD model (section 2.4.2) each processor executes the same code, and the overall algorithm is the result of these individual behaviours. The local program has access only to local data – everything else needs to be communicated with send and receive operations – and the processor knows its own number.

One possible way of writing this would be

- If I am processor 0 do nothing, otherwise receive a  $y$  element from the left, add it to my  $x$  element.
- If I am the last processor do nothing, otherwise send my  $y$  element to the right.

At first we look at the case where sends and receives are so-called *blocking communication* instructions: a send instruction does not finish until the sent item is actually received, and a receive instruction waits for the corresponding send. This means that sends and receives between processors have to be carefully paired. We will now see that this can lead to various problems on the way to an efficient code.

The above solution is illustrated in figure 2.12, where we show the local timelines depicting the local

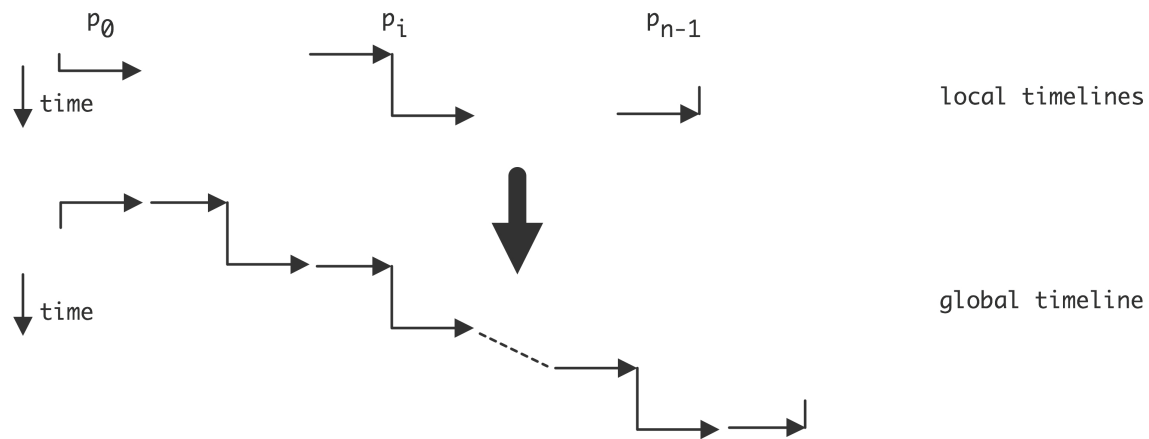

Figure 2.12: Local and resulting global view of an algorithm for sending data to the right

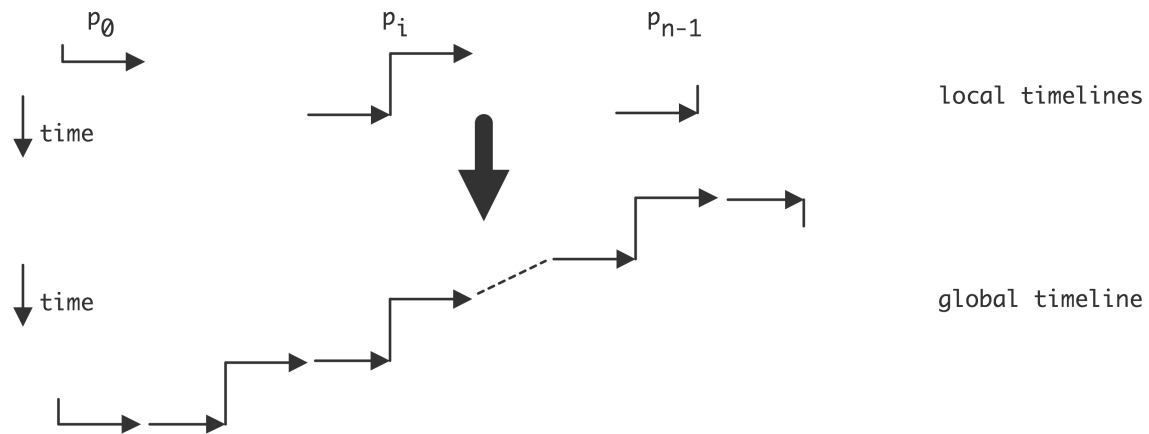

Figure 2.13: Local and resulting global view of an algorithm for sending data to the right

processor code, and the resulting global behaviour. You see that the processors are not working at the same time: we get *serialized execution*.

What if we reverse the send and receive operations?

- If I am not the last processor, send my  $x$  element to the right;
- If I am not the first processor, receive an  $x$  element from the left and add it to my  $y$  element.

This is illustrated in figure 2.13 and you see that again we get a serialized execution, except that now the processor are activated right to left.

If the algorithm in equation 2.4 had been cyclic:

$$\begin{cases} y_i \leftarrow y_i + x_{i-1} & i = 1 \dots n - 1 \\ y_0 \leftarrow y_0 + x_{n-1} & i = 0 \end{cases} \quad (2.5)$$

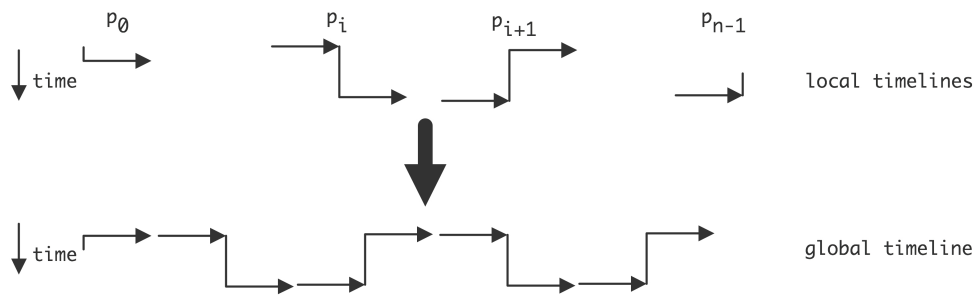

Figure 2.14: Local and resulting global view of an algorithm for sending data to the right

the problem would be even worse. Now the last processor can not start its receive since it is blocked sending  $x_{n-1}$  to processor 0. This situation, where the program can not progress because every processor is waiting for another, is called *deadlock*.

The solution to getting an efficient code is to make as much of the communication happen simultaneously as possible. After all, there are no serial dependencies in the algorithm. Thus we program the algorithm as follows:

- If I am an odd numbered processor, I send first, then receive;
- If I am an even numbered processor, I receive first, then send.

This is illustrated in figure 2.14, and we see that the execution is now parallel.

**Exercise 2.18.** Take another look at figure 2.3 of a parallel reduction. The basic actions are:

- receive data from a neighbour
- add it to your own data
- send the result on.

As you see in the diagram, there is at least one processor who does not send data on, and others may do a variable number of receives before they send their result on.

Write node code so that an SPMD program realizes the distributed reduction. Hint: write each processor number in binary. The algorithm uses a number of steps that is equal to the length of this bitstring.

- Assuming that a processor receives a message, express the distance to the origin of that message in the step number.
- Every processor sends at most one message. Express the step where this happens in terms of the binary processor number.

### 2.7.3.2 Blocking and non-blocking communication

The reason for blocking instructions is to prevent accumulation of data in the network. If a send instruction were to complete before the corresponding receive started, the network would have to store the data somewhere in the mean time. Consider a simple example:

```
buffer = ... ; // generate some data
send(buffer,0); // send to processor 0
```

## 2. Parallel Computing

---

```
buffer = ... ; // generate more data
send(buffer,1); // send to processor 1
```

After the first send, we start overwriting the buffer. If the data in it hasn't been received, the first set of values would have to be buffered somewhere in the network, which is not realistic. By having the send operation block, the data stays in the sender's buffer until it is guaranteed to have been copied to the recipient's buffer.

One way out of the problem of sequentialization or deadlock that arises from blocking instruction is the use of *non-blocking communication* instructions, which include explicit buffers for the data. With non-blocking send instruction, the user needs to allocate a buffer for each send, and check when it is safe to overwrite the buffer.

```
buffer0 = ... ; // data for processor 0
send(buffer0,0); // send to processor 0
buffer1 = ... ; // data for processor 1
send(buffer1,1); // send to processor 1
...
// wait for completion of all send operations.
```

### 2.7.3.3 The MPI library

If OpenMP is the way to program shared memory, Message Passing Interface (MPI) [148] is the standard solution for programming distributed memory. MPI ('Message Passing Interface') is a specification for a library interface for moving data between processes that do not otherwise share data. The MPI routines can be divided roughly in the following categories:

- Process management. This includes querying the parallel environment and constructing subsets of processors.
- Point-to-point communication. This is a set of calls where two processes interact. These are mostly variants of the send and receive calls.
- Collective calls. In these routines, all processors (or the whole of a specified subset) are involved. Examples are the *broadcast* call, where one processor shares its data with every other processor, or the *gather* call, where one processor collects data from all participating processors.

Let us consider how the OpenMP examples can be coded in MPI<sup>8</sup>. First of all, we no longer allocate

```
double a[ProblemSize];
```

but

```
double a[LocalProblemSize];
```

where the local size is roughly a  $1/P$  fraction of the global size. (Practical considerations dictate whether you want this distribution to be as evenly as possible, or rather biased in some way.)

---

8. This is not a course in MPI programming, and consequently the examples will leave out many details of the MPI calls. If you want to learn MPI programming, consult for instance [75].

The parallel loop is trivially parallel, with the only difference that it now operates on a fraction of the arrays:

```
for (i=0; i<LocalProblemSize; i++) {
    a[i] = b[i];
}
```

However, if the loop involves a calculation based on the iteration number, we need to map that to the global value:

```
for (i=0; i<LocalProblemSize; i++) {
    a[i] = b[i]+f(i+MyFirstVariable);
}
```

(We will assume that each process has somehow calculated the values of `LocalProblemSize` and `MyFirstVariable`.) Local variables are now automatically local, because each process has its own instance:

```
for (i=0; i<LocalProblemSize; i++) {
    t = b[i]*b[i];
    a[i] = sin(t) + cos(t);
}
```

However, shared variables are harder to implement. Since each process has its own data, the local accumulation has to be explicitly assembled:

```
for (i=0; i<LocalProblemSize; i++) {
    s = s + a[i]*b[i];
}
MPI_Allreduce(s, globals, 1, MPI_DOUBLE, MPI_SUM);
```

The ‘reduce’ operation sums together all local values `s` into a variable `globals` that receives an identical value on each processor. This is known as a *collective operation*.

Let us make the example slightly more complicated:

```
for (i=0; i<ProblemSize; i++) {
    if (i==0)
        a[i] = (b[i]+b[i+1])/2
    else if (i==ProblemSize-1)
        a[i] = (b[i]+b[i-1])/2
    else
        a[i] = (b[i]+b[i-1]+b[i+1])/3
}
```

If we had shared memory, we could write the following parallel code:

```
for (i=0; i<LocalProblemSize; i++) {
    bleft = b[i-1]; bright = b[i+1];
}
```



## 2. Parallel Computing

---

```
a[i] = (b[i]+bleft+bright)/3
```

To turn this into valid distributed memory code, first we account for the fact that `bleft` and `bright` need to be obtained from a different processor for `i==0` (`bleft`), and for `i==LocalProblemSize-1` (`bright`). We do this with a exchange operation with our left and right neighbour processor:

```
// get bfromleft and bfromright from neighbour processors, then
for (i=0; i<LocalProblemSize; i++) {
    if (i==0) bleft=bfromleft;
    else bleft = b[i-1]
    if (i==LocalProblemSize-1) bright=bfromright;
    else bright = b[i+1];
    a[i] = (b[i]+bleft+bright)/3
```

Obtaining the neighbour values is done as follows. First we need to ask our processor number, so that we can start a communication with the processor with a number one higher and lower.

```
MPI_Comm_rank(MPI_COMM_WORLD, &myTaskID);
MPI_Sendrecv
    (/* to be sent: */ &b[LocalProblemSize-1],
     /* destination */ myTaskID+1,
     /* to be recvd: */ &bfromleft,
     /* source: */ myTaskID-1,
     /* some parameters omitted */
    );
MPI_Sendrecv(&b[0], myTaskID-1,
             &bfromright, /* ... */ );
```

There are still two problems with this code. First, the `sendrecv` operations need exceptions for the first and last processors. This can be done elegantly as follows:

```
MPI_Comm_rank(MPI_COMM_WORLD, &myTaskID);
MPI_Comm_size(MPI_COMM_WORLD, &nTasks);
if (myTaskID==0) leftproc = MPI_PROC_NULL;
    else leftproc = myTaskID-1;
if (myTaskID==nTasks-1) rightproc = MPI_PROC_NULL;
    else rightproc = myTaskID+1;
MPI_Sendrecv( &b[LocalProblemSize-1], &bfromleft, rightproc );
MPI_Sendrecv( &b[0], &bfromright, leftproc);
```

**Exercise 2.19.** There is still a problem left with this code: the boundary conditions from the original, global, version have not been taken into account. Give code that solves that problem.

MPI gets complicated if different processes need to take different actions, for example, if one needs to send data to another. The problem here is that each process executes the same executable, so it needs to contain

both the send and the receive instruction, to be executed depending on what the rank of the process is.

```

if (myTaskID==0) {
    MPI_Send(myInfo,1,MPI_INT,/* to: */ 1,/* labeled: */ 0,
            MPI_COMM_WORLD);
} else {
    MPI_Recv(myInfo,1,MPI_INT,/* from: */ 0,/* labeled: */ 0,
            /* not explained here: */ &status,MPI_COMM_WORLD);
}

```

#### 2.7.3.4 Blocking

Although MPI is sometimes called the ‘assembly language of parallel programming’, for its perceived difficulty and level of explicitness, it is not all that hard to learn, as evinced by the large number of scientific codes that use it. The main issues that make MPI somewhat intricate to use, are buffer management and blocking semantics.

These issues are related, and stem from the fact that, ideally, data should not be in two places at the same time. Let us briefly consider what happens if processor 1 sends data to processor 2. The safest strategy is for processor 1 to execute the send instruction, and then wait until processor 2 acknowledges that the data was successfully received. This means that processor 1 is temporarily blocked until processor 2 actually executes its receive instruction, and the data has made its way through the network. This is the standard behaviour of the `MPI_Send` and `MPI_Recv` calls, which are said to use *blocking communication*.

Alternatively, processor 1 could put its data in a buffer, tell the system to make sure that it gets sent at some point, and later checks to see that the buffer is safe to reuse. This second strategy is called *non-blocking communication*, and it requires the use of a temporary buffer.

#### 2.7.3.5 Collective operations

In the above examples, you saw the `MPI_Allreduce` call, which computed a global sum and left the result on each processor. There is also a local version `MPI_Reduce` which computes the result only on one processor. These calls are examples of *collective operations* or collectives. The collectives are:

**reduction** : each processor has a data item, and these items need to be combined arithmetically with an addition, multiplication, max, or min operation. The result can be left on one processor, or on all, in which case we call this an **allreduce** operation.

**broadcast** : one processor has a data item that all processors need to receive.

**gather** : each processor has a data item, and these items need to be collected in an array, without combining them in an operations such as an addition. The result can be left on one processor, or on all, in which case we call this an **allgather**.

**scatter** : one processor has an array of data items, and each processor receives one element of that array.

**all-to-all** : each processor has an array of items, to be scattered to all other processors.

Collective operations are blocking (see section 2.7.3.4), although MPI 3.0 (which is currently only a draft) will have non-blocking collectives. We will analyze the cost of collective operations in detail in section 6.1.

### 2.7.3.6 *Non-blocking communication*

In a simple computer program, each instruction takes some time to execute, in a way that depends on what goes on in the processor. In parallel programs the situation is more complicated. A send operation, in its simplest form, declares that a certain buffer of data needs to be sent, and program execution will then stop until that buffer has been safely sent and received by another processor. This sort of operation is called a *non-local operation* since it depends on the actions of other processes, and a *blocking communication* operation since execution will halt until a certain event takes place.

Blocking operations have the disadvantage that they can lead to *deadlock*. In the context of message passing this describes the situation that a process is waiting for an event that never happens; for instance, it can be waiting to receive a message and the sender of that message is waiting for something else. You can easily recognize that deadlock occurs if two processes are waiting for each other, or more generally, if you have a cycle of processes where each is waiting for the next process in the cycle. Example:

```
if ( /* this is process 0 */ )
    // wait for message from 1
else if ( /* this is process 1 */ )
    // wait for message from 0
```

A block receive here leads to deadlock. Even without deadlock, they can lead to considerable *idle time* in the processors, as they wait without performing any useful work. On the other hand, they have the advantage that it is clear when the buffer can be reused: after the operation completes, there is a guarantee that the data has been safely received at the other end.

The blocking behaviour can be avoided, at the cost of complicating the buffer semantics, by using *non-blocking communication* operations. A non-blocking send (`MPI_Isend`) declares that a data buffer needs to be sent, but then does not wait for the completion of the corresponding receive. There is a second operation `MPI_Wait` that will actually block until the receive has been completed. The advantage of this decoupling of sending and blocking is that it now becomes possible to write:

```
MPI_Isend(somebuffer, &handle); // start sending, and
    // get a handle to this particular communication
{ ... } // do useful work on local data
MPI_Wait(handle); // block until the communication is completed;
{ ... } // do useful work on incoming data
```

With a little luck, the local operations take more time than the communication, and you have completely eliminated the communication time.

In addition to non-blocking sends, there are non-blocking receives. A typical piece of code then looks like

```
MPI_Isend(sendbuffer, &sendhandle);
MPI_IReceive(recvbuffer, &recvhandle);
{ ... } // do useful work on local data
MPI_Wait(sendhandle); Wait(recvhandle);
{ ... } // do useful work on incoming data
```

**Exercise 2.20.** Take another look at equation (2.5) and give pseudocode that solves the problem using non-blocking sends and receives. What is the disadvantage of this code over a blocking solution?

### 2.7.3.7 MPI version 1 and 2

The first MPI standard [131] had a number of notable omissions, which are included in the MPI 2 standard [76]. One of these concerned parallel input/output: there was no facility for multiple processes to access the same file, even if the underlying hardware would allow that. A separate project MPI-I/O has now been rolled into the MPI-2 standard. We will discuss parallel I/O in this book.

A second facility missing in MPI, though it was present in *PVM* [42, 62] which predates MPI, is process management: there is no way to create new processes and have them be part of the parallel run.

Finally, MPI-2 has support for one-sided communication: one process put data into the memory of another, without the receiving process doing an actual receive instruction. We will have a short discussion in section 2.7.3.8 below.

### 2.7.3.8 One-sided communication

The MPI way of writing matching send and receive instructions is not ideal for a number of reasons. First of all, it requires the programmer to give the same data description twice, once in the send and once in the receive call. Secondly, it requires a rather precise orchestration of communication if deadlock is to be avoided; the alternative of using asynchronous calls is tedious to program, requiring the program to manage a lot of buffers. Lastly, it requires a receiving processor to know how many incoming messages to expect, which can be tricky in irregular applications. Life would be so much easier if it was possible to pull data from another processor, or conversely to put it on another processor, without that other processor being explicitly involved.

This style of programming is further encouraged by the existence of *Remote Direct Memory Access (RDMA)* support on some hardware. An early example was the *Cray T3E*. These days, one-sided communication is widely available through its incorporation in the MPI-2 library; section 2.7.3.7.

Let us take a brief look at one-sided communication in MPI-2, using averaging of array values as an example:

$$\forall_i: a_i \leftarrow (a_i + a_{i-1} + a_{i+1})/3.$$

The MPI parallel code will look like

```
// do data transfer
a_local = (a_local+left+right)/3
```

It is clear what the transfer has to accomplish: the `a_local` variables needs to become the `left` variable on the processor with the next higher rank, and the `right` variables on the one with the next lower rank.

First of all, processors need to declare explicitly what memory area is available for one-sided transfer, the so-called ‘window’. In this example, that consists of the `a_local`, `left`, and `right` variables on the processors:

```
MPI_Win_create(&a_local, ..., &data_window);
MPI_Win_create(&left, ..., &left_window);
MPI_Win_create(&right, ..., &right_window);
```

The code now has two options: it is possible to push data out

```
target = my_tid-1;
MPI_Put (&a_local, ..., target, right_window);
target = my_tid+1;
MPI_Put (&a_local, ..., target, left_window);
```

or to pull it in

```
data_window = a_local;
source = my_tid-1;
MPI_Get (&right, ..., data_window);
source = my_tid+1;
MPI_Get (&left, ..., data_window);
```

The above code will have the right semantics if the Put and Get calls are blocking; see section 2.7.3.4. However, part of the attraction of one-sided communication is that it makes it easier to express communication, and for this, a non-blocking semantics is assumed.

The problem with non-blocking one-sided calls is that it becomes necessary to ensure explicitly that communication is successfully completed. For instance, if one processor does a one-sided *put* operation on another, the other processor has no way of checking that the data has arrived, or indeed that transfer has begun at all. Therefore it is necessary to insert a global barrier in the program, for which every package has its own implementation. In MPI-2 the relevant call is the `MPI_Win_fence` routine. These barriers in effect divide the program execution in *supersteps*; see section 2.7.8.

Another form of one-sided communication is used in the Charm++ package; see section 2.7.7.

### 2.7.4 Hybrid shared/distributed memory computing

Modern architectures are often a mix of shared and distributed memory. For instance, a cluster will be distributed on the level of the nodes, but sockets and cores on a node will have shared memory. One level up, each socket can have a shared L3 cache but separate L2 and L1 caches. Intuitively it seems clear that a mix of shared and distributed programming techniques would give code that is optimally matched to the architecture. In this section we will discuss such hybrid programming models, and discuss their efficacy.

A common setup of clusters uses distributed memory *nodes*, where each node contains several *sockets*, that share memory. This suggests using MPI to communicate between the nodes (*inter-node communication*) and OpenMP for parallelism on the node (*intra-node communication*).

In practice this is realized as follows:

- On each node a single MPI process is started (rather than one per socket or core);

- This one MPI process than uses OpenMP (or another threading protocol) to spawn as many threads as there are independent sockets or cores on the node.
- The OpenMP threads can then easily access the same shared memory.

The alternative would be to have an MPI process on each core or socket, and do all communication through message passing, even between processes that can see the same shared memory.

This hybrid strategy may sound like a good idea but the truth is complicated.

- Message passing between MPI processes sounds like it's more expensive than communicating through shared memory. However, optimized versions of MPI can typically detect when processes are on the same node, and they will replace the message passing by a simple data copy. The only argument against using MPI is then that each process has its own data space, so there is memory overhead because each process has to allocate space for buffers and duplicates of the data that is copied.
- Threading is more flexible: if a certain part of the code needs more memory per process, an OpenMP approach could limit the number of threads on that part. On the other hand, flexible handling of threads incurs a certain amount of OS overhead that MPI does not have with its fixed processes.
- Shared memory programming is conceptually simple, but there can be unexpected performance pitfalls. For instance, the performance of two processes now can be impeded by the need for maintaining *cache coherence* and by *false sharing*.

On the other hand, the hybrid approach offers some advantage since it bundles messages. For instance, if two MPI processes on one node send messages to each of two processes on another node there would be four messages; in the hybrid model these would be bundled into one message.

**Exercise 2.21.** Analyze the discussion in the last item above. Assume that the bandwidth between the two nodes is only enough to sustain one message at a time. What is the cost savings of the hybrid model over the purely distributed model? Hint: consider bandwidth and latency separately.

This bundling of MPI processes may have an advantage for a deeper technical reason. In order to support a *handshake protocol*, each MPI process needs a small amount of buffer space for each other process. With a larger number of processes this can be a limitation, so bundling is attractive on high core count processors such as the *Intel Xeon Phi*.

The MPI library is explicit about what sort of threading it supports: you can query whether multi-threading is supported at all, whether all MPI calls have to originate from one thread or one thread at-a-time, or whether there is complete freedom in making MPI calls from threads.

### 2.7.5 Parallel languages

One approach to mitigating the difficulty of parallel programming is the design of languages that offer explicit support for parallelism. There are several approaches, and we will see some examples.

- Some languages reflect the fact that many operations in scientific computing are data parallel (section 2.6.1). Languages such as *High Performance Fortran (HPF)* (section 2.7.5.3) have an *array syntax*, where operations such addition of arrays can be expressed  $A = B+C$ . This syntax

simplifies programming, but more importantly, it specifies operations at an abstract level, so that a lower level can make specific decision about how to handle parallelism. However, the data parallelism expressed in HPF is only of the simplest sort, where the data are contained in regular arrays. Irregular data parallelism is harder; the *Chapel* language (section 2.7.5.5) makes an attempt at addressing this.

- Another concept in parallel languages, not necessarily orthogonal to the previous, is that of Partitioned Global Address Space (PGAS) model: there is only one address space (unlike in the MPI model), but this address space is partitioned, and each partition has affinity with a thread or process. Thus, this model encompasses both SMP and distributed shared memory. A typical PGAS language, *Unified Parallel C (UPC)*, allows you to write programs that for the most part looks like regular C code. However, by indicating how the major arrays are distributed over processors, the program can be executed in parallel.

### 2.7.5.1 Discussion

Parallel languages hold the promise of making parallel programming easier, since they make communication operations appear as simple copies or arithmetic operations. However, by doing so they invite the user to write code that may not be efficient, for instance by inducing many small messages.

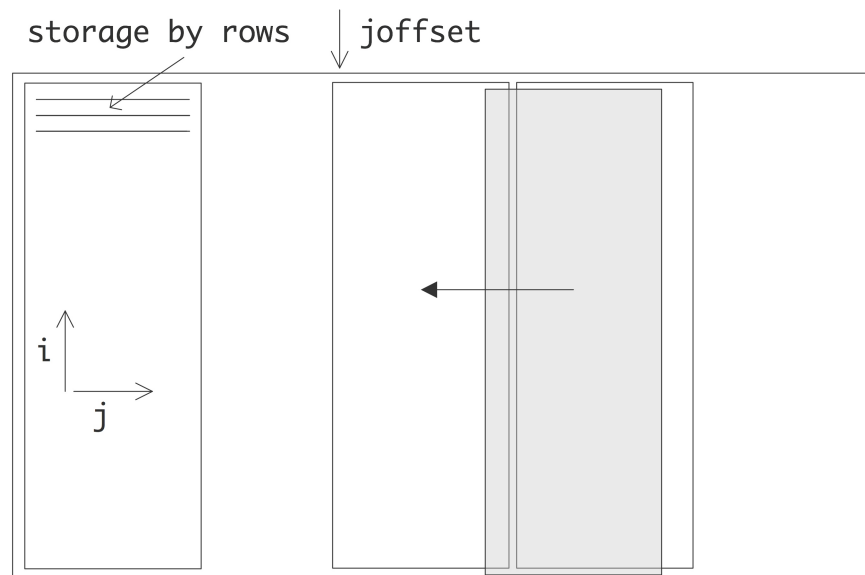

Figure 2.15: Data shift that requires communication

As an example, consider arrays  $a, b$  that have been horizontally partitioned over the processors, and that are shifted (see figure 2.15):

```
for (i=0; i<N; i++)
  for (j=0; j<N/np; j++)
    a[i][j+joffset] = b[i][j+1+joffset]
```

If this code is executed on a shared memory machine, it will be efficient, but a naive translation in the distributed case will have a single number being communicated in each iteration of the `i` loop. Clearly, these can be combined in a single buffer send/receive operation, but compilers are usually unable to make this transformation. As a result, the user is forced to, in effect, re-implement the blocking that needs to be done in an MPI implementation:

```
for (i=0; i<N; i++)
    t[i] = b[i][N/np+joffset]
for (i=0; i<N; i++)
    for (j=0; j<N/np-1; j++) {
        a[i][j] = b[i][j+1]
        a[i][N/np] = t[i]
    }
```

On the other hand, certain machines support direct memory copies through global memory hardware. In that case, PGAS languages can be more efficient than explicit message passing, even with physically distributed memory.

### 2.7.5.2 Unified Parallel C

Unified Parallel C (UPC) [153] is an extension to the C language. Its main source of parallelism is *data parallelism*, where the compiler discovers independence of operations on arrays, and assigns them to separate processors. The language has an extended array declaration, which allows the user to specify whether the array is partitioned by blocks, or in a *round-robin* fashion.

The following program in UPC performs a vector-vector addition.

```
//vect_add.c
#include <upc_relaxed.h>
#define N 100*THREADS
shared int v1[N], v2[N], v1plusv2[N];
void main() {
    int i;
    for(i=MYTHREAD; i<N; i+=THREADS)
        v1plusv2[i]=v1[i]+v2[i];
}
```

The same program with an explicitly parallel loop construct:

```
//vect_add.c
#include <upc_relaxed.h>
#define N 100*THREADS
shared int v1[N], v2[N], v1plusv2[N];
void main()
{
    int i;
```



## 2. Parallel Computing

---

```
upc_forall(i=0; i<N; i++; i)
    v1plusv2[i]=v1[i]+v2[i];
}
```

is comparable to UPC in spirit, but based on Java rather than on C.

### 2.7.5.3 High Performance Fortran

High Performance Fortran<sup>9</sup> (HPF) is an extension of Fortran 90 with constructs that support parallel computing, published by the High Performance Fortran Forum (HPFF). The HPFF was convened and chaired by Ken Kennedy of Rice University. The first version of the HPF Report was published in 1993.

Building on the array syntax introduced in Fortran 90, HPF uses a data parallel model of computation to support spreading the work of a single array computation over multiple processors. This allows efficient implementation on both SIMD and MIMD style architectures. HPF features included:

- New Fortran statements, such as FORALL, and the ability to create PURE (side effect free) procedures;
- The use of *compiler directives* for recommended distributions of array data;
- Extrinsic procedure interface for interfacing to non-HPF parallel procedures such as those using message passing;
- Additional library routines, including environmental inquiry, parallel prefix/suffix (e.g., 'scan'), data scattering, and sorting operations.

Fortran 95 incorporated several HPF capabilities. While some vendors did incorporate HPF into their compilers in the 1990s, some aspects proved difficult to implement and of questionable use. Since then, most vendors and users have moved to OpenMP-based parallel processing. However, HPF continues to have influence. For example the proposed BIT data type for the upcoming Fortran-2008 standard contains a number of new intrinsic functions taken directly from HPF.

### 2.7.5.4 Co-array Fortran

Co-array Fortran (CAF) is an extension to the Fortran 95/2003 language. The main mechanism to support parallelism is an extension to the array declaration syntax, where an extra dimension indicates the parallel distribution. For instance, in

```
Real, dimension(100), codimension[*] :: X
Real :: Y(100)[*]
Real :: Z(100,200)[10,0:9,*]
```

arrays X, Y have 100 elements on each processor. Array Z behaves as if the available processors are on a three-dimensional grid, with two sides specified and the third adjustable to accommodate the available processors.

Communication between processors is now done through copies along the (co-)dimensions that describe the processor grid. The Fortran 2008 standard includes co-arrays.

---

9. This section quoted from Wikipedia

### 2.7.5.5 Chapel

Chapel [24] is a new parallel programming language<sup>10</sup> being developed by Cray Inc. as part of the DARPA-led High Productivity Computing Systems program (HPCS). Chapel is designed to improve the productivity of high-end computer users while also serving as a portable parallel programming model that can be used on commodity clusters or desktop multicore systems. Chapel strives to vastly improve the programmability of large-scale parallel computers while matching or beating the performance and portability of current programming models like MPI.

Chapel supports a multithreaded execution model via high-level abstractions for data parallelism, task parallelism, concurrency, and nested parallelism. Chapel's locale type enables users to specify and reason about the placement of data and tasks on a target architecture in order to tune for locality. Chapel supports global-view data aggregates with user-defined implementations, permitting operations on distributed data structures to be expressed in a natural manner. In contrast to many previous higher-level parallel languages, Chapel is designed around a multiresolution philosophy, permitting users to initially write very abstract code and then incrementally add more detail until they are as close to the machine as their needs require. Chapel supports code reuse and rapid prototyping via object-oriented design, type inference, and features for generic programming.

Chapel was designed from first principles rather than by extending an existing language. It is an imperative block-structured language, designed to be easy to learn for users of C, C++, Fortran, Java, Perl, Matlab, and other popular languages. While Chapel builds on concepts and syntax from many previous languages, its parallel features are most directly influenced by ZPL, High-Performance Fortran (HPF), and the Cray MTA's extensions to C and Fortran.

Here is vector-vector addition in Chapel:

```
const BlockDist= newBlock1D(bbox=[1..m], tasksPerLocale=...);
const ProblemSpace: domain(1, 64) distributed BlockDist = [1..m];
var A, B, C: [ProblemSpace] real;
forall(a, b, c) in(A, B, C) do
    a = b + alpha * c;
```

### 2.7.5.6 Fortress

Fortress [58] is a programming language developed by Sun Microsystems. Fortress<sup>11</sup> aims to make parallelism more tractable in several ways. First, parallelism is the default. This is intended to push tool design, library design, and programmer skills in the direction of parallelism. Second, the language is designed to be more friendly to parallelism. Side-effects are discouraged because side-effects require synchronization to avoid bugs. Fortress provides transactions, so that programmers are not faced with the task of determining lock orders, or tuning their locking code so that there is enough for correctness, but not so much that performance is impeded. The Fortress looping constructions, together with the library, turns "iteration" inside out; instead of the loop specifying how the data is accessed, the data structures specify how the loop is run,

10. This section quoted from the Chapel homepage.

11. This section quoted from the Fortress homepage.

and aggregate data structures are designed to break into large parts that can be effectively scheduled for parallel execution. Fortress also includes features from other languages intended to generally help productivity – test code and methods, tied to the code under test; contracts that can optionally be checked when the code is run; and properties, that might be too expensive to run, but can be fed to a theorem prover or model checker. In addition, Fortress includes safe-language features like checked array bounds, type checking, and garbage collection that have been proven-useful in Java. Fortress syntax is designed to resemble mathematical syntax as much as possible, so that anyone solving a problem with math in its specification can write a program that can be more easily related to its original specification.

### 2.7.5.7 X10

X10 is an experimental new language currently under development at IBM in collaboration with academic partners. The X10 effort is part of the IBM PERCS project (Productive Easy-to-use Reliable Computer Systems) in the DARPA program on High Productivity Computer Systems. The PERCS project is focused on a hardware-software co-design methodology to integrate advances in chip technology, architecture, operating systems, compilers, programming language and programming tools to deliver new adaptable, scalable systems that will provide an order-of-magnitude improvement in development productivity for parallel applications by 2010.

X10 aims to contribute to this productivity improvement by developing a new programming model, combined with a new set of tools integrated into Eclipse and new implementation techniques for delivering optimized scalable parallelism in a managed runtime environment. X10 is a type-safe, modern, parallel, distributed object-oriented language intended to be very easily accessible to Java(TM) programmers. It is targeted to future low-end and high-end systems with nodes that are built out of multi-core SMP chips with non-uniform memory hierarchies, and interconnected in scalable cluster configurations. A member of the Partitioned Global Address Space (PGAS) family of languages, X10 highlights the explicit reification of locality in the form of places; lightweight activities embodied in `async`, `future`, `foreach`, and `ateach` constructs; constructs for termination detection (`finish`) and phased computation (`clocks`); the use of lock-free synchronization (`atomic blocks`); and the manipulation of global arrays and data structures.

### 2.7.5.8 Linda

As should be clear by now, the treatment of data is by far the most important aspect of parallel programming, far more important than algorithmic considerations. The programming system *Linda* [63, 64], also called a *coordination language*, is designed to address the data handling explicitly. Linda is not a language as such, but can, and has been, incorporated into other languages.

The basic concept of Linda is *tuple space*: data is added to a pool of globally accessible information by adding a label to it. Processes then retrieve data by their label, and without needing to know which processes added them to the tuple space.

Linda is aimed primarily at a different computation model than is relevant for *High-Performance Computing (HPC)*: it addresses the needs of asynchronous communicating processes. However, it has been used for scientific computation [38]. For instance, in parallel simulations of the heat equation (section 4.3), processors can write their data into tuple space, and neighbouring processes can retrieve their *ghost region* without having to know its provenance. Thus, Linda becomes one way of implementing *one-sided communication*.

### 2.7.5.9 The Global Arrays library

The Global Arrays library (<http://www.emsl.pnl.gov/docs/global/>) is another example of *one-sided communication*, and in fact it predates MPI. This library has as its prime data structure *cartesian product* arrays<sup>12</sup>, distributed over a processor grid of the same or lower dimension. Through library calls, any processor can access any sub-brick out of the array in either a `put` or `get` operation. These operations are non-collective. As with any one-sided protocol, a barrier sync is necessary to ensure completion of the sends/receives.

### 2.7.6 OS-based approaches

It is possible to design an architecture with a shared address space, and let the data movement be handled by the operating system. The Kendall Square computer [98] had an architecture name ‘all-cache’, where no data was natively associated with any processor. Instead, all data was considered to be cached on a processor, and moved through the network on demand, much like data is moved from main memory to cache in a regular CPU. This idea is analogous to the NUMA support in current SGI architectures.

### 2.7.7 Active messages

The MPI paradigm (section 2.7.3.3) is traditionally based on two-sided operations: each data transfer requires an explicit send and receive operation. This approach works well with relatively simple codes, but for complicated problems it becomes hard to orchestrate all the data movement. One of the ways to simplify consists of using *active messages*. This is used in the package *Charm++*[94].

With active messages, one processor can send data to another, without that second processor doing an explicit receive operation. Instead, the recipient declares code that handles the incoming data, a ‘method’ in objective orientation parlance, and the sending processor calls this method with the data that it wants to send. Since the sending processor in effect activates code on the other processor, this is also known as *remote method invocation*. A big advantage of this method is that overlap of communication and computation becomes easier to realize.

As an example, consider the matrix-vector multiplication with a tridiagonal matrix

$$\forall_i: y_i \leftarrow 2x_i - x_{i+1} - x_{i-1}.$$

See section 4.2.2 for an explanation of the origin of this problem in PDEs. Assuming that each processor has exactly one index  $i$ , the MPI code could look like:

```
if ( /* I am the first or last processor */ )
    n_neighbours = 1;
else
    n_neighbours = 2;

/* do the MPI_Isend operations on my local data */
```

12. This means that if the array is three-dimensional, it can be described by three integers  $n_1, n_2, n_3$ , and each point has a coordinate  $(i_1, i_2, i_3)$  with  $1 \leq i_1 \leq n_1$  et cetera.

```
sum = 2*local_x_data;
received = 0;
for (neighbour=0; neighbour<n_neighbours; neighbour++) {
    MPI_WaitAny( /* wait for any incoming data */ )
    sum = sum - /* the element just received */
    received++
    if (received==n_neighbours)
        local_y_data = sum
}
```

With active messages this looks like

```
void incorporate_neighbour_data(x) {
    sum = sum-x;
    if (received==n_neighbours)
        local_y_data = sum
}
sum = 2*local_xdata;
received = 0;
all_processors[myid+1].incorporate_neighbour_data(local_x_data);
all_processors[myid-1].incorporate_neighbour_data(local_x_data);
```

### 2.7.8 Bulk synchronous parallelism

The MPI library (section 2.7.3.3) can lead to very efficient code. The price for this is that the programmer needs to spell out the communication in great detail. On the other end of the spectrum, PGAS languages (section 2.7.5) ask very little of the programmer, but give not much performance in return. One attempt to find a middle ground is the *Bulk Synchronous Parallel (BSP)* model [154, 147]. Here the programmer needs to spell out the communications, but not their ordering.

The BSP model orders the program into a sequence of *supersteps*, each of which ends with a *barrier* synchronization. The communications that are started in one superstep are all asynchronous and rely on the barrier for their completion. This makes programming easier and removes the possibility of deadlock. Moreover, all communication are of the *one-sided communication* type.

**Exercise 2.22.** Consider the parallel summing example in section 2.1. Argue that a BSP implementation needs  $\log_2 n$  supersteps.

Because of its synchronization of the processors through the barriers concluding the supersteps the BSP model can do a simple cost analysis of parallel algorithms.

Another aspect of the BSP model is its use of *overdecomposition* of the problem, where multiple processes are assigned to each processor, as well as *random placement* of data and tasks. This is motivated with a statistical argument that shows it can remedy *load imbalance*. If there are  $p$  processors and if in a superstep  $p$  remote accesses are made, with high likelihood some processor receives  $\log p / \log \log p$  accesses, while

others receive none. Thus, we have a load imbalance that worsens with increasing processor count. On the other hand, if  $p \log p$  accesses are made, for instance because there are  $\log p$  processes on each processor, the maximum number of accesses is  $3 \log p$  with high probability. This means the load balance is within a constant factor of perfect.

The BSP model is implemented in BSPLib [87]. Other system can be said to be BSP-like in that they use the concept of supersteps; for instance Google's *Pregel* [119].

## 2.7.9 Program design for parallelism

A long time ago it was thought that some magic combination of compiler and runtime system could transform an existing sequential program into a parallel one. That hope has long evaporated, so these days a parallel program will have been written from the ground up as parallel. Of course there are different types of parallelism, and they each have their own implications for precisely how you design your parallel program. In this section we will briefly look into some of the issues.

### 2.7.9.1 Parallel data structures

One of the issues in parallel program design is the use of *Array-Of-Structures (AOS)* vs *Structure-Of-Arrays (SOA)*. In normal program design you often define a structure

```
struct { int number; double xcoord,ycoord; } _Node;
struct { double xtrans,ytrans} _Vector;
typedef struct _Node* Node;
typedef struct _Vector* Vector;
```

and if you need a number of them you create an array of such structures.

```
Node *nodes = (node) malloc( n_nodes*sizeof(struct _Node) );
```

This is the AOS design.

Now suppose that you want to parallelize an operation

```
void shift(node the_point,vector by) {
    the_point->xcoord += by->xtrans;
    the_point->ycoord += by->ytrans;
}
```

which is done in a loop

```
for (i=0; i<n_nodes; i++) {
    shift(nodes[i],shift_vector);
}
```

## 2. Parallel Computing

---

This code has the right structure for MPI programming (section 2.7.3.3), where every processor has its own local array of nodes. This loop is also easily parallelizable with OpenMP (section 2.7.2).

However, in the 1980s codes had to be substantially rewritten as it was realized that the AOS design was not good for vector computers. In that case you operands need to be contiguous, and so codes had to go to a SOA design:

```
node_numbers = (int*) malloc( n_nodes*sizeof(int) );
node_xcoords = // et cetera
node_ycoords = // et cetera
```

and you would iterate

```
for (i=0; i<n_nodes; i++) {
    node_xcoords[i] += shift_vector->xtrans;
    node_ycoords[i] += shift_vector->ytrans;
}
```

Oh, did I just say that the original SOA design was best for distributed memory programming? That meant that 10 years after the vector computer era everyone had to rewrite their codes again for clusters. And of course nowadays, with increasing *SIMD width*, we need to go part way back to the AOS design. (There is some experimental software support for this transformation in the Intel *ispc* project, <http://ispc.github.io/>, which translates *SPMD* code to *SIMD*.)

### 2.7.9.2 Latency hiding

Communication between processors is typically slow, slower than data transfer from memory on a single processor, and much slower than operating on data. For this reason, it is good to think about the relative volumes of network traffic versus ‘useful’ operations when designing a parallel program. There has to be enough work per processor to offset the communication.

Another way of coping with the relative slowness of communication is to arrange the program so that the communication actually happens while some computation is going on. This is referred to as *overlapping computation with communication* or *latency hiding*.

For example, consider the parallel execution of a matrix-vector product  $y = Ax$  (there will be further discussion of this operation in section 6.2.1). Assume that the vectors are distributed, so each processor  $p$  executes

$$\forall_{i \in I_p} : y_i = \sum_j a_{ij} x_j.$$

Since  $x$  is also distributed, we can write this as

$$\forall_{i \in I_p} : y_i = \left( \sum_{j \text{ local}} + \sum_{j \text{ not local}} \right) a_{ij} x_j.$$

This scheme is illustrated in figure 2.16. We can now proceed as follows:

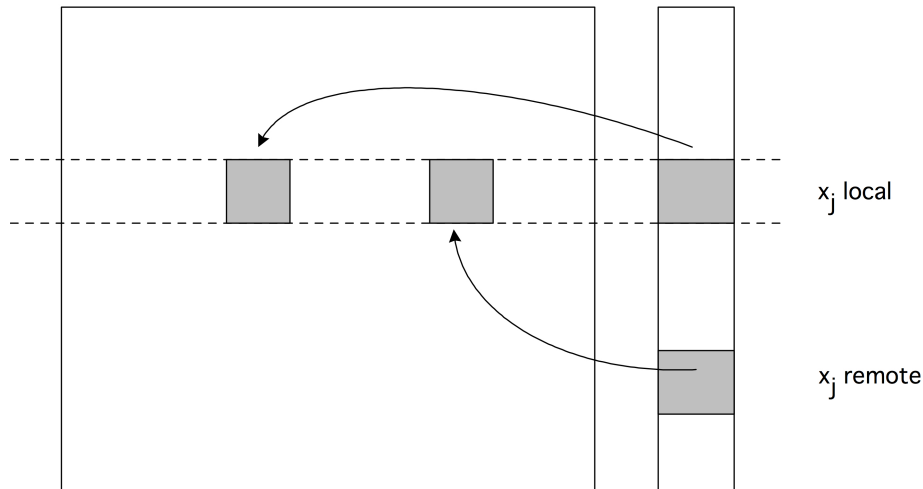

Figure 2.16: The parallel matrix-vector product with a blockrow distribution.

- Start the transfer of non-local elements of  $x$ ;
- Operate on the local elements of  $x$  while data transfer is going on;
- Make sure that the transfers are finished;
- Operate on the non-local elements of  $x$ .

**Exercise 2.23.** How much can you gain from overlapping computation and communication?

Hint: consider the border cases where computation takes zero time and there is only communication, and the reverse. Now consider the general case.

Of course, this scenario presupposes that there is software and hardware support for this overlap. MPI allows for this (see section 2.7.3.6), through so-called *asynchronous communication* or *non-blocking communication* routines. This does not immediately imply that overlap will actually happen, since hardware support is an entirely separate question.

## 2.8 Topologies

If a number of processors are working together on a single task, most likely they need to communicate data. For this reason there needs to be a way for data to make it from any processor to any other. In this section we will discuss some of the possible schemes to connect the processors in a parallel machine. Such a scheme is called a (processor) *topology*.

In order to get an appreciation for the fact that there is a genuine problem here, consider two simple schemes that do not ‘scale up’:

- Ethernet is a connection scheme where all machines on a network are on a single cable<sup>13</sup>. If one machine puts a signal on the wire to send a message, and another also wants to send a

13. We are here describing the original design of Ethernet. With the use of switches, especially in an HPC context, this description does not really apply anymore.



message, the latter will detect that the sole available communication channel is occupied, and it will wait some time before retrying its send operation. Receiving data on ethernet is simple: messages contain the address of the intended recipient, so a processor only has to check whether the signal on the wire is intended for it.

The problems with this scheme should be clear. The capacity of the communication channel is finite, so as more processors are connected to it, the capacity available to each will go down. Because of the scheme for resolving conflicts, the average delay before a message can be started will also increase<sup>14</sup>.

- In a *fully connected* configuration, each processor has one wire for the communications with each other processor. This scheme is perfect in the sense that messages can be sent in the minimum amount of time, and two messages will never interfere with each other. The amount of data that can be sent from one processor is no longer a decreasing function of the number of processors; it is in fact an increasing function, and if the network controller can handle it, a processor can even engage in multiple simultaneous communications.

The problem with this scheme is of course that the design of the network interface of a processor is no longer fixed: as more processors are added to the parallel machine, the network interface gets more connecting wires. The network controller similarly becomes more complicated, and the cost of the machine increases faster than linearly in the number of processors.

In this section we will see a number of schemes that *can* be increased to large numbers of processors.

### 2.8.1 Some graph theory

The network that connects the processors in a parallel computer can conveniently be described with some elementary *graph theory* concepts. We describe the parallel machine with a graph where each processor is a node, and two nodes are connected<sup>15</sup> if there is a direct connection between them.

We can then analyze two important concepts of this graph.

First of all, the *degree* of a node in a graph is the number of other nodes it is connected to. With the nodes representing processors, and the edges the wires, it is clear that a high degree is not just desirable for efficiency of computing, but also costly from an engineering point of view. We assume that all processors have the same degree.

Secondly, a message traveling from one processor to another, through one or more intermediate nodes, will most likely incur some delay at each stage of the path between the nodes. For this reason, the *diameter* of the graph is important. The diameter is defined as the maximum shortest distance, counting numbers of links, between any two nodes:

$$d(G) = \max_{i,j} |\text{shortest path between } i \text{ and } j|.$$

If  $d$  is the diameter, and if sending a message over one wire takes unit time, this means a message will always arrive in at most time  $d$ .

---

14. It was initially thought that ethernet would be inferior to other solutions such as IBM's 'token ring'. It takes fairly sophisticated statistical analysis to prove that it works a lot better than was naively expected.

15. We assume that connections are symmetric, so that the network is an *undirected graph*.

**Exercise 2.24.** Find a relation between the number of processors, their degree, and the diameter of the connectivity graph.

In addition to the question ‘how long will a message from processor A to processor B take’, we often worry about conflicts between two simultaneous messages: is there a possibility that two messages, under way at the same time, will need to use the same network link? In figure 2.17 we illustrate what happens if every processor  $p_i$  with  $i < n/2$  send a message to  $p_{i+n/2}$ : there will be  $n/2$  messages trying to get through the wire between  $p_{n/2-1}$  and  $p_{n/2}$ . This sort of conflict is called *congestion* or *contention*. Clearly, the more

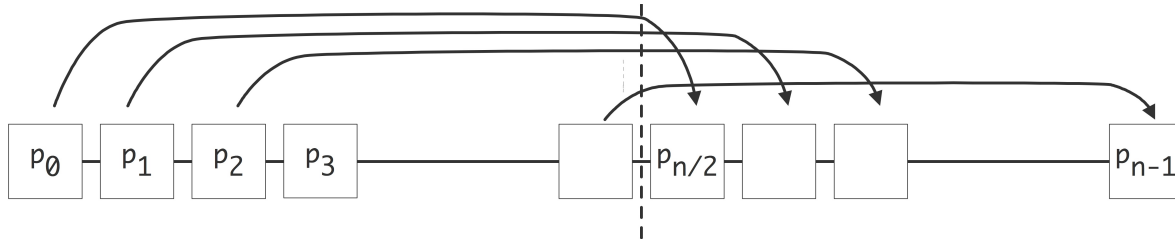

Figure 2.17: Contention for a network link due to simultaneous messages

links a parallel computer has, the smaller the chance of congestion.

A precise way to describe the likelihood of congestion, is to look at the *bisection width*. This is defined as the minimum number of links that have to be removed to partition the processor graph into two unconnected graphs. For instance, consider processors connected as a linear array, that is, processor  $P_i$  is connected to  $P_{i-1}$  and  $P_{i+1}$ . In this case the bisection width is 1.

The bisection width  $w$  describes how many messages can, guaranteed, be under way simultaneously in a parallel computer. Proof: take  $w$  sending and  $w$  receiving processors. The  $w$  paths thus defined are disjoint: if they were not, we could separate the processors into two groups by removing only  $w - 1$  links.

In practice, of course, more than  $w$  messages can be under way simultaneously. For instance, in a linear array, which has  $w = 1$ ,  $P/2$  messages can be sent and received simultaneously if all communication is between neighbours, and if a processor can only send or receive, but not both, at any one time. If processors can both send and receive simultaneously,  $P$  messages can be under way in the network.

Bisection width also describes *redundancy* in a network: if one or more connections are malfunctioning, can a message still find its way from sender to receiver?

While bisection width is a measure express as a number of wires, in practice we care about the capacity through those wires. The relevant concept here is *bisection bandwidth*: the bandwidth across the bisection width, which is the product of the bisection width, and the capacity (in bits per second) of the wires. Bisection bandwidth can be considered as a measure for the bandwidth that can be attained if an arbitrary half of the processors communicates with the other half. Bisection bandwidth is a more realistic measure than the *aggregate bandwidth* which is sometimes quoted and which is defined as the total data rate if every processor is sending: the number of processors times the bandwidth of a connection times the number of simultaneous sends a processor can perform. This can be quite a high number, and it is typically not representative of the communication rate that is achieved in actual applications.

### 2.8.2 Busses

The first interconnect design we consider is to have all processors on the same *memory bus*. This design connects all processors directly to the same memory pool, so it offers a *UMA* or *SMP* model.

The main disadvantage of using a bus is the limited scalability, since only one processor at a time can do a memory access. To overcome this, we need to assume that processors are slower than memory, or that the processors have cache or other local memory to operate out of. In the latter case, maintaining *cache coherence* is easy with a bus by letting processors listen to all the memory traffic on the bus – a process known as *snooping*.

### 2.8.3 Linear arrays and rings

A simple way to hook up multiple processors is to connect them in a *linear array*: every processor has a number  $i$ , and processor  $P_i$  is connected to  $P_{i-1}$  and  $P_{i+1}$ . The first and last processor are possible exceptions: if they are connected to each other, we call the architecture a *ring network*.

This solution requires each processor to have two network connections, so the design is fairly simple.

**Exercise 2.25.** What is the bisection width of a linear array? Of a ring?

**Exercise 2.26.** With the limited connections of a linear array, you may have to be clever about how to program parallel algorithms. For instance, consider a ‘broadcast’ operation: processor 0 has a data item that needs to be sent to every other processor.

We make the following simplifying assumptions:

- a processor can send any number of messages simultaneously,
- but a wire can carry only one message at a time; however,
- communication between any two processors takes unit time, regardless the number of processors in between them.

In a fully connected network or a star network you can simply write for  $i = 1 \dots N - 1$ :

send the message to processor  $i$

With the assumption that a processor can send multiple messages, this means that the operation is done in one step.

Now consider a linear array. Show that, even with this unlimited capacity for sending, the above algorithm runs into trouble because of congestion.

Find a better way to organize the send operations. Hint: pretend that your processors are connected as a binary tree. Assume that there are  $N = 2^n - 1$  processors. Show that the broadcast can be done in  $\log N$  stages, and that processors only need to be able to send a single message simultaneously.

This exercise is an example of *embedding* a ‘logical’ communication pattern in a physical one.

### 2.8.4 2D and 3D arrays

A popular design for parallel computers is to organize the processors in a two-dimensional or three-dimensional *cartesian mesh*. This means that every processor has a coordinate  $(i, j)$  or  $(i, j, k)$ , and it is

connected to its neighbours in all coordinate directions. The processor design is still fairly simple: the number of network connections (the degree of the connectivity graph) is twice the number of space dimensions (2 or 3) of the network.

It is a fairly natural idea to have 2D or 3D networks, since the world around us is three-dimensional, and computers are often used to model real-life phenomena. If we accept for now that the physical model requires *nearest neighbour* type communications (which we will see is the case in section 4.2.3), then a mesh computer is a natural candidate for running physics simulations.

**Exercise 2.27.** What is the diameter of a 3D cube of  $n \times n \times n$  processors? What is the bisection width? How does that change if you add wraparound torus connections?

**Exercise 2.28.** Your parallel computer has its processors organized in a 2D grid. The chip manufacturer comes out with a new chip with same clock speed that is dual core instead of single core, and that will fit in the existing sockets. Critique the following argument: "the amount work per second that can be done (that does not involve communication) doubles; since the network stays the same, the bisection bandwidth also stays the same, so I can reasonably expect my new machine to become twice as fast<sup>16</sup>."

Grid-based designs often have so-called *wrap-around* or *torus* connections, which connect the left and right sides of a 2D grid, as well as the top and bottom. This is illustrated in figure 2.18.

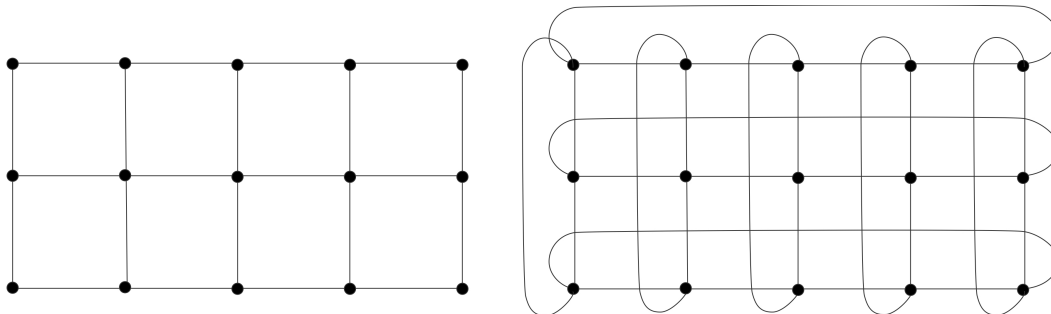

Figure 2.18: A 2D grid with torus connections

Some computer designs claim to be a grid of high dimensionality, for instance 5D, but not all dimensional are equal here. For instance a 3D grid where each *node* is a quad-socket quad-core can be considered as a 5D grid. However, the last two dimensions are fully connected.

### 2.8.5 Hypercubes

Above we gave a hand-waving argument for the suitability of mesh-organized processors, based on the prevalence of nearest neighbour communications. However, sometimes sends and receives between arbitrary processors occur. One example of this is the above-mentioned broadcast. For this reason, it is desirable

16. With the numbers one and two replaced by higher numbers, this is actually not a bad description of current trends in processor design.

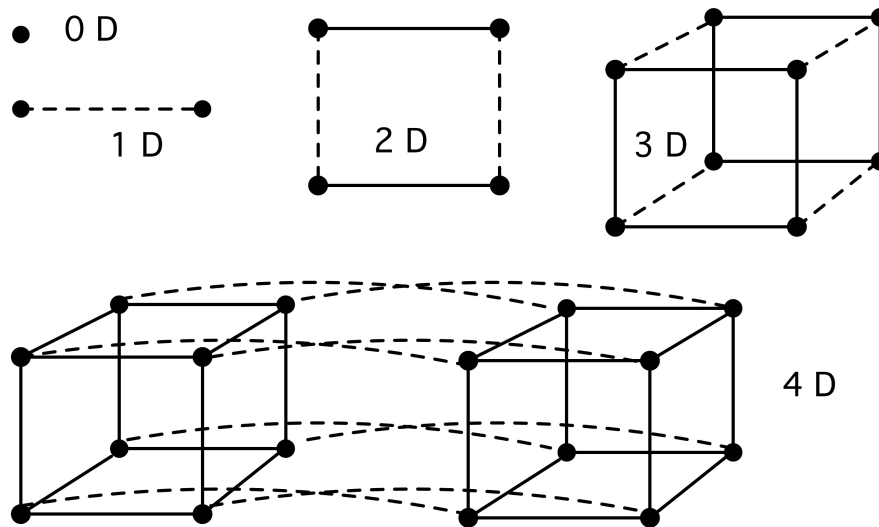

Figure 2.20: Hypercubes

to have a network with a smaller diameter than a mesh. On the other hand we want to avoid the complicated design of a fully connected network.

A good intermediate solution is the *hypercube* design. An  $n$ -dimensional hypercube computer has  $2^n$  processors, with each processor connected to one other in each dimension; see figure 2.20.

An easy way to describe this is to give each processor an address consisting of  $d$  bits: we give each node of a hypercube a number that is the bit pattern describing its location in the cube; see figure 2.19.

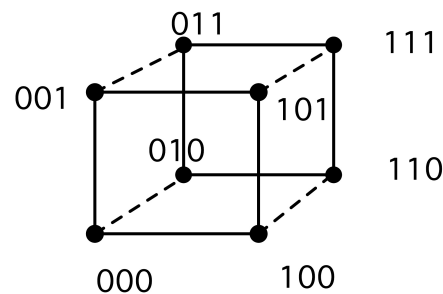

Figure 2.19: Numbering of the nodes of a hypercube

With this numbering scheme, a processor is then connected to all others that have an address that differs by exactly one bit. This means that, unlike in a grid, a processor's neighbours do not have numbers that differ by 1 or  $\sqrt{P}$ , but by 1, 2, 4, 8, ...

The big advantages of a hypercube design are the small diameter and large capacity for traffic through the network.

**Exercise 2.29.** What is the diameter of a hypercube? What is the bisection width?

One disadvantage is the fact that the processor design is dependent on the total machine size. In practice, processors will be designed with a maximum number of possible connections, and someone buying a smaller machine then will be paying for unused capacity. Another disadvantage is the fact that extending a given machine can only be done by doubling it: other sizes than  $2^p$  are not possible.

**Exercise 2.30.** Consider the parallel summing example of section 2.1, and give the execution

time of a parallel implementation on a hypercube. Show that the theoretical speedup from the example is attained (up to a factor) for the implementation on a hypercube.

### 2.8.5.1 Embedding grids in a hypercube

Above we made the argument that mesh-connected processors are a logical choice for many applications that model physical phenomena. Hypercubes do not look like a mesh, but they have enough connections that they can simply pretend to be a mesh by ignoring certain connections.

Let's say that we want the structure of a 1D array: we want processors with a numbering so that processor  $i$  can directly send data to  $i - 1$  and  $i + 1$ . We can not use the obvious numbering of nodes as in figure 2.19. For instance, node 1 is directly connected to node 0, but has a distance of 2 to node 2. The right neighbour of node 3 in a ring, node 4, even has the maximum distance of 3 in this hypercube. Clearly we need to renumber the nodes in some way.

What we will show is that it's possible to walk through a hypercube, touching every corner exactly once, which is equivalent to embedding a 1D mesh in the hypercube.

1D Gray code :	0 1
2D Gray code :	1D code and reflection: 0 1 $\vdots$ 1 0
	append 0 and 1 bit: 0 0 $\vdots$ 1 1
	2D code and reflection: 0 1 1 0 $\vdots$ 0 1 1 0
3D Gray code :	0 0 1 1 $\vdots$ 1 1 0 0
	append 0 and 1 bit: 0 0 0 0 $\vdots$ 1 1 1 1

Figure 2.21: Gray codes

The basic concept here is a (binary reflected) *Gray code* [73]. This is a way of ordering the binary numbers  $0 \dots 2^d - 1$  as  $g_0, \dots, g_{2^d-1}$  so that  $g_i$  and  $g_{i+1}$  differ in only one bit. Clearly, the ordinary binary numbers do not satisfy this: the binary representations for 1 and 2 already differ in two bits. Why do Gray codes help us? Well, since  $g_i$  and  $g_{i+1}$  differ only in one bit, it means they are the numbers of nodes in the hypercube that are directly connected.

Figure 2.21 illustrates how to construct a Gray code. The procedure is recursive, and can be described informally as 'divide the cube into two subcubes, number the one subcube, cross over to the other subcube, and number its nodes in the reverse order of the first one'. The result for a 2D cube is in figure 2.22.

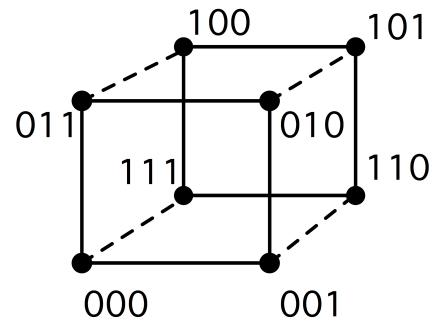

Figure 2.22: Gray code numbering of the nodes of a hypercube

Since a Gray code offers us a way to embed a one-dimensional ‘mesh’ into a hypercube, we can now work our way up.

**Exercise 2.31.** Show how a square mesh of  $2^{2d}$  nodes can be embedded in a hypercube by appending the bit patterns of the embeddings of two  $2^d$  node cubes. How would you accommodate a mesh of  $2^{d_1+d_2}$  nodes? A three-dimensional mesh of  $2^{d_1+d_2+d_3}$  nodes?

### 2.8.6 Switched networks

Above, we briefly discussed fully connected processors. They are impractical if the connection is made by making a large number of wires between all the processors. There is another possibility, however, by connecting all the processors to a *switch* or switching network. Some popular network designs are the *crossbar*, the *butterfly exchange*, and the *fat tree*.

Switching networks are made out of switching elements, each of which have a small number (up to about a dozen) of inbound and outbound links. By hooking all processors up to some switching element, and having multiple stages of switching, it then becomes possible to connect any two processors by a path through the network.

#### 2.8.6.1 Cross bar

The simplest switching network is a cross bar, an arrangement of  $n$  horizontal and vertical lines, with a switch element on each intersection that determines whether the lines are connected; see figure 2.23. If we designate the horizontal lines as inputs the vertical as outputs, this is clearly a way of having  $n$  inputs be mapped to  $n$  outputs. Every combination of inputs and outputs (sometimes called a ‘permutation’) is allowed.

One advantage of this type of network is that no connection blocks another. The main disadvantage is that the number of switching elements is  $n^2$ , a fast growing function of the number of processors  $n$ .

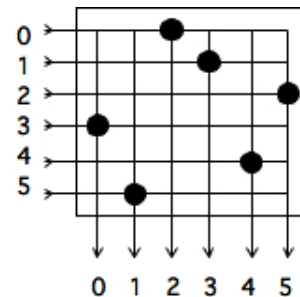

Figure 2.23: A simple cross bar connecting 6 inputs to 6 outputs

#### 2.8.6.2 Butterfly exchange

Butterfly exchanges are typically built out of small switching elements, and they have multiple stages; as the number of processors grows, the number of stages grows with it. Figure 2.24 shows a one-stage butterfly used to implement both shared memory and distributed (or distributed shared) memory, and the extension of the latter to two stages.

As you can see in figure 2.25, butterfly exchanges allow several processors to access memory simultaneously. Also, their access times are identical, so exchange networks are a way of implementing a *UMA* architecture; see section 2.5.1. One computer that was based on a Butterfly exchange network was the *BBN Butterfly*<sup>17</sup>.

---

17. [http://en.wikipedia.org/wiki/BBN\\_Butterfly](http://en.wikipedia.org/wiki/BBN_Butterfly)

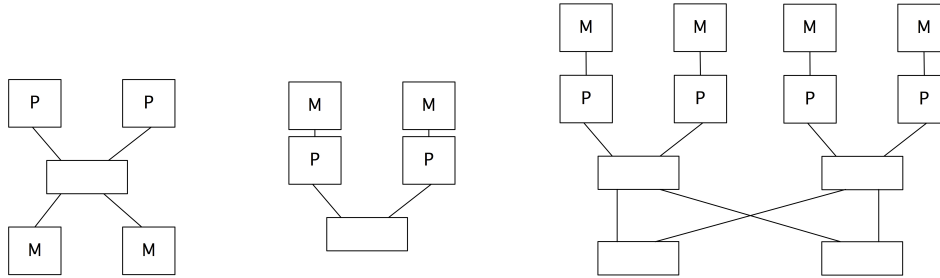

Figure 2.24: A butterfly exchange network for two and four processors/memories

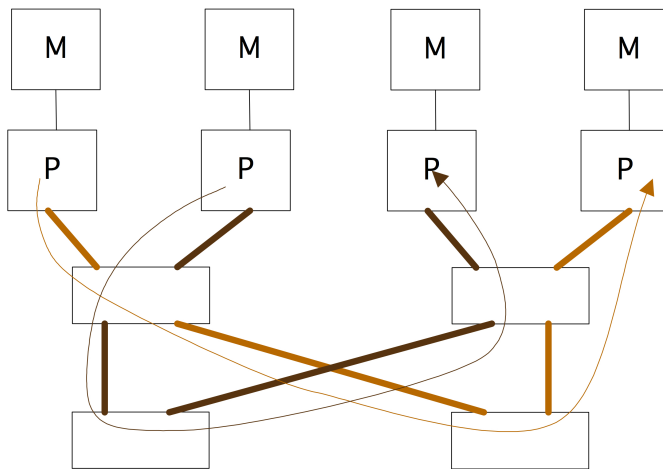

Figure 2.25: Two independent routes through a butterfly exchange network

**Exercise 2.32.** For both the simple cross bar and the butterfly exchange, the network needs to be expanded as the number of processors grows. Give the number of wires (of some unit length) and the number of switching elements that is needed in both cases to connect  $n$  processors and memories. What is the time that a data packet needs to go from memory to processor, expressed in the unit time that it takes to traverse a unit length of wire and the time to traverse a switching element?

Routing through a butterfly network is done based on considering the bits in the destination address. On the  $i$ -th level the  $i$ -th digit is considered; if this is 1, the left exit of the switch is taken, if 0, the right exit. This is illustrated in figure 2.26. If we attach the memories to the processors, as in figure 2.25, we need only two bits (to the last switch) but a further three bits to describe the reverse route.

### 2.8.6.3 Fat-trees

If we were to connect switching nodes like a tree, there would be a big problem with congestion close to the root since there are only two wires attached to the root node. Say we have a  $k$ -level tree, so there are  $2^k$  leaf nodes. If all leaf nodes in the left subtree try to communicate with nodes in the right subtree, we have  $2^{k-1}$  messages going through just one wire into the root, and similarly out through one wire. A fat-tree



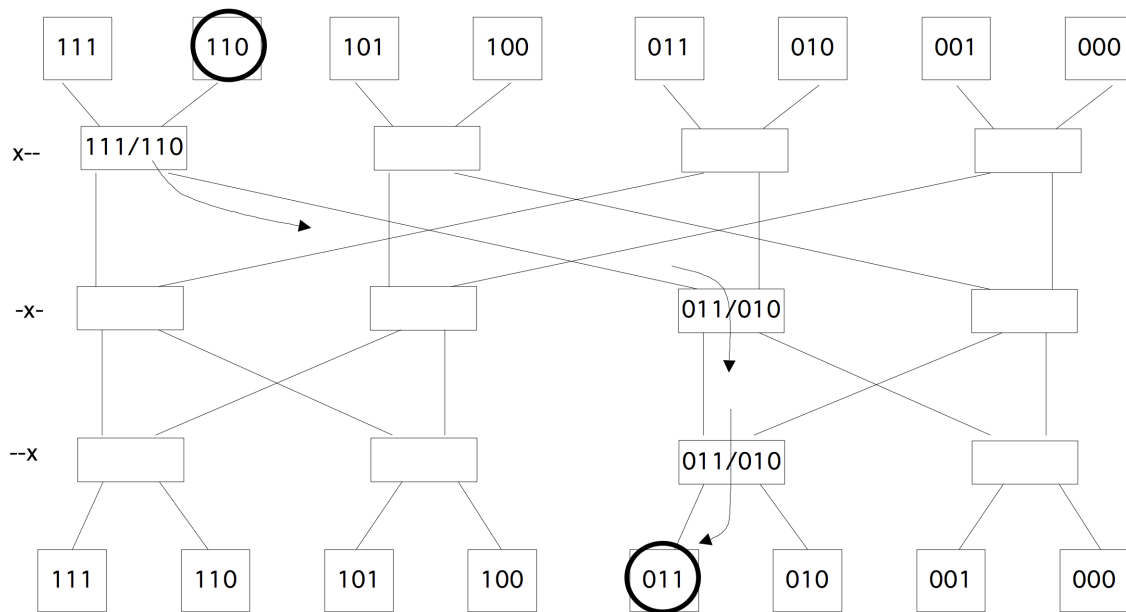

Figure 2.26: Routing through a three-stage butterfly exchange network

is a tree network where each level has the same total bandwidth, so that this congestion problem does not occur: the root will actually have  $2^{k-1}$  incoming and outgoing wires attached [74]. Figure 2.27 shows this structure on the left; on the right is shown a cabinet of the Stampede cluster, with a *leaf switch* for top and bottom half of the cabinet.

The first successful computer architecture based on a fat-tree was the Connection Machines CM5.

In fat-trees, as in other switching networks, each message carries its own routing information. Since in a fat-tree the choices are limited to going up a level, or switching to the other subtree at the current level, a message needs to carry only as many bits routing information as there are levels, which is  $\log_2 n$  for  $n$  processors.

**Exercise 2.33.** Show that the *bisection width* of a fat tree is  $P/2$  where  $P$  is the number of processor leaf nodes. Hint: show that there is only one way of splitting a fat tree-connected set of processors into two connected subsets.

The theoretical exposition of fat-trees in [113] shows that fat-trees are optimal in some sense: it can deliver messages as fast (up to logarithmic factors) as any other network that takes the same amount of space to build. The underlying assumption of this statement is that switches closer to the root have to connect more wires, therefore take more components, and correspondingly are larger. This argument, while theoretically interesting, is of no practical significance, as the physical size of the network hardly plays a role in the biggest currently available computers that use fat-tree interconnect. For instance, in the Ranger supercomputer of The University of Texas at Austin, the fat-tree switch connects 60,000 cores, yet takes less than 10 percent of the floor space.

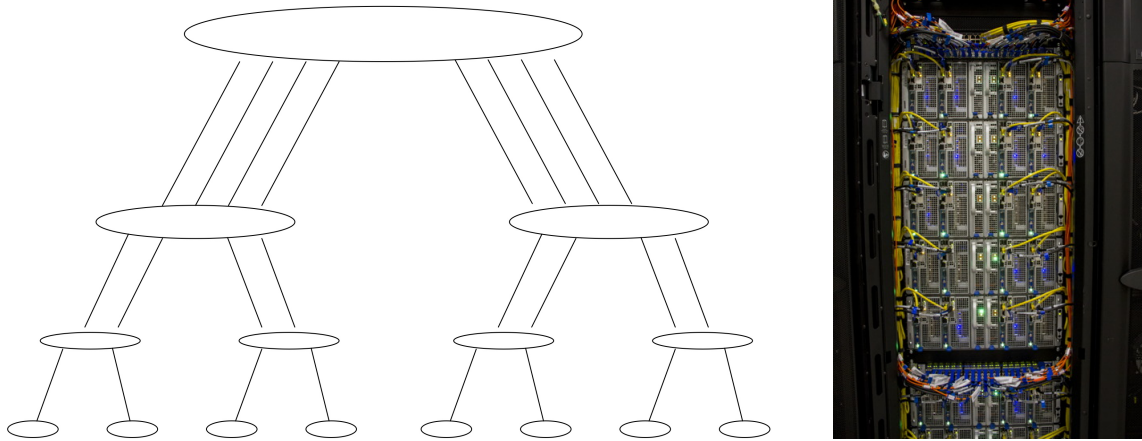

Figure 2.27: A fat tree with a three-level interconnect (left); the leaf switches in a cabinet of the Stampede cluster (right)

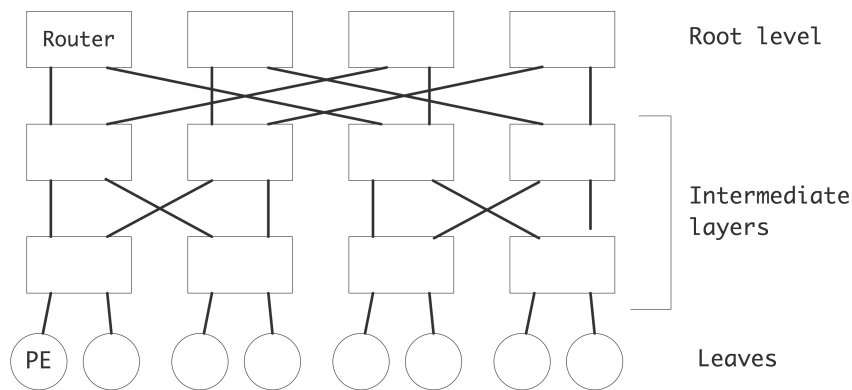

Figure 2.28: A fat-tree built from simple switching elements

A fat tree, as sketched above, would be costly to build, since for every next level a new, bigger, switch would have to be designed. In practice, therefore, a network with the characteristics of a fat-tree is constructed from simple switching elements; see figure 2.28. This network is equivalent in its bandwidth and routing possibilities to a fat-tree. Routing algorithms will be slightly more complicated: in a fat-tree, a data packet can go up in only one way, but here a packet has to know to which of the two higher switches to route.

This type of switching network is one case of a *Clos network* [29].

### 2.8.7 Cluster networks

The above discussion was somewhat abstract, but in real-life clusters you can actually see the network designs reflected. For instance, *fat tree cluster networks* will have a central cabinet corresponding to the top level in the tree. Figure 2.29 shows the switches of the TACC *Ranger* (no longer in service) and *Stampede*



Figure 2.29: Networks switches for the TACC Ranger and Stampede clusters

clusters. In the second picture it can be seen that there are actually multiple redundant fat-tree networks.

On the other hand, clusters such as the *IBM BlueGene*, which is based on a *torus-based cluster*, will look like a collection of identical cabinets, since each contains an identical part of the network; see figure 2.30.

### 2.8.8 Bandwidth and latency

The statement above that sending a message can be considered a unit time operation, is of course unrealistic. A large message will take longer to transmit than a short one. There are two concepts to arrive at a more realistic description of the transmission process; we have already seen this in section 1.3.2 in the context of transferring data between cache levels of a processor.

**latency** Setting up a communication between two processors takes an amount of time that is independent of the message size. The time that this takes is known as the *latency* of a message. There are various causes for this delay.

- The two processors engage in ‘hand-shaking’, to make sure that the recipient is ready, and that appropriate buffer space is available for receiving the message.
- The message needs to be encoded for transmission by the sender, and decoded by the receiver.
- The actual transmission may take time: parallel computers are often big enough that, even at lightspeed, the first byte of a message can take hundreds of cycles to traverse the distance between two processors.



Figure 2.30: A BlueGene computer

**bandwidth** After a transmission between two processors has been initiated, the main number of interest is the number of bytes per second that can go through the channel. This is known as the *bandwidth*. The bandwidth can usually be determined by the *channel rate*, the rate at which a physical link can deliver bits, and the *channel width*, the number of physical wires in a link. The channel width is typically a multiple of 16, usually 64 or 128. This is also expressed by saying that a channel can send one or two 8-byte words simultaneously.

Bandwidth and latency are formalized in the expression

$$T(n) = \alpha + \beta n$$

for the transmission time of an  $n$ -byte message. Here,  $\alpha$  is the latency and  $\beta$  is the time per byte, that is, the inverse of bandwidth. Sometimes we consider data transfers that involve communication, for instance in the case of a *collective operation*; see section 6.1. We then extend the transmission time formula to

$$T(n) = \alpha + \beta n + \gamma n$$

where  $\gamma$  is the time per operation, that is, the inverse of the *computation rate*.

It would also be possible to refine this formulas as

$$T(n, p) = \alpha + \beta n + \delta p$$

where  $p$  is the number of network ‘hops’ that is traversed. However, on most networks the value of  $\delta$  is far lower than of  $\alpha$ , so we will ignore it here. Also, in fat-tree networks (section 2.8.6.3) the number of hops is of the order of  $\log P$ , where  $P$  is the total number of processors, so it can never be very large anyway.

### 2.8.9 Locality in parallel computing

In section 1.5.2 you found a discussion of locality concepts in single-processor computing. The concept of *locality in parallel computing* comprises all this and a few levels more.

**Between cores; private cache** Cores on modern processors have private coherent caches. This means that it looks like you don't have to worry about locality, since data is accessible no matter what cache it is in. However, maintaining coherence costs bandwidth, so it is best to keep access localized.

**Between cores; shared cache** The cache that is shared between cores is one place where you don't have to worry about locality: this is memory that is truly symmetric between the processing cores.

**Between sockets** The sockets on a node (or motherboard) appear to the programmer to have shared memory, but this is really *NUMA* access (section 2.5.2) since the memory is associated with specific sockets.

**Through the network structure** Some networks have clear locality effects. You saw a simple example in section 2.8.1, and in general it is clear that any grid-type network will favour communication between 'nearby' processors. Networks based on fat-trees seem free of such contention issues, but the levels induce a different form of locality. One level higher than the locality on a node, small groups of nodes are often connected by a *leaf switch*, which prevents data from going to the central switch.

### 2.9 Multi-threaded architectures

The architecture of modern CPUs is largely dictated by the fact that getting data from memory is much slower than processing it. Hence, a hierarchy of ever faster and smaller tries to keep data as close to the processing unit as possible, mitigating the long latency and small bandwidth of main memory. The ILP in the processing unit also helps to hide the latency and more fully utilize the available bandwidth.

However, finding ILP is a job for the compiler and there is a limit to what it can practically find. On the other hand, scientific codes are often very *data parallel* in a sense that is obvious to the programmer, though not necessarily to the compiler. Would it be possible for the programmer to specify this parallelism explicitly and for the processor to use it?

In section 2.4.1 you saw that SIMD architectures can be programmed in an explicitly data parallel way. What if we have a great deal of data parallelism but not that many processing units? In that case, we could turn the parallel instruction streams into threads (see section 2.7.1) and have multiple threads be executed on each processing unit. Whenever a thread would stall because of an outstanding memory request, the processor could switch to another thread for which all the necessary inputs are available. This is called *multi-threading*. While it sounds like a way of preventing the processor from waiting for memory, it can also be viewed as a way of keeping memory maximally occupied.

**Exercise 2.34.** If you consider the long latency and limited bandwidth of memory as two separate problems, does multi-threading address them both?

The problem here is that most CPUs are not good at switching quickly between threads. A *context switch* (switching between one thread and another) takes a large number of cycles, comparable to a wait for data from main memory. In a so-called *Multi-Threaded Architecture (MTA)* a context-switch is very efficient,

sometimes as little as a single cycle, which makes it possible for one processor to work on many threads simultaneously.

The multi-threaded concept was explored in the *Tera Computer MTA* machine, which evolved into the current *Cray XMT*<sup>18</sup>.

The other example of an MTA is the GPU, where the processors work as SIMD units, while being themselves multi-threaded; see section 2.10.3.

## 2.10 Co-processors

Current CPUs are built to be moderately efficient at just about any conceivable computation. This implies that by restricting the functionality of a processor it may be possible to raise its efficiency, or lower its power consumption at similar efficiency. Thus, the idea of incorporating a *co-processor* attached to the *host process* has been explored many times. For instance, Intel's 8086 chip, which powered the first generation of IBM PCs, could have a numerical co-processor, the 80287, added to it. This processor was very efficient at transcendental functions and it also incorporated SIMD technology. Using separate functionality for graphics has also been popular, leading to the *SSE* instructions for the x86 processor, and separate GPU units to be attached to the PCI-X bus.

Further examples are the use of co-processors for Digital Signal Processing (DSP) instructions, as well as FPGA boards which can be reconfigured to accommodate specific needs. Early *array processors* such as the *ICL DAP* were also co-processors.

In this section we look briefly at some modern incarnations of this idea, in particular GPUs.

### 2.10.1 A little history

Co-processors can be programmed in two different ways: sometimes it is seamlessly integrated, and certain instructions are automatically executed there, rather than on the 'host' processor. On the other hand, it is also possible that co-processor functions need to be explicitly invoked, and it may even be possible to overlap co-processor functions with host functions. The latter case may sound attractive from an efficiency point of view, but it raises a serious problem of programmability. The programmer now needs to identify explicitly two streams of work: one for the host processor and one for the co-processor.

Some notable parallel machines with co-processors are:

- The *Intel Paragon* (1993) had two processors per node, one for communication and the other for computation. These were in fact identical, the *Intel i860* Intel i860 processor. In a later revision, it became possible to pass data and function pointers to the communication processors.
- The *IBM Roadrunner* at Los Alamos was the first machine to reach a PetaFlop<sup>19</sup>. It achieved this speed through the use of Cell co-processors. Incidentally, the Cell processor is in essence the engine of the Sony Playstation3, showing again the commoditization of supercomputers (section 2.4.3).

18. Tera Computer renamed itself *Cray Inc.* after acquiring *Cray Research* from *SGI*.

19. The *Grape computer* had reached this point earlier, but that was a special purpose machine for molecular dynamics calculations.

- The Chinese *Tianhe-1A* topped the Top 500 list in 2010, reaching about 2.5 PetaFlops through the use of NVidia GPUs.
- The *Tianhe-2* and the *TACC Stampede cluster* use *Intel Xeon Phi* co-processors.

The Roadrunner and Tianhe-1A are examples of co-processors that are very powerful, and that need to be explicitly programmed independently of the host CPU. For instance, code running on the GPUs of the Tianhe-1A is programmed in *CUDA* and compiled separately.

In both cases the programmability problem is further exacerbated by the fact that the co-processor can not directly talk to the network. To send data from one co-processor to another it has to be passed to a host processor, from there through the network to the other host processor, and only then moved to the target co-processor.

### 2.10.2 Bottlenecks

Co-processors often have their own memory, and the *Intel Xeon Phi* can run programs independently, but more often there is the question of how to access the memory of the host processor. A popular solution is to connect the co-processor through a *PCI bus*. Accessing host memory this way is slower than the direct connection that the host processor has. For instance, the *Intel Xeon Phi* has a *bandwidth* of 512-bit wide at 5.5GT per second (we will get to that ‘GT’ in a second), while its connection to host memory is 5.0GT/s, but only 16-bit wide.

**GT measure** We are used to seeing bandwidth measured in gigabits per second. For a *PCI bus* one often see the *GT* measure. This stands for giga-transfer, and it measures how fast the bus can change state between zero and one. Normally, every state transition would correspond to a bit, except that the bus has to provide its own clock information, and if you would send a stream of identical bits the clock would get confused. Therefore, every 8 bits are encoded in 10 bits, to prevent such streams. However, this means that the effective bandwidth is lower than the theoretical number, by a factor of  $4/5$  in this case.

And since manufacturers like to give a positive spin on things, they report the higher number.

### 2.10.3 GPU computing

A *Graphics Processing Unit (GPU)* (or sometimes *General Purpose Graphics Processing Unit (GPGPU)*) is a special purpose processor, designed for fast graphics processing. However, since the operations done for graphics are a form of arithmetic, GPUs have gradually evolved a design that is also useful for non-graphics computing. The general design of a GPU is motivated by the ‘graphics pipeline’: identical operations are performed on many data elements in a form of *data parallelism* (section 2.6.1), and a number of such blocks of data parallelism can be active at the same time.

The basic limitations that hold for a CPU hold for a GPU: accesses to memory incur a long latency. The solution to this problem in a CPU is to introduce levels of cache; in the case of a GPU a different approach is taken (see also section 2.9). GPUs are concerned with *throughput computing*, delivering large amounts of data with high average rates, rather than any single result as quickly as possible. This is made possible by supporting many threads (section 2.7.1) and having very fast switching between them. While one thread is waiting for data from memory, another thread that already has its data can proceed with its computations.

### 2.10.3.1 SIMD-type programming with kernels

Present day GPUs<sup>20</sup> have an architecture that combines SIMD and SPMD parallelism. Threads are not completely independent, but are ordered in *thread blocks*, where all threads in the block execute the same instruction, making the execution SIMD. It is also possible to schedule the same instruction stream (a ‘kernel’ in Cuda terminology) on more than one thread block. In this case, thread blocks can be out of sync, much like processes in an SPMD context. However, since we are dealing with threads here, rather than processes, the term *Single Instruction Multiple Thread (SIMT)* is used.

This software design is apparent in the hardware; for instance, an NVidia GPU has 16–30 Streaming Multiprocessors (SMs), and a SMs consists of 8 Streaming Processors (SPs), which correspond to processor cores; see figure 2.31. The SPs act in true SIMD fashion. The number of cores in a GPU is typically larger than in traditional multi-core processors, but the cores are more limited. Hence, the term *manycore* is used here.

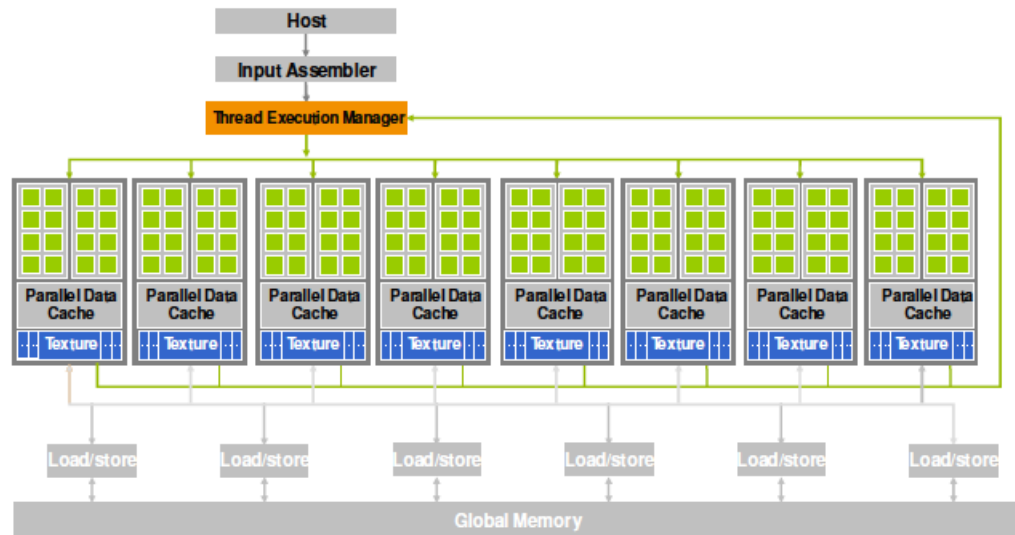

Figure 2.31: Diagram of a GPU

The SIMD, or *data parallel*, nature of GPUs becomes apparent in the way *CUDA* starts processes. A *kernel*, that is, a function that will be executed on the GPU, is started on  $mn$  cores by:

```
KernelProc<< m, n >> (args)
```

The collection of  $mn$  cores executing the kernel is known as a *grid*, and it is structured as  $m$  *thread blocks* of  $n$  threads each. A thread block can have up to 512 threads.

Recall that threads share an address space (see section 2.7.1), so they need a way to identify what part of the data each thread will operate on. For this, the blocks in a thread are numbered with  $x, y$  coordinates, and the threads in a block are numbered with  $x, y, z$  coordinates. Each thread knows its coordinates in the block, and its block’s coordinates in the grid.

20. The most popular GPUs today are made by NVidia, and are programmed in *CUDA*, an extension of the C language.



We illustrate this with a vector addition example:

```
// Each thread performs one addition
__global__ void vecAdd(float* A, float* B, float* C)
{
    int i = threadIdx.x + blockDim.x * blockIdx.x;
    C[i] = A[i] + B[i];
}
int main()
{
    // Run grid of N/256 blocks of 256 threads each
    vecAdd<<< N/256, 256>>>(d_A, d_B, d_C);
}
```

This shows the SIMD nature of GPUs: every thread executes the same scalar program, just on different data.

Threads in a thread block are truly data parallel: if there is a conditional that makes some threads take the *true* branch and others the *false* branch, then one branch will be executed first, with all threads in the other branch stopped. Subsequently, *and not simultaneously*, the threads on the other branch will then execute their code. This may induce a severe performance penalty.

GPUs rely on large amount of data parallelism and the ability to do a fast *context switch*. This means that they will thrive in graphics and scientific applications, where there is lots of data parallelism. However they are unlikely to do well on ‘business applications’ and operating systems, where the parallelism is of the Instruction Level Parallelism (ILP) type, which is usually limited.

### 2.10.3.2 GPUs versus CPUs

These are some of the differences between GPUs and regular CPUs:

- First of all, as of this writing (late 2010), GPUs are attached processors, for instance over a *PCI-X bus*, so any data they operate on has to be transferred from the CPU. Since the memory *bandwidth* of this transfer is low, at least 10 times lower than the memory bandwidth in the GPU, sufficient work has to be done on the GPU to overcome this overhead.
- Since GPUs are graphics processors, they put an emphasis on *single precision* floating point arithmetic. To accomodate the scientific computing community, *double precision* support is increasing, but double precision speed is typically half the single precision flop rate. This discrepancy is likely to be addressed in future generations.
- A CPU is optimized to handle a single stream of instructions that can be very heterogeneous in character; a GPU is made explicitly for data parallelism, and will perform badly on traditional codes.
- A CPU is made to handle one *thread*, or at best a small number of threads. A GPU *needs* a large number of threads, far larger than the number of computational cores, to perform efficiently.

### 2.10.3.3 Expected benefit from GPUs

GPUs have rapidly gained a reputation for achieving high performance, highly cost effectively. Stories abound of codes that were ported with minimal effort to CUDA, with a resulting speedup of sometimes 400 times. Is the GPU really such a miracle machine? Were the original codes badly programmed? Why don't we use GPUs for everything if they are so great?

The truth has several aspects.

First of all, a GPU is not as general-purpose as a regular CPU: GPUs are very good at doing *data parallel* computing, and CUDA is good at expressing this fine-grained parallelism elegantly. In other words, GPUs are suitable for a certain type of computation, and will be a poor fit for many others.

Conversely, a regular CPU is not necessarily good at data parallelism. Unless the code is very carefully written, performance can degrade from optimal by approximately the following factors:

- Unless directives or explicit parallel constructs are used, compiled code will only use 1 out of the available cores, say 4.
- If instructions are not pipelined, the latency because of the floating point pipeline adds another factor of 4.
- If the core has independent add and multiply pipelines, another factor of 2 will be lost if they are not both used simultaneously.
- Failure to use SIMD registers can add more to the slowdown with respect to peak performance.

Writing the optimal CPU implementation of a computational kernel often requires writing in assembler, whereas straightforward CUDA code will achieve high performance with comparatively little effort, provided of course the computation has enough data parallelism.

## 2.10.4 Intel Xeon Phi

Recently, Intel has released a co-processor, the *Intel Xeon Phi* (also known by its architecture design as Many Integrated Cores (MIC)) which is expressly designed for numerical computing. It has both differences and similarities with GPUs.

- Both are connected through a *PCI-X* bus, which means that operations on the device have a considerable latency in starting up.
- The Xeon Phi has general purpose cores, so that it can run whole programs; GPUs has that only to a limited extent (see section 2.10.3.1).
- The Xeon Phi accepts ordinary C code.
- Both architectures require a large amount of SIMD-style parallelism, in the case of the Xeon Phi because of the 8-wide *AVX* instructions.
- Both devices work, or can work, through *offloading* from a host program. In the case of the Xeon Phi this can happen with OpenMP constructs and *MKL* calls.

### 2.11 Remaining topics

#### 2.11.1 Load balancing

In much of this chapter, we assumed that a problem could be perfectly divided over processors, that is, a processor would always be performing useful work, and only be *idle* because of latency in communication. In practice, however, a processor may be idle because it is waiting for a message, and the sending processor has not even reached the send instruction in its code. Such a situation, where one processor is working and another is idle, is described as *load unbalance*: there is no intrinsic reason for the one processor to be idle, and it could have been working if we had distributed the work load differently.

There is an asymmetry between processors having too much work and having not enough work: it is better to have one processor that finishes a task early, than having one that is overloaded so that all others wait for it.

**Exercise 2.35.** Make this notion precise. Suppose a parallel task takes time 1 on all processors but one.

- Let  $0 < \alpha < 1$  and let one processor take time  $1 + \alpha$ . What is the speedup and efficiency as function of the number of processors? Consider this both in the Amdahl and Gustafsson sense (section 2.3.3).
- Answer the same questions if one processor takes time  $1 - \alpha$ .

Load balancing is often expensive since it requires moving relatively large amounts of data. For instance, section 6.5 has an analysis showing that the data exchanges during a sparse matrix-vector product is of a lower order than what is stored on the processor. However, we will not go into the actual cost of moving: our main concerns here are to balance the workload, and to preserve any locality in the original load distribution.

##### 2.11.1.1 Load balancing versus data distribution

There is a duality between work and data: in many applications the distribution of data implies a distribution of work and the other way around. If an application updates a large array, each element of the array typically ‘lives’ on a uniquely determined processor, and that processor takes care of all the updates to that element. This strategy is known as *owner computes*.

Thus, there is a direct relation between data and work, and, correspondingly, data distribution and load balancing go hand in hand. For instance, in section 6.2 we will talk about how data distribution influences the efficiency, but this immediately translates to concerns about load distribution:

- Load needs to be evenly distribution. This can often be done by evenly distributing the data, but sometimes this relation is not linear.
- Tasks need to be placed to minimize the amount of traffic between them. In the matrix-vector multiplication case this means that a two-dimensional distribution is to be preferred over a one-dimensional one; the discussion about *space-filling curves* is similarly motivated.

As a simple example of how the data distribution influences the load balance, consider a linear array where each point undergoes the same computation, and each computation takes the same amount of time. If the length of the array,  $N$ , is perfectly divisible by the number of processors,  $p$ , the work is perfectly evenly distributed. If the data is not evenly divisible, we start by assigning  $\lfloor N/p \rfloor$  points to each processor, and the remaining  $N - p\lfloor N/p \rfloor$  points to the last processors.

**Exercise 2.36.** In the worst case, how unbalanced does that make the processors' work? Compare this scheme to the option of assigning  $\lceil N/p \rceil$  points to all processors except one, which gets fewer; see the exercise above.

It is better to spread the surplus  $r = N - p\lfloor N/p \rfloor$  over  $r$  processors than one. This could be done by giving one extra data point to the first or last  $r$  processors. While this scheme is decently balanced, computing for instance to what processor a given point belongs is tricky. The following scheme makes such computations easier: let  $f(i) = \lfloor iN/p \rfloor$ , then processor  $i$  gets points  $f(i)$  up to  $f(i+1)$ .

**Exercise 2.37.** Show that  $\lfloor N/p \rfloor \leq f(i+1) - f(i) \leq \lceil N/p \rceil$ .

Under this scheme, the processor that owns index  $i$  is  $\lfloor (p(i+1) - 1)/N \rfloor$ .

### 2.11.1.2 Load balancing of independent tasks

In other cases, work load is not directly determined by data. This can happen if there is a pool of work to be done, and the processing time for each work item is not or easily computed from its description. In such cases we may want some flexibility in assigning work to processes.

Let us first consider the case of a job that can be partitioned into independent tasks that do not communicate. An example would be computing the pixels of a *Mandelbrot set* picture, where each pixel is set according to a mathematical function that does not depend on surrounding pixels. If we could predict the time it would take to draw an arbitrary part of the picture, we could make a perfect division of the work and assign it to the processors. This is known as *static load balancing*.

More realistically, we can not predict the running time of a part of the job perfectly, and we use an *overdecomposition* of the work: we divide the work in more tasks than there are processors. These tasks are then assigned to a *work pool*, and processors take the next job from the pool whenever they finish a job. This is known as *dynamic load balancing*. Many graph and combinatorial problems can be approached this way; see section 2.6.3. For task assignment in a multicore context, see section 6.12.

There are results that show that randomized assignment of tasks to processors is statistically close to optimal [96], but this ignores the aspect that in scientific computing tasks typically communicate frequently.

**Exercise 2.38.** Suppose you have tasks  $\{T_i\}_{i=1,\dots,N}$  with running times  $t_i$ , and an unlimited number of processors. Look up *Brent's theorem* in section 2.3.1.2, and derive from it that the fastest execution scheme for the tasks can be characterized as follows: there is one processor that only executes the task with maximal  $t_i$  value.

### 2.11.1.3 Load balancing as graph problem

Next let us consider a parallel job where the parts do communicate. In this case we need to balance both the scalar workload and the communication.

A parallel computation can be formulated as a graph (see Appendix 16 for an introduction to graph theory) where the processors are the vertices, and there is an edge between two vertices if their processors need to communicate at some point. Such a graph is often derived from an underlying graph of the problem being solved. As an example consider the matrix-vector product  $y = Ax$  where  $A$  is a sparse matrix, and look

in detail at the processor that is computing  $y_i$  for some  $i$ . The statement  $y_i \leftarrow y_i + A_{ij}x_j$  implies that this processor will need the value  $x_j$ , so, if this variable is on a different processor, it needs to be sent over.

We can formalize this: Let the vectors  $x$  and  $y$  be distributed disjointly over the processors, and define uniquely  $P(i)$  as the processor that owns index  $i$ . Then there is an edge  $(P, Q)$  if there is a nonzero element  $a_{ij}$  with  $P = P(i)$  and  $Q = P(j)$ . This graph is undirected in the case of a *structurally symmetric matrix*, that is  $a_{ij} \neq 0 \Leftrightarrow a_{ji} \neq 0$ .

The distribution of indices over the processors now gives us vertex and edge weights: a processor has a vertex weight that is the number of indices owned by it; an edge  $(P, Q)$  has a weight that is the number of vector components that need to be sent from  $Q$  to  $P$ , as described above.

The load balancing problem can now be formulated as follows:

Find a partitioning  $\mathbb{P} = \cup_i \mathbb{P}_i$ , such the variation in vertex weights is minimal, and simultaneously the edge weights are as low as possible.

Minimizing the variety in vertex weights implies that all processor have approximately the same amount of work. Keeping the edge weights low means that the amount of communication is low. These two objectives need not be satisfiable at the same time: some trade-off is likely.

**Exercise 2.39.** Consider the limit case where processors are infinitely fast and bandwidth between processors is also unlimited. What is the sole remaining factor determining the runtime? What graph problem do you need to solve now to find the optimal load balance? What property of a sparse matrix gives the worst case behaviour?

An interesting approach to load balancing comes from spectral graph theory (section 16.5): if  $A_G$  is the adjacency matrix of an undirected graph and  $D_G - A_G$  the *graph Laplacian*, then the eigenvector  $u_1$  to the smallest eigenvalue zero is positive, and the eigenvector  $u_2$  to the next eigenvalue is orthogonal to it. Therefore  $u_2$  has to have elements of alternating sign; further analysis shows that the elements with positive sign are connected, as are the negative ones. This leads to a natural bisection of the graph.

### 2.11.1.4 Load redistributing

In certain applications an initial load distribution is clear, but later adjustments are needed. A typical example is in Finite Element Method (FEM) codes, where load can be distributed by a partitioning of the physical domain; see section 6.5.3. If later the discretization of the domain changes, the load has to be *rebalanced* or *redistributed*. In the next subsection we will see one technique for load balancing and rebalancing that is aimed at preserving locality.

### 2.11.1.5 Load balancing with space-filling curves

In the previous sections we considered two aspects of load balancing: making sure all processors have an approximately equal amount of work, and letting the distribution reflect the structure of the problem so that communication is kept within reason. We can phrase the second point trying to preserve the locality of the problem when distributed over a parallel machine: points in space that are close together are likely to interact, so they should be on the same processor, or at least one not too far away.

Striving to preserve locality is not obviously the right strategy. In BSP (see section 2.7.8) a statistical argument is made that *random placement* will give a good load balance as well as balance of communication.

**Exercise 2.40.** Consider the assignment of processes to processors, where the structure of the problem is such that each processes only communicates with its nearest neighbours, and let processors be ordered in a two-dimensional grid. If we do the obvious assignment of the process grid to the processor grid, there will be no contention. Now write a program that assigns processes to random processors, and evaluate how much contention there will be.

In the previous section you saw how graph partitioning techniques can help with the second point of preserving problem locality. In this section you will see a different technique that is attractive both for the initial load assignment and for subsequent *load rebalancing*. In the latter case, a processor's work may increase or decrease, necessitating moving some of the load to a different processor.

For instance, some problems are adaptively refined<sup>21</sup>. This is illustrated in figure 2.32. If we keep track

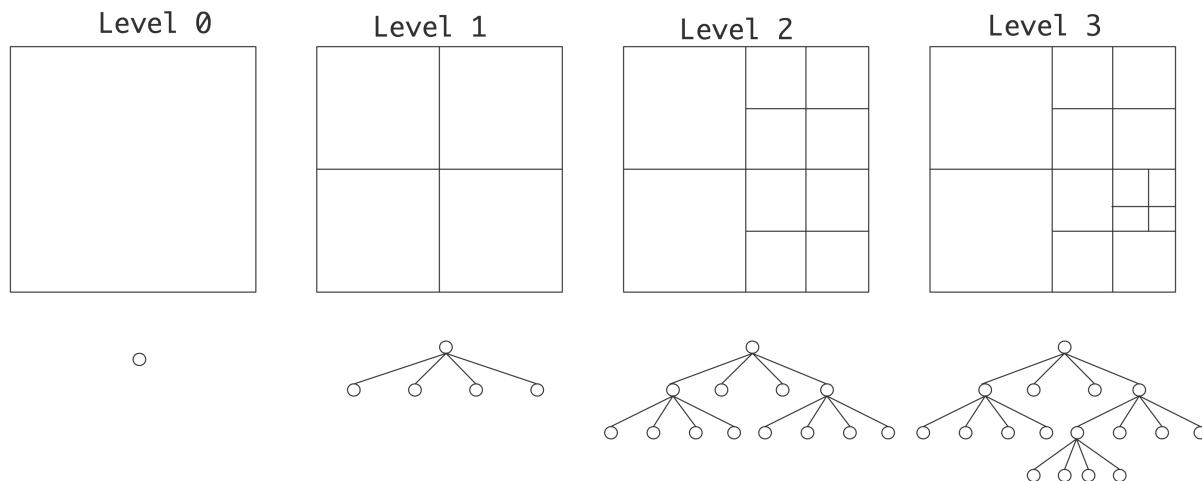

Figure 2.32: Adaptive refinement of a domain in subsequent levels

of these refinement levels, the problem gets a tree structure, where the leaves contain all the work. Load balancing becomes a matter of partitioning the leaves of the tree over the processors; figure 2.33. Now we observe that the problem has a certain locality: the subtrees of any non-leaf node are physically close, so there will probably be communication between them.

- Likely there will be more subdomains than processors; to minimize communication between processors, we want each processor to contain a simply connected group of subdomains. Moreover, we want each processor to cover a part of the domain that is ‘compact’ in the sense that it has low aspect ratio, and low surface-to-volume ratio.
- When a subdomain gets further subdivided, part of the load of its processor may need to be shifted to another processor. This process of *load redistributing* should preserve locality.

To fulfill these requirements we use Space-Filling Curves (SFCs). A Space-Filling Curve (SFC) for the load balanced tree is shown in figure 2.34. We will not give a formal discussion of SFCs; instead we will let

21. For a detailed discussion, see [21].

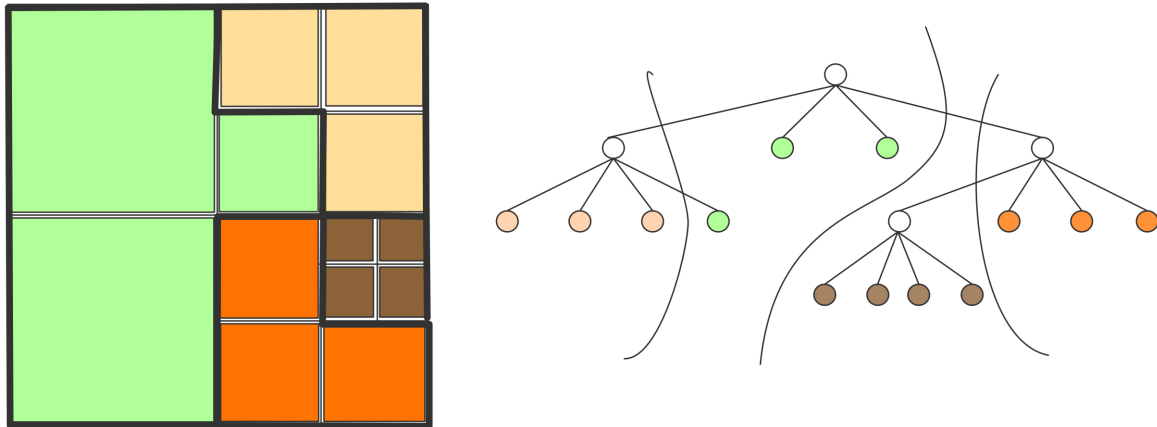

Figure 2.33: Load distribution of an adaptively refined domain

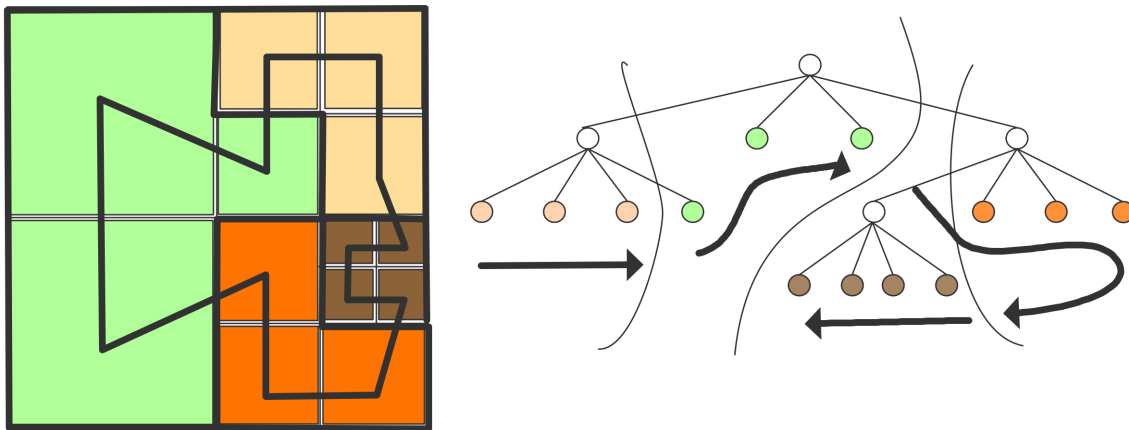

Figure 2.34: A space filling curve for the load balanced tree

figure 2.35 stand for a definition: a SFC is a recursively defined curve that touches each subdomain once<sup>22</sup>. The SFC has the property that domain elements that are close together physically will be close together on the curve, so if we map the SFC to a linear ordering of processors we will preserve the locality of the problem.

More importantly, if the domain is refined by another level, we can refine the curve accordingly. Load can then be redistributed to neighbouring processors on the curve, and we will still have locality preserved.

22. Space-Filling Curves (SFCs) were introduced by Peano as a mathematical device for constructing a continuous surjective function from the line segment  $[0, 1]$  to a higher dimensional cube  $[0, 1]^d$ . This upset the intuitive notion of dimension that ‘you can not stretch and fold a line segment to fill up the square’. A proper treatment of the concept of dimension was later given by Brouwer.

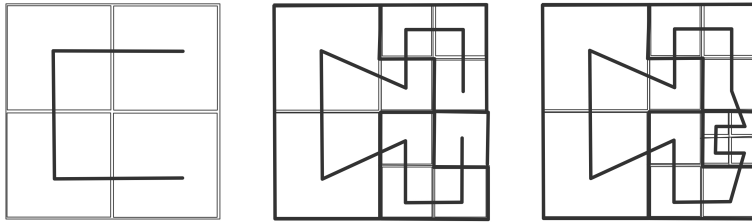

Figure 2.35: Space filling curves, regularly and irregularly refined

### 2.11.2 Distributed computing, grid computing, cloud computing

In this section we will take a short look at terms such as *cloud computing*, and an earlier term *distributed computing*. These are concepts that have a relation to parallel computing in the scientific sense, but that differ in certain fundamental ways.

Distributed computing can be traced back as coming from large database servers, such as airline reservations systems, which had to be accessed by many travel agents simultaneously. For a large enough volume of database accesses a single server will not suffice, so the mechanism of *remote procedure call* was invented, where the central server would call code (the procedure in question) on a different (remote) machine. The remote call could involve transfer of data, the data could be already on the remote machine, or there would be some mechanism that data on the two machines would stay synchronized. This gave rise to the *Storage Area Network (SAN)*. A generation later than distributed database systems, web servers had to deal with the same problem of many simultaneous accesses to what had to act like a single server.

We already see one big difference between distributed computing and high performance parallel computing. Scientific computing needs parallelism because a single simulation becomes too big or slow for one machine; the business applications sketched above deal with many users executing small programs (that is, database or web queries) against a large data set. For scientific needs, the processors of a parallel machine (the nodes in a cluster) have to have a very fast connection to each other; for business needs no such network is needed, as long as the central dataset stays coherent.

Both in *HPC* and in business computing, the server has to stay available and operative, but in distributed computing there is considerably more liberty in how to realize this. For a user connecting to a service such as a database, it does not matter what actual server executes their request. Therefore, distributed computing can make use of *virtualization*: a virtual server can be spawned off on any piece of hardware.

An analogy can be made between remote servers, which supply computing power wherever it is needed, and the electric grid, which supplies electric power wherever it is needed. This has led to *grid computing* or *utility computing*, with the Teragrid, owned by the US National Science Foundation, as an example. Grid computing was originally intended as a way of hooking up computers connected by a *Local Area Network (LAN)* or *Wide Area Network (WAN)*, often the Internet. The machines could be parallel themselves, and were often owned by different institutions. More recently, it has been viewed as a way of sharing resources, both datasets, software resources, and scientific instruments, over the network.

The notion of utility computing as a way of making services available, which you recognize from the above description of distributed computing, went mainstream with Google's search engine, which indexes the



whole of the Internet. Another example is the GPS capability of Android mobile phones, which combines GIS, GPS, and mashup data. The computing model by which Google's gathers and processes data has been formalized in MapReduce [33]. It combines a data parallel aspect (the 'map' part) and a central accumulation part ('reduce'). Neither involves the tightly coupled neighbour-to-neighbour communication that is common in scientific computing. An open source framework for MapReduce computing exists in Hadoop [78]. Amazon offers a commercial Hadoop service.

The concept of having a remote computer serve user needs is attractive even if no large datasets are involved, since it absolves the user from the need of maintaining software on their local machine. Thus, Google Docs offers various 'office' applications without the user actually installing any software. This idea is sometimes called *Software As a Service (SAS)*, where the user connects to an 'application server', and accesses it through a client such as a web browser. In the case of Google Docs, there is no longer a large central dataset, but each user interacts with their own data, maintained on Google's servers. This of course has the large advantage that the data is available from anywhere the user has access to a web browser.

The SAS concept has several connections to earlier technologies. For instance, after the mainframe and workstation eras, the so-called *thin client* idea was briefly popular. Here, the user would have a workstation rather than a terminal, yet work on data stored on a central server. One product along these lines was Sun's *Sun Ray* (circa 1999) where users relied on a smartcard to establish their local environment on an arbitrary, otherwise stateless, workstation.

### 2.11.2.1 Usage scenarios

The model where services are available on demand is attractive for businesses, which increasingly are using cloud services. The advantages are that it requires no initial monetary and time investment, and that no decisions about type and size of equipment have to be made. At the moment, cloud services are mostly focused on databases and office applications, but scientific clouds with a high performance interconnect are under development.

The following is a broad classification of usage scenarios of cloud resources<sup>23</sup>.

- **Scaling.** Here the cloud resources are used as a platform that can be expanded based on user demand. This can be considered Platform-as-a-Service (PAS): the cloud provides software and development platforms, eliminating the administration and maintenance for the user. We can distinguish between two cases: if the user is running single jobs and is actively waiting for the output, resources can be added to minimize the wait time for these jobs (capability computing). On the other hand, if the user is submitting jobs to a queue and the time-to-completion of any given job is not crucial (capacity computing), resources can be added as the queue grows. In HPC applications, users can consider the cloud resources as a cluster; this falls under Infrastructure-as-a-Service (IAS): the cloud service is a computing platforms allowing customization at the operating system level.
- **Multi-tenancy.** Here the same software is offered to multiple users, giving each the opportunity for individual customizations. This falls under Software-as-a-Service (SAS): software is provided on demand; the customer does not purchase software, but only pays for its use.

---

23. Based on a blog post by Ricky Ho: <http://blogs.globallogic.com/five-cloud-computing-patterns>.

- **Batch processing.** This is a limited version of one of the Scaling scenarios above: the user has a large amount of data to process in batch mode. The cloud then becomes a batch processor. This model is a good candidate for MapReduce computations; section 2.11.4.
- **Storage.** Most cloud providers offer database services, so this model absolves the user from maintaining their own database, just like the Scaling and Batch processing models take away the user's concern with maintaining cluster hardware.
- **Synchronization.** This model is popular for commercial user applications. Netflix and Amazon's Kindle allow users to consume online content (streaming movies and ebooks respectively); after pausing the content they can resume from any other platform. Apple's recent iCloud provides synchronization for data in office applications, but unlike Google Docs the applications are not 'in the cloud' but on the user machine.

The first Cloud to be publicly accessible was Amazon's Elastic Compute cloud (EC2), launched in 2006. EC2 offers a variety of different computing platforms and storage facilities. Nowadays more than a hundred companies provide cloud based services, well beyond the initial concept of computers-for-rent.

The infrastructure for cloud computing can be interesting from a computer science point of view, involving distributed file systems, scheduling, virtualization, and mechanisms for ensuring high reliability.

An interesting project, combining aspects of grid and cloud computing is the Canadian Advanced Network For Astronomical Research[144]. Here large central datasets are being made available to astronomers as in a grid, together with compute resources to perform analysis on them, in a cloud-like manner. Interestingly, the cloud resources even take the form of user-configurable virtual clusters.

### 2.11.2.2 Characterization

Summarizing<sup>24</sup> we have three *cloud computing service models*:

**Software as a Service** The consumer runs the provider's application, typically through a thin client such as a browser; the consumer does not install or administer software. A good example is Google Docs

**Platform as a Service** The service offered to the consumer is the capability to run applications developed by the consumer, who does not otherwise manage the processing platform or data storage involved.

**Infrastructure as a Service** The provider offers to the consumer both the capability to run software, and to manage storage and networks. The consumer can be in charge of operating system choice and network components such as firewalls.

These can be deployed as follows:

**Private cloud** The cloud infrastructure is managed by one organization for its own exclusive use.

**Public cloud** The cloud infrastructure is managed for use by a broad customer base.

One could also define hybrid models such as community clouds.

The characteristics of cloud computing are then:

24. The remainder of this section is based on the NIST definition of cloud computing <http://csrc.nist.gov/publications/nistpubs/800-145/SP800-145.pdf>.

**On-demand and self service** The consumer can quickly request services and change service levels, without requiring human interaction with the provider.

**Rapid elasticity** The amount of storage or computing power appears to the consumer to be unlimited, subject only to budgeting constraints. Requesting extra facilities is fast, in some cases automatic.

**Resource pooling** Virtualization mechanisms make a cloud appear like a single entity, regardless its underlying infrastructure. In some cases the cloud remembers the ‘state’ of user access; for instance, Amazon’s Kindle books allow one to read the same book on a PC, and a smartphone; the cloud-stored book ‘remembers’ where the reader left off, regardless the platform.

**Network access** Clouds are available through a variety of network mechanisms, from web browsers to dedicated portals.

**Measured service** Cloud services are typically ‘metered’, with the consumer paying for computing time, storage, and bandwidth.

### 2.11.3 Capability versus capacity computing

Large parallel computers can be used in two different ways. In later chapters you will see how scientific problems can be scaled up almost arbitrarily. This means that with an increasing need for accuracy or scale, increasingly large computers are needed. The use of a whole machine for a single problem, with only time-to-solution as the measure of success, is known as *capability computing*.

On the other hand, many problems need less than a whole supercomputer to solve, so typically a computing center will set up a machine so that it serves a continuous stream of user problems, each smaller than the full machine. In this mode, the measure of success is the sustained performance per unit cost. This is known as *capacity computing*, and it requires a finely tuned *job scheduling* strategy.

A popular scheme is *fair-share scheduling*, which tries to allocate resources equally between users, rather than between processes. This means that it will lower a user’s priority if the user had recent jobs, and it will give higher priority to short or small jobs. Examples of schedulers on this principle are *SGE* and *Slurm*.

Jobs can have dependencies, which makes scheduling harder. In fact, under many realistic conditions scheduling problems are *NP-complete*, so in practice heuristics will be used. This topic, while interesting, is not further discussed in this book.

### 2.11.4 MapReduce

MapReduce [33] is a programming model for certain parallel operations. One of its distinguishing characteristics is that it is implemented using *functional programming*. The MapReduce model handles computations of the following form:

- For all available data, select items that satisfy a certain criterion;
- and emit a key-value pair for them. This is the mapping stage.
- Optionally there can be a combine/sort stage where all pairs with the same key value are grouped together.
- Then do a global reduction on the keys, yielding one or more of the corresponding values. This is the reduction stage.

We will now give a few examples of using MapReduce, and present the functional programming model that underlies the MapReduce abstraction.

#### 2.11.4.1 Expressive power of the MapReduce model

The reduce part of the MapReduce model makes it a prime candidate for computing global statistics on a dataset. One example would be to count how many times each of a set of words appears in some set of documents. The function being mapped knows the set of words, and outputs for each document a pair of document name and a list with the occurrence counts of the words. The reduction then does a component-wise sum of the occurrence counts.

The combine stage of MapReduce makes it possible to transform data. An example is a ‘Reverse Web-Link Graph’: the map function outputs target-source pairs for each link to a target URL found in a page named “source”. The reduce function concatenates the list of all source URLs associated with a given target URL and emits the pair target-list(source).

A less obvious example is computing PageRank (section 9.3) with MapReduce. Here we use the fact that the PageRank computation relies on a distributed sparse matrix-vector product. Each web page corresponds to a column of the web matrix  $W$ ; given a probability  $p_j$  of being on page  $j$ , that page can then compute tuples  $\langle i, w_{ij}p_j \rangle$ . The combine stage of MapReduce then sums together  $(Wp)_i = \sum_j w_{ij}p_j$ .

Database operations can be implemented with MapReduce but since it has a relatively large latency, it is unlikely to be competitive with standalone databases, which are optimized for fast processing of a single query, rather than bulk statistics. For other applications see <http://horicky.blogspot.com/2010/08/designing-algorithmis-for-map-reduce.html>.

#### 2.11.4.2 Mapreduce software

The implementation of MapReduce by Google was released under the name *Hadoop*. While it suited the Google model of single-stage reading and processing of data, it had considerable disadvantages for many other users:

- Hadoop would flush all its data back to disc after each MapReduce cycle, so for operations that take more than a single cycle the file system and bandwidth demands are too great.
- In computing center environments, where a user’s data is not continuously online, the time required for loading data into *Hadoop File System (HDFS)* would like overwhelm the actual analysis.

For these reasons, further projects such as Apache *Spark* (<https://spark.apache.org/>) offer caching of data.

#### 2.11.4.3 Functional programming

The mapping and reduction operations are easily implemented on any type of parallel architecture, using a combination of threading and message passing. However, at Google where this model was developed traditional parallelism was not attractive for two reasons. First of all, processors could fail during the computation, so a traditional model of parallelism would have to be enhanced with *fault tolerance* mechanisms. Secondly, the computing hardware could already have a load, so parts of the computation may need to be migrated, and in general any type of synchronization between tasks would be very hard.

MapReduce is one way to abstract from such details of parallel computing, namely through adopting a functional programming model. In such a model the only operation is the evaluation of a function, applied to some arguments, where the arguments are themselves the result of a function application, and the result of the computation is again used as argument for another function application. In particular, in a strict functional model there are no variables, so there is no static data.

A function application, written in *Lisp* style as `(f a b)` (meaning that the function `f` is applied to arguments `a` and `b`) would then be executed by collecting the inputs from wherever they are to the processor that evaluates the function `f`. The mapping stage of a MapReduce process is denoted

```
(map f (some list of arguments))
```

and the result is a list of the function results of applying `f` to the input list. All details of parallelism and of guaranteeing that the computation successfully finishes are handled by the `map` function.

Now we are only missing the reduction stage, which is just as simple:

```
(reduce g (map f (the list of inputs)))
```

The `reduce` function takes a list of inputs and performs a reduction on it.

The attractiveness of this functional model lies in the fact that functions can not have *side effects*: because they can only yield a single output result, they can not change their environment, and hence there is no coordination problem of multiple tasks accessing the same data.

Thus, MapReduce is a useful abstraction for programmers dealing with large amounts of data. Of course, on an implementation level the MapReduce software uses familiar concepts such as decomposing the data space, keeping a work list, assigning tasks to processors, retrying failed operations, et cetera.

### 2.11.5 The top500 list

There are several informal ways of measuring just ‘how big’ a computer is. The most popular is the TOP500 list, maintained at <http://www.top500.org/>, which records a computer’s performance on the *Linpack benchmark*. *Linpack* is a package for linear algebra operations, and no longer in use, since it has been superseded by *Lapack* for shared memory and *Scalapack* for distributed memory computers. The benchmark operation is the solution of a (square, nonsingular, dense) linear system through LU factorization with partial pivoting, with subsequent forward and backward solution.

The LU factorization operation is one that has great opportunity for cache reuse, since it is based on the matrix-matrix multiplication kernel discussed in section 1.5.1. It also has the property that the amount of work outweighs the amount of communication:  $O(n^3)$  versus  $O(n^2)$ . As a result, the Linpack benchmark is likely to run at a substantial fraction of the peak speed of the machine. Another way of phrasing this is to say that the Linpack benchmark is a *CPU-bound* or *compute-bound* algorithm.

Typical efficiency figures are between 60 and 90 percent. However, it should be noted that many scientific codes do not feature the dense linear solution kernel, so the performance on this benchmark is not indicative of the performance on a typical code. Linear system solution through iterative methods (section 5.5), for

instance, is much less efficient in a flops-per-second sense, being dominated by the bandwidth between CPU and memory (a *bandwidth bound algorithm*).

One implementation of the Linpack benchmark that is often used is ‘High-Performance LINPACK’ (<http://www.netlib.org/benchmark/hpl/>), which has several parameters such as blocksize that can be chosen to tune the performance.

### 2.11.5.1 The top500 list as a recent history of supercomputing

The top500 list offers a history of almost 20 years of supercomputing. In this section we will take a brief look at historical developments<sup>25</sup>. First of all, figure 2.36 shows the evolution of architecture types by

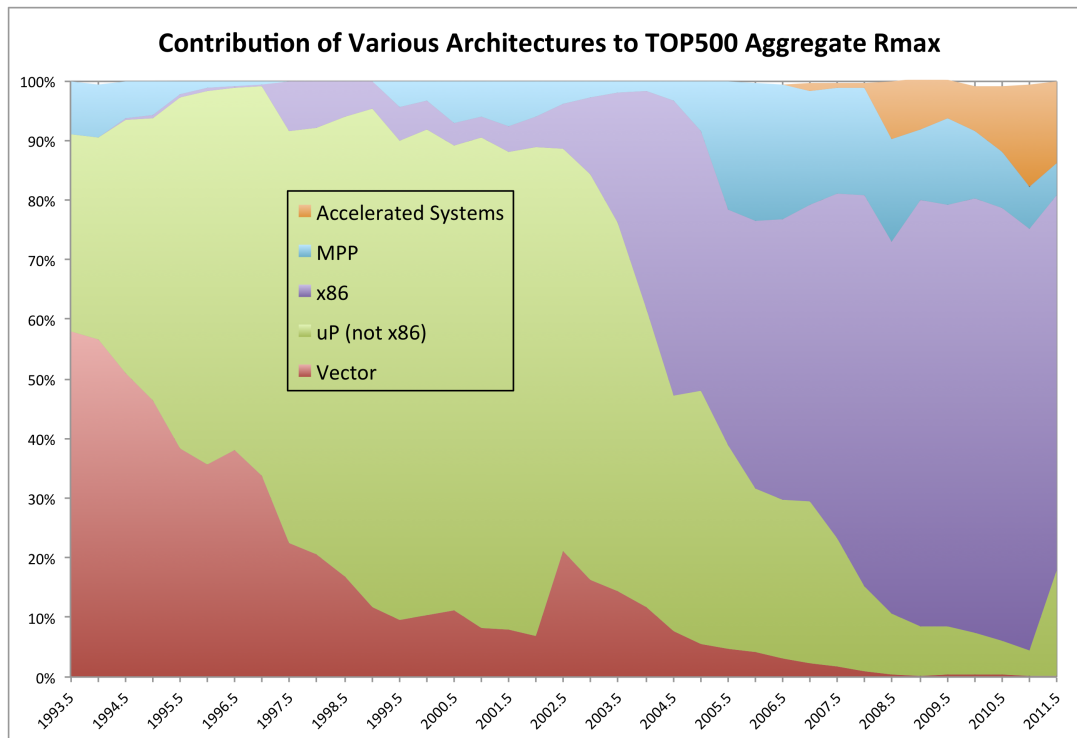

Figure 2.36: Evolution of the architecture types on the top500 list

charting what portion of the aggregate peak performance of the whole list is due to each type.

- Vector machines feature a relatively small number of very powerful vector pipeline processors (section 2.4.1.1). This type of architecture has largely disappeared; the last major machine of this type was the Japanese *Earth Simulator* which is seen as the spike in the graph around 2002, and which was at the top of the list for two years.
- Micro-processor based architectures get their power from the large number of processors in one machine. The graph distinguishes between *x86* (*Intel* and *AMD* processors with the exception of the *Intel Itanium*) processors and others; see also the next graph.

25. The graphs contain John McCalpin’s analysis of the top500 data.

## 2. Parallel Computing

- A number of systems were designed as highly scalable architectures: these are denoted MPP for ‘massively parallel processor’. In the early part of the timeline this includes architectures such as the *Connection Machine*, later it is almost exclusively the *IBM BlueGene*.
- In recent years ‘accelerated systems’ are the upcoming trend. Here, a processing unit such as a *GPU* is attached to the networked main processor.

Next, figure 2.37 shows the dominance of the x86 processor type relative to other micro-processors. (Since

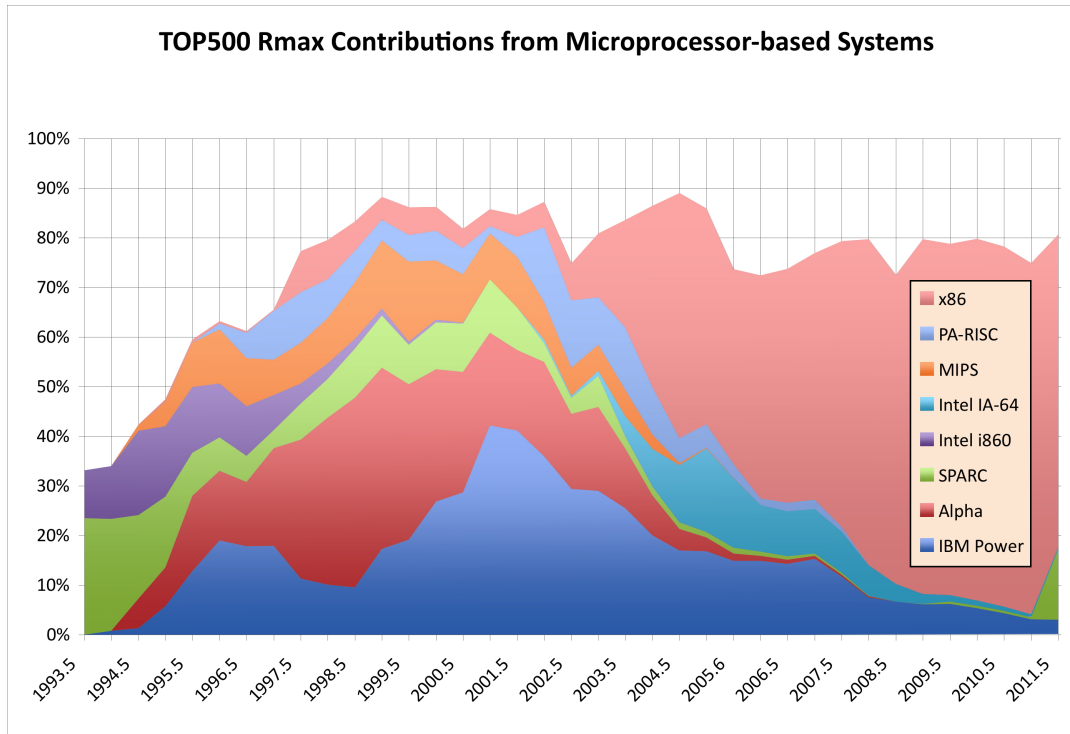

Figure 2.37: Evolution of the architecture types on the top500 list

we classified the *IBM BlueGene* as an MPP, its processors are not in the ‘Power’ category here.)

Finally, figure 2.38 shows the gradual increase in core count. Here we can make the following observations:

- In the 1990s many processors consisted of more than one chip. In the rest of the graph, we count the number of cores per ‘package’, that is, per *socket*. In some cases a socket can actually contain two separate dies.
- With the advent of multi-core processors, it is remarkable how close to vertical the section in the graph are. This means that new processor types are very quickly adopted, and the lower core counts equally quickly completely disappear.
- For accelerated systems (mostly systems with GPUs) the concept of ‘core count’ is harder to define; the graph merely shows the increasing importance of this type of architecture.

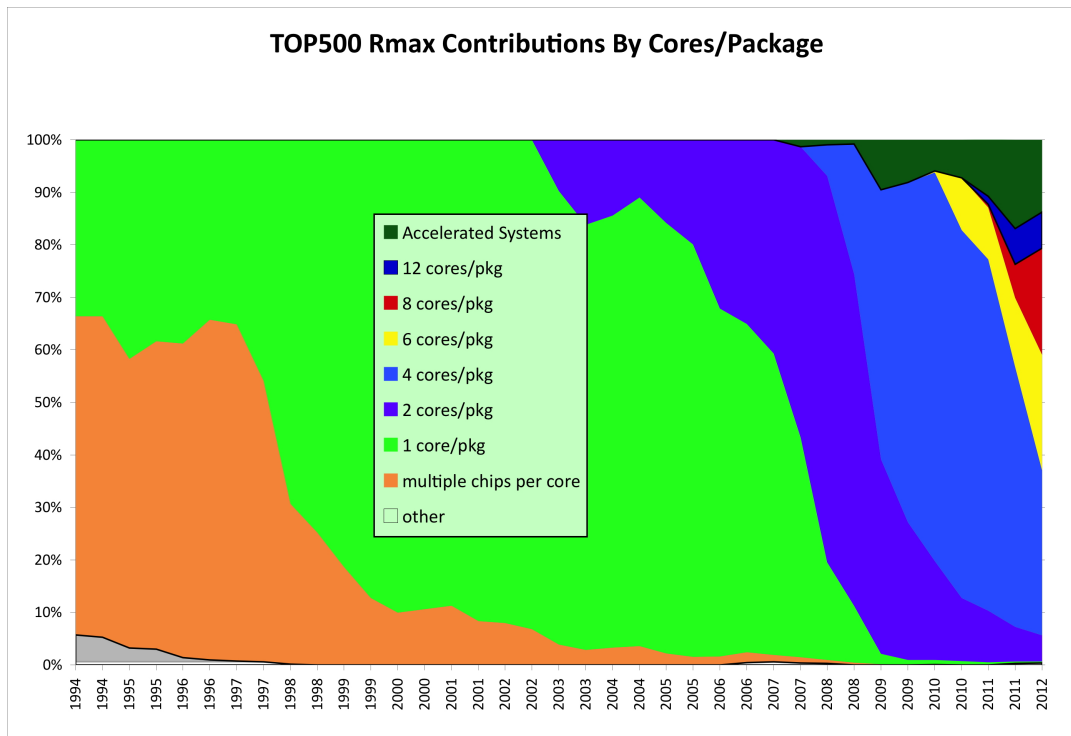

Figure 2.38: Evolution of the architecture types on the top500 list

### 2.11.6 Heterogeneous computing

You have now seen several computing models: single core, shared memory multicore, distributed memory clusters, GPUs. These models all have in common that, if there is more than one instruction stream active, all streams are interchangeable. With regard to GPUs we need to refine this statement: all instruction stream *on the GPU* are interchangeable. However, a GPU is not a standalone device, but can be considered a *co-processor* to a *host processor*.

If we want to let the host perform useful work while the co-processor is active, we now have two different instruction streams or types of streams. This situation is known as *heterogeneous computing*. In the GPU case, these instruction streams are even programmed by a slightly different mechanisms – using *CUDA* for the GPU – but this need not be the case: the Intel Many Integrated Cores (MIC) architecture is programmed in ordinary C.



## Chapter 3

### Computer Arithmetic

Of the various types of data that one normally encounters, the ones we are concerned with in the context of scientific computing are the numerical types: integers (or whole numbers)  $\dots, -2, -1, 0, 1, 2, \dots$ , real numbers  $0, 1, -1.5, 2/3, \sqrt{2}, \log 10, \dots$ , and complex numbers  $1 + 2i, \sqrt{3} - \sqrt{5}i, \dots$ . Computer memory is organized to give only a certain amount of space to represent each number, in multiples of *bytes*, each containing 8 *bits*. Typical values are 4 bytes for an integer, 4 or 8 bytes for a real number, and 8 or 16 bytes for a complex number.

Since only a certain amount of memory is available to store a number, it is clear that not all numbers of a certain type can be stored. For instance, for integers only a range is stored. In the case of real numbers, even storing a range is not possible since any interval  $[a, b]$  contains infinitely many numbers. Therefore, any *representation of real numbers* will cause gaps between the numbers that are stored. Calculations in a computer are sometimes described as *finite precision arithmetic*. Since many results are not representible, any computation that results in such a number will have to be dealt with by issuing an error or by approximating the result. In this chapter we will look at the ramifications of such approximations of the ‘true’ outcome of numerical calculations.

For detailed discussions, see the book by Overton [132]; it is easy to find online copies of the essay by Goldberg [68]. For extensive discussions of round-off error analysis in algorithms, see the books by Higham [86] and Wilkinson [164].

#### 3.1 Integers

In scientific computing, most operations are on real numbers. Computations on integers rarely add up to any serious computation load<sup>1</sup>. It is mostly for completeness that we start with a short discussion of integers.

Integers are commonly stored in 16, 32, or 64 bits, with 16 becoming less common and 64 becoming more and more so. The main reason for this increase is not the changing nature of computations, but the fact that integers are used to index arrays. As the size of data sets grows (in particular in parallel computations), larger indices are needed. For instance, in 32 bits one can store the numbers zero through  $2^{32} - 1 \approx 4 \cdot 10^9$ .

---

1. Some computations are done on bit strings. We will not mention them at all.

In other words, a 32 bit index can address 4 gigabytes of memory. Until recently this was enough for most purposes; these days the need for larger data sets has made 64 bit indexing necessary.

When we are indexing an array, only positive integers are needed. In general integer computations, of course, we need to accommodate the negative integers too. We will now discuss several strategies for implementing negative integers. Our motivation here will be that arithmetic on positive and negative integers should be as simple as on positive integers only: the circuitry that we have for comparing and operating on bitstrings should be usable for (signed) integers.

There are several ways of implementing negative integers. The simplest solution is to reserve one bit as a *sign bit*, and use the remaining 31 (or 15 or 63; from now on we will consider 32 bits the standard) bits to store the absolute magnitude. By comparison, we will call the straightforward interpretation of bitstring *unsigned* integers.

bitstring	00...0	...	01...1	10...0	...	11...1
interpretation as unsigned int	0	...	$2^{31} - 1$	$2^{31}$	...	$2^{32} - 1$
interpretation as signed integer	0	...	$2^{31} - 1$	-0	...	$-(2^{31} - 1)$

This scheme has some disadvantages, one being that there is both a positive and negative number zero. This means that a test for equality becomes more complicated than simply testing for equality as a bitstring. More importantly, in the second half of the bitstrings, the interpretation as signed integer *decreases*, going to the right. This means that a test for greater-than becomes complex; also adding a positive number to a negative number now has to be treated differently from adding it to a positive number.

Another solution would be to let an unsigned number  $n$  be interpreted as  $n - B$  where  $B$  is some plausible base, for instance  $2^{31}$ .

bitstring	00...0	...	01...1	10...0	...	11...1
interpretation as unsigned int	0	...	$2^{31} - 1$	$2^{31}$	...	$2^{32} - 1$
interpretation as shifted int	$-2^{31}$	...	-1	0	...	$2^{31} - 1$

This shifted scheme does not suffer from the  $\pm 0$  problem, and numbers are consistently ordered. However, if we compute  $n - n$  by operating on the bitstring that represents  $n$ , we do not get the bitstring for zero. To get we rotate the number line to put the pattern for zero back at zero.

The resulting scheme, which is the one that is used most commonly, is called *2's complement*. Using this scheme, the representation of integers is formally defined as follows.

- If  $0 \leq m \leq 2^{31} - 1$ , the normal bit pattern for  $m$  is used.
- For  $-2^{31} \leq n \leq -1$ ,  $n$  is represented by the bit pattern for  $2^{32} - |n|$ .

The following diagram shows the correspondence between bitstrings and their interpretation as 2's complement integer:

bitstring	00...0	...	01...1	10...0	...	11...1
interpretation as unsigned int	0	...	$2^{31} - 1$	$2^{31}$	...	$2^{32} - 1$
interpretation as 2's comp. integer	0	...	$2^{31} - 1$	$-2^{31}$	...	-1

Some observations:

- There is no overlap between the bit patterns for positive and negative integers, in particular, there is only one pattern for zero.
- The positive numbers have a leading bit zero, the negative numbers have the leading bit set.

**Exercise 3.1.** For the ‘naive’ scheme and the 2’s complement scheme for negative numbers, give pseudocode for the comparison test  $m < n$ , where  $m$  and  $n$  are integers. Be careful to distinguish between all cases of  $m, n$  positive, zero, or negative.

Adding two numbers with the same sign, or multiplying two numbers of any sign, may lead to a result that is too large or too small to represent. This is called *overflow*; see section 3.2.3 for details.

**Exercise 3.2.** Investigate what happens when you perform such a calculation. What does your compiler say if you try to write down a nonrepresentable number explicitly, for instance in an assignment statement?

In exercise 3.1 above you explored comparing two integers. Let us now explore how subtracting numbers in two’s complement is implemented. Consider  $0 \leq m \leq 2^{31} - 1$  and  $1 \leq n \leq 2^{31}$  and let us see what happens in the computation of  $m - n$ .

Suppose we have an algorithm for adding and subtracting unsigned 32-bit numbers. Can we use that to subtract two’s complement integers? We start by observing that the integer subtraction  $m - n$  becomes the unsigned addition  $m + (2^{32} - n)$ .

- Case:  $m < n$ . In this case,  $m - n$  is negative and  $1 \leq |m - n| \leq 2^{31}$ , so the bit pattern for  $m - n$  is that of  $2^{32} - (n - m)$ . Now,  $2^{32} - (n - m) = m + (2^{32} - n)$ , so we can compute  $m - n$  in 2’s complement by adding the bit patterns of  $m$  and  $-n$  as unsigned integers.
- Case:  $m > n$ . Here we observe that  $m + (2^{32} - n) = 2^{32} + m - n$ . Since  $m - n > 0$ , this is a number  $> 2^{32}$  and therefore not a legitimate representation of a negative number. However, if we store this number in 33 bits, we see that it is the correct result  $m - n$ , plus a single bit in the 33-rd position. Thus, by performing the unsigned addition, and ignoring the *overflow bit*, we again get the correct result.

In both cases we conclude that we can perform the subtraction  $m - n$  by adding the unsigned number that represent  $m$  and  $-n$  and ignoring overflow if it occurs.

## 3.2 Real numbers

In this section we will look at how real numbers are represented in a computer, and the limitations of various schemes. The next section will then explore the ramifications of this for arithmetic involving computer numbers.

### 3.2.1 They’re not really real numbers

In the mathematical sciences, we usually work with real numbers, so it’s convenient to pretend that computers can do this too. However, since numbers in a computer have only a finite number of bits, most real numbers can not be represented exactly. In fact, even many fractions can not be represented exactly, since they repeat; for instance,  $1/3 = 0.333 \dots$ . An illustration of this is given in appendix 31.6.

**Exercise 3.3.** Some programming languages allow you to write loops with not just an integer, but also with a real number as ‘counter’. Explain why this is a bad idea. Hint: when is the upper bound reached?

Whether a fraction repeats depends on the number system. (How would you write  $1/3$  in ternary, base 3, arithmetic?) In binary computers this means that fractions such as  $1/10$ , which in decimal arithmetic are terminating, are repeating. Since decimal arithmetic is important in financial calculations, some people care about this kind of arithmetic right; see section 3.2.2.2 for what was done about it.

### 3.2.2 Representation of real numbers

Real numbers are stored using a scheme that is analogous to what is known as ‘scientific notation’, where a number is represented as a *significant* and an *exponent*, for instance  $6.022 \cdot 10^{23}$ , which has a significant 6022 with a *radix point* after the first digit, and an exponent 23. This number stands for

$$6.022 \cdot 10^{23} = [6 \times 10^0 + 0 \times 10^{-1} + 2 \times 10^{-2} + 2 \times 10^{-3}] \cdot 10^{23}.$$

We introduce a *base*, a small integer number, 10 in the preceding example, and 2 in computer numbers, and write numbers in terms of it as a sum of  $t$  terms:

$$x = \pm 1 \times [d_1\beta^0 + d_2\beta^{-1} + d_3\beta^{-2} + \dots + d_t\beta^{-t+1}b] \times \beta^e = \pm \sum_{i=1}^t d_i\beta^{1-i} \times \beta^e \quad (3.1)$$

where the components are

- the *sign bit*: a single bit storing whether the number is positive or negative;
- $\beta$  is the base of the number system;
- $0 \leq d_i \leq \beta - 1$  the digits of the *mantissa* or *significant* – the location of the radix point (decimal point in decimal numbers) is implicitly assumed to the immediately following the first digit;
- $t$  is the length of the mantissa;
- $e \in [L, U]$  exponent; typically  $L < 0 < U$  and  $L \approx -U$ .

Note that there is an explicit sign bit for the whole number; the sign of the exponent is handled differently. For reasons of efficiency,  $e$  is not a signed number; instead it is considered as an unsigned number in excess of a certain minimum value. For instance, the bit pattern for the number zero is interpreted as  $e = L$ .

#### 3.2.2.1 Some examples

Let us look at some specific examples of floating point representations. Base 10 is the most logical choice for human consumption, but computers are binary, so base 2 predominates there. Old IBM mainframes grouped bits to make for a base 16 representation.

	$\beta$	$t$	$L$	$U$
IEEE single precision (32 bit)	2	24	-126	127
IEEE double precision (64 bit)	2	53	-1022	1023
Old Cray 64 bit	2	48	-16383	16384
IBM mainframe 32 bit	16	6	-64	63
packed decimal	10	50	-999	999
Setun	3			

Of these, the single and double precision formats are by far the most common. We will discuss these in section 3.2.7 and further.

#### 3.2.2.2 Binary coded decimal

Decimal numbers are not relevant in scientific computing, but they are useful in financial calculations, where computations involving money absolutely have to be exact. Binary arithmetic is at a disadvantage here, since numbers such as  $1/10$  are repeating fractions in binary. With a finite number of bits in the mantissa, this means that the number  $1/10$  can not be represented exactly in binary. For this reason, *binary-coded-decimal* schemes were used in old IBM mainframes, and are in fact being standardized in revisions of IEEE754 [90]; see also section 3.2.7.

In BCD schemes, one or more decimal digits are encoded in a number of bits. The simplest scheme would encode the digits  $0 \dots 9$  in four bits. This has the advantage that in a BCD number each digit is readily identified; it has the disadvantage that about  $1/3$  of all bits are wasted, since 4 bits can encode the numbers  $0 \dots 15$ . More efficient encodings would encode  $0 \dots 999$  in ten bits, which could in principle store the numbers  $0 \dots 1023$ . While this is efficient in the sense that few bits are wasted, identifying individual digits in such a number takes some decoding. For this reason, BCD arithmetic needs hardware support from the processor, which is rarely found these days; one example is the IBM Power architecture, starting with the *IBM Power6*.

#### 3.2.2.3 Other number bases for computer arithmetic

There have been some experiments with *ternary arithmetic* (see [http://en.wikipedia.org/wiki/Ternary\\_computer](http://en.wikipedia.org/wiki/Ternary_computer) and <http://www.computer-museum.ru/english/setun.htm>), however, no practical hardware exists.

### 3.2.3 Limitations

Since we use only a finite number of bits to store floating point numbers, not all numbers can be represented. The ones that can not be represented fall into two categories: those that are too large or too small (in some sense), and those that fall in the gaps. Numbers can be too large or too small in the following ways.

**Overflow** The largest number we can store is

$$(\beta - 1) \cdot 1 + (\beta - 1) \cdot \beta^{-1} + \dots + (\beta - 1) \cdot \beta^{-(t-1)} = \beta - 1 \cdot \beta^{-(t-1)},$$

and the smallest number (in an absolute sense) is  $-(\beta - \beta^{-(t-1)})$ ; anything larger than the former or smaller than the latter causes a condition called *overflow*.

**Underflow** The number closest to zero is  $\beta^{-(t-1)} \cdot \beta^L$ . A computation that has a result less than that (in absolute value) causes a condition called *underflow*. (See section 3.2.4 for *gradual underflow*.)

The fact that only a small number of real numbers can be represented exactly is the basis of the field of round-off error analysis. We will study this in some detail in the following sections.

The occurrence of overflow or underflow means that your computation will be ‘wrong’ from that point on. Underflow will make the computation proceed with a zero where there should have been a nonzero; overflow is represented as *Inf*, short of ‘infinite’. Computing with *Inf* is possible to an extent: adding two of those quantities will again give *Inf*. However, subtracting them gives *NaN*: ‘not a number’.

In none of these cases will the computation abort: the processor will continue, unless you tell it otherwise. The ‘otherwise’ consists of you telling the compiler to generate an *interrupt*, which halts the computation with an error message. In C, you specify this with a library call:

```
#include <fenv.h>
int main() {
    ...
    feenableexcept (FE_DIVBYZERO | FE_INVALID | FE_OVERFLOW);
```

Interrupts can also be enabled by compiler options.

### 3.2.4 Normalized and unnormalized numbers

The general definition of floating point numbers, equation (3.1), leaves us with the problem that numbers have more than one representation. For instance,  $.5 \times 10^2 = .05 \times 10^3$ . Since this would make computer arithmetic needlessly complicated, for instance in testing equality of numbers, we use *normalized floating point numbers*. A number is normalized if its first digit is nonzero. This implies that the mantissa part is  $\beta > x_m \geq 1$ .

A practical implication in the case of binary numbers is that the first digit is always 1, so we do not need to store it explicitly. In the IEEE 754 standard, this means that every floating point number is of the form

$$1.d_1d_2 \dots d_t \times 2^{exp}$$

and only the digits  $d_1d_2 \dots d_t$  are stored.

Another implication of this scheme is that we have to amend the definition of underflow (see section 3.2.3 above): instead of having a smallest number  $-(\beta - \beta^{-(t-1)})$ , any number less than  $1 \cdot \beta^L$  now causes underflow. Trying to compute a number less than that in absolute value is sometimes handled by using *unnormalized floating point numbers*, a process known as *gradual underflow*. In this case, a special value of the exponent indicates that the number is no longer normalized. In the case IEEE standard arithmetic (section 3.2.7) this is done through a zero exponent field.

However, this is typically tens or hundreds of times slower than computing with regular floating point numbers<sup>2</sup>. At the time of this writing, only the IBM Power6 has hardware support for gradual underflow.

### 3.2.5 Representation error

Let us consider a real number that is not representable in a computer’s number system.

An unrepresentable number is approximated either by ordinary *rounding*, rounding up or down, or *truncation*. This means that a machine number  $\tilde{x}$  is the representation for all  $x$  in an interval around it. With  $t$

2. In real-time applications such as audio processing this phenomenon is especially noticeable; see <http://phonophunk.com/articles/pentium4-denormalization.php?pg=3>.

digits in the mantissa, this is the interval of numbers that differ from  $\bar{x}$  in the  $t + 1$ st digit. For the mantissa part we get:

$$\begin{cases} x \in [\tilde{x}, \tilde{x} + \beta^{-t+1}) & \text{truncation} \\ x \in [\tilde{x} - \frac{1}{2}\beta^{-t+1}, \tilde{x} + \frac{1}{2}\beta^{-t+1}) & \text{rounding} \end{cases}$$

If  $x$  is a number and  $\tilde{x}$  its representation in the computer, we call  $x - \tilde{x}$  the *representation error* or *absolute representation error*, and  $\frac{x-\tilde{x}}{x}$  the *relative representation error*. Often we are not interested in the sign of the error, so we may apply the terms error and relative error to  $|x - \tilde{x}|$  and  $|\frac{x-\tilde{x}}{x}|$  respectively.

Often we are only interested in bounds on the error. If  $\epsilon$  is a bound on the error, we will write

$$\tilde{x} = x \pm \epsilon \stackrel{\text{D}}{\equiv} |x - \tilde{x}| \leq \epsilon \Leftrightarrow \tilde{x} \in [x - \epsilon, x + \epsilon]$$

For the relative error we note that

$$\tilde{x} = x(1 + \epsilon) \Leftrightarrow \left| \frac{\tilde{x} - x}{x} \right| \leq \epsilon$$

Let us consider an example in decimal arithmetic, that is,  $\beta = 10$ , and with a 3-digit mantissa:  $t = 3$ . The number  $x = 1.256$  has a representation that depends on whether we round or truncate:  $\tilde{x}_{\text{round}} = 1.26$ ,  $\tilde{x}_{\text{truncate}} = 1.25$ . The error is in the 4th digit: if  $\epsilon = x - \tilde{x}$  then  $|\epsilon| < \beta^{t-1}$ .

**Exercise 3.4.** The number in this example had no exponent part. What are the error and relative error if there had been one?

#### 3.2.6 Machine precision

Often we are only interested in the order of magnitude of the representation error, and we will write  $\tilde{x} = x(1 + \epsilon)$ , where  $|\epsilon| \leq \beta^{-t}$ . This maximum relative error is called the *machine precision*, or sometimes *machine epsilon*. Typical values are:

$$\begin{cases} \epsilon \approx 10^{-7} & \text{32-bit single precision} \\ \epsilon \approx 10^{-16} & \text{64-bit double precision} \end{cases}$$

Machine precision can be defined another way:  $\epsilon$  is the smallest number that can be added to 1 so that  $1 + \epsilon$  has a different representation than 1. A small example shows how aligning exponents can shift a too small operand so that it is effectively ignored in the addition operation:

$$\begin{array}{rcl} \begin{array}{r} 1.0000 \times 10^0 \\ + 1.0000 \times 10^{-5} \\ \hline \end{array} & \Rightarrow & \begin{array}{r} 1.0000 \times 10^0 \\ + 0.00001 \times 10^0 \\ \hline = 1.0000 \times 10^0 \end{array} \end{array}$$

Yet another way of looking at this is to observe that, in the addition  $x + y$ , if the ratio of  $x$  and  $y$  is too large, the result will be identical to  $x$ .

The machine precision is the maximum attainable accuracy of computations: it does not make sense to ask for more than 6-or-so digits accuracy in single precision, or 15 in double.

sign	exponent	mantissa	$(e_1 \dots e_8)$	numerical value
$s$	$e_1 \dots e_8$	$s_1 \dots s_{23}$	$(0 \dots 0) = 0$	$\pm 0.s_1 \dots s_{23} \times 2^{-126}$
31	30 $\dots$ 23	22 $\dots$ 0	$(0 \dots 01) = 1$	$\pm 1.s_1 \dots s_{23} \times 2^{-126}$
			$(0 \dots 010) = 2$	$\pm 1.s_1 \dots s_{23} \times 2^{-125}$
			$\dots$	
			$(01111111) = 127$	$\pm 1.s_1 \dots s_{23} \times 2^0$
			$(10000000) = 128$	$\pm 1.s_1 \dots s_{23} \times 2^1$
			$\dots$	
			$(11111110) = 254$	$\pm 1.s_1 \dots s_{23} \times 2^{127}$
			$(11111111) = 255$	$\pm \infty$ if $s_1 \dots s_{23} = 0$ , otherwise NaN

Figure 3.1: Single precision arithmetic

**Exercise 3.5.** Write a small program that computes the machine epsilon. Does it make any difference if you set the *compiler optimization levels* low or high?

**Exercise 3.6.** The number  $e \approx 2.72$ , the base for the natural logarithm, has various definitions. One of them is

$$e = \lim_{n \rightarrow \infty} (1 + 1/n)^n.$$

Write a single precision program that tries to compute  $e$  in this manner. Evaluate the expression for  $n = 10^k$  with  $k = 1, \dots, 10$ . Explain the output for large  $n$ . Comment on the behaviour of the error.

### 3.2.7 The IEEE 754 standard for floating point numbers

Some decades ago, issues like the length of the mantissa and the rounding behaviour of operations could differ between computer manufacturers, and even between models from one manufacturer. This was obviously a bad situation from a point of portability of codes and reproducibility of results. The IEEE standard 754<sup>34</sup> codified all this, for instance stipulating 24 and 53 bits for the mantissa in single and double precision arithmetic, using a storage sequence of sign bit, exponent, mantissa.

The standard also declared the rounding behaviour to be *correct rounding*: the result of an operation should be the rounded version of the exact result. There will be much more on the influence of rounding (and truncation) on numerical computations, below.

3. IEEE 754 is a standard for binary arithmetic; there is a further standard, IEEE 854, that allows decimal arithmetic.

4. “It was remarkable that so many hardware people there, knowing how difficult p754 would be, agreed that it should benefit the community at large. If it encouraged the production of floating-point software and eased the development of reliable software, it would help create a larger market for everyone’s hardware. This degree of altruism was so astonishing that MATLAB’s creator Dr. Cleve Moler used to advise foreign visitors not to miss the country’s two most awesome spectacles: the Grand Canyon, and meetings of IEEE p754.” W. Kahan, <http://www.cs.berkeley.edu/~wkahan/ieee754status/754story.html>.



Above (section 3.2.3), we have seen the phenomena of overflow and underflow, that is, operations leading to unrepresentable numbers. There is a further exceptional situation that needs to be dealt with: what result should be returned if the program asks for illegal operations such as  $\sqrt{-4}$ ? The IEEE 754 standard has two special quantities for this: `Inf` and `NaN` for ‘infinity’ and ‘not a number’. Infinity is the result of overflow or dividing by zero, not-a-number is the result of, for instance, subtracting infinity from infinity. If `NaN` appears in an expression, the whole expression will evaluate to that value. The rule for computing with `Inf` is a bit more complicated [68].

An inventory of the meaning of all bit patterns in IEEE 754 double precision is given in figure 3.1. Recall from section 3.2.4 above that for normalized numbers the first nonzero digit is a 1, which is not stored, so the bit pattern  $d_1d_2 \dots d_t$  is interpreted as  $1.d_1d_2 \dots d_t$ .

**Exercise 3.7.** Every programmer, at some point in their life, makes the mistake of storing a real number in an integer or the other way around. This can happen for instance if you call a function differently from how it was defined.

```
void a(double x) {....}
int main() {
    int i;
    .... a(i) ....
}
```

What happens when you print `x` in the function? Consider the bit pattern for a small integer, and use the table in figure 3.1 to interpret it as a floating point number. Explain that it will be an unnormalized number<sup>5</sup>.

These days, almost all processors adhere to the IEEE 754 standard. Early generations of the *NVidia Tesla GPUs* were not standard-conforming in single precision. The justification for this was that single precision is more likely used for graphics, where exact compliance matters less. For many scientific computations, double precision is necessary, since the precision of calculations gets worse with increasing problem size or runtime. This is true for the sort of calculations in chapter 4, but not for others such as *Lattice Boltzmann Method (LBM)*

#### 3.2.7.1 Setting the rounding behaviour

The 754 standard also declares that a processor should be able to switch its rounding behaviour between ordinary rounding, rounding up or down (sometimes phrased as ‘towards plus infinity’ and ‘towards minus infinity’ respectively) or truncation. In C99, the API for this is contained in *fenv.h*:

```
#include <fenv.h>

int roundings[]={FE_TONEAREST, FE_UPWARD, FE_DOWNWARD, FE_TOWARDZERO};
rchoice = ....
int status = fesetround(roundings[rchoice]);
```

---

5. This is one of those errors you won’t forget after you make it. In the future, whenever you see a number on the order of  $10^{-305}$  you’ll recognize that you probably made this error.

In Fortran2003 the function `IEEE_SET_ROUNDING_MODE` is available in the `IEEE_ARITHMETIC` module.

Setting the rounding behaviour can serve as a quick test for the stability of an algorithm: if the result changes appreciably between two different rounding strategies, the algorithm is likely not stable.

### 3.3 Round-off error analysis

Numbers that are too large or too small to be represented, leading to overflow and underflow, are uncommon: usually computations can be arranged so that this situation will not occur. By contrast, the case that the result of a computation between computer numbers (even something as simple as a single addition) is not representable is very common. Thus, looking at the implementation of an algorithm, we need to analyze the effect of such small errors propagating through the computation. This is commonly called *round-off error analysis*.

#### 3.3.1 Correct rounding

The IEEE 754 standard, mentioned in section 3.2.7, does not only declare the way a floating point number is stored, it also gives a standard for the accuracy of operations such as addition, subtraction, multiplication, division. The model for arithmetic in the standard is that of *correct rounding*: the result of an operation should be as if the following procedure is followed:

- The exact result of the operation is computed, whether this is representable or not;
- This result is then rounded to the nearest computer number.

In short: the representation of the result of an operation is the rounded exact result of that operation. (Of course, after two operations it no longer needs to hold that the computed result is the exact rounded version of the exact result.)

If this statement sounds trivial or self-evident, consider subtraction as an example. In a decimal number system with two digits in the mantissa, the computation  $1.0 - 9.4 \cdot 10^{-1} = 1.0 - 0.94 = 0.06 = 0.6 \cdot 10^{-2}$ . Note that in an intermediate step the mantissa .094 appears, which has one more digit than the two we declared for our number system. The extra digit is called a *guard digit*.

Without a guard digit, this operation would have proceeded as  $1.0 - 9.4 \cdot 10^{-1}$ , where  $9.4 \cdot 10^{-1}$  would be rounded to 0.9, giving a final result of 0.1, which is almost double the correct result.

**Exercise 3.8.** Consider the computation  $1.0 - 9.5 \cdot 10^{-1}$ , and assume again that numbers are rounded to fit the 2-digit mantissa. Why is this computation in a way a lot worse than the example?

One guard digit is not enough to guarantee correct rounding. An analysis that we will not reproduce here shows that three extra bits are needed [67].

#### 3.3.1.1 Mul-Add operations

In 2008, the IEEE 754 standard was revised to include the behaviour of *Fused Multiply-Add (FMA)* operations, that is, operations of the form  $a*b+c$ . The standard here defines correct rounding to be that the result of this combined computation should be the rounded correct result. A naive implementation of this operations would involve two roundings: one after the multiplication and one after the addition.

**Exercise 3.9.** Can you come up with an example where correct rounding of an FMA is considerably more accurate than rounding the multiplication and addition separately?  
Hint: let the  $c$  term be of opposite sign as  $a*b$ , and try to force cancellation in the subtraction.

Mul-add operations sometimes use the 80-bit *extended precision* format for great *precision of the intermediate result*.

#### 3.3.2 Addition

Addition of two floating point numbers is done in a couple of steps. First the exponents are aligned: the smaller of the two numbers is written to have the same exponent as the larger number. Then the mantissas are added. Finally, the result is adjusted so that it again is a normalized number.

As an example, consider  $1.00 + 2.00 \times 10^{-2}$ . Aligning the exponents, this becomes  $1.00 + 0.02 = 1.02$ , and this result requires no final adjustment. We note that this computation was exact, but the sum  $1.00 + 2.55 \times 10^{-2}$  has the same result, and here the computation is clearly not exact: the exact result is 1.0255, which is not representable with three digits to the mantissa.

In the example  $6.15 \times 10^1 + 3.98 \times 10^1 = 10.13 \times 10^1 = 1.013 \times 10^2 \rightarrow 1.01 \times 10^2$  we see that after addition of the mantissas an adjustment of the exponent is needed. The error again comes from truncating or rounding the first digit of the result that does not fit in the mantissa: if  $x$  is the true sum and  $\tilde{x}$  the computed sum, then  $\tilde{x} = x(1 + \epsilon)$  where, with a 3-digit mantissa  $|\epsilon| < 10^{-3}$ .

Formally, let us consider the computation of  $s = x_1 + x_2$ , and we assume that the numbers  $x_i$  are represented as  $\tilde{x}_i = x_i(1 + \epsilon_i)$ . Then the sum  $s$  is represented as

$$\begin{aligned}\tilde{s} &= (\tilde{x}_1 + \tilde{x}_2)(1 + \epsilon_3) \\ &= x_1(1 + \epsilon_1)(1 + \epsilon_3) + x_2(1 + \epsilon_2)(1 + \epsilon_3) \\ &\approx x_1(1 + \epsilon_1 + \epsilon_3) + x_2(1 + \epsilon_2 + \epsilon_3) \\ &\approx s(1 + 2\epsilon)\end{aligned}$$

under the assumptions that all  $\epsilon_i$  are small and of roughly equal size, and that both  $x_i > 0$ . We see that the relative errors are added under addition.

#### 3.3.3 Multiplication

Floating point multiplication, like addition, involves several steps. In order to multiply two numbers  $m_1 \times \beta^{e_1}$  and  $m_2 \times \beta^{e_2}$ , the following steps are needed.

- The exponents are added:  $e \leftarrow e_1 + e_2$ .

- The mantissas are multiplied:  $m \leftarrow m_1 \times m_2$ .
- The mantissa is normalized, and the exponent adjusted accordingly.

For example:  $1.23 \cdot 10^0 \times 5.67 \cdot 10^1 = 0.69741 \cdot 10^1 \rightarrow 6.9741 \cdot 10^0 \rightarrow 6.97 \cdot 10^0$ .

**Exercise 3.10.** Analyze the relative error of multiplication.

### 3.3.4 Subtraction

Subtraction behaves very differently from addition. Whereas in addition errors are added, giving only a gradual increase of overall roundoff error, subtraction has the potential for greatly increased error in a single operation.

For example, consider subtraction with 3 digits to the mantissa:  $1.24 - 1.23 = 0.01 \rightarrow 1.00 \cdot 10^{-2}$ . While the result is exact, it has only one significant digit<sup>6</sup>. To see this, consider the case where the first operand 1.24 is actually the rounded result of a computation that should have resulted in 1.235. In that case, the result of the subtraction should have been  $5.00 \cdot 10^{-3}$ , that is, there is a 100% error, even though the relative error of the inputs was as small as could be expected. Clearly, subsequent operations involving the result of this subtraction will also be inaccurate. We conclude that subtracting almost equal numbers is a likely cause of numerical roundoff.

There are some subtleties about this example. Subtraction of almost equal numbers is exact, and we have the correct rounding behaviour of IEEE arithmetic. Still, the correctness of a single operation does not imply that a sequence of operations containing it will be accurate. While the addition example showed only modest decrease of numerical accuracy, the cancellation in this example can have disastrous effects. You'll see an example in section 3.3.6.1.

### 3.3.5 Associativity

Another effect of the way floating point numbers are treated is on the *associativity of mathematical operations*. Operations such as addition and multiplication, that ought to be associative, are no longer so in computer arithmetic.

Let's consider a simple example, showing how this can be caused by the rounding behaviour of floating point numbers. Let floating point numbers be stored as a single digit for the mantissa, one digit for the exponent, and one *guard digit*; now consider the computation of  $4 + 6 + 7$ . Evaluation left-to-right gives:

$$\begin{aligned}
 (4 \cdot 10^0 + 6 \cdot 10^0) + 7 \cdot 10^0 &\Rightarrow 10 \cdot 10^0 + 7 \cdot 10^0 && \text{addition} \\
 &\Rightarrow 1 \cdot 10^1 + 7 \cdot 10^0 && \text{rounding} \\
 &\Rightarrow 1.0 \cdot 10^1 + 0.7 \cdot 10^1 && \text{using guard digit} \\
 &\Rightarrow 1.7 \cdot 10^1 && \\
 &\Rightarrow 2 \cdot 10^1 && \text{rounding}
 \end{aligned}$$

6. Normally, a number with 3 digits to the mantissa suggests an error corresponding to rounding or truncating the fourth digit. We say that such a number has 3 *significant digits*. In this case, the last two digits have no meaning, resulting from the normalization process.

On the other hand, evaluation right-to-left gives:

$$\begin{aligned}
 4 \cdot 10^0 + (6 \cdot 10^0 + 7 \cdot 10^0) &\Rightarrow 4 \cdot 10^0 + 13 \cdot 10^0 && \text{addition} \\
 &\Rightarrow 4 \cdot 10^0 + 1 \cdot 10^1 && \text{rounding} \\
 &\Rightarrow 0.4 \cdot 10^1 + 1.0 \cdot 10^1 && \text{using guard digit} \\
 &\Rightarrow 1.4 \cdot 10^1 \\
 &\Rightarrow 1 \cdot 10^1 && \text{rounding}
 \end{aligned}$$

The conclusion is that the sequence in which rounding and truncation is applied to intermediate results makes a difference. You can also observe that starting with the smaller numbers gives a more accurate result. In section 3.3.6.2 you'll see a more elaborate example of this principle.

Usually, the evaluation order of expressions is determined by the definition of the programming language, or at least by the compiler. In section 3.3.7 we will see how in parallel computations the associativity is not so uniquely determined.

#### 3.3.6 Examples

From the above, the reader may get the impression that roundoff errors only lead to serious problems in exceptional circumstances. In this section we will discuss some very practical examples where the inexactness of computer arithmetic becomes visible in the result of a computation. These will be fairly simple examples; more complicated examples exist that are outside the scope of this book, such as the instability of matrix inversion. The interested reader is referred to [164, 86].

##### 3.3.6.1 The 'abc-formula'

As a practical example, consider the quadratic equation  $ax^2 + bx + c = 0$  which has solutions  $x = \frac{-b \pm \sqrt{b^2 - 4ac}}{2a}$ . Suppose  $b > 0$  and  $b^2 \gg 4ac$  then  $\sqrt{b^2 - 4ac} \approx b$  and the '+' solution will be inaccurate. In this case it is better to compute  $x_- = \frac{-b - \sqrt{b^2 - 4ac}}{2a}$  and use  $x_+ \cdot x_- = -c/a$ .

**Exercise 3.11.** Write a program that computes the roots of the quadratic equation, both the 'textbook' way, and as described above.

- Let  $b = 1$  and  $a = -c$ , and  $4ac \downarrow 0$  by taking progressively smaller values for  $a$  and  $c$ .
- Print out the computed root, the root using the stable computation, and the value of  $f(x) = ax^2 + bx + c$  in the computed root.

Now suppose that you don't care much about the actual value of the root: you want to make sure the residual  $f(x)$  is small in the computed root. Let  $x^*$  be the exact root, then

$$f(x^* + h) \approx f(x^*) + hf'(x^*) = hf'(x^*).$$

Now investigate separately the cases  $a \downarrow 0, c = -1$  and  $a = -1, c \downarrow 0$ . Can you explain the difference?

3.3.6.2 *Summing series*

The previous example was about preventing a large roundoff error in a single operation. This example shows that even gradual buildup of roundoff error can be handled in different ways.

Consider the sum  $\sum_{n=1}^{10000} \frac{1}{n^2} = 1.644834$  and assume we are working with single precision, which on most computers means a machine precision of  $10^{-7}$ . The problem with this example is that both the ratio between terms, and the ratio of terms to partial sums, is ever increasing. In section 3.2.6 we observed that a too large ratio can lead to one operand of an addition in effect being ignored.

If we sum the series in the sequence it is given, we observe that the first term is 1, so all partial sums ( $\sum_{n=1}^N$  where  $N < 10000$ ) are at least 1. This means that any term where  $1/n^2 < 10^{-7}$  gets ignored since it is less than the machine precision. Specifically, the last 7000 terms are ignored, and the computed sum is 1.644725. The first 4 digits are correct.

However, if we evaluate the sum in reverse order we obtain the exact result in single precision. We are still adding small quantities to larger ones, but now the ratio will never be as bad as one-to- $\epsilon$ , so the smaller number is never ignored. To see this, consider the ratio of two terms subsequent terms:

$$\frac{n^2}{(n-1)^2} = \frac{n^2}{n^2 - 2n + 1} = \frac{1}{1 - 2/n + 1/n^2} \approx 1 + \frac{2}{n}$$

Since we only sum  $10^5$  terms and the machine precision is  $10^{-7}$ , in the addition  $1/n^2 + 1/(n-1)^2$  the second term will not be wholly ignored as it is when we sum from large to small.

**Exercise 3.12.** There is still a step missing in our reasoning. We have shown that in adding two subsequent terms, the smaller one is not ignored. However, during the calculation we add partial sums to the next term in the sequence. Show that this does not worsen the situation.

The lesson here is that series that are monotone (or close to monotone) should be summed from small to large, since the error is minimized if the quantities to be added are closer in magnitude. Note that this is the opposite strategy from the case of subtraction, where operations involving similar quantities lead to larger errors. This implies that if an application asks for adding and subtracting series of numbers, and we know a priori which terms are positive and negative, it may pay off to rearrange the algorithm accordingly.

3.3.6.3 *Unstable algorithms*

We will now consider an example where we can give a direct argument that the algorithm can not cope with problems due to inexactly represented real numbers.

Consider the recurrence  $y_n = \int_0^1 \frac{x^n}{x-5} dx = \frac{1}{n} - 5y_{n-1}$ . This is easily seen to be monotonically decreasing; the first term can be computed as  $y_0 = \ln 6 - \ln 5$ .

Performing the computation in 3 decimal digits we get:

### 3. Computer Arithmetic

---

computation	correct result
$y_0 = \ln 6 - \ln 5 = .182 322 \times 10^1 \dots$	1.82
$y_1 = .900 \times 10^{-1}$	.884
$y_2 = .500 \times 10^{-1}$	.0580
$y_3 = .830 \times 10^{-1}$	going up? .0431
$y_4 = -.165$	negative? .0343

We see that the computed results are quickly not just inaccurate, but actually nonsensical. We can analyze why this is the case.

If we define the error  $\epsilon_n$  in the  $n$ -th step as

$$\tilde{y}_n - y_n = \epsilon_n,$$

then

$$\tilde{y}_n = 1/n - 5\tilde{y}_{n-1} = 1/n + 5y_{n-1} + 5\epsilon_{n-1} = y_n + 5\epsilon_{n-1}$$

so  $\epsilon_n \geq 5\epsilon_{n-1}$ . The error made by this computation shows exponential growth.

#### 3.3.6.4 Linear system solving

Sometimes we can make statements about the numerical precision of a problem even without specifying what algorithm we use. Suppose we want to solve a linear system, that is, we have an  $n \times n$  matrix  $A$  and a vector  $b$  of size  $n$ , and we want to compute the vector  $x$  such that  $Ax = b$ . (We will actually considering algorithms for this in chapter 5.) Since the vector  $b$  will the result of some computation or measurement, we are actually dealing with a vector  $\tilde{b}$ , which is some perturbation of the ideal  $b$ :

$$\tilde{b} = b + \Delta b.$$

The perturbation vector  $\Delta b$  can be of the order of the machine precision if it only arises from representation error, or it can be larger, depending on the calculations that produced  $\tilde{b}$ .

We now ask what the relation is between the exact value of  $x$ , which we would have obtained from doing an exact calculation with  $A$  and  $b$ , which is clearly impossible, and the computed value  $\tilde{x}$ , which we get from computing with  $A$  and  $\tilde{b}$ . (In this discussion we will assume that  $A$  itself is exact, but this is a simplification.)

Writing  $\tilde{x} = x + \Delta x$ , the result of our computation is now

$$A\tilde{x} = \tilde{b}$$

or

$$A(x + \Delta x) = b + \Delta b.$$

Since  $Ax = b$ , we get  $A\Delta x = \Delta b$ . From this, we get (see appendix 12 for details)

$$\left\{ \begin{array}{l} \Delta x = A^{-1}\Delta b \\ Ax = b \end{array} \right\} \Rightarrow \left\{ \begin{array}{l} \|A\|\|x\| \geq \|b\| \\ \|\Delta x\| \leq \|A^{-1}\|\|\Delta b\| \end{array} \right\} \Rightarrow \frac{\|\Delta x\|}{\|x\|} \leq \|A\|\|A^{-1}\| \frac{\|\Delta b\|}{\|b\|} \quad (3.2)$$

The quantity  $\|A\|\|A^{-1}\|$  is called the *condition number* of a matrix. The bound (3.2) then says that any perturbation in the right hand side can lead to a perturbation in the solution that is at most larger by the condition number of the matrix  $A$ . Note that it does not say that the perturbation in  $x$  *needs* to be anywhere close to that size, but we can not rule it out, and in some cases it indeed happens that this bound is attained.

Suppose that  $b$  is exact up to machine precision, and the condition number of  $A$  is  $10^4$ . The bound (3.2) is often interpreted as saying that the last 4 digits of  $x$  are unreliable, or that the computation ‘loses 4 digits of accuracy’.

Equation (3.2) can also be interpreted as follows: when we solve a linear system  $Ax = b$  we get an approximate solution  $x + \Delta x$  which is the *exact* solution of a perturbed system  $A(x + \Delta x) = b + \Delta b$ . The fact that the perturbation in the solution can be related to the perturbation in the system, is expressed by saying that the algorithm exhibits *backwards stability*.

The analysis of the accuracy of linear algebra algorithms is a field of study in itself; see for instance the book by Higham [86].

### 3.3.7 Roundoff error in parallel computations

As we discussed in section 3.3.5, and as you saw in the above example of summing a series, addition in computer arithmetic is not *associative*. A similar fact holds for multiplication. This has an interesting consequence for parallel computations: the way a computation is spread over parallel processors influences the result.

As a very simple example, consider computing the sum of four numbers  $a + b + c + d$ . On a single processor, ordinary execution corresponds to the following associativity:

$$((a + b) + c) + d.$$

On the other hand, spreading this computation over two processors, where processor 0 has  $a, b$  and processor 1 has  $c, d$ , corresponds to

$$((a + b) + (c + d)).$$

Generalizing this, we see that reduction operations will most likely give a different result on different numbers of processors. (The MPI standard declares that two program runs on the same set of processors should give the same result.) It is possible to circumvent this problem by replace a reduction operation by a *gather* operation to all processors, which subsequently do a local reduction. However, this increases the memory requirements for the processors.

There is an intriguing other solution to the parallel summing problem. If we use a mantissa of 4000 bits to store a floating point number, we do not need an exponent, and all calculations with numbers thus stored are exact since they are a form of fixed-point calculation [102, 101]. While doing a whole application with such numbers would be very wasteful, reserving this solution only for an occasional inner product calculation may be the solution to the reproducibility problem.



#### 3.4 Compilers and round-off

From the above discussion it should be clear that some simple statements that hold for mathematical real numbers do not hold for floating-point numbers. For instance, in floating-point arithmetic

$$(a + b) + c \neq a + (b + c).$$

This implies that a compiler can not perform certain optimizations without it having an effect on round-off behaviour<sup>7</sup>. In some codes such slight differences can be tolerated, for instance because the method has built-in safeguards. For instance, the stationary iterative methods of section 5.5 damp out any error that is introduced.

On the other hand, if the programmer has written code to account for round-off behaviour, the compiler has no such liberties. This was hinted at in exercise 3.5 above. We use the concept of *value safety* to describe how a compiler is allowed to change the interpretation of a computation. At its strictest, the compiler is not allowed to make any changes that affect the result of a computation.

These matters are also of importance if you care about *reproducibility* of results. If a code is compiled with two different compilers, should runs with the same input give the same output? If a code is run in parallel on two different processor configurations? These questions are very subtle. In the first case, people sometimes insist on *bitwise reproducibility*, whereas in the second case some differences are allowed, as long as the result stays ‘scientifically’ equivalent. Of course, that concept is hard to make rigorous.

Here are some issues that are relevant when considering the influence of the compiler on code behaviour and reproducibility.

**Re-association** Foremost among changes that a compiler can make to a computation is *re-association*, the technical term for grouping  $a + b + c$  as  $a + (b + c)$ . The *C language standard* and the *C++ language standard* prescribe strict left-to-right evaluation of expressions without parentheses, so re-association is in fact not allowed by the standard. The *Fortran language standard* has no such prescription.

A common source of re-association is *loop unrolling*; see section 1.6.2. Under strict value safety, a compiler is limited in how it can unroll a loop, which has implications for performance. The amount of loop unrolling, and whether it’s performed at all, depends on the compiler optimization level, the choice of compiler, and the target platform.

A more subtle source of re-association is parallel execution; see section 3.3.7. This implies that the output of a code need not be strictly reproducible between two runs on different parallel configurations.

**Expression evaluation** In evaluating the expression  $a + (b + c)$ , a processor will generate an intermediate result for  $b + c$  which is not assigned to any variable. Many processors are able to assign a higher *precision of the intermediate result*. A compiler can have a flag to dictate whether to use this facility.

---

7. This section borrows from documents by Microsoft [http://msdn.microsoft.com/en-us/library/aa289157\(vs.71\).aspx](http://msdn.microsoft.com/en-us/library/aa289157(vs.71).aspx) and Intel [http://software.intel.com/sites/default/files/article/164389/fp-consistency-122712\\_1.pdf](http://software.intel.com/sites/default/files/article/164389/fp-consistency-122712_1.pdf); for detailed discussion the reader is referred to these.

**Behaviour of the floating point unit** Rounding behaviour and treatment of *gradual underflow* may be controlled by library functions.

**Library functions** The IEEE 754 standard only prescribes simple operations; there is as yet no standard that treats sine or log functions. Therefore, their implementation may be a source of variability.

## 3.5 More about floating point arithmetic

### 3.5.1 Programming languages

Different languages have different approaches to declaring integers and floating point numbers.

**Fortran** In Fortran there are various ways of specifying the storage format for integer and real variables. For instance, it is possible to declare the number of bytes that it takes to store a variable: `INTEGER*2, REAL*8`. One advantage of this approach is the easy interoperability with other languages, or the MPI library.

Often it is possible to write a code using only `INTEGER`, `REAL`, and use *compiler flags* to indicate the size of an integer and real number in bytes.

More sophisticated, modern versions of Fortran can indicate the number of digits of precision a floating point number needs to have:

```
integer, parameter :: k9 = selected_real_kind(9)
real(kind=k9) :: r
r = 2._k9; print *, sqrt(r) ! prints 1.4142135623730
```

The ‘kind’ values will usually be 4,8,16 but this is compiler dependent.

**C** In C, the type identifiers have no standard length. For integers there is `short int`, `int`, `long int`, and for floating point `float`, `double`. The `sizeof()` operator gives the number of bytes used to store a datatype.

**C99, Fortran2003** Recent standards of the C and Fortran languages incorporate the C/Fortran interoperability standard, which can be used to declare a type in one language so that it is compatible with a certain type in the other language.

### 3.5.2 Other computer arithmetic systems

Other systems have been proposed to dealing with the problems of inexact arithmetic on computers. One solution is *extended precision* arithmetic, where numbers are stored in more bits than usual. A common use of this is in the calculation of inner products of vectors: the accumulation is internally performed in extended precision, but returned as a regular floating point number. Alternatively, there are libraries such as `GMPLib` [65] that allow for any calculation to be performed in higher precision.

Another solution to the imprecisions of computer arithmetic is ‘interval arithmetic’ [91], where for each calculation interval bounds are maintained. While this has been researched for considerable time, it is not practically used other than through specialized libraries [18].

#### 3.5.3 Extended precision

When the IEEE 754 standard was drawn up, it was envisioned that processors could have a whole range of precisions. In practice, only single and double precision as defined have been used. However, one instance of *extended precision* still survives: processors sometimes have 80-bit registers for storing intermediate results. (This goes back to the *Intel 80287 co-processor*.) This strategy makes sense in *FMA* instructions, and in the accumulation of inner products.

#### 3.5.4 Fixed-point arithmetic

A fixed-point number (for a more thorough discussion than found here, see [168]) can be represented as  $\langle N, F \rangle$  where  $N \geq \beta^0$  is the integer part and  $F < 1$  is the fractional part. Another way of looking at this, is that a fixed-point number is an integer stored in  $N + F$  digits, with an implied decimal point after the first  $N$  digits.

Fixed-point calculations can overflow, with no possibility to adjust an exponent. Consider the multiplication  $\langle N_1, F_1 \rangle \times \langle N_2, F_2 \rangle$ , where  $N_1 \geq \beta^{n_1}$  and  $N_2 \geq \beta^{n_2}$ . This overflows if  $n_1 + n_2$  is more than the number of positions available for the integer part. (Informally, the number of digits of the product is the sum of the digits of the operands.) This means that, in a program that uses fixed-point, numbers will need to have a number of zero digits, if you are ever going to multiply them, which lowers the numerical accuracy. It also means that the programmer has to think harder about calculations, arranging them in such a way that overflow will not occur, and that numerical accuracy is still preserved to a reasonable extent.

So why would people use fixed-point numbers? One important application is in embedded low-power devices, think a battery-powered digital thermometer. Since fixed-point calculations are essentially identical to integer calculations, they do not require a floating-point unit, thereby lowering chip size and lessening power demands. Also, many early video game systems had a processor that either had no floating-point unit, or where the integer unit was considerably faster than the floating-point unit. In both cases, implementing non-integer calculations as fixed-point, using the integer unit, was the key to high throughput.

Another area where fixed point arithmetic is still used is in signal processing. In modern CPUs, integer and floating point operations are of essentially the same speed, but converting between them is relatively slow. Now, if the sine function is implemented through table lookup, this means that in  $\sin(\sin x)$  the output of a function is used to index the next function application. Obviously, outputting the sine function in fixed point obviates the need for conversion between real and integer quantities, which simplifies the chip logic needed, and speeds up calculations.

#### 3.5.5 Complex numbers

Some programming languages have complex numbers as a native data type, others not, and others are in between. For instance, in Fortran you can declare

```
COMPLEX z1, z2, z(32)
COMPLEX*16 zz1, zz2, zz(36)
```

A complex number is a pair of real numbers, the real and imaginary part, allocated adjacent in memory. The first declaration then uses 8 bytes to store to `REAL*4` numbers, the second one has `REAL*8`s for the real and imaginary part. (Alternatively, use `DOUBLE COMPLEX` or in Fortran90 `COMPLEX (KIND=2)` for the second line.)

By contrast, the C language does not natively have complex numbers, but both C99 and C++ have a `complex.h` header file<sup>8</sup>. This defines as complex number as in Fortran, as two real numbers.

Storing a complex number like this is easy, but sometimes it is computationally not the best solution. This becomes apparent when we look at arrays of complex numbers. If a computation often relies on access to the real (or imaginary) parts of complex numbers exclusively, striding through an array of complex numbers, has a stride two, which is disadvantageous (see section 1.3.4.6). In this case, it is better to allocate one array for the real parts, and another for the imaginary parts.

**Exercise 3.13.** Suppose arrays of complex numbers are stored the Fortran way. Analyze the memory access pattern of pairwise multiplying the arrays, that is,  $\forall_i: c_i \leftarrow a_i \cdot b_i$ , where `a()`, `b()`, `c()` are arrays of complex numbers.

**Exercise 3.14.** Show that an  $n \times n$  linear system  $Ax = b$  over the complex numbers can be written as a  $2n \times 2n$  system over the real numbers. Hint: split the matrix and the vectors in their real and imaginary parts. Argue for the efficiency of storing arrays of complex numbers as separate arrays for the real and imaginary parts.

### 3.6 Conclusions

Computations done on a computer are invariably beset with numerical error. In a way, the reason for the error is the imperfection of computer arithmetic: if we could calculate with actual real numbers there would be no problem. (There would still be the matter of measurement error in data, and approximations made in numerical methods; see the next chapter.) However, if we accept roundoff as a fact of life, then various observations hold:

- Mathematically equivalent operations need not behave identically from a point of stability; see the ‘abc-formula’ example.
- Even rearrangements of the same computations do not behave identically; see the summing example.

Thus it becomes imperative to analyze computer algorithms with regard to their roundoff behaviour: does roundoff increase as a slowly growing function of problem parameters, such as the number of terms evaluated, or is worse behaviour possible? We will not address such questions in further detail in this book.

8. These two header files are not identical, and in fact not compatible. Beware, if you compile C code with a C++ compiler [47].

## Chapter 4

### Numerical treatment of differential equations

In this chapter we will look at the numerical solution of Ordinary Differential Equations (ODEs) and Partial Differential Equations (PDEs). These equations are commonly used in physics to describe phenomena such as the flow of air around an aircraft, or the bending of a bridge under various stresses. While these equations are often fairly simple, getting specific numbers out of them ('how much does this bridge sag if there are a hundred cars on it') is more complicated, often taking large computers to produce the desired results. Here we will describe the techniques that turn ODEs and PDEs into computable problems.

First of all, we will look at Initial Value Problems (IVPs), which describes processes that develop in time. Here we only consider ODEs: scalar functions that are only depend on time. The name derives from the fact that typically the function is specified at an initial time point.

Next, we will look at Boundary Value Problems (BVPs), describing processes in space. In realistic situations, this will concern multiple space variables, so we have a PDE. The name BVP is explained by the fact that the solution is specified on the boundary of the domain of definition.

Finally, we will consider the 'heat equation', an Initial Boundary Value Problem (IBVP) which has aspects of both IVPs and BVPs: it describes heat spreading through a physical object such as a rod. The initial value describes the initial temperature, and the boundary values give prescribed temperatures at the ends of the rod.

Our aim in this chapter is to show the origins of an important class of computational problems. Therefore we will not go into theoretical matters of existence, uniqueness, or conditioning of solutions. For this, see [81] or any book that is specifically dedicated to ODEs or PDEs. For ease of analysis we will also assume that all functions involved have sufficiently many higher derivatives, and that each derivative is sufficiently smooth.

#### 4.1 Initial value problems

Many physical phenomena change over time, and typically the laws of physics give a description of the change, rather than of the quantity of interest itself. For instance, Newton's second law

$$F = ma$$

is a statement about the change in position of a point mass: expressed as

$$a = \frac{d^2}{dt^2}x = F/m$$

it states that acceleration depends linearly on the force exerted on the mass. A closed form description  $x(t) = \dots$  for the location of the mass can sometimes be derived analytically, but in many cases some form of approximation or numerical computation is needed.

Newton's equation is an ODE since it describes a function of one variable, time. It is an IVP since it describes the development in time, starting with some initial conditions. As an ODE, it is 'of second order' since it involves a second derivative, We can reduce this to first order, involving only first derivatives, if we allow vector quantities.

We introduce a two-component vector  $u$  that combines the location  $x$  and velocity  $x'$ <sup>1</sup>:

$$u(t) = (x(t), x'(t))^t,$$

Newton's equation expressed in  $u$  then becomes:

$$u' = Au + B, \quad A = \begin{pmatrix} 0 & 1 \\ 0 & 0 \end{pmatrix}, \quad B = \begin{pmatrix} 0 \\ F/a \end{pmatrix}$$

For simplicity, in this course we will only consider scalar equations; our reference equation is then

$$u'(t) = f(t, u(t)), \quad u(0) = u_0, \quad t > 0. \quad (4.1)$$

Equation (4.1) allows for an explicit time dependence of the process, but in general we only consider equations that do not have this explicit dependence, the so-called 'autonomous' ODEs of the form

$$u'(t) = f(u(t)) \quad (4.2)$$

in which the right hand side does not explicitly depend on  $t$ <sup>2</sup>.

Typically, the initial value in some starting point (often chosen as  $t = 0$ ) is given:  $u(0) = u_0$  for some value  $u_0$ , and we are interested in the behaviour of  $u$  as  $t \rightarrow \infty$ . As an example,  $f(x) = x$  gives the equation  $u'(t) = u(t)$ . This is a simple model for population growth: the equation states that the rate of growth is equal to the size of the population. The equation (4.1) can be solved analytically for some choices of  $f$ , but we will not consider this. Instead, we only consider the numerical solution and the accuracy of this process.

We will now consider numerical methods for the solution In a numerical method, we consider discrete size time steps to approximate the solution of the continuous time-dependent process. Since this introduces a certain amount of error, we will analyze the error introduced in each time step, and how this adds up to a global error. In some cases, the need to limit the global error will impose restrictions on the numerical scheme.

1. We use the prime symbol to indicate differentiation in case of functions of a single variable.

2. Non-autonomous ODEs can be transformed to autonomous ones, so this is no limitation. If  $u = u(t)$  is a scalar function and  $f = f(t, u)$ , we define  $u_2(t) = t$  and consider the equivalent autonomous system  $\begin{pmatrix} u' \\ u_2' \end{pmatrix} = \begin{pmatrix} f(u_2, u) \\ 1 \end{pmatrix}$

### 4.1.1 Error and stability

Since numerical computation will always involve the inaccuracies stemming from the use of machine arithmetic, we want to avoid the situation where a small perturbation in the initial value leads to large perturbations in the solution. Therefore, we will call a differential equation ‘stable’ if solutions corresponding to different initial values  $u_0$  converge to one another as  $t \rightarrow \infty$ .

A sufficient criterium for stability is:

$$\frac{\partial}{\partial u} f(u) = \begin{cases} > 0 & \text{unstable} \\ = 0 & \text{neutrally stable} \\ < 0 & \text{stable} \end{cases}$$

Proof. If  $u^*$  is a zero of  $f$ , meaning  $f(u^*) = 0$ , then the constant function  $u(t) \equiv u^*$  is a solution of  $u' = f(u)$ , a so-called ‘equilibrium’ solution. We will now consider how small perturbations from the equilibrium behave. Let  $u$  be a solution of the PDE, and write  $u(t) = u^* + \eta(t)$ , then we have

$$\begin{aligned} \eta' &= u' = f(u) = f(u^* + \eta) = f(u^*) + \eta f'(u^*) + O(\eta^2) \\ &= \eta f'(u^*) + O(\eta^2) \end{aligned}$$

Ignoring the second order terms, this has the solution

$$\eta(t) = e^{f'(x^*)t}$$

which means that the perturbation will damp out if  $f'(x^*) < 0$ .

We will often refer to the simple example  $f(u) = -\lambda u$ , with solution  $u(t) = u_0 e^{-\lambda t}$ . This problem is stable if  $\lambda > 0$ .

### 4.1.2 Finite difference approximation: Euler explicit and implicit methods

In order to solve the problem numerically, we turn the continuous problem into a discrete one by looking at finite time/space steps. Assuming all functions are sufficiently smooth, a straightforward *Taylor series* expansion<sup>3</sup> gives:

$$u(t + \Delta t) = u(t) + u'(t)\Delta t + u''(t)\frac{\Delta t^2}{2!} + u'''(t)\frac{\Delta t^3}{3!} + \dots$$

This gives for  $u'$ :

$$\begin{aligned} u'(t) &= \frac{u(t+\Delta t)-u(t)}{\Delta t} + \frac{1}{\Delta t} \left( u''(t)\frac{\Delta t^2}{2!} + u'''(t)\frac{\Delta t^3}{3!} + \dots \right) \\ &= \frac{u(t+\Delta t)-u(t)}{\Delta t} + \frac{1}{\Delta t} O(\Delta t^2) \\ &= \frac{u(t+\Delta t)-u(t)}{\Delta t} + O(\Delta t) \end{aligned} \tag{4.3}$$

We can approximate the infinite sum of higher derivatives by a single  $O(\Delta t^2)$  if all derivatives are bounded; alternatively, appendix 15 shows that this sum is equal to  $\Delta t^2 u''(t + \alpha \Delta t)$  with  $0 < \alpha < 1$ .

3. See appendix 15 if you are unfamiliar with this.

We see that we can approximate a differential operator by a *finite difference*, with an error that is known in its order of magnitude as a function of the time step.

Substituting this in  $u' = f(t, u)$  gives<sup>4</sup>

$$\frac{u(t + \Delta t) - u(t)}{\Delta t} = f(t, u(t)) + O(\Delta t)$$

or

$$u(t + \Delta t) = u(t) + \Delta t f(t, u(t)) + O(\Delta t^2)$$

We use this equation to derive a numerical scheme: with  $t_0 = 0$ ,  $t_{k+1} = t_k + \Delta t = \dots = (k + 1)\Delta t$ , we get a difference equation

$$u_{k+1} = u_k + \Delta t f(t_k, u_k)$$

for  $u_k$  quantities, and we hope that  $u_k$  will be a good approximation to  $u(t_k)$ . This is known as the ‘Explicit Euler’ or ‘Euler forward’ method.

The process of going from a differential equation to a difference equation is often referred to as *discretization*, since we compute function values only in a discrete set of points. The values computed themselves are still real valued. Another way of phrasing this: the numerical solution is found in the finite dimensional space  $\mathbb{R}^k$  if we compute  $k$  time steps. The solution to the original problem is found in the space of functions  $\mathbb{R} \rightarrow \mathbb{R}$ .

In (4.3) we approximated one operator by another, and in doing so made a *truncation error* of order  $O(\Delta t)$  as  $\Delta t \downarrow 0$  (see appendix 13 for a more formal introduction to this notation for orders of magnitude.). This does *not* immediately imply that the difference equation computes a solution that is close to the true solution. For that some more analysis is needed.

We start by analyzing the ‘local error’: if we assume the computed solution is exact at step  $k$ , that is,  $u_k = u(t_k)$ , how wrong will we be at step  $k + 1$ ? We have

$$\begin{aligned} u(t_{k+1}) &= u(t_k) + u'(t_k)\Delta t + u''(t_k)\frac{\Delta t^2}{2!} + \dots \\ &= u(t_k) + f(t_k, u(t_k))\Delta t + u''(t_k)\frac{\Delta t^2}{2!} + \dots \end{aligned}$$

and

$$u_{k+1} = u_k + f(t_k, u_k)\Delta t$$

So

$$\begin{aligned} L_{k+1} &= u_{k+1} - u(t_{k+1}) = u_k - u(t_k) + f(t_k, u_k) - f(t_k, u(t_k)) - u''(t_k)\frac{\Delta t^2}{2!} + \dots \\ &= -u''(t_k)\frac{\Delta t^2}{2!} + \dots \end{aligned}$$

---

4. The following equation is a mathematical equality, and should not be interpreted as a way of computing  $u'$  for a given function  $u$ . Recalling the discussion in section 3.3.4 you can see that this formula would quickly lead to cancellation for small  $\Delta t$ . For a discussion of numerical differentiation, see a numerical analysis textbook.



## 4. Numerical treatment of differential equations

---

This shows that in each step we make an error of  $O(\Delta t^2)$ . If we assume that these errors can be added, we find a global error of

$$E_k \approx \sum_k L_k = k\Delta t \frac{\Delta t^2}{2!} = O(\Delta t)$$

Since the global error is of first order in  $\Delta t$ , we call this a ‘first order method’. Note that this error, which measures the distance between the true and computed solutions, is of the same order  $O(\Delta t)$  as the truncation error, which is the error in approximating the operator.

### 4.1.2.1 Stability of the Euler explicit method

Consider the IVP  $u' = f(t, u)$  for  $t \geq 0$ , where  $f(t, u) = -\lambda u$  and an initial value  $u(0) = u_0$  is given. This has an exact solution of  $u(t) = u_0 e^{-\lambda t}$ . From the above discussion, we conclude that this problem is stable, meaning that small perturbations in the solution ultimately damp out, if  $\lambda > 0$ . We will now investigate the question of whether the numerical solution behaves the same way as the exact solution, that is, whether numerical solutions also converge to zero.

The Euler forward, or explicit Euler, scheme for this problem is

$$u_{k+1} = u_k - \Delta t \lambda u_k = (1 - \lambda \Delta t) u_k \Rightarrow u_k = (1 - \lambda \Delta t)^k u_0.$$

For stability, we require that  $u_k \rightarrow 0$  as  $k \rightarrow \infty$ . This is equivalent to

$$\begin{aligned} u_k \downarrow 0 &\Leftrightarrow |1 - \lambda \Delta t| < 1 \\ &\Leftrightarrow -1 < 1 - \lambda \Delta t < 1 \\ &\Leftrightarrow -2 < -\lambda \Delta t < 0 \\ &\Leftrightarrow 0 < \lambda \Delta t < 2 \\ &\Leftrightarrow \Delta t < 2/\lambda \end{aligned}$$

We see that the stability of the numerical solution scheme depends on the value of  $\Delta t$ : the scheme is only stable if  $\Delta t$  is small enough. For this reason, we call the explicit Euler method *conditionally stable*. Note that the stability of the differential equation and the stability of the numerical scheme are two different questions. The continuous problem is stable if  $\lambda > 0$ ; the numerical problem has an additional condition that depends on the discretization scheme used.

Note that the stability analysis we just performed was specific to the differential equation  $u' = -\lambda u$ . If you are dealing with a different IVP you have to perform a separate analysis. However, you will find that explicit methods typically give conditional stability.

### 4.1.2.2 The Euler implicit method

The explicit method you just saw was easy to compute, but the conditional stability is a potential problem. For instance, it could imply that the number of time steps would be a limiting factor. There is an alternative to the explicit method that does not suffer from the same objection.

Instead of expanding  $u(t + \Delta t)$ , consider the following expansion of  $u(t - \Delta t)$ :

$$u(t - \Delta t) = u(t) - u'(t)\Delta t + u''(t)\frac{\Delta t^2}{2!} + \dots$$

which implies

$$u'(t) = \frac{u(t) - u(t - \Delta t)}{\Delta t} + u''(t)\Delta t/2 + \dots$$

As before, we take the equation  $u'(t) = f(t, u(t))$  and approximate  $u'(t)$  by a difference formula:

$$\frac{u(t) - u(t - \Delta t)}{\Delta t} = f(t, u(t)) + O(\Delta t) \Rightarrow u(t) = u(t - \Delta t) + \Delta t f(t, u(t)) + O(\Delta t^2)$$

Again we define fixed points  $t_k = kt$ , and we define a numerical scheme:

$$u_{k+1} = u_k + \Delta t f(t_{k+1}, u_{k+1})$$

where  $u_k$  is an approximation of  $u(t_k)$ .

An important difference with the explicit scheme is that  $u_{k+1}$  now also appears on the right hand side of the equation. That is, computation of  $u_{k+1}$  is now implicit. For example, let  $f(t, u) = -u^3$ , then  $u_{k+1} = u_k - \Delta t u_{k+1}^3$ . In other words,  $u_{k+1}$  is the solution for  $x$  of the equation  $\Delta t x^3 + x = u_k$ . This is a nonlinear equation, which typically can be solved using the Newton method.

#### 4.1.2.3 Stability of the implicit Euler method

Let us take another look at the example  $f(t, u) = -\lambda u$ . Formulating the implicit method gives

$$u_{k+1} = u_k - \lambda \Delta t u_{k+1} \Leftrightarrow (1 + \lambda \Delta t) u_{k+1} = u_k$$

so

$$u_{k+1} = \left( \frac{1}{1 + \lambda \Delta t} \right) u_k \Rightarrow u_k = \left( \frac{1}{1 + \lambda \Delta t} \right)^k u_0.$$

If  $\lambda > 0$ , which is the condition for a stable equation, we find that  $u_k \rightarrow 0$  for all values of  $\lambda$  and  $\Delta t$ . This method is called *unconditionally stable*. One advantage of an implicit method over an explicit one is clearly the stability: it is possible to take larger time steps without worrying about unphysical behaviour. Of course, large time steps can make convergence to the *steady state* (see Appendix 14.4) slower, but at least there will be no divergence.

On the other hand, implicit methods are more complicated. As you saw above, they can involve nonlinear systems to be solved in every time step. In cases where  $u$  is vector-valued, such as in the heat equation, discussed below, you will see that the implicit method requires the solution of a system of equations.

**Exercise 4.1.** Analyse the accuracy and computational aspects of the following scheme for the IVP  $u'(x) = f(x)$ :

$$u_{i+1} = u_i + h(f(x_i) + f(x_{i+1}))/2$$

which corresponds to adding the Euler explicit and implicit schemes together. You do not have to analyze the stability of this scheme.

**Exercise 4.2.** Consider the initial value problem  $y'(t) = y(t)(1 - y(t))$ . Observe that  $y \equiv 0$  and  $y \equiv 1$  are solutions. These are called ‘equilibrium solutions’.

1. A solution is stable, if perturbations ‘converge back to the solution’, meaning that for  $\epsilon$  small enough,

$$\text{if } y(t) = \epsilon \text{ for some } t, \text{ then } \lim_{t \rightarrow \infty} y(t) = 0$$

and

$$\text{if } y(t) = 1 + \epsilon \text{ for some } t, \text{ then } \lim_{t \rightarrow \infty} y(t) = 1$$

This requires for instance that

$$y(t) = \epsilon \Rightarrow y'(t) < 0.$$

Investigate this behaviour. Is zero a stable solution? Is one?

2. Consider the explicit method

$$y_{k+1} = y_k + \Delta t y_k (1 - y_k)$$

for computing a numerical solution to the differential equation. Show that

$$y_k \in (0, 1) \Rightarrow y_{k+1} > y_k, \quad y_k > 1 \Rightarrow y_{k+1} < y_k$$

3. Write a small program to investigate the behaviour of the numerical solution under various choices for  $\Delta t$ . Include program listing and a couple of runs in your homework submission.
4. You see from running your program that the numerical solution can oscillate. Derive a condition on  $\Delta t$  that makes the numerical solution monotone. It is enough to show that  $y_k < 1 \Rightarrow y_{k+1} < 1$ , and  $y_k > 1 \Rightarrow y_{k+1} > 1$ .
5. Now consider the implicit method

$$y_{k+1} - \Delta t y_{k+1} (1 - y_{k+1}) = y_k$$

and show that  $y_{k+1}$  is easily computed from  $y_k$ . Write a program, and investigate the behaviour of the numerical solution under various choices for  $\Delta t$ .

6. Show that the numerical solution of the implicit scheme is monotone for all choices of  $\Delta t$ .

## 4.2 Boundary value problems

In the previous section you saw initial value problems, which model phenomena that evolve over time. We will now move on to ‘boundary value problems’, which are in general stationary in time, but which describe a phenomenon that is location dependent. Examples would be the shape of a bridge under a load, or the heat distribution in a window pane, as the temperature outside differs from the one inside.

The general form of a (second order, one-dimensional) BVP is<sup>5</sup>

$$u''(x) = f(x, u, u') \text{ for } x \in [a, b] \text{ where } u(a) = u_a, u(b) = u_b$$

but here we will only consider the simple form

$$-u''(x) = f(x) \text{ for } x \in [0, 1] \text{ with } u(0) = u_0, u(1) = u_1. \quad (4.4)$$

in one space dimension, or

$$-u_{xx}(\bar{x}) - u_{yy}(\bar{x}) = f(\bar{x}) \text{ for } \bar{x} \in \Omega = [0, 1]^2 \text{ with } u(\bar{x}) = u_0 \text{ on } \delta\Omega. \quad (4.5)$$

in two space dimensions. Here,  $\delta\Omega$  is the boundary of the domain  $\Omega$ . Since we prescribe the value of  $u$  on the boundary, such a problem is called a Boundary Value Problem (BVP).

### 4.2.1 General PDE theory

There are several types of PDE, each with distinct mathematical properties. The most important property is that of *region of influence*: if we tinker with the problem so that the solution changes in one point, what other points will be affected.

- *Hyperbolic PDEs* are of the form

$$Au_{xx} + Bu_{yy} + \text{lower order terms} = 0$$

with  $A, B$  of opposite sign. Such equations describe waves, or more general convective phenomena, that are conservative, and do not tend to a steady state.

Intuitively, changing the solution of a wave equation at any point will only change certain future points, since waves have a propagation speed that makes it impossible for a point to influence points in the near future that are too far away in space. This type of PDE will not be discussed in this book.

- *Parabolic PDEs* are of the form

$$Au_x + Bu_{yy} + \text{no higher order terms in } x = 0$$

and they describe diffusion-like phenomena; these often tend to a *steady state*. The best way to characterize them is to consider that the solution in each point in space and time is influenced by a certain finite region at each previous point in space<sup>6</sup>. The *heat equation* (section 4.3) is the standard example of this type.

5. Actually, the boundary conditions can be more general, involving derivatives on the interval end points. Here we only look at *Dirichlet boundary conditions* which prescribe function values on the boundary of the domain.

6. This leads to a condition limiting the time step in *IBVP*, known as the *Courant-Friedrichs-Lewy condition* [http://en.wikipedia.org/wiki/CourantFriedrichsLewy\\_condition](http://en.wikipedia.org/wiki/CourantFriedrichsLewy_condition). It describes the notion that in the exact problem  $u(x, t)$  depends on a range of  $u(x', t - \Delta t)$  values; the time step of the numerical method has to be small enough that the numerical solution takes all these points into account.

- *Elliptic PDEs* have the form

$$Au_{xx} + Bu_{yy} + \text{lower order terms} = 0$$

where  $A, B > 0$ ; they typically describe processes that have reached a *steady state*, for instance as  $t \rightarrow \infty$  in a parabolic problem. They are characterized by the fact that all points influence each other. These equations often describe phenomena in structural mechanics, such as a beam or a membrane. It is intuitively clear that pressing down on any point of a membrane will change the elevation of every other point, no matter how little. The *Poisson equation* (section 4.2.2) is the standard example of this type.

#### 4.2.2 The Poisson equation in one space dimension

We call the operator  $\Delta$ , defined by

$$\Delta u = u_{xx} + u_{yy},$$

a second order *differential operator*, and equation (4.5) a second-order PDE. Specifically, the problem

$$-\Delta u = -u_{xx}(\bar{x}) - u_{yy}(\bar{x}) = f(\bar{x}) \text{ for } \bar{x} \in \Omega = [0, 1]^2 \text{ with } u(\bar{x}) = u_0 \text{ on } \delta\Omega. \quad (4.6)$$

is called the *Poisson equation*, in this case defined on the unit square. Second order PDEs are quite common, describing many phenomena in fluid and heat flow and structural mechanics.

At first, for simplicity, we consider the one-dimensional Poisson equation

$$-u_{xx} = f(x).$$

and we consider the two-dimensional case below; the extension to three dimensions will then be clear.

In order to find a numerical scheme we use Taylor series as before, expressing  $u(x + h)$  and  $u(x - h)$  in terms of  $u$  and its derivatives at  $x$ . Let  $h > 0$ , then

$$u(x + h) = u(x) + u'(x)h + u''(x)\frac{h^2}{2!} + u'''(x)\frac{h^3}{3!} + u^{(4)}(x)\frac{h^4}{4!} + u^{(5)}(x)\frac{h^5}{5!} + \dots$$

and

$$u(x - h) = u(x) - u'(x)h + u''(x)\frac{h^2}{2!} - u'''(x)\frac{h^3}{3!} + u^{(4)}(x)\frac{h^4}{4!} - u^{(5)}(x)\frac{h^5}{5!} + \dots$$

Our aim is now to approximate  $u''(x)$ . We see that the  $u'$  terms in these equations would cancel out under addition, leaving  $2u(x)$ :

$$u(x + h) + u(x - h) = 2u(x) + u''(x)h^2 + u^{(4)}(x)\frac{h^4}{12} + \dots$$

so

$$-u''(x) = \frac{2u(x) - u(x + h) - u(x - h)}{h^2} + u^{(4)}(x)\frac{h^2}{12} + \dots \quad (4.7)$$

The basis for a numerical scheme for (4.4) is then the observation

$$\frac{2u(x) - u(x+h) - u(x-h)}{h^2} = f(x, u(x), u'(x)) + O(h^2),$$

which shows that we can approximate the differential operator by a difference operator, with an  $O(h^2)$  truncation error as  $h \downarrow 0$ .

To derive a numerical method, we divide the interval  $[0, 1]$  into equally spaced points:  $x_k = kh$  where  $h = 1/(n+1)$  and  $k = 0 \dots n+1$ . With these, the Finite Difference (FD) formula (4.7) leads to a numerical scheme that forms a system of equations:

$$-u_{k+1} + 2u_k - u_{k-1} = h^2 f(x_k) \quad \text{for } k = 1, \dots, n \quad (4.8)$$

This process of using the FD formula (4.7) for the approximate solution of a PDE is known as the *Finite Difference Method (FDM)*.

For most values of  $k$  this equation relates  $u_k$  unknown to the unknowns  $u_{k-1}$  and  $u_{k+1}$ . The exceptions are  $k = 1$  and  $k = n$ . In that case we recall that  $u_0$  and  $u_{n+1}$  are known boundary conditions, and we write the equations with unknowns on the left and known quantities on the right as

$$\begin{cases} 2u_1 - u_2 = h^2 f(x_1) + u_0 \\ 2u_n - u_{n-1} = h^2 f(x_n) + u_{n+1}. \end{cases}$$

We can now summarize these equations for  $u_k, k = 1 \dots n-1$  as a matrix equation:

$$\begin{pmatrix} 2 & -1 & & \\ -1 & 2 & -1 & \\ & & \ddots & \ddots & \ddots \end{pmatrix} \begin{pmatrix} u_1 \\ u_2 \\ \vdots \end{pmatrix} = \begin{pmatrix} h^2 f_1 + u_0 \\ h^2 f_2 \\ \vdots \end{pmatrix} \quad (4.9)$$

This has the form  $Au = f$  with  $A$  a fully known matrix,  $f$  a fully known vector, and  $u$  a vector of unknowns. Note that the right hand side vector has the boundary values of the problem in the first and last locations. This means that, if you want to solve the same differential equation with different boundary conditions, only the vector  $f$  changes.

**Exercise 4.3.** A condition of the type  $u(0) = u_0$  is called a *Dirichlet boundary condition*.

Physically, this corresponds to knowing the temperature at the end point of a rod. Other boundary conditions exist. Specifying a value for the derivative,  $u'(0) = u'_0$ , rather than for the function value, would be appropriate if we are modeling fluid flow and the outflow rate at  $x = 0$  is known. This is known as a *Neumann boundary condition*.

A Neumann boundary condition  $u'(0) = u'_0$  can be modeled by stating

$$\frac{u_0 - u_1}{h} = u'_0.$$

Show that, unlike in the case of the Dirichlet boundary condition, this affects the matrix of the linear system.

Show that having a Neumann boundary condition at both ends gives a singular matrix, and therefore no unique solution to the linear system. (Hint: guess the vector that has eigenvalue zero.)

Physically this makes sense. For instance, in an elasticity problem, Dirichlet boundary conditions state that the rod is clamped at a certain height; a Neumann boundary condition only states its angle at the end points, which leaves its height undetermined.

Let us list some properties of  $A$  that you will see later are relevant for solving such systems of equations:

- The matrix is very *sparse*: the percentage of elements that is nonzero is low. The nonzero elements are not randomly distributed but located in a band around the main diagonal. We call this a *banded matrix* in general, and a *tridiagonal matrix* in this specific case.
- The matrix is symmetric. This property does not hold for all matrices that come from discretizing BVPs, but it is true if there are no odd order (meaning first, third, fifth, . . .) derivatives, such as  $u_x, u_{xxx}, u_{xy}$ .
- Matrix elements are constant in each diagonal, that is, in each set of points  $\{(i, j) : i - j = c\}$  for some  $c$ . This is only true for very simple problems. It is no longer true if the differential equation has location dependent terms such as  $\frac{d}{dx}(a(x)\frac{d}{dx}u(x))$ . It is also no longer true if we make  $h$  variable through the interval, for instance because we want to model behaviour around the left end point in more detail.
- Matrix elements conform to the following sign pattern: the diagonal elements are positive, and the off-diagonal elements are nonpositive. This property depends on the numerical scheme used, but it is often true. Together with the following property of definiteness, this is called an *M-matrix*. There is a whole mathematical theory of these matrices [9].
- The matrix is positive definite:  $x^t Ax > 0$  for all nonzero vectors  $x$ . This property is inherited from the original continuous problem, if the numerical scheme is carefully chosen. While the use of this may not seem clear at the moment, later you will see methods for solving the linear system that depend on it.

Strictly speaking the solution of equation (4.9) is simple:  $u = A^{-1}f$ . However, computing  $A^{-1}$  is not the best way of finding  $u$ . As observed just now, the matrix  $A$  has only  $3N$  nonzero elements to store. Its inverse, on the other hand, does not have a single nonzero. Although we will not prove it, this sort of statement holds for most sparse matrices. Therefore, we want to solve  $Au = f$  in a way that does not require  $O(n^2)$  storage.

### 4.2.3 The Poisson equation in two space dimensions

The one-dimensional BVP above was atypical in a number of ways, especially related to the resulting linear algebra problem. In this section we will investigate the two-dimensional Poisson problem. You'll see that it constitutes a non-trivial generalization of the one-dimensional problem. The three-dimensional case is very much like the two-dimensional case, so we will not discuss it. (For one essential difference, see the discussion in section 6.8.1.)

The one-dimensional problem above had a function  $u = u(x)$ , which now becomes  $u = u(x, y)$  in two dimensions. The two-dimensional problem we are interested is then

$$-u_{xx} - u_{yy} = f, \quad (x, y) \in [0, 1]^2, \quad (4.10)$$

where the values on the boundaries are given. We get our discrete equation by applying equation (4.7) in  $x$  and  $y$  directions:

$$\begin{aligned} -u_{xx}(x, y) &= \frac{2u(x,y)-u(x+h,y)-u(x-h,y)}{h^2} + u^{(4)}(x, y)\frac{h^2}{12} + \dots \\ -u_{yy}(x, y) &= \frac{2u(x,y)-u(x,y+h)-u(x,y-h)}{h^2} + u^{(4)}(x, y)\frac{h^2}{12} + \dots \end{aligned}$$

or, taken together:

$$4u(x, y) - u(x + h, y) - u(x - h, y) - u(x, y + h) - u(x, y - h) = 1/h^2 f(x, y) + O(h^2) \quad (4.11)$$

Let again  $h = 1/(n + 1)$  and define  $x_i = ih$  and  $y_j = jh$ ; let  $u_{ij}$  be the approximation to  $u(x_i, y_j)$ , then our discrete equation becomes

$$4u_{ij} - u_{i+1,j} - u_{i-1,j} - u_{i,j+1} - u_{i,j-1} = h^{-2} f_{ij}. \quad (4.12)$$

We now have  $n \times n$  unknowns  $u_{ij}$ . To render this in a linear system as before we need to put them in a linear ordering, which we do by defining  $I = I_{ij} = j + i \times n$ . This is called the *lexicographic ordering* since it sorts the coordinates  $(i, j)$  as if they are strings.

Using this ordering gives us  $N = n^2$  equations

$$4u_I - u_{I+1} - u_{I-1} - u_{I+n} - u_{I-n} = h^{-2} f_I, \quad I = 1, \dots, N \quad (4.13)$$

and the linear system looks like

$$A = \left( \begin{array}{cccc|ccc|c} 4 & -1 & & \emptyset & -1 & & & \emptyset \\ -1 & 4 & -1 & & & -1 & & \\ & & \ddots & \ddots & \ddots & & & \\ & & & \ddots & & \ddots & & \\ & & & & \ddots & & & -1 \\ \hline \emptyset & & & -1 & 4 & & & -1 \\ -1 & & & \emptyset & & & & \\ & -1 & & & 4 & -1 & & -1 \\ & & \uparrow & & \uparrow & \uparrow & & \uparrow \\ & & k-n & & k-1 & k & k+1 & k+n \\ & & & -1 & & & -1 & \\ \hline & & & & & & -1 & 4 \\ & & & & \ddots & & & \ddots \end{array} \right) \quad (4.14)$$

As in the one-dimensional case, we see that a BVP gives rise to a *sparse matrix*.

It may seem the natural thing to consider this system of linear equations in its matrix form. However, it can be more insightful to render these equations in a way that makes clear the two-dimensional connections of the unknowns. For this, figure 4.1 pictures the variables in the domain, and how equation (4.12) relates them. From now on, when making such a picture of the domain, we will just use the indices of the variables, and omit the ‘ $u$ ’ identifier.



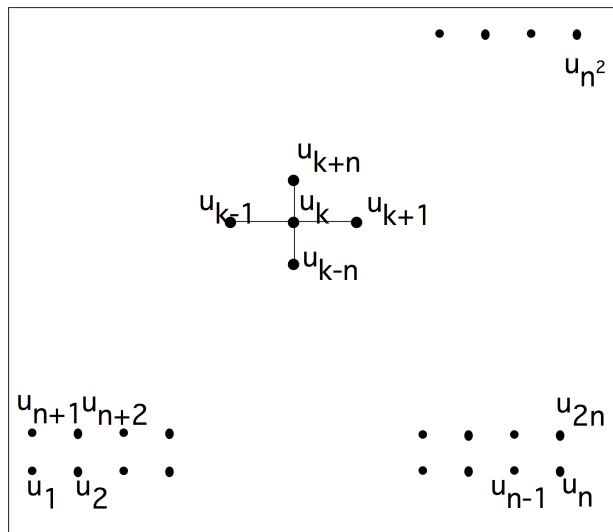

Figure 4.1: A difference stencil applied to a two-dimensional square domain

The matrix of equation 4.14 is banded as in the one-dimensional case, but unlike in the one-dimensional case, there are zeros inside the band. (This has some important consequences when we try to solve the linear system; see section 5.4.3.) Because the matrix has five nonzero diagonals, it is said to be of *penta-diagonal* structure.

You can also put a block structure on the matrix, by grouping the unknowns together that are in one row of the domain. This is called a *block matrix*, and, on the block level, it has a *tridiagonal* structure, so we call this a *block tridiagonal* matrix. Note that the diagonal blocks themselves are tridiagonal; the off-diagonal blocks are minus the identity matrix.

This matrix, like the one-dimensional example above, has constant diagonals, but this is again due to the simple nature of the problem. In practical problems it will not be true. That said, such ‘constant coefficient’ problems occur, and when they are on rectangular domains, there are very efficient methods for solving the linear system with  $N \log N$  time complexity.

**Exercise 4.4.** The block structure of the matrix, with all diagonal blocks having the same size, is due to the fact that we defined our BVP on a square domain. Sketch the matrix structure that arises from discretizing equation (4.10), again with central differences, but this time defined on a triangular domain; see figure 4.2. Show that, again, there is a block tridiagonal matrix structure, but that the blocks are now of varying sizes. Hint: start by sketching a small example. For  $n = 4$  you should get a  $10 \times 10$  matrix with a  $4 \times 4$  block structure.

For domains that are even more irregular, the matrix structure will also be irregular.

The regular block structure is also caused by our decision to order the unknowns by rows and columns. This known as the *natural ordering* or *lexicographic ordering*; various other orderings are possible. One common way of ordering the unknowns is the *red-black ordering* or *checkerboard ordering* which has advantages for parallel computation. This will be discussed in section 6.7.

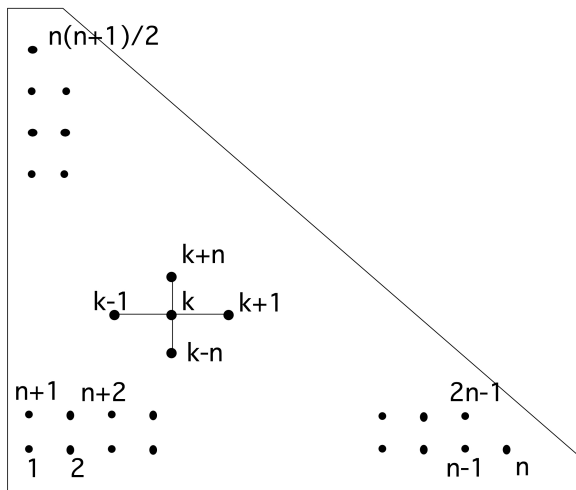

Figure 4.2: A triangular domain of definition for the Poisson equation

There is more to say about analytical aspects of the BVP (for instance, how smooth is the solution and how does that depend on the boundary conditions?) but those questions are outside the scope of this course. Here we only focus on the numerical aspects of the matrices. In the chapter on linear algebra, we will come back to the BVP, since solving the linear system is mathematically interesting.

#### 4.2.4 Difference stencils

The discretization (4.11) is often phrased as applying the *difference stencil*

$$\begin{array}{ccc} \cdot & -1 & \cdot \\ -1 & 4 & -1 \\ \cdot & -1 & \cdot \end{array}$$

to the function  $u$ . Given a physical domain, we apply the stencil to each point in that domain to derive the equation for that point. Figure 4.1 illustrates that for a square domain of  $n \times n$  points. Connecting this figure with equation (4.14), you see that the connections in the same line give rise to the main diagonal and first upper and lower offdiagonal; the connections to the next and previous lines become the nonzeros in the off-diagonal blocks.

This particular stencil is often referred to as the ‘5-point star’. There are other difference stencils; the structure of some of them are depicted in figure 4.3. A stencil with only connections in horizontal or vertical direction is called a ‘star stencil’, while one that has cross connections (such as the second in figure 4.3) is called a ‘box stencil’.

**Exercise 4.5.** Consider the third stencil in figure 4.3, used for a BVP on a square domain. What does the sparsity structure of the resulting matrix look like, if we again order the variables by rows and columns?

Other stencils than the 5-point star can be used to attain higher accuracy, for instance giving a truncation error of  $O(h^4)$ . They can also be used for other differential equations than the one discussed above. For

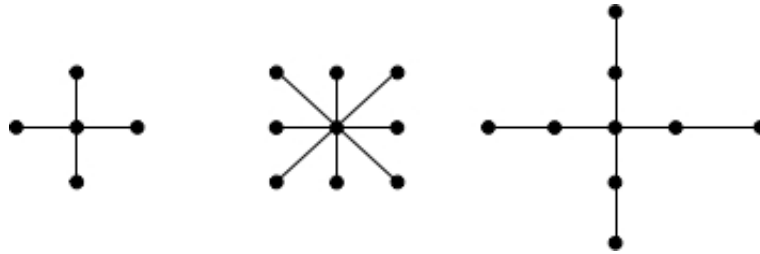

Figure 4.3: The structure of some difference stencils in two dimensions

instance, it is not hard to show that for the equation  $u_{xxxx} + u_{yyyy} = f$  we need a stencil that contains both  $x, y \pm h$  and  $x, y \pm 2h$  connections, such as the third stencil in the figure. Conversely, using the 5-point stencil no values of the coefficients give a discretization of the fourth order problem with less than  $O(1)$  truncation error.

While the discussion so far has been about two-dimensional problems, it is easily generalized to higher dimensions for such equations as  $-u_{xx} - u_{yy} - u_{zz} = f$ . The straightforward generalization of the 5-point stencil, for instance, becomes a 7-point stencil in three dimensions.

#### 4.2.5 Other discretization techniques

In the above, we used the FDM to find a numerical solution to a differential equation. There are various other techniques, and in fact, in the case of boundary value problems, they are usually preferred over finite differences. The most popular methods are the *FEM* and the *finite volume method*. Especially the finite element method is attractive, since it can handle irregular shapes more easily, and it is more amenable to approximation error analysis. However, on the simple problems discussed here it gives similar or even the same linear systems as FD methods, so we limit the discussion to Finite Differences, since we are mostly concerned with the computational aspects of the linear systems.

There will be a brief discussion of finite element matrices in section [6.6.2](#).

### 4.3 Initial boundary value problem

We will now go on to discuss an Initial Boundary Value Problem (IBVP), which, as you may deduce from the name, combines aspects of IVPs and BVPs. Here we will limit ourselves to one space dimension.

The problem we are considering is that of heat conduction in a rod, where  $T(x, t)$  describes the temperature in location  $x$  at time  $t$ , for  $x \in [a, b]$ ,  $t > 0$ . The so-called *heat equation* (see [Appendix 14](#) for a quick introduction to PDEs in general and the heat equation in particular) is:

$$\frac{\partial}{\partial t} T(x, t) - \alpha \frac{\partial^2}{\partial x^2} T(x, t) = q(x, t)$$

where

- The initial condition  $T(x, 0) = T_0(x)$  describes the initial temperature distribution.

- The boundary conditions  $T(a, t) = T_a(t)$ ,  $T(b, t) = T_b(t)$  describe the ends of the rod, which can for instance be fixed to an object of a known temperature.
- The material the rod is made of is modeled by a single parameter  $\alpha > 0$ , the thermal diffusivity, which describes how fast heat diffuses through the material.
- The forcing function  $q(x, t)$  describes externally applied heating, as a function of both time and place.

There is a simple connection between the IBVP and the BVP: if the boundary functions  $T_a$  and  $T_b$  are constant, and  $q$  does not depend on time, only on location, then intuitively  $T$  will converge to a *steady state*. The equation for this is  $-\alpha u''(x) = q$ .

### 4.3.1 Discretization

We now discretize both space and time, by  $x_{j+1} = x_j + \Delta x$  and  $t_{k+1} = t_k + \Delta t$ , with boundary conditions  $x_0 = a$ ,  $x_n = b$ , and  $t_0 = 0$ . We write  $T_j^k$  for the numerical solution at  $x = x_j$ ,  $t = t_k$ ; with a little luck, this will approximate the exact solution  $T(x_j, t_k)$ .

For the space discretization we use the central difference formula (4.8):

$$\left. \frac{\partial^2}{\partial x^2} T(x, t_k) \right|_{x=x_j} \Rightarrow \frac{T_{j-1}^k - 2T_j^k + T_{j+1}^k}{\Delta x^2}.$$

For the time discretization we can use any of the schemes in section 4.1.2. We will investigate again the explicit and implicit schemes, with similar conclusions about the resulting stability.

#### 4.3.1.1 Explicit scheme

With explicit time stepping we approximate the time derivative as

$$\left. \frac{\partial}{\partial t} T(x_j, t) \right|_{t=t_k} \Rightarrow \frac{T_j^{k+1} - T_j^k}{\Delta t}. \quad (4.15)$$

Taking this together with the central differences in space, we now have

$$\frac{T_j^{k+1} - T_j^k}{\Delta t} - \alpha \frac{T_{j-1}^k - 2T_j^k + T_{j+1}^k}{\Delta x^2} = q_j^k$$

which we rewrite as

$$T_j^{k+1} = T_j^k + \frac{\alpha \Delta t}{\Delta x^2} (T_{j-1}^k - 2T_j^k + T_{j+1}^k) + \Delta t q_j^k \quad (4.16)$$

Pictorially, we render this as a difference stencil in figure 4.4. This expresses that the function value in each point is determined by a combination of points on the previous time level.

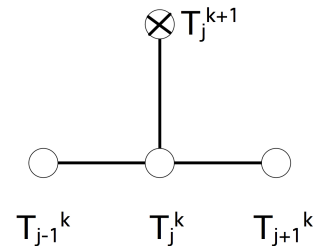

Figure 4.4: The difference stencil of the Euler forward method for the heat equation

#### 4. Numerical treatment of differential equations

It is convenient to summarize the set of equations (4.16) for a given  $k$  and all values of  $j$  in vector form as

$$T^{k+1} = \left( I - \frac{\alpha \Delta t}{\Delta x^2} K \right) T^k + \Delta t q^k \quad (4.17)$$

where

$$K = \begin{pmatrix} 2 & -1 & & & \\ -1 & 2 & -1 & & \\ & \ddots & \ddots & \ddots & \\ & & & & \ddots \end{pmatrix}, \quad T^k = \begin{pmatrix} T_1^k \\ \vdots \\ T_n^k \end{pmatrix}.$$

The important observation here is that the dominant computation for deriving the vector  $T^{k+1}$  from  $T^k$  is a simple matrix-vector multiplication:

$$T^{k+1} \leftarrow AT^k + \Delta t q^k$$

where  $A = I - \frac{\alpha \Delta t}{\Delta x^2} K$ . This is a first indication that the sparse matrix-vector product is an important operation; see sections 5.4 and 6.5. Actual computer programs using an explicit method often do not form the matrix, but evaluate the equation (4.16). However, the linear algebra formulation (4.17) is more insightful for purposes of analysis.

In later chapters we will consider parallel execution of operations. For now, we note that the explicit scheme is trivially parallel: each point can be updated with just the information of a few surrounding points.

##### 4.3.1.2 Implicit scheme

In equation (4.15) we let  $T^{k+1}$  be defined from  $T^k$ . We can turn this around by defining  $T^k$  from  $T^{k+1}$ , as we did for the IVP in section 4.1.2.2. For the time discretization this gives

$$\left. \frac{\partial}{\partial t} T(x, t) \right|_{t=t_k} \Rightarrow \frac{T_j^k - T_j^{k-1}}{\Delta t} \quad \text{or} \quad \left. \frac{\partial}{\partial t} T(x, t) \right|_{t=t_{k+1}} \Rightarrow \frac{T_j^{k+1} - T_j^k}{\Delta t}. \quad (4.18)$$

The implicit time step discretization of the whole heat equation, evaluated in  $t_{k+1}$ , now becomes:

$$\frac{T_j^{k+1} - T_j^k}{\Delta t} - \alpha \frac{T_{j-1}^{k+1} - 2T_j^{k+1} + T_{j+1}^{k+1}}{\Delta x^2} = q_j^{k+1}$$

or

$$T_j^{k+1} - \frac{\alpha \Delta t}{\Delta x^2} (T_{j-1}^{k+1} - 2T_j^{k+1} + T_{j+1}^{k+1}) = T_j^k + \Delta t q_j^{k+1} \quad (4.19)$$

Figure 4.5 renders this as a stencil; this expresses that each point on the current time level influences a combination of points on the next level. Again we write this in vector form:

$$\left( I + \frac{\alpha \Delta t}{\Delta x^2} K \right) T^{k+1} = T^k + \Delta t q^{k+1} \quad (4.20)$$

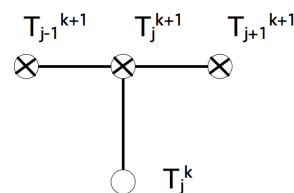

Figure 4.5: The difference stencil of the Euler backward method for the heat equation

As opposed to the explicit method, where a matrix-vector multiplication sufficed, the derivation of the vector  $T^{k+1}$  from  $T^k$  now involves solving a linear system

$$T^{k+1} \leftarrow A^{-1}(T^k + \Delta t q^{k+1})$$

where  $A = I + \frac{\alpha \Delta t}{\Delta x^2} K$ , a harder operation than the matrix-vector multiplication. In this case, it is not possible, as above, to evaluate the equation (4.19) directly. Codes using an implicit method actually form the coefficient matrix, and solve the system (4.20) as such. Solving linear systems will be the focus of much of chapters 5 and 6.

In contrast to the explicit scheme, we now have no obvious parallelization strategy. The parallel solution of linear systems will occupy us in sections 6.6 and on.

**Exercise 4.6.** Show that the flop count for a time step of the implicit method is of the same order as of a time step of the explicit method. (This only holds for a problem with one space dimension.) Give at least one argument why we consider the implicit method as computationally ‘harder’.

The numerical scheme that we used here is of first order in time and second order in space: the truncation error (section 4.1.2) is  $O(\Delta t + \Delta x^2)$ . It would be possible to use a scheme that is second order in time by using central differences in time too. Alternatively, see exercise 4.7.

### 4.3.2 Stability analysis

We now analyse the stability of the explicit and implicit schemes in a simple case. Let  $q \equiv 0$ , and assume  $T_j^k = \beta^k e^{i\ell x_j}$  for some  $\ell^7$ . This assumption is intuitively defensible: since the differential equation does not ‘mix’ the  $x$  and  $t$  coordinates, we surmise that the solution will be a product  $T(x, t) = v(x) \cdot w(t)$  of the separate solutions of

$$\begin{cases} v_{xx} = c_1 v, & v(0) = 0, v(1) = 0 \\ w_t = c_2 w & w(0) = 1 \end{cases}$$

The only meaningful solution occurs with  $c_1, c_2 < 0$ , in which case we find:

$$v_{xx} = -c^2 v \Rightarrow v(x) = e^{-icx} = e^{-i\ell\pi x}$$

where we substitute  $c = \ell\pi$  to take boundary conditions into account, and

$$w(t) = e^{-ct} = e^{-ck\Delta t} = \beta^k, \quad \beta = e^{-ck}.$$

If the assumption on this form of the solution holds up, we need  $|\beta| < 1$  for stability.

7. Actually,  $\beta$  is also dependent on  $\ell$ , but we will save ourselves a bunch of subscripts, since different  $\beta$  values never appear together in one formula.

Substituting the surmised form for  $T_j^k$  into the explicit scheme gives

$$\begin{aligned}
 T_j^{k+1} &= T_j^k + \frac{\alpha \Delta t}{\Delta x^2} (T_{j-1}^k - 2T_j^k + T_{j+1}^k) \\
 \Rightarrow \beta^{k+1} e^{i\ell x_j} &= \beta^k e^{i\ell x_j} + \frac{\alpha \Delta t}{\Delta x^2} (\beta^k e^{i\ell x_{j-1}} - 2\beta^k e^{i\ell x_j} + \beta^k e^{i\ell x_{j+1}}) \\
 &= \beta^k e^{i\ell x_j} \left[ 1 + \frac{\alpha \Delta t}{\Delta x^2} [e^{-i\ell \Delta x} - 2 + e^{i\ell \Delta x}] \right] \\
 \Rightarrow \beta &= 1 + 2 \frac{\alpha \Delta t}{\Delta x^2} \left[ \frac{1}{2} (e^{i\ell \Delta x} + e^{-i\ell \Delta x}) - 1 \right] \\
 &= 1 + 2 \frac{\alpha \Delta t}{\Delta x^2} (\cos(\ell \Delta x) - 1)
 \end{aligned}$$

For stability we need  $|\beta| < 1$ :

- $\beta < 1 \Leftrightarrow 2 \frac{\alpha \Delta t}{\Delta x^2} (\cos(\ell \Delta x) - 1) < 0$ : this is true for any  $\ell$  and any choice of  $\Delta x, \Delta t$ .
- $\beta > -1 \Leftrightarrow 2 \frac{\alpha \Delta t}{\Delta x^2} (\cos(\ell \Delta x) - 1) > -2$ : this is true for all  $\ell$  only if  $2 \frac{\alpha \Delta t}{\Delta x^2} < 1$ , that is

$$\Delta t < \frac{\Delta x^2}{2\alpha}$$

The latter condition poses a big restriction on the allowable size of the time steps: time steps have to be small enough for the method to be stable. This is similar to the stability analysis of the explicit method for the IVP; however, now the time step is also related to the space discretization. This implies that, if we decide we need more accuracy in space and we halve the space discretization  $\Delta x$ , the number of time steps will be multiplied by four.

Let us now consider the stability of the implicit scheme. Substituting the form of the solution  $T_j^k = \beta^k e^{i\ell x_j}$  into the numerical scheme gives

$$\begin{aligned}
 T_j^{k+1} - T_j^k &= \frac{\alpha \Delta t}{\Delta x^2} (T_{j-1}^{k+1} - 2T_j^{k+1} + T_{j+1}^{k+1}) \\
 \Rightarrow \beta^{k+1} e^{i\ell \Delta x} - \beta^k e^{i\ell x_j} &= \frac{\alpha \Delta t}{\Delta x^2} (\beta^{k+1} e^{i\ell x_{j-1}} - 2\beta^{k+1} e^{i\ell x_j} + \beta^{k+1} e^{i\ell x_{j+1}})
 \end{aligned}$$

Dividing out  $e^{i\ell x_j} \beta^{k+1}$  gives

$$\begin{aligned}
 1 &= \beta^{-1} + 2\alpha \frac{\Delta t}{\Delta x^2} (\cos \ell \Delta x - 1) \\
 \beta &= \frac{1}{1 + 2\alpha \frac{\Delta t}{\Delta x^2} (1 - \cos \ell \Delta x)}
 \end{aligned}$$

Since  $1 - \cos \ell \Delta x \in (0, 2)$ , the denominator is strictly  $> 1$ . Therefore the condition  $|\beta| < 1$  is always satisfied, regardless the value of  $\ell$  and the choices of  $\Delta x$  and  $\Delta t$ : the method is always stable.

**Exercise 4.7.** The schemes we considered here are of first order in time and second order in space: their discretization order are  $O(\Delta t) + O(\Delta x^2)$ . Derive the *Crank-Nicolson method* that is obtained by averaging the explicit and implicit schemes, show that it is unconditionally stable, and of second order in time.

## Chapter 5

### Numerical linear algebra

In chapter 4 you saw how the numerical solution of partial differential equations can lead to linear algebra problems. Sometimes this is a simple problem – a matrix-vector multiplication in the case of the Euler forward method – but sometimes it is more complicated, such as the solution of a system of linear equations in the case of Euler backward methods. Solving linear systems will be the focus of this chapter; in other applications, which we will not discuss here, eigenvalue problems need to be solved.

You may have learned a simple algorithm for solving system of linear equations: elimination of unknowns, also called Gaussian elimination. This method can still be used, but we need some careful discussion of its efficiency. There are also other algorithms, the so-called iterative solution methods, which proceed by gradually approximating the solution of the linear system. They warrant some discussion of their own.

Because of the PDE background, we only consider linear systems that are square and nonsingular. Rectangular, in particular overdetermined, systems have important applications too in a corner of numerical analysis known as optimization theory. However, we will not cover that in this book.

The standard work on numerical linear algebra is Golub and Van Loan's *Matrix Computations* [71]. It covers algorithms, error analysis, and computational details. Heath's *Scientific Computing* covers the most common types of computations that arise in scientific computing; this book has many excellent exercises and practical projects.

#### 5.1 Elimination of unknowns

In this section we are going to take a closer look at Gaussian elimination, or elimination of unknowns. You may have seen this method before (and if not, it will be explained below), but we will be a bit more systematic here so that we can analyze various aspects of it.

One general thread of this chapter will be the discussion of the efficiency of the various algorithms. When you learned how to solve a system of unknowns by gradually eliminating unknowns, you most likely never applied that method to a matrix larger than  $4 \times 4$ . The linear systems that occur in PDE solving can be thousands of times larger, and counting how many operations, as well as how much memory, they require becomes important.



Let us consider an example of the importance of efficiency in choosing the right algorithm. The solution of a linear system can be written with a fairly simple explicit formula, using determinants. This is called ‘Cramer’s rule’. It is mathematically elegant, but completely impractical for our purposes.

If a matrix  $A$  and a vector  $b$  are given, and a vector  $x$  satisfying  $Ax = b$  is wanted, then, writing  $|A|$  for the determinant,

$$x_i = \frac{\begin{vmatrix} a_{11} & a_{12} & \dots & a_{1i-1} & b_1 & a_{1i+1} & \dots & a_{1n} \\ a_{21} & & & & b_2 & & & a_{2n} \\ \vdots & & & & \vdots & & & \vdots \\ a_{n1} & & & & b_n & & & a_{nn} \end{vmatrix}}{|A|}$$

For any matrix  $M$  the determinant is defined recursively as

$$|M| = \sum_i (-1)^{i m_{1i}} |M^{[1,i]}|$$

where  $M^{[1,i]}$  denotes the matrix obtained by deleting row 1 and column  $i$  from  $M$ . This means that computing the determinant of a matrix of dimension  $n$  means  $n$  times computing a size  $n - 1$  determinant. Each of these requires  $n - 1$  determinants of size  $n - 2$ , so you see that the number of operations required to compute the determinant is factorial in the matrix size. This quickly becomes prohibitive, even ignoring any issues of numerical stability. Later in this chapter you will see complexity estimates for other methods of solving systems of linear equations that are considerably more reasonable.

Let us now look at a simple example of solving linear equations with elimination of unknowns. Consider the system

$$\begin{aligned} 6x_1 - 2x_2 + 2x_3 &= 16 \\ 12x_1 - 8x_2 + 6x_3 &= 26 \\ 3x_1 - 13x_2 + 3x_3 &= -19 \end{aligned} \tag{5.1}$$

We eliminate  $x_1$  from the second and third equation by

- multiplying the first equation  $\times 2$  and subtracting the result from the second equation, and
- multiplying the first equation  $\times 1/2$  and subtracting the result from the third equation.

The linear system then becomes

$$\begin{aligned} 6x_1 - 2x_2 + 2x_3 &= 16 \\ 0x_1 - 4x_2 + 2x_3 &= -6 \\ 0x_1 - 12x_2 + 2x_3 &= -27 \end{aligned}$$

Finally, we eliminate  $x_2$  from the third equation by multiplying the second equation by 3, and subtracting the result from the third equation:

$$\begin{aligned} 6x_1 - 2x_2 + 2x_3 &= 16 \\ 0x_1 - 4x_2 + 2x_3 &= -6 \\ 0x_1 + 0x_2 - 4x_3 &= -9 \end{aligned}$$

We can now solve  $x_3 = 9/4$  from the last equation. Substituting that in the second equation, we get  $-4x_2 = -6 - 2x_2 = -21/2$  so  $x_2 = 21/8$ . Finally, from the first equation  $6x_1 = 16 + 2x_2 - 2x_3 = 16 + 21/4 - 9/2 = 76/4$  so  $x_1 = 19/6$ .

We can write this more compactly by omitting the  $x_i$  coefficients. Write

$$\begin{pmatrix} 6 & -2 & 2 \\ 12 & -8 & 6 \\ 3 & -13 & 3 \end{pmatrix} \begin{pmatrix} x_1 \\ x_2 \\ x_3 \end{pmatrix} = \begin{pmatrix} 16 \\ 26 \\ -19 \end{pmatrix}$$

as

$$\left[ \begin{array}{ccc|c} 6 & -2 & 2 & 16 \\ 12 & -8 & 6 & 26 \\ 3 & -13 & 3 & -19 \end{array} \right] \quad (5.2)$$

then the elimination process is

$$\left[ \begin{array}{ccc|c} 6 & -2 & 2 & 16 \\ 12 & -8 & 6 & 26 \\ 3 & -13 & 3 & -19 \end{array} \right] \longrightarrow \left[ \begin{array}{ccc|c} 6 & -2 & 2 & 16 \\ 0 & -4 & 2 & -6 \\ 0 & -12 & 2 & -27 \end{array} \right] \longrightarrow \left[ \begin{array}{ccc|c} 6 & -2 & 2 & 16 \\ 0 & -4 & 2 & -6 \\ 0 & 0 & -4 & -9 \end{array} \right].$$

In the above example, the matrix coefficients could have been any real (or, for that matter, complex) coefficients, and you could follow the elimination procedure mechanically. There is the following exception. At some point in the computation, we divided by the numbers 6,  $-4$ ,  $-4$  which are found on the diagonal of the matrix in the last elimination step. These quantities are called the *pivots*, and clearly they are required to be nonzero.

**Exercise 5.1.** The system

$$\begin{aligned} 6x_1 - 2x_2 + 2x_3 &= 16 \\ 12x_1 - 4x_2 + 6x_3 &= 26 \\ 3x_1 - 13x_2 + 3x_3 &= -19 \end{aligned}$$

is the same as the one we just investigated in equation (5.1), except for the (2, 2) element. Confirm that you get a zero pivot in the second step.

The first pivot is an element of the original matrix; as you saw in the preceding exercise, the other pivots can not easily be found without doing the actual elimination. In particular, there is no easy way of predicting zero pivots from looking at the system of equations.

If a pivot turns out to be zero, all is not lost for the computation: we can always exchange two matrix rows; this is known as *pivoting*. It is not hard to show<sup>1</sup> that with a nonsingular matrix there is always a row exchange possible that puts a nonzero element in the pivot location.

**Exercise 5.2.** Suppose you want to exchange matrix rows 2 and 3 of the system of equations in equation (5.2). What other adjustments would you have to make to make sure you still compute the correct solution? Continue the system solution of the previous exercise by exchanging rows 2 and 3, and check that you get the correct answer.

1. And you can find this in any elementary linear algebra textbook.

**Exercise 5.3.** Take another look at exercise 5.1. Instead of exchanging rows 2 and 3, exchange columns 2 and 3. What does this mean in terms of the linear system? Continue the process of solving the system; check that you get the same solution as before.

In general, with floating point numbers and round-off, it is very unlikely that a matrix element will become exactly zero during a computation. Also, in a PDE context, the diagonal is usually nonzero. Does that mean that pivoting is in practice almost never necessary? The answer is *no*: pivoting is desirable from a point of view of numerical stability. In the next section you will see an example that illustrates this fact.

## 5.2 Linear algebra in computer arithmetic

In most of this chapter, we will act as if all operations can be done in exact arithmetic. However, it is good to become aware of some of the potential problems due to our finite precision computer arithmetic. This allows us to design algorithms that minimize the effect of roundoff. A more rigorous approach to the topic of numerical linear algebra includes a full-fledged error analysis of the algorithms we discuss; however, that is beyond the scope of this course. Error analysis of computations in computer arithmetic is the focus of Wilkinson's classic *Rounding errors in Algebraic Processes* [164] and Higham's more recent *Accuracy and Stability of Numerical Algorithms* [86].

Here, we will only note a few paradigmatic examples of the sort of problems that can come up in computer arithmetic: we will show why pivoting during LU factorization is more than a theoretical device, and we will give two examples of problems in eigenvalue calculations due to the finite precision of computer arithmetic.

### 5.2.1 Roundoff control during elimination

Above, you saw that row interchanging ('pivoting') is necessary if a zero element appears on the diagonal during elimination of that row and column. Let us now look at what happens if the pivot element is not zero, but close to zero.

Consider the linear system

$$\begin{pmatrix} \epsilon & 1 \\ 1 & 1 \end{pmatrix} x = \begin{pmatrix} 1 + \epsilon \\ 2 \end{pmatrix}$$

which has the solution  $x = (1, 1)^t$ . Using the  $(1, 1)$  element to clear the remainder of the first column gives:

$$\begin{pmatrix} \epsilon & 1 \\ 0 & 1 - \frac{1}{\epsilon} \end{pmatrix} x = \begin{pmatrix} 1 + \epsilon \\ 2 - \frac{1 + \epsilon}{\epsilon} \end{pmatrix}.$$

We can now solve  $x_2$  and from it  $x_1$ .

If  $\epsilon$  is small, say  $\epsilon < \epsilon_{\text{mach}}$ , the  $1 + \epsilon$  term in the right hand side will be simply 1: our linear system will be

$$\begin{pmatrix} \epsilon & 1 \\ 1 & 1 \end{pmatrix} x = \begin{pmatrix} 1 \\ 2 \end{pmatrix}$$

but the solution  $(1, 1)^t$  will still satisfy the system in machine arithmetic.

Next,  $1/\epsilon$  will be very large, so the second component of the right hand side after elimination will be  $2 - \frac{1}{\epsilon} = -1/\epsilon$ . Also, the  $(2, 2)$  element of the matrix is then  $-1/\epsilon$  instead of  $1 - 1/\epsilon$ :

$$\begin{pmatrix} \epsilon & 1 \\ 0 & -1/\epsilon \end{pmatrix} x = \begin{pmatrix} 1 \\ -1/\epsilon \end{pmatrix}$$

We get the correct value  $x_2 = 1$ , but

$$\epsilon x_1 + x_2 = 1 \Rightarrow \epsilon x_1 = 0 \Rightarrow x_1 = 0,$$

which is 100% wrong.

What would have happened if we had pivoted as described above? We exchange the matrix rows, giving

$$\begin{pmatrix} 1 & 1 \\ \epsilon & 1 \end{pmatrix} x = \begin{pmatrix} 2 \\ 1 + \epsilon \end{pmatrix} \Rightarrow \begin{pmatrix} 1 & 1 \\ 0 & 1 - \epsilon \end{pmatrix} x = \begin{pmatrix} 2 \\ 1 - \epsilon \end{pmatrix}$$

Now we get, regardless the size of epsilon:

$$x_2 = \frac{1 - \epsilon}{1 - \epsilon} = 1, \quad x_1 = 2 - x_2 = 1$$

In this example we used a very small value of  $\epsilon$ ; a much more refined analysis shows that even with  $\epsilon$  greater than the machine precision pivoting still makes sense. The general rule of thumb is: *Always do row exchanges to get the largest remaining element in the current column into the pivot position.* In chapter 4 you saw matrices that arise in certain practical applications; it can be shown that for them pivoting is never necessary; see exercise 5.13.

The pivoting that was discussed above is also known as *partial pivoting*, since it is based on row exchanges only. Another option would be *full pivoting*, where row and column exchanges are combined to find the largest element in the remaining subblock, to be used as pivot. Finally, *diagonal pivoting* applies the same exchange to rows and columns. (This is equivalent to renumbering the unknowns of the problem, a strategy which we will consider in section 6.8 for increasing the parallelism of the problem.) This means that pivots are only searched on the diagonal. From now on we will only consider partial pivoting.

### 5.2.2 Influence of roundoff on eigenvalue computations

Consider the matrix

$$A = \begin{pmatrix} 1 & \epsilon \\ \epsilon & 1 \end{pmatrix}$$

where  $\epsilon_{\text{mach}} < |\epsilon| < \sqrt{\epsilon_{\text{mach}}}$ , which has eigenvalues  $1 + \epsilon$  and  $1 - \epsilon$ . If we calculate its characteristic polynomial in computer arithmetic

$$\begin{vmatrix} 1 - \lambda & \epsilon \\ \epsilon & 1 - \lambda \end{vmatrix} = \lambda^2 - 2\lambda + (1 - \epsilon^2) = \lambda^2 - 2\lambda + 1.$$

we find a double eigenvalue 1. Note that the exact eigenvalues are expressible in working precision; it is the algorithm that causes the error. Clearly, using the characteristic polynomial is not the right way to compute eigenvalues, even in well-behaved, symmetric positive definite, matrices.

An unsymmetric example: let  $A$  be the matrix of size 20

$$A = \begin{pmatrix} 20 & 20 & & \emptyset \\ & 19 & 20 & \\ & & \ddots & \ddots \\ & & & 2 & 20 \\ \emptyset & & & & 1 \end{pmatrix}.$$

Since this is a triangular matrix, its eigenvalues are the diagonal elements. If we perturb this matrix by setting  $A_{20,1} = 10^{-6}$  we find a perturbation in the eigenvalues that is much larger than in the elements:

$$\lambda = 20.6 \pm 1.9i, 20.0 \pm 3.8i, 21.2, 16.6 \pm 5.4i, \dots$$

Also, several of the computed eigenvalues have an imaginary component, which the exact eigenvalues do not have.

### 5.3 LU factorization

So far, we have looked at eliminating unknowns in the context of solving a single system of linear equations. Suppose you need to solve more than one system with the same matrix, but with different right hand sides. This happens for instance if you take multiple time steps in an implicit method. Can you use any of the work you did in the first system to make solving subsequent ones easier?

The answer is yes. You can split the solution process in a part that only concerns the matrix, and a part that is specific to the right hand side. If you have a series of systems to solve, you have to do the first part only once, and, luckily, that even turns out to be the larger part of the work.

Let us take a look at the same example of section 5.1 again.

$$A = \begin{pmatrix} 6 & -2 & 2 \\ 12 & -8 & 6 \\ 3 & -13 & 3 \end{pmatrix}$$

In the elimination process, we took the 2nd row minus  $2 \times$  the first and the 3rd row minus  $1/2 \times$  the first. Convince yourself that this combining of rows can be done by multiplying  $A$  from the left by

$$L_1 = \begin{pmatrix} 1 & 0 & 0 \\ -2 & 1 & 0 \\ -1/2 & 0 & 1 \end{pmatrix},$$

which is the identity with the elimination coefficients in the first column, below the diagonal. The first step in elimination of variables is equivalent to transforming the system  $Ax = b$  to  $L_1Ax = L_1b$ .

In the next step, you subtracted  $3\times$  the second row from the third. Convince yourself that this corresponds to left-multiplying the current matrix  $L_1A$  by

$$L_2 = \begin{pmatrix} 1 & 0 & 0 \\ 0 & 1 & 0 \\ 0 & -3 & 1 \end{pmatrix}$$

We have now transformed our system  $Ax = b$  into  $L_2L_1Ax = L_2L_1b$ , and  $L_2L_1A$  is of ‘upper triangular’ form. If we define  $U = L_2L_1A$ , then  $A = L_1^{-1}L_2^{-1}U$ . How hard is it to compute matrices such as  $L_2^{-1}$ ? Remarkably easy, it turns out to be.

We make the following observations:

$$L_1 = \begin{pmatrix} 1 & 0 & 0 \\ -2 & 1 & 0 \\ -1/2 & 0 & 1 \end{pmatrix} \quad L_1^{-1} = \begin{pmatrix} 1 & 0 & 0 \\ 2 & 1 & 0 \\ 1/2 & 0 & 1 \end{pmatrix}$$

and likewise

$$L_2 = \begin{pmatrix} 1 & 0 & 0 \\ 0 & 1 & 0 \\ 0 & -3 & 1 \end{pmatrix} \quad L_2^{-1} = \begin{pmatrix} 1 & 0 & 0 \\ 0 & 1 & 0 \\ 0 & 3 & 1 \end{pmatrix}$$

and even more remarkable:

$$L_1^{-1}L_2^{-1} = \begin{pmatrix} 1 & 0 & 0 \\ 2 & 1 & 0 \\ 1/2 & 3 & 1 \end{pmatrix},$$

that is,  $L_1^{-1}L_2^{-1}$  contains the off-diagonal elements of  $L_1^{-1}, L_2^{-1}$  unchanged, and they in turn contain the elimination coefficients. (This is a special case of *Householder reflectors*; see 12.6.)

**Exercise 5.4.** Show that a similar statement holds, even if there are elements above the diagonal.

If we define  $L = L_1^{-1}L_2^{-1}$ , we now have  $A = LU$ ; this is called an *LU factorization*. We see that the coefficients of  $L$  below the diagonal are the negative of the coefficients used during elimination. Even better, the first column of  $L$  can be written while the first column of  $A$  is being eliminated, so the computation of  $L$  and  $U$  can be done without extra storage, at least if we can afford to lose  $A$ .

### 5.3.1 The algorithm

Let us write out the *LU* factorization algorithm in more or less formal code.

```

⟨LU factorization⟩:
  for  $k = 1, n - 1$ :
    ⟨eliminate values in column  $k$ ⟩
  ⟨eliminate values in column  $k$ ⟩:
    for  $i = k + 1$  to  $n$ :

```

```
    ⟨compute multiplier for row i⟩
    ⟨update row i⟩
⟨compute multiplier for row i⟩
   $a_{ik} \leftarrow a_{ik}/a_{kk}$ 
⟨update row i⟩:
  for  $j = k + 1$  to  $n$ :
     $a_{ij} \leftarrow a_{ij} - a_{ik} * a_{kj}$ 
```

Or, putting everything together:

```
⟨LU factorization⟩:
  for  $k = 1, n - 1$ :
    for  $i = k + 1$  to  $n$ :
       $a_{ik} \leftarrow a_{ik}/a_{kk}$ 
    for  $j = k + 1$  to  $n$ :
       $a_{ij} \leftarrow a_{ij} - a_{ik} * a_{kj}$  (5.3)
```

This is the most common way of presenting the LU factorization. However, other ways of computing the same result exist. Algorithms such as the LU factorization can be coded in several ways that are mathematically equivalent, but that have different computational behaviour. This issue, in the context of dense matrices, is the focus of van de Geijn and Quintana's *The Science of Programming Matrix Computations* [157].

### 5.3.2 The Cholesky factorization

The  $LU$  factorization of a symmetric matrix does not give an  $L$  and  $U$  that are each other's transpose:  $L$  has ones on the diagonal and  $U$  has the pivots. However it is possible to make a factorization of a symmetric matrix  $A$  of the form  $A = LL^t$ . This has the advantage that the factorization takes the same amount of space as the original matrix, namely  $n(n + 1)/2$  elements. We a little luck we can, just as in the  $LU$  case, overwrite the matrix with the factorization.

We derive this algorithm by reasoning inductively. Let us write  $A = LL^t$  on block form:

$$A = \begin{pmatrix} A_{11} & A_{21}^t \\ A_{21} & A_{22} \end{pmatrix} = LL^t = \begin{pmatrix} \ell_{11} & 0 \\ \ell_{21} & L_{22} \end{pmatrix} \begin{pmatrix} \ell_{11} & \ell_{21}^t \\ 0 & L_{22}^t \end{pmatrix}$$

then  $\ell_{11}^2 = a_{11}$ , from which we get  $\ell_{11}$ . We also find  $\ell_{11}(L^t)_{1j} = \ell_{j1} = a_{1j}$ , so we can compute the whole first column of  $L$ . Finally,  $A_{22} = L_{22}L_{22}^t + \ell_{12}\ell_{12}^t$ , so

$$L_{22}L_{22}^t = A_{22} - \ell_{12}\ell_{12}^t,$$

which shows that  $L_{22}$  is the Cholesky factor of the updated  $A_{22}$  block. Recursively, the algorithm is now defined.

### 5.3.3 Uniqueness

It is always a good idea, when discussing numerical algorithms, to wonder if different ways of computing lead to the same result. This is referred to as the 'uniqueness' of the result, and it is of practical use: if

the computed result is unique, swapping one software library for another will not change anything in the computation.

Let us consider the uniqueness of  $LU$  factorization. The definition of an  $LU$  factorization algorithm (without pivoting) is that, given a nonsingular matrix  $A$ , it will give a lower triangular matrix  $L$  and upper triangular matrix  $U$  such that  $A = LU$ . The above algorithm for computing an  $LU$  factorization is deterministic (it does not contain instructions ‘take any row that satisfies...’), so given the same input, it will always compute the same output. However, other algorithms are possible, so we need worry whether they give the same result.

Let us then assume that  $A = L_1U_1 = L_2U_2$  where  $L_1, L_2$  are lower triangular and  $U_1, U_2$  are upper triangular. Then,  $L_2^{-1}L_1 = U_2U_1^{-1}$ . In that equation, the left hand side is the product of lower triangular matrices, while the right hand side contains only upper triangular matrices.

**Exercise 5.5.** Prove that the product of lower triangular matrices is lower triangular, and the product of upper triangular matrices upper triangular. Is a similar statement true for inverses of nonsingular triangular matrices?

The product  $L_2^{-1}L_1$  is apparently both lower triangular and upper triangular, so it must be diagonal. Let us call it  $D$ , then  $L_1 = L_2D$  and  $U_2 = DU_1$ . The conclusion is that  $LU$  factorization is not unique, but it is unique ‘up to diagonal scaling’.

**Exercise 5.6.** The algorithm in section 5.3.1 resulted in a lower triangular factor  $L$  that had ones on the diagonal. Show that this extra condition makes the factorization unique.

**Exercise 5.7.** Show that an alternative condition of having ones on the diagonal of  $U$  is also sufficient for the uniqueness of the factorization.

Since we can demand a unit diagonal in  $L$  or in  $U$ , you may wonder if it is possible to have both. (Give a simple argument why this is not strictly possible.) We can do the following: suppose that  $A = LU$  where  $L$  and  $U$  are nonsingular lower and upper triangular, but not normalized in any way. Write

$$L = (I + L')D_L, \quad U = D_U(I + U'), \quad D = D_L D_U.$$

After some renaming we now have a factorization

$$A = (I + L)D(I + U) \tag{5.4}$$

where  $D$  is a diagonal matrix containing the pivots.

**Exercise 5.8.** Show that you can also normalize the factorization on the form

$$A = (D + L)D^{-1}(D + U).$$

How does this  $D$  relate to the previous?

**Exercise 5.9.** Consider the factorization of a tridiagonal matrix this way. How do  $L$  and  $U$  relate to the triangular parts of  $A$ ? Derive a relation between  $D$  and  $D_A$  and show that this is the equation that generates the pivots.



### 5.3.4 Pivoting

Above, you saw examples where pivoting, that is, exchanging rows, was necessary during the factorization process, either to guarantee the existence of a nonzero pivot, or for numerical stability. We will now integrate pivoting into the  $LU$  factorization.

Let us first observe that row exchanges can be described by a matrix multiplication. Let

$$P^{(i,j)} = \begin{pmatrix} & & & & i & j & & & \\ & & & & & & & & \\ & & & & & & & & \\ & & & & & & & & \\ & & & & & & & & \\ i & & & & 0 & 1 & & & \\ & & & & & & I & & \\ j & & & & 1 & 0 & & & \\ & & & & & & & I & \\ & & & & & & & & \ddots \end{pmatrix}$$

then  $P^{(i,j)}A$  is the matrix  $A$  with rows  $i$  and  $j$  exchanged. Since we may have to pivot in every iteration of the factorization process, we introduce a sequence  $p(\cdot)$  where  $p(i)$  is the  $j$  values of the row that row  $i$  is switched with. We write  $P^{(i)} \equiv P^{(i,p(i))}$  for short.

**Exercise 5.10.** Show that  $P^{(i)}$  is its own inverse.

The process of factoring with partial pivoting can now be described as:

- Let  $A^{(i)}$  be the matrix with columns  $1 \dots i - 1$  eliminated, and partial pivoting applied to get the desired element in the  $(i, i)$  location.
- Let  $\ell^{(i)}$  be the vector of multipliers in the  $i$ -th elimination step. (That is, the elimination matrix  $L_i$  in this step is the identity plus  $\ell^{(i)}$  in the  $i$ -th column.)
- Let  $P^{(i+1)}$  (with  $j \geq i + 1$ ) be the matrix that does the partial pivoting for the next elimination step as described above.
- Then  $A^{(i+1)} = P^{(i+1)}L_iA^{(i)}$ .

In this way we get a factorization of the form

$$L_{n-1}P^{(n-2)}L_{n-2} \dots L_1P^{(1)}A = U.$$

Suddenly it has become impossible to write  $A = LU$ : instead we write

$$A = P^{(1)}L_1^{-1} \dots P^{(n-2)}L_{n-1}^{-1}U. \tag{5.5}$$

**Exercise 5.11.** Recall from sections 1.6.10 and 1.6.8 that blocked algorithms are often desirable from a performance point of view. Why is the ‘ $LU$  factorization with interleaved pivoting matrices’ in equation (5.5) bad news for performance?

Fortunately, equation (5.5) can be simplified: the  $P$  and  $L$  matrices ‘almost commute’. We show this by looking at an example:  $P^{(2)}L_1 = \tilde{L}_1P^{(2)}$  where  $\tilde{L}_1$  is very close to  $L_1$ .

$$\begin{pmatrix} 1 & & & \\ & 0 & 1 & \\ & & I & \\ & 1 & 0 & \\ & & & I \end{pmatrix} \begin{pmatrix} 1 & & \emptyset & \\ \vdots & 1 & & \\ \ell^{(1)} & & \ddots & \\ \vdots & & & 1 \end{pmatrix} = \begin{pmatrix} 1 & & \emptyset & \\ \vdots & 0 & 1 & \\ \tilde{\ell}^{(1)} & & & \\ \vdots & 1 & 0 & \\ \vdots & & & I \end{pmatrix} = \begin{pmatrix} 1 & & \emptyset & \\ \vdots & 1 & & \\ \tilde{\ell}^{(1)} & & \ddots & \\ \vdots & & & 1 \end{pmatrix} \begin{pmatrix} 1 & & & \\ & 0 & 1 & \\ & & I & \\ & 1 & 0 & \\ & & & I \end{pmatrix}$$

where  $\tilde{\ell}^{(1)}$  is the same as  $\ell^{(1)}$ , except that elements  $i$  and  $p(i)$  have been swapped. You can now easily convince yourself that similarly  $P^{(2)}$  et cetera can be ‘pulled through’  $L_1$ .

As a result we get

$$P^{(n-2)} \dots P^{(1)}A = \tilde{L}_1^{-1} \dots L_{n-1}^{-1}U = \tilde{L}U. \quad (5.6)$$

This means that we can again form a matrix  $L$  just as before, except that every time we pivot, we need to update the columns of  $L$  that have already been computed.

**Exercise 5.12.** If we write equation (5.6) as  $PA = LU$ , we get  $A = P^{-1}LU$ . Can you come up with a simple formula for  $P^{-1}$  in terms of just  $P$ ? Hint: each  $P^{(i)}$  is symmetric and its own inverse; see the exercise above.

**Exercise 5.13.** Earlier, you saw that 2D BVP (section 4.2.3) give rise to a certain kind of matrix. We stated, without proof, that for these matrices pivoting is not needed. We can now formally prove this, focusing on the crucial property of *diagonal dominance*:

$$\forall_i a_{ii} \geq \sum_{j \neq i} |a_{ij}|.$$

Assume that a matrix  $A$  satisfies  $\forall_{j \neq i}: a_{ij} \leq 0$ . Show that the matrix is diagonally dominant iff there are vectors  $u, v \geq 0$  (meaning that each component is nonnegative) such that  $Au = v$ .

Show that, after eliminating a variable, for the remaining matrix  $\tilde{A}$  there are again vectors  $\tilde{u}, \tilde{v} \geq 0$  such that  $\tilde{A}\tilde{u} = \tilde{v}$ .

Now finish the argument that (partial) pivoting is not necessary if  $A$  is symmetric and diagonally dominant. (One can actually prove that pivoting is not necessary for any *symmetric positive definite (SPD)* matrix, and diagonal dominance is a stronger condition than SPD-ness.)

### 5.3.5 Solving the system

Now that we have a factorization  $A = LU$ , we can use this to solve the linear system  $Ax = LUx = b$ . If we introduce a temporary vector  $y = Ux$ , then we see this takes two steps:

$$Ly = b, \quad Ux = z.$$

The first part,  $Ly = b$  is called the ‘lower triangular solve’, since it involves the lower triangular matrix  $L$ .

$$\begin{pmatrix} 1 & & & \emptyset \\ \ell_{21} & 1 & & \\ \ell_{31} & \ell_{32} & 1 & \\ \vdots & & & \ddots \\ \ell_{n1} & \ell_{n2} & \cdots & 1 \end{pmatrix} \begin{pmatrix} y_1 \\ y_2 \\ \vdots \\ y_n \end{pmatrix} = \begin{pmatrix} b_1 \\ b_2 \\ \vdots \\ b_n \end{pmatrix}$$

In the first row, you see that  $y_1 = b_1$ . Then, in the second row  $\ell_{21}y_1 + y_2 = b_2$ , so  $y_2 = b_2 - \ell_{21}y_1$ . You can imagine how this continues: in every  $i$ -th row you can compute  $y_i$  from the previous  $y$ -values:

$$y_i = b_i - \sum_{j < i} \ell_{ij}y_j.$$

Since we compute  $y_i$  in increasing order, this is also known as the forward substitution, forward solve, or forward sweep.

The second half of the solution process, the upper triangular solve, backward substitution, or backward sweep, computes  $x$  from  $Ux = y$ :

$$\begin{pmatrix} u_{11} & u_{12} & \cdots & u_{1n} \\ & u_{22} & \cdots & u_{2n} \\ & & \ddots & \vdots \\ \emptyset & & & u_{nn} \end{pmatrix} \begin{pmatrix} x_1 \\ x_2 \\ \vdots \\ x_n \end{pmatrix} = \begin{pmatrix} y_1 \\ y_2 \\ \vdots \\ y_n \end{pmatrix}$$

Now we look at the last line, which immediately tells us that  $x_n = u_{nn}^{-1}y_n$ . From this, the line before the last states  $u_{n-1,n-1}x_{n-1} + u_{n-1,n}x_n = y_{n-1}$ , which gives  $x_{n-1} = u_{n-1,n-1}^{-1}(y_{n-1} - u_{n-1,n}x_n)$ . In general, we can compute

$$x_i = u_{ii}^{-1}(y_i - \sum_{j > i} u_{ij}y_j)$$

for decreasing values of  $i$ .

**Exercise 5.14.** In the backward sweep you had to divide by the numbers  $u_{ii}$ . That is not possible if any of them are zero. Relate this problem back to the above discussion.

### 5.3.6 Complexity

In the beginning of this chapter, we indicated that not every method for solving a linear system takes the same number of operations. Let us therefore take a closer look at the complexity<sup>2</sup>, that is, the number of operations as function of the problem size, of the use of an LU factorization in solving the linear system.

First we look at the computation of  $x$  from  $LUx = b$  (‘solving the linear system’; section 5.3.5), given that we already have the factorization  $A = LU$ . Looking at the lower and upper triangular part together, you

2. See appendix 13 for an explanation of complexity.

see that you perform a multiplication with all off-diagonal elements (that is, elements  $l_{ij}$  or  $u_{ij}$  with  $i \neq j$ ). Furthermore, the upper triangular solve involves divisions by the  $u_{ii}$  elements. Now, division operations are in general much more expensive than multiplications, so in this case you would compute the values  $1/u_{ii}$ , and store them instead.

**Exercise 5.15.** Take a look at the factorization algorithm, and argue that storing the reciprocals of the pivots does not add to the computational complexity.

Summing up, you see that, on a system of size  $n \times n$ , you perform  $n^2$  multiplications and roughly the same number of additions. This shows that, given a factorization, solving a linear system has the same complexity as a simple matrix-vector multiplication, that is, of computing  $Ax$  given  $A$  and  $x$ .

The complexity of constructing the  $LU$  factorization is a bit more involved to compute. Refer to the algorithm in section 5.3.1. You see that in the  $k$ -th step two things happen: the computation of the multipliers, and the updating of the rows. There are  $n - k$  multipliers to be computed, each of which involve a division. After that, the update takes  $(n - k)^2$  additions and multiplications. If we ignore the divisions for now, because there are fewer of them, we find that the  $LU$  factorization takes  $\sum_{k=1}^{n-1} 2(n - k)^2$  operations. If we number the terms in this sum in the reverse order, we find

$$\#\text{ops} = \sum_{k=1}^{n-1} 2k^2.$$

Since we can approximate a sum by an integral, we find that this is  $2/3n^3$  plus some lower order terms. This is of a higher order than solving the linear system: as the system size grows, the cost of constructing the  $LU$  factorization completely dominates.

Of course there is more to algorithm analysis than operation counting. While solving the linear system has the same complexity as a matrix-vector multiplication, the two operations are of a very different nature. One big difference is that both the factorization and forward/backward solution involve recursion, so they are not simple to parallelize. We will say more about that later on.

### 5.3.7 Block algorithms

Often, matrices have a natural block structure, such as in the case of two-dimensional BVPs; section 4.2.3. Many linear algebra operations can be formulated in terms of these blocks. This can have several advantages over the traditional scalar view of matrices. For instance, it improves *cache blocking* (section 1.6.7); it also facilitates scheduling linear algebra algorithms on *multicore* architectures (section 6.12).

For block algorithms we write a matrix as

$$A = \begin{pmatrix} A_{11} & \dots & A_{1N} \\ \vdots & & \vdots \\ A_{M1} & \dots & A_{MN} \end{pmatrix}$$

where  $M, N$  are the block dimensions, that is, the dimension expressed in terms of the subblocks. Usually, we choose the blocks such that  $M = N$  and the diagonal blocks are square.

As a simple example, consider the matrix-vector product  $y = Ax$ , expressed in block terms.

$$\begin{pmatrix} Y_1 \\ \vdots \\ Y_M \end{pmatrix} = \begin{pmatrix} A_{11} & \dots & A_{1M} \\ \vdots & & \vdots \\ A_{M1} & \dots & A_{MM} \end{pmatrix} \begin{pmatrix} X_1 \\ \vdots \\ X_M \end{pmatrix}$$

To see that the block algorithm computes the same result as the old scalar algorithm, we look at a component  $Y_{i_k}$ , that is the  $k$ -th scalar component of the  $i$ -th block. First,

$$Y_i = \sum_j A_{ij} X_j$$

so

$$Y_{i_k} = \left( \sum_j A_{ij} X_j \right)_k = \sum_j (A_{ij} X_j)_k = \sum_j \sum_\ell A_{ij_{k\ell}} X_{j_\ell}$$

which is the product of the  $k$ -th row of the  $i$ -th blockrow of  $A$  with the whole of  $X$ .

A more interesting algorithm is the block version of the LU factorization. The algorithm (5.3) then becomes

$$\begin{aligned} &\langle LU \text{ factorization} \rangle: \\ &\quad \text{for } k = 1, n - 1: \\ &\quad \quad \text{for } i = k + 1 \text{ to } n: \\ &\quad \quad \quad A_{ik} \leftarrow A_{ik} A_{kk}^{-1} \\ &\quad \quad \quad \text{for } j = k + 1 \text{ to } n: \\ &\quad \quad \quad \quad A_{ij} \leftarrow A_{ij} - A_{ik} \cdot A_{kj} \end{aligned} \tag{5.7}$$

which mostly differs from the earlier algorithm in that the division by  $a_{kk}$  has been replaced by a multiplication by  $A_{kk}^{-1}$ . Also, the  $U$  factor will now have pivot blocks, rather than pivot elements, on the diagonal, so  $U$  is only ‘block upper triangular’, and not strictly upper triangular.

**Exercise 5.16.** We would like to show that the block algorithm here again computes the same result as the scalar one. Doing so by looking explicitly at the computed elements is cumbersome, so we take another approach. First, recall from section 5.3.3 that  $LU$  factorizations are unique: if  $A = L_1 U_1 = L_2 U_2$  and  $L_1, L_2$  have unit diagonal, then  $L_1 = L_2, U_1 = U_2$ .

Next, consider the computation of  $A_{kk}^{-1}$ . Show that this can be done easily by first computing an LU factorization of  $A_{kk}$ . Now use this to show that the block LU factorization can give  $L$  and  $U$  factors that are strictly triangular. The uniqueness of  $LU$  factorizations then proves that the block algorithm computes the scalar result.

## 5.4 Sparse matrices

In section 4.2.3 you saw that the discretization of BVPs (and IBVPs) may give rise to sparse matrices. Since such a matrix has  $N^2$  elements but only  $O(N)$  nonzeros, it would be a big waste of space to store this as a two-dimensional array. Additionally, we want to avoid operating on zero elements.

In this section we will explore efficient storage schemes for sparse matrices, and the form that familiar linear algebra operations take when using sparse storage.

### 5.4.1 Storage of sparse matrices

It is pointless to look for an exact definition of *sparse matrix*, but an operational definition is that a matrix is called ‘sparse’ if there are enough zeros to make specialized storage feasible. We will discuss here briefly the most popular storage schemes for sparse matrices. Since a matrix is no longer stored as a simple 2-dimensional array, algorithms using such storage schemes need to be rewritten too.

#### 5.4.1.1 Diagonal storage

In section 4.2.2 you have seen examples of sparse matrices that were banded. In fact, their nonzero elements are located precisely on a number of subdiagonals. For such a matrix, a specialized storage scheme is possible.

Let us take as an example the matrix of the one-dimensional BVP (section 4.2.2). Its elements are located on three subdiagonals: the main diagonal and the first super and subdiagonal. The idea of *storage by diagonals* or *diagonal storage* is to store the diagonals consecutively in memory. The most economical storage scheme for such a matrix would store the  $2n - 2$  elements consecutively. However, for various reasons it is more convenient to waste a few storage locations, as shown in figure 5.1.

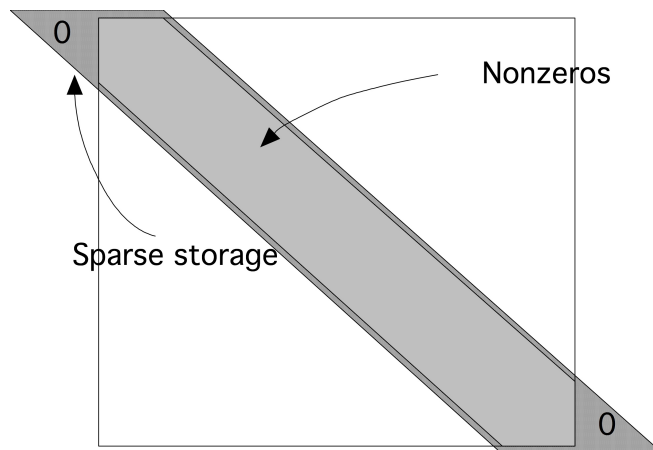

Figure 5.1: Diagonal storage of a banded matrix

Thus, for a matrix with size  $n \times n$  and a *bandwidth*  $p$ , we need a rectangular array of size  $n \times p$  to store the matrix. The matrix of equation (4.9) would then be stored as

$$\begin{array}{|c|c|c|} \hline \star & 2 & -1 \\ \hline -1 & 2 & -1 \\ \hline \vdots & \vdots & \vdots \\ \hline -1 & 2 & \star \\ \hline \end{array} \quad (5.8)$$

where the stars indicate array elements that do not correspond to matrix elements: they are the triangles in the top left and bottom right in figure 5.1.

Of course, now we have to wonder about the conversion between array elements  $A(i, j)$  and matrix elements  $A_{ij}$ . This is easiest done in the Fortran language. If we allocate the array with

```
dimension A(n, -1:1)
```

then the main diagonal  $A_{ii}$  is stored in  $A(*, 0)$ . For instance,  $A(1, 0) \sim A_{11}$ . The next location in the same row of the matrix  $A$ ,  $A(1, 1) \sim A_{12}$ . It is easy to see that together we have the conversion

$$A(i, j) \sim A_{i, i+j}. \quad (5.9)$$

**Exercise 5.17.** What is the reverse conversion, that is, what array location  $A(?, ?)$  does the matrix element  $A_{ij}$  correspond to?

**Exercise 5.18.** If you are a C programmer, derive the conversion between matrix elements  $A_{ij}$  and array elements  $A[i][j]$ .

If we apply this scheme to the matrix of the two-dimensional BVP (section 4.2.3), it becomes wasteful, since we would be storing many zeros that exist inside the band. Therefore, we refine this scheme by storing only the nonzero diagonals: if the matrix has  $p$  nonzero diagonals, we need an  $n \times p$  array. For the matrix of equation (4.14) this means:

$$\begin{array}{ccccc} \star & \star & 4 & -1 & -1 \\ \vdots & \vdots & 4 & -1 & -1 \\ \vdots & -1 & 4 & -1 & -1 \\ -1 & -1 & 4 & -1 & -1 \\ \vdots & \vdots & \vdots & \vdots & \vdots \\ -1 & -1 & 4 & \star & \star \end{array}$$

Of course, we need an additional integer array telling us the locations of these nonzero diagonals.

In the preceding examples, the matrices had an equal number of nonzero diagonals above and below the main diagonal. In general this need not be true. For this we introduce the concepts of

- *left halfbandwidth*: if  $A$  has a left halfbandwidth of  $p$  then  $A_{ij} = 0$  for  $i > j + p$ , and
- *right halfbandwidth*: if  $A$  has a right halfbandwidth of  $p$  then  $A_{ij} = 0$  for  $j > i + p$ .

#### 5.4.1.2 Operations on diagonal storage

The most important operation on sparse matrices is the matrix-vector product. With a matrix stored by diagonals, as described above, it is still possible to perform the ordinary rowwise or columnwise product using the conversion formula (5.9)<sup>3</sup>. However, with a small bandwidth, this gives short vector lengths and relatively high loop overhead, so it will not be efficient. It is possible to do much better than that.

If we look at how the matrix elements are used in the matrix-vector product, we see that the main diagonal is used as

$$y_i \leftarrow y_i + A_{ii}x_i,$$

3. In fact, this is how Lapack banded routines work.

the first superdiagonal is used as

$$y_i \leftarrow y_i + A_{ii+1}x_{i+1} \quad \text{for } i < n,$$

and the first subdiagonal as

$$y_i \leftarrow y_i + A_{ii-1}x_{i-1} \quad \text{for } i > 1.$$

In other words, the whole matrix-vector product can be executed in just three vector operations of length  $n$  (or  $n - 1$ ), instead of  $n$  inner products of length 3 (or 2).

```

for diag = -diag_left, diag_right
  for loc = max(1, 1-dia), min(n, n-dia)
    y(loc) = y(loc) + val(loc, dia) * x(loc+dia)
  end
end
end

```

**Exercise 5.19.** Write a routine that computes  $y \leftarrow A^t x$  by diagonals. Implement it in your favourite language and test it on a random matrix.

**Exercise 5.20.** The above code fragment is efficient if the matrix is dense inside the band. This is not the case for, for instance, the matrix of two-dimensional BVPs; see section 4.2.3 and in particular equation (4.14). Write code for the matrix-vector product by diagonals that only uses the nonzero diagonals.

**Exercise 5.21.** Multiplying matrices is harder than multiplying a matrix times a vector. If matrix  $A$  has left and halfbandwidth  $p_A, q_A$ , and matrix  $B$  has  $p_B, q_B$ , what are the left and right halfbandwidth of  $C = AB$ ? Assuming that an array of sufficient size has been allocated for  $C$ , write a routine that computes  $C \leftarrow AB$ .

### 5.4.1.3 Compressed row storage

If we have a sparse matrix that does not have a simple band structure, or where the number of nonzero diagonals becomes impractically large, we use the more general Compressed Row Storage (CRS) scheme. As the name indicates, this scheme is based on compressing all rows, eliminating the zeros; see figure 5.2. Since this loses the information what columns the nonzeros originally came from, we have to store this explicitly. Consider an example of a sparse matrix:

$$A = \begin{pmatrix} 10 & 0 & 0 & 0 & -2 & 0 \\ 3 & 9 & 0 & 0 & 0 & 3 \\ 0 & 7 & 8 & 7 & 0 & 0 \\ 3 & 0 & 8 & 7 & 5 & 0 \\ 0 & 8 & 0 & 9 & 9 & 13 \\ 0 & 4 & 0 & 0 & 2 & -1 \end{pmatrix}. \quad (5.10)$$

After compressing all rows, we store all nonzeros in a single real array. The column indices are similarly stored in an integer array, and we store pointers to where the columns start. Using 0-based indexing this gives:



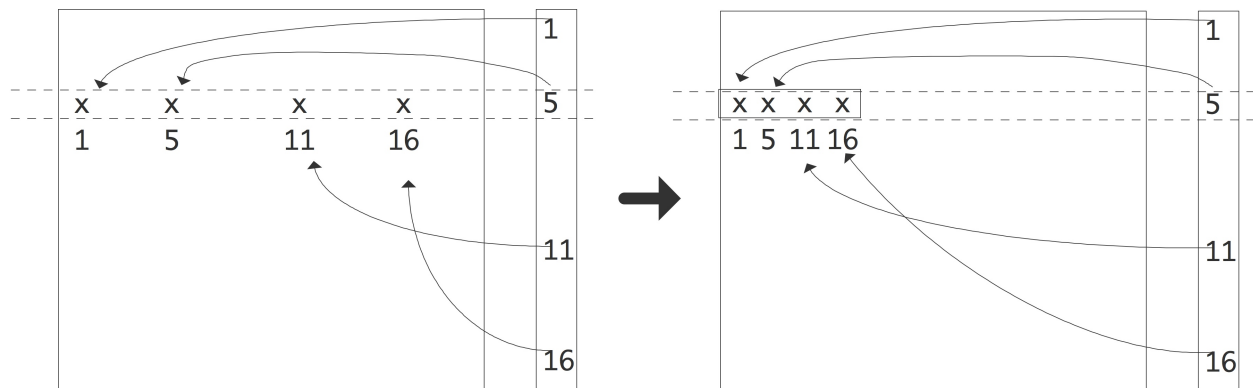

Figure 5.2: Compressing a row of a sparse matrix in the CRS format

val	10	-2	3	9	3	7	8	7	3 ... 9	13	4	2	-1
col_ind	0	4	0	1	5	1	2	3	0 ... 4	5	1	4	5
row_ptr	0	2	5	8	12	16	19						

A simple variant of CRS is *Compressed Column Storage (CCS)* where the elements in columns are stored contiguously. This is also known as the *Harwell-Boeing matrix format* [48]. Another storage scheme you may come across is *coordinate storage*, where the matrix is stored as a list of triplets  $\langle i, j, a_{ij} \rangle$ . The popular *Matrix Market* website [129] uses a variant of this scheme.

#### 5.4.1.4 Algorithms on compressed row storage

In this section we will look at the form some algorithms take in CRS.

First we consider the *implementation of the sparse matrix-vector product*.

```

for (row=0; row<nrows; row++) {
    s = 0;
    for (icol=ptr[row]; icol<ptr[row+1]; icol++) {
        int col = ind[icol];
        s += a[icol] * x[col];
    }
    y[row] = s;
}

```

You recognize the standard matrix-vector product algorithm for  $y = Ax$ , where the inner product is taken of each row  $A_{i*}$  and the input vector  $x$ . However, note that the inner loop no longer has the column number as index, but rather the location where that number is to be found. This extra step is known as *indirect addressing*.

**Exercise 5.22.** Compare the data locality of the dense matrix-vector product, executed by rows, with the sparse product given just now. Show that, for general sparse matrices, the spatial locality in addressing the input vector  $x$  has now disappeared. Are there matrix structures for which you can still expect some spatial locality?

Now, how about if you wanted to compute the product  $y = A^t x$ ? In that case you need rows of  $A^t$ , or, equivalently, columns of  $A$ . Finding arbitrary columns of  $A$  is hard, requiring lots of searching, so you may think that this algorithm is correspondingly hard to compute. Fortunately, that is not true.

If we exchange the  $i$  and  $j$  loop in the standard algorithm for  $y = Ax$ , we get

$$\begin{array}{l}
 y \leftarrow 0 \\
 \text{for } i: \\
 \quad \text{for } j: \\
 \quad \quad y_i \leftarrow y_i + a_{ij}x_j
 \end{array}
 \quad \Rightarrow \quad
 \begin{array}{l}
 y \leftarrow 0 \\
 \text{for } j: \\
 \quad \text{for } i: \\
 \quad \quad y_i \leftarrow y_i + a_{ji}x_j
 \end{array}$$

We see that in the second variant, columns of  $A$  are accessed, rather than rows. This means that we can use the second algorithm for computing the  $A^t x$  product by rows.

**Exercise 5.23.** Write out the code for the transpose product  $y = A^t x$  where  $A$  is stored in CRS format. Write a simple test program and confirm that your code computes the right thing.

**Exercise 5.24.** What if you need access to both rows and columns at the same time? Implement an algorithm that tests whether a matrix stored in CRS format is symmetric. Hint: keep an array of pointers, one for each row, that keeps track of how far you have progressed in that row.

**Exercise 5.25.** The operations described so far are fairly simple, in that they never make changes to the sparsity structure of the matrix. The CRS format, as described above, does not allow you to add new nonzeros to the matrix, but it is not hard to make an extension that does allow it.

Let numbers  $p_i, i = 1 \dots n$ , describing the number of nonzeros in the  $i$ -th row, be given. Design an extension to CRS that gives each row space for  $q$  extra elements. Implement this scheme and test it: construct a matrix with  $p_i$  nonzeros in the  $i$ -th row, and check the correctness of the matrix-vector product before and after adding new elements, up to  $q$  elements per row.

Now assume that the matrix will never have more than a total of  $qn$  nonzeros. Alter your code so that it can deal with starting with an empty matrix, and gradually adding nonzeros in random places. Again, check the correctness.

We will revisit the transpose product algorithm in section 6.5.5 in the context of shared memory parallelism.

## 5.4.2 Sparse matrices and graph theory

Many arguments regarding sparse matrices can be formulated in terms of graph theory. To see why this can be done, consider a matrix  $A$  of size  $n$  and observe that we can define a graph  $\langle E, V \rangle$  by  $V = \{1, \dots, n\}$ ,  $E = \{(i, j) : a_{ij} \neq 0\}$ . This is called the *adjacency graph* of the matrix. For simplicity, we assume that  $A$

has a nonzero diagonal. If necessary, we can attach weights to this graph, defined by  $w_{ij} = a_{ij}$ . The graph is then denoted  $\langle E, V, W \rangle$ . (If you are not familiar with the basics of graph theory, see appendix 16.)

Graph properties now correspond to matrix properties; for instance, the degree of the graph is the maximum number of nonzeros per row, not counting the diagonal element. As another example, if the graph of the matrix is an *undirected graph*, this means that  $a_{ij} \neq 0 \Leftrightarrow a_{ji} \neq 0$ . We call such a matrix *structurally symmetric*: it is not truly symmetric in the sense that  $\forall_{ij}: a_{ij} = a_{ji}$ , but every nonzero in the upper triangle corresponds to one in the lower triangle and vice versa.

One advantage of considering the graph of a matrix is that graph properties do not depend on how we order the nodes, that is, they are invariant under permutation of the matrix.

**Exercise 5.26.** Let us take a look at what happens with a matrix  $A$  when the nodes of its graph  $G = \langle V, E, W \rangle$  are renumbered. As a simple example, we number the nodes backwards; that is, with  $n$  the number of nodes, we map node  $i$  to  $n + 1 - i$ . Correspondingly, we find a new graph  $G' = \langle V, E', W' \rangle$  where

$$(i, j) \in E' \Leftrightarrow (n + 1 - i, n + 1 - j) \in E, \quad w'_{ij} = w_{n+1-i, n+1-j}.$$

What does this renumbering imply for the matrix  $A'$  that corresponds to  $G'$ ? If you exchange the labels  $i, j$  on two nodes, what is the effect on the matrix  $A$ ?

Some graph properties can be hard to see from the sparsity pattern of a matrix, but are easier deduced from the graph.

**Exercise 5.27.** Let  $A$  be the tridiagonal matrix of the one-dimensional BVP (see section 4.2.2) of size  $n$  with  $n$  odd. What does the graph of  $A$  look like? Consider the permutation that results from putting the nodes in the following sequence:  $1, 3, 5, \dots, n, 2, 4, 6, \dots, n - 1$ . What does the sparsity pattern of the permuted matrix look like? Renumbering strategies such as this will be discussed in more detail in section 6.8.2.

**Exercise 5.28.** Take again the matrix from the previous exercise, and zero the offdiagonal elements closest to the ‘middle’ of the matrix: let  $a_{(n+1)/2, (n+1)/2+1} = a_{(n+1)/2+1, (n+1)/2} = 0$ . Describe what that does to the graph of  $A$ . Such a graph is called *reducible*. Now apply the permutation of the previous exercise and sketch the resulting sparsity pattern. Note that the reducibility of the graph is now harder to read from the sparsity pattern.

### 5.4.3 LU factorizations of sparse matrices

In section 4.2.2 the one-dimensional BVP led to a linear system with a tridiagonal coefficient matrix. If we do one step of Gaussian elimination, the only element that needs to be eliminated is in the second row:

$$\begin{pmatrix} 2 & -1 & 0 & \dots & & \\ -1 & 2 & -1 & & & \\ 0 & -1 & 2 & -1 & & \\ & \ddots & \ddots & \ddots & \ddots & \\ & & & & & \ddots \end{pmatrix} \Rightarrow \left( \begin{array}{c|cccc} 2 & -1 & 0 & \dots & \\ \hline 0 & 2 - \frac{1}{2} & -1 & & \\ 0 & -1 & 2 & -1 & \\ & \ddots & \ddots & \ddots & \ddots \end{array} \right)$$

There are two important observations to be made: one is that this elimination step does not change any zero elements to nonzero. The other observation is that the part of the matrix that is left to be eliminated is again tridiagonal. Inductively, during the elimination no zero elements change to nonzero: the sparsity pattern of  $L + U$  is the same as of  $A$ , and so the factorization takes the same amount of space to store as the matrix.

The case of tridiagonal matrices is unfortunately not typical, as we will shortly see in the case of two-dimensional problems. But first we will extend the discussion on graph theory of section 5.4.2 to factorizations.

#### 5.4.3.1 Graph theory of sparse LU factorization

Graph theory is often useful when discussing the factorization of a sparse matrix. Let us investigate what eliminating the first unknown (or sweeping the first column) means in graph theoretic terms. We are assuming a structurally symmetric matrix.

We consider eliminating an unknown as a process that takes a graph  $G = \langle V, E \rangle$  and turns it into a graph  $G' = \langle V', E' \rangle$ . The relation between these graphs is first that a vertex, say  $k$ , has been removed from the vertices:  $k \notin V'$ ,  $V' \cup \{k\} = V$ .

The relationship between  $E$  and  $E'$  is more complicated. In the Gaussian elimination algorithm the result of eliminating variable  $k$  is that the statement

$$a_{ij} \leftarrow a_{ij} - a_{ik}a_{kk}^{-1}a_{kj}$$

is executed for all  $i, j \neq k$ . If  $a_{ij} \neq 0$  originally, then its value is merely altered. In case  $a_{ij} = 0$  in the original matrix, there will be a nonzero element, termed a *fill-in* element, after the  $k$  unknown is eliminated:



Figure 5.3: Eliminating a vertex introduces a new edge in the quotient graph

in  $E$  there was no edge  $(i, j)$ , and this edge is present in  $E'$ . This is illustrated in figure 5.3.

Summarizing, eliminating an unknown gives a graph that has one vertex less, and that has edges for all  $i, j$  such that there were edges between  $i$  or  $j$  and the eliminated variable  $k$ .

**Exercise 5.29.** Go back to exercise 5.27. Use a graph argument to determine the sparsity pattern after the odd variables have been eliminated.

**Exercise 5.30.** Prove the generalization of the above argument about eliminating a single vertex. Let  $I \subset V$  be any set of vertices, and let  $J$  be the vertices connected to  $I$ :

$$J \cap I = \emptyset, \quad \forall i \in I \exists j \in J: (i, j) \in E.$$

Now show that eliminating the variables in  $I$  leads to a graph  $\langle V', E' \rangle$  where all nodes in  $J$  are connected in the remaining graph, if there was a path between them through  $I$ :

$$\forall_{j_1, j_2 \in J} : \text{there is a path } j_i \rightarrow j_2 \text{ through } I \text{ in } E \Rightarrow (j_1, j_2) \in E'.$$

#### 5.4.3.2 Fill-in

We now return to the factorization of the matrix from two-dimensional problems. We write such matrices of size  $N \times N$  as block matrices with block dimension  $n$ , each block being of size  $n$ . (Refresher question: where do these blocks come from?) Now, in the first elimination step we need to zero two elements,  $a_{21}$  and  $a_{n+1,1}$ .

$$\left( \begin{array}{cccc|cc} 4 & -1 & 0 & \dots & -1 & \\ -1 & 4 & -1 & 0 & \dots & 0 & -1 \\ & \ddots & \ddots & \ddots & & & \ddots \\ -1 & 0 & \dots & & 4 & -1 & \\ 0 & -1 & 0 & \dots & -1 & 4 & -1 \end{array} \right) \Rightarrow \left( \begin{array}{cccc|cc} 4 & -1 & 0 & \dots & -1 & \\ \hline & 4 - \frac{1}{4} & -1 & 0 & \dots & -1/4 & -1 \\ & \ddots & \ddots & \ddots & & & \ddots \\ -1 & -1/4 & & & 4 - \frac{1}{4} & -1 & \\ \hline & -1 & 0 & & -1 & 4 & -1 \end{array} \right)$$

You see that eliminating  $a_{21}$  and  $a_{n+1,1}$  causes two *fill* elements to appear: in the original matrix  $a_{2,n+1}$  and  $a_{n+1,2}$  are zero, but in the modified matrix these locations are nonzero. We define *fill locations* as locations  $(i, j)$  where  $a_{ij} = 0$ , but  $(L + U)_{ij} \neq 0$ .

Clearly the matrix fills in during factorization. With a little imagination you can also see that every element in the band outside the first diagonal block will fill in. However, using the graph approach of section 5.4.3.1 it becomes easy to visualize the fill-in connections that are created.

In figure 5.4 this is illustrated for the graph of the 2d BVP example. (The edges corresponding to diagonal elements have not been pictured here.) Each variable in the first row that is eliminated creates connections between the next variable and the second row, and between variables in the second row. Inductively you see that after the first row is eliminated the second row is fully connected. (Connect this to exercise 5.30.)

**Exercise 5.31.** Finish the argument. What does the fact that variables in the second row are fully connected imply for the matrix structure? Sketch in a figure what happens after the first variable in the second row is eliminated.

**Exercise 5.32.** The LAPACK software for dense linear algebra has an LU factorization routine that overwrites the input matrix with the factors. Above you saw that is possible since the columns of  $L$  are generated precisely as the columns of  $A$  are eliminated. Why is such an algorithm not possible if the matrix is stored in sparse format?

#### 5.4.3.3 Fill-in estimates

In the above example you saw that the factorization of a sparse matrix can take much more space than the matrix itself, but still less than storing an entire square array of size the matrix dimension. We will now give some bounds for the *space complexity* of the factorization, that is, the amount of space needed to execute the factorization algorithm.

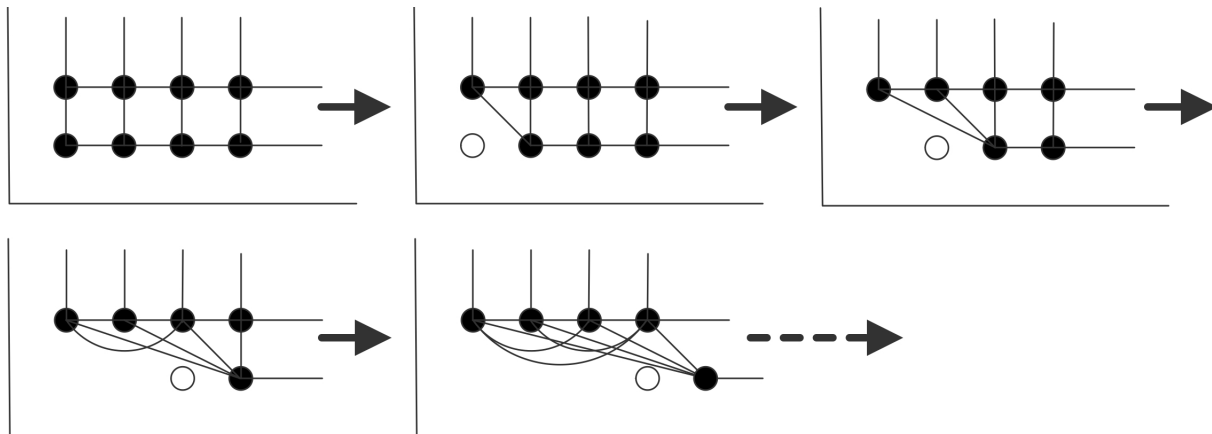

Figure 5.4: Creation of fill-in connection in the matrix graph

**Exercise 5.33.** Prove the following statements.

1. Assume that the matrix  $A$  has a *halfbandwidth*  $p$ , that is,  $a_{ij} = 0$  if  $|i - j| > p$ . Show that, after a factorization without pivoting,  $L + U$  has the same halfbandwidth.
2. Show that, after a factorization with partial pivoting,  $L$  has a left halfbandwidth of  $p$ , whereas  $U$  has a right halfbandwidth of  $2p$ .
3. Assuming no pivoting, show that the fill-in can be characterized as follows:  
Consider row  $i$ . Let  $j_{\min}$  be the leftmost nonzero in row  $i$ , that is  $a_{ij} = 0$  for  $j < j_{\min}$ . Then there will be no fill-in in row  $i$  to the left of column  $j_{\min}$ . Likewise, if  $i_{\min}$  is the topmost nonzero in column  $j$ , there will be no fill-in in column  $j$  above row  $i_{\min}$ .

As a result,  $L$  and  $U$  have a ‘skyline’ profile. Given a sparse matrix, it is now easy to allocate enough storage to fit a factorization without pivoting: this is known as *skyline storage*.

This exercise shows that we can allocate enough storage for the factorization of a banded matrix:

- for the factorization without pivoting of a matrix with bandwidth  $p$ , an array of size  $N \times p$  suffices;
- the factorization with partial pivoting of a matrix left halfbandwidth  $p$  and right halfbandwidth  $q$  can be stored in  $N \times (p + 2q + 1)$ .
- A skyline profile, sufficient for storing the factorization, can be constructed based on the specific matrix.

We can apply this estimate to the matrix from the two-dimensional BVP, section 4.2.3.

**Exercise 5.34.** Show that in equation (4.14) the original matrix has  $O(N) = O(n^2)$  nonzero elements,  $O(N^2) = O(n^4)$  elements in total, and the factorization has  $O(nN) = O(n^3) = O(N^{3/2})$  nonzeros.

These estimates show that the storage required for an  $LU$  factorization can be more than what is required for  $A$ , and the difference is not a constant factor, but related to the matrix size. Without proof we state that



investigating whether it is possible to reduce the amount of fill-in by renumbering the nodes of the matrix graph, or equivalently, by applying a *permutation* to the linear system.

**Exercise 5.36.** Consider the ‘arrow’ matrix with nonzeros only in the first row and column and on the diagonal:

$$\begin{pmatrix} * & * & \cdots & * \\ * & * & & \emptyset \\ \vdots & & \ddots & \\ * & \emptyset & & * \end{pmatrix}$$

What is the number of nonzeros in the matrix, and in the factorization, assuming that no addition ever results in zero? Can you find a symmetric permutation of the variables of the problem such that the new matrix has no fill-in?

This example is not typical, but it is true that fill-in estimates can sometimes be improved upon by clever permuting of the matrix (see for instance section 6.8.1). Even with this, as a rule the statement holds that an *LU* factorization of a sparse matrix takes considerably more space than the matrix itself. This is one of the motivating factors for the iterative methods in the next section.

#### 5.4.3.5 Fill-in reducing orderings

Some matrix properties are invariant under symmetric permutations.

**Exercise 5.37.** In linear algebra classes, you typically look at matrix properties and whether they are invariant under a change of basis, in particular under *unitary basis transformations*:

$$B = VAV^t, \quad \text{where } VV^t = I.$$

Show that a symmetric permutation a particular change of basis is. Name some matrix properties that do not change under unitary transformations.

Other properties are not: in the previous section you saw that the amount of fill-in is one of those. Thus, you may wonder what the best ordering is to reduce the fill-in of factoring a given matrix. This problem is intractable in practice, but various heuristics exist. Some of these heuristics can also be justified from a point of view of parallelism; in fact, the *nested dissection* ordering will only be discussed in the section on parallelism 6.8.1. Here we briefly show two other heuristics that predate the need for parallelism.

The *Cuthill-McKee ordering* [30] orders the variables in *level sets*. It considers the *adjacency graph* of the matrix, and proceeds as follows:

1. Take an arbitrary node, and call that ‘level zero’.
2. Given a level  $n$ , assign all nodes that are connecting to level  $n$ , and that are not yet in a level, to level  $n + 1$ .
3. For the so-called ‘reverse Cuthill-McKee ordering’, reverse the numbering of the levels.

**Exercise 5.38.** Show that permuting a matrix according to the Cuthill-McKee ordering has a *block tridiagonal* structure.



We will revisit this algorithm in section 6.10.1 when we consider parallelism.

Another ordering is motivated by the observation that the amount of fill-in is related to the degree of nodes.

**Exercise 5.39.** Show that eliminating a node with degree  $d$  leads to at most  $2d$  fill elements

The so-called *minimum degree ordering* proceeds as follows:

- Find the node with lowest degree;
- eliminate that node and update the degree information for the remaining nodes;
- repeat from the first step, with the updated matrix graph.

**Exercise 5.40.** Indicate a difference between the two above-mentioned methods. Both are based on inspection of the matrix graph; however, the minimum degree method requires much more flexibility in the data structures used. Explain why and discuss two aspects in detail.

## 5.5 Iterative methods

Gaussian elimination, the use of an  $LU$  factorization, is a simple way to find the solution of a linear system, but as we saw above, in the sort of problems that come from discretized PDEs, it can create a lot of fill-in. In this section we will look at a completely different approach, where the solution of the system is found by a sequence of approximations.

The computational scheme looks, very roughly, like:

$$\left\{ \begin{array}{l} \text{Choose any starting vector } x_0 \text{ and repeat for } i \geq 0: \\ x_{i+1} = Bx_i + c \\ \text{until some stopping test is satisfied.} \end{array} \right.$$

The important feature here is that no systems are solved with the original coefficient matrix; instead, every iteration involves a matrix-vector multiplication or a solution of a much simpler system. Thus we have replaced a complicated operation, constructing an  $LU$  factorization and solving a system with it, by a repeated simpler and cheaper operation. This makes iterative methods easier to code, and potentially more efficient.

Let us consider a simple example to motivate the precise definition of the iterative methods. Suppose we want to solve the system

$$\begin{pmatrix} 10 & 0 & 1 \\ 1/2 & 7 & 1 \\ 1 & 0 & 6 \end{pmatrix} \begin{pmatrix} x_1 \\ x_2 \\ x_3 \end{pmatrix} = \begin{pmatrix} 21 \\ 9 \\ 8 \end{pmatrix}$$

which has the solution  $(2, 1, 1)$ . Suppose you know (for example, from physical considerations) that solution components are roughly the same size. Observe the dominant size of the diagonal, then, to decide that

$$\begin{pmatrix} 10 & & \\ & 7 & \\ & & 6 \end{pmatrix} \begin{pmatrix} x_1 \\ x_2 \\ x_3 \end{pmatrix} = \begin{pmatrix} 21 \\ 9 \\ 8 \end{pmatrix}$$

might be a good approximation. This has the solution  $(2.1, 9/7, 8/6)$ . Clearly, solving a system that only involves the diagonal of the original system is both easy to do, and, at least in this case, fairly accurate.

Another approximation to the original system would be to use the lower triangle. The system

$$\begin{pmatrix} 10 & & \\ 1/2 & 7 & \\ 1 & 0 & 6 \end{pmatrix} \begin{pmatrix} x_1 \\ x_2 \\ x_3 \end{pmatrix} = \begin{pmatrix} 21 \\ 9 \\ 8 \end{pmatrix}$$

has the solution  $(2.1, 7.95/7, 5.9/6)$ . Solving triangular systems is a bit more work than diagonal systems, but still a lot easier than computing an  $LU$  factorization. Also, we have not generated any fill-in in the process of finding this approximate solution.

Thus we see that there are easy to compute ways of getting reasonably close to the solution. Can we somehow repeat this trick?

Formulated a bit more abstractly, what we did was instead of solving  $Ax = b$  we solved  $L\tilde{x} = b$ . Now define  $\Delta x$  as the distance from the true solution:  $\tilde{x} = x + \Delta x$ . This gives  $A\Delta x = A\tilde{x} - b \equiv r$ , where  $r$  is the *residual*. Next we solve again  $L\tilde{\Delta}x = r$  and update  $\tilde{\tilde{x}} = \tilde{x} - \tilde{\Delta}x$ .

iteration	1	2	3
$x_1$	2.1000	2.0017	2.000028
$x_2$	1.1357	1.0023	1.000038
$x_3$	0.9833	0.9997	0.999995

In this case we get two decimals per iteration, which is not typical.

It is now clear why iterative methods can be attractive. Solving a system by Gaussian elimination takes  $O(n^3)$  operations, as shown above. A single iteration in a scheme as the above takes  $O(n^2)$  operations if the matrix is dense, and possibly as low as  $O(n)$  for a sparse matrix. If the number of iterations is low, this makes iterative methods competitive.

**Exercise 5.41.** When comparing iterative and direct methods, the flop count is not the only relevant measure. Outline some issues relating to the efficiency of the code in both cases. Also compare the cases of solving a single linear system and solving multiple.

### 5.5.1 Abstract presentation

It is time to do a formal presentation of the iterative scheme of the above example. Suppose we want to solve  $Ax = b$ , and a direct solution is too expensive, but multiplying by  $A$  is feasible. Suppose furthermore that we have a matrix  $K \approx A$  such that solving  $Kx = b$  can be done cheaply.

Instead of solving  $Ax = b$  we solve  $Kx = b$ , and define  $x_0$  as the solution:  $Kx_0 = b$ . This leaves us with an error  $e_0 = x_0 - x$ , for which we have the equation  $A(x_0 - e_0) = b$  or  $Ae_0 = Ax_0 - b$ . We call  $r_0 \equiv Ax_0 - b$  the *residual*; the error then satisfies  $Ae_0 = r_0$ .

If we could solve the error from the equation  $Ae_0 = r_0$ , we would be done: the true solution is then found as  $x = x_0 - e_0$ . However, since solving with  $A$  was too expensive the last time, we can not do so this time either, so we determine the error correction approximately. We solve  $K\tilde{e}_0 = r_0$  and set  $x_1 := x_0 - \tilde{e}_0$ ; the story can now continue with  $e_1 = x_1 - x$ ,  $r_1 = Ax_1 - b$ ,  $K\tilde{e}_1 = r_1$ ,  $x_2 = x_1 - \tilde{e}_1$ , et cetera.

The iteration scheme is then:

Let  $x_0$  be given  
For  $i \geq 0$ :  
    let  $r_i = Ax_i - b$   
    compute  $e_i$  from  $Ke_i = r_i$   
    update  $x_{i+1} = x_i - e_i$

We call the basic scheme

$$x_{i+1} = x_i - K^{-1}r_1 \tag{5.11}$$

a *stationary iteration*. It is stationary because every update is performed the same way, without any dependence on the iteration number. This scheme has a simple analysis, but unfortunately limited applicability.

There are several questions we need to answer about iterative schemes:

- Does this scheme always take us to the solution?
- If the scheme converges, how quickly?
- When do we stop iterating?
- How do we choose  $K$ ?

We will now devote some attention to these matters, though a full discussion is beyond the scope of this book.

### 5.5.2 Convergence and error analysis

We start with the question of whether the iterative scheme converges, and how quickly. Consider one iteration step:

$$\begin{aligned} r_1 &= Ax_1 - b = A(x_0 - \tilde{e}_0) - b \\ &= r_0 - AK^{-1}r_0 \\ &= (I - AK^{-1})r_0 \end{aligned} \tag{5.12}$$

Inductively we find  $r_n = (I - AK^{-1})^n r_0$ , so  $r_n \downarrow 0$  if all eigenvalues satisfy  $|\lambda(I - AK^{-1})| < 1$ <sup>4</sup>.

This last statement gives us both a condition for convergence, by relating  $K$  to  $A$ , and a geometric convergence rate, if  $K$  is close enough.

**Exercise 5.42.** Derive a similar inductive relation for  $e_n$ .

It is hard to determine if the condition  $|\lambda(I - AK^{-1})| < 1$  is satisfied by computing the actual eigenvalues. However, sometimes the Gershgorin theorem (appendix 12.5) gives us enough information.

**Exercise 5.43.** Consider the matrix  $A$  of equation (4.14) that we obtained from discretization of a two-dimensional BVP. Let  $K$  be matrix containing the diagonal of  $A$ , that is  $k_{ii} = a_{ii}$  and  $k_{ij} = 0$  for  $i \neq j$ . Use the Gershgorin theorem to show that  $|\lambda(I - AK^{-1})| < 1$ .

---

4. This is fairly easy to see in the case where the matrix is diagonalizable and has a full basis of eigenvectors. However, it is true in the general case too.

The argument in this exercise is hard to generalize for more complicated choices of  $K$ , such as you will see below. Here we only remark that for certain matrices  $A$ , these choices of  $K$  will always lead to convergence, with a speed that decreases as the matrix size increases. We will not go into the details beyond stating that for  $M$ -matrices (see section 4.2.2) these iterative methods converge. For more details on the convergence theory of stationary iterative methods, see [159]

### 5.5.3 Computational form

Above, in section 5.5.1, we derived stationary iteration as a process that involves multiplying by  $A$  and solving with  $K$ . However, in some cases a simpler implementation is possible. Consider the case where  $A = K - N$ , and we know both  $K$  and  $N$ . Then we write  $Ax = b$  as

$$Kx = Nx + b \tag{5.13}$$

and we observe that an  $x$  satisfying (5.13) is a fixed point of the iteration

$$Kx^{(n+1)} = Nx^{(n)} + b.$$

It is easy to see that this is a stationary iteration:

$$\begin{aligned} Kx^{(n+1)} &= Nx^{(n)} + b \\ &= Kx^{(n)} - Ax^{(n)} + b \\ &= Kx^{(n)} - r^{(n)} \\ \Rightarrow x^{(n+1)} &= x^{(n)} - K^{-1}r^{(n)}. \end{aligned}$$

which is the basic form of equation (5.11). The convergence criterium  $|\lambda(I - AK^{-1})| < 1$  (see above) now simplifies to  $|\lambda(NK^{-1})| < 1$ .

Let us consider some special cases. First of all, let  $K = D_A$ , that is, the matrix containing the diagonal part of  $A$ :  $k_{ii} = a_{ii}$  and  $k_{ij} = 0$  for all  $i \neq j$ . Likewise,  $n_{ii} = 0$  and  $n_{ij} = -a_{ij}$  for all  $i \neq j$ .

This is known as the *Jacobi method*. The iteration scheme  $Kx^{(n+1)} = Nx^{(n)} + b$  now becomes

for  $t = 1, \dots$  until convergence, do:

for  $i = 1 \dots n$ :

//  $a_{ii}x_i^{(t+1)} = \sum_{j \neq i} a_{ij}x_j^{(t)} + b_i$  becomes:

$$x_i^{(t+1)} = a_{ii}^{-1}(\sum_{j \neq i} a_{ij}x_j^{(t)} + b_i)$$

(Bearing in mind that divisions are relatively costly, section 1.2, we would actually store the  $a_{ii}^{-1}$  quantities explicitly, and replace the division by a multiplication.)

This requires us to have one vector  $x$  for the current iterate  $x^{(t)}$ , and one temporary  $u$  for the next vector  $x^{(t+1)}$ . The easiest way to write this is probably:

for  $t = 1, \dots$  until convergence, do:

for  $i = 1 \dots n$ :

$$u_i = a_{ii}^{-1}(-\sum_{j \neq i} a_{ij}x_j + b_i)$$

copy  $x \leftarrow u$

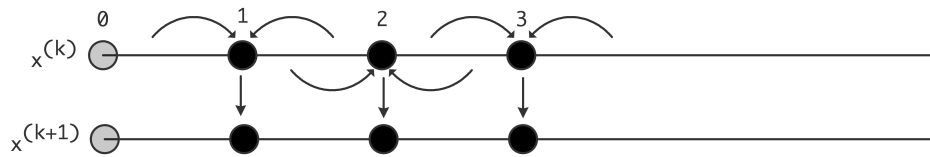

Figure 5.5: Data movement pattern in the Jacobi iteration on a one-dimensional problem

For the simple case of a one-dimensional problem this is illustrated in figure 5.5: in each  $x_i$  point the values of the two neighbours are combined with the current value to generate a new value. Since the computations in all the  $x_i$  points are independent, this can be done in parallel on a parallel computer.

But, you might think, in the sum  $\sum_{j \neq i} a_{ij} x_j$  why not use the  $x^{(t+1)}$  values for as far as already computed? In terms of the vectors  $x^{(t)}$  this means

for  $k = 1, \dots$  until convergence, do:

for  $i = 1 \dots n$ :

$$x_i^{(t+1)} = a_{ii}^{-1} \left( -\sum_{j < i} a_{ij} x_j^{(t+1)} - \sum_{j > i} a_{ij} x_j^{(t)} + b_i \right)$$

Surprisingly, the implementation is simpler than of the Jacobi method:

for  $t = 1, \dots$  until convergence, do:

for  $i = 1 \dots n$ :

$$x_i = a_{ii}^{-1} \left( -\sum_{j \neq i} a_{ij} x_j + b_i \right)$$

If you write this out as a matrix equation, you see that the newly computed elements  $x_i^{(t+1)}$  are multiplied with elements of  $D_A + L_A$ , and the old elements  $x_j^{(t)}$  by  $U_A$ , giving

$$(D_A + L_A)x^{(k+1)} = -U_A x^{(k)} + b$$

which is called the *Gauss-Seidel* method.

For the one-dimensional case, the Gauss-Seidel method is illustrated in figure 5.6; every  $x_i$  point still

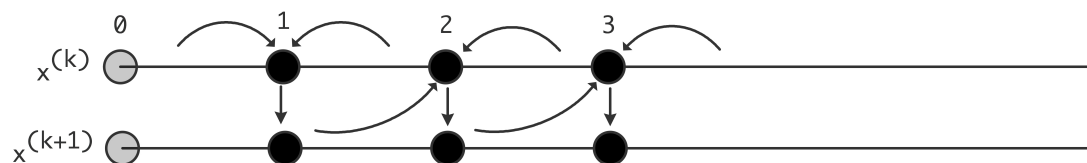

Figure 5.6: Data movement pattern in the Gauss-Seidel iteration on a one-dimensional problem

combines its neighbours' values, but now the left value is actually from the next outer iteration. Since the computations in the  $x_i$  points are now dependent, this type of iteration is not simple to implement on a parallel computer. Some strategies for dealing with this are discussed in section 6.7.

Finally, we can insert a damping parameter into the Gauss-Seidel scheme, giving the *Successive Over-Relaxation (SOR)* method:

for  $t = 1, \dots$  until convergence, do:

for  $i = 1 \dots n$ :

$$x_i^{(t+1)} = \omega a_{ii}^{-1} (-\sum_{j<i} a_{ij} x_j^{(t+1)} - \sum_{j>i} a_{ij} x_j^{(t)} + b_i) + (1 - \omega)x_i^{(t)}$$

Surprisingly for something that looks like an interpolation, the method actually works with value for  $\omega$  in the range  $\omega \in (0, 2)$ , the optimal value being larger than 1 [79]. Computing the optimal  $\omega$  is not simple.

#### 5.5.4 Convergence of the method

We are interested in two questions: firstly whether the iterative method converges at all, and if so, with what speed. The theory behind these questions goes far beyond this book. Above we remarked that convergence can often be guaranteed for  $M$ -matrices; with regard to the convergence speed a full analysis is usually only possible in model cases. For the matrices from BVPs, as described in section 4.2.3, we state without proof that the smallest eigenvalue of the coefficient matrix is  $O(h^2)$ . The geometric convergence ratio  $|\lambda(I - AK^{-1})|$  derived above can then be shown to be as follows:

- For the Jacobi method, the ratio is  $1 - O(h^2)$ ;
- For the Gauss-Seidel iteration it also is  $1 - O(h^2)$ , but the method converges twice as fast;
- For the SOR method, the optimal omega can improve the convergence factor to  $1 - O(h)$ .

#### 5.5.5 Choice of $K$

The convergence and error analysis above showed that the closer  $K$  is to  $A$ , the faster the convergence will be. In the initial examples we already saw the diagonal and lower triangular choice for  $K$ . We can describe these formally by letting  $A = D_A + L_A + U_A$  be a splitting into diagonal, lower triangular, upper triangular part of  $A$ . Here are some methods with their traditional names:

- Richardson iteration:  $K = \alpha I$ .
- Jacobi method:  $K = D_A$  (diagonal part),
- Gauss-Seidel method:  $K = D_A + L_A$  (lower triangle, including diagonal)
- The SOR method:  $K = \omega^{-1} D_A + L_A$
- Symmetric SOR (SSOR) method:  $K = (D_A + L_A) D_A^{-1} (D_A + U_A)$ .
- Iterative refinement:  $K = LU$  where  $LU$  is a true factorization of  $A$ . In exact arithmetic, solving a system  $LUx = y$  gives you the exact solution, so using  $K = LU$  in an iterative method would give convergence after one step. In practice, roundoff error will make the solution be inexact, so people will sometimes iterate a few steps to get higher accuracy.

**Exercise 5.44.** What is the extra cost of a few steps of iterative refinement over a single system solution, assuming a dense system?

**Exercise 5.45.** The Jacobi iteration for the linear system  $Ax = b$  is defined as

$$x_{i+1} = x_i - K^{-1}(Ax_i - b)$$

where  $K$  is the diagonal of  $A$ . Show that you can transform the linear system (that is, find a different coefficient matrix and right hand side vector that will still have the same solution) so that you can compute the same  $x_i$  vectors but with  $K = I$ , the identity matrix.

What are the implications of this strategy, in terms of storage and operation counts? Are there special implications if  $A$  is a sparse matrix?

Suppose  $A$  is symmetric. Give a simple example to show that  $K^{-1}A$  does not have to be symmetric. Can you come up with a different transformation of the system so that symmetry of the coefficient matrix is preserved and that has the same advantages as the transformation above? You can assume that the matrix has positive diagonal elements.

**Exercise 5.46.** Show that the transformation of the previous exercise can also be done for the Gauss-Seidel method. Give several reasons why this is not a good idea.

There are many different ways of choosing the preconditioner matrix  $K$ . Some of them are defined algebraically, such as the incomplete factorization discussed below. Other choices are inspired by the differential equation. For instance, if the operator is

$$\frac{\delta}{\delta x}(a(x, y) \frac{\delta}{\delta x} u(x, y)) + \frac{\delta}{\delta y}(b(x, y) \frac{\delta}{\delta y} u(x, y)) = f(x, y)$$

then the matrix  $K$  could be derived from the operator

$$\frac{\delta}{\delta x}(\tilde{a}(x) \frac{\delta}{\delta x} u(x, y)) + \frac{\delta}{\delta y}(\tilde{b}(y) \frac{\delta}{\delta y} u(x, y)) = f(x, y)$$

for some choices of  $\tilde{a}, \tilde{b}$ . The second set of equations is called a *separable problem*, and there are *fast solvers* for them, meaning that they have  $O(N \log N)$  time complexity; see [163].

#### 5.5.5.1 Constructing $K$ as an incomplete LU factorization

We briefly mention one other choice of  $K$ , which is inspired by Gaussian elimination. As in Gaussian elimination, we let  $K = LU$ , but now we use an *Incomplete LU (ILU)* factorization. Remember that a regular *LU* factorization is expensive because of the fill-in phenomenon. In an incomplete factorization, we limit the fill-in artificially.

If we write Gauss elimination as

```
for k, i, j:
    a[i, j] = a[i, j] - a[i, k] * a[k, j] / a[k, k]
```

we define an incomplete variant by

```
for k, i, j:
    if a[i, j] not zero:
        a[i, j] = a[i, j] - a[i, k] * a[k, j] / a[k, k]
```

- The resulting factorization is no longer exact:  $LU \approx A$ , so it is called an Incomplete LU (ILU) factorization.
- An ILU factorization takes much less space than a full factorization: the sparsity of  $L + U$  is the same as of  $A$ .

The algorithm above is called ‘ILU(0)’, where the zero refers to the fact that absolutely no fill-in is allowed during the incomplete factorization. Other schemes that allow a limited amount of fill-in exist. Much more can be said about this method; we will only remark that for  $M$ -matrices this scheme typically gives a converging method [122].

**Exercise 5.47.** How do operation counts of the matrix-vector product and solving a system with an ILU factorization compare?

You have seen that a full factorization of sparse matrix can need a higher order storage ( $N^{3/2}$  for the factorization versus  $N$  for the matrix), but that an incomplete factorization takes  $O(N)$ , just like the matrix. It may therefore come as a surprise that the error matrix  $R = A - LU$  is not dense, but itself sparse.

**Exercise 5.48.** Let  $A$  be the matrix of the Poisson equation,  $LU$  an incomplete factorization, and  $R = A - LU$ . Show that  $R$  is a bi-diagonal matrix:

- Consider that  $R$  consists of those elements that are discarded during the factorization. Where are they located in the matrix?
- Alternatively, write out the sparsity pattern of the product  $LU$  and compare that to the sparsity pattern of  $A$ .

### 5.5.5.2 Cost of constructing a preconditioner

In the example of the heat equation (section 4.3) you saw that each time step involves solving a linear system. As an important practical consequence, any setup cost for solving the linear system, such as constructing the preconditioner, will be amortized over the sequence of systems that is to be solved. A similar argument holds in the context of nonlinear equations, a topic that we will not discuss as such. Nonlinear equations are solved by an iterative process such as the *Newton method*, which in its multidimensional form leads to a sequence of linear systems. Although these have different coefficient matrices, it is again possible to amortize setup costs by reusing the preconditioner for a number of Newton steps.

### 5.5.5.3 Parallel preconditioners

Constructing and using a preconditioner is a balancing act of many considerations: a more accurate preconditioner leads to convergence in fewer iterations, but these iterations can be more expensive; in addition, a more accurate preconditioner can be more costly to construct. In parallel, this story is even more complicated, because certain preconditioners are not very parallel to begin with. Therefore, we may accept a preconditioner that is parallel, but that has a worse iteration count than a serial preconditioner. For more discussion, see section 6.7.

## 5.5.6 Stopping tests

The next question we need to tackle is when to stop iterating. Above we saw that the error decreases geometrically, so clearly we will never reach the solution exactly, even if that were possible in computer



arithmetic. Since we only have this relative convergence behaviour, how do we know when we are close enough?

We would like the error  $e_i = x - x_i$  to be small, but measuring this is impossible. Above we observed that  $Ae_i = r_i$ , so

$$\|e_i\| \leq \|A^{-1}\| \|r_i\| \leq \lambda_{\max}(A^{-1}) \|r_i\|$$

If we know anything about the eigenvalues of  $A$ , this gives us a bound on the error. (The norm of  $A$  is only the largest eigenvalue for symmetric  $A$ . In general, we need singular values here.)

Another possibility is to monitor changes in the computed solution. If these are small:

$$\|x_{n+1} - x_n\| / \|x_n\| < \epsilon$$

we can also conclude that we are close to the solution.

**Exercise 5.49.** Prove an analytic relationship between the distance between iterates and the distance to the true solution. If your equation contains constants, can they be determined theoretically or in practice?

**Exercise 5.50.** Write a simple program to experiment with linear system solving. Take the matrix from the 1D BVP (use an efficient storage scheme) and program an iterative method using the choice  $K = D_A$ . Experiment with stopping tests on the residual and the distance between iterates. How does the number of iterations depend on the size of the matrix?

Change the matrix construction so that a certain quantity is added the diagonal, that is, add  $\alpha I$  to the original matrix. What happens when  $\alpha > 0$ ? What happens when  $\alpha < 0$ ? Can you find the value where the behaviour changes? Does that value depend on the matrix size?

### 5.5.7 Theory of general iterative methods

Above, you saw iterative methods of the form  $x_{i+1} = x_i - K^{-1}r_i$ , and we will now see iterative methods of the more general form

$$x_{i+1} = x_i + \sum_{j \leq i} K^{-1} r_j \alpha_{ji}, \tag{5.14}$$

that is, using all previous residuals to update the iterate. One might ask, ‘why not introduce an extra parameter and write  $x_{i+1} = \alpha_i x_i + \dots$ ?’ Here we give a short argument that the former scheme describes a large class of methods. Indeed, the current author is not aware of methods that fall outside this scheme.

We defined the residual, given an approximate solution  $\tilde{x}$ , as  $\tilde{r} = A\tilde{x} - b$ . For this general discussion we precondition the system as  $K^{-1}Ax = K^{-1}b$ . (See section 5.5.5 where we discussed transforming the linear system.) The corresponding residual for the initial guess  $\tilde{x}$  is

$$\tilde{r} = K^{-1}A\tilde{x} - K^{-1}b.$$

We now find that

$$x = A^{-1}b = \tilde{x} - A^{-1}K\tilde{r} = \tilde{x} - (K^{-1}A)^{-1}\tilde{r}.$$

Now, the *Cayley-Hamilton theorem* states that for every  $A$  there exists a polynomial  $\phi(x)$  (the *characteristic polynomial*) such that

$$\phi(A) = 0.$$

We observe that we can write this polynomial  $\phi$  as

$$\phi(x) = 1 + x\pi(x)$$

where  $\pi$  is another polynomial. Applying this to  $K^{-1}A$ , we have

$$0 = \phi(K^{-1}A) = I + K^{-1}A\pi(K^{-1}A) \Rightarrow (K^{-1}A)^{-1} = -\pi(K^{-1}A)$$

so that  $x = \tilde{x} + \pi(K^{-1}A)\tilde{r}$ . Now, if we let  $x_0 = \tilde{x}$ , then  $\tilde{r} = K^{-1}r_0$ , giving the equation

$$x = x_0 + \pi(K^{-1}A)K^{-1}r_0.$$

This equation suggests an iterative scheme: if we can find a series of polynomials  $\pi^{(i)}$  of degree  $i$  to approximate  $\pi$ , it will give us a sequence of iterates

$$x_{i+1} = x_0 + \pi^{(i)}(K^{-1}A)K^{-1}r_0 = x_0 + K^{-1}\pi^{(i)}(AK^{-1})r_0 \quad (5.15)$$

that ultimately reaches the true solution. Multiplying this equation by  $A$  and subtracting  $b$  on both sides gives

$$r_{i+1} = r_0 + \tilde{\pi}^{(i)}(AK^{-1})r_0$$

where  $\tilde{\pi}^{(i)}(x) = x\pi^{(i)}(x)$ . This immediately gives us

$$r_i = \hat{\pi}^{(i)}(AK^{-1})r_0 \quad (5.16)$$

where  $\hat{\pi}^{(i)}$  is a polynomial of degree  $i$  with  $\hat{\pi}^{(i)}(0) = 1$ . This statement can be used as the basis of a convergence theory of iterative methods. However, this goes beyond the scope of this book.

Let us look at a couple of instances of equation (5.16). For  $i = 1$  we have

$$r_1 = (\alpha_1 AK^{-1} + \alpha_2 I)r_0 \Rightarrow AK^{-1}r_0 = \beta_1 r_1 + \beta_0 r_0$$

for some values  $\alpha_i, \beta_i$ . For  $i = 2$

$$r_2 = (\alpha_2 (AK^{-1})^2 + \alpha_1 AK^{-1} + \alpha_0)r_0$$

for different values  $\alpha_i$ . But we had already established that  $AK_0^{-1}$  is a combination of  $r_1, r_0$ , so now we have that

$$(AK^{-1})^2 r_0 \in \llbracket r_2, r_1, r_0 \rrbracket,$$

and it is clear how to show inductively that

$$(AK^{-1})^i r_0 \in \llbracket r_i, \dots, r_0 \rrbracket. \quad (5.17)$$

Substituting this in (5.15) we finally get

$$x_{i+1} = x_0 + \sum_{j \leq i} K^{-1} r_j \alpha_{ji}. \quad (5.18)$$

It is easy to see that the scheme (5.14) is of the form (5.18) and that the reverse implication also holds.

Summarizing, the basis of iterative methods is a scheme where iterates get updated by all residuals computed so far:

$$x_{i+1} = x_i + \sum_{j \leq i} K^{-1} r_j \alpha_{ji}. \quad (5.19)$$

Compare that to the stationary iteration (section 5.5.1) where the iterates get updated from just the last residual, and with a coefficient that stays constant.

We can say more about the  $\alpha_{ij}$  coefficients. If we multiply equation (5.19) by  $A$ , and subtract  $b$  from both sides, we find

$$r_{i+1} = r_i + \sum_{j \leq i} AK^{-1} r_j \alpha_{ji}. \quad (5.20)$$

Let us consider this equation for a moment. If we have a starting residual  $r_0$ , the next residual is computed as

$$r_1 = r_0 + AK^{-1} r_0 \alpha_{00}.$$

From this we get that  $AK^{-1} r_0 = \alpha_{00}^{-1} (r_1 - r_0)$ , so for the next residual,

$$\begin{aligned} r_2 &= r_1 + AK^{-1} r_1 \alpha_{11} + AK^{-1} r_0 \alpha_{01} \\ &= r_1 + AK^{-1} r_1 \alpha_{11} + \alpha_{00}^{-1} \alpha_{01} (r_1 - r_0) \\ \Rightarrow AK^{-1} r_1 &= \alpha_{11}^{-1} (r_2 - (1 + \alpha_{00}^{-1} \alpha_{01}) r_1 + \alpha_{00}^{-1} \alpha_{01} r_0) \end{aligned}$$

We see that we can express  $AK^{-1} r_1$  as a sum  $r_2 \beta_2 + r_1 \beta_1 + r_0 \beta_0$ , and that  $\sum_i \beta_i = 0$ .

Generalizing this, we find (with different  $\alpha_{ij}$  than above)

$$\begin{aligned} r_{i+1} &= r_i + AK^{-1} r_i \delta_i + \sum_{j \leq i+1} r_j \alpha_{ji} \\ r_{i+1} (1 - \alpha_{i+1,i}) &= AK^{-1} r_i \delta_i + r_i (1 + \alpha_{ii}) + \sum_{j < i} r_j \alpha_{ji} \\ r_{i+1} \alpha_{i+1,i} &= AK^{-1} r_i \delta_i + \sum_{j \leq i} r_j \alpha_{ji} \\ r_{i+1} \alpha_{i+1,i} \delta_i^{-1} &= AK^{-1} r_i + \sum_{j \leq i} r_j \alpha_{ji} \delta_i^{-1} \\ r_{i+1} \alpha_{i+1,i} \delta_i^{-1} &= AK^{-1} r_i + \sum_{j \leq i} r_j \alpha_{ji} \delta_i^{-1} \\ r_{i+1} \gamma_{i+1,i} &= AK^{-1} r_i + \sum_{j \leq i} r_j \gamma_{ji} \end{aligned} \quad \begin{array}{l} \text{substituting } \alpha_{ii} := 1 + \alpha_{ii} \\ \alpha_{i+1,i} := 1 - \alpha_{i+1,i} \\ \text{note that } \alpha_{i+1,i} = \sum_{j \leq i} \alpha_{ji} \\ \\ \text{substituting } \gamma_{ij} = \alpha_{ij} \delta_j^{-1} \end{array}$$

and we have that  $\gamma_{i+1,i} = \sum_{j \leq i} \gamma_{ji}$ .

We can take this last equation and write it as  $AK^{-1}R = RH$  where

$$H = \begin{pmatrix} -\gamma_{11} & -\gamma_{12} & \dots & & \\ \gamma_{21} & -\gamma_{22} & -\gamma_{23} & \dots & \\ 0 & \gamma_{32} & -\gamma_{33} & -\gamma_{34} & \\ \emptyset & \ddots & \ddots & \ddots & \ddots \end{pmatrix}$$

In this,  $H$  is a so-called *Hessenberg matrix*: it is upper triangular plus a single lower subdiagonal. Also we note that the elements of  $H$  in each column sum to zero.

Because of the identity  $\gamma_{i+1,i} = \sum_{j \leq i} \gamma_{ji}$  we can subtract  $b$  from both sides of the equation for  $r_{i+1}$  and ‘divide out  $A$ ’, giving

$$x_{i+1}\gamma_{i+1,i} = K^{-1}r_i + \sum_{j \leq i} x_j\gamma_{ji}.$$

This gives us the general form for iterative methods:

$$\begin{cases} r_i = Ax_i - b \\ x_{i+1}\gamma_{i+1,i} = K^{-1}r_i + \sum_{j \leq i} x_j\gamma_{ji} \\ r_{i+1}\gamma_{i+1,i} = AK^{-1}r_i + \sum_{j \leq i} r_j\gamma_{ji} \end{cases} \quad \text{where } \gamma_{i+1,i} = \sum_{j \leq i} \gamma_{ji}. \quad (5.21)$$

This form holds for many iterative methods, including the stationary iterative methods you have seen above. In the next sections you will see how the  $\gamma_{ij}$  coefficients follow from orthogonality conditions on the residuals.

### 5.5.8 Iterating by orthogonalization

The stationary methods described above (section 5.5.1) have been around in some form or another for a long time: Gauss described some variant in a letter to a student. They were perfected in the thesis of Young [170] in 1950; the final reference is probably the book by Varga [159]. These methods are little used these days, except in the specialized context of *multigrid smoothers*, a topic not discussed in this course.

At almost the same time, the field of methods based on orthogonalization was kicked off by two papers [107, 85], though it took a few decades for them to find wide applicability. (For further history, see [69].)

The basic idea is as follows:

If you can make all your residuals orthogonal to each other, and the matrix is of dimension  $n$ , then after  $n$  iterations you have to have converged: it is not possible to have an  $n + 1$ -st residual that is orthogonal to all previous and nonzero. Since a zero residual means that the corresponding iterate is the solution, we conclude that after  $n$  iterations we have the true solution in hand.

With the size of matrices that contemporary applications generate this reasoning is no longer relevant: it is not computationally realistic to iterate for  $n$  iterations. Moreover, roundoff will probably destroy any accuracy of the solution. However, it was later realized [141] that such methods are a realistic option in the case of *symmetric positive definite (SPD)* matrices. The reasoning is then:

The sequence of residuals spans a series of subspaces of increasing dimension, and by orthogonalizing, the new residuals are projected on these spaces. This means that they will have decreasing sizes.

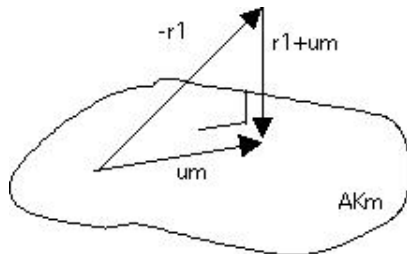

Figure 5.7: The optimal update  $u_m$  make the new residual orthogonal to the  $AK_m$  subspace

This is illustrated in figure 5.7.

In this section you will see the basic idea of iterating by orthogonalization. The method presented here is only of theoretical interest; next you will see the Conjugate Gradients (CG) and Generalized Minimum Residual (GMRES) methods that are the basis of many real-life applications.

Let us now take the basic scheme (5.21) and orthogonalize the residuals. Instead of the normal inner product we use the  $K^{-1}$ -inner product:

$$(x, y)_{K^{-1}} = x^t K^{-1} y$$

and we will force residuals to be  $K^{-1}$ -orthogonal:

$$\forall_{i \neq j}: r_i \perp_{K^{-1}} r_j \Leftrightarrow \forall_{i \neq j}: r_i K^{-1} r_j = 0$$

This is known as the *Full Orthogonalization Method (FOM)* scheme:

Let  $r_0$  be given  
 For  $i \geq 0$ :  
   let  $s \leftarrow K^{-1} r_i$   
   let  $t \leftarrow AK^{-1} r_i$   
   for  $j \leq i$ :  
     let  $\gamma_j$  be the coefficient so that  $t - \gamma_j r_j \perp r_j$   
   for  $j \leq i$ :  
     form  $s \leftarrow s - \gamma_j r_j$   
     and  $t \leftarrow t - \gamma_j r_j$   
   let  $x_{i+1} = (\sum_j \gamma_j)^{-1} s$ ,  $r_{i+1} = (\sum_j \gamma_j)^{-1} t$ .

You may recognize the *Gram-Schmidt* orthogonalization in this (see appendix 12.2 for an explanation): in each iteration  $r_{i+1}$  is initially set to  $AK^{-1} r_i$ , and orthogonalized against  $r_j$  with  $j \leq i$ .

We can use *modified Gram-Schmidt* by rewriting the algorithm as:

Let  $r_0$  be given  
 For  $i \geq 0$ :  
   let  $s \leftarrow K^{-1}r_i$   
   let  $t \leftarrow AK^{-1}r_i$   
   for  $j \leq i$ :  
     let  $\gamma_j$  be the coefficient so that  $t - \gamma_j r_j \perp r_j$   
     form  $s \leftarrow s - \gamma_j x_j$   
     and  $t \leftarrow t - \gamma_j r_j$   
 let  $x_{i+1} = (\sum_j \gamma_j)^{-1}s$ ,  $r_{i+1} = (\sum_j \gamma_j)^{-1}t$ .

These two version of the FOM algorithm are equivalent in exact arithmetic, but differ in practical circumstances in two ways:

- The modified Gram-Schmidt method is more numerically stable;
- The unmodified method allows you to compute all inner products simultaneously. We discuss this below in section 6.6.

Even though the FOM algorithm is not used in practice, these computational considerations carry over to the GMRES method below.

### 5.5.9 Coupled recurrences form of iterative methods

Above, you saw the general equation (5.21) for generating iterates and search directions. This equation is often split as

- An update of the  $x_i$  iterate from a single *search direction*:

$$x_{i+1} = x_i - \delta_i p_i,$$

and

- A construction of the search direction from the residuals known so far:

$$p_i = K^{-1}r_i + \sum_{j < i} \beta_{ij} K^{-1}r_j.$$

It is not hard to see inductively that we can also define

$$p_i = K^{-1}r_i + \sum_{j < i} \gamma_{ji} p_j,$$

and this last form is the one that is used in practice.

The iteration dependent coefficients are typically chosen to let the residuals satisfy various orthogonality conditions. For instance, one can choose to let the method be defined by letting the residuals be orthogonal ( $r_i^t r_j = 0$  if  $i \neq j$ ), or  $A$ -orthogonal ( $r_i^t A r_j = 0$  if  $i \neq j$ ). Many more schemes exist. Such methods can converge much faster than stationary iteration, or converge for a wider range of matrix and preconditioner types. Below we will see two such methods; their analysis, however, is beyond the scope of this course.

### 5.5.10 The method of Conjugate Gradients

In this section, we will derive the Conjugate Gradients (CG) method, which is a specific implementation of the FOM algorithm. In particular, it has pleasant computational properties in the case of an SPD matrix  $A$ .

The CG method takes as its basic form the coupled recurrences formulation described above, and the coefficients are defined by demanding that the sequence of residuals  $r_0, r_1, r_2, \dots$  satisfy

$$r_i^t K^{-1} r_j = 0 \quad \text{if } i \neq j.$$

We start by deriving the CG method for nonsymmetric systems, and then show how it simplifies in the symmetric case. (The approach here is taken from [51]).

The basic equations are

$$\begin{cases} x_{i+1} = x_i - \delta_i p_i \\ r_{i+1} = r_i - \delta_i A p_i \\ p_{i+1} = K^{-1} r_{i+1} + \sum_{j \leq i} \gamma_{ji+1} p_j, \end{cases} \quad (5.22)$$

where the first and third equation were introduced above, and the second can be found by multiplying the first by  $A$  (check this!).

We will now derive the coefficients in this method by induction. In essence, we assume that we have current residual  $r_{\text{cur}}$ , a residuals to be computed  $r_{\text{new}}$ , and a collection of known residuals  $R_{\text{old}}$ . Rather than using subscripts ‘old, cur, new’, we use the following convention:

- $x_1, r_1, p_1$  are the current iterate, residual, and search direction. Note that the subscript 1 does not denote the iteration number here.
- $x_2, r_2, p_2$  are the iterate, residual, and search direction that we are about to compute. Again, the subscript does not equal the iteration number.
- $X_0, R_0, P_0$  are all previous iterates, residuals, and search directions bundled together in a block of vectors.

In terms of these quantities, the update equations are then

$$\begin{cases} x_2 = x_1 - \delta_1 p_1 \\ r_2 = r_1 - \delta_1 A p_1 \\ p_2 = K^{-1} r_2 + v_{12} p_1 + P_0 u_{02} \end{cases} \quad (5.23)$$

where  $\delta_1, v_{12}$  are scalars, and  $u_{02}$  is a vector with length the number of iterations before the current. We now derive  $\delta_1, v_{12}, u_{02}$  from the orthogonality of the residuals. To be specific, the residuals have to be orthogonal under the  $K^{-1}$  inner product: we want to have

$$r_2^t K^{-1} r_1 = 0, \quad r_2^t K^{-1} R_0 = 0.$$

Combining these relations gives us, for instance,

$$\left. \begin{array}{l} r_1^t K^{-1} r_2 = 0 \\ r_2 = r_1 - \delta_1 A K^{-1} p_1 \end{array} \right\} \Rightarrow \delta_1 = \frac{r_1^t K^{-1} r_1}{r_1^t K^{-1} A p_1}.$$

Finding  $v_{12}, u_{02}$  is a little harder. For this, we start by summarizing the relations for the residuals and search directions in equation (5.22) in block form as

$$(R_0, r_1, r_2) \left( \begin{array}{cc|cc} 1 & & & \\ -1 & 1 & & \\ & \ddots & \ddots & \\ \hline & & -1 & 1 \\ \hline & & & -1 & 1 \end{array} \right) = A(P_0, p_1, p_2) \text{diag}(D_0, d_1, d_2)$$

$$(P_0, p_1, p_2) \left( \begin{array}{ccc} I - U_{00} & -u_{01} & -u_{02} \\ & 1 & -v_{12} \\ & & 1 \end{array} \right) = K^{-1}(R_0, r_1, r_2)$$

or abbreviated  $RJ = APD$ ,  $P(I-U) = R$  where  $J$  is the matrix with identity diagonal and minus identity subdiagonal. We then observe that

- $R^t K^{-1} R$  is diagonal, expressing the orthogonality of the residuals.
- Combining that  $R^t K^{-1} R$  is diagonal and  $P(I-U) = R$  gives that  $R^t P = R^t K^{-1} R(I-U)^{-1}$ . We now reason that  $(I-U)^{-1}$  is upper diagonal, so  $R^t P$  is upper triangular. This tells us quantities such as  $r_2^t p_1$  are zero.
- Combining the relations for  $R$  and  $P$ , we get first that

$$R^t K^{-t} AP = R^t K^{-t} RJD^{-1}$$

which tells us that  $R^t K^{-t} AP$  is lower bidiagonal. Expanding  $R$  in this equation gives

$$P^t AP = (I-U)^{-t} R^t RJD^{-1}.$$

Here  $D$  and  $R^t K^{-1} R$  are diagonal, and  $(I-U)^{-t}$  and  $J$  are lower triangular, so  $P^t AP$  is lower triangular.

- This tells us that  $P_0^t A p_2 = 0$  and  $p_1^t A p_2 = 0$ .
- Taking the product of  $P_0^t A$ ,  $p_1^t A$  with the definition of  $p_2$  in equation (5.23) gives

$$u_{02} = -(P_0^t AP_0)^{-1} P_0^t AK^{-1} r_2, \quad v_{12} = -(p_1^t A p_1)^{-1} p_1^t AK^{-1} r_2.$$

- If  $A$  is symmetric,  $P^t AP$  is lower triangular (see above) and symmetric, so it is in fact diagonal. Also,  $R^t K^{-t} AP$  is lower bidiagonal, so, using  $A = A^t$ ,  $P^t AK^{-1} R$  is upper bidiagonal. Since  $P^t AK^{-1} R = P^t AP(I-U)$ , we conclude that  $I-U$  is upper bidiagonal, so, only in the symmetric case,  $u_{02} = 0$ .

Some observations about this derivation.

- Strictly speaking we are only proving necessary relations here. It can be shown that these are sufficient too.
- There are different formulas that wind up computing the same vectors, in exact arithmetic. For instance, it is easy to derive that  $p_1^t r_1 = r_1^t r_1$ , so this can be substituted in the formulas just derived. The implementation of the CG method as it is typically implemented, is given in figure 5.8.



```

Compute  $r^{(0)} = Ax^{(0)} - b$  for some initial guess  $x^{(0)}$ 
for  $i = 1, 2, \dots$ 
  solve  $Kz^{(i-1)} = r^{(i-1)}$ 
   $\rho_{i-1} = r^{(i-1)T} z^{(i-1)}$ 
  if  $i = 1$ 
     $p^{(1)} = z^{(0)}$ 
  else
     $\beta_{i-1} = \rho_{i-1} / \rho_{i-2}$ 
     $p^{(i)} = z^{(i-1)} + \beta_{i-1} p^{(i-1)}$ 
  endif
   $q^{(i)} = Ap^{(i)}$ 
   $\delta_i = \rho_{i-1} / p^{(i)T} q^{(i)}$ 
   $x^{(i)} = x^{(i-1)} - \delta_i p^{(i)}$ 
   $r^{(i)} = r^{(i-1)} - \delta_i q^{(i)}$ 
  check convergence; continue if necessary
end

```

Figure 5.8: The Preconditioned Conjugate Gradient Method

- In the  $k$ -th iteration, computing  $P_0^t A r_2$  (which is needed for  $u_{02}$ ) takes  $k$  inner products. First of all, inner products are disadvantageous in a parallel context. Secondly, this requires us to store all search directions indefinitely. This second point implies that both work and storage go up with the number of iterations. Contrast this with the stationary iteration scheme, where storage was limited to the matrix and a few vectors, and work in each iteration was the same.
- The objections just raised disappear in the symmetric case. Since  $u_{02}$  is zero, the dependence on  $P_0$  disappears, and only the dependence on  $p_1$  remains. Thus, storage is constant, and the amount of work per iteration is constant. The number of inner products per iteration can be shown to be just two.

**Exercise 5.51.** Do a flop count of the various operations in one iteration of the CG method. Assume that  $A$  is the matrix of a five-point stencil and that the preconditioner  $M$  is an incomplete factorization of  $A$  (section 5.5.5.1). Let  $N$  be the matrix size.

### 5.5.11 Derivation from minimization

The above derivation of the CG method is not often found in the literature. The typical derivation starts with a minimization problem with a *symmetric positive definite (SPD)* matrix  $A$ :

$$\text{For which vector } x \text{ with } \|x\| = 1 \text{ is } f(x) = 1/2 x^t A x - b^t x \text{ minimal?} \quad (5.24)$$

If we accept the fact that the function  $f$  has a minimum, which follows from the positive definiteness, we find the minimum by computing the derivative

$$f'(x) = Ax - b.$$

and asking where  $f'(x) = 0$ . And, presto, there we have the original linear system.

**Exercise 5.52.** Derive the derivative formula above. (Hint: write out the definition of derivative as  $\lim_{h \downarrow 0} \dots$ ) Note that this requires  $A$  to be symmetric.

For the derivation of the iterative method, we state that the iterate  $x_i$  is updated with a certain stepsize  $\delta_i$  along a *search direction*  $p_i$ :

$$x_{i+1} = x_i + p_i \delta_i$$

The optimal stepsize

$$\delta_i = \frac{r_i^t p_i}{p_i^t A p_i}$$

is then derived as the one that minimizes the function  $f$  along the line  $x_i + \delta p_i$ :

$$\delta_i = \operatorname{argmin}_{\delta} \|f(x_i + p_i \delta)\|$$

The construction of the search direction from the residuals follows by induction proof from the requirement that the residuals be orthogonal. For a typical proof, see [3].

### 5.5.12 GMRES

In the discussion of the CG method above, it was pointed out that orthogonality of the residuals requires storage of all residuals, and  $k$  inner products in the  $k$ 'th iteration. Unfortunately, it can be proved that the work savings of the CG method can, for all practical purposes, not be found outside of *SPD* matrices [53].

The *GMRES* method is a popular implementation of such full orthogonalization schemes. In order to keep the computational costs within bounds, it is usually implemented as a *restarted* method. That is, only a certain number (say  $k = 5$  or  $20$ ) of residuals is retained, and every  $k$  iterations the method is restarted.

Other methods exist that do not have the growing storage demands of GMRES, for instance QMR [60] and BiCGstab [158]. Even though by the remark above these can not orthogonalize the residuals, they are still attractive in practice.

### 5.5.13 Complexity

The efficiency of Gaussian elimination was fairly easy to assess: factoring and solving a system takes, deterministically,  $\frac{1}{3}n^3$  operations. For an iterative method, the operation count is the product of the number of operations per iteration times the number of iterations. While each individual iteration is easy to analyze, there is no good theory to predict the number of iterations. (In fact, an iterative method may not even converge to begin with.) Added to this is the fact that Gaussian elimination can be coded in such a way that there is considerable cache reuse, making the algorithm run at a fair percentage of the computer's peak speed. Iterative methods, on the other hand, are much slower on a flops per second basis.

All these considerations make the application of iterative methods to linear system solving somewhere in between a craft and a black art. In practice, people do considerable experimentation to decide whether an iterative method will pay off, and if so, which method is preferable.

## 5.6 Further Reading

Iterative methods is a very deep field. As a practical introduction to the issues involved, you can read the ‘Templates book’ [6], online at <http://netlib.org/templates/>. For a deeper treatment of the theory, see the book by Saad [142] of which the first edition can be downloaded at <http://www-users.cs.umn.edu/~saad/books.html>.

## Chapter 6

### High performance linear algebra

In this section we will discuss a number of issues pertaining to linear algebra on parallel computers. We will take a realistic view of this topic, assuming that the number of processors is finite, and that the problem data is always large, relative to the number of processors. We will also pay attention to the physical aspects of the communication network between the processors.

We will analyze various linear algebra operations, including iterative methods, and their behaviour in the presence of a network with finite bandwidth and finite connectivity. This chapter will conclude with various short remarks regarding complications in algorithms that arise due to parallel execution.

#### 6.1 Collective operations

Collective operations play an important part in linear algebra operations. In fact, the scalability of the operations can depend on the cost of these collectives as you will see below. Here we give a short discussion of the essential ideas; see [22] for details.

In computing the cost of a collective operation, three architectural constants are enough to give lower bounds:  $\alpha$ , the cost of sending a single message,  $\beta$ , the inverse of the bandwidth for sending data (see section 1.3.2), and  $\gamma$ , the inverse of the processor speed, the time for performing an arithmetic operation. Sending  $n$  data items then takes time  $\alpha + \beta n$ . We further assume that a processor can only send one message at a time. We make no assumptions about the connectivity of the processors; thus, the lower bounds derived here will hold for a wide range of architectures.

The main implication of the architectural model above is that the number of active processors can only double in each step of an algorithm. For instance, to do a broadcast, first processor 0 sends to 1, then 0 and 1 can send to 2 and 3, then 0–3 send to 4–7, et cetera. This cascade of messages is called a *minimum spanning tree* of the processor network, and it follows that any collective algorithm has at least  $\alpha \log_2 p$  cost associated with the accumulated latencies.

##### 6.1.1 Broadcast

In a *broadcast* operation, a single processor has  $n$  data elements that it needs to send to all others: the other processors need a full copy of all  $n$  elements. By the above doubling argument, we conclude that

a broadcast to  $p$  processors takes time at least  $\lceil \log_2 p \rceil$  steps with a total latency of  $\lceil \log_2 p \rceil \alpha$ . Since  $n$  elements are sent, this adds at least a time  $n\beta$  for all elements to leave the sending processor, giving a total cost lower bound of

$$\lceil \log_2 p \rceil \alpha + n\beta.$$

We can illustrate the spanning tree method as follows:

	$t = 1$	$t = 2$	$t = 3$
$p_0$	$x_0 \downarrow, x_1 \downarrow, x_2 \downarrow, x_3 \downarrow$	$x_0 \downarrow, x_1 \downarrow, x_2 \downarrow, x_3 \downarrow$	$x_0, x_1, x_2, x_3$
$p_1$		$x_0 \downarrow, x_1 \downarrow, x_2 \downarrow, x_3 \downarrow$	$x_0, x_1, x_2, x_3$
$p_2$			$x_0, x_1, x_2, x_3$
$p_3$			$x_0, x_1, x_2, x_3$

(On  $t = 1$ ,  $p_0$  sends to  $p_1$ ; on  $t = 2$   $p_0, p_1$  send to  $p_2, p_3$ .) This algorithm has the correct  $\log_2 p \cdot \alpha$  term, but processor 0 repeatedly sends the whole vector, so the bandwidth cost is  $\log_2 p \cdot n\beta$ . If  $n$  is small, the latency cost dominates, so we may characterize this as a *short vector collective operation*

The following algorithm implements the broadcast as a combination of a scatter and a *bucket brigade algorithm*:

	$t = 0$	$t = 1$	<i>etcetera</i>
$p_0$	$x_0 \downarrow$	$x_0$	$x_3 \downarrow, x_0, x_2, x_3$
$p_1$	$x_1 \downarrow$	$x_0 \downarrow, x_1$	$x_0, x_1, x_3$
$p_2$	$x_2 \downarrow$	$x_1 \downarrow, x_2$	$x_0, x_1, x_2$
$p_3$	$x_3 \downarrow$	$x_2 \downarrow, x_3$	$x_1, x_2, x_3$

The complexity now becomes

$$p\alpha + \beta n(p-1)/p$$

which is not optimal in latency, but is a better algorithm if  $n$  is large, making this a *long vector collective operation*.

### 6.1.2 Reduction

In a *reduction* operation, each processor has  $n$  data elements, and one processor needs to combine them elementwise, for instance computing  $n$  sums or products.

By running the broadcast backwards in time, we see that a reduction operation has the same lower bound on the communication of  $\lceil \log_2 p \rceil \alpha + n\beta$ . A reduction operation also involves computation, which would take a total time of  $(p-1)\gamma n$  sequentially: each of  $n$  items gets reduced over  $p$  processors. Since these operations can potentially be parallelized, the lower bound on the computation is  $\frac{p-1}{p}\gamma n$ , giving a total of

$$\lceil \log_2 p \rceil \alpha + n\beta + \frac{p-1}{p}\gamma n.$$

We illustrate the spanning tree algorithm, using the notation  $x_i^{(j)}$  for the data item  $i$  that was originally on processor  $j$ , and  $x_i^{(j:k)}$  for the sum of the items  $i$  of processors  $j \dots k$ .

	$t = 1$	$t = 2$	$t = 3$
$p_0$	$x_0^{(0)}, x_1^{(0)}, x_2^{(0)}, x_3^{(0)}$	$x_0^{(0:1)}, x_1^{(0:1)}, x_2^{(0:1)}, x_3^{(0:1)}$	$x_0^{(0:3)}, x_1^{(0:3)}, x_2^{(0:3)}, x_3^{(0:3)}$
$p_1$	$x_0^{(1)} \uparrow, x_1^{(1)} \uparrow, x_2^{(1)} \uparrow, x_3^{(1)} \uparrow$		
$p_2$	$x_0^{(2)}, x_1^{(2)}, x_2^{(2)}, x_3^{(2)}$	$x_0^{(2:3)} \uparrow, x_1^{(2:3)} \uparrow, x_2^{(2:3)} \uparrow, x_3^{(2:3)} \uparrow$	
$p_3$	$x_0^{(3)} \uparrow, x_1^{(3)} \uparrow, x_2^{(3)} \uparrow, x_3^{(3)} \uparrow$		

On time  $t = 1$  processors  $p_0, p_2$  receive from  $p_1, p_3$ , and on  $t = 2$   $p_0$  receives from  $p_2$ .

As with the broadcast above, this algorithm does not achieve the lower bound; instead it has a complexity

$$\lceil \log_2 p \rceil (\alpha + n\beta + \frac{p-1}{p} \gamma n).$$

For short vectors the  $\alpha$  term dominates, so this algorithm is sufficient. For long vectors one can, as above, use other algorithms [22].

### 6.1.3 Allreduce

An *allreduce* operation computes the same elementwise reduction of  $n$  elements on each processor, but leaves the result on each processor, rather than just on the root of the spanning tree. This could be implemented as a reduction followed by a broadcast, but more clever algorithms exist.

The lower bound on the cost of an allreduce is, somewhat remarkably, almost the same as of a simple reduction: since in a reduction not all processors are active at the same time, we assume that the extra work can be spread out perfectly. This means that the lower bound on the latency and computation stays the same. For the bandwidth we reason as follows: in order for the communication to be perfectly parallelized,  $\frac{p-1}{p}n$  items have to arrive at, and leave each processor. Thus we have a total time of

$$\lceil \log_2 p \rceil \alpha + 2 \frac{p-1}{p} n\beta + \frac{p-1}{p} n\gamma.$$

### 6.1.4 Allgather

In a *gather* operation on  $n$  elements, each processor has  $n/p$  elements, and one processor collects them all, without combining them as in a reduction. The *allgather* computes the same gather, but leaves the result on all processors.

Again we assume that gathers with multiple targets are active simultaneously. Since every processor originates a minimum spanning tree, we have  $\log_2 p \alpha$  latency; since each processor receives  $n/p$  elements from  $p-1$  processors, there is  $(p-1) \times (n/p)\beta$  bandwidth cost. The total cost for constructing a length  $n$  vector by allgather is then

$$\lceil \log_2 p \rceil \alpha + \frac{p-1}{p} n\beta.$$

We illustrate this:

	$t = 1$	$t = 2$	$t = 3$
$p_0$	$x_0 \downarrow$	$x_0x_1 \downarrow$	$x_0x_1x_2x_3$
$p_1$	$x_1 \uparrow$	$x_0x_1 \downarrow$	$x_0x_1x_2x_3$
$p_2$	$x_2 \downarrow$	$x_2x_3 \uparrow$	$x_0x_1x_2x_3$
$p_3$	$x_3 \uparrow$	$x_2x_3 \uparrow$	$x_0x_1x_2x_3$

At time  $t = 1$ , there is an exchange between neighbours  $p_0, p_1$  and likewise  $p_2, p_3$ ; at  $t = 2$  there is an exchange over distance two between  $p_0, p_2$  and likewise  $p_1, p_3$ .

### 6.1.5 Reduce-scatter

In a *reduce-scatter* operation, each processor has  $n$  elements, and an  $n$ -way reduction is done on them. Unlike in the reduce or allreduce, the result is then broken up, and distributed as in a scatter operation.

Formally, processor  $i$  has an item  $x_i^{(i)}$ , and it needs  $\sum_j x_i^{(j)}$ . We could implement this by doing a size  $p$  reduction, collecting the vector  $(\sum_i x_0^{(i)}, \sum_i x_1^{(i)}, \dots)$  on one processor, and scattering the results. However it is possible to combine these operations in a so-called *bidirectional exchange* algorithm:

	$t = 1$	$t = 2$	$t = 3$
$p_0$	$x_0^{(0)}, x_1^{(0)}, x_2^{(0)} \downarrow, x_3^{(0)} \downarrow$	$x_0^{(0:2:2)}, x_1^{(0:2:2)} \downarrow$	$x_0^{(0:3)}$
$p_1$	$x_0^{(1)}, x_1^{(1)}, x_2^{(1)} \downarrow, x_3^{(1)} \downarrow$	$x_0^{(1:3:2)} \uparrow, x_1^{(1:3:2)}$	$x_1^{(0:3)}$
$p_2$	$x_0^{(2)} \uparrow, x_1^{(2)} \uparrow, x_2^{(2)}, x_3^{(2)}$	$x_2^{(0:2:2)}, x_3^{(0:2:2)} \downarrow$	$x_2^{(0:3)}$
$p_3$	$x_0^{(3)} \uparrow, x_1^{(3)} \uparrow, x_2^{(3)}, x_3^{(3)}$	$x_0^{(1:3:2)} \uparrow, x_1^{(1:3:2)}$	$x_3^{(0:3)}$

The reduce-scatter can be considered as a allgather run in reverse, with arithmetic added, so the cost is

$$\lceil \log_2 p \rceil \alpha + \frac{p-1}{p} n(\beta + \gamma).$$

## 6.2 Parallel dense matrix-vector product

In this section we will go into great detail into the performance, and in particular the scalability, of the parallel dense matrix-vector product. First we will consider a simple case, and discuss the parallelism aspects in some amount of detail.

### 6.2.1 Implementing the block-row case

In designing a parallel version of an algorithm, one often proceeds by making a *data decomposition* of the objects involved. In the case of a matrix-vector operations such as the product  $y = Ax$ , we have the choice of starting with a vector decomposition, and exploring its ramifications on how the matrix can be decomposed, or rather to start with the matrix, and deriving the vector decomposition from it. In this case, it seems natural to start with decomposing the matrix rather than the vector, since it will be most likely of larger computational significance. We now have two choices:

1. We make a one-dimensional decomposition of the matrix, splitting it in block rows or block columns, and assigning each of these – or groups of them – to a processor.
2. Alternatively, we can make a two-dimensional decomposition, assigning to each processor one or more general submatrices.

We start by considering the decomposition in block rows. Consider a processor  $p$  and the set  $I_p$  of indices of rows that it owns<sup>1</sup>, and let  $i \in I_p$  be a row that is assigned to this processor. The elements in row  $i$  are used in the operation

$$y_i = \sum_j a_{ij}x_j$$

We now reason:

- If processor  $p$  has all  $x_j$  values, the matrix-vector product can trivially be executed, and upon completion, the processor has the correct values  $y_j$  for  $j \in I_p$ .
- This means that every processor needs to have a copy of  $x$ , which is wasteful. Also it raises the question of data integrity: you need to make sure that each processor has the correct value of  $x$ .
- In certain practical applications (for instance iterative methods, as you have seen before), the output of the matrix-vector product is, directly or indirectly, the input for a next matrix-vector operation. This is certainly the case for the power method which computes  $x, Ax, A^2x, \dots$ . Since our operation started with each processor having the whole of  $x$ , but ended with it owning only the local part of  $Ax$ , we have a mismatch.
- Maybe it is better to assume that each processor, at the start of the operation, has only the local part of  $x$ , that is, those  $x_i$  where  $i \in I_p$ , so that the start state and end state of the algorithm are the same. This means we have to change the algorithm to include some communication that allows each processor to obtain those values  $x_i$  where  $i \notin I_p$ .

**Exercise 6.1.** Go through a similar reasoning for the case where the matrix is decomposed in block columns. Describe the parallel algorithm in detail, like above, but without giving pseudo code.

Let us now look at the communication in detail: we will consider a fixed processor  $p$  and consider the operations it performs and the communication that necessitates. According to the above analysis, in executing the statement  $y_i = \sum_j a_{ij}x_j$  we have to be aware what processor the  $j$  values ‘belong to’. To acknowledge this, we write

$$y_i = \sum_{j \in I_p} a_{ij}x_j + \sum_{j \notin I_p} a_{ij}x_j \tag{6.1}$$

1. For ease of exposition we will let  $I_p$  be a contiguous range of indices, but any general subset is allowed.



**Input:** Processor number  $p$ ; the elements  $x_i$  with  $i \in I_p$ ; matrix elements  $A_{ij}$  with  $i \in I_p$ .

**Output:** The elements  $y_i$  with  $i \in I_p$

```
for  $i \in I_p$  do  
     $s \leftarrow 0$ ;  
  
    for  $j \in I_p$  do  
         $s \leftarrow s + a_{ij}x_j$   
  
    for  $j \notin I_p$  do  
        send  $x_j$  from the processor that owns it to the current one, then;  
  
         $s \leftarrow s + a_{ij}x_j$   
  
 $y_i \leftarrow s$ 
```

**Procedure** Naive Parallel MVP( $A, x_{local}, y_{local}, p$ )

Figure 6.1: A naïvely coded parallel matrix-vector product

If  $j \in I_p$ , the instruction  $y_i \leftarrow y_i + a_{ij}x_j$  involves only quantities that are already local to the processor. Let us therefore concentrate on the case  $j \notin I_p$ . It would be nice if we could just write the statement

$$y(i) = y(i) + a(i, j) * x(j)$$

and some lower layer would automatically transfer  $x(j)$  from whatever processor it is stored on to a local register. (The PGAS languages of section 2.7.5 aim to do this, but their efficiency is far from guaranteed.) An implementation, based on this optimistic view of parallelism, is given in figure 6.1.

The immediate problem with such a ‘local’ approach is that too much communication will take place.

- If the matrix  $A$  is dense, the element  $x_j$  is necessary once for each row  $i \in I_p$ , and it will thus be fetched once for every row  $i \in I_p$ .
- For each processor  $q \neq p$ , there will be (large) number of elements  $x_j$  with  $j \in I_q$  that need to be transferred from processor  $q$  to  $p$ . Doing this in separate messages, rather than one bulk transfer, is very wasteful.

With shared memory these issues are not much of a problem, but in the context of distributed memory it is better to take a *buffering* approach.

Instead of communicating individual elements of  $x$ , we use a local buffer  $B_{pq}$  for each processor  $q \neq p$  where we collect the elements from  $q$  that are needed to perform the product on  $p$ . (See figure 6.2 for an illustration.) The parallel algorithm is given in figure 6.3.

In addition to preventing an element from being fetched more than once, this also combines many small messages into one large message, which is usually more efficient; recall our discussion of bandwidth and latency in section 2.8.8.

**Exercise 6.2.** Give pseudocode for the matrix-vector product using nonblocking operations (section 2.7.3.6)

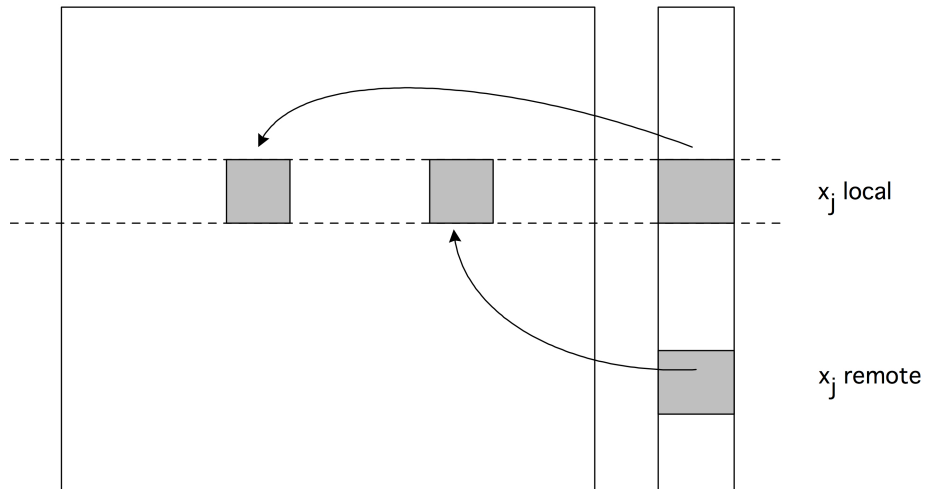

Figure 6.2: The parallel matrix-vector product with a blockrow distribution.

**Input:** Processor number  $p$ ; the elements  $x_i$  with  $i \in I_p$ ; matrix elements  $A_{ij}$  with  $i \in I_p$ .

**Output:** The elements  $y_i$  with  $i \in I_p$

**for**  $q \neq p$  **do**

    Send elements of  $x$  from processor  $q$  to  $p$ , receive in buffer  $B_{pq}$ .

$y_{local} \leftarrow Ax_{local}$

**for**  $q \neq p$  **do**

$y_{local} \leftarrow y_{local} + A_{pq}B_q$

**Procedure** Parallel MVP( $A, x_{local}, y_{local}, p$ )

Figure 6.3: A buffered implementation of the parallel matrix-vector product

Above we said that having a copy of the whole of  $x$  on each processor was wasteful in space. The implicit argument here is that, in general, we do not want local storage to be function of the number of processors: ideally it should be only a function of the local data. (This is related to weak scaling; section 2.3.4.)

You see that, because of communication considerations, we have actually decided that it is unavoidable, or at least preferable, for each processor to store the whole input vector. Such trade-offs between space and time efficiency are fairly common in parallel programming. For the dense matrix-vector product we can actually defend this overhead, since the vector storage is of lower order than the matrix storage, so our over-allocation is small by ratio. Below (section 6.5), we will see that for the sparse matrix-vector product the overhead can be much less.

It is easy to see that the parallel dense matrix-vector product, as described above, has perfect speedup *if we are allowed to ignore the time for communication*. In the next couple of sections you will see that the block row implementation above is not optimal if we take communication into account. For scalability we need a two-dimensional decomposition. We start with a discussion of collectives.

## 6.2.2 Scalability of the dense matrix-vector product

In this section, we will give a full analysis of the parallel computation of  $y \leftarrow Ax$ , where  $x, y \in \mathbb{R}^n$  and  $A \in \mathbb{R}^{n \times n}$ . We will assume that  $p$  nodes will be used, but we make no assumptions on their connectivity. We will see that the way the matrix is distributed makes a big difference for the scaling of the algorithm; for the original research see [83, 145, 150], and see section 2.3.4 for the definitions of the various forms of scaling.

### 6.2.2.1 Matrix-vector product, partitioning by rows

Partition

$$A \rightarrow \begin{pmatrix} A_0 \\ A_1 \\ \vdots \\ A_{p-1} \end{pmatrix} \quad x \rightarrow \begin{pmatrix} x_0 \\ x_1 \\ \vdots \\ x_{p-1} \end{pmatrix}, \quad \text{and} \quad y \rightarrow \begin{pmatrix} y_0 \\ y_1 \\ \vdots \\ y_{p-1} \end{pmatrix},$$

where  $A_i \in \mathbb{R}^{m_i \times n}$  and  $x_i, y_i \in \mathbb{R}^{m_i}$  with  $\sum_{i=0}^{p-1} m_i = n$  and  $m_i \approx n/p$ . We will start by assuming that  $A_i, x_i$ , and  $y_i$  are originally assigned to  $\mathcal{P}_i$ .

The computation is characterized by the fact that each processor needs the whole vector  $x$ , but owns only an  $n/p$  fraction of it. Thus, we execute an *allgather* of  $x$ . After this, the processor can execute the local product  $y_i \leftarrow A_i x$ ; no further communication is needed after that.

An algorithm with cost computation for  $y = Ax$  in parallel is then given by

Step	Cost (lower bound)
Allgather $x_i$ so that $x$ is available on all nodes	$\lceil \log_2(p) \rceil \alpha + \frac{p-1}{p} n \beta$ $\approx \log_2(p) \alpha + n \beta$
Locally compute $y_i = A_i x$	$\approx 2 \frac{n^2}{p} \gamma$

*Cost analysis* The total cost of the algorithm is given by, approximately,

$$T_p(n) = T_p^{\text{1D-row}}(n) = 2\frac{n^2}{p}\gamma + \underbrace{\log_2(p)\alpha + n\beta}_{\text{Overhead}}$$

Since the sequential cost is  $T_1(n) = 2n^2\gamma$ , the speedup is given by

$$S_p^{\text{1D-row}}(n) = \frac{T_1(n)}{T_p^{\text{1D-row}}(n)} = \frac{2n^2\gamma}{2\frac{n^2}{p}\gamma + \log_2(p)\alpha + n\beta} = \frac{p}{1 + \frac{p\log_2(p)\alpha}{2n^2\gamma} + \frac{p\beta}{2n\gamma}}$$

and the parallel efficiency by

$$E_p^{\text{1D-row}}(n) = \frac{S_p^{\text{1D-row}}(n)}{p} = \frac{1}{1 + \frac{p\log_2(p)\alpha}{2n^2\gamma} + \frac{p\beta}{2n\gamma}}.$$

*An optimist's view* Now, if one fixes  $p$  and lets  $n$  get large,

$$\lim_{n \rightarrow \infty} E_p(n) = \lim_{n \rightarrow \infty} \left[ \frac{1}{1 + \frac{p\log_2(p)\alpha}{2n^2\gamma} + \frac{p\beta}{2n\gamma}} \right] = 1.$$

Thus, if one can make the problem large enough, eventually the parallel efficiency is nearly perfect. However, this assumes unlimited memory, so this analysis is not practical.

*A pessimist's view* In a *strong scalability* analysis, one fixes  $n$  and lets  $p$  get large, to get

$$\lim_{p \rightarrow \infty} E_p(n) = \lim_{p \rightarrow \infty} \left[ \frac{1}{1 + \frac{p\log_2(p)\alpha}{2n^2\gamma} + \frac{p\beta}{2n\gamma}} \right] = 0.$$

Thus, eventually the parallel efficiency becomes nearly nonexistent.

*A realist's view* In a more realistic view we increase the number of processors with the amount of data. This is called *weak scalability*, and it makes the amount of memory that is available to store the problem scale linearly with  $p$ .

Let  $M$  equal the number of floating point numbers that can be stored in a single node's memory. Then the aggregate memory is given by  $Mp$ . Let  $n_{\max}(p)$  equal the largest problem size that can be stored in the aggregate memory of  $p$  nodes. Then, if *all* memory can be used for the matrix,

$$(n_{\max}(p))^2 = Mp \quad \text{or} \quad n_{\max}(p) = \sqrt{Mp}.$$

The question now becomes what the parallel efficiency for the largest problem that can be stored on  $p$  nodes:

$$\begin{aligned} E_p^{\text{1D-row}}(n_{\max}(p)) &= \frac{1}{1 + \frac{p \log_2(p)}{2(n_{\max}(p))^2} \frac{\alpha}{\gamma} + \frac{p}{2n_{\max}(p)} \frac{\beta}{\gamma}} \\ &= \frac{1}{1 + \frac{\log_2(p)}{2M} \frac{\alpha}{\gamma} + \frac{\sqrt{p}}{2\sqrt{M}} \frac{\beta}{\gamma}}. \end{aligned}$$

Now, if one analyzes what happens when the number of nodes becomes large, one finds that

$$\lim_{p \rightarrow \infty} E_p(n_{\max}(p)) = \lim_{p \rightarrow \infty} \left[ \frac{1}{1 + \frac{\log_2(p)}{2M} \frac{\alpha}{\gamma} + \frac{\sqrt{p}}{2\sqrt{M}} \frac{\beta}{\gamma}} \right] = 0.$$

Thus, this parallel algorithm for matrix-vector multiplication does not scale.

If you take a close look at this expression for efficiency, you'll see that the main problem is the  $1/\sqrt{p}$  part of the expression. This term involves a factor  $\beta$ , and if you follow the derivation backward you see that it comes from the time to send data between the processors. Informally this can be described as saying that the message size is too large to make the problem scalable. In fact, the message size is constant  $n$ , regardless the number of processors.

Alternatively, a realist realizes that there is a limited amount of time,  $T_{\max}$ , to get a computation done. Under the best of circumstances, that is, with zero communication overhead, the largest problem that we can solve in time  $T_{\max}$  is given by

$$T_p(n_{\max}(p)) = 2 \frac{(n_{\max}(p))^2}{p} \gamma = T_{\max}.$$

Thus

$$(n_{\max}(p))^2 = \frac{T_{\max} p}{2\gamma} \quad \text{or} \quad n_{\max}(p) = \frac{\sqrt{T_{\max}} \sqrt{p}}{\sqrt{2\gamma}}.$$

Then the parallel efficiency that is attained by the algorithm for the largest problem that can be solved in time  $T_{\max}$  is given by

$$E_{p, n_{\max}} = \frac{1}{1 + \frac{\log_2 p}{T} \alpha + \sqrt{\frac{p}{T}} \frac{\beta}{\gamma}}$$

and the parallel efficiency as the number of nodes becomes large approaches

$$\lim_{p \rightarrow \infty} E_p = \sqrt{\frac{T\gamma}{p\beta}}.$$

Again, efficiency cannot be maintained as the number of processors increases and the execution time is capped.

## 6.2.2.2 Matrix-vector product, partitioning by columns

Partition

$$A \rightarrow (A_0, A_1, \dots, A_{p-1}) \quad x \rightarrow \begin{pmatrix} x_0 \\ x_1 \\ \vdots \\ x_{p-1} \end{pmatrix}, \quad \text{and} \quad y \rightarrow \begin{pmatrix} y_0 \\ y_1 \\ \vdots \\ y_{p-1} \end{pmatrix},$$

where  $A_j \in \mathbb{R}^{n \times n_j}$  and  $x_j, y_j \in \mathbb{R}^{n_j}$  with  $\sum_{j=0}^{p-1} n_j = n$  and  $n_j \approx n/p$ .

We will start by assuming that  $A_j$ ,  $x_j$ , and  $y_j$  are originally assigned to  $\mathcal{P}_j$  (but now  $A_i$  is a block of columns). In this algorithm by columns, processor  $i$  can compute the length  $n$  vector  $A_i x_i$  without prior communication. These partial results then have to be added together

$$y \leftarrow \sum_i A_i x_i$$

in a *reduce-scatter* operation: each processor  $i$  scatters a part  $(A_i x_i)_j$  of its result to processor  $j$ . The receiving processors then perform a reduction, adding all these fragments:

$$y_j = \sum_i (A_i x_i)_j.$$

The algorithm with costs is then given by:

Step	Cost (lower bound)
Locally compute $y^{(j)} = A_j x_j$	$\approx 2 \frac{n^2}{p} \gamma$
Reduce-scatter the $y^{(j)}$ s so that $y_i = \sum_{j=0}^{p-1} y_i^{(j)}$ is on $\mathcal{P}_i$	$[\log_2(p)]\alpha + \frac{p-1}{p}n\beta + \frac{p-1}{p}n\gamma$ $\approx \log_2(p)\alpha + n(\beta + \gamma)$

*Cost analysis* The total cost of the algorithm is given by, approximately,

$$T_p^{\text{1D-col}}(n) = 2 \frac{n^2}{p} \gamma + \underbrace{\log_2(p)\alpha + n(\beta + \gamma)}_{\text{Overhead}}.$$

Notice that this is identical to the cost  $T_p^{\text{1D-row}}(n)$ , except with  $\beta$  replaced by  $(\beta + \gamma)$ . It is not hard to see that the conclusions about scalability are the same.

## 6.2.2.3 Two-dimensional partitioning

Next, partition

$$A \rightarrow \begin{pmatrix} A_{00} & A_{01} & \dots & A_{0,p-1} \\ A_{10} & A_{11} & \dots & A_{1,p-1} \\ \vdots & \vdots & \ddots & \vdots \\ A_{p-1,0} & A_{p-1,1} & \dots & A_{p-1,p-1} \end{pmatrix} \quad x \rightarrow \begin{pmatrix} x_0 \\ x_1 \\ \vdots \\ x_{p-1} \end{pmatrix}, \quad \text{and} \quad y \rightarrow \begin{pmatrix} y_0 \\ y_1 \\ \vdots \\ y_{p-1} \end{pmatrix},$$

## 6. High performance linear algebra

where  $A_{ij} \in \mathbb{R}^{n_i \times n_j}$  and  $x_i, y_i \in \mathbb{R}^{n_i}$  with  $\sum_{i=0}^{p-1} n_i = N$  and  $n_i \approx N/\sqrt{P}$ .

We will view the nodes as an  $r \times c$  mesh, with  $P = rc$ , and index them as  $p_{ij}$ , with  $i = 0, \dots, r - 1$  and  $j = 0, \dots, c - 1$ . Figure 6.4, for a  $12 \times 12$  matrix on a  $3 \times 4$  processor grid, illustrates the assignment of data to nodes, where the  $i, j$  ‘cell’ shows the matrix and vector elements owned by  $p_{ij}$ .

$x_0$ $a_{00} \ a_{01} \ a_{02} \ y_0$ $a_{10} \ a_{11} \ a_{12}$ $a_{20} \ a_{21} \ a_{22}$ $a_{30} \ a_{31} \ a_{32}$	$x_3$ $a_{03} \ a_{04} \ a_{05}$ $a_{13} \ a_{14} \ a_{15} \ y_1$ $a_{23} \ a_{24} \ a_{25}$ $a_{33} \ a_{34} \ a_{35}$	$x_6$ $a_{06} \ a_{07} \ a_{08}$ $a_{16} \ a_{17} \ a_{18}$ $a_{26} \ a_{27} \ a_{28} \ y_2$ $a_{37} \ a_{37} \ a_{38}$	$x_9$ $a_{09} \ a_{0,10} \ a_{0,11}$ $a_{19} \ a_{1,10} \ a_{1,11}$ $a_{29} \ a_{2,10} \ a_{2,11}$ $a_{39} \ a_{3,10} \ a_{3,11} \ y_3$
$x_1$ $a_{40} \ a_{41} \ a_{42} \ y_4$ $a_{50} \ a_{51} \ a_{52}$ $a_{60} \ a_{61} \ a_{62}$ $a_{70} \ a_{71} \ a_{72}$	$x_4$ $a_{43} \ a_{44} \ a_{45}$ $a_{53} \ a_{54} \ a_{55} \ y_5$ $a_{63} \ a_{64} \ a_{65}$ $a_{73} \ a_{74} \ a_{75}$	$x_7$ $a_{46} \ a_{47} \ a_{48}$ $a_{56} \ a_{57} \ a_{58}$ $a_{66} \ a_{67} \ a_{68} \ y_6$ $a_{77} \ a_{77} \ a_{78}$	$x_{10}$ $a_{49} \ a_{4,10} \ a_{4,11}$ $a_{59} \ a_{5,10} \ a_{5,11}$ $a_{69} \ a_{6,10} \ a_{6,11}$ $a_{79} \ a_{7,10} \ a_{7,11} \ y_7$
$x_2$ $a_{80} \ a_{81} \ a_{82} \ y_8$ $a_{90} \ a_{91} \ a_{92}$ $a_{10,0} \ a_{10,1} \ a_{10,2}$ $a_{11,0} \ a_{11,1} \ a_{11,2}$	$x_5$ $a_{83} \ a_{84} \ a_{85}$ $a_{93} \ a_{94} \ a_{95} \ y_9$ $a_{10,3} \ a_{10,4} \ a_{10,5}$ $a_{11,3} \ a_{11,4} \ a_{11,5}$	$x_8$ $a_{86} \ a_{87} \ a_{88}$ $a_{96} \ a_{97} \ a_{98}$ $a_{10,6} \ a_{10,7} \ a_{10,8} \ y_{10}$ $a_{11,7} \ a_{11,7} \ a_{11,8}$	$x_{11}$ $a_{89} \ a_{8,10} \ a_{8,11}$ $a_{99} \ a_{9,10} \ a_{9,11}$ $a_{10,9} \ a_{10,10} \ a_{10,11}$ $a_{11,9} \ a_{11,10} \ a_{11,11} \ y_{11}$

Figure 6.4: Distribution of matrix and vector elements for a problem of size 12 on a  $4 \times 3$  processor grid

In other words,  $p_{ij}$  owns the matrix block  $A_{ij}$  and parts of  $x$  and  $y$ . This makes possible the following algorithm<sup>2</sup>:

- Since  $x_j$  is distributed over the  $j$ th column, the algorithm starts by collecting  $x_j$  on each processor  $p_{ij}$  by an *allgather* inside the processor columns.
- Each processor  $p_{ij}$  then computes  $y_{ij} = A_{ij}x_j$ . This involves no further communication.
- The result  $y_i$  is then collected by gathering together the pieces  $y_{ij}$  in each processor row to form  $y_i$ , and this is then distributed over the processor row. These two operations are in fact combined to form a *reduce-scatter*.
- If  $r = c$ , we can transpose the  $y$  data over the processors, so that it can function as the input for a subsequent matrix-vector product. If, on the other hand, we are computing  $A^t Ax$ , then  $y$  is now correctly distributed for the  $A^t$  product.

2. This figure shows a partitioning of the matrix into contiguous blocks, and the vector distribution seem to be what is necessary to work with this matrix distribution. You could also look at this story the other way: start with a distribution of input and output vector, and then decide what that implies for the matrix distribution. For instance, if you distributed  $x$  and  $y$  the same way, you would arrive at a different matrix distribution, but otherwise the product algorithm would be much the same; see [49].

*Algorithm* The algorithm with cost analysis is

Step	Cost (lower bound)
Allgather $x_i$ 's within columns	$\lceil \log_2(r) \rceil \alpha + \frac{r-1}{p} n \beta$ $\approx \log_2(r) \alpha + \frac{n}{c} \beta$
Perform local matrix-vector multiply	$\approx 2 \frac{n^2}{p} \gamma$
Reduce-scatter $y_i$ 's within rows	$\lceil \log_2(c) \rceil \alpha + \frac{c-1}{p} n \beta + \frac{c-1}{p} n \gamma$ $\approx \log_2(c) \alpha + \frac{n}{c} \beta + \frac{n}{c} \gamma$

*Cost analysis* The total cost of the algorithm is given by, approximately,

$$T_p^{r \times c}(n) = T_p^{r \times c}(n) = 2 \frac{n^2}{p} \gamma + \underbrace{\log_2(p) \alpha + \left( \frac{n}{c} + \frac{n}{r} \right) \beta + \frac{n}{r} \gamma}_{\text{Overhead}}.$$

We will now make the simplification that  $r = c = \sqrt{p}$  so that

$$T_p^{\sqrt{p} \times \sqrt{p}}(n) = T_p^{\sqrt{p} \times \sqrt{p}}(n) = 2 \frac{n^2}{p} \gamma + \underbrace{\log_2(p) \alpha + \frac{n}{\sqrt{p}} (2\beta + \gamma)}_{\text{Overhead}}$$

Since the sequential cost is  $T_1(n) = 2n^2\gamma$ , the speedup is given by

$$S_p^{\sqrt{p} \times \sqrt{p}}(n) = \frac{T_1(n)}{T_p^{\sqrt{p} \times \sqrt{p}}(n)} = \frac{2n^2\gamma}{2 \frac{n^2}{p} \gamma + \frac{n}{\sqrt{p}} (2\beta + \gamma)} = \frac{p}{1 + \frac{p \log_2(p)}{2n^2} \frac{\alpha}{\gamma} + \frac{\sqrt{p}}{2n} \frac{(2\beta + \gamma)}{\gamma}}$$

and the parallel efficiency by

$$E_p^{\sqrt{p} \times \sqrt{p}}(n) = \frac{1}{1 + \frac{p \log_2(p)}{2n^2} \frac{\alpha}{\gamma} + \frac{\sqrt{p}}{2n} \frac{(2\beta + \gamma)}{\gamma}}$$

We again ask the question what the parallel efficiency for the largest problem that can be stored on  $p$  nodes is.

$$\begin{aligned} E_p^{\sqrt{p} \times \sqrt{p}}(n_{\max}(p)) &= \frac{1}{1 + \frac{p \log_2(p)}{2n^2} \frac{\alpha}{\gamma} + \frac{\sqrt{p}}{2n} \frac{(2\beta + \gamma)}{\gamma}} \\ &= \frac{1}{1 + \frac{\log_2(p)}{2M} \frac{\alpha}{\gamma} + \frac{1}{2\sqrt{M}} \frac{(2\beta + \gamma)}{\gamma}} \end{aligned}$$

so that still

$$\lim_{p \rightarrow \infty} E_p^{\sqrt{p} \times \sqrt{p}}(n_{\max}(p)) = \lim_{p \rightarrow \infty} \frac{1}{1 + \frac{\log_2(p)}{2M} \frac{\alpha}{\gamma} + \frac{1}{2\sqrt{M}} \frac{(2\beta + \gamma)}{\gamma}} = 0.$$



However,  $\log_2 p$  grows very slowly with  $p$  and is therefore considered to act much like a constant. In this case  $E_p^{\sqrt{p} \times \sqrt{p}}(n_{\max}(p))$  decreases very slowly and the algorithm is considered to be scalable for practical purposes.

Note that when  $r = p$  the 2D algorithm becomes the "partitioned by rows" algorithm and when  $c = p$  it becomes the "partitioned by columns" algorithm. It is not hard to show that the 2D algorithm is scalable in the sense of the above analysis when  $r = c$ , as long as  $r/c$  is kept constant.

### 6.3 LU factorization in parallel

The matrix-vector and matrix-product are easy to parallelize in one sense. The elements of the output can all be computed independently and in any order, so we have many degrees of freedom in parallelizing the algorithm. This does not hold for computing an LU factorization, or solving a linear system with the factored matrix.

#### 6.3.1 Solving a triangular system

The solution of a triangular system  $y = L^{-1}x$  (with  $L$  is lower triangular) is a matrix-vector operation, so it has its  $O(N^2)$  complexity in common with the matrix-vector product. However, unlike the product operation, this solution process contains a recurrence relation between the output elements:

$$y_i = \ell_{ii}^{-1} \left( x_i - \sum_{j < i} \ell_{ij} x_j \right).$$

This means that parallelization is not trivial. In the case of a sparse matrix special strategies may be possible; see section 6.10. Here we will make a few remarks about general, dense case.

Let us assume for simplicity that communication takes no time, and that all arithmetic operations take the same unit time. First we consider the matrix distribution by rows, meaning that processor  $p$  stores the elements  $\ell_{p*}$ . With this we can implement the triangular solution as:

- Processor 1 solves  $y_1 = \ell_{11}^{-1} x_1$  and sends its value to the next processor.
- In general, processor  $p$  gets the values  $y_1, \dots, y_{p-1}$  from processor  $p - 1$ , and computes  $y_p$ ;
- Each processor  $p$  then sends  $y_1, \dots, y_p$  to  $p + 1$ .

**Exercise 6.3.** Show that this algorithm takes time  $2N^2$ , just like the sequential algorithm.

This algorithm has each processor passing all computed  $y_i$  values to its successor, in a pipeline fashion. However, this means that processor  $p$  receives  $y_1$  only at the last moment, whereas that value was computed already in the first step. We can formulate the solution algorithm in such a way that computed elements are made available as soon as possible:

- Processor 1 solve  $y_1$ , and sends it to all later processors.
- In general, processor  $p$  waits for individual messages with values  $y_q$  for  $q < p$ .
- Processor  $p$  then computes  $y_p$  and sends it to processors  $q$  with  $q > p$ .

Under the assumption that communication time is negligible, this algorithm can be much faster. For instance, all processors  $p > 1$  receive  $y_1$  simultaneously, and can compute  $\ell_{p1} y_1$  simultaneously.

**Exercise 6.4.** Show that this algorithm variant takes a time  $O(N)$ .

**Exercise 6.5.** Now consider the matrix distribution by columns: processor  $p$  stores  $\ell_{*p}$ . Outline the triangular solution algorithm with this distribution, and show that the parallel solve time is  $O(N)$ .

### 6.3.2 Factorization

A full analysis of the scalability of dense LU factorization is quite involved, so we will state without further proof that as in the matrix-vector case a two-dimensional distribution is needed. However, we can identify a further complication. Since factorizations of any type<sup>3</sup> progress through a matrix, processors will be inactive for part of the time.

**Exercise 6.6.** Consider the regular right-looking Gaussian elimination

```

for k=1..n
  p = 1/a(k,k)
  for i=k+1,n
    for j=k+1,n
      a(i,j) = a(i,j) - a(i,k)*p*a(k,j)

```

Analyze the running time, speedup, and efficiency as a function of  $N$ , if we assume a one-dimensional distribution, and enough processors to store one column per processor. Show that speedup is limited.

Also perform this analysis for a two-dimensional decomposition where each processor stores one element.

For this reason, an *overdecomposition* is used, where the matrix is divided in more blocks than there are processors, and each processor stores several, non-contiguous, sub-matrices. We illustrate this in figure 6.5

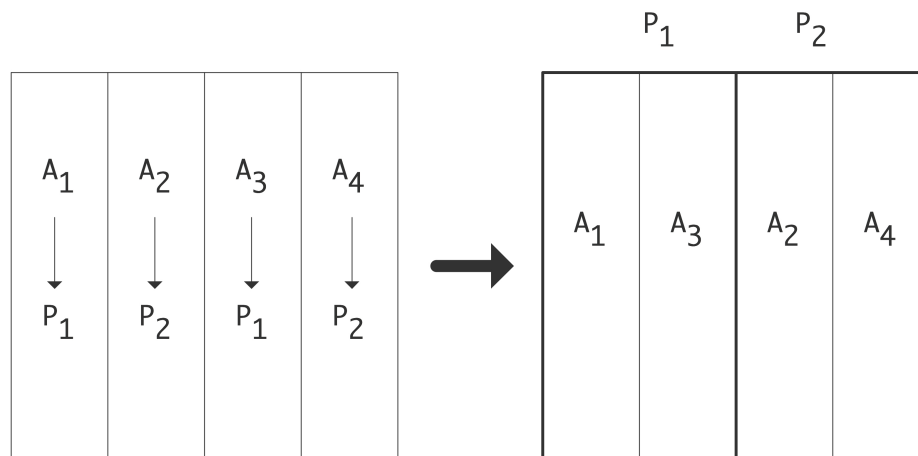

Figure 6.5: One-dimensional cyclic distribution: assignment of four matrix columns to two processors, and the resulting mapping of storage to matrix columns

3. Gaussian elimination can be performed in right-looking, left-looking and Crout variants; see [157].

where we divide four block columns of a matrix to two processors: each processor stores in a contiguous block of memory two non-contiguous matrix columns.

Next, we illustrate in figure 6.6 that a matrix-vector product with such a matrix can be performed without

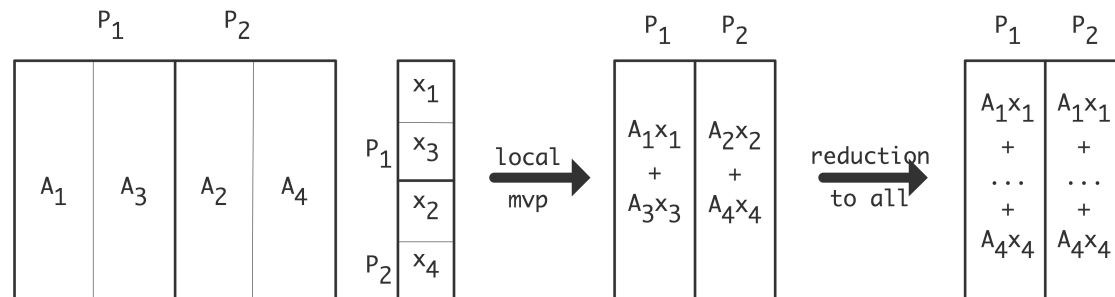

Figure 6.6: Matrix-vector multiplication with a cyclicly distributed matrix

knowing that the processors store non-contiguous parts of the matrix. All that is needed is that the input vector is also cyclicly distributed.

**Exercise 6.7.** Now consider a  $4 \times 4$  matrix and a  $2 \times 2$  processor grid. Distribute the matrix cyclicly both by rows and columns. Show how the matrix-vector product can again be performed using the contiguous matrix storage, as long as the input is distributed correctly. How is the output distributed? Show that more communication is needed than the reduction of the one-dimensional example.

Specifically, with  $P < N$  processors, and assuming for simplicity  $N = cP$ , we let processor 0 store rows  $0, c, 2c, 3c, \dots$ ; processor 1 stores rows  $1, c+1, 2c+1, \dots$ , et cetera. This scheme can be generalized to a two-dimensional distribution, if  $N = c_1P_1 = c_2P_2$  and  $P = P_1P_2$ . This is called a *2D cyclic distribution*. This scheme can be further extended by considering block rows and columns (with a small block size), and assigning to processor 0 the *block* rows  $0, c, 2c, \dots$

**Exercise 6.8.** Consider a square  $n \times n$  matrix, and a square  $p \times p$  processor grid, where  $p$  divides  $n$  without remainder. Consider the overdecomposition outlined above, and make a sketch of matrix element assignment for the specific case  $n = 6, p = 2$ . That is, draw an  $n \times n$  table where location  $(i, j)$  contains the processor number that stores the corresponding matrix element. Also make a table for each of the processors describing the local to global mapping, that is, giving the global  $(i, j)$  coordinates of the elements in the local matrix. (You will find this task facilitated by using zero-based numbering.)

Now write functions  $P, Q, I, J$  of  $i, j$  that describe the global to local mapping, that is, matrix element  $a_{ij}$  is stored in location  $(I(i, j), J(i, j))$  on processor  $(P(i, j), Q(i, j))$ .

## 6.4 Matrix-matrix product

In section 1.6.11 we considered the high performance implementation of the single-processor *matrix-matrix product*. We will now briefly consider the distributed memory version of this operation.

One algorithm for this operation is known as *Cannon's algorithm*. It assumes a square processor grid where processor  $(i, j)$  gradually accumulates the  $(i, j)$  block  $C_{i,j} = \sum_k A_{i,k} B_{k,j}$ ; see figure 6.7.

If you start top-left, you see that processor  $(0, 0)$  has both  $A_{00}$  and  $B_{00}$ , so it can immediately start doing a local multiplication. However, processor  $(0, 1)$  has  $A_{01}$  and  $B_{01}$ , which are not needed together. However, if we rotate the second column of  $B$  up by one position, processor  $(0, 1)$  will have  $A_{01}, B_{11}$  and those two do need to be multiplied. Similarly, we rotate the third column of  $B$  up by two places so that  $(0, 2)$  contains  $A_{02}, B_{22}$ .

How does this story go in the second row? Processor  $(1, 0)$  has  $A_{10}, B_{10}$  which are not needed together. If we rotate the second row of  $A$  one position to the left, it contains  $A_{11}, B_{10}$  which are needed for a partial product. And now processor  $(1, 1)$  has  $A_{11}, B_{11}$ .

If we continue this story, we start with a matrix  $A$  of which the rows have been rotated left, and  $B$  of which the columns have been rotated up. In this setup, processor  $(i, j)$  contains  $A_{i,i+j}$  and  $B_{i+j,j}$ , where the addition is done modulo the matrix size. This means that each processor can start by doing a local product.

Now we observe that  $C_{ij} = \sum_k A_{ik} B_{kj}$  implies that the next partial product term comes from increasing  $k$  by 1. The corresponding elements of  $A, B$  can be moved into the processor by rotating the rows and columns by another location.

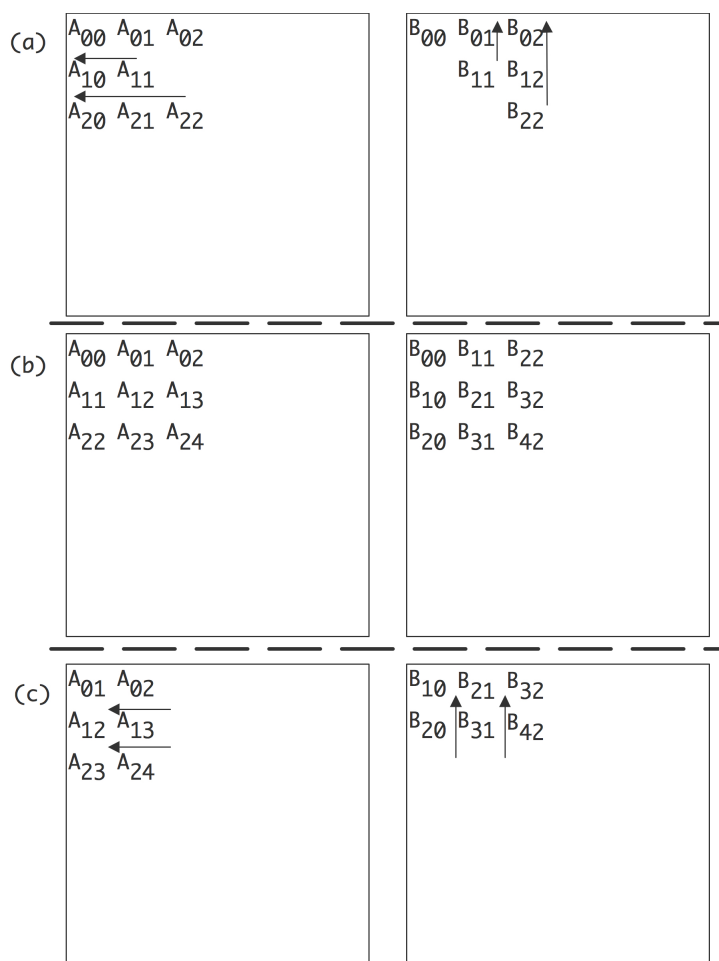

Figure 6.7: Cannon's algorithm for matrix-matrix multiplication: (a) initial rotation of matrix rows and columns, (b) resulting position in which processor  $(i, j)$  can start accumulating  $\sum_k A_{ik} B_{kj}$ , (c) subsequent rotation of  $A, B$  for the next term.

### 6.5 Sparse matrix-vector product

In linear system solving through iterative methods (see section 5.5) the matrix-vector product is computationally an important kernel, since it is executed in each of potentially hundreds of iterations. In this section we look at performance aspects of the matrix-vector product on a single processor first; the multi-processor case will get our attention in section 6.5.

#### 6.5.1 The single-processor sparse matrix-vector product

We are not much worried about the dense matrix-vector product in the context of iterative methods, since one typically does not iterate on dense matrices. In the case that we are dealing with block matrices, refer to section 1.6.10 for an analysis of the dense product. The sparse product is a lot trickier, since most of that analysis does not apply.

**Data reuse in the sparse matrix-vector product** There are some similarities between the dense matrix-vector product, executed by rows, and the CRS sparse product (section 5.4.1.4). In both cases all matrix elements are used sequentially, so any cache line loaded is utilized fully. However, the CRS product is worse at least the following ways:

- The indirect addressing requires loading the elements of an integer vector. This implies that the sparse product has more memory traffic for the same number of operations.
- The elements of the source vector are not loaded sequentially, in fact they can be loaded in effectively a random order. This means that a cacheline contains a source element will likely not be fully utilized. Also, the prefetch logic of the memory subsystem (section 1.3.5) cannot assist here.

For these reasons, an application that is computationally dominated by the sparse matrix-vector product can very well be run at  $\approx 5\%$  of the peak performance of the processor.

It may be possible to improve this performance if the structure of the matrix is regular in some sense. One such case is where we are dealing with a *block matrix* consisting completely of small dense blocks. This leads at least to a reduction in the amount of indexing information: if the matrix consists of  $2 \times 2$  blocks we get a  $4\times$  reduction in the amount of integer data transferred.

**Exercise 6.9.** Give two more reasons why this strategy is likely to improve performance. Hint: cachelines, and reuse.

Such a *matrix tessellation* may give a factor of 2 in performance improvement. Assuming such an improvement, we may adopt this strategy even if the matrix is not a perfect block matrix: if every  $2 \times 2$  block will contain one zero element we may still get a factor of 1.5 performance improvement [161, 20].

**Vectorization in the sparse product** In other circumstances bandwidth and reuse are not the dominant concerns:

- On old vector computers, such as old Cray machines, memory was fast enough for the processor, but vectorization was paramount. This is a problem for sparse matrices, since the number of zeros in a matrix row, and therefore the vector length, is typically low.

- On GPUs memory bandwidth is fairly high, but it is necessary to find large numbers of identical operations. Matrix can be treated independently, but since the rows are likely of unequal length this is not an appropriate source of parallelism.

For these reasons, a variation on the *diagonal storage* scheme for sparse matrices has seen a revival recently. The observation here is that if you sort the matrix rows by the number of rows you get a small number of blocks of rows; each block will be fairly large, and in each block the rows have the same number of elements.

A matrix with such a structure is good for vector architectures [31]. In this case the product is computed by diagonals.

**Exercise 6.10.** Write pseudo-code for this case. How did the sorting of the rows improve the situation?

This sorted storage scheme also solves the problem we noted on GPUs [17]. In this case we the traditional CRS product algorithm, and we have an amount of parallelism equal to the number of rows in a block.

Of course there is the complication that we have permuted the matrix: the input and output vectors will need to be permuted accordingly. If the product operation is part of an iterative method, doing this permutation back and forth in each iteration will probably negate any performance gain. Instead we could permute the whole linear system and iterate on the permuted system.

**Exercise 6.11.** Can you think of reasons why this would work? Reasons why it wouldn't?

### 6.5.2 The parallel sparse matrix-vector product

In section 5.4 you saw a first discussion of sparse matrices, limited to use on a single processor. We will now go into parallelism aspects.

The dense matrix-vector product, as you saw above, required each processor to communicate with every other, and to have a local buffer of essentially the size of the global vector. In the sparse case, considerably less buffer space, as well as less communication, is needed. Let us analyze this case. We will assume that the matrix is distributed by block rows, where processor  $p$  owns the matrix rows with indices in some set  $I_p$ .

The line  $y_i = y_i + a_{ij}x_j$  now has to take into account that  $a_{ij}$  can be zero. In particular, we need to consider that, for some pairs  $i \in I_p, j \notin I_p$  no communication will be needed. Declaring for each  $i \in I_p$  a sparsity pattern set

$$S_{p;i} = \{j : j \notin I_p, a_{ij} \neq 0\}$$

our multiplication instruction becomes

$$y_i += a_{ij}x_j \quad \text{if } j \in S_{p;i}.$$

If we want to avoid, as above, a flood of small messages, we combine all communication into a single message per processor. Defining

$$S_p = \cup_{i \in I_p} S_{p;i},$$

the algorithm now becomes:

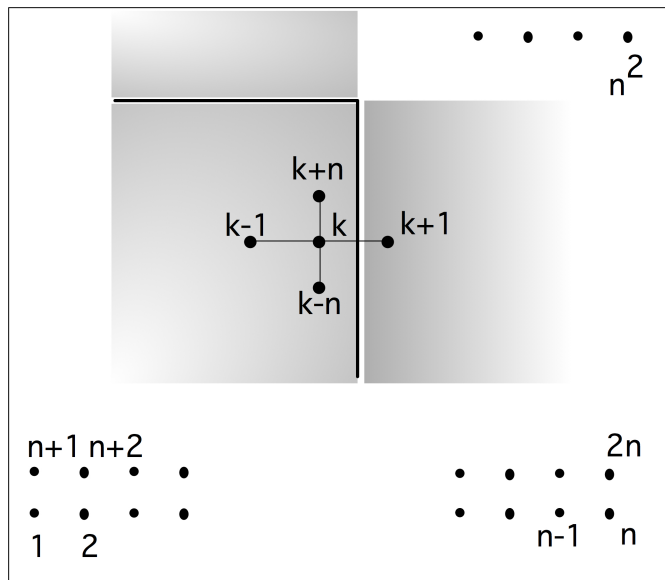

Figure 6.8: A difference stencil applied to a two-dimensional square domain, distributed over processors. A cross-processor connection is indicated.

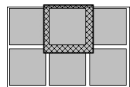

Figure 6.9: The ghost region of a processor, induced by a stencil

- Collect all necessary off-processor elements  $x_j$  with  $j \in S_p$  into one buffer;
- Perform the matrix-vector product, reading all elements of  $x$  from local storage.

This whole analysis of course also applies to dense matrices. This becomes different if we consider where sparse matrices come from. Let us start with a simple case.

Recall figure 4.1, which illustrated a discretized boundary value problem on the simplest domain, a square, and let us now parallelize it. We do this by partitioning the domain; each processor gets the matrix rows corresponding to its subdomain. Figure 6.8 shows how this gives rise to connections between processors: the elements  $a_{ij}$  with  $i \in I_p, j \notin I_p$  are now the ‘legs’ of the stencil that reach beyond a processor boundary. The set of all such  $j$ , formally defined as

$$G = \{j \notin I_p : \exists i \in I_p : a_{ij} \neq 0\}$$

is known as the *ghost region* of a processor; see figure 6.9.

**Exercise 6.12.** Show that a one-dimensional partitioning of the domain leads to a partitioning of the matrix into block rows, but a two-dimensional partitioning of the domain does not. You can do this in the abstract, or you can illustrate it: take a  $4 \times 4$  domain (giving a matrix of size 16), and partition it over 4 processors. The one-dimensional domain partitioning corresponds to giving each processor one line out of the domain, while

the two-dimensional partitioning gives each processor a  $2 \times 2$  subdomain. Draw the matrices for these two cases.

Our crucial observation is now that, for each processor, the number of other processors it is involved with is strictly limited. This has implications for the efficiency of the operation.

### 6.5.3 Parallel efficiency of the sparse matrix-vector product

In the case of the dense matrix-vector product (section 6.2.2), partitioning the matrix over the processors by (block) rows did not lead to a scalable algorithm. Part of the reason was the increase in the number of neighbours that each processors needs to communicate with. Figure 6.8 shows that, for the matrix of a 5-five point stencil, this number is limited to four.

**Exercise 6.13.** Take a square domain and a partitioning of the variables of the processors as in figure 6.8. What is the maximum number of neighbours a processor needs to communication with for the box stencil in figure 4.3? In three space dimensions, what is the number of neighbours if a 7-point central difference stencil is used?

The observation that each processor communicates with just a few neighbours stays intact if we go beyond square domains to more complicated physical objects. If a processor receives a more or less contiguous subdomain, the number of its neighbours will be limited. This implies that even in complicated problems each processor will only communicate with a small number of other processors. Compare this to the dense case where each processor had to receive data from every other processor. It is obvious that the sparse case is far more friendly to the interconnection network. (The fact that it also more common for large systems may influence the choice of network to install if you are about to buy a new parallel computer.)

For square domains, this argument can easily be made formal. Let the unit domain  $[0, 1]^2$  be partitioned over  $P$  processors in a  $\sqrt{P} \times \sqrt{P}$  grid. From figure 6.8 we see that every processor communicates with at most four neighbours. Let the amount of work per processor be  $w$  and the communication time with each neighbour  $c$ . Then the time to perform the total work on a single processor is  $T_1 = Pw$ , and the parallel time is  $T_P = w + 4c$ , giving a speed up of

$$S_P = Pw/(w + 4c) = P/(1 + 4c/w) \approx P(1 - 4c/w).$$

**Exercise 6.14.** Express  $c$  and  $w$  as functions of  $N$  and  $P$ , and show that the speedup is asymptotically optimal, under weak scaling of the problem.

**Exercise 6.15.** In this exercise you will analyze the parallel sparse matrix-vector product for a hypothetical, but realistic, parallel machine. Let the machine parameters be characterized by (see section 1.3.2):

- *Latency:*  $\alpha = 1\mu s = 10^{-6}s$ .
- *Bandwidth:*  $1Gb/s$  corresponds to  $\beta = 10^{-9}$ .
- *Computation rate:* A per-core flops rate of  $1Gflops$  means  $\gamma = 10^9$ . This number may seem low, but note that the matrix-vector product has less reuse than the matrix-matrix product, which can achieve close to peak performance, and that the sparse matrix-vector product is even more bandwidth-bound.



We assume  $10^4$  processors, and a five-point stencil matrix of size  $N = 25 \cdot 10^{10}$ . This means each processor stores  $5 \cdot 8 \cdot N/p = 10^9$  bytes. If the matrix comes from a problem on a square domain, this means the domain was size  $n \times n$  where  $n = \sqrt{N} = 5 \cdot 10^5$ .

Case 1. Rather than dividing the matrix, we divide the domain, and we do this first by horizontal slabs of size  $n \times (n/p)$ . Argue that the communication complexity is  $2(\alpha + n\beta)$  and computation complexity is  $10 \cdot n \cdot (n/p)$ . Show that the resulting computation outweighs the communication by a factor 250.

Case 2. We divide the domain into patches of size  $(n/\sqrt{p}) \times (n/\sqrt{p})$ . The memory and computation time are the same as before. Derive the communication time and show that it is better by a factor of 50.

Argue that the first case does not weakly scale: under the assumption that  $N/p$  is constant the efficiency will go down. (Show that speedup still goes up asymptotically as  $\sqrt{p}$ .) Argue that the second case does scale weakly.

The argument that a processor will only connect with a few neighbours is based on the nature of the scientific computations. It is true for FDM and FEM methods. In the case of the *Boundary Element Method (BEM)*, any subdomain needs to communicate with everything in a radius  $r$  around it. As the number of processors goes up, the number of neighbours per processor will also go up.

**Exercise 6.16.** Give a formal analysis of the speedup and efficiency of the BEM algorithm.

Assume again a unit amount of work  $w$  per processor and a time of communication  $c$  per neighbour. Since the notion of neighbour is now based on physical distance, not on graph properties, the number of neighbours will go up. Give  $T_1, T_p, S_p, E_p$  for this case.

There are also cases where a sparse matrix needs to be handled similarly to a dense matrix. For instance, *Google's PageRank* algorithm (see section 9.3) has at its heart the repeated operation  $x \leftarrow Ax$  where  $A$  is a sparse matrix with  $A_{ij} \neq 0$  if web page  $j$  links to page  $i$ ; see section 9.3. This makes  $A$  a very sparse matrix, with no obvious structure, so every processor will most likely communicate with almost every other.

### 6.5.4 Memory behaviour of the sparse matrix-vector product

In section 1.6.10 you saw an analysis of the sparse matrix-vector product in the dense case, on a single processor. Some of the analysis carries over immediately to the sparse case, such as the fact that each matrix element is used only once and that the performance is bound by the bandwidth between processor and memory.

Regarding reuse of the input and the output vector, if the matrix is stored by rows, such as in *CRS* format (section 5.4.1.3), access to the output vector will be limited to one write per matrix row. On the other hand, the loop unrolling trick for getting reuse of the input vector can not be applied here. Code that combines two iterations is as follows:

```
for (i=0; i<M; i+=2) {
    s1 = s2 = 0;
    for (j) {
        s1 = s1 + a[i][j] * x[j];
```

```

        s2 = s2 + a[i+1][j] * x[j];
    }
    y[i] = s1; y[i+1] = s2;
}

```

The problem here is that if  $a_{ij}$  is nonzero, it is not guaranteed that  $a_{i+1,j}$  is nonzero. The irregularity of the sparsity pattern makes optimizing the matrix-vector product hard. Modest improvements are possible by identifying parts of the matrix that are small dense blocks [20, 36, 160].

On a *GPU* the sparse matrix-vector product is also limited by memory bandwidth. Programming is now harder because the GPU has to work in data parallel mode, with many active threads.

An interesting optimization becomes possible if we consider the context in which the sparse matrix-vector product typically appears. The most common use of this operation is in iterative solution methods for linear systems (section 5.5), where it is applied with the same matrix in possibly hundreds of iterations. Thus we could consider leaving the matrix stored on the GPU and only copying the input and output vectors for each product operation.

### 6.5.5 The transpose product

In section 5.4.1.3 you saw that the code for both the regular and the transpose matrix-vector product are limited to loop orderings where rows of the matrix are traversed. (In section 1.5.2 you saw a discussion of computational effects of changes in loop order; in this case we are limited to row traversal by the storage format.)

In this section we will briefly look at the parallel transpose product. Equivalently to partitioning the matrix by rows and performing the transpose product, we look at a matrix stored and partitioned by columns and perform the regular product.

The algorithm for the product by columns can be given as:

```

y ← 0
for j:
  for i:
    yi ← yi + aijxj

```

Both in shared and distributed memory we distribute outer iterations over processors. The problem is then that each outer iteration updates the whole output vector. This is a problem: with shared memory it leads to multiple writes to locations in the output and in distributed memory it requires communication that is as yet unclear.

One way to solve this would be to allocate a private output vector  $y^{(p)}$  for each process:

```

y(p) ← 0
for j ∈ the rows of processor p
  for all i:
    yi(p) ← yi(p) + ajixj

```

after which we sum  $y \leftarrow \sum_p y^{(p)}$ .

### 6.5.6 Setup of the sparse matrix-vector product

While the dense matrix-vector product relies on collectives (see section 6.2), the sparse case uses point-to-point communication<sup>4</sup> Every processor sends to just a few neighbours, and receives from just a few.

However, there is an asymmetry between sending and receiving. It is fairly easy for a processor to find out what other processors it will be receiving from.

**Exercise 6.17.** Assume that the matrix is divided over the processors by block rows; see figure 6.2 for an illustration. Also assume that each processor knows which rows each other processor stores. (How would you implement that knowledge?) Sketch the algorithm by which a processor can find out who it will be receiving from; this algorithm should not involve any communication itself.

Discovering who to send to is harder.

**Exercise 6.18.** Argue that this is easy in the case of a *structurally symmetric matrix*:  $a_{ij} \neq 0 \Leftrightarrow a_{ji} \neq 0$ .

In the general case, a processor can in principle be asked to send to any other, so the simple algorithm is as follows:

- Each processor makes an inventory of what non-local indices it needs. Under the above assumption that it knows what range of indices each other processor owns, it then decides which indices to get from what neighbours.
- Each processor sends a list of indices to each of its neighbours; this list will be empty for most of the neighbours, but we can not omit sending it.
- Each processor then receives these lists from all others, and draws up lists of which indices to send.

You will note that, even though the communication during the matrix-vector product involves only a few neighbours for each processor, giving a cost that is  $O(1)$  in the number of processors, the setup involves all-to-all communications, which have time complexity  $O(\alpha P)$

If a processor has only a few neighbours, the above algorithm is wasteful. Ideally, you would want space and running time proportional to the number of neighbours. We could bring the receive time in the setup if we knew how many messages were to be expected. That number can be found:

- Each processor makes an array `need` of length  $P$ , where `need[i]` is 1 if the processor needs any data from processor  $i$ , and zero otherwise.
- A *reduce-scatter* collective on this array, with a sum operator, then leaves on each processor a number indicating how many processors need data from it.
- The processor can execute that many receive calls.

The reduce-scatter call has time complexity  $\alpha \log P + \beta P$ , which is of the same order as the previous algorithm, but probably with a lower proportionality constant.

The time and space needed for the setup can be reduced to  $O(\log P)$  with some sophisticated trickery [54, 89].

---

4. This makes sense for the type of sparse matrices that come from PDEs which have a clear structure, as you saw in section 4.2.3. However, there are sparse matrices that are so random that you essentially have to use dense techniques; see section 9.4.

## 6.6 Computational aspects of iterative methods

All iterative methods feature the following operations:

- A matrix-vector product; this was discussed for the sequential case in section 5.4 and for the parallel case in section 6.5. In the parallel case, construction of FEM matrices has a complication that we will discuss in section 6.6.2.
- The construction of the preconditioner matrix  $K \approx A$ , and the solution of systems  $Kx = y$ . This was discussed in the sequential case in section 5.5.5. Below we will go into parallelism aspects in section 6.7.
- Some vector operations (including inner products, in general). These will be discussed next.

### 6.6.1 Vector operations

There are two types of vector operations in a typical iterative method: vector additions and inner products.

**Exercise 6.19.** Consider the CG method of section 5.5.10, figure 5.8, applied to the matrix from a 2D BVP; equation (4.14). First consider the unpreconditioned case  $M = I$ . Show that there is a roughly equal number of floating point operations are performed in the matrix-vector product and in the vector operations. Express everything in the matrix size  $N$  and ignore lower order terms. How would this balance be if the matrix had 20 nonzeros per row?

Next, investigate this balance between vector and matrix operations for the FOM scheme in section 5.5.8. Since the number of vector operations depends on the iteration, consider the first 50 iterations and count how many floating point operations are done in the vector updates and inner product versus the matrix-vector product. How many nonzeros does the matrix need to have for these quantities to be equal?

**Exercise 6.20.** Flop counting is not the whole truth. What can you say about the efficiency of the vector and matrix operations in an iterative method, executed on a single processor?

#### 6.6.1.1 Vector additions

The vector additions are typically of the form  $x \leftarrow x + \alpha y$  or  $x \leftarrow \alpha x + y$ . If we assume that all vectors are distributed the same way, this operation is fully parallel.

#### 6.6.1.2 Inner products

Inner products are vector operations, but they are computationally more interesting than updates, since they involve communication.

When we compute an inner product, most likely every processor needs to receive the computed value. We

use the following algorithm:

```
for processor  $p$  do  
  compute  $a_p \leftarrow x_p^t y_p$  where  $x_p, y_p$  are the part of  $x, y$  stored on processor  $p$   
  do a global reduction to compute  $a = \sum_p a_p$   
  broadcast the result
```

**Algorithm 1:** Compute  $a \leftarrow x^t y$  where  $x, y$  are distributed vectors

The reduction and broadcast (which can be joined into an `Allreduce`) combine data over all processors, so they have a communication time that increases with the number of processors. This makes the inner product potentially an expensive operation, and people have suggested a number of ways to reducing their impact on the performance of iterative methods.

**Exercise 6.21.** Iterative methods are typically used for sparse matrices. In that context, you can argue that the communication involved in an inner product can have a larger influence on overall performance than the communication in the matrix-vector product. What is the complexity of the matrix-vector product and the inner product as a function of the number of processors?

Here are some of the approaches that have been taken.

- The CG method has two inner products per iteration that are inter-dependent. It is possible to rewrite the method so that it computes the same iterates (in exact arithmetic, at least) but so that the two inner products per iteration can be combined. See [27, 32, 124, 167].
- It may be possible to overlap the inner product calculation with other, parallel, calculations [34].
- In the GMRES method, use of the classical Gram-Schmidt (GS) method takes far fewer independent inner product than the modified GS method, but it is less stable. People have investigated strategies for deciding when it is allowed to use the classic GS method [109].

Since computer arithmetic is not associative, inner products are a prime source of results that differ when the same calculation is executed of two different processor configurations. In section 3.3.7 we sketched a solution.

## 6.6.2 Finite element matrix construction

The *FEM* leads to an interesting issue in parallel computing. For this we need to sketch the basic outline of how this method works. The FEM derives its name from the fact that the physical objects modeled are divided into small two or three dimensional shapes, the elements, such as triangles and squares in 2D, or pyramids and bricks in 3D. On each of these, the function we are modeling is then assumed to polynomial, often of a low degree, such as linear or bilinear.

The crucial fact is that a matrix element  $a_{ij}$  is then the sum of computations, specifically certain integrals, over all elements that contain both variables  $i$  and  $j$ :

$$a_{ij} = \sum_{e: i,j \in e} a_{ij}^{(e)}.$$

The computations in each element share many common parts, so it is natural to assign each element  $e$  uniquely to a processor  $P_e$ , which then computes all contributions  $a_{ij}^{(e)}$ . In figure 6.10 element 2 is assigned to processor 0 and element 4 to processor 1.

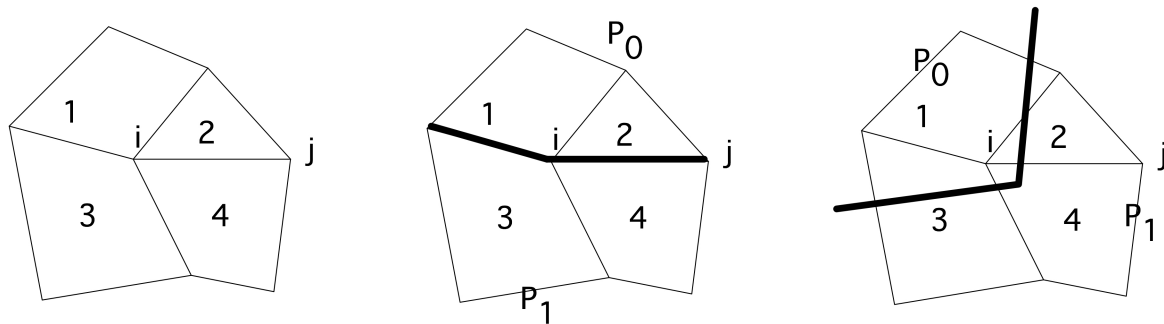

Figure 6.10: A finite element domain, parallelization of the matrix construction, and parallelization of matrix element storage

Now consider variables  $i$  and  $j$  and the matrix element  $a_{ij}$ . It is constructed as the sum of computations over domain elements 2 and 4, which have been assigned to different processors. Therefore, no matter what processor row  $i$  is assigned to, at least one processor will have to communicate its contribution to matrix element  $a_{ij}$ .

Clearly it is not possible to make assignments  $P_e$  of elements and  $P_i$  of variables such that  $P_e$  computes in full the coefficients  $a_{ij}$  for all  $i \in e$ . In other words, if we compute the contributions locally, there needs to be some amount of communication to assemble certain matrix elements. For this reason, modern linear algebra libraries such as PETSc (see tutorial section 24) allow any processor to set any matrix element.

### 6.6.3 A simple model for iterative method performance

Above, we have already remarked that iterative methods have very little opportunity for data reuse, and they are therefore characterized as *bandwidth-bound* algorithms. This allows us to make a simple prediction as to the *floating point performance of iterative methods*. Since the number of iterations of an iterative method is hard to predict, by performance here we mean the performance of a single iteration. Unlike with *direct methods for linear systems* (see for instance section 6.8.1), the number of flops to solution is very hard to establish in advance.

First we argue that we can restrict ourselves to the *performance of the sparse matrix vector product*: the time spent in this operation is considerably more than in the vector operations. Additionally, most preconditioners have a computational structure that is quite similar to the matrix-vector product.

Let us then consider the *performance of the CRS matrix-vector product*.

- First we observe that the arrays of matrix elements and column indices have no reuse, so the performance of loading them is completely determined by the available bandwidth. Caches and prefetch streams only hide the latency, but do not improve the bandwidth. For each multiplication of matrix element times input vector element we load one floating point number and one integer. Depending on whether the indices are 32-bit or 64-bit, this means 12 or 16 bytes loaded for each multiplication.

- The demands for storing the result vector are less important: an output vector element is written only once for each matrix row.
- The input vector can also be ignored in the bandwidth calculation. At first sight you might think that indirect indexing into the input vector is more or less random and therefore expensive. However, let's take the operator view of a matrix-vector product and consider the space domain of the PDE from which the matrix stems; see section 4.2.3. We now see that the seemingly random indexing is in fact into vector elements that are grouped closely together. This means that these vector elements will likely reside in L3 cache, and therefore accessible with a higher bandwidth (say, by a factor of at least 5) than data from main memory.

For the parallel performance of the sparse matrix-vector product we consider that in a PDE context each processor communicates only with a few neighbours. Furthermore, a surface-to-volume argument shows that the message volume is of a lower order than the on-node computation.

In sum, we conclude that a very simple model for the sparse matrix vector product, and thereby for the whole iterative solver, consists of measuring the effective bandwidth and computing the performance as one addition and one multiplication operation per 12 or 16 bytes loaded.

### 6.7 Parallel preconditioners

Above (section 5.5.5 and in particular 5.5.5.1) we saw a couple of different choices of  $K$ . In this section we will begin the discussion of parallelization strategies. The discussion is continued in detail in the next sections.

#### 6.7.1 Jacobi preconditioning

The Jacobi method (section 5.5.3) uses the diagonal of  $A$  as preconditioner. Applying this is as parallel as is possible: the statement  $y \leftarrow K^{-1}x$  scales every element of the input vector independently. Unfortunately the improvement in the number of iterations with a Jacobi preconditioner is rather limited. Therefore we need to consider more sophisticated methods such ILU. Unlike with the Jacobi preconditioner, parallelism is then not trivial.

#### 6.7.2 The trouble with parallel ILU

Above we saw that, in a flop counting sense, applying an ILU preconditioner (section 5.5.5.1) is about as expensive as doing a matrix-vector product. This is no longer true if we run our iterative methods on a parallel computer.

At first glance the operations are similar. A matrix-vector product  $y = Ax$  looks like

```
for i=1..n
  y[i] = sum over j=1..n a[i,j]*x[j]
```

In parallel this would look like

```

for i=myfirstrow..mylastrow
  y[i] = sum over j=1..n a[i,j]*x[j]

```

Suppose that a processor has local copies of all the elements of  $A$  and  $x$  that it will need, then this operation is fully parallel: each processor can immediately start working, and if the work load is roughly equal, they will all finish at the same time. The total time for the matrix-vector product is then divided by the number of processors, making the speedup more or less perfect.

Consider now the forward solve  $Lx = y$ , for instance in the context of an ILU preconditioner:

```

for i=1..n
  x[i] = (y[i] - sum over j=1..i-1 ell[i,j]*x[j]) / a[i,i]

```

We can simply write the parallel code:

```

for i=myfirstrow..mylastrow
  x[i] = (y[i] - sum over j=1..i-1 ell[i,j]*x[j]) / a[i,i]

```

but now there is a problem. We can no longer say ‘suppose a processor has local copies of everything in the right hand side’, since the vector  $x$  appears both in the left and right hand side. While the matrix-vector product is in principle fully parallel over the matrix rows, this triangular solve code is recursive, hence sequential.

In a parallel computing context this means that, for the second processor to start, it needs to wait for certain components of  $x$  that the first processor computes. Apparently, the second processor can not start until the first one is finished, the third processor has to wait for the second, and so on. The disappointing conclusion is that in parallel only one processor will be active at any time, and the total time is the same as for the sequential algorithm. This is actually not a big problem in the dense matrix case, since parallelism can be found in the operations for handling a single row (see section 6.12), but in the sparse case it means we can not use incomplete factorizations without some redesign.

In the next few subsections we will see different strategies for finding preconditioners that perform efficiently in parallel.

### 6.7.3 Block Jacobi methods

Various approaches have been suggested to remedy this sequentiality the triangular solve. For instance, we could simply let the processors ignore the components of  $x$  that should come from other processors:

```

for i=myfirstrow..mylastrow
  x[i] = (y[i] - sum over j=myfirstrow..i-1 ell[i,j]*x[j])
        / a[i,i]

```

This is not mathematically equivalent to the sequential algorithm (technically, it is called a *block Jacobi* method with ILU as the *local solve*), but since we’re only looking for an approximation  $K \approx A$ , this is simply a slightly cruder approximation.



**Exercise 6.22.** Take the Gauss-Seidel code you wrote above, and simulate a parallel run. What is the effect of increasing the (simulated) number of processors?

The idea behind block methods can easily be appreciated pictorially; see figure 6.11. In effect, we make an

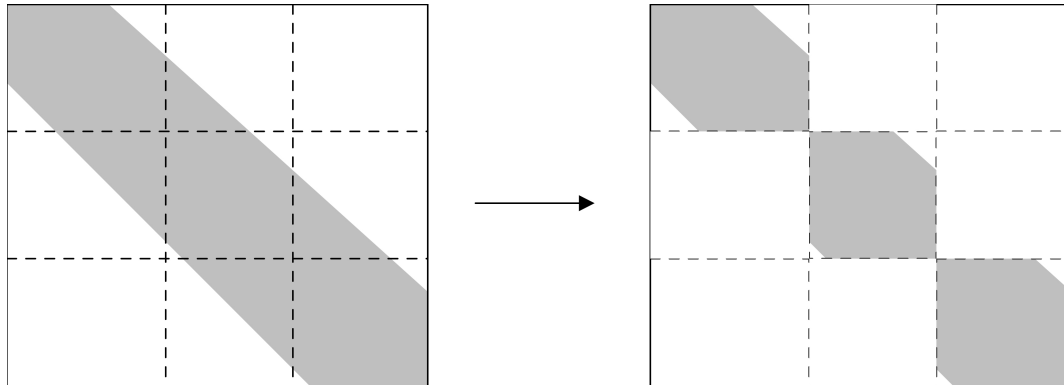

Figure 6.11: Sparsity pattern corresponding to a block Jacobi preconditioner

ILU of the matrix that we get by ignoring all connections between processors. Since in a BVP all points influence each other (see section 4.2.1), using a less connected preconditioner will increase the number of iterations if executed on a sequential computer. However, block methods are parallel and, as we observed above, a sequential preconditioner is very inefficient in a parallel context, so we put up with this increase in iterations.

#### 6.7.4 Parallel ILU

The Block Jacobi preconditioner operates by decoupling domain parts. While this may give a method that is highly parallel, it may give a higher number of iterations than a true ILU preconditioner. (A theoretical argument can be made that this decoupling decreases the efficiency of the iterative method; see section 4.2.1.) Fortunately it is possible to have a parallel ILU method.

In section 6.8.2 you saw the combination of *graph colouring* and permutation. Let  $P$  be the permutation that groups like-coloured variables together, then  $\tilde{A} = P^t A P$  is a matrix with the following structure:

- $\tilde{A}$  has a block structure with the number of blocks equal to the number of colours in the adjacency graph of  $A$ ; and
- each diagonal block is a diagonal matrix.

Now, if you are performing an iterative system solution and you are looking for a parallel preconditioner you can use this permuted matrix. Consider solving  $Ly = x$  with the permuted system. We write the usual algorithm (section 5.3.5) as

for  $c$  in the set of colours:  
 for  $i$  in the variables of colour  $c$ :  

$$y_i \leftarrow x_i - \sum_{j < i} \ell_{ij} y_j$$

**Exercise 6.23.** Show that the flop count of solving a system  $LUx = y$  remains the same (in the highest order term) when you from an ILU factorization in the natural ordering to one in the colour-permuted ordering.

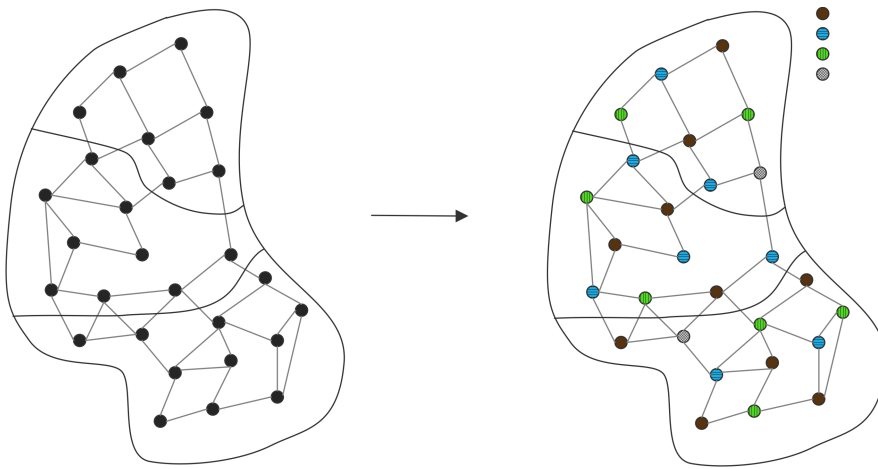

Figure 6.12: A partitioned domain with coloured nodes

Where does all this colouring get us? Solving is still sequential. . . Well, it is true that the outer loop over the colours is sequential, but all the points of one colour are independent of each other, so they can be solved at the same time. So if we use an ordinary domain partitioning and combine that with a multi-colouring (see figure 6.12), the processors are all active during all the colour stages; see figure 6.13. Ok, if you take a close look at that figure you'll see that one processor is not active in the last colour. With large numbers of nodes per processor this is unlikely to happen, but there may be some load imbalance.

## 6.8 Ordering strategies and parallelism

In the foregoing we have remarked on the fact that solving a linear system of equations is inherently a recursive activity. For dense systems, the number of operations is large enough compared to the recursion length that finding parallelism is fairly straightforward. Sparse systems, on the other hand, take more sophistication. In this section we will look at a number of strategies for reordering the equations (or, equivalently, permuting the matrix) that will increase the available parallelism.

These strategies can all be considered as variants of Gaussian elimination. By making incomplete variants of them (see section 5.5.5.1), all these strategies also apply to constructing preconditioners for iterative solution methods.

### 6.8.1 Nested dissection

Above, you have seen several examples of ordering the variables in the domain other than with the *lexicographic ordering*. In this section you will see the *nested dissection ordering*, which was initially designed as a way to reduce fill-in. However, it is also advantageous in a parallel computing context.

Nested dissection is a recursive process for determining a nontrivial ordering of the unknowns in a domain. In the first step, the computational domain is split in two parts, with a dividing strip between them; see figure 6.14. To be precise, the *separator* is wide enough that there are no connections between the left and

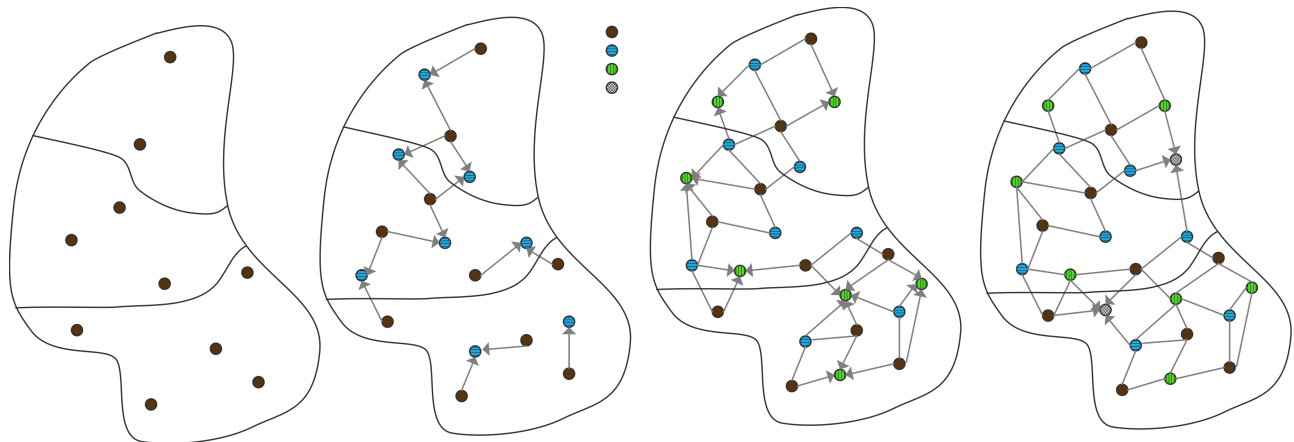

Figure 6.13: Solving a parallel multicolour ILU in four steps

right *subdomain*. The resulting matrix  $A^{\text{DD}}$  has a  $3 \times 3$  structure, corresponding to the three divisions of the domain. Since the subdomains  $\Omega_1$  and  $\Omega_2$  are not connected, the submatrices  $A_{12}^{\text{DD}}$  and  $A_{21}^{\text{DD}}$  are zero.

$$A^{\text{DD}} = \begin{pmatrix} A_{11} & \emptyset & A_{13} \\ \emptyset & A_{22} & A_{23} \\ A_{31} & A_{32} & A_{33} \end{pmatrix} = \left( \begin{array}{cccc|cccc|c} \star & \star & & & & & & & 0 \\ \star & \star & \star & & & & & & \vdots \\ & & \ddots & \ddots & \ddots & & & & \vdots \\ & & & \star & \star & \star & & & 0 \\ & & & & \star & \star & & & \star \\ \hline & & & & & \star & \star & & 0 \\ & & & & & \star & \star & \star & \vdots \\ & & & \emptyset & & \ddots & \ddots & \ddots & \vdots \\ & & & & & & \star & \star & \star & 0 \\ & & & & & & & \star & \star & \star \\ \hline 0 & \dots & \dots & 0 & \star & 0 & \dots & \dots & 0 & \star & \star \end{array} \right) \left. \begin{array}{l} \vphantom{\begin{pmatrix} \star \\ \vdots \\ 0 \\ \star \end{pmatrix}} \right\} (n^2 - n)/2 \\ \vphantom{\begin{pmatrix} \star \\ \vdots \\ 0 \\ \star \end{pmatrix}} \left. \begin{array}{l} \vphantom{\begin{pmatrix} \star \\ \vdots \\ 0 \\ \star \end{pmatrix}} \right\} (n^2 - n)/2 \\ \vphantom{\begin{pmatrix} \star \\ \vdots \\ 0 \\ \star \end{pmatrix}} \left. \begin{array}{l} \vphantom{\begin{pmatrix} \star \\ \vdots \\ 0 \\ \star \end{pmatrix}} \right\} n \end{array} \right\}$$

This process of dividing the domain by a separator is also called *domain decomposition* or *substructuring*, although this name is also associated with the mathematical analysis of the resulting matrices [10]. In this example of a rectangular domain it is of course trivial to find a separator. However, for the type of equations we get from BVPs it is usually feasible to find a separator efficiently for any domain [115]; see also section 16.5.1.

Let us now consider the  $LU$  factorization of this matrix. If we factor it in terms of the  $3 \times 3$  block structure, we get

$$A^{\text{DD}} = LU = \begin{pmatrix} I & & \\ \emptyset & I & \\ A_{31}A_{11}^{-1} & A_{32}A_{22}^{-1} & I \end{pmatrix} \begin{pmatrix} A_{11} & \emptyset & A_{13} \\ A_{22} & A_{23} \\ S_{33} \end{pmatrix}$$

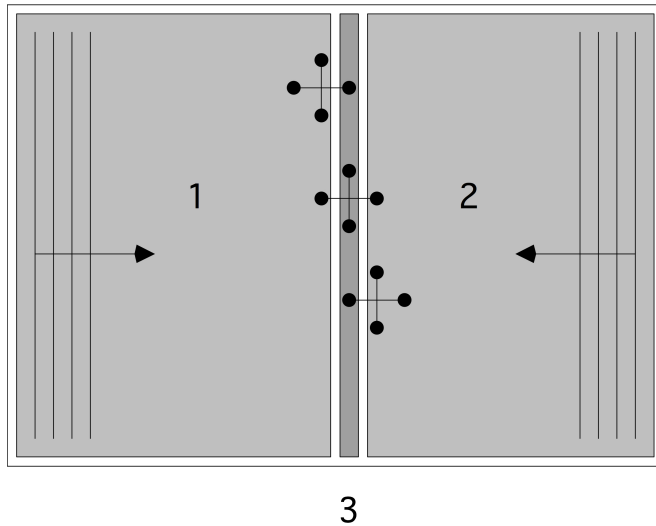

Figure 6.14: Domain dissection into two unconnected subdomains and a separator

where

$$S_{33} = A_{33} - A_{31}A_{11}^{-1}A_{13} - A_{32}A_{22}^{-1}A_{23}.$$

The important fact here is that

- the contributions  $A_{31}A_{11}^{-1}A_{13}$  and  $A_{32}A_{22}^{-1}A_{23}$  can be computed simultaneously, so the factorization is largely parallel; and
- both in the forward and backward solve, components 1 and 2 of the solution can be computed simultaneously, so the solution process is also largely parallel.

The third block can not trivially be handled in parallel, so this introduces a sequential component in the algorithm. We also need to take a closer look at the structure of  $S_{33}$ .

**Exercise 6.24.** In section 5.4.3.1 you saw the connection between LU factorization and graph theory: eliminating a node leads to a graph with that node removed, but with certain new connections added. Show that, after eliminating the first two sets of variables, the graph of the remaining matrix on the separator will be fully connected.

The upshot is that after eliminating all the variables in blocks 1 and 2 we are left with a matrix  $S_{33}$  that is fully dense of size  $n \times n$ .

The introduction of a separator gave us a factorization that was two-way parallel. Now we iterate this process: we put a separator inside blocks 1 and 2 (see figure 6.15), which gives the following matrix structure:

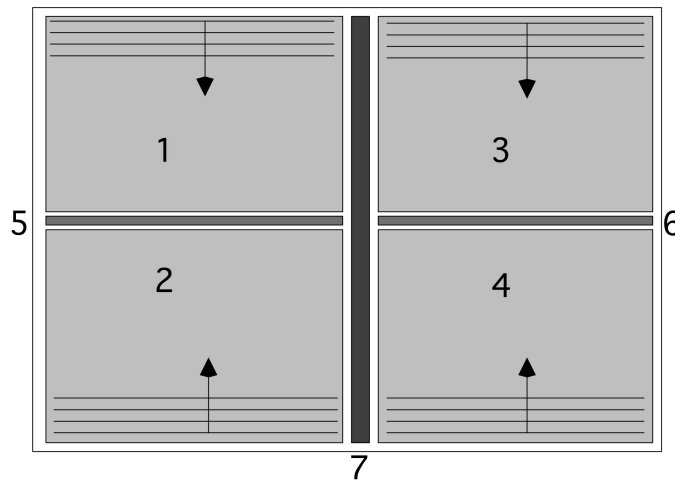

Figure 6.15: A four-way domain decomposition

$$A^{DD} = \begin{pmatrix} A_{11} & & & & A_{15} & & A_{17} \\ & A_{22} & & & A_{25} & & A_{27} \\ & & A_{33} & & & A_{36} & A_{37} \\ & & & A_{44} & & A_{46} & A_{47} \\ \hline A_{51} & A_{52} & & & A_{55} & & A_{57} \\ & & A_{63} & A_{64} & & A_{66} & A_{67} \\ \hline A_{71} & A_{72} & A_{73} & A_{74} & A_{75} & A_{76} & A_{77} \end{pmatrix}$$

(Note the similarities with the ‘arrow’ matrix in section 5.4.3.4, and recall the argument that this led to lower fill-in.) The LU factorization of this is:

$$\begin{pmatrix} I & & & & & & \\ & I & & & & & \\ & & I & & & & \\ & & & I & & & \\ \hline A_{51}A_{11}^{-1} & A_{52}A_{22}^{-1} & & & I & & \\ & & A_{63}A_{33}^{-1} & A_{64}A_{44}^{-1} & & I & \\ \hline A_{71}A_{11}^{-1} & A_{72}A_{22}^{-1} & A_{73}A_{33}^{-1} & A_{74}A_{44}^{-1} & A_{75}S_5^{-1} & A_{76}S_6^{-1} & I \end{pmatrix}.$$

$$\begin{pmatrix} A_{11} & & & & A_{15} & & A_{17} \\ & A_{22} & & & A_{25} & & A_{27} \\ & & A_{33} & & & A_{36} & A_{37} \\ & & & A_{44} & & A_{46} & A_{47} \\ \hline & & & & S_5 & & A_{57} \\ & & & & & S_6 & A_{67} \\ \hline & & & & & & S_7 \end{pmatrix}$$

where

$$S_5 = A_{55} - A_{51}A_{11}^{-1}A_{15} - A_{52}A_{22}^{-1}A_{25}, \quad S_6 = A_{66} - A_{63}A_{33}^{-1}A_{36} - A_{64}A_{44}^{-1}A_{46}$$

$$S_7 = A_{77} - \sum_{i=1,2,3,4} A_{7i}A_{ii}^{-1}A_{i7} - \sum_{i=5,6} A_{7i}S_i^{-1}A_{i7}.$$

Constructing the factorization now goes as follows:

- Blocks  $A_{ii}$  are factored in parallel for  $i = 1, 2, 3, 4$ ; similarly the contributions  $A_{5i}A_{ii}^{-1}A_{i5}$  for  $i = 1, 2$ ,  $A_{6i}A_{ii}^{-1}A_{i6}$  for  $i = 3, 4$ , and  $A_{7i}A_{ii}^{-1}A_{i7}$  for  $i = 1, 2, 3, 4$  can be constructed in parallel.
- The Schur complement matrices  $S_5, S_6$  are formed and subsequently factored in parallel, and the contributions  $A_{7i}S_i^{-1}A_{i7}$  for  $i = 5, 6$  are constructed in parallel.
- The Schur complement  $S_7$  is formed and factored.

Analogous to the above reasoning, we conclude that after eliminating blocks 1,2,3,4 the updated matrices  $S_5, S_6$  are dense of size  $n/2$ , and after eliminating blocks 5,6 the Schur complement  $S_7$  is dense of size  $n$ .

**Exercise 6.25.** Show that solving a system with  $A^{\text{DD}}$  has a similar parallelism to constructing the factorization as described above.

For future reference, we will call the sets 1 and 2 each others' siblings, and similarly for 3 and 4. The set 5 is the parent of 1 and 2, 6 is the parent of 3 and 4; 5 and 6 are siblings and 7 is the parent of 5 and 6.

### 6.8.1.1 Domain decomposition

In figure 6.15 we divided the domain four ways by a recursive process. This leads up to our discussion of nested dissection. It is also possible to immediately split a domain in any number of strips, or in a grid of subdomains. As long as the separators are wide enough, this will give a matrix structure with many independent subdomains. As in the above discussion, an LU factorization will be characterized by

- parallel processing of the subdomains, both in the factorization and  $L, U$  solves, and
- a system to be solved on the separator structure.

**Exercise 6.26.** The matrix from a two-dimensional BVP has a block tridiagonal structure. Divide the domain in four strips, that is, using three separators (see figure 6.16). Note that the separators are uncoupled in the original matrix.

Now sketch the sparsity structure of the resulting system on the separators are elimination of the subdomains. Show that the system is block tridiagonal.

### 6.8.1.2 Complexity

The nested dissection method repeats the above process until the subdomains are very small. For a theoretical analysis, we keep dividing until we have subdomains of size  $1 \times 1$ , but in practice one could stop at sizes such as 32, and use an efficient dense solver to factor and invert the blocks.

To derive the complexity of the algorithm, we take another look at figure 6.15, and see that complexity argument, the total space a full recursive nested dissection factorization needs is the sum of

- one dense matrix on a separator of size  $n$ , plus
- two dense matrices on separators of size  $n/2$ ,

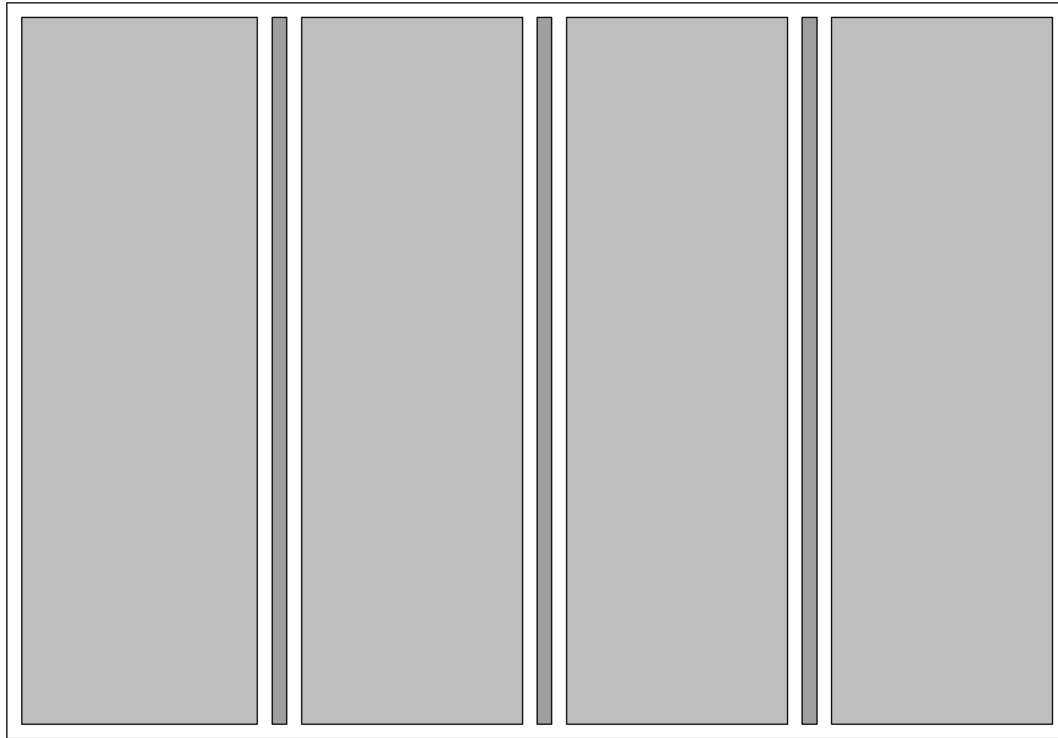

Figure 6.16: One-way domain decomposition

- taking together  $3/2 n^2$  space and  $5/12 n^3$  time;
- the two terms above then get repeated on four subdomains of size  $(n/2) \times (n/2)$ .

With the observation that  $n = \sqrt{N}$ , this sums to

$$\begin{aligned} \text{space} &= 3/2 n^2 + 4 \cdot 3/2 (n/2)^2 + \dots \\ &= N(3/2 + 3/2 + \dots) \quad \log n \text{ terms} \\ &= O(N \log N) \end{aligned}$$

$$\begin{aligned} \text{time} &= 5/12 n^3/3 + 4 \cdot 5/12 (n/2)^3/3 + \dots \\ &= 5/12 N^{3/2} (1 + 1/4 + 1/16 + \dots) \\ &= O(N^{3/2}) \end{aligned}$$

Apparently, we now have a factorization that is parallel to a large extent, and that is done in  $O(N \log N)$  space, rather than  $O(N^{3/2})$  (see section 5.4.3.3). The factorization time has also gone down from  $O(N^2)$  to  $O(N^{3/2})$ .

Unfortunately, this space savings only happens in two dimensions: in three dimensions we need

- one separator of size  $n \times n$ , taking  $(n \times n)^2 = N^{4/3}$  space and  $1/3 \cdot (n \times n)^3 = 1/3 \cdot N^2$  time,
- two separators of size  $n \times n/2$ , taking  $N^{3/2}/2$  space and  $1/3 \cdot N^2/4$  time,
- four separators of size  $n/2 \times n/2$ , taking  $N^{3/2}/4$  space and  $1/3 \cdot N^2/16$  time,
- adding up to  $7/4 N^{3/2}$  space and  $21/16 N^2/3$  time;

- on the next level there are 8 subdomains that contribute these terms with  $n \rightarrow n/2$  and therefore  $N \rightarrow N/8$ .

This makes the total space

$$\frac{7}{4}N^{3/2}(1 + (1/8)^{4/3} + \dots) = O(N^{3/2})$$

and the total time

$$\frac{21}{16}N^2(1 + 1/16 + \dots)/3 = O(N^2).$$

We no longer have the tremendous savings of the 2D case. A much more complicated analysis shows that the order improvement holds for general problems in 2D, and that 3D in general has a higher complexity [114].

### 6.8.1.3 Parallelism

The nested dissection method clearly introduces a lot of parallelism, and we can characterize it as task parallelism (section 2.6.3): associated with each separator is a task of factoring its matrix, and later one of solving a linear system on its variables. However, the tasks are not independent: in figure 6.15 the factorization on domain 7 has to wait for 5 and 6, and they have to wait for 1,2,3,4. Thus, we have tasks with dependencies in the form of a tree: each separator matrix can be factored only when its children have been factored.

Mapping these tasks to processors is not trivial. First of all, if we are dealing with shared memory we can use a simple task queue:

```

Queue ← {}
for all bottom level subdomains d do
  add d to the Queue
while Queue is not empty do
  if a processor is idle then
    assign a queued task to it
  if a task is finished AND its sibling is finished then
    add its parent to the queue

```

The main problem here is that at some point we will have more processors than tasks, thus causing load unbalance. This problem is made more severe by the fact that the last tasks are also the most substantial, since the separators double in size from level to level. (Recall that the work of factoring a dense matrix goes up with the third power of the size!) Thus, for the larger separators we have to switch from task parallelism to medium-grained parallelism, where processors collaborate on factoring a block.

With distributed memory, we can now solve the parallelism problem with a simple task queue, since it would involve moving large amounts of data. (But recall that work is a higher power of the matrix size, which this time works in our favour, making communication relatively cheap.) The solution is then to use some form of domain decomposition. In figure 6.15 we could have four processors, associated with block 1,2,3,4. Processors 1 and 2 would then negotiate which one factors block 5 (and similarly processors 3 and 4 and block 6), or they could both do it redundantly.





Figure 6.17: Red-black ordering of a the points on a line

#### 6.8.1.4 Preconditioning

As with all factorizations, it is possible to turn the nested dissection method into a preconditioner by making the factorization incomplete. (For the basic idea of incomplete factorizations, see section 5.5.5.1). However, here the factorization is formulated completely in terms of *block matrices*, and the division by the pivot element becomes an inversion or system solution with the pivot block matrix. We will not go into this further; for details see the literature [4, 50, 125].

### 6.8.2 Variable reordering and colouring: independent sets

Another permutation of the problem variables is based on graph colouring (section 16.3). The direct goal here is to maximize available parallelism.

Let us take a simple example, where  $A$  is a tridiagonal matrix. The equation  $Ax = b$  looks like

$$\begin{pmatrix} a_{11} & a_{12} & & & \emptyset \\ a_{21} & a_{22} & a_{23} & & \\ & a_{32} & a_{33} & a_{34} & \\ \emptyset & & \ddots & \ddots & \ddots \end{pmatrix} \begin{pmatrix} x_1 \\ x_2 \\ x_3 \\ \vdots \end{pmatrix} = \begin{pmatrix} y_1 \\ y_2 \\ y_3 \\ \vdots \end{pmatrix}$$

We observe that  $x_i$  directly depends on  $x_{i-1}$  and  $x_{i+1}$ , but not  $x_{i-2}$  or  $x_{i+1}$ . Thus, let us see what happens if we permute the indices to group every other component together.

Pictorially, we take the points  $1, \dots, n$  and colour them red and black (figure 6.17), then we permute them to first take all red points, and subsequently all black ones. The correspondingly permuted matrix looks as follows:

$$\begin{pmatrix} a_{11} & & & & a_{12} & & & & \\ & a_{33} & & & a_{32} & a_{34} & & & \\ & & a_{55} & & & \ddots & \ddots & & \\ & & & \ddots & & & & & \\ a_{21} & a_{23} & & & a_{22} & & & & \\ & a_{43} & a_{45} & & a_{44} & & & & \\ & & \ddots & \ddots & & & & & \ddots \end{pmatrix} \begin{pmatrix} x_1 \\ x_3 \\ x_5 \\ \vdots \\ x_2 \\ x_4 \\ \vdots \end{pmatrix} = \begin{pmatrix} y_1 \\ y_3 \\ y_5 \\ \vdots \\ y_2 \\ y_4 \\ \vdots \end{pmatrix}$$



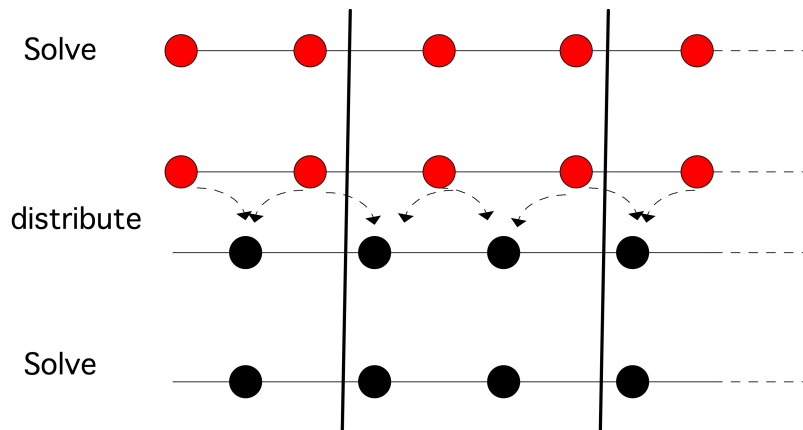

Figure 6.19: Parallel red-black solution on a 1d domain

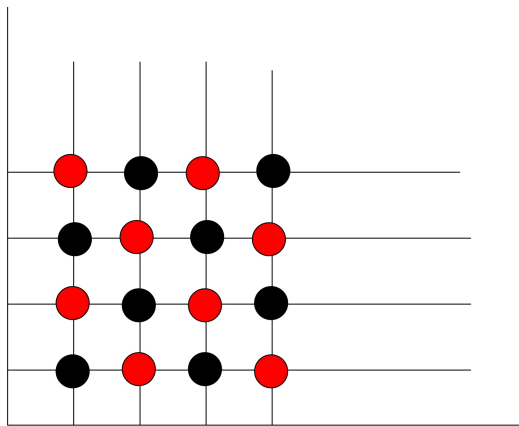

Figure 6.20: Red-black ordering of the variables of a two-dimensional domain

**Exercise 6.27.** Apply the red-black ordering to the 2D BVP (4.10). Sketch the resulting matrix structure.

The red-black ordering is a simple example of *graph colouring* (sometimes called *multi-colouring*). In simple cases, such as the unit square domain we considered in section 4.2.3 or its extension to 3D, the *colour number* of the adjacency graph is easily determined.

**Exercise 6.28.** You saw that a red-black ordering of unknowns coupled with the regular five-point star stencil give two subsets of variables that are not connected among themselves, that is, they form a two-colouring of the matrix graph. Can you find a colouring if nodes are connected by the second stencil in figure 4.3?

There is a simple bound for the number of colours needed for the graph of a sparse matrix: the number of colours is at most  $d + 1$  where  $d$  is the degree of the graph. To see that we can colour a graph with degree  $d$  using  $d + 1$  colours, consider a node with degree  $d$ . No matter how its neighbours are coloured, there is always an unused colour among the  $d + 1$  available ones.

**Exercise 6.29.** Consider a sparse matrix, where the graph can be coloured with  $d$  colours. Permute the matrix by first enumerating the unknowns of the first colour, then the second colour, et cetera. What can you say about the sparsity pattern of the resulting permuted matrix?

If you are looking for a direct solution of the linear system you can repeat the process of colouring and permuting on the matrix that remains after you have eliminated one colour. In the case of a tridiagonal matrix you saw that this remaining matrix was again tridiagonal, so it is clear how to continue the process. This is called *recursive doubling*. If the matrix is not tridiagonal but *block tridiagonal*, this operation can be performed on blocks.

## 6.9 Operator splitting

In some contexts, it is necessary to perform implicit calculations through all directions of a two or three-dimensional array. For example, in section 4.3 you saw how the implicit solution of the heat equation gave rise to repeated systems

$$\left(\alpha I + \frac{d^2}{dx^2} + \frac{d^2}{dy^2}\right)u^{(t+1)} = u^{(t)} \quad (6.2)$$

Without proof, we state that the time-dependent problem can also be solved by

$$\left(\beta I + \frac{d^2}{dx^2}\right)\left(\beta I + \frac{d^2}{dy^2}\right)u^{(t+1)} = u^{(t)} \quad (6.3)$$

for suitable  $\beta$ . This scheme will not compute the same values on each individual time step, but it will converge to the same steady state. The scheme can also be used as a preconditioner in the BVP case.

This approach has considerable advantages, mostly in terms of operation counts: the original system has to be solved either making a factorization of the matrix, which incurs *fill-in*, or by solving it iteratively.

**Exercise 6.30.** Analyze the relative merits of these approaches, giving rough operation counts.

Consider both the case where  $\alpha$  has dependence on  $t$  and where it does not. Also discuss the expected speed of various operations.

A further advantage appears when we consider the parallel solution of (6.3). Note that we have a two-dimensional set of variables  $u_{ij}$ , but the operator  $I + d^2u/dx^2$  only connects  $u_{ij}, u_{ij-1}, u_{ij+1}$ . That is, each line corresponding to an  $i$  value can be processed independently. Thus, both operators can be solved fully parallel using a one-dimensional partition on the domain. The solution of the system in (6.2), on the other hand, has limited parallelism.

Unfortunately, there is a serious complication: the operator in  $x$  direction needs a partitioning of the domain in one direction, and the operator in  $y$  in the other. The solution usually taken is to transpose the  $u_{ij}$  value matrix in between the two solves, so that the same processor decomposition can handle both. This transposition can take a substantial amount of the processing time of each time step.

**Exercise 6.31.** Discuss the merits of and problems with a two-dimensional decomposition of the domain, using a grid of  $P = p \times p$  processors. Can you suggest a way to ameliorate the problems?

One way to speed up these calculations, is to replace the implicit solve, by an explicit operation; see section 6.10.3.

## 6.10 Parallelism and implicit operations

In the discussion of IBVPs (section 4.1.2.2) you saw that implicit operations can have great advantages from the point of numerical stability. However, you also saw that they make the difference between methods based on a simple operation such as the matrix-vector product, and ones based on the more complicated linear system solution. There are further problems with implicit methods when you start computing in parallel.

**Exercise 6.32.** Let  $A$  be the matrix

$$A = \begin{pmatrix} a_{11} & & \emptyset & & \\ a_{21} & a_{22} & & & \\ & \ddots & \ddots & & \\ \emptyset & & & a_{n,n-1} & a_{nn} \end{pmatrix}. \quad (6.4)$$

Show that the matrix vector product  $y \leftarrow Ax$  and the system solution  $x \leftarrow A^{-1}y$ , obtained by solving the triangular system  $Ax = y$ , not by inverting  $A$ , have the same operation count.

Now consider parallelizing the product  $y \leftarrow Ax$ . Suppose we have  $n$  processors, and each processor  $i$  stores  $x_i$  and the  $i$ -th row of  $A$ . Show that the product  $Ax$  can be computed without idle time on any processor but the first.

Can the same be done for the solution of the triangular system  $Ax = y$ ? Show that the straightforward implementation has every processor idle for an  $(n-1)/n$  fraction of the computation.

We will now see a number of ways of dealing with this inherently sequential component.

### 6.10.1 Wavefronts

Above, you saw that solving a lower triangular system of size  $N$  can have sequential time complexity of  $N$  steps. In practice, things are often not quite that bad. Implicit algorithms such as solving a triangular system are inherently sequential, but the number of steps can be less than is apparent at first.

**Exercise 6.33.** Take another look at the matrix from a two-dimensional BVP on the unit square, discretized with central differences. Derive the matrix structure if we order the unknowns by diagonals. What can you say about the sizes of the blocks and the structure of the blocks themselves?

Let us take another look at figure 4.1 that describes the difference stencil of a two-dimensional BVP. The corresponding picture for the lower triangular factor is in figure 6.21. This describes the sequentiality of the lower triangular solve process  $x \leftarrow L^{-1}y$ :

$$x_k = y_k - \ell_{k,k-1}x_{k-1} - \ell_{k,k-n}x_{k-n}$$

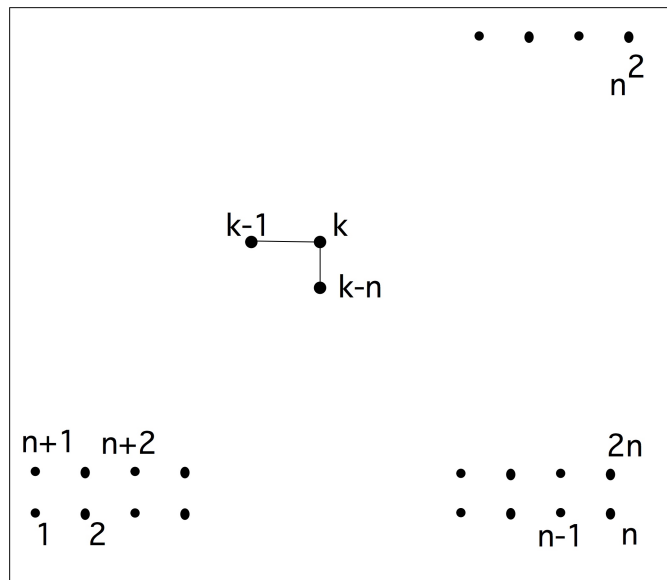

Figure 6.21: The difference stencil of the  $L$  factor of the matrix of a two-dimensional BVP

In other words, the value at point  $k$  can be found if its neighbours to the left (that is, variable  $k - 1$ ) and below (variable  $k - n$ ) are known.

Turning this around, we see that, if we know  $x_1$ , we can not only find  $x_2$ , but also  $x_{n+1}$ . In the next step we can determine  $x_3$ ,  $x_{n+2}$ , and  $x_{2n+1}$ . Continuing this way, we can solve  $x$  by *wavefronts*: the values of  $x$  on each wavefront are independent, so they can be solved in parallel in the same sequential step.

**Exercise 6.34.** Finish this argument. What is the maximum number of processors we can employ, and what is the number of sequential steps? What is the resulting efficiency?

Of course you don't have to use actual parallel processing to exploit this parallelism. Instead you could use a *vector processor*, *vector instructions*, or a *GPU* [117].

In section 5.4.3.5 you saw the *Cuthill-McKee ordering* for reducing the fill-in of a matrix. We can modify this algorithm as follows to give wavefronts:

1. Take an arbitrary node, and call that 'level zero'.
2. For level  $n + 1$ , find points connected to level  $n$ , that are not themselves connected.
3. For the so-called 'reverse Cuthill-McKee ordering', reverse the numbering of the levels.

**Exercise 6.35.** This algorithm is not entirely correct. What is the problem; how can you correct it? Show that the resulting permuted matrix is no longer tridiagonal, but will likely still have a band structure.

### 6.10.2 Recursive doubling

One strategy for dealing with recurrences is *recursive doubling*, which you already saw in exercise 1.4. Here we will discuss it in a more systematic manner. First, take the matrix from (6.4) and scale it to be of

the form

$$\begin{pmatrix} 1 & & & \emptyset \\ b_{21} & 1 & & \\ & \ddots & \ddots & \\ \emptyset & & b_{n,n-1} & 1 \end{pmatrix}$$

which we write as  $A = I + B$ .

**Exercise 6.36.** How does solving the system  $(I + B)x = y$  help in solving  $Ax = y$ ? What are the operation counts of solving the system in the two different ways?

Now we do something that looks like Gaussian elimination, except that we do not start with the first row, but the second. (What would happen if you did Gaussian elimination or LU decomposition on the matrix  $I + B$ ?) We use the second row to eliminate  $b_{32}$ :

$$\begin{pmatrix} 1 & & & \emptyset \\ & 1 & & \\ -b_{32} & 1 & & \\ & & \ddots & \\ \emptyset & & & 1 \end{pmatrix} \times \begin{pmatrix} 1 & & & \emptyset \\ b_{21} & 1 & & \\ & b_{32} & 1 & \\ & & \ddots & \ddots \\ \emptyset & & & b_{n,n-1} & 1 \end{pmatrix} = \begin{pmatrix} 1 & & & \emptyset \\ b_{21} & 1 & & \\ -b_{32}b_{21} & 0 & 1 & \\ \emptyset & & b_{n,n-1} & 1 \end{pmatrix}$$

which we write as  $L^{(2)}A = A^{(2)}$ . We also compute  $L^{(2)}y = y^{(2)}$  so that  $A^{(2)}x = y^{(2)}$  has the same solution as  $Ax = y$ . Solving the transformed system gains us a little: after we compute  $x_1, x_2$  and  $x_3$  can be computed in parallel.

Now we repeat this elimination process by using the fourth row to eliminate  $b_{54}$ , the sixth row to eliminate  $b_{76}$ , et cetera. The final result is, summarizing all  $L^{(i)}$  matrices:

$$\begin{pmatrix} 1 & & & & & & \emptyset \\ 0 & 1 & & & & & \\ & -b_{32} & 1 & & & & \\ & & 0 & 1 & & & \\ & & & -b_{54} & 1 & & \\ & & & & 0 & 1 & \\ & & & & & -b_{76} & 1 \\ & & & & & & \ddots & \ddots \end{pmatrix} \times (I+B) = \begin{pmatrix} 1 & & & & & & \emptyset \\ b_{21} & 1 & & & & & \\ -b_{32}b_{21} & 0 & 1 & & & & \\ & & b_{43} & 1 & & & \\ & & -b_{54}b_{43} & 0 & 1 & & \\ & & & & b_{65} & 1 & \\ & & & & -b_{76}b_{65} & 0 & 1 \\ & & & & & & \ddots & \ddots & \ddots \end{pmatrix}$$

which we write as  $L(I + B) = C$ , and solving  $(I + B)x = y$  now becomes  $Cx = L^{-1}y$ .

This final result needs close investigation.

- First of all, computing  $y' = L^{-1}y$  is simple. (Work out the details. How much parallelism is available?)
- Solving  $Cx = y'$  is still sequential, but it no longer takes  $n$  steps: from  $x_1$  we can get  $x_3$ , from that we get  $x_5$ , et cetera. In other words, there is only a sequential relationship between the odd numbered components of  $x$ .
- The even numbered components of  $x$  do not depend on each other, but only on the odd components:  $x_2$  follows from  $x_1$ ,  $x_4$  from  $x_3$ , et cetera. Once the odd components have been computed, admittedly sequentially, this step is fully parallel.

We can describe the sequential solving of the odd components by itself:

$$\begin{pmatrix} 1 & & \emptyset \\ c_{21} & 1 & \\ & \ddots & \ddots \\ \emptyset & & c_{n,n-1} & 1 \end{pmatrix} \begin{pmatrix} x_1 \\ x_3 \\ \vdots \\ x_n \end{pmatrix} = \begin{pmatrix} y'_1 \\ y'_3 \\ \vdots \\ y'_n \end{pmatrix}$$

where  $c_{i+1,i} = -b_{2n+1,2n}b_{2n,2n-1}$ . In other words, we have reduced a size  $n$  sequential problem to a sequential problem of the size kind and a parallel problem, both of size  $n/2$ . Now we can repeat this procedure recursively, reducing the original problem to a sequence of parallel operations, each half the size of the former.

The process of computing all partial sums through recursive doubling is also referred to as a parallel *prefix operation*. Here we use a prefix sum, but in the abstract it can be applied to any associative operator.

### 6.10.3 Approximating implicit by explicit operations, series expansion

There are various reasons why it is sometimes allowed to replace an implicit operation, which, as you saw above, can be problematic in practice, by a different one that is practically more advantageous.

- Using an explicit method for the heat equation (section 4.3) instead of an implicit one is equally legitimate, as long as we observe step size restrictions on the explicit method.
- Tinkering with the preconditioner (section 5.5.7) in an iterative method is allowed, since it will only affect the speed of convergence, not the solution the method converges to. You already saw one example of this general idea in the *block Jacobi* method; section 6.7.3. In the rest of this section you will see how recurrences in the preconditioner, which are implicit operations, can be replaced by explicit operations, giving various computational advantages.

Solving a linear system is a good example of an implicit operation, and since this comes down to solving two triangular systems, let us look at ways of finding a computational alternative to solving a lower triangular system. If  $U$  is upper triangular and nonsingular, we let  $D$  be the diagonal of  $U$ , and we write  $U = D(I - B)$  where  $B$  is an upper triangular matrix with a zero diagonal, also called a *strictly upper triangular matrix*; we say that  $I - B$  is a *unit upper triangular matrix*.

**Exercise 6.37.** Let  $A = LU$  be an LU factorization where  $L$  has ones on the diagonal. Show how solving a system  $Ax = b$  can be done, involving only the solution of unit upper and lower triangular systems. Show that no divisions are needed during the system solution.

Our operation of interest is now solving the system  $(I - B)x = y$ . We observe that

$$(I - B)^{-1} = I + B + B^2 + \dots \tag{6.5}$$

and  $B^n = 0$  where  $n$  is the matrix size (check this!), so we can solve  $(I - B)x = y$  exactly by

$$x = \sum_{k=0}^{n-1} B^k y.$$



Of course, we want to avoid computing the powers  $B^k$  explicitly, so we observe that

$$\sum_{k=0}^1 B^k y = (I+B)y, \quad \sum_{k=0}^2 B^k y = (I+B(I+B))y, \quad \sum_{k=0}^3 B^k y = (I+B(I+B((I+B))))y, \quad (6.6)$$

et cetera. The resulting algorithm for evaluating  $\sum_{k=0}^{n-1} B^k y$  is called *Horner's rule*, and you see that it avoids computing matrix powers  $B^k$ .

**Exercise 6.38.** Suppose that  $I-B$  is bidiagonal. Show that the above calculation takes  $n(n+1)$  operations. What is the operation count for computing  $(I-B)x = y$  by triangular solution?

We have now turned an implicit operation into an explicit one, but unfortunately one with a high operation count. In practical circumstances, however, we can truncate the sum of matrix powers.

**Exercise 6.39.** Let  $A$  be the tridiagonal matrix

$$A = \begin{pmatrix} 2 & -1 & & \emptyset \\ -1 & 2 & -1 & \\ & \ddots & \ddots & \ddots \\ \emptyset & & & -1 & 2 \end{pmatrix}$$

of the one-dimensional BVP from section 4.2.2.

1. Recall the definition of diagonal dominance in section 5.3.4. Is this matrix diagonally dominant?
2. Show that the pivots in an LU factorization of this matrix (without pivoting) satisfy a recurrence. Hint: show that after  $n$  elimination steps ( $n \geq 0$ ) the remaining matrix looks like

$$A^{(n)} = \begin{pmatrix} d_n & -1 & & \emptyset \\ -1 & 2 & -1 & \\ & \ddots & \ddots & \ddots \\ \emptyset & & & -1 & 2 \end{pmatrix}$$

and show the relation between  $d_{n+1}$  and  $d_n$ .

3. Show that the sequence  $n \mapsto d_n$  is descending, and derive the limit value.
4. Write out the  $L$  and  $U$  factors in terms of the  $d_n$  pivots.
5. Are the  $L$  and  $U$  factors diagonally dominant?

The above exercise implies (note that we did not actually prove it!) that for matrices from BVPs we find that  $B^k \downarrow 0$ , in element size and in norm. This means that we can approximate the solution of  $(I-B)x = y$  by, for instance,  $x = (I+B)y$  or  $x = (I+B+B^2)y$ . Doing this still has a higher operation count than the direct triangular solution, but it is computationally advantageous in at least two ways:

- The explicit algorithm has a better pipeline behaviour.

- The implicit algorithm has problems in parallel, as you have seen; the explicit algorithm is easily parallelized.

Of course, this approximation may have further implications for the stability of the overall numerical algorithm.

**Exercise 6.40.** Describe the parallelism aspects of Horner's rule; equation (6.6).

## 6.11 Grid updates

One of the conclusions of chapter 4 was that explicit methods for time-dependent problems are computationally easier than implicit ones. For instance, they typically involve a matrix-vector product rather than a system solution, and parallelizing explicit operations is fairly simple: each result value of the matrix-vector product can be computed independently. That does not mean that there are other computational aspects worth remarking on.

Since we are dealing with sparse matrices, stemming from some computational stencil, we take the operator point of view. In figures 6.8 and 6.9 you saw how applying a stencil in each point of the domain induces certain relations between processors: in order to evaluate the matrix-vector product  $y \leftarrow Ax$  on a processor, that processor needs to obtain the  $x$ -values of its *ghost region*. Under reasonable assumptions on the partitioning of the domain over the processors, the number of messages involved will be fairly small.

**Exercise 6.41.** Reason that, in a FEM or FDM context, the number of messages is  $O(1)$  as  $h \downarrow 0$ .

In section 1.5.1 you saw that the matrix-vector product has little data reuse, though there is some locality to the computation; in section 5.4.1.4 it was pointed out that the locality of the sparse matrix-vector product is even worse because of indexing schemes that the sparsity necessitates. This means that the sparse product is largely a *bandwidth-bound algorithm*.

Looking at just a single product there is not much we can do about that. However, often we do a number of such products in a row, for instance as the steps in a time-dependent process. In that case there may be rearrangements of the operations that lessen the bandwidth demands. Consider as a simple example

$$\forall_i: x_i^{(n+1)} = f(x_i^{(n)}, x_{i-1}^{(n)}, x_{i+1}^{(n)}) \quad (6.7)$$

and let's assume that the set  $\{x_i^{(n)}\}_i$  is too large to fit in cache. This is a model for, for instance, the explicit scheme for the heat equation in one space dimension; section 4.3.1.1. Schematically:

$$\begin{array}{ccc} x_0^{(n)} & x_1^{(n)} & x_2^{(n)} \\ \downarrow \swarrow & \searrow \downarrow \swarrow & \searrow \downarrow \swarrow \\ x_0^{(n+1)} & x_1^{(n+1)} & x_2^{(n+1)} \\ \downarrow \swarrow & \searrow \downarrow \swarrow & \searrow \downarrow \swarrow \\ x_0^{(n+2)} & x_1^{(n+2)} & x_2^{(n+2)} \end{array}$$

In the ordinary computation, where we first compute all  $x_i^{(n+1)}$ , then all  $x_i^{(n+2)}$ , the intermediate values at level  $n+1$  will be flushed from the cache after they were generated, and then brought back into cache as input for the level  $n+2$  quantities.

However, if we compute not one, but two iterations, the intermediate values may stay in cache. Consider  $x_0^{(n+2)}$ : it requires  $x_0^{(n+1)}, x_1^{(n+1)}$ , which in turn require  $x_0^{(n)}, \dots, x_2^{(n)}$ .

Now suppose that we are not interested in the intermediate results, but only the final iteration. Figure 6.22 shows a simple example. The first processor computes 4 points on level  $n + 2$ . For this it needs 5 points

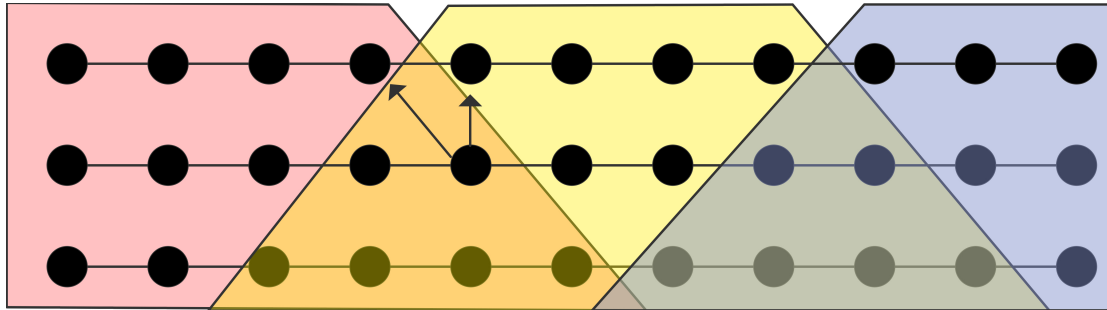

Figure 6.22: Computation of blocks of grid points over multiple iterations

from level  $n + 1$ , and these need to be computed too, from 6 points on level  $n$ . We see that a processor apparently needs to collect a *ghost region* of width two, as opposed to just one for the regular single step update. One of the points computed by the first processor is  $x_3^{(n+2)}$ , which needs  $x_4^{(n+1)}$ . This point is also needed for the computation of  $x_4^{(n+2)}$ , which belongs to the second processor.

The easiest solution is to let this sort of point on the intermediate level *redundantly computed*, in the computation of both blocks where it is needed, on two different processors.

**Exercise 6.42.** Can you think of cases where a point would be redundantly computed by more than two processors?

We can give several interpretations to this scheme of computing multiple update steps by blocks.

- First of all, as we motivated above, doing this on a single processor increases locality: if all points in a coloured block (see the figure) fit in cache, we get reuse of the intermediate points.
- Secondly, if we consider this as a scheme for distributed memory computation, it reduces message traffic. Normally, for every update step the processors need to exchange their boundary data. If we accept some redundant duplication of work, we can now eliminate the data exchange for the intermediate levels. The decrease in communication will typically outweigh the increase in work.

**Exercise 6.43.** Discuss the case of using this strategy for multicore computation. What are the savings? What are the potential pitfalls?

### 6.11.1 Analysis

Let's analyze the algorithm we have just sketched. As in equation (6.7) we limit ourselves to a 1D set of points and a function of three points. The parameters describing the problem are these:

- $N$  is the number of points to be updated, and  $M$  denotes the number of update steps. Thus, we perform  $MN$  function evaluations.

- $\alpha, \beta, \gamma$  are the usual parameters describing latency, transmission time of a single point, and time for an operation (here taken to be an  $f$  evaluation).
- $b$  is the number of steps we block together.

Each halo communication consists of  $b$  points, and we do this  $\sqrt{N}/b$  many times. The work performed consists of the  $MN/p$  local updates, plus the redundant work because of the halo. The latter term consists of  $b^2/2$  operations, performed both on the left and right side of the processor domain.

Adding all these terms together, we find a cost of

$$\frac{M}{b}\alpha + M\beta + \left(\frac{MN}{p} + Mb\right)\gamma.$$

We observe that the overhead of  $\alpha M/b + \gamma Mb$  is independent of  $p$ ,

**Exercise 6.44.** Compute the optimal value of  $b$ , and remark that it only depends on the architectural parameters  $\alpha, \beta, \gamma$  but not on the problem parameters.

### 6.11.2 Communication and work minimizing strategy

We can make this algorithm more efficient by *overlapping computation with communication*. As illustrated in figure 6.23, each processor start by communicating its halo, and overlapping this communication with the part of the communication that can be done locally. The values that depend on the halo will then be computed last.

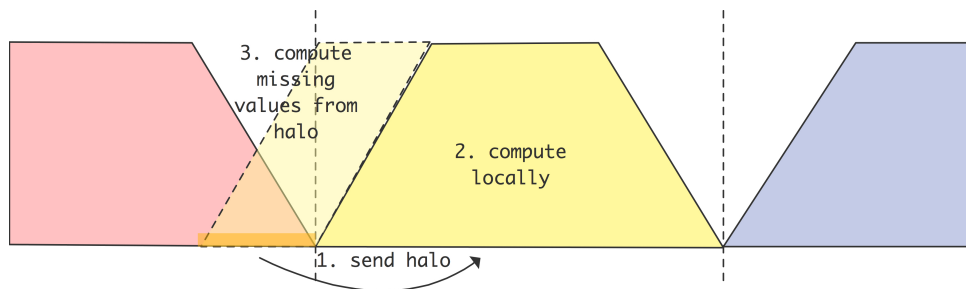

Figure 6.23: Computation of blocks of grid points over multiple iterations

**Exercise 6.45.** What is a great practical problem with organizing your code (with the emphasis on ‘code!’) this way?

If the number of points per processor is large enough, the amount of communication is low relative to the computation, and you could take  $b$  fairly large. However, these grid updates are mostly used in iterative methods such as the *CG* method (section 5.5.10), and in that case considerations of roundoff prevent you from taking  $b$  too large[27].

**Exercise 6.46.** Go through the complexity analysis for the non-overlapping algorithm in case the points are organized in a 2D grid. Assume that each point update involves four neighbours, two in each coordinate direction.

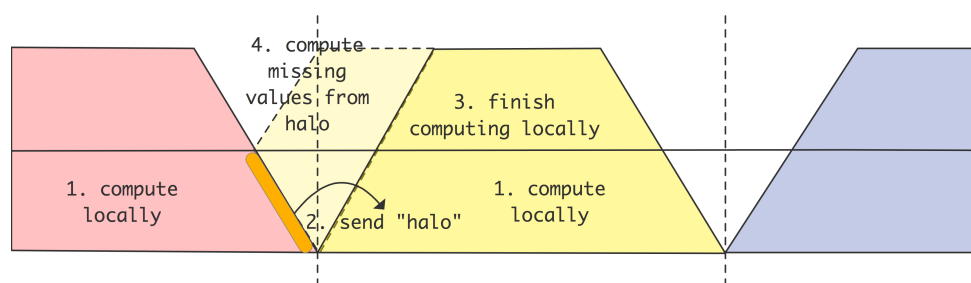

Figure 6.24: Computation of blocks of grid points over multiple iterations

A further refinement of the above algorithm is possible. Figure 6.24 illustrates that it is possible to use a halo region that uses different points from different time steps. This algorithm (see [35]) cuts down on the amount of redundant computation. However, now the halo values that are communicated first need to be computed, so this requires splitting the local communication into two phases.

## 6.12 Block algorithms on multicore architectures

In section 5.3.7 you saw that certain linear algebra algorithms can be formulated in terms of submatrices. This point of view can be beneficial for the efficient execution of linear algebra operations on shared memory architectures such as current *multicore* processors.

As an example, let us consider the *Cholesky factorization*, which computes  $A = LL^t$  for a symmetric positive definite matrix  $A$ ; see also section 5.3.2. Recursively, we can describe the algorithm as follows:

$$\text{Chol} \begin{pmatrix} A_{11} & A_{21}^t \\ A_{21} & A_{22} \end{pmatrix} = LL^t \quad \text{where} \quad L = \begin{pmatrix} L_{11} & 0 \\ \tilde{A}_{21} & \text{Chol}(A_{22} - \tilde{A}_{21}\tilde{A}_{21}^t) \end{pmatrix}$$

and where  $\tilde{A}_{21} = A_{21}L_{11}^{-t}$ ,  $A_{11} = L_{11}L_{11}^t$ .

In practice, the block implementation is applied to a partitioning

$$\left( \begin{array}{c|cc} & \text{finished} & \\ \hline & A_{kk} & A_{k,>k} \\ \hline & A_{>k,k} & A_{>k,>k} \end{array} \right)$$

where  $k$  is the index of the current block row, and the factorization is finished for all indices  $< k$ . The factorization is written as follows, using Blas names for the operations:

for  $k = 1, \text{nblocks}$ :

Chol: factor  $L_k L_k^t \leftarrow A_{kk}$

Trsm: solve  $\tilde{A}_{>k,k} \leftarrow A_{>k,k} L_k^{-t}$

Gemm: form the product  $\tilde{A}_{>k,k} \tilde{A}_{>k,k}^t$

Syrk: symmetric rank- $k$  update  $A_{>k,>k} \leftarrow A_{>k,>k} - \tilde{A}_{>k,k} \tilde{A}_{>k,k}^t$

The key to parallel performance is to partition the indices  $> k$  and write the algorithm in terms of these blocks:

$$\left( \begin{array}{c|ccc} & \text{finished} & & \\ \hline & A_{kk} & A_{k,k+1} & A_{k,k+2} \cdots \\ \hline A_{k+1,k} & A_{k+1,k+1} & A_{k+1,k+2} \cdots & \\ A_{k+2,k} & A_{k+2,k+2} & & \\ \vdots & \vdots & & \end{array} \right)$$

The algorithm now gets an extra level of inner loops:

for  $k = 1, \text{nblocks}$ :

  Chol: factor  $L_k L_k^t \leftarrow A_{kk}$

  for  $\ell > k$ :

    Trsm: solve  $\tilde{A}_{\ell,k} \leftarrow A_{\ell,k} L_k^{-t}$

  for  $\ell_1, \ell_2 > k$ :

    Gemm: form the product  $\tilde{A}_{\ell_1,k} \tilde{A}_{\ell_2,k}^t$

  for  $\ell_1, \ell_2 > k, \ell_1 \leq \ell_2$ :

    Syrk: symmetric rank- $k$  update  $A_{\ell_1,\ell_2} \leftarrow A_{\ell_1,\ell_2} - \tilde{A}_{\ell_1,k} \tilde{A}_{\ell_2,k}^t$

Now it is clear that the algorithm has a good deal of parallelism: the iterations in every  $\ell$ -loop can be processed independently. However, these loops get shorter in every iteration of the outer  $k$ -loop, so it is not immediate how many processors we can accommodate. Moreover, it is not necessary to preserve the order of operations of the algorithm above. For instance, after

$$L_1 L_1^t = A_{11}, \quad A_{21} \leftarrow A_{21} L_1^{-t}, \quad A_{22} \leftarrow A_{22} - A_{21} A_{21}^t$$

the factorization  $L_2 L_2^t = A_{22}$  can start, even if the rest of the  $k = 1$  iteration is still unfinished. Thus, there is probably a lot more parallelism than we would get from just parallelizing the inner loops.

The best way to approach parallelism in this case is to shift away from a *control flow* view of the algorithm, where the sequence of operations is prescribed, to a *data flow* view. In the latter only data dependencies are indicated, and any ordering of operations that obeys these dependencies is allowed. (Technically, we abandon the program order of the tasks and replace it with a *partial ordering*<sup>5</sup>.) The best way of representing the data flow of an algorithm is by constructing a *Directed Acyclic Graph (DAG)* (see section 16 for a brief tutorial on graphs) of tasks. We add an edge  $(i, j)$  to the graph if task  $j$  uses the output of task  $i$ .

**Exercise 6.47.** In section 2.7.1.5 you learned the concept of *sequential consistency*: a threaded parallel code program should give the same results when executed in parallel as when it's executed sequentially. We have just stated that DAG-based algorithms are free to execute tasks in any order that obeys the partial order of the graph nodes. Discuss whether sequential consistency is a problem in this context.

In our example, we construct a DAG by making a vertex task for every inner iteration. Figure 6.25 shows the DAG of all tasks of matrix of  $4 \times 4$  blocks. This graph is constructed by simulating the Cholesky algorithm above,

5. Let's write  $a \leq b$  if  $a$  is executed before  $b$ , then the relation  $\cdot \leq \cdot$  is a partial order if  $a \leq b \wedge b \leq a \Rightarrow a = b$  and  $a \leq b \wedge b \leq c \Rightarrow a \leq c$ . The difference with a total ordering, such as program ordering, is that it is not true that  $a \leq b \vee b \leq a$ : there can be pairs that are not ordered, meaning that their time ordering is not prescribed.

**Exercise 6.48.** What is the diameter of this graph? Identify the tasks that lie on the path that determines the diameter. What is the meaning of these tasks in the context of the algorithm? This path is called the *critical path*. Its length determines the execution time of the computation in parallel, even if an infinite number of processors is available.

**Exercise 6.49.** Assume there are  $T$  tasks that all take a unit time to execute, and assume we have  $p$  processors. What is the theoretical minimum time to execute the algorithm? Now amend this formula to take into account the critical path; call its length  $C$ .

In the execution of the tasks a DAG, several observations can be made.

- If more than one update is made to a block, it is probably advantageous to have these updates be computed by the same process. This simplifies maintaining *cache coherence*.
- If data is used and later modified, the use must be finished before the modification can start. This can even be true if the two actions are on different processors, since the memory subsystem typically maintains cache coherence, so the modifications can affect the process that is reading the data. This case can be remedied by having a copy of the data in main memory, giving a reading process data that is reserved (see section 1.4.1).

Figure 6.25: Graph of task dependencies in a  $4 \times 4$  Cholesky factorization





**PART II**

**APPLICATIONS**

## Chapter 7

### Molecular dynamics

Molecular dynamics is a technique for simulating the atom-by-atom behavior of molecules and deriving macroscopic properties from these atomistic motions. It has application to biological molecules such as proteins and nucleic acids, as well as natural and synthetic molecules in materials science and nanotechnology. Molecular dynamics falls in the category of particle methods, which includes N-body problems in celestial mechanics and astrophysics, and many of the ideas presented here will carry over to these other fields. In addition, there are special cases of molecular dynamics including *ab initio* molecular dynamics where electrons are treated quantum mechanically and thus chemical reactions can be modeled. We will not treat these special cases, but will instead concentrate on *classical* molecular dynamics.

The idea behind molecular dynamics is very simple: a set of particles interact according to Newton's law of motion,  $F = ma$ . Given the initial particle positions and velocities, the particle masses and other parameters, as well as a model of the forces that act between particles, Newton's law of motion can be integrated numerically to give a trajectory for each of the particles for all future (and past) time. Commonly, the particles reside in a computational box with periodic boundary conditions.

A molecular dynamics time step is thus composed of two parts:

- 1: compute forces on all particles
- 2: update positions (integration).

The computation of the forces is the expensive part. State-of-the-art molecular dynamics simulations are performed on parallel computers because the force computation is costly and a vast number of time steps are required for reasonable simulation lengths. In many cases, molecular dynamics is applied to simulations on molecules with a very large number of atoms as well, e.g., up to a million for biological molecules and long time scales, and up to billions for other molecules and shorter time scales.

Numerical integration techniques are also of interest in molecular dynamics. For simulations that take a large number of time steps and for which the preservation of quantities such as energy is more important than order of accuracy, the solvers that must be used are different than the traditional ODE solvers presented in Chapter 4.

In the following, we will introduce force fields used for biomolecular simulations and discuss fast methods for computing these forces. Then we devote sections to the parallelization of molecular dynamics for short-range forces and the parallelization of the 3-D FFT used in fast computations of long-range forces. We

end with a section introducing the class of integration techniques that are suitable for molecular dynamics simulations. Our treatment of the subject of molecular dynamics in this chapter is meant to be introductory and practical; for more information, the text [59] is recommended.

## 7.1 Force Computation

### 7.1.1 Force Fields

In classical molecular dynamics, the model of potential energy and of the forces that act between atoms is called a *force field*. The force field is a tractable but approximate model of quantum mechanical effects which are computationally too expensive to determine for large molecules. Different force fields are used for different types of molecules, as well as for the same molecule by different researchers, and none are ideal.

In biochemical systems, commonly-used force fields model the potential energy function as the sum of bonded, van der Waals, and electrostatic (Coulomb) energy:

$$E = E_{\text{bonded}} + E_{\text{Coul}} + E_{\text{vdW}}.$$

The potential is a function of the positions of all the atoms in the simulation. The force on an atom is the negative gradient of this potential at the position of the atom.

The bonded energy is due to covalent bonds in a molecule,

$$E_{\text{bonded}} = \sum_{\text{bonds}} k_i (r_i - r_{i,0})^2 + \sum_{\text{angles}} k_i (\theta_i - \theta_{i,0})^2 + \sum_{\text{torsions}} V_n (1 + \cos(n\omega - \gamma))$$

where the three terms are, respectively, sums over all covalent bonds, sums over all angles formed by two bonds, and sums over all dihedral angles formed by three bonds. The fixed parameters  $k_i$ ,  $r_{i,0}$ , etc. depend on the types of atoms involved, and may differ for different force fields. Additional terms or terms with different functional forms are also commonly used.

The remaining two terms for the potential energy  $E$  are collectively called the nonbonded terms. Computationally, they form the bulk of the force calculation. The electrostatic energy is due to atomic charges and is modeled by the familiar

$$E_{\text{Coul}} = \sum_i \sum_{j>i} \frac{q_i q_j}{4\pi\epsilon_0 r_{ij}}$$

where the sum is over all pairs of atoms,  $q_i$  and  $q_j$  are the charges on atoms  $i$  and  $j$ , and  $r_{ij}$  is the distance between atoms  $i$  and  $j$ . Finally, the van der Waals energy approximates the remaining attractive and repulsive effects, and is commonly modeled by the Lennard-Jones function

$$E_{\text{vdW}} = \sum_i \sum_{j>i} 4\epsilon_{ij} \left[ \left( \frac{\sigma_{ij}}{r_{ij}} \right)^{12} - \left( \frac{\sigma_{ij}}{r_{ij}} \right)^6 \right]$$

where  $\epsilon_{ij}$  and  $\sigma_{ij}$  are force field parameters depending on atom types. At short distances, the repulsive ( $r^{-12}$ ) term is in effect, while at long distances, the dispersive (attractive,  $-r^{-6}$ ) term is in effect.

Parallelization of the molecular dynamics force calculation depends on parallelization each of these individual types of force calculations. The bonded forces are local computations in the sense that for a given atom, only nearby atom positions and data are needed. The van der Waals forces are also local and are termed short-range because they are negligible for large atom separations. The electrostatic forces are long-range, and various techniques have been developed to speed up these calculations. In the next two subsections, we separately discuss the computation of short-range and long-range nonbonded forces.

### 7.1.2 Computing Short-Range Nonbonded Forces

The computation of short-range nonbonded forces for a particle can be truncated beyond a cutoff radius,  $r_c$ , of that particle. The naive approach to perform this computation for a particle  $i$  is by examining all other particles and computing their distance to particle  $i$ . For  $n$  particles, the complexity of this approach is  $O(n^2)$ , which is equivalent to computing forces between all pairs of particles. There are two data structures, *cell lists* and *Verlet neighbor lists*, that can be used independently for speeding up this calculation, as well as an approach that combines the two.

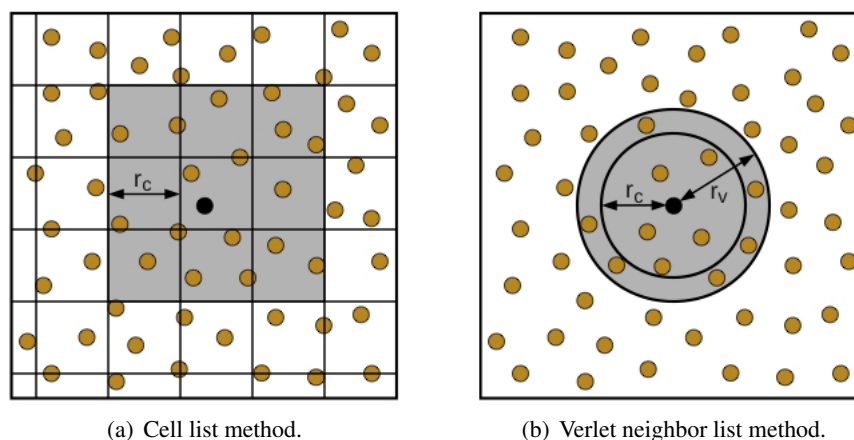

Figure 7.1: Computing nonbonded forces within a cutoff,  $r_c$ . To compute forces involving the highlighted particle, only particles in the shaded regions are considered.

#### 7.1.2.1 Cell Lists

The idea of cell lists appears often in problems where a set of points that are nearby a given point is sought. Referring to Fig. 7.1(a), where we illustrate the idea with a 2-D example, a grid is laid over the set of particles. If the grid spacing is no less than  $r_c$ , then to compute the forces on particle  $i$ , only the particles in the cell containing  $i$  and the 8 adjacent cells need to be considered. One sweep through all the particles is used to construct a list of particles for each cell. These cell lists are used to compute the forces for all particles. At the next time step, since the particles have moved, the cell lists must be regenerated or updated. The complexity of this approach is  $O(n)$  for computing the data structure and  $O(n \times n_c)$  for the

force computation, where  $n_c$  is the average number of particles in 9 cells (27 cells in 3-D). The storage required for the cell list data structure is  $O(n)$ .

### 7.1.2.2 Verlet Neighbor Lists

The cell list structure is somewhat inefficient because, for each particle  $i$ ,  $n_c$  particles are considered, but this is much more than the number of particles within the cutoff  $r_c$ . A Verlet neighbor list is a list of particles within the cutoff for a particle  $i$ . Each particle has its own list, and thus the storage required is  $O(n \times n_v)$  where  $n_v$  is the average number of particles within the cutoff. Once these lists are constructed, computing the forces is then very fast, requiring the minimal complexity  $O(n \times n_v)$ . Constructing the list is more expensive, requiring examining all the particles for each particle, i.e., no less than the original complexity of  $O(n^2)$ . The advantage, however, is that the neighbor lists can be reused for many time steps if an expanded cutoff,  $r_v$  is used. Referring to a 2-D example in Fig. 7.1(b), the neighbor list can be reused as long as no particle from outside the two circles moves inside the inner circle. If the maximum speed of the particles can be estimated or bounded, then one can determine a number of time steps for which it is safe to reuse the neighbor lists. (Alternatively, it may be possible to signal when any particle crosses to a position within the cutoff.) Technically, the Verlet neighbor list is the list of particles within the expanded cutoff,  $r_v$ .

### 7.1.2.3 Using Cell and Neighbor Lists Together

The hybrid approach is simply to use Verlet neighbor lists but to use cell lists to construct the neighbor lists. This reduces the high cost when neighbor lists need to be regenerated. This hybrid approach is very effective and is often the approach used in state-of-the-art molecular dynamics software.

Both cell lists and Verlet neighbor lists can be modified to exploit the fact that the force  $f_{ij}$  on particle  $i$  due to particle  $j$  is equal to  $-f_{ji}$  (Newton's third law) and only needs to be computed once. For example, for cell lists, only 4 of the 8 cells (in 2-D) need to be considered.

## 7.1.3 Computing Long-Range Forces

Electrostatic forces are challenging to compute because they are long-range: each particle feels a non-negligible electrostatic force from all other particles in the simulation. An approximation that is sometimes used is to truncate the force calculation for a particle after a certain cutoff radius (as is done for short-range van der Waals forces). This generally produces unacceptable artifacts in the results, however.

There are several more accurate methods for speeding up the computation of electrostatic forces, avoiding the  $O(n^2)$  sum over all pairs of  $n$  particles. We briefly outline some of these methods here.

### 7.1.3.1 Hierarchical N-body Methods

Hierarchical N-body methods, including the Barnes-Hut method and the fast multipole method, are popular for astrophysical particle simulations, but are typically too costly for the accuracy required in biomolecular simulations. In the Barnes-Hut method, space is recursively divided into 8 equal cells (in 3-D) until each cell contains zero or one particles. Forces between nearby particles are computed individually, as normal, but

for distant particles, forces are computed between one particle and a set of distant particles within a cell. An accuracy measure is used to determine if the force can be computed using a distant cell or must be computed by individually considering its children cells. The Barnes-Hut method has complexity  $O(n \log n)$ . The fast multipole method has complexity  $O(n)$ ; this method calculates the potential and does not calculate forces directly.

### 7.1.3.2 Particle-Mesh Methods

In particle-mesh methods, we exploit the Poisson equation

$$\nabla^2 \phi = -\frac{1}{\epsilon} \rho$$

which relates the potential  $\phi$  to the charge density  $\rho$ , where  $1/\epsilon$  is a constant of proportionality. To utilize this equation, we discretize space using a mesh, assign charges to the mesh points, solve Poisson's equation on the mesh to arrive at the potential on the mesh. The force is the negative gradient of the potential (for conservative forces such as electrostatic forces). A number of techniques have been developed for distributing point charges in space to a set of mesh points and also for numerically interpolating the force on the point charges due to the potentials at the mesh points. Many fast methods are available for solving the Poisson equation, including multigrid methods and fast Fourier transforms. With respect to terminology, particle-mesh methods are in contrast to the naive *particle-particle* method where forces are computed between all pairs of particles.

It turns out that particle-mesh methods are not very accurate, and a more accurate alternative is to split each force into a short-range, rapidly-varying part and a long-range, slowly-varying part:

$$f_{ij} = f_{ij}^{sr} + f_{ij}^{lr}.$$

One way to accomplish this easily is to weigh  $f$  by a function  $h(r)$ , which emphasizes the short-range part (small  $r$ ) and by  $1 - h(r)$  which emphasizes the long-range part (large  $r$ ). The short-range part is computed by computing the interaction of all pairs of particles within a cutoff (a particle-particle method) and the long-range part is computed using the particle-mesh method. The resulting method, called particle-particle-mesh (PPPM, or P<sup>3</sup>M) is due to Hockney and Eastwood, in a series of papers beginning in 1973.

### 7.1.3.3 Ewald Method

The Ewald method is the most popular of the methods described so far for electrostatic forces in biomolecular simulations and was developed for the case of periodic boundary conditions. The structure of the method is similar to PPPM in that the force is split between short-range and long-range parts. Again, the short-range part is computed using particle-particle methods, and the long-range part is computed using Fourier transforms. Variants of the Ewald method are very similar to PPPM in that the long-range part uses a mesh, and fast Fourier transforms are used to solve the Poisson equation on the mesh. For additional details, see, for example [59]. In Section 7.3, we describe the parallelization of the 3-D FFT to solve the 3-D Poisson equation.

## 7.2 Parallel Decompositions

We now discuss the parallel computation of forces. Plimpton [136] created a very useful categorization of molecular dynamics parallelization methods, identifying *atom*, *force*, and *spatial* decomposition methods. Here, we closely follow his description of these methods. We also add a fourth category which has come to be recognized as differing from the earlier categories, called *neutral territory* methods, a name coined by Shaw [146]. Neutral territory methods are currently used by many state-of-the-art molecular dynamics codes. Spatial decompositions and neutral territory methods are particularly advantageous for parallelizing cutoff-based calculations.

### 7.2.1 Atom Decompositions

In an atom decomposition, each particle is assigned to one processor, and that processor is responsible for computing the particle's forces and updating its position for the entire simulation. For the computation to be roughly balanced, each processor is assigned approximately the same number of particles (a random distribution works well). An important point of atom decompositions is that each processor generally needs to communicate with all other processors to share updated particle positions.

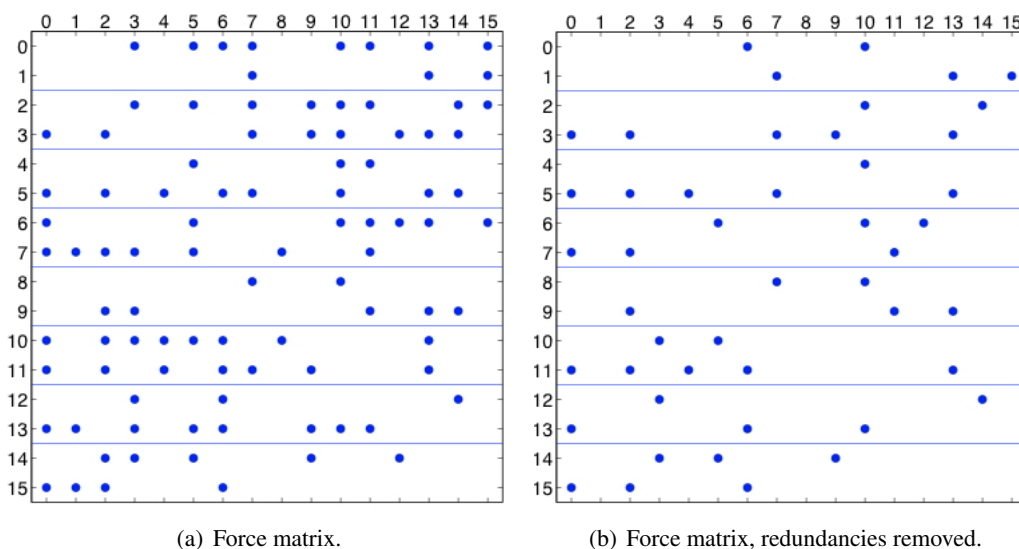

Figure 7.2: Atom decomposition, showing a force matrix of 16 particles distributed among 8 processors. A dot represents a nonzero entry in the force matrix. On the left, the matrix is symmetric; on the right, only one element of a pair of skew-symmetric elements is computed, to take advantage of Newton's third law.

An atom decomposition is illustrated by the *force matrix* in Fig. 7.2(a). For  $n$  particles, the force matrix is an  $n$ -by- $n$  matrix; the rows and columns are numbered by particle indices. A nonzero entry  $f_{ij}$  in the matrix denotes a nonzero force on particle  $i$  due to particle  $j$  which must be computed. This force may be a nonbonded and/or a bonded force. When cutoffs are used, the matrix is sparse, as in this example. The matrix is dense if forces are computed between all pairs of particles. The matrix is skew-symmetric because of Newton's third law,  $f_{ij} = -f_{ji}$ . The lines in Fig. 7.2(a) show how the particles are partitioned. In the figure, 16 particles are partitioned among 8 processors.



Algorithm 1 shows one time step from the point of view of one processor. At the beginning of the time step, each processor holds the positions of particles assigned to it.

---

**Algorithm 1** Atom decomposition time step

---

- 1: send/receive particle positions to/from all other processors
  - 2: (if nonbonded cutoffs are used) determine which nonbonded forces need to be computed
  - 3: compute forces for particles assigned to this processor
  - 4: update positions (integration) for particles assigned to this processor
- 

An optimization is to halve the amount of computation, which is possible because the force matrix is skew-symmetric. To do this, we choose exactly one of  $f_{ij}$  or  $f_{ji}$  for all skew-symmetric pairs such that each processor is responsible for computing approximately the same number of forces. Choosing the upper or lower triangular part of the force matrix is a bad choice because the computational load is unbalanced. A better choice is to compute  $f_{ij}$  if  $i + j$  is even in the upper triangle, or if  $i + j$  is odd in the lower triangle, as shown in Fig. 7.2(b). There are many other options.

When taking advantage of skew-symmetry in the force matrix, all the forces on a particle owned by a processor are no longer computed by that processor. For example, in Fig. 7.2(b), the forces on particle 1 are no longer computed only by the first processor. To complete the force calculation, processors must communicate to send forces that are needed by other processors and receive forces that are computed by other processors. The above algorithm must now be modified by adding a communication step (step 4) as shown in Algorithm 2.

---

**Algorithm 2** Atom decomposition time step, without redundant calculations

---

- 1: send/receive particle positions to/from all other processors
  - 2: (if nonbonded cutoffs are used) determine which nonbonded forces need to be computed
  - 3: compute *partial* forces for particles assigned to this processor
  - 4: send particle forces needed by other processors and receive particle forces needed by this processor
  - 5: update positions (integration) for particles assigned to this processor
- 

This algorithm is advantageous if the extra communication is outweighed by the savings in computation. Note that the amount of communication doubles in general.

### 7.2.2 Force Decompositions

In a force decomposition, the forces are distributed among the processors for computation. A straightforward way to do this is to partition the force matrix into blocks and to assign each block to a processor. Fig. 7.3(a) illustrates this for the case of 16 particles and 16 processors. Particles also need to be assigned to processors (as in atom decompositions) for the purpose of having processors assigned to update particle positions. In the example of the Figure, processor  $i$  is assigned to update the positions of particle  $i$ ; in practical problems, a processor would be assigned to update the positions of many particles. Note that, again, we first consider the case of a skew-symmetric force matrix.

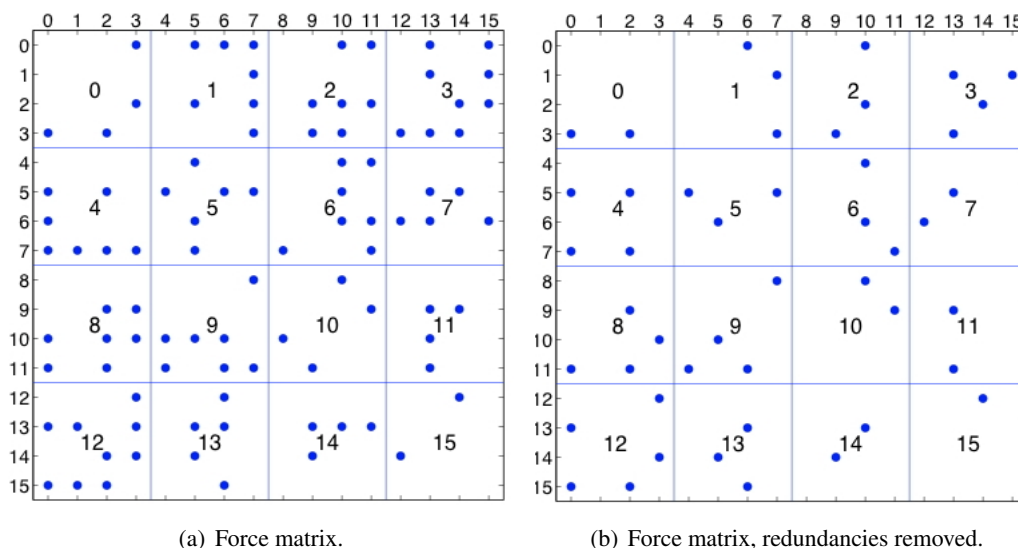

Figure 7.3: Force decomposition, showing a force matrix of 16 particles and forces partitioned among 16 processors.

We now examine the communication required in a time step for a force decomposition. Consider processor 3, which computes partial forces for particles 0, 1, 2, 3, and needs positions from particles 0, 1, 2, 3, and also 12, 13, 14, 15. Thus processor 3 needs to perform communication with processors 0, 1, 2, 3, and processors 12, 13, 14, 15. After forces have been computed by all processors, processor 3 needs to collect forces on particle 3 computed by other processors. Thus processor 2 needs to perform communication again with processors 0, 1, 2, 3.

Algorithm 3 shows what is performed in one time step, from the point-of-view of one processor. At the beginning of the time step, each processor holds the positions of all the particles assigned to it.

---

**Algorithm 3** Force decomposition time step

---

- 1: send positions of my assigned particles which are needed by other processors; receive *row* particle positions needed by my processor (this communication is between processors in the same processor row, e.g., processor 3 communicates with processors 0, 1, 2, 3)
  - 2: receive *column* particle positions needed by my processor (this communication is generally with processors in another processor row, e.g., processor 3 communicates with processors 12, 13, 14, 15)
  - 3: (if nonbonded cutoffs are used) determine which nonbonded forces need to be computed
  - 4: compute forces for my assigned particles
  - 5: send forces needed by other processors; receive forces needed for my assigned particles (this communication is between processors in the same processor row, e.g., processor 3 communicates with processors 0, 1, 2, 3)
  - 6: update positions (integration) for my assigned particles
- 

In general, if there are  $p$  processors (and  $p$  is square, for simplicity), then the the force matrix is partitioned

into  $\sqrt{p}$  by  $\sqrt{p}$  blocks. The force decomposition just described requires a processor to communicate in three steps, with  $\sqrt{p}$  processors in each step. This is much more efficient than atom decompositions which require communications among all  $p$  processors.

We can also exploit Newton's third law in force decompositions. Like for atom decompositions, we first choose a modified force matrix where only one of  $f_{ij}$  and  $f_{ji}$  is computed. The forces on particle  $i$  are computed by a row of processors and now also by a column of processors. Thus an extra step of communication is needed by each processor to collect forces from a column of processors for particles assigned to it. Whereas there were three communication steps, there are now four communication steps when Newton's third law is exploited (the communication is not doubled in this case as in atom decompositions).

A modification to the force decomposition saves some communication. In Fig. 7.4, the columns are reordered using a *block-cyclic* ordering. Consider again processor 3, which computes partial forces for particles 0, 1, 2, 3. It needs positions from particles 0, 1, 2, 3, as before, but now also with processors 3, 7, 11, 15. The latter are processors in the same processor column as processor 3. Thus all communications are within the same processor row or processor column, which may be advantageous on mesh-based network architectures. The modified method is shown as Algorithm 4.

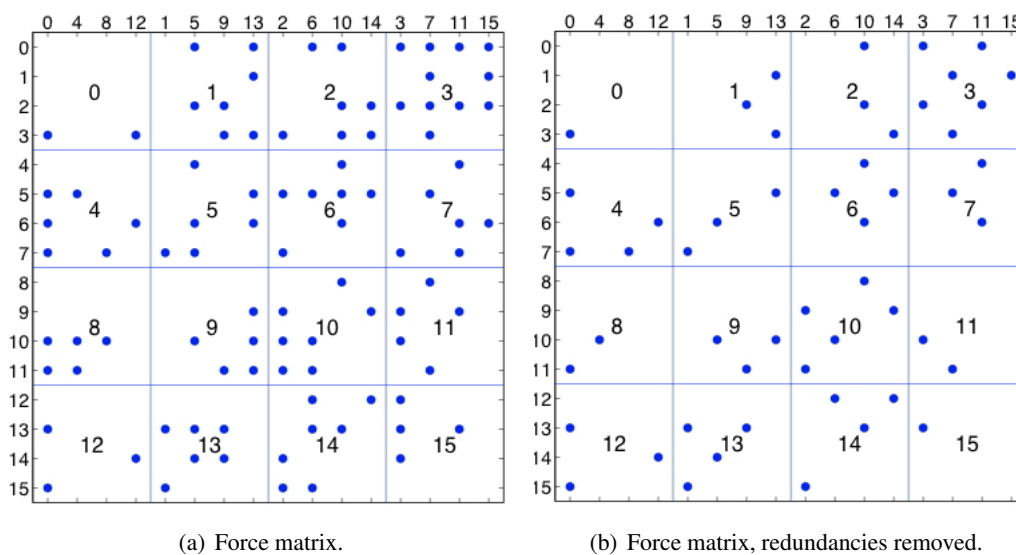

Figure 7.4: Force decomposition, with permuted columns in the force matrix. Note that columns 3, 7, 11, 15 are now in the block column corresponding to processors 3, 7, 11, 15 (the same indices), etc.

### 7.2.3 Spatial Decompositions

In a spatial decomposition, space is decomposed into cells. Each cell is assigned to a processor which is responsible for computing the forces on particles that lie inside the cell. Fig. 7.5(a) illustrates a spatial decomposition into 64 cells for the case of a 2-D simulation. (This is a decomposition of space and is not to be confused with a force matrix.) Typically, the number of cells is chosen to be equal to the number of processors. Since particles move during the simulation, the assignment of particles to cells changes as well. This is in contrast to atom and force decompositions.

**Algorithm 4** Force decomposition time step, with permuted columns of force matrix

- 1: send positions of my assigned particles which are needed by other processors; receive row particle positions needed by my processor (this communication is between processors in the same processor row, e.g., processor 3 communicates with processors 0, 1, 2, 3)
- 2: receive *column* particle positions needed by my processor (this communication is generally with processors the same processor column, e.g., processor 3 communicates with processors 3, 7, 11, 15)
- 3: (if nonbonded cutoffs are used) determine which nonbonded forces need to be computed
- 4: compute forces for my assigned particles
- 5: send forces needed by other processors; receive forces needed for my assigned particles (this communication is between processors in the same processor row, e.g., processor 3 communicates with processors 0, 1, 2, 3)
- 6: update positions (integration) for my assigned particles

Fig. 7.5(b) shows one cell (center square) and the region of space (shaded) that contains particles that are potentially within the cutoff radius,  $r_c$ , with particles in the given cell. The shaded region is often called the *import region*, since the given cell must import positions of particles lying in this region to perform its force calculation. Note that not all particles in the given cell must interact with all particles in the import region, especially if the import region is large compared to the cutoff radius.

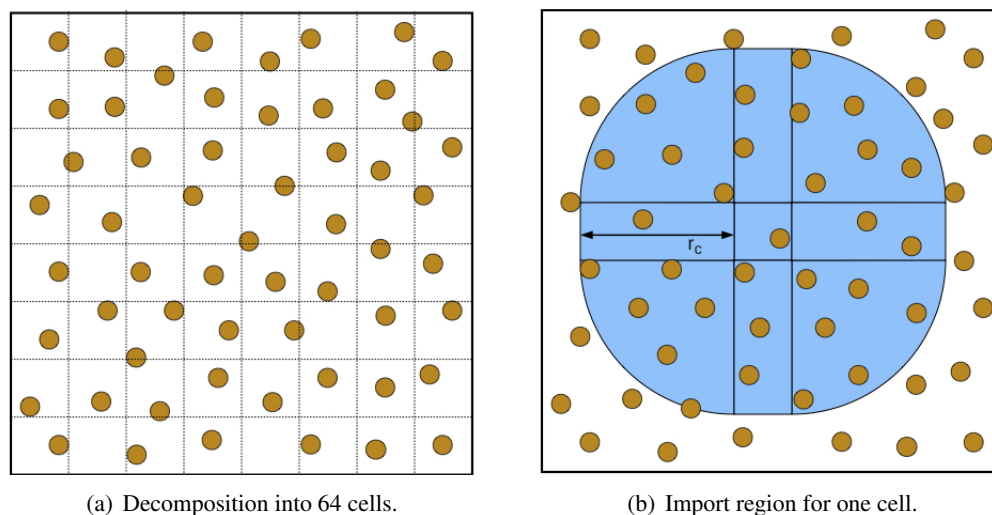

Figure 7.5: Spatial decomposition, showing particles in a 2-D computational box, (a) partitioned into 64 cells, (b) import region for one cell.

Algorithm 5 shows what each processor performs in one time step. We assume that at the beginning of the time step, each processor holds the positions of the particles in its cell.

To exploit Newton's third law, the shape of the import region can be halved. Now each processor only computes a partial force on particles in its cell, and needs to receive forces from other processors to compute the total force on these particles. Thus an extra step of communication is involved. We leave it as an exercise to the reader to work out the details of the modified import region and the pseudocode for this case.

---

**Algorithm 5** Spatial decomposition time step

---

- 1: send positions needed by other processors for particles in their import regions; receive positions for particles in my import region
  - 2: compute forces for my assigned particles
  - 3: update positions (integration) for my assigned particles
- 

In the implementation of a spatial decomposition method, each cell is associated with a list of particles in its import region, similar to a Verlet neighbor list. Like a Verlet neighbor list, it is not necessary to update this list at every time step, if the import region is expanded slightly. This allows the import region list to be reused for several time steps, corresponding to the amount of time it takes a particle to traverse the width of the expanded region. This is exactly analogous to Verlet neighbor lists.

In summary, the main advantage of spatial decomposition methods is that they only require communication between processors corresponding to nearby particles. A disadvantage of spatial decomposition methods is that, for very large numbers of processors, the import region is large compared to the number of particles contained inside each cell.

### 7.2.4 Neutral Territory Methods

Our description of neutral territory methods follows closely that of Shaw [146]. A neutral territory method can be viewed as combining aspects of spatial decompositions and force decompositions. To parallelize the integration step, particles are assigned to processors according to a partitioning of space. To parallelize the force computation, each processor computes the forces between two sets of particles, but these particles may be unrelated to the particles that have been assigned to the processor for integration. As a result of this additional flexibility, neutral territory methods may require much less communication than spatial decomposition methods.

An example of a neutral territory method is shown in Fig. 7.6 for the case of a 2-D simulation. In the method shown in the Figure, the given processor is assigned the computation of forces between particles lying in the horizontal bar with particles lying in the vertical bar. These two regions thus form the import region for this method. By comparing to Fig. 7.6(b), the import region for this neutral territory method is much smaller than that for the corresponding spatial decomposition method. The advantage is greater when the size of the cells corresponding to each processor is small compared to the cutoff radius.

After the forces are computed, the given processor sends the forces it has computed to the processors that need these forces for integration. We thus have Algorithm 6.

---

**Algorithm 6** Neutral territory method time step

---

- 1: send and receive particle positions corresponding to import regions
  - 2: compute forces assigned to this processor
  - 3: send and receive forces required for integration
  - 4: update positions (integration) for particles assigned to this processor
- 

Like other methods, the import region of the neutral territory method can be modified to take advantage of

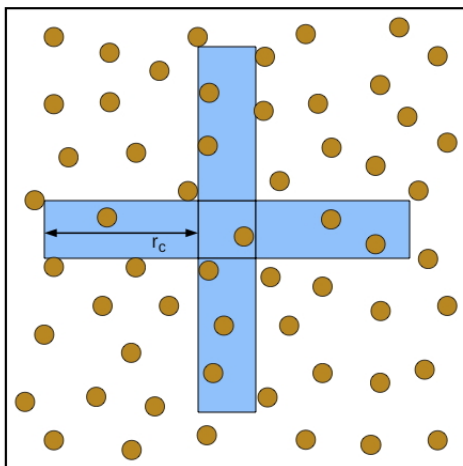

Figure 7.6: Neutral territory method, showing particles in a 2-D computational box and the import region (shaded) for one cell (center square). This Figure can be compared directly to the spatial decomposition case of Fig. 7.5(b). See Shaw [146] for additional details.

Newton's third law. We refer to Shaw [146] for additional details and for illustrations of neutral territory methods in 3-D simulations.

### 7.3 Parallel Fast Fourier Transform

A common component of many methods for computing long-range forces is the 3-D FFT for solving the Poisson equation on a 3-D mesh. The Fourier transform diagonalizes the Poisson operator (called the Laplacian) and one forward and one inverse FFT transformation are required in the solution. Consider the discrete Laplacian operator  $L$  (with periodic boundary conditions) and the solution of  $\phi$  in  $-L\phi = \rho$ . Let  $F$  denote the Fourier transform. The original problem is equivalent to

$$\begin{aligned} -(FLF^{-1})F\phi &= F\rho \\ \phi &= -F^{-1}(FLF^{-1})^{-1}F\rho. \end{aligned}$$

The matrix  $FLF^{-1}$  is diagonal. The forward Fourier transform  $F$  is applied to  $\rho$ , then the Fourier-space components are scaled by the inverse of the diagonal matrix, and finally, the inverse Fourier transform  $F^{-1}$  is applied to obtain the solution  $\phi$ .

For realistic protein sizes, a mesh spacing of approximately 1 Ångstrom is typically used, leading to a 3-D mesh that is quite small by many standards:  $64 \times 64 \times 64$ , or  $128 \times 128 \times 128$ . Parallel computation would often not be applied to a problem of this size, but parallel computation must be used because the data  $\rho$  is already distributed among the parallel processors (assuming a spatial decomposition is used).

A 3-D FFT is computed by computing 1-D FFTs in sequence along each of the three dimensions. For the  $64 \times 64 \times 64$  mesh size, this is 4096 1-D FFTs of dimension 64. The parallel FFT calculation is typically bound by communication. The best parallelization of the FFT depends on the size of the transforms and

the architecture of the computer network. Below, we first describe some concepts for parallel 1-D FFTs and then describe some concepts for parallel 3-D FFTs. For current software and research dedicated to the parallelization and efficient computation (using SIMD operations) of large 1-D transforms, we refer to the SPIRAL and FFTW packages. These packages use autotuning to generate FFT codes that are efficient for the user's computer architecture.

### 7.3.1 Parallel 1-D FFT

#### 7.3.1.1 1-D FFT without Transpose

Fig. 7.7 shows the data dependencies (data flow diagram) between the inputs (left) and outputs (right) for the 16-point radix-2 decimation-in-frequency FFT algorithm. (Not shown is a bit-reversal permutation that may be necessary in the computation.) The Figure also shows a partitioning of the computation among four processors. In this parallelization, the initial data is not moved among processors, but communication occurs during the computation. In the example shown in the Figure, communication occurs in the first two FFT stages; the final two stages do not involve communication. When communication does occur, every processor communicates with exactly one other processor.

#### 7.3.1.2 1-D FFT with Transpose

Use of transposes is common to parallelize FFT computations. Fig. 7.8(a) shows the same data flow diagram as in Fig. 7.7, but horizontal lines have been removed and additional index labels have been added for clarity. As before, the first two FFT stages are performed without communication. The data is then transposed among the processors. With this transposed data layout, the last two FFT stages can be performed without communication. The final data is not in the original order; an additional transpose may be needed, or the data may be used in this transposed order. Fig. 7.8(b) shows how the indices are partitioned among four processors before and after the transpose. From these two Figures, notice that the first two stages have data dependencies that only involve indices in the same partition. The same is true for the second two stages for the partitioning after the transpose. Observe also that the structure of the computations before and after the transpose are identical.

### 7.3.2 Parallel 3-D FFT

#### 7.3.2.1 3-D FFT with Block Decomposition

Fig. 7.9(a) shows a block decomposition of the FFT input data when a spatial decomposition is used for a mesh of size  $8 \times 8 \times 8$  distributed across 64 processors arranged in a  $4 \times 4 \times 4$  topology. The parallel 1-D FFT algorithms can be applied in each of the dimensions. For the example shown in the Figure, each 1-D FFT computation involves 4 processors. Each processor performs multiple 1-D FFTs simultaneously (four in this example). Within each processor, data is ordered contiguously if traversing one of the dimensions, and thus data access is strided for computation in the other two dimensions. Strided data access can be slow, and thus it may be worthwhile to reorder the data within each processor when computing the FFT for each of the dimensions.

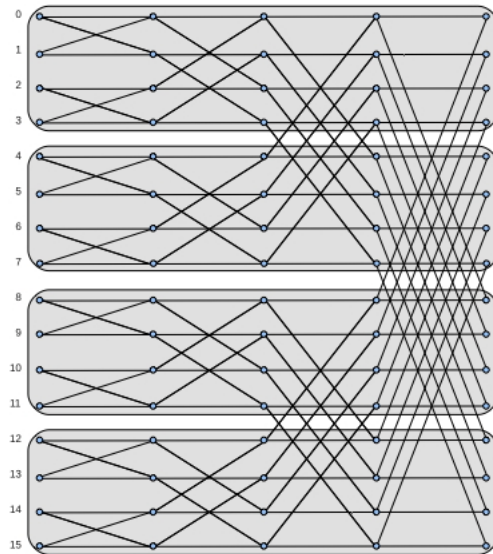

Figure 7.7: Data flow diagram for 1-D FFT for 16 points. The shaded regions show a decomposition for 4 processors (one processor per region). In this parallelization, the first two FFT stages have no communication; the last two FFT stages do have communication.

### 7.3.2.2 3-D FFT with Slab Decomposition

The slab decomposition is shown in Fig. 7.9(b) for the case of 4 processors. Each processor holds one or more planes of the input data. This decomposition is used if the input data is already distributed in slabs, or if it can be easily redistributed this way. The two 1-D FFTs in the plane of the slabs require no communication. The remaining 1-D FFTs require communication and could use one of the two approaches for parallel 1-D FFTs described above. A disadvantage of the slab decomposition is that for large numbers of processors, the number of processors may exceed the number of points in the 3-D FFT along any one dimension. An alternative is the pencil decomposition below.

### 7.3.2.3 3-D FFT with Pencil Decomposition

The pencil decomposition is shown in Fig. 7.9(c) for the case of 16 processors. Each processor holds one or more pencils of the input data. If the original input data is distributed in blocks as in Fig. 7.9(a), then communication among a row of processors (in a 3-D processor mesh) can distribute the data into the pencil decomposition. The 1-D FFTs can then be performed with no communication. To perform the 1-D FFT in another dimension, the data needs to be redistributed into pencils in another dimension. In total, four communication stages are needed for the entire 3-D FFT computation.



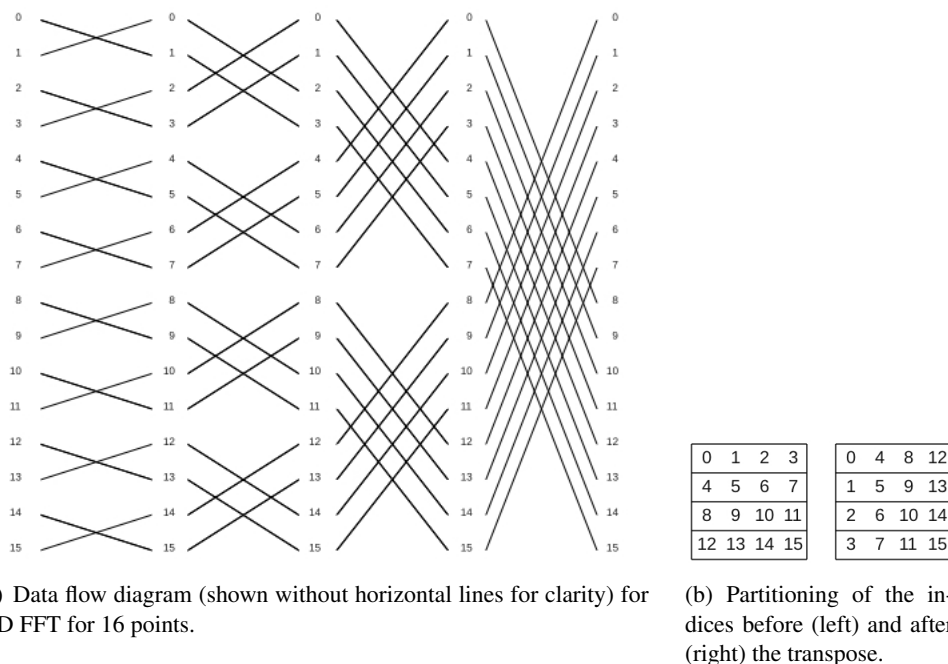

Figure 7.8: 1-D FFT with transpose. The first two stages do not involve communication. The data is then transposed among the processors. As a result, the second two stages also do not involve communication.

## 7.4 Integration for Molecular Dynamics

To numerically integrate the system of ordinary differential equations in molecular dynamics, special methods are required, different than the traditional ODE solvers that were studied in Chapter 4. These special methods, called symplectic methods, are better than other methods at producing solutions that have constant energy, for example, for systems that are called Hamiltonian (which include systems from molecular dynamics). When Hamiltonian systems are integrated with many time steps over a long time interval, preservation of structure such as total energy is often more important than the order of accuracy of the method. In this section, we motivate some ideas and give some details of the Störmer-Verlet method, which is sufficient for simple molecular dynamics simulations.

Hamiltonian systems are a class of dynamical systems which conserve energy and which can be written in a form called Hamilton's equations. Consider, for simplicity, the *simple harmonic oscillator*

$$u'' = -u$$

where  $u$  is the displacement of a single particle from an equilibrium point. This equation could model a particle with unit mass on a spring with unit spring constant. The force on a particle at position  $u$  is  $-u$ . This system does not look like a molecular dynamics system but is useful for illustrating several ideas.

The above second order equation can be written as a system of first order equations

$$\begin{aligned} q' &= p \\ p' &= -q \end{aligned}$$

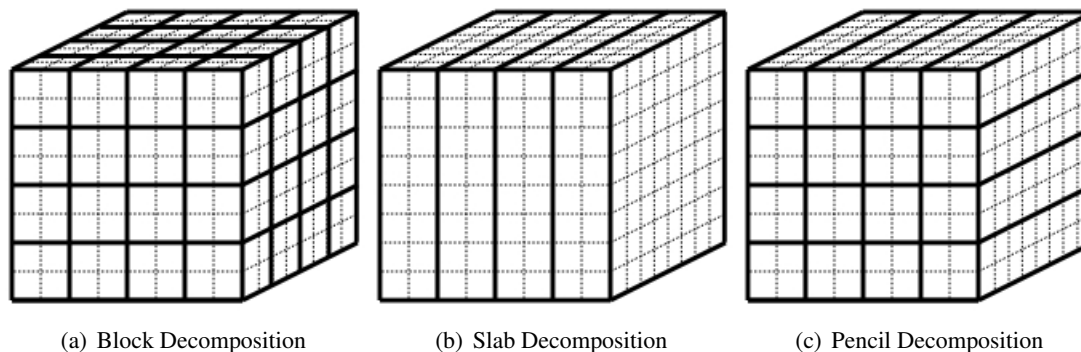

Figure 7.9: Three data decompositions for 3-D FFTs.

where  $q = u$  and  $p = u'$  which is common notation used in classical mechanics. The general solution is

$$\begin{pmatrix} q \\ p \end{pmatrix} = \begin{pmatrix} \cos t & \sin t \\ -\sin t & \cos t \end{pmatrix} \begin{pmatrix} q \\ p \end{pmatrix}.$$

The kinetic energy of the simple harmonic oscillator is  $p^2/2$  and the potential energy is  $q^2/2$  (the negative gradient of potential energy is the force,  $-q$ ). Thus the total energy is proportional to  $q^2 + p^2$ .

Now consider the solution of the system of first order equations by three methods, explicit Euler, implicit Euler, and a method called the Störmer-Verlet method. The initial condition is  $(q, p) = (1, 0)$ . We use a time step of  $h = 0.05$  and take 500 steps. We plot  $q$  and  $p$  on the horizontal and vertical axes, respectively (called a *phase plot*). The exact solution, as given above, is a unit circle centered at the origin.

Figure 7.10 shows the solutions. For explicit Euler, the solution spirals outward, meaning the displacement and momentum of the solution increases over time. The opposite is true for the implicit Euler method. A plot of the total energy would show the energy increasing and decreasing for the two cases, respectively. The solutions are better when smaller time steps are taken or when higher order methods are used, but these methods are not at all appropriate for integration of symplectic systems over long periods of time. Figure 7.10(c) shows the solution using a symplectic method called the Störmer-Verlet method. The solution shows that  $q^2 + p^2$  is preserved much better than in the other two methods.

The Störmer-Verlet method is derived very easily. We derive it for the second order equation

$$u'' = f(t, u)$$

by simply replacing the left-hand side with a finite difference approximation

$$\frac{u_{k+1} - 2u_k + u_{k-1}}{h^2} = f(t_k, u_k)$$

which can be rearranged to obtain the method

$$u_{k+1} = 2u_k - u_{k-1} + h^2 f(t_k, u_k).$$

The formula can equivalently be derived from Taylor series. The method is similar to linear multistep methods in that some other technique is needed to supply the initial step of the method. The method is also

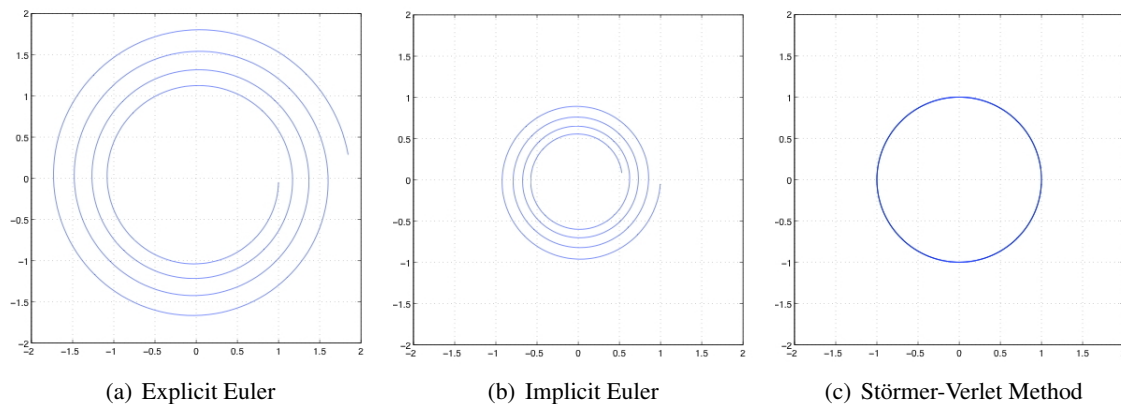

Figure 7.10: Phase plot of the solution of the simple harmonic oscillator for three methods with initial value  $(1,0)$ , time step  $0.05$ , and  $500$  steps. For explicit Euler, the solution spirals outward; for implicit Euler, the solution spirals inward; the total energy is best preserved with the Störmer-Verlet method.

time-reversible, because the formula is the same if  $k+1$  and  $k-1$  are swapped. To explain why this method is symplectic, unfortunately, is beyond the scope of this introduction.

The method as written above has a number of disadvantages, the most severe being that the addition of the small  $h^2$  term is subject to catastrophic cancellation. Thus this formula should not be used in this form, and a number of mathematically equivalent formulas (which can be derived from the formula above) have been developed.

One alternative formula is the *leap-frog* method:

$$\begin{aligned} u_{k+1} &= u_k + hv_{k+1/2} \\ v_{k+1/2} &= v_{k-1/2} + hf(t_k, u_k) \end{aligned}$$

where  $v$  is the first derivative (velocity) which is offset from the displacement  $u$  by a half step. This formula does not suffer from the same roundoff problems and also makes available the velocities, although they need to be re-centered with displacements in order to calculate total energy at a given step. The second of this pair of equations is basically a finite difference formula.

A third form of the Störmer-Verlet method is the *velocity Verlet* variant:

$$\begin{aligned} u_{k+1} &= u_k + hv_k + \frac{h^2}{2} f(t_k, u_k) \\ v_{k+1} &= v_k + \frac{h^2}{2} (f(t_k, u_k) + f(t_{k+1}, u_{k+1})) \end{aligned}$$

where now the velocities are computed at the same points as the displacements. Each of these algorithms can be implemented such that only two sets of quantities need to be stored (two previous positions, or a position and a velocity). These variants of the Störmer-Verlet method are popular because of their simplicity, requiring only one costly force evaluation per step. Higher-order methods have generally not been practical.

The velocity Verlet scheme is also the basis of multiple time step algorithms for molecular dynamics. In these algorithms, the slowly-varying (typically long-range) forces are evaluated less frequently and update the positions less frequently than the quickly-varying (typically short-range) forces. Finally, many state-of-the-art molecular dynamics integrate a Hamiltonian system that has been modified in order to control the simulation temperature and pressure. Much more complicated symplectic methods have been developed for these systems.

## Chapter 8

### Combinatorial algorithms

In this chapter we will briefly consider a few combinatorial algorithms: sorting, and prime number finding with the Sieve of Eratosthenes.

#### 8.1 Sorting

Sorting is not a common operation in scientific computing: one expects it to be more important in databases, whether these be financial or biological (for instance in sequence alignment). However, it sometimes comes up, for instance in *Adaptive Mesh Refinement (AMR)* and other applications where significant manipulations of data structures occurs.

In this section we will briefly look at some basic algorithms and how they can be done in parallel. For more details, see [104] and the references therein.

##### 8.1.1 Brief introduction to sorting

###### 8.1.1.1 Complexity

There are many sorting algorithms. Traditionally, they have been distinguished by their computational complexity, that is, given an array of  $n$  elements, how many operations does it take to sort them, as a function of  $n$ .

Theoretically one can show that a sorting algorithm has to have at least complexity  $O(n \log n)$ <sup>1</sup>. There are indeed several algorithms that are guaranteed to attain this complexity, but a very popular algorithm, called *Quicksort* has only an ‘expected’ complexity of  $O(n \log n)$ , and a worst case complexity of  $O(n^2)$ .

---

1. One can consider a sorting algorithm as a decision tree: a first comparison is made, depending on it two other comparisons are made, et cetera. Thus, an actual sorting becomes a path through this decision tree. If every path has running time  $h$ , the tree has  $2^h$  nodes. Since a sequence of  $n$  elements can be ordered in  $n!$  ways, the tree needs to have enough paths to accomodate all of these; in other words,  $2^h \geq n!$ . Using Stirling’s formula, this means that  $n \geq O(n \log n)$

### 8.1.1.2 Sorting networks

There is another way of looking at sorting algorithms, distinguishing them by whether they work independent of the state of the input data, or not. As an example of an algorithm that depends on its input data, imagine a sorting algorithm that makes a pass over the data to check if it was already sorted. This algorithm has linear complexity (that is,  $n$  operations for  $n$  elements) for a sorted list, and something higher for an unsorted list.

The popular Quicksort algorithm has such data dependencies, since it involves finding ‘pivot’ elements.

On the other hand, the so-called *bubble sort* algorithm can be described independently of the data to be sorted. This algorithm is given by:

```

for  $t$  from  $n - 1$  down to 1 do
  for  $e$  from 1 to  $t$  do
    if elements  $e$  and  $e + 1$  are ordered the wrong way then
      exchange them

```

**Algorithm 2:** The bubble sort algorithm

It is easy to see that this algorithm has a complexity of  $O(n^2)$ : the inner loop does  $t$  comparisons and up to  $t$  exchanges. Summing this from 1 to  $n - 1$  gives approximately  $n^2/2$  comparisons and at most the same number of exchanges.

Such a data-independent sorting algorithm is sometimes called *sorting network*. It can be considered as custom hardware that implements just one algorithm. The basic hardware element is the *compare-and-swap* element, which has two inputs and two outputs. For two inputs  $x, y$  the outputs are  $\max(x, y)$  and  $\min(x, y)$ .

Below we will consider the *Bitonic sort* algorithm as a prime example of a sorting network.

### 8.1.1.3 Parallel complexity

Above we remarked that sorting sequentially takes at least  $O(N \log N)$  time. If we can have perfect speedup, using for simplicity  $P = N$  processors, we would have parallel time  $O(\log N)$ . If the parallel time is more than that, we define the *sequential complexity* as the total number of operations. For instance, below you will see *odd-even transposition sort*, which takes  $N$  steps, giving a sequential complexity of  $N^2$ , and bitonic sort which has a parallel time of  $(\log N)^2$  and a sequential complexity of  $N(\log N)^2$ .

## 8.1.2 Odd-even transposition sort

The *odd-even transposition sort* algorithm is a simple algorithm, with as main virtue that it is easily implemented on a linear area of processors. A single step of the algorithm consists of two substeps:

- Every even-numbered processor does a compare-and-swap with its right neighbour; then
- Every odd-numbered processor does a compare-and-swap with its right neighbour.

**Theorem 2** *After  $N$  steps, each consisting of the two substeps just given, a sequency is sorted.*

With a parallel time of  $2N$ , this gives a sequential complexity  $O(N^2)$ .

### 8.1.3 Quicksort

Quicksort is a recursive algorithm, that, unlike bubble sort, is not deterministic. It is a two step procedure, based on a reordering of the sequence<sup>2</sup>:

**Algorithm:** Dutch National Flag ordering of an array

**Input** : An array of elements, and a ‘pivot’ value

**Output:** The input array with elements ordered as red-white-blue, where red elements are larger than the pivot, white elements are equal to the pivot, and blue elements are less than the pivot

We state without proof that this can be done in  $O(n)$  operations. With this, quicksort becomes:

**Algorithm:** Quicksort

**Input** : An array of elements

**Output:** The input array, sorted

**while** *The array is longer than one element* **do**

    pick an arbitrary value as pivot

    apply the Dutch National Flag reordering to this array

    Quicksort( the blue elements )

    Quicksort( the red elements )

The indeterminacy of this algorithm, and the variance in its complexity, stems from the pivot choice. In the worst case, the pivot is always the (unique) smallest element of the array. There will then be no blue elements, the only white element is the pivot, and the recursive call will be on the array of  $n - 1$  red elements. It is easy to see that the running time will then be  $O(n^2)$ . On the other hand, if the pivot is always (close to) the median, that is, the element that is intermediate in size, then the recursive calls will have an about equal running time, and we get a recursive formula for the running time:

$$T_n = 2T_{n/2} + O(n)$$

which is (again without proof)  $O(n \log n)$ .

We will now consider parallel implementations of quicksort.

#### 8.1.3.1 Quicksort in shared memory

A simple parallelization of the quicksort algorithm can be achieved by executing the two recursive calls in parallel. This is easiest realized with a shared memory model, and threads (section 2.7.1) for the recursive calls. However, this implementation is not efficient.

On an array of length  $n$ , and with perfect pivot choice, there will be  $n$  threads active in the final stage of the algorithm. Optimally, we would want a parallel algorithm to run in  $O(\log n)$  time, but here the time is dominated by the initial reordering of the array by the first thread.

---

2. The name is explained by its origin with the Dutch computer scientist Edsger Dijkstra; see [http://en.wikipedia.org/wiki/Dutch\\_national\\_flag\\_problem](http://en.wikipedia.org/wiki/Dutch_national_flag_problem).

**Exercise 8.1.** Make this argument precise. What is the total running time, the speedup, and the efficiency of parallelizing the quicksort algorithm this way?

Is there a way to make splitting the array more efficient? As it turns out, yes, and the key is to use a parallel *prefix operation*; see appendix 18. If the array of values is  $x_1, \dots, x_n$ , we use a parallel prefix to compute how many elements are less than the pivot  $\pi$ :

$$X_i = \#\{x_j : j < i \wedge x_j < \pi\}.$$

With this, if a processor looks at  $x_i$ , and  $x_i$  is less than the pivot, it needs to be moved to location  $X_i + 1$  in the array where elements are split according to the pivot. Similarly, one would could how many elements there are over the pivot, and move those accordingly.

This shows that each pivoting step can be done in  $O(\log n)$  time, and since there  $\log n$  steps to the sorting algorithm, the total algorithm runs in  $O((\log n)^2)$  time.

### 8.1.3.2 Quicksort on a hypercube

As was apparent from the previous section, for an efficient parallelization of the quicksort algorithm, we need to make the Dutch National Flag reordering parallel too. Let us then assume that the array has been partitioned over the  $p$  processors of a hypercube of dimension  $d$  (meaning that  $p = 2^d$ ).

In the first step of the parallel algorithm, we choose a pivot, and broadcast it to all processors. All processors will then apply the reordering independently on their local data.

In order to bring together the red and blue elements in this first level, every processor is now paired up with one that has a binary address that is the same in every bit but the most significant one. In each pair, the blue elements are sent to the processor that has a 1 value in that bit; the red elements go to the processor that has a 0 value in that bit.

After this exchange (which is local, and therefore fully parallel), the processors with an address  $1xxxxx$  have all the red elements, and the processors with an address  $0xxxxx$  have all the blue elements. The previous steps can now be repeated on the subcubes.

This algorithm keeps all processors working in every step; however, it is susceptible to load imbalance if the chosen pivots are far from the median. Moreover, this load imbalance is not lessened during the sort process.

### 8.1.3.3 Quicksort on a general parallel processor

Quicksort can also be done on any parallel machine that has a linear ordering of the processors. We assume at first that every processor holds exactly one array element, and, because of the flag reordering, sorting will always involve a consecutive set of processors.

Parallel quicksort of an array (or subarray in a recursive call) starts by constructing a binary tree on the processors storing the array. A pivot value is chosen and broadcast through the tree. The tree structure is then used to count on each processor how many elements in the left and right subtree are less than, equal to, or more than the pivot value.



With this information, the root processor can compute where the red/white/blue regions are going to be stored. This information is sent down the tree, and every subtree computes the target locations for the elements in its subtree.

If we ignore network contention, the reordering can now be done in unit time, since each processor sends at most one element. This means that each stage only takes time in summing the number of blue and red elements in the subtrees, which is  $O(\log n)$  on the top level,  $O(\log n/2)$  on the next, et cetera. This makes for almost perfect speedup.

#### 8.1.4 Bitonic sort

To motivate bitonic sorting, suppose a sequence  $x = \langle x_0, \dots, x_{n-1} \rangle$  consists of an ascending followed by a descending part. Now split this sequence into two subsequences of equal length defined by:

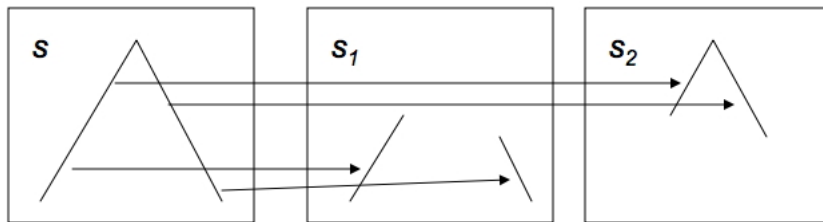

Figure 8.1: Illustration of a splitting a bitonic sequence

$$\begin{aligned} s_1 &= \langle \min\{x_0, x_{n/2}\}, \dots, \min\{x_{n/2-1}, x_{n-1}\} \\ s_2 &= \langle \max\{x_0, x_{n/2}\}, \dots, \max\{x_{n/2-1}, x_{n-1}\} \end{aligned} \quad (8.1)$$

From the picture it is easy to see that  $s_1, s_2$  are again sequences with an ascending and descending part. Moreover, all the elements in  $s_1$  are less than all the elements in  $s_2$ .

We call (8.1) an ascending bitonic sorter, since the second subsequence contains elements larger than in the first. Likewise we can construct a descending sorter by reversing the roles of maximum and minimum.

It's not hard to imagine that this is a step in a sorting algorithm: starting out with a sequence on this form, recursive application of formula (8.1) gives a sorted sequence. Figure 8.2 shows how 4 bitonic sorters, over distances 8,4,2,1 respectively, will sort a sequence of length 16.

The actual definition of a *bitonic sequence* is slightly more complicated. A sequence is bitonic if it consists of an ascending part followed by a descending part, or is a cyclic permutation of such a sequence.

**Exercise 8.2.** Prove that splitting a bitonic sequence according to formula (8.1) gives two bitonic sequences.

So the question is how to get a bitonic sequence. The answer is to use larger and larger bitonic networks.

- A bitonic sort of two elements gives you a sorted sequence.
- If you have two sequences of length two, one sorted up, the other sorted down, that is a bitonic sequence.

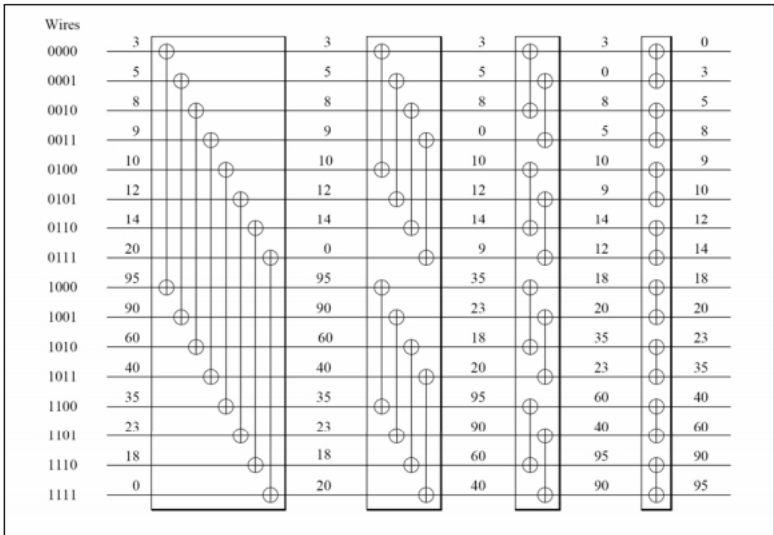

Figure 8.2: Illustration of a bitonic network that sorts a bitonic sequence of length 16

- So this sequence of length four can be sorted in two bitonic steps.
- And two sorted sequences of length four form a bitonic sequence of length;
- which can be sorted in three bitonic steps; et cetera.

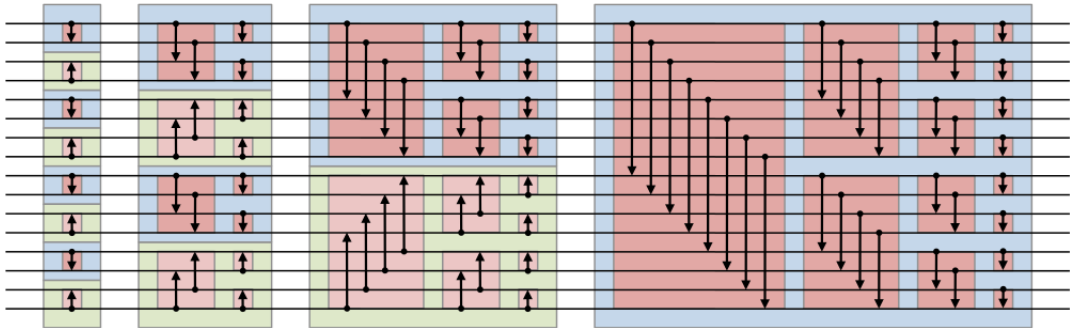

Figure 8.3: Full bitonic sort for 16 elements

From this description you see that you  $\log_2 N$  stages to sort  $N$  elements, where the  $i$ -th stage is of length  $\log_2 i$ . This makes the total *sequential complexity of bitonic sort*  $(\log_2 N)^2$ .

The sequence of operations in figure 8.3 is called a *sorting network*, built up out of simple *compare-and-swap* elements. There is no dependence on the value of the data elements, as is the case with quicksort.

### 8.2 Prime number finding

The *sieve of Eratosthenes* is a very old method for finding prime numbers. In a way, it is still the basis of many more modern methods.

Write down all natural numbers from 2 to some upper bound  $N$ , and we are going to mark these numbers as prime or definitely not-prime. All numbers are initially unmarked.

- The first unmarked number is 2: mark it as prime, and mark all its multiples as not-prime.
- The first unmarked number is 3: mark it as prime, and mark all its multiples as not-prime.
- The next number is 4, but it has been marked already, so mark 5 and its multiples.
- The next number is 6, but it has been marked already, so mark 7 and its multiples.
- Numbers 8,9,10 have been marked, so continue with 11.
- Et cetera.

## Chapter 9

### Graph analytics

Various problems in scientific computing can be formulated as graph problems (for an introduction to graph theory see Appendix 16); for instance, you have encountered the problem of load balancing (section 2.11.1.3) and finding independent sets (section 6.8.2).

Many traditional graph algorithms are not immediately, or at least not efficiently, applicable, since the graphs are often distributed, and traditional graph theory assume global knowledge of the whole graph. Moreover, graph theory is often concerned with finding the optimal algorithm, which is usually not a parallel one. Therefore, parallel graph algorithms are a field of study by themselves.

Recently, new types of graph computations in have arisen in scientific computing. Here the graph are no longer tools, but objects of study themselves. Examples are the *World Wide Web* or the *social graph* of *Facebook*, or the graph of all possible *protein interactions* in a living organism.

For this reason, combinatorial computational science is becoming a discipline in its own right. In this section we look at *graph analytics*: computations on large graphs. We start by discussing some classic algorithms, but we give them in an algebraic framework that will make parallel implementation much easier.

#### 9.1 Traditional graph algorithms

We start by looking at a few ‘classic’ graph algorithms, and we discuss how they can be implemented in parallel. The connection between graphs and sparse matrices (see Appendix 16) will be crucial here: many graph algorithms have the structure of a *sparse matrix-vector multiplication*.

##### 9.1.1 Shortest path algorithms

There are several types of shortest path algorithms. For instance, in the *single source shortest path* algorithm one wants the shortest path from a given node to any other node. In *all-pairs shortest path* algorithms one wants to know the distance between any two nodes. Computing the actual paths is not part of these algorithms; however, it is usually easy to include some information by which the path can be reconstructed later.

We start with a simple algorithm: finding the single source shortest paths in an unweighted graph. This is simple to do with a Breadth-First Search (BFS):

**Input** : A graph, and a starting node  $s$   
**Output**: A function  $d(v)$  that measures the distance from  $s$  to  $v$   
Let  $s$  be given, and set  $d(s) = 0$   
Initialize the finished set as  $U = \{s\}$   
Set  $c = 1$   
**while not finished do**  
    Let  $V$  the neighbours of  $U$  that are not themselves in  $U$   
    **if**  $V = \emptyset$  **then**  
        We're done  
    **else**  
        Set  $d(v) = c + 1$  for all  $v \in V$ .  
         $U \leftarrow U \cup V$   
        Increase  $c \leftarrow c + 1$

This way of formulating an algorithm is useful for theoretical purposes: typically you can formulate a *predicate* that is true for every iteration of the while loop. This then allows you to prove that the algorithm terminates and that it computes what you intended it to compute. And on a traditional processor this would indeed be how you program a graph algorithm. However, these days graphs such as from Facebook can be enormous, and you want to program your graph algorithm in parallel.

In that case, the traditional formulations fall short:

- They are often based on queues to which nodes are added or subtracted; this means that there is some form of shared memory.
- Statements about nodes and neighbours are made without wondering if these satisfy any sort of spatial locality; if a node is touched more than once there is no guarantee of temporal locality.

We will now show that graph algorithms can often be considered as sparse-matrix algorithms, which means that we can apply all the concepts and analysis we have developed for these.

If  $G$  is the *adjacency matrix* of the graph, we can also formulate the shortest path algorithm analogous to a series of matrix-vector multiplications (see appendix section 16.4.4). Let  $x$  be the vector tabulating distances from the source, that is,  $x_i$  is the distance of node  $i$  from the source. For any neighbour  $j$  of  $i$ , the distance to the source is then  $x_i + G_{ij}$ , unless a shorter distance was already known. In other words, we can define a product

$$y^t = x^t G \equiv \forall_i: y_j = \min\{x_j, \min_{i: G_{ij} \neq 0} \{x_i + 1\}\},$$

and the iterations of the above while-loop correspond to subsequent matrix-vector products under this definition.

This algorithm works because we can set  $d(v)$  to its final value the first time we visit it: this happens precisely after a number of outer iterations equal to the path length. The total number of inner loop executions equals the number of edges in the graph. A weighted graph is somewhat trickier, since a path with more

stages can actually be shorter as measured in the sum of the weights of the stages. Here is the Bellman-Ford algorithm:

```

Let  $s$  be given, and set  $d(s) = 0$ 
Set  $d(v) = \infty$  for all other nodes  $v$ 
for  $|E| - 1$  times do
  for all edges  $e = (u, v)$  do
    Relax: if  $d(u) + w_{uv} < d(v)$  then
      Set  $d(v) \leftarrow d(u) + w_{uv}$ 

```

This algorithm is correct since, for a given node  $u$ , after  $k$  steps of the outer iteration it has considered all path  $s \rightarrow u$  of  $k$  stages.

**Exercise 9.1.** What is the complexity of this algorithm? Can the length of the outer loop be reduced if you have some knowledge of the graph?

We can again write this as a series of matrix-vector products, if we define the product as

$$y^t = x^t G \equiv \forall_i: y_j = \min\{x_j, \min_{i: G_{ij} \neq 0} \{x_i + g_{ij}\}\},$$

This has essentially the same basis as above: the minimum distance to  $j$  is minimum of an already computed distance, or the minimum distance to any node  $i$  plus the transition  $g_{ij}$ .

### 9.1.2 Parallelization

Graph algorithms in their traditional formulation can be parallelized. Typically there are macro steps that are sequential, but in which a number of variables are considered independently. Thus there is indeed parallelism to be exploited.

However, these traditional formulations often feature sets of variables that are gradually built up or depleted. This is implementable by using a *task queue*, but this limits the implementation to some form of shared memory. Also, assignment of tasks to processing elements is completely arbitrary, so the algorithm will have little spatial or temporal locality.

For these reasons, a linear algebra formulation can be preferable. We definitely need this approach once distributed memory is considered, but even on multicore architectures it can pay off to encourage locality.

In section 6.5 we discussed the parallel evaluation of the sparse matrix-vector product. Because of the sparsity, only a partitioning by block rows or columns made sense. In effect, we let the partitioning be determined by one of the problem variables. This is also the only strategy that makes sense for single-source shortest path algorithms.

**Exercise 9.2.** Can you make an *a priori* argument for basing the parallelization on a distribution of the vector? How much data is involved in this operation, how much work, and how many sequential steps?

### 9.1.3 Floyd-Warshall all-pairs shortest path

The *Floyd-Warshall algorithm* is an example of an all-pairs shortest paths algorithm. It is a *dynamic programming* algorithm that is based on gradually increasing the set of intermediate nodes for the paths.

Specifically, in step  $k$  all paths  $u \rightsquigarrow v$  are considered that have intermediate nodes in the set  $k = \{0, \dots, k-1\}$ , and  $\Delta_k(u, v)$  is defined as the path length from  $u$  to  $v$  where all intermediate nodes are in  $k$ . Initially, this means that only graph edges are considered, and when  $k \equiv |V|$  we have considered all possible paths and we are done.

The computational step is

$$\Delta_{k+1}(u, v) = \min\{\Delta_k(u, v), \Delta_k(u, k) + \Delta_k(k, v)\}. \quad (9.1)$$

that is, the  $k$ -th estimate for the distance  $\Delta(u, v)$  is the minimum of the old one, and a new path that has become feasible now that we are considering node  $k$ . This latter path is found by concatenating paths  $u \rightsquigarrow k$  and  $k \rightsquigarrow v$ .

Writing it algorithmically:

```
for  $k$  from zero to  $|V|$  do
  for all nodes  $u, v$  do
     $\Delta_{uv} \leftarrow f(\Delta_{uv}, \Delta_{uk}, \Delta_{kv})$ 
```

we see that this algorithm has a similar structure to Gaussian elimination, except that there the inner loop would be ‘for all  $u, v > k$ ’.

Algebraically:

```
for  $k$  from zero to  $|V|$  do
   $D \leftarrow D \cdot_{\min} [D(:, k) \min \cdot + D(k, :)]$ 
```

The Floyd-Warshall algorithm does not tell you the actual path. Storing those paths during the distance calculation above is costly, both in time and memory. A simpler solution is possible: we store a second matrix  $n(i, j)$  that has the highest node number of the path between  $i$  and  $j$ .

**Exercise 9.3.** Include the calculation of  $n(i, j)$  in the Floyd-Warshall algorithm, and describe how to use this to find the shortest path between  $i$  and  $j$  once  $d(\cdot, \cdot)$  and  $n(\cdot, \cdot)$  are known.

**Parallelization** In the single-source shortest path algorithm above we didn’t have much choice but to parallelize by distributing the vector rather than the matrix. This type of distribution is possible here too, and it corresponds to a one-dimensional distribution of the  $D(\cdot, \cdot)$  quantities.

**Exercise 9.4.** Sketch the parallel implementation of this variant of the algorithm. Show that each  $k$ -th iteration involves a broadcast with processor  $k$  as root.

However, this approach runs into the same scaling problems as the matrix-vector product using a one-dimensional distribution of the matrix; see section 6.2.2. Therefore we need to use a two-dimensional distribution.

**Exercise 9.5.** Do the scaling analysis. In a weak scaling scenario with constant memory, what is the asymptotic efficiency?

**Exercise 9.6.** Sketch the Floyd-Warshall algorithm using a two-dimensional distribution of the  $D(\cdot, \cdot)$  quantities.

**Exercise 9.7.** The parallel Floyd-Warshall algorithm performs quite some operations on zeros, certainly in the early stages. Can you design an algorithm that avoids those?

### 9.1.4 Spanning trees

In an undirected graph  $G = \langle V, E \rangle$ , we call  $T \subset E$  a ‘tree’ if it is connected and acyclic. It is called a *spanning tree* if additionally its edges contain all vertices. If the graph has edge weights  $w_i: i \in E$ , the tree has weight  $\sum_{e \in T} w_e$ , and we call a tree a *minimum spanning tree* if it has minimum weight. A minimum spanning tree need not be unique.

*Prim’s algorithm*, a minimal variant of *Dijkstra’s shortest path algorithm*, computes a spanning tree starting at a root. The root has path length zero, and all other nodes infinity. In each step, all nodes connected to the known tree nodes are considered, and their best known path length updated.

```

for all vertices  $v$  do
     $\ell(v) \leftarrow \infty$ 
 $\ell(s) \leftarrow 0$ 
 $Q \leftarrow V - \{s\}$  and  $T \leftarrow \{s\}$ 
while  $Q \neq \emptyset$  do
    let  $u$  be the element in  $Q$  with minimal  $\ell(u)$  value
    remove  $u$  from  $Q$ , and add it to  $T$ 
    for  $v \in Q$  with  $(u, v) \in E$  do
        if  $\ell(u) + w_{uv} < \ell(v)$  then
            Set  $\ell(v) \leftarrow \ell(u) + w_{uv}$ 

```

**Theorem 3** *The above algorithm computes the shortest distance from each node to the root node.*

*Proof.* The key to the correctness of this algorithm is the fact that we choose  $u$  to have minimal  $\ell(u)$  value. Call the true shortest path length to a vector  $L(v)$ . Since we start with an  $\ell$  value of infinity and only ever decrease it, we always have  $L(v) \leq \ell(v)$ .

Our induction hypothesis will be that, at any stage in the algorithm, for the nodes in the current  $T$  the path length is determined correctly:

$$u \in T \Rightarrow L(u) = \ell(u).$$

This is certainly true when the tree consists only of the root  $s$ . Now we need to prove the induction step: if for all nodes in the current tree the path length is correct, then we will also have  $L(u) = \ell(u)$ .

Suppose this is not true, and there is another path that is shorter. This path needs to go through some node  $y$  that is not currently in  $T$ ; this illustrated in figure 9.1. Let  $x$  be the node in  $T$  on the purported shortest path right before  $y$ . Now we have  $\ell(u) > L(u)$  since we do not have the right pathlength yet, and  $L(u) > L(x) + w_{xy}$  since there is at least one edge (which has positive weight) between  $y$  and  $u$ . But  $x \in T$ , so  $L(x) = \ell(x)$  and  $L(x) + w_{xy} = \ell(x) + w_{xy}$ . Now we observe that when  $x$  was added to  $T$  its neighbours were updated, so  $\ell(y)$  is  $\ell(x) + w_{xy}$  or less. Stringing together these inequalities we find

$$\ell(y) < \ell(x) + w_{xy} = L(x) + w_{xy} < L(u) < \ell(u)$$

which contradicts the fact that we choose  $u$  to have minimal  $\ell$  value.



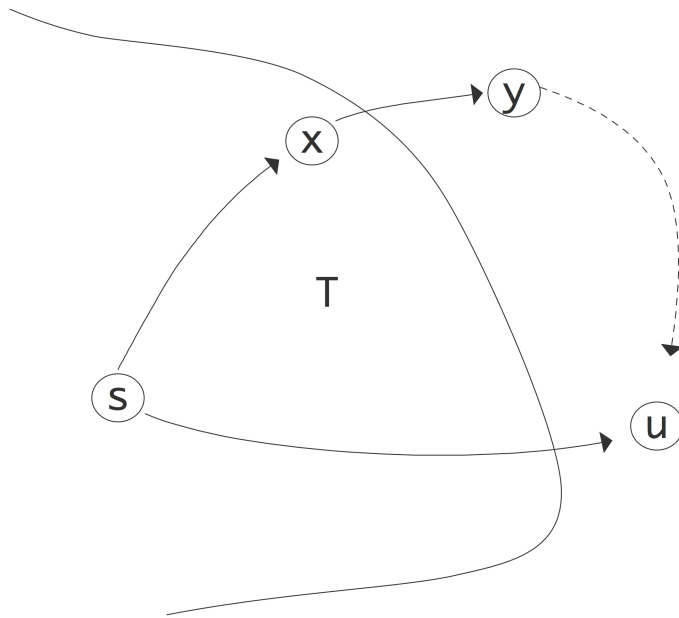

Figure 9.1: Illustration of the correctness of Dijkstra's algorithm

To parallelize this algorithm we observe that the inner loop is independent and therefore easily parallelized. However, the outer loop has a choice that minimizes a function value. Computing this choice is a reduction operator, and subsequently it needs to be broadcast. This strategy makes the sequential time equal to  $d \log P$  where  $d$  is the depth of the spanning tree.

On a single processor, finding the minimum value in an array is naively an  $O(N)$  operation, but through the use of a *priority queue* this can be reduced to  $O(\log N)$ . For the parallel version of the spanning tree algorithm the corresponding term is  $O(\log(N/P))$ , not counting the  $O(\log P)$  cost of the reduction.

## 9.2 'Real world' graphs

In discussions such as in section 4.2.3 you have seen how the discretization of PDEs leads to computational problems that has a graph aspect to them. Such graphs have properties that make them amenable to certain kinds of problems. For instance, using FDMs or FEMs to model two or three-dimensional objects leads graphs where each node is connected to just a few neighbours. This makes it easy to find *separators*, which in turn allows such solution methods as *nested dissection*; see section 6.8.1.

There are however applications with computationally intensive graph problems that do not look like FEM graphs. We will briefly look at the example of the world-wide web, and algorithms such *Google's PageRank* which try to find authoritative nodes.

For now, we will call such graphs *random graphs*, although this term has a technical meaning too [52].

### 9.2.1 Properties of random graphs

The graphs we have seen in most of this course have properties that stem from the fact that they model objects in our three-dimensional world. Thus, the typical distance between two nodes is typically  $O(N^{1/3})$  where  $N$  is the number of nodes. Random graphs do not behave like this: they often have a *small world* property where the typical distance is  $O(\log N)$ . A famous example is the graph of film actors and their connection by having appeared in the same movie: according to ‘Six degrees of separation’, no two actors have a distance more than six in this graph. In graph terms this means that the diameter of the graph is six.

Small-world graphs have other properties, such as the existence of cliques (although these feature too in higher order FEM problems) and hubs: nodes of a high degree. This leads to implications such as the following: deleting a random node in such a graph does not have a large effect on shortest paths.

**Exercise 9.8.** Considering the graph of airports and the routes that exist between them. If there are only hubs and non-hubs, argue that deleting a non-hub has no effect on shortest paths between other airports. On the other hand, consider the nodes ordered in a two-dimensional grid, and delete an arbitrary node. How many shortest paths are affected?

## 9.3 Hypertext algorithms

There are several algorithms based on linear algebra for measuring the importance of web sites [110]. We will briefly define a few and discuss computational implications.

### 9.3.1 HITS

In the HITS (Hypertext-Induced Text Search) algorithm, sites have a *hub* score that measures how many other sites it points to, and an *authority* score that measures how many sites point to it. To calculate such scores we define an *incidence matrix*  $L$ , where

$$L_{ij} = \begin{cases} 1 & \text{document } i \text{ points to document } j \\ 0 & \text{otherwise} \end{cases}$$

The authority scores  $x_i$  are defined as the sum of the hub scores  $y_j$  of everything that points to  $i$ , and the other way around. Thus

$$\begin{aligned} x &= L^t y \\ y &= Lx \end{aligned}$$

or  $x = LL^t x$  and  $y = L^t Ly$ , showing that this is an eigenvalue problem. The eigenvector we need has only nonnegative entries; this is known as the *Perron vector* for a *nonnegative matrix*, see appendix 12.4. The Perron vector is computed by a *power method*; see section 12.3.

A practical search strategy is:

- Find all documents that contain the search terms;

- Build the subgraph of these documents, and possible one or two levels of documents related to them;
- Compute authority and hub scores on these documents, and present them to the user as an ordered list.

### 9.3.2 PageRank

The PageRank [133] basic idea is similar to HITS. Again we define a connectivity matrix

$$M_{ij} = \begin{cases} 1 & \text{if page } j \text{ links to } i \\ 0 & \text{otherwise} \end{cases}$$

With  $e = (1, \dots, 1)$ , the vector  $d^t = e^t M$  counts how many links there are on a page:  $d_i$  is the number of links on page  $i$ . We construct a diagonal matrix  $D = \text{diag}(d_1, \dots)$  we normalize  $M$  to  $T = MD^{-1}$ .

Now the columns sums (that is, the sum of the elements in any column) of  $T$  are all 1, which we can express as  $e^t T = e^t$  where  $e^t = (1, \dots, 1)$ . Such a matrix is called *stochastic matrix*. It has the following interpretation:

If  $p$  is a *probability vector*, that is,  $p_i$  is the probability that the user is looking at page  $i$ , then  $Tp$  is the probability vector after the user has clicked on a random link.

**Exercise 9.9.** Mathematically, a probability vector is characterized by the fact that the sum of its elements is 1. Show that the product of a stochastic matrix and a probability vector is indeed again a probability vector.

The PageRank algorithm now does a mathematical investigation of the question ‘if the user keeps clicking on links that are somehow the most desirable on a page, what will overall be the set of the most desirable links’. In principle this would correspond to taking an arbitrary stochastic vector  $p$ , computing the *power method*  $Tp, T^2p, T^3p, \dots$  and seeing if that sequence converges to something.

There is, however, a small problem with this algorithm. If a page has no outgoing links, a user that would wind up there would never leave. Mathematically this problem also comes up. Consider for instance an web with only 2 pages and the following *adjacency matrix*:

$$A = \begin{pmatrix} 1/2 & 0 \\ 1/2 & 1 \end{pmatrix}.$$

Check for yourself that this corresponds to the second page having no outgoing links. Now let  $p$  be the starting vector  $p^t = (1, 1)$ , and compute a few iterations of the power method. Do you see that the probability of the user being on the second page goes up to 1? The problem here is that we are dealing with a *reducible matrix*.

To prevent this problem, PageRank introduces another element: sometimes the user will get bored from clicking, and will go to an arbitrary page (there are also provisions for pages with no outgoing links). If we call  $s$  the chance that the user will click on a link, then the chance of going to an arbitrary page is  $1 - s$ . Together, we now have the process

$$p' \leftarrow sTp + (1 - s)e,$$

that is, if  $p$  is a vector of probabilities then  $p'$  is a vector of probabilities that describes where the user is after making one page transition, either by clicking on a link or by ‘teleporting’.

The PageRank vector is the stationary point of this process; you can think of it as the probability distribution after the user has made infinitely many transitions. The PageRank vector satisfies

$$p = sTp + (1 - s)e \Leftrightarrow (I - sT)p = (1 - s)e.$$

Thus, we now have to wonder whether  $I - sT$  has an inverse. If the inverse exists it satisfies

$$(I - sT)^{-1} = I + sT + s^2T^2 + \dots$$

It is not hard to see that the inverse exists: with the Gershgorin theorem (appendix 12.5) you can see that the eigenvalues of  $T$  satisfy  $|\lambda| \leq 1$ . Now use that  $s < 1$ , so the series of partial sums converges.

The above formula for the inverse also indicates a way to compute the PageRank vector  $p$  by using a series of matrix-vector multiplications.

**Exercise 9.10.** Write pseudo-code for computing the PageRank vector, given the matrix  $T$ . Show that you never need to compute the powers of  $T$  explicitly. (This is an instance of *Horner’s rule*).

In the case that  $s = 1$ , meaning that we rule out teleportation, the PageRank vector satisfies  $p = Tp$ , which is again the problem of finding the *Perron vector*; see appendix 12.4.

We find the Perron vector by a power iteration (section 12.3)

$$p^{(i+1)} = Tp^{(i)}.$$

This is a sparse matrix vector product, but unlike in the BVP case the sparsity is unlikely to have a structure such as bandedness. Computationally, one probably has to use the same parallelism arguments as for a dense matrix: the matrix has to be distributed two-dimensionally [130].

## 9.4 Large-scale computational graph theory

In the preceding sections you have seen that many graph algorithms have a computational structure that makes the matrix-vector product their most important kernel. Since most graphs are of low degree relative to the number of nodes, the product is a *sparse* matrix-vector product.

In many cases we can then, as in section 6.5, make a one-dimensional distribution of the matrix, induced by a distribution of the graph nodes: if a processor owns a graph node  $i$ , it owns all the edges  $i, j$ .

However, often the computation is very unbalanced. For instance, in the single-source shortest path algorithm only the vertices along the front are active. For this reason, sometimes a distribution of edges rather than vertices makes sense. For an even balancing of the load even random distributions can be used.

The *parallelization of the Floyd-Warshall algorithm* (section 9.1.3) proceeds along different lines. Here we don’t compute a quantity per node, but a quantity that is a function of pairs of nodes, that is, a matrix-like quantity. Thus, instead of distributing the nodes, we distribute the pair distances.

Sometimes we need to go beyond a one-dimensional decomposition in dealing with sparse graph matrices. Let's assume that we're dealing with a graph that has a structure that is more or less random, for instance in the sense that the chance of there being an edge is the same for any pair of vertices. Also assuming that we have a large number of vertices and edges, every processor will then store a certain number of vertices. The conclusion is then that the chance that any pair of processors needs to exchange a message is the same, so the number of messages is  $O(P)$ . (Another way of visualizing this is to see that nonzeros are randomly distributed through the matrix.) This does not give a scalable algorithm.

The way out is to treat this sparse matrix as a dense one, and invoke the arguments from section 6.2.2 to decide on a two-dimensional distribution of the matrix. (See [169] for an application to the BFS problem; they formulate their algorithm in graph terms, but the structure of the 2D matrix-vector product is clearly recognizable.) The two-dimensional product algorithm only needs collectives in processor rows and columns, so the number of processors involved is  $O(\sqrt{P})$ .

## Chapter 10

### N-body problems

In chapter 4 we looked at continuous phenomena, such as the behaviour of a heated rod in the entire interval  $[0, 1]$  over a certain time period. There are also applications where you may be interested in a finite number of points. One such application is the study of collections of particles, possibly very big particles such as planets or stars, under the influence of a force such as gravity or the electrical force. (There can also be external forces, which we will ignore; also we assume there are no collisions, otherwise we need to incorporate nearest-neighbour interactions.) This type of problems is known as N-body problems; for an introduction see [http://www.scholarpedia.org/article/N-body\\_simulations\\_\(gravitational\)](http://www.scholarpedia.org/article/N-body_simulations_(gravitational)).

A basic algorithm for this problem is easy enough:

- choose some small time interval,
- calculate the forces on each particle, given the locations of all the particles,
- move the position of each particle as if the force on it stays constant throughout that interval.

For a small enough time interval this algorithm gives a reasonable approximation to the truth.

The last step, updating the particle positions, is easy and completely parallel: the problem is in evaluating the forces. In a naive way this calculation is simple enough, and even completely parallel:

for each particle  $i$   
  for each particle  $j$   
    let  $\vec{r}_{ij}$  be the vector between  $i$  and  $j$ ;  
    then the force on  $i$  because of  $j$  is  
      
$$f_{ij} = -\vec{r}_{ij} \frac{m_i m_j}{|\vec{r}_{ij}|^2}$$
  
    (where  $m_i, m_j$  are the masses or charges) and  
      
$$f_{ji} = -f_{ij}.$$

The main objection to this algorithm is that it has quadratic computational complexity: for  $N$  particles, the number of operations is  $O(N^2)$ .

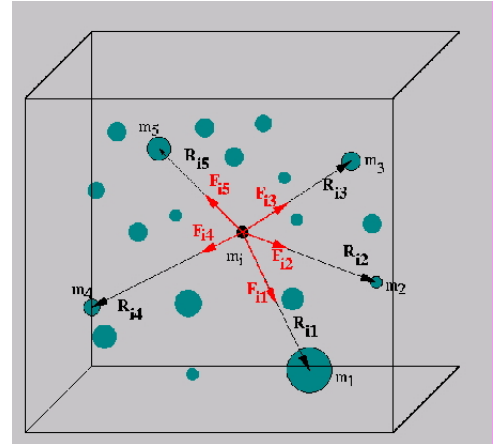

Figure 10.1: Summing all forces on a particle

**Exercise 10.1.** If we had  $N$  processors, the computations for one update step would take time  $O(N)$ . What is the communication complexity? Hint: is there a collective operations you can use?

Several algorithms have been invented to get the sequential complexity down to  $O(N \log N)$  or even  $O(N)$ . As might be expected, these are harder to implement than the naive algorithm. We will discuss a popular method: the *Barnes-Hut algorithm* [5], which has  $O(N \log N)$  complexity.

### 10.1 The Barnes-Hut algorithm

The basic observation that leads to a reduction in complexity is the following. If you are calculating the forces on two particles  $i_1, i_2$  that are close together, coming from two particles  $j_1, j_2$  that are also close together, you can clump  $j_1, j_2$  together into one particle, and use that for both  $i_1, i_2$ .

Next, the algorithm uses a recursive division of space, in two dimensions in quadrants and in three dimensions in octants; see figure 10.2.

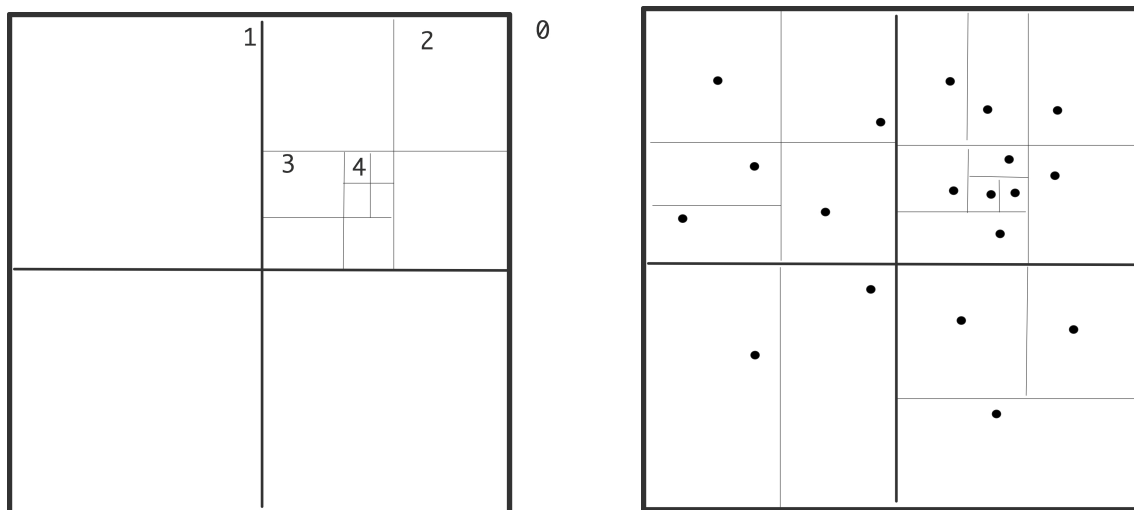

Figure 10.2: Recursive subdivision of a domain in quadrants with levels indicated (left); actual subdivision with one particle per box (right)

The algorithm is then as follows. First total mass and center of mass are computed for all cells on all levels:

```

for each level  $\ell$ , from fine to coarse:
  for each cell  $c$  on level  $\ell$ :
    compute the total mass and center of mass
      for cell  $c$  by considering its children
    if there are no particles in this cell,
      set its mass to zero
  
```

Then the levels are used to compute the interaction with each particle:

```

for each particle  $p$ :
  for each cell  $c$  on the top level
    if  $c$  is far enough away from  $p$ :
      use the total mass and center of mass of  $c$ ;
    otherwise consider the children of  $c$ 

```

The test on whether a cell is far enough away is typically implemented as the ratio of its diameter to its distance being small enough. This is sometimes referred to as the ‘cell opening criterium’. In this manner, each particle interacts with a number of concentric rings of cells, each next ring of double width; see figure 10.3.

This algorithm is easy to realize if the cells are organized in a tree. In the three-dimensional case, each cell has eight children, so this is known as an *octtree*.

The computation of centres of masses has to be done each time after the particles move. Updating can be less expensive than computing from scratch. Also, it can happen that a particle crosses a cell border, in which case the data structure needs to be updated. In the worst case, a particle moves into a cell that used to be empty.

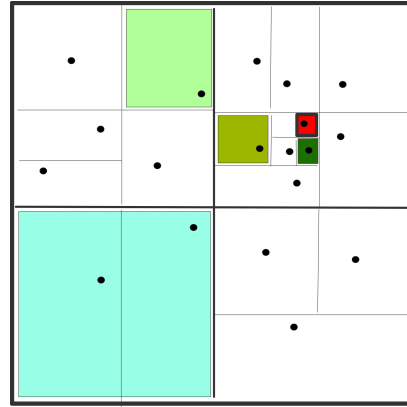

Figure 10.3: Boxes with constant distance/diameter ratio

## 10.2 The Fast Multipole Method

The *Fast Multipole Method (FMM)* computes an expression for the potential at every point, not the force as does Barnes-Hut. FMM uses more information than the mass and center of the particles in a box. This more complicated expansion is more accurate, but also more expensive. In compensation, the FMM uses a fixed set of boxes to compute the potential, rather than a set varying with the accuracy parameter  $\theta$ , and location of the center of mass.

However, computationally the FMM is much like the Barnes-Hut method so we will discuss their implementation jointly.

## 10.3 Full computation

Despite the above methods for judicious approximation, there are also efforts at full calculation of the  $N^2$  interactions; see for instance the *NBODY6* code of Sverre Aarseth; see <http://www.ast.cam.ac.uk/~sverre/web/pages/home.htm>. Such codes use high order integrators and adaptive time steps. Fast implementation on the *Grape computer* exist; general parallelization is typically hard because of the need for regular load balancing.



## 10.4 Implementation

Octree methods offer some challenges on high performance architectures. First of all, the problem is irregular, and secondly, the irregularity dynamically changes. The second aspect is mostly a problem in distributed memory, and it needs *load rebalancing*; see section 2.11.1. In this section we concentrated on the force calculation in a single step.

### 10.4.1 Vectorization

The structure of a problem as in figure 10.2 is quite irregular. This is a problem for vectorization on the small scale of SSE/AVX instructions and on the large scale of vector pipeline processors (see section 2.4.1 for an explanation of both). Program steps ‘for all children of a certain box do something’ will be of irregular length, and data will possibly be not stored in a regular manner.

This problem can be alleviated by subdividing the grid even if this means having empty boxes. If the bottom level is fully divided, there will always be eight (in three dimension) particles to operate on. Higher levels can also be filled in, but this means an increasing number of empty boxes on the lower levels, so there is a trade-off between increased work and increasing efficiency.

### 10.4.2 Shared memory implementation

Executed on a sequential architecture, this algorithm has complexity  $O(N \log N)$ . It is clear that this algorithm will also work on shared memory if each particle is turned into a task. Since not all cells contain particles, tasks will have a different running time.

### 10.4.3 Distributed memory implementation

The above shared-memory version of the Barnes-Hut algorithm can not immediately be used in a distributed memory context, since each particle can in principle access information from any part of the total data. It is possible to realize an implementation along these lines using a *hashed octree*, but we will not pursue this.

We observe data access is more structured than it seems at first. Consider a particle  $p$  and the cells on level  $\ell$  that it interacts with. Particles located close to  $p$  will interact with the same cells, so we can rearrange interaction by looking at cells on level  $\ell$  and the other cells on the same level that they interact with.

This gives us the following algorithm [97]: the calculation of centres of mass become a calculation of the force  $g_p^{(\ell)}$  exerted by a particle  $p$  on level  $\ell$ :

```
for level  $\ell$  from one above the finest to the coarsest:
  for each cell  $c$  on level  $\ell$ 
    let  $g_c^{(\ell)}$  be the combination of the  $g_i^{(\ell+1)}$  for all children  $i$  of  $c$ 
```

With this we compute the force on a cell:

```
for level  $\ell$  from one below the coarses to the finest:
  for each cell  $c$  on level  $\ell$ :
    let  $f_c^{(\ell)}$  be the sum of
```

1. the force  $f_p^{(\ell-1)}$  on the parent  $p$  of  $c$ , and
2. the sums  $g_i^{(\ell)}$  for all  $i$  on level  $\ell$  that satisfy the cell opening criterium

We see that on each level, each cell now only interacts with a small number of neighbours on that level. In the first half of the algorithm we go up the tree using only parent-child relations between cells. Presumably this is fairly easy.

The second half of the algorithm uses more complicated data access. The cells  $i$  in the second term are all at some distance from the cell  $c$  on which we are computing the force. In graph terms these cells can be described as cousins: children of a sibling of  $c$ 's parent. If the opening criterium is made sharper, we use second cousins: grandchildren of the sibling of  $c$ 's grandparent, et cetera.

**Exercise 10.2.** Argue that this force calculation operation has much in common, structurally, with the sparse matrix-vector product.

In the shared memory case we already remarked that different subtrees take different time to process, but, since we are likely to have more tasks than processor cores, this will all even out. With distributed memory we lack the possibility to assign work to arbitrary processors, so we need to assign load carefully. Space-Filling Curves (SFCs) can be used here to good effect (see section [2.11.1.5](#)).

## Chapter 11

### Monte Carlo Methods

Monte Carlo simulation is a broad term for methods that use random numbers and statistical sampling to solve problems, rather than exact modeling. From the nature of this sampling, the result will have some uncertainty, but the statistical ‘law of large numbers’ will ensure that the uncertainty goes down as the number of samples grows.

#### 11.1 Motivation

Let’s start with a simple example: measuring an area, for instance,  $\pi$  is the area of a circle inscribed in a square with sides 2. If you picked a random point in the square, the chance of it falling in the circle is  $\pi/4$ , so you could estimate this ratio by taking many random points  $(x, y)$  and seeing in what proportion their length  $\sqrt{x^2 + y^2}$  is less than 1.

You could even do this as a physical experiment: suppose you have a pond of an irregular shape in your backyard, and that the yard itself is rectangular with known dimensions. If you would now throw pebbles into your yard so that they are equally likely to land at any given spot, then the ratio of pebbles falling in the pond to those falling outside equals the ratio of the areas.

Less fanciful and more mathematically, we need to formalize the idea of falling inside or outside the shape you are measuring. Therefore, let  $\Omega \in [0, 1]^2$  be the shape, and let a function  $f(\bar{x})$  describe the boundary of  $\Omega$ , that is

$$\begin{cases} f(\bar{x}) < 0 & x \notin \Omega \\ f(\bar{x}) > 0 & x \in \Omega \end{cases}$$

Now take random points  $\bar{x}_0, \bar{x}_1, \bar{x}_2 \in [0, 1]^2$ , then we can estimate the area of  $\Omega$  by counting how often  $f(\bar{x}_i)$  is positive or negative.

We can extend this idea to integration. The average value of a function on an interval  $(a, b)$  is defined as

$$\langle f \rangle = \frac{1}{b-a} \int_a^b f(x) dx$$

On the other hand, we can also estimate the average as

$$\langle f \rangle \approx \frac{1}{N} \sum_{i=1}^n f(x_i)$$

if the points  $x_i$  are reasonably distributed and the function  $f$  is not too wild. This leads us to

$$\int_a^b f(x) dx \approx (b-a) \frac{1}{N} \sum_{i=1}^n f(x_i)$$

Statistical theory, that we will not go into, tells us that the uncertainty  $\sigma_I$  in the integral is related to the standard deviation  $\sigma_f$  by

$$\sigma_I \sim \frac{1}{\sqrt{N}} \sigma_f$$

for normal distributions.

### 11.1.1 What is the attraction?

So far, Monte Carlo integration does not look much different from classical integration by *Riemann sums*. The difference appears when we go to higher dimensions. In that case, for classical integration we would need  $N$  points in each dimension, leading to  $N^d$  points in  $d$  dimensions. In the Monte Carlo method, on the other hand, the points are taken at random from the  $d$ -dimensional space, and a much lower number of points suffices.

Computationally, Monte Carlo methods are attractive since all function evaluations can be performed in parallel.

The statistical law that underlies this is as follows: if  $N$  independent observations are made of a quantity with standard deviation  $\sigma$ , then the standard deviation of the mean is  $\sigma/\sqrt{N}$ . This means that more observations will lead to more accuracy; what makes Monte Carlo methods interesting is that this gain in accuracy is not related to dimensionality of the original problem.

Monte Carlo techniques are of course natural candidates for simulating phenomena that are statistical in nature, such as radioactive decay, or Brownian motion. Other problems where Monte Carlo simulation is attractive are outside the realm of scientific computing. For instance, the *Black-Scholes model* for stock option pricing [11] uses Monte Carlo simulation.

Some problems that you have seen before, such as solving a linear system of equations, can be tackled with Monte Carlo techniques. However, this is not a typical application. Below we will discuss two applications where exact methods would take far too much time to compute and where statistical sampling can quickly give a reasonably accurate answer.

An important tool for statistical sampling is a random number generator. We start by briefly discussing the problems in generating random numbers, especially in parallel.

## 11.2 Parallel Random Number Generation

Random numbers are often used in simulations as some examples below will show. True random numbers are very hard to obtain: they could be generated by measuring quantum processes such as radioactive particles, but this is very cumbersome. Instead, we use *pseudo-random numbers*. This means that we use a deterministic mathematical process, that is sufficiently irregular that for practical purposes no order can be found in it.

### 11.2.1 Sequential random number generators

An easy way to generate random numbers (we leave off the ‘pseudo’ qualification) is to use *linear congruential* generators (for all you ever need to know about random numbers, see Knuth [99]), recurrences of the form

$$x_{k+1} = (ax_k + b) \pmod{m}.$$

This sequence is periodic, since it consists of nonnegative integers at most  $m - 1$ , and with period  $m$  under certain conditions. A typical period is  $2^{31}$ . The starting point  $x_0$  of the series is known as the ‘seed’. Software for random numbers often lets you specify the seed. To get reproducible results you would run your program with the same seed multiple times; to get random behaviour over multiple runs of your program you could for instance derive the seed from clock and calendar functions.

Linear congruential generators may have some amount of correlation between lower bits. A different principle of generating random numbers is the *lagged Fibonacci* random number generator

$$X_i = X_{i-p} \otimes X_{i-q}$$

where  $p, q$  are the lag parameter, and  $\otimes$  is any binary operation, such as addition or multiplication modulo  $M$ .

The main problems with lagged Fibonacci generators are:

- They require setting  $\max(p, q)$  initial values, and their randomness is sensitive to these choices;
- Their theory is not as developed as for congruential generators, so there is a greater reliance on statistical tests to evaluate their ‘randomness’.

### 11.2.2 Parallel random number generation

Random number generation is problematic in parallel. To see this, consider a parallel process that uses a random number generator on each subprocess, and consider a single processor emulating the parallel process. Now this single process in effect has a random number generator that consists of interleaving the parallel generator results. This means that, if we use the same generator in all parallel processes, the effective generator over the whole process will produce stretches of identical values.

There are various ways out.

### 11.2.2.1 Master-worker generator

We can generate the random numbers centrally. In shared memory that could mean making its operation atomic. This may introduce a serious bottleneck.

**Exercise 11.1.** Critical sections are usually justified if the work spent there is of lower order than the parallel work. Why does that argument not apply here.

Another solution would be to have one thread or process that generates the random numbers and distributes them to the other processes. Doing this on a number-by-number basis causes considerable overhead. Instead, it would be possible for the generator process to distribute blocks of numbers. However, the manner in which this is done may again cause correlation between processes.

### 11.2.2.2 Sequence splitting solutions

A better solution is to set up independent generators with parameter choices that guarantee statistical randomness. This is not simple. For instance, if two sequences  $x_i^{(1)}, x_i^{(2)}$  have the same values of  $a, b, m$ , and their starting points are close together, the sequences will be strongly correlated. Less trivial examples of correlation exist.

Various techniques for random number generation exist, such as using two sequences, where one generates the starting points for the other sequence, which is the one actually used in the simulation. Software for parallel random number generator can be found at <http://sprng.cs.fsu.edu/> [120].

### 11.2.2.3 Blocked random number generators

Some random number generators (see [112]) allow you to calculate a value that is many iteration away from the seed. You could then take the block of values from the seed to that iteration and give it to one processor. Similarly, each processor would get a contiguous block of iterations of the generator.

## 11.3 Examples

### 11.3.1 Monte Carlo simulation of the Ising model

The Ising model (for an introduction, see [28]) was originally proposed to model ferromagnetism. Magnetism is the result of atoms aligning their ‘spin’ direction: let’s say spin can only be ‘up’ or ‘down’, then a material has magnetism if more atoms have spin up than down, or the other way around. The atoms are said to be in a structure called a ‘lattice’.

Now imagine heating up a material, which loosens up the atoms. If an external field is applied to the material, the atoms will start aligning with the field, and if the field is removed the magnetism disappears again. However, below a certain critical temperature the material will retain its magnetism. We will use Monte Carlo simulation to find the stable configurations that remain.

Let’s say the lattice  $\Lambda$  has  $N$  atoms, and we denote a configuration of atoms as  $\sigma = (\sigma_1, \dots, \sigma_N)$  where each  $\sigma_i = \pm 1$ . The energy of a lattice is modeled as

$$H = H(\sigma) = -J \sum_i \sigma_i - E \sum_{ij} \sigma_i \sigma_j.$$

The first term models the interaction of individual spins  $\sigma_i$  with an external field of strength  $J$ . The second term, which sums over nearest neighbour pairs, models alignment of atom pairs: the product  $\sigma_i\sigma_j$  is positive if the atoms have identical spin, and negative if opposite.

In *statistical mechanics*, the probability of a configuration is

$$P(\sigma) = \exp(-H(\sigma))/Z$$

where the ‘partitioning function’  $Z$  is defined as

$$Z = \sum_{\sigma} \exp(H(\sigma))$$

where the sum runs over all  $2^N$  configurations.

A configuration is stable if its energy does not decrease under small perturbations. To explore this, we iterate over the lattice, exploring whether altering the spin of atoms lowers the energy. We introduce an element of chance to prevent artificial solutions. (This is the *Metropolis algorithm* [123].)

```
for fixed number of iterations do  
  for each atom  $i$  do  
    calculate the change  $\Delta E$  from changing the sign of  $\sigma_i$   
    if  $\Delta E < \text{or } \exp(-\Delta E)$  greater than some random number then  
      accept the change
```

This algorithm can be parallelized, if we notice the similarity with the structure of the sparse matrix-vector product. In that algorithm too we compute a local quantity by combining inputs from a few nearest neighbours. This means we can partition the lattice, and compute the local updates after each processor collects a *ghost region*.

Having each processor iterate over local points in the lattice corresponds to a particular global ordering of the lattice; to make the parallel computation equivalent to a sequential one we also need a parallel random generator (section 11.2).

**PART III**

**APPENDICES**



---

This course requires no great mathematical sophistication. Mostly it assumes that you know the basics of linear algebra: what are matrices and vectors, and the most common operations on them.

In the following appendices we will cover some less common bits of theory that have been moved out of the main storyline of the preceding chapters.

## Chapter 12

### Linear algebra

In this course it is assumed that you know what a matrix and a vector are, simple algorithms such as how to multiply them, and some properties such as invertibility of a matrix. This appendix introduces some concepts and theorems that are not typically part of a first course in linear algebra.

#### 12.1 Norms

A *norm* is a way to generalize the concept of absolute value to multi-dimensional objects such as vectors and matrices. There are many ways of defining a norm, and there is theory of how different norms relate. Here we only give the basic definitions; for more detail see any linear algebra textbook, for instance [70].

##### 12.1.1 Vector norms

A norm is any function  $n(\cdot)$  on a vector space  $V$  with the following properties:

- $n(x) \geq 0$  for all  $x \in V$  and  $n(x) = 0$  only for  $x = 0$ ,
- $n(\lambda x) = |\lambda|n(x)$  for all  $x \in V$  and  $\lambda \in \mathbb{R}$ .
- $n(x + y) \leq n(x) + n(y)$

For any  $p \geq 1$ , the following defines a vector norm:

$$\|x\|_p = \sqrt[p]{\sum_i |x_i|^p}.$$

Common norms are  $\|\cdot\|_1$  ('sum of absolute values') and  $\|\cdot\|_2$  ('square root of sum of squares'); the  $\|\cdot\|_\infty$  norm is defined as  $\lim_{p \rightarrow \infty} \|\cdot\|_p$ , and it is not hard to see that this equals

$$\|x\|_\infty = \max_i |x_i|.$$

### 12.1.2 Matrix norms

By considering a matrix of size  $n$  as a vector of length  $n^2$ , we can define the Frobenius matrix norm:

$$\|A\|_F = \sqrt{\sum_{i,j} |a_{ij}|^2}.$$

However, we will mostly look at *associated matrix norms*:

$$\|A\|_p = \sup_{\|x\|_p=1} \|Ax\|_p = \sup_x \frac{\|Ax\|_p}{\|x\|_p}.$$

From their definition, it easily follows that

$$\|Ax\| \leq \|A\| \|x\|$$

for associated norms.

The following are easy to derive:

- $\|A\|_1 = \max_j \sum_i |a_{ij}|$ ,
- $\|A\|_\infty = \max_i \sum_j |a_{ij}|$ .

By observing that  $\|A\|_2 = \sup_{\|x\|_2=1} x^t A^t A x$ , it is not hard to derive that  $\|A\|_2$  is the maximal singular value of  $A$ , which is the root of the maximal eigenvalue of  $A^t A$ .

The matrix *condition number* is defined as

$$\kappa(A) = \|A\| \|A^{-1}\|.$$

In the symmetric case, and using the 2-norm, this is the ratio between the largest and smallest eigenvalue.

## 12.2 Gram-Schmidt orthogonalization

The Gram-Schmidt (GS) algorithm takes a series of vectors and inductively orthogonalizes them. This can be used to turn an arbitrary basis of a vector space into an orthogonal basis; it can also be viewed as transforming a matrix  $A$  into one with orthogonal columns. If  $Q$  has orthogonal columns,  $Q^t Q$  is diagonal, which is often a convenient property to have.

The basic principle of the GS algorithm can be demonstrated with two vectors  $u, v$ . Suppose we want a vector  $v'$  so that  $u, v$  and  $u, v'$  span the same space, but  $v' \perp u$ . For this we let

$$v' \leftarrow v - \frac{u^t v}{u^t u} u.$$

It is easy to see that this satisfies the requirements.

Suppose we have an set of vectors  $u_1, \dots, u_n$  that we want to orthogonalize. We do this by successive applications of the above transformation:

For  $i = 1, \dots, n$ :  
 For  $j = 1, \dots, i - 1$ :  
   let  $c_{ji} = u_j^t u_i / u_j^t u_j$   
 For  $i = 1, \dots, n$ :  
   update  $u_i \leftarrow u_i - u_j c_{ji}$

Often the vector  $v$  in the algorithm above is normalized; this adds a line

$$u_i \leftarrow u_i / \|u_i\|$$

to the algorithm. GS orthogonalization with this normalization, applied to a matrix, is also known as the *QR factorization*.

**Exercise 12.1.** Suppose that we apply the GS algorithm to the columns of a rectangular matrix  $A$ , giving a matrix  $Q$ . Prove that there is an upper triangular matrix  $R$  such that  $A = QR$ . (Hint: look at the  $c_{ji}$  coefficients above.) If we normalize the orthogonal vector in the algorithm above,  $Q$  has the additional property that  $Q^t Q = I$ . Prove this too.

The GS algorithm as given above computes the desired result, but only in exact arithmetic. A computer implementation can be quite inaccurate if the angle between  $v$  and one of the  $u_i$  is small. In that case, the Modified Gram-Schmidt (MGS) algorithm will perform better:

For  $i = 1, \dots, n$ :  
 For  $j = 1, \dots, i - 1$ :  
   let  $c_{ji} = u_j^t u_i / u_j^t u_j$   
   update  $u_i \leftarrow u_i - u_j c_{ji}$

To contrast it with MGS, the original GS algorithm is also known as Classical Gram-Schmidt (CGS).

As an illustration of the difference between the two methods, consider the matrix

$$A = \begin{pmatrix} 1 & 1 & 1 \\ \epsilon & 0 & 0 \\ 0 & \epsilon & 0 \\ 0 & 0 & \epsilon \end{pmatrix}$$

where  $\epsilon$  is of the order of the machine precision, so that  $1 + \epsilon^2 = 1$  in machine arithmetic. The CGS method proceeds as follows:

- The first column is of length 1 in machine arithmetic, so

$$q_1 = a_1 = \begin{pmatrix} 1 \\ \epsilon \\ 0 \\ 0 \end{pmatrix}.$$

- The second column gets orthogonalized as  $v \leftarrow a_2 - 1 \cdot q_1$ , giving

$$v = \begin{pmatrix} 0 \\ -\epsilon \\ \epsilon \\ 0 \end{pmatrix}, \quad \text{normalized: } q_2 = \begin{pmatrix} 0 \\ -\frac{\sqrt{2}}{2} \\ \frac{\sqrt{2}}{2} \\ 0 \end{pmatrix}$$

- The third column gets orthogonalized as  $v \leftarrow a_3 - c_1 q_1 - c_2 q_2$ , where

$$\begin{cases} c_1 = q_1^t a_3 = 1 \\ c_2 = q_2^t a_3 = 0 \end{cases} \Rightarrow v = \begin{pmatrix} 0 \\ -\epsilon \\ 0 \\ \epsilon \end{pmatrix}; \quad \text{normalized: } q_3 = \begin{pmatrix} 0 \\ \frac{\sqrt{2}}{2} \\ 0 \\ \frac{\sqrt{2}}{2} \end{pmatrix}$$

It is easy to see that  $q_2$  and  $q_3$  are not orthogonal at all. By contrast, the MGS method differs in the last step:

- As before,  $q_1^t a_3 = 1$ , so

$$v \leftarrow a_3 - q_1 = \begin{pmatrix} 0 \\ -\epsilon \\ \epsilon \\ 0 \end{pmatrix}.$$

Then,  $q_2^t v = \frac{\sqrt{2}}{2} \epsilon$  (note that  $q_2^t a_3 = 0$  before), so the second update gives

$$v \leftarrow v - \frac{\sqrt{2}}{2} \epsilon q_2 = \begin{pmatrix} 0 \\ \frac{\epsilon}{2} \\ -\frac{\epsilon}{2} \\ \epsilon \end{pmatrix}, \quad \text{normalized: } \begin{pmatrix} 0 \\ \frac{\sqrt{6}}{6} \\ -\frac{\sqrt{6}}{6} \\ 2\frac{\sqrt{6}}{6} \end{pmatrix}$$

Now all  $q_i^t q_j$  are on the order of  $\epsilon$  for  $i \neq j$ .

### 12.3 The power method

The vector sequence

$$x_i = Ax_{i-1},$$

where  $x_0$  is some starting vector, is called the *power method* since it computes the product of subsequent matrix powers times a vector:

$$x_i = A^i x_0.$$

There are cases where the relation between the  $x_i$  vectors is simple. For instance, if  $x_0$  is an eigenvector of  $A$ , we have for some scalar  $\lambda$

$$Ax_0 = \lambda x_0 \quad \text{and} \quad x_i = \lambda^i x_0.$$

However, for an arbitrary vector  $x_0$ , the sequence  $\{x_i\}_i$  is likely to consist of independent vectors. Up to a point.

Exercise 12.2. Let  $A$  and  $x$  be the  $n \times n$  matrix and dimension  $n$  vector

$$A = \begin{pmatrix} 1 & 1 & & & \\ & 1 & 1 & & \\ & & \ddots & \ddots & \\ & & & 1 & 1 \\ & & & & 1 \end{pmatrix}, \quad x = (0, \dots, 0, 1)^t.$$

Show that the sequence  $[x, Ax, \dots, A^i x]$  is an independent set for  $i < n$ . Why is this no longer true for  $i \geq n$ ?

Now consider the matrix  $B$ :

$$B = \left( \begin{array}{cccc|cccc} 1 & 1 & & & & & & \\ & \ddots & \ddots & & & & & \\ & & 1 & 1 & & & & \\ & & & 1 & & & & \\ & & & & 1 & & & \\ \hline & & & & & 1 & 1 & \\ & & & & & & \ddots & \ddots \\ & & & & & & & 1 & 1 \\ & & & & & & & & 1 \end{array} \right), \quad y = (0, \dots, 0, 1)^t$$

Show that the set  $[y, By, \dots, B^i y]$  is an independent set for  $i < n/2$ , but not for any larger values of  $i$ .

While in general the vectors  $x, Ax, A^2x, \dots$  can be expected to be independent, in computer arithmetic this story is no longer so clear.

Suppose the matrix has eigenvalues  $\lambda_0 > \lambda_1 \geq \dots \geq \lambda_{n-1}$  and corresponding eigenvectors  $u_i$  so that

$$Au_i = \lambda_i u_i.$$

Let the vector  $x$  be written as

$$x = c_0 u_0 + \dots + c_{n-1} u_{n-1},$$

then

$$A^i x = c_0 \lambda_0^i u_0 + \dots + c_{n-1} \lambda_{n-1}^i u_{n-1}.$$

If we write this as

$$A^i x = \lambda_0^i \left[ c_0 u_0 + c_1 \left( \frac{\lambda_1}{\lambda_0} \right)^i + \dots + c_{n-1} \left( \frac{\lambda_{n-1}}{\lambda_0} \right)^i \right],$$

we see that, numerically,  $A^i x$  will get progressively closer to a multiple of  $u_0$ , the *dominant eigenvector*. Hence, any calculation that uses independence of the  $A^i x$  vectors is likely to be inaccurate.

### 12.4 Nonnegative matrices; Perron vectors

If  $A$  is a nonnegative matrix, the maximal eigenvalue has the property that its eigenvector is nonnegative: this is the the *Perron-Frobenius theorem*.

**Theorem 4** *If a nonnegative matrix  $A$  is irreducible, its eigenvalues satisfy*

- *The eigenvalue  $\alpha_1$  that is largest in magnitude is real and simple:*

$$\alpha_1 > |\alpha_2| \geq \dots$$

- *The corresponding eigenvector is positive.*

### 12.5 The Gershgorin theorem

Finding the eigenvalues of a matrix is usually complicated. However, there are some tools to estimate eigenvalues. In this section you will see a theorem that, in some circumstances, can give useful information on eigenvalues.

Let  $A$  be a square matrix, and  $x, \lambda$  an eigenpair:  $Ax = \lambda x$ . Looking at one component, we have

$$a_{ii}x_i + \sum_{j \neq i} a_{ij}x_j = \lambda x_i.$$

Taking norms:

$$(a_{ii} - \lambda) \leq \sum_{j \neq i} |a_{ij}| \left| \frac{x_j}{x_i} \right|$$

Taking the value of  $i$  for which  $|x_i|$  is maximal, we find

$$(a_{ii} - \lambda) \leq \sum_{j \neq i} |a_{ij}|.$$

This statement can be interpreted as follows:

The eigenvalue  $\lambda$  is located in the circle around  $a_{ii}$  with radius  $\sum_{j \neq i} |a_{ij}|$ .

Since we do not know for which value of  $i$   $|x_i|$  is maximal, we can only say that there is some value of  $i$  such that  $\lambda$  lies in such a circle. This is the Gershgorin theorem.

**Theorem 5** *Let  $A$  be a square matrix, and let  $D_i$  be the circle with center  $a_{ii}$  and radius  $\sum_{j \neq i} |a_{ij}|$ , then the eigenvalues are contained in the union of circles  $\cup_i D_i$ .*

We can conclude that the eigenvalues are in the interior of these discs, if the constant vector is not an eigenvector.

## 12.6 Householder reflectors

In some contexts the question comes up how to transform one subspace into another. *Householder reflectors* are in a sense the minimal solution to this. Consider a unit vector  $u$ , and let

$$H = I - 2uu^t.$$

You can easily check that  $Hu = -u$ , and if  $u \perp v$ , then  $Hv = v$ . In other words, the subspace of multiples of  $u$  is flipped, and the orthogonal subspace stays invariant.

Now for the original problem of mapping one space into another. Let the original space be spanned by a vector  $x$  and the resulting by  $y$ , then note that

$$\begin{cases} x = (x+y)/2 + (x-y)/2 \\ y = (x+y)/2 - (x-y)/2 \end{cases}$$

In other words, we can map  $x$  into  $y$  with the reflector based on  $u = (x-y)/2$ .

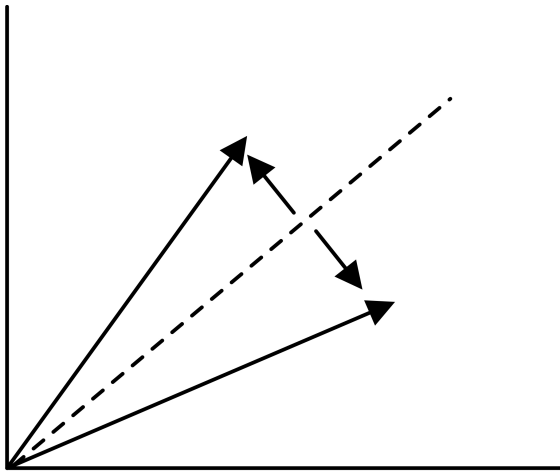

Figure 12.1: Householder reflector

We can generalize Householder reflectors to a form

$$H = I - 2uv^t.$$

The matrices  $L_i$  used in LU factorization (see section 5.3) can then be seen to be of the form  $L_i = I - \ell_i e_i^t$  where  $e_i$  has a single one in the  $i$ -th location, and  $\ell_i$  only has nonzero below that location. That form also makes it easy to see that  $L_i^{-1} = I + \ell_i e_i^t$ :

$$(I - uv^t)(I + uv^t) = I - uv^t uv^t = 0$$

if  $v^t u = 0$ .



## Chapter 13

### Complexity

At various places in this book we are interested in how many operations an algorithm takes. It depends on the context what these operations are, but often we count additions (or subtractions) and multiplications. This is called the *arithmetic* or *computational complexity* of an algorithm. For instance, summing  $n$  numbers takes  $n - 1$  additions. Another quantity that we may want to describe is the amount of space (computer memory) that is needed. Sometimes the space to fit the input and output of an algorithm is all that is needed, but some algorithms need temporary space. The total required space is called the *space complexity* of an algorithm.

Both arithmetic and space complexity depend on some description of the input, for instance, for summing an array of numbers, the length  $n$  of the array is all that is needed. We express this dependency by saying ‘summing an array of numbers has time complexity  $n - 1$  additions, where  $n$  is the length of the array’.

The time (or space) the summing algorithm takes is not dependent on other factors such as the values of the numbers. By contrast, some algorithms such as computing the greatest common divisor of an array of integers *can* be dependent on the actual values.

**Exercise 13.1.** What is the time and space complexity of multiplying two square matrices of size  $n \times n$ ? Assume that an addition and a multiplication take the same amount of time.

Often we aim to simplify the formulas that describe time or space complexity. For instance, if the complexity of an algorithm is  $n^2 + 2n$ , we see that for  $n > 2$  the complexity is less than  $2n^2$ , and for  $n > 4$  it is less than  $(3/2)n^2$ . On the other hand, for all values of  $n$  the complexity is at least  $n^2$ . Clearly, the quadratic term  $n^2$  is the most important, and the linear term  $n$  becomes less and less important by ratio. We express this informally by saying that the complexity is quadratic in  $n$  as  $n \rightarrow \infty$ : there are constants  $c, C$  so that for  $n$  large enough the complexity is at least  $cn^2$  and at most  $Cn^2$ .

This is expressed for short by saying that the complexity is of *order*  $n^2$ , written as  $O(n^2)$  as  $n \rightarrow \infty$ . In chapter 4 you will see phenomena that we want to describe as orders of a parameter that goes to zero. In that case we write for instance  $f(h) = O(h^2)$  as  $h \downarrow 0$ , meaning that  $f$  is bounded by  $ch^2$  and  $Ch^2$  for certain constants  $c, C$  and  $h$  small enough.

## Chapter 14

### Partial Differential Equations

Partial Differential Equations are the source of a large fraction of HPC problems. Here is a quick derivation of two of the most important ones.

#### 14.1 Partial derivatives

Derivatives of a function  $u(x)$  are a measure of the rate of change. Partial derivatives to the same, but for a function  $u(x, y)$  of two variables. Notated  $u_x$  and  $u_y$ , these *partial derivatives* indicate the rate of change if only one variable changes and the other stays constant.

Formally, we define  $u_x, u_y$  by:

$$u_x(x, y) = \lim_{h \rightarrow 0} \frac{u(x+h, y) - u(x, y)}{h}, \quad u_y(x, y) = \lim_{h \rightarrow 0} \frac{u(x, y+h) - u(x, y)}{h}$$

#### 14.2 Poisson or Laplace Equation

Let  $T$  be the temperature of a material, then its heat energy is proportional to it. A segment of length  $\Delta x$  has heat energy  $Q = c\Delta x \cdot u$ . If the heat energy in that segment is constant

$$\frac{\delta Q}{\delta t} = c\Delta x \frac{\delta u}{\delta t} = 0$$

but it is also the difference between inflow and outflow of the segment. Since flow is proportional to temperature differences, that is, to  $u_x$ , we see that also

$$0 = \left. \frac{\delta u}{\delta x} \right|_{x+\Delta x} - \left. \frac{\delta u}{\delta x} \right|_x$$

In the limit of  $\Delta x \downarrow 0$  this gives  $u_{xx} = 0$ , which is called the *Laplace equation*. If we have a source term, for instance corresponding to externally applied heat, the equation becomes  $u_{xx} = f$ , which is called the *Poisson equation*.

### 14.3 Heat Equation

Let  $T$  be the temperature of a material, then its heat energy is proportional to it. A segment of length  $\Delta x$  has heat energy  $Q = c\Delta x \cdot u$ . The rate of change in heat energy in that segment is

$$\frac{\delta Q}{\delta t} = c\Delta x \frac{\delta u}{\delta t}$$

but it is also the difference between inflow and outflow of the segment. Since flow is proportional to temperature differences, that is, to  $u_x$ , we see that also

$$\frac{\delta Q}{\delta t} = \left. \frac{\delta u}{\delta x} \right|_{x+\Delta x} - \left. \frac{\delta u}{\delta x} \right|_x$$

In the limit of  $\Delta x \downarrow 0$  this gives  $u_t = \alpha u_{xx}$ .

### 14.4 Steady state

The solution of an IBVP is a function  $u(x, t)$ . In cases where the forcing function and the boundary conditions do not depend on time, the solution will converge in time, to a function called the *steady state* solution:

$$\lim_{t \rightarrow \infty} u(x, t) = u_{\text{steadystate}}(x).$$

This solution satisfies a BVP, which can be found by setting  $u_t \equiv 0$ . For instance, for the heat equation

$$u_t = u_{xx} + q(x)$$

the steady state solution satisfies  $-u_{xx} = q(x)$ .

## Chapter 15

### Taylor series

Taylor series expansion is a powerful mathematical tool. In this course it is used several times in proving properties of numerical methods.

The Taylor expansion theorem, in a sense, asks how well functions can be approximated by polynomials, that is, for a given function  $f$ , can we find coefficients  $c_i$  with  $i = 1, \dots, n$  so that

$$f(x) \approx c_0 + c_1x + c_2x^2 + \dots + c_nx^n.$$

This question obviously needs to be refined. What do we mean by ‘approximately equal’? This approximation formula can not hold for all functions  $f$  and all  $x$ : the function  $\sin x$  is bounded for all  $x$ , but any polynomial is unbounded for  $x \rightarrow \pm\infty$ , so any polynomial approximation to the  $\sin x$  function is unbounded. Clearly we can only approximate on an interval.

We will show that a function  $f$  with sufficiently many derivatives can be approximated as follows: if the  $n$ -th derivative  $f^{(n)}$  is continuous on an interval  $I$ , then there are coefficients  $c_0, \dots, c_{n-1}$  such that

$$\forall_{x \in I}: |f(x) - \sum_{i < n} c_i x^i| \leq cM_n \quad \text{where } M_n = \max_{x \in I} |f^{(n)}(x)|$$

It is easy to get inspiration for what these coefficients should be. Suppose

$$f(x) = c_0 + c_1x + c_2x^2 + \dots$$

(where we will not worry about matters of convergence and how long the dots go on) then filling in

$$x = 0 \text{ gives } c_0 = f(0).$$

Next, taking the first derivative

$$f'(x) = c_1 + 2c_2x + 3c_3x^2 + \dots$$

and filling in

$$x = 0 \text{ gives } c_1 = f'(0).$$

From the second derivative

$$f''(x) = 2c_2 + 6c_3x + \dots$$

so filling in  $x = 0$  gives

$$c_2 = f''(0)/2.$$

Similarly, in the third derivative

$$\text{filling in } x = 0 \text{ gives } c_3 = \frac{1}{3!}f^{(3)}(0).$$

Now we need to be a bit more precise. Cauchy's form of Taylor's theorem says that

$$f(x) = f(a) + \frac{1}{1!}f'(a)(x-a) + \dots + \frac{1}{n!}f^{(n)}(a)(x-a)^n + R_n(x)$$

where the 'rest term'  $R_n$  is

$$R_n(x) = \frac{1}{(n+1)!}f^{(n+1)}(\xi)(x-a)^{n+1} \quad \text{where } \xi \in (a, x) \text{ or } \xi \in (x, a) \text{ depending.}$$

If  $f^{(n+1)}$  is bounded, and  $x = a + h$ , then the form in which we often use Taylor's theorem is

$$f(x) = \sum_{k=0}^n \frac{1}{k!}f^{(k)}(a)h^k + O(h^{n+1}).$$

We have now approximated the function  $f$  on a certain interval by a polynomial, with an error that decreases geometrically with the inverse of the degree of the polynomial.

For a proof of Taylor's theorem we use integration by parts. First we write

$$\int_a^x f'(t)dt = f(x) - f(a)$$

as

$$f(x) = f(a) + \int_a^x f'(t)dt$$

Integration by parts then gives

$$\begin{aligned} f(x) &= f(a) + [xf'(x) - af'(a)] - \int_a^x tf''(t)dt \\ &= f(a) + [xf'(x) - xf'(a) + xf'(a) - af'(a)] - \int_a^x tf''(t)dt \\ &= f(a) + x \int_a^x f''(t)dt + (x-a)f'(a) - \int_a^x tf''(t)dt \\ &= f(a) + (x-a)f'(a) + \int_a^x (x-t)f''(t)dt \end{aligned}$$

Another application of integration by parts gives

$$f(x) = f(a) + (x-a)f'(a) + \frac{1}{2}(x-a)^2f''(a) + \frac{1}{2} \int_a^x (x-t)^2f'''(t)dt$$

---

Inductively, this gives us Taylor's theorem with

$$R_{n+1}(x) = \frac{1}{n!} \int_a^x (x-t)^n f^{(n+1)}(t) dt$$

By the mean value theorem this is

$$\begin{aligned} R_{n+1}(x) &= \frac{1}{(n+1)!} f^{(n+1)}(\xi) \int_a^x (x-t)^n f^{(n+1)}(t) dt \\ &= \frac{1}{(n+1)!} f^{(n+1)}(\xi) (x-a)^{n+1} \end{aligned}$$

## Chapter 16

### Graph theory

Graph theory is the branch of mathematics that studies pairwise relations between objects. Graphs both appear as tools for analyzing issues in HPC, and as objects of study themselves. This appendix introduces the basic concepts and some relevant theory.

#### 16.1 Definitions

A graph consists of a set of objects, and set of relations between them. The objects, called the *nodes* or *vertices* of the graph, usually form a finite set, so we usually identify them with consecutive integers  $1 \dots n$  or  $0 \dots n - 1$ . The relation that holds between nodes is described by the *edges* of the graph: if  $i$  and  $j$  are related, we say that  $(i, j)$  is an edge of the graph. This relation does not need to be symmetric, take for instance the ‘less than’ relation.

Formally, then, a graph is a tuple  $G = \langle V, E \rangle$  where  $V = \{1, \dots, n\}$  for some  $n$ , and  $E \subset \{(i, j) : 1 \leq i, j \leq n, i \neq j\}$ .

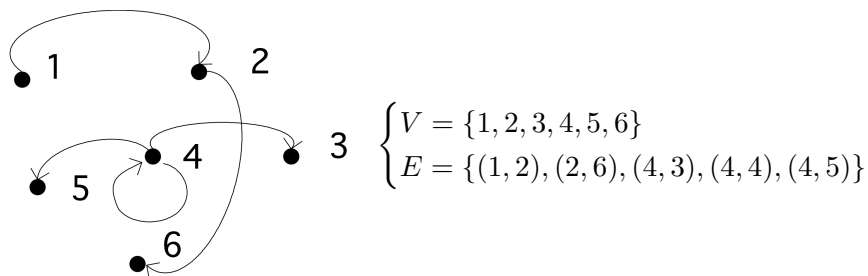

Figure 16.1: A simple graph

A graph is called an *undirected graph* if  $(i, j) \in E \Leftrightarrow (j, i) \in E$ . The alternative is a *directed graph*, where we indicate an edge  $(i, j)$  with an arrow from  $i$  to  $j$ .

Two concepts that often appear in graph theory are the degree and the diameter of a graph.

**Definition 2** The degree denotes the maximum number of nodes that are connected to any node:

$$d(G) \equiv \max_i |\{j : j \neq i \wedge (i, j) \in E\}|.$$

**Definition 3** The diameter of a graph is the length of the longest shortest path in the graph, where a path is defined as a set of vertices  $v_1, \dots, v_{k+1}$  such that  $v_i \neq v_j$  for all  $i \neq j$  and

$$\forall_{1 \leq i \leq k} : (v_i, v_{i+1}) \in E.$$

The length of this path is  $k$ .

The concept of diameter is illustrated in figure 16.2.

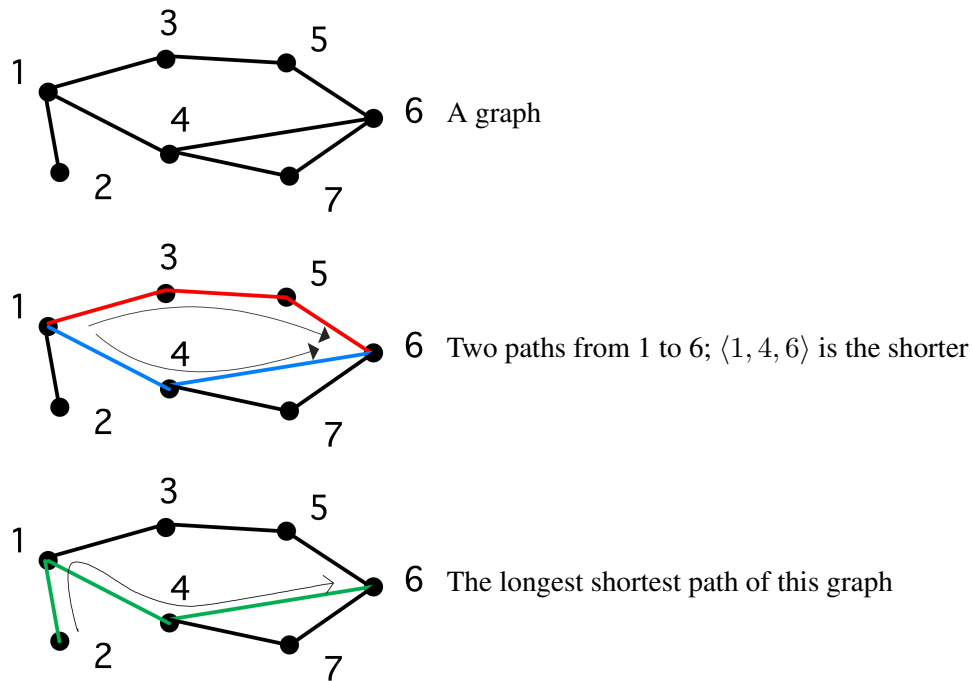

Figure 16.2: Shortest paths

A path where all nodes are disjoint except for  $v_1 = v_{k+1}$  is called a *cycle*.

Sometimes we are only interested in the mere existence of an edge  $(i, j)$ , at other times we attach a value or 'weight'  $w_{ij}$  to that edge. A graph with weighted edges is called a *weighted graph*. Such a graph can be represented as a tuple  $G = \langle V, E, W \rangle$  where  $E$  and  $W$  have the same cardinality.

## 16.2 Common types of graphs

### 16.2.1 Directed Acyclic Graphs

A graph that does not have cycles is called *acyclic*. A special case of this type of graph is the *Directed Acyclic Graph (DAG)*. This type of graph can for instance be used to model dependencies between tasks: if there is an edge between  $i, j$ , it means that task  $i$  has to be done before task  $j$ .



### 16.2.2 Trees

One special case of DAGs is the *tree graph*: here any node can have multiple incoming edges, but only one outgoing edge. Nodes with no incoming edges are *leaf nodes*; a node with no outgoing edges is called a root (can there be more than one root?), and all other nodes are called *interior nodes*.

### 16.3 Graph colouring and independent sets

We can assign labels to the nodes of a graph, which is equivalent to partitioning the set of nodes into disjoint subsets. One type of labeling that is of interest is *graph colouring*: here the labels (or ‘colours’) are chosen so that, if nodes  $i$  and  $j$  have the same colour, there is no edge connecting them:  $(i, j) \notin E$ .

There is a trivial colouring of a graph, where each node has its own colour. More interestingly, the minimum number of colours with which you can colour a graph is called the *colour number* of the graph.

**Exercise 16.1.** Show that, if a graph has degree  $d$ , the colour number is at most  $d + 1$ .

A famous graph colouring problem is the ‘four colour theorem’: if a graph depicts countries on a two-dimensional map (a so-called ‘planar’ graph), then the colour number is at most four. In general, finding the colour number is hard (in fact, NP-hard).

The colour sets of a graph colouring are also called *independent sets*, since within each colour no node is connected to a node of the same colour.

There is a trivial way of finding independent sets: declare each node to have its own unique colour. On the other hand, finding the ‘best’ division in independent sets, for instance through finding the colour number of the graph, is difficult. However, often it is enough to find a reasonable partitioning of the nodes into independent sets, for instance in constructing parallel ILU preconditioners; section 6.7.4. The following algorithm does that [93, 118]:

- Give each node a unique random number.
- Now find the set of nodes that have a higher number than all of their neighbours; call this the first independent set.
- Remove this set from the graph, and find again the nodes with a higher number than all their neighbours; this will be the second set.
- Repeat this procedure until all nodes are in an independent set.

**Exercise 16.2.** Convince yourself that the sets found this way are indeed independent.

### 16.4 Graphs and matrices

A graph can be rendered in a number of ways. You could of course just list nodes and edges, but little insight can be derived that way. Simple graphs can be visualized by drawing vertices and edges, but for large graphs this becomes unwieldy. Another option is to construct the *adjacency matrix* of the graph. For

a graph  $G = \langle V, E \rangle$ , the adjacency matrix  $M$  (with a size  $n$  equal to the number of vertices  $|V|$ ) is defined by

$$M_{ij} = \begin{cases} 1 & (i, j) \in E \\ 0 & \text{otherwise} \end{cases}$$

Conversely, if you have a matrix, especially a *sparse matrix*, you can construct its *adjacency graph*. This is illustrated in figure 16.3 for both a dense and a sparse matrix. In this example, the matrices are structurally

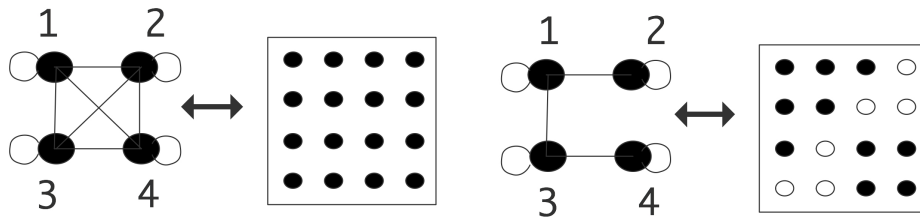

Figure 16.3: A dense and a sparse matrix, both with their adjacency graph

symmetric, so we use lines instead of arrows in the graphs. There is an edge on each vertex corresponding to the diagonal element; this edge will often be left out of illustrations.

For graphs with edge weights, we set the elements of the adjacency matrix to the weights:

$$M_{ij} = \begin{cases} w_{ij} & (i, j) \in E \\ 0 & \text{otherwise} \end{cases}$$

If a matrix has no zero elements, its adjacency graph has an edge between each pair of vertices. Such a graph is called a *clique*. If the graph is undirected, the adjacency matrix is symmetric, and conversely, if a matrix is *structurally symmetric*, its adjacency graph is undirected.

### 16.4.1 Permutation

Graphs are often used to indicate relations between objects in the real world. One example would be ‘friend-of’ relations in Facebook. In such cases, the nodes in a graph do not have a natural numbering: they are identified by a name and any numbering is artificial. Thus, we could wonder which graph properties remain invariant, and which ones change, if we apply a different numbering.

Renumbering a set of objects can be modeled algebraically by applying a *permutation matrix*.

**Definition 4** A permutation matrix is a square matrix where each row and column has exactly one element equal to one; all other elements are zero.

**Exercise 16.3.** Let a set of  $N$  objects  $x_1, \dots, x_N$  be given. What is the permutation matrix that orders them as  $x_1, x_3, \dots, x_2, x_4, \dots$ ? That is, find the matrix  $P$  such that

$$\begin{pmatrix} x_1 \\ x_3 \\ \vdots \\ x_2 \\ x_4 \\ \vdots \end{pmatrix} = P \begin{pmatrix} x_1 \\ \vdots \\ x_N \end{pmatrix}$$

**Exercise 16.4.** Show that the eigenvalues of a matrix are invariant under permutation.

### 16.4.2 Irreducibility

As an example of graph concepts that has an easy interpretation in the adjacency matrix, consider reducibility.

**Definition 5** A graph is called irreducible if for every pair  $i, j$  of nodes there is a path from  $i$  to  $j$  and from  $j$  to  $i$ . A graph is reducible if it is not irreducible.

**Exercise 16.5.** Let  $A$  be a matrix

$$A = \begin{pmatrix} B & C \\ \emptyset & D \end{pmatrix}$$

where  $B$  and  $D$  are square matrices. Prove the reducibility of the graph of which this is the adjacency matrix.

If we permute graph, its reducibility or irreducibility is not changed. However, it may now no longer be apparent from looking at the adjacency matrix.

### 16.4.3 Graph closure

Here is another example of how adjacency matrices can simplify reasoning about graphs.

**Exercise 16.6.** Let  $G = \langle V, E \rangle$  be an undirected graph, and let  $G' = \langle V, E' \rangle$  be the graph with the same vertices, but with vertices defined by

$$(i, j) \in E' \Leftrightarrow \exists k: (i, k) \in E \wedge (k, j) \in E.$$

If  $M$  is the adjacency matrix of  $G$ , show that  $M^2$  is the adjacency matrix of  $G'$ , where we use boolean multiplication on the elements:  $1 \cdot 1 = 1, 1 + 1 = 1$ .

### 16.4.4 Graph operations in linear algebra

In most of the above, the adjacency matrix was nothing more than a table. We will now show that we can actually do linear algebra with it, making it deserving of the name ‘matrix’. As a simple example of using

linear algebra on an adjacency matrix  $G$ , let  $e$  the vector of all 1s, then  $Ge$  is the vector that lists the degrees of the nodes.

We can do many operations this way. Consider a weighted graph  $G$ . Finding for each node  $i$  the largest weight  $g_{ij}$  can be described as

$$y = G \otimes e \quad \text{where} \quad y_i = \max_j g_{ij} \cdot 1$$

This looks like the regular matrix-vector product  $Ge$ , but with the sum replaced by a maximum calculation.

In many cases we actually need the left product, that is, multiplying the adjacency matrix from the left by a row vector. Let for example  $e_i$  be the vector with a 1 in location  $i$  and zero elsewhere. Then  $e_i^t G$  has a one in every  $j$  that is a neighbour of  $i$  in the adjacency graph of  $G$ .

#### 16.4.4.1 Markov chains

This left matrix-vector product has a neat application: *Markov chains*. Suppose we have a system (see for instance 17) that can be in any of  $n$  states. We can then use the adjacency matrix to model state transitions.

Let  $G$  be an adjacency matrix with the property that all elements are non-negative, and the elements in each row sum to 1. We now interpret  $g_{ij}$  as the probability of going from state  $i$  to state  $j$ . Let  $x$  be a probability vector, that is,  $x_i$  is the nonnegative probability of being in state  $i$ , then  $y^t = x^t G$  describes these probabilities, after one state transition.

**Exercise 16.7.** For a vector  $x$  to be a proper probability vector, its elements need to sum to 1.

Show that the elements of  $y$  again sum to 1.

#### 16.4.4.2 General matrix-vector product

The examples above showed that sometimes we perform an operation on an adjacency matrix that has the structure of a matrix-vector product, but may not necessarily use addition and multiplication. (Many more examples of this can be found in section 9.1.)

Motivated by this, we define a general product

$$y = G \oplus_{\otimes} x$$

where  $\otimes$  is a binary operator, and  $\oplus$  a reduction operator, as

$$y_i = \bigoplus_j (g_{ij} \otimes x_j).$$

In this notation, finding the largest weight would be

$$w = G \max_{\otimes} \cdot_{\times} e.$$

This will be used in several algorithms in chapter 9; for other applications see [105].

### 16.5 Spectral graph theory

With a graph  $G^1$  and its adjacency matrix  $A_G$ , we can define a *stochastic matrix* or *Markov matrix* by scaling  $A_G$  to have unit row sums:

$$W_G = D_G^{-1} A_G \quad \text{where } (D_G)_{ii} = \text{deg}(i).$$

To see how we interpret this, let's look at a simple example. Let's take an unweighted graph with an adjacency matrix

$$A_G = \begin{pmatrix} 1 & 1 & 1 \\ & 1 & 1 \\ 1 & 1 & 1 \\ & 1 & 1 \end{pmatrix}$$

and look at the second row, which says that there are edges  $(2, 3)$  and  $(2, 4)$ . This means that if you are on node 2, you can go to nodes 3 and 4. Scaling this matrix we get

$$W_G = \begin{pmatrix} 1/3 & 1/3 & 1/3 \\ & 1/2 & 1/2 \\ 1/3 & 1/3 & 1/3 \\ & 1/2 & 1/2 \end{pmatrix}$$

and now the second row says that from node 2 you can get with equal probability to nodes 3 and 4. You can also derive this statement mathematically:

$$(0 \ 1 \ 0 \ 0) W_G = (0 \ 0 \ 1/2 \ 1/2)$$

It is simple to extrapolate that: if  $p$  is a vector where the  $i$ -th component gives the probability of being in node  $i$ , then  $(p^t W_G)_i$  is the probability of being in node  $i$  if you take one more step along a graph edge.

**Exercise 16.8.** Prove that  $p^t W_G$  is indeed a vector of probabilities. Hint: you can express that  $p$  is a probability vector as  $p^t e = e$ , where  $e$  is the vector of all ones.

Another matrix to associate with a graph is the *graph Laplacian*

$$L_G = D_G - A_G.$$

This matrix has zero rowsums and positive diagonal entries, so by the Gershgorin theorem (section 12.5 all its eigenvalues are in the complex right half plane.

**Exercise 16.9.** Show that the vector of all ones is an eigenvector with eigenvalue 1.

This Laplacian matrix gives us a quadratic form:

$$x^t L_G x = \sum_{(i,j) \in E} (x_i - x_j)^2.$$

1. This section owes much to Dan Spielman's course on spectral graph theory <http://www.cs.yale.edu/homes/spielman/561/>.

### 16.5.1 Eigenvalue theorems for graph matrices

There are various interesting theorems connected with the graph adjacency and Laplacian matrix. We start by remarking that the following theorems may not seem intuitive, but they closely resemble some simple facts about PDEs.

Connected with the *Laplace equation*  $-\Delta u = f$  is an operator  $\mathcal{L}u = -\Delta u$ . On the unit interval  $[0, 1]$  the eigenfunctions of this operator, that is, the functions for which  $\mathcal{L}u = \lambda u$ , are  $u_n(x) = \sin n\pi x$  for  $n > 0$ . These have the property that  $u_n(x)$  has  $n - 1$  zeros in the interior of the interval, and they divide the interval in  $n$  connected regions where the function is positive or negative. Thus, if you wanted to divide a domain  $\Omega$  over  $p$  processors, you could consider the  $p$ -th eigenfunction of the Laplacian on  $\Omega$ , and find the connected regions where it is positive or negative.

This statement about PDE has a graph equivalent in two versions of *Fiedler's theorem*. (We will not give any proofs in this section; see [149].)

**Theorem 6** *Let  $G$  be a weighted path graph on  $n$  vertices, let  $L_P$  have eigenvalues  $0 = \lambda_1 < \lambda_2 \leq \dots \leq \lambda_n$ , and let  $v_k$  be an eigenvector of  $\lambda_k$ . Then  $v_k$  changes sign  $k - 1$  times.*

The second theorem is more useful [55]:

**Theorem 7** *Let  $G = (V, E, w)$  be a weighted connected graph, and let  $L_G$  be its Laplacian matrix. Let  $0 = \lambda_1 < \lambda_2 \leq \dots \leq \lambda_n$  be the eigenvalues of  $L_G$  and let  $v_1, \dots, v_n$  be the corresponding eigenvectors. For any  $k \geq 2$ , let  $W_k = \{i \in V : v_k(i) \geq 0\}$ . Then, the graph induced by  $G$  on  $W_k$  has at most  $k - 1$  connected components.*

The important consequence of this is that the eigenvector to the first nontrivial eigenvalue can be used to partition the graph in two connected pieces: one of nodes where the eigenvector is positive, and one where the eigenvector is negative. This eigenvector is known as the *Fiedler vector*.

The adjacency matrix is nonnegative, and there is an extensive theory for this type of matrix [9]; see the Perron-Frobenius theorem in section 12.4.

**Lemma 1** *The largest eigenvalue of the adjacency matrix can be bounded by the maximum node degree:*

$$\alpha_1 \leq d_{\max}.$$

### 16.5.2 Cheeger's inequality

Above we remarked that the first non-trivial eigenvalue of the graph Laplacian has a relation to partitioning a graph in two parts. The *Cheeger's constant* and *Cheeger's inequality* relate this eigenvalue to a certain quality measure of partitionings.

Let  $V$  be the set of vertices and  $S \subset V$ , then Cheeger's constant of a graph is defined as

$$C = \min_S \frac{e(S, V - S)}{\min \text{vol}(S), \text{vol}(V - S)}$$

where  $e(S, V - S)$  denotes the number of edges connecting  $S$  to  $V - S$ , and the volume of a set of nodes is defined as

$$\text{vol}(S) = \sum_{e \in S} d(e).$$

Cheeger's inequality then states

$$2C \geq \lambda \geq \frac{C^2}{2}$$

where  $\lambda$  is the first nontrivial eigenvalue of the graph Laplacian.

## Chapter 17

### Automata theory

*Automata* are mathematical abstractions of machines. There is an extensive theory of automata; here we will only touch on the basic concepts. Let us start with a simple example.

#### 17.1 Finite State Automata

A *Finite State Automaton (FSA)* is a very simple machine, something on the order of a vending machine that will dispense a candy bar when a quarter has been inserted. There are four actions possible with a vending machine: insert a quarter, press ‘coin return’ to ask for any inserted money back, open the window to take the candy bar, and close the window again. Whether an action is possible (especially the third) depends on the *state* the machine is in. There are three states: the begin state, the state where the quarter has been inserted and the window unlocked (let us call this ‘ready to dispense’), and the state where the window is open (which we will call ‘dispensing’).

In certain states, certain actions are not possible. For instance, in the beginning state the window can not be opened.

The mathematical description of this vending machine consists of 1. the list of states, 2. a table of how the possible actions make the machine go from one state to another. However, rather than writing down the table, a graphical representation is usually more insightful.

#### 17.2 General discussion

From the vending machine example, you saw an important characteristic of an automaton: it allows certain actions, but only in some circumstances, and in the end it has a state corresponding to ‘success’, which is only reached if certain sequences of actions are taken.

The formal description of this process is as follows: we call the individual actions an ‘alphabet’, and a sequence of actions a ‘word’ from based on that alphabet. The ‘success’ result of a machine then corresponds to a verdict that a certain word belong to the ‘language’ that is accepted by the automaton. Thus there is a correspondence between automata theory and language theory.



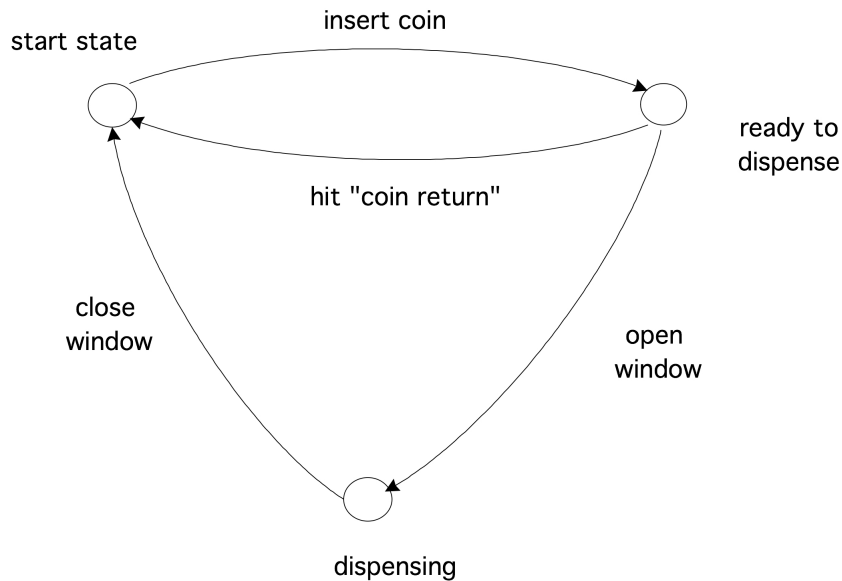

Figure 17.1: A simple real-life automaton

**Exercise 17.1.** Consider the alpha  $\{a, b\}$ , that is, the alphabet with only the letters  $a, b$ , and consider the language  $\{a^m b^n : m, n > 0\}$ , that is the words that consist of one or more  $a$ s followed by one or more  $b$ s. Draw the automaton that accepts this language.

What makes the FSA the simplest type is that it has no memory. Most vending machines do not complain if you put in more than one quarter: they have no memory beyond ‘a quarter has been inserted’. A more complicated machine would count how many quarters you inserted, and then allow you to open that many windows to different candy bars. In the above formal way of describing, that machine would accept the language  $\{q^n w^n : n \geq 0\}$ , that is, the sequences where you deposit as many quarters ( $q$ ) as you open windows ( $w$ ). This language is an example of a so-called *context-free language*; the language of the original vending machine is a *regular language*.

These two language types belong to the four level *Chomsky hierarchy* of languages. The famous *Turing machine*, which recognizes the *recursively enumerable language* type, is on the top level of the hierarchy. The missing step has the *context-sensitive language* type, which is recognized by a *linear bounded automaton*.

## Chapter 18

### Parallel Prefix

For operations to be executable in parallel they need to be independent. That makes recurrences problematic to evaluate in parallel. Recurrences occur in obvious places such as solving a triangular system of equations (section 5.3.5), but they can also appear in sorting and many other operations.

In this appendix we look at *parallel prefix* operations: the parallel execution of an operation that is defined by a recurrence involving an associative operator. Computing the sum of an array of elements is an example of this type of operation (disregarding the *non-associativity* for the moment). Let  $\pi(x, y)$  be the binary sum operator:

$$\pi(x, y) \equiv x + y,$$

then we define the prefix sum of  $n \geq 2$  terms as

$$\Pi(x_1, \dots, x_n) = \begin{cases} \pi(x_1, x_2) & \text{if } n = 2 \\ \pi(\Pi(x_1, \dots, x_{n-1}), x_n) & \text{otherwise} \end{cases}$$

As a non-obvious of a prefix operation, we could count the number of elements of an array that have a certain property.

**Exercise 18.1.** Let  $p(\cdot)$  be a predicate,  $p(x) = 1$  if it holds for  $x$  and 0 otherwise. Define a binary operator  $\pi(x, y)$  so that its reduction over an array of numbers yields the number of elements for which  $p$  is true.

So let us now assume the existence of an associative operator  $\oplus$ , an array of values  $x_1, \dots, x_n$ . Then we define the prefix problem as the computation of  $X_1, \dots, X_n$ , where

$$\begin{cases} X_1 = x_1 \\ X_k = \oplus_{i \leq k} x_i \end{cases}$$

#### 18.1 Parallel prefix

The key to parallelizing this is the realization that we can compute partial reductions in parallel:

$$x_1 \oplus x_2, \quad x_3 \oplus x_4, \dots$$

are all independent. Furthermore, partial reductions of these reductions,

$$(x_1 \oplus x_2) \oplus (x_3 \oplus x_4), \quad \dots$$

are also independent. We use the notation

$$X_{i,j} = x_i \oplus \dots \oplus x_j$$

for these partial reductions.

You have seen this before in section 2.1: an array of  $n$  numbers can be reduced in  $\lceil \log_2 n \rceil$  steps. What is missing to make this a full prefix operation is computation of all intermediate values.

Observing that, for instance,  $X_3 = (x_1 \oplus x_2) \oplus x_3 = X_2 \oplus x_3$ , you can now easily imagine the whole process; see figure 18.1 for the case of 8 elements. To compute, say,  $X_{13}$ , you express  $13 = 8 + 4 + 1$  and

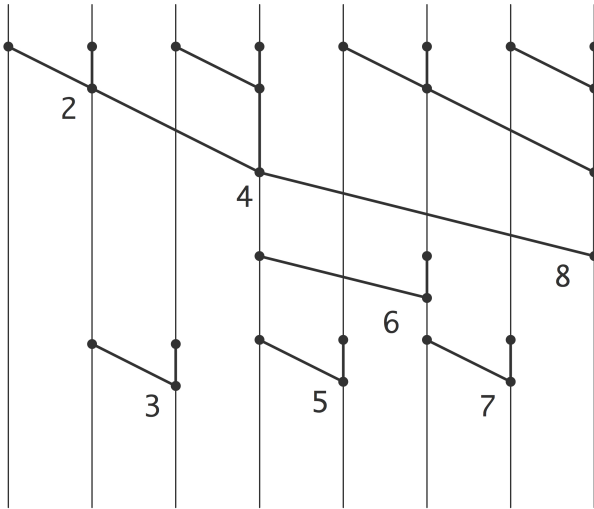

Figure 18.1: A prefix operation applied to 8 elements

compute  $X_{13} = X_8 \oplus X_{9,12} \oplus x_{13}$ .

In this figure, operations over the same ‘distance’ have been horizontally aligned corresponding to a SIMD type execution. If the execution proceeds with a task graph, some steps can be executed earlier than the figure suggests; for instance  $X_3$  can be computed simultaneously with  $X_6$ .

Regardless the arrangement of the computational steps, it is not hard to see that the whole prefix calculation can be done in  $2 \log_2 n$  steps:  $\log_2 n$  steps for computing the final reduction  $X_n$ , then another  $\log_2 n$  steps for filling in the intermediate values.

## 18.2 Sparse matrix vector product as parallel prefix

It has been observed that the sparse matrix vector product can be considered a prefix operation; see [14]. The reasoning here is we first compute all  $y_{ij} \equiv a_{ij}x_j$ , and subsequently compute the sums  $y_i = \sum_j y_{ij}$  with a prefix operation.

A prefix sum as explained above does not compute the right result. The first couple of  $y_{ij}$  terms do indeed sum to  $y_1$ , but then continuing the prefix sum gives  $y_1 + y_2$ , instead of  $y_2$ . The trick to making this work is to consider two-component quantities  $\langle y_{ij}, s_{ij} \rangle$ , where

$$s_{ij} = \begin{cases} 1 & \text{if } j \text{ is the first nonzero index in row } i \\ 0 & \text{otherwise} \end{cases}$$

Now we can define prefix sums that are ‘reset’ every time  $s_{ij} = 1$ .



**PART IV**

**TUTORIALS**

---

In the theory part of this book you learned mathematical models can be translated to algorithms that can be realized efficiently on modern hardware. You learned how data structures and coding decisions influence the performance of your code. In other words, you should now have all the tools to write programs that solve scientific problems.

This would be all you would need to know, if there was any guarantee that a correctly derived algorithm and well designed data structure could immediately be turned into a correct program. Unfortunately, there is more to programming than that. This collection of tutorials will give you the tools to be an effective scientific programmer.

The vast majority of scientific programming is done on the Unix platform so we start out with a tutorial on Unix in section 19, followed by an explanation of the how your code is handled by compilers and linkers and such in section 20.

Next you will learn about some tools that will increase your productivity and effectiveness:

- The *Make* utility is used for managing the building of projects; section 21.
- Source control systems store your code in such a way that you can undo changes, or maintain multiple versions; in section 22 you will see the *subversion* software.
- Storing and exchanging scientific data becomes an important matter once your program starts to produce results; in section 23 you will learn the use of *HDF5*.
- A lot of functionality that you need has been coded already by other people; in section 24 you will learn about some of the scientific libraries that are available to you.
- Visual output of program data is important, but too wide a topic to discuss here in great detail; section 25 teaches you the basics of the *gnuplot* package, which is suitable for simple data plotting.

We also consider the activity of program development itself: section 26 considers how to code to prevent errors, and section 27 teaches you to debug code with *gdb*. Section 28 contains some information on how to write a program that uses more than one programming language.

Finally, section 29 teaches you about the  $\text{\LaTeX}$  document system, so that you can report on your work in beautifully typeset articles.

Many of the tutorials are very hands-on. Do them while sitting at a computer!

## Chapter 19

### Unix intro

Unix is an *Operating System (OS)*, that is, a layer of software between the user or a user program and the hardware. It takes care of files and screen output, and it makes sure that many processes can exist side by side on one system. However, it is not immediately visible to the user. Most of the time that you use Unix, you are typing commands which are executed by an interpreter called the *shell*. The shell makes the actual OS calls. There are a few possible Unix shells available, but in this tutorial we will assume that you are using the *sh* or *bash* shell, although many commands are common to the various shells in existence.

This short tutorial will get you going; if you want to learn more about Unix and shell scripting, see for instance <http://www.tldp.org/guides.html>. Most of this tutorial will work on any Unix-like platform, including *Cygwin* on Windows. However, there is not just one Unix:

- Traditionally there are a few major flavours of Unix: ATT and BSD. Apple has Darwin which is close to BSD; IBM and HP have their own versions of Unix, and Linux is yet another variant. The differences between these are deep down and if you are taking this tutorial you probably won't see them for quite a while.
- Within Linux there are various *Linux distributions* such as *Red Hat* or *Ubuntu*. These mainly differ in the organization of system files and again you probably need not worry about them.
- As mentioned just now, there are different shells, and they do differ considerably. Here you will learn the bash shell, which for a variety of reasons is to be preferred over the *csh* or *tcsh* shell. Other shells are the *ksh* and *zsh*.

#### 19.1 Files and such

**Purpose.** In this section you will learn about the Unix file system, which consists of *directories* that store *files*. You will learn about *executable* files and commands for displaying data files.

##### 19.1.1 Looking at files

**Purpose.** In this section you will learn commands for displaying file contents.



The `ls` command gives you a listing of files that are in your present location.

**Exercise.** Type `ls`. Does anything show up?

*Expected outcome.* If there are files in your directory, they will be listed; if there are none, no output will be given. This is standard Unix behaviour: no output does not mean that something went wrong, it only means that there is nothing to report.

The `cat` command is often used to display files, but it can also be used to create some simple content.

**Exercise.** Type `cat > newfilename` (where you can pick any filename) and type some text. Conclude with `Control-d` on a line by itself<sup>1</sup>. Now use `cat` to view the contents of that file: `cat newfilename`.

*Expected outcome.* In the first use of `cat`, text was concatenated from the terminal to a file; in the second the file was cat'ed to the terminal output. You should see on your screen precisely what you typed into the file.

*Caveats.* Be sure to type `Control-d` as the first thing on the last line of input. If you really get stuck, `Control-c` will usually get you out. Try this: start creating a file with `cat > filename` and hit `Control-c` in the middle of a line. What are the contents of your file?

**Remark 1** *Instead of `Control-d` you will often see the notation `^D`. The capital letter is for historic reasons: you use the control key and the lowercase letter.*

Above you used `ls` to get a directory listing. You can also use the `ls` command on specific files:

**Exercise.** Do `ls newfilename` with the file that you created above; also do `ls nosuchfile` with a file name that does not exist.

*Expected outcome.* For an existing file you get the file name on your screen; for a non-existing file you get an error message.

The `ls` command can give you all sorts of information.

**Exercise.** Read the man page of the `ls` command: `man ls`. Find out the size and creation date of some files, for instance the file you just created.

*Expected outcome.* Did you find the `ls -s` and `ls -l` options? The first one lists the size of each file, usually in kilobytes, the other gives all sorts of information about a file, including things you will learn about later.

*Caveats.* The `man` command puts you in a mode where you can view long text documents. This viewer is common on Unix systems (it is available as the `more` or `less` system command), so memorize the following ways of navigating: Use the space bar to go forward and the `u` key to go back up. Use `g` to go to the beginning of the text, and `G` for the end. Use `q` to exit the viewer. If you really get stuck, `Control-c` will get you out.

---

1. Press the `Control` and hold it while you press the `d` key.

(If you already know what command you're looking for, you can use `man` to get online information about it. If you forget the name of a command, `man -k keyword` can help you find it.)

The `touch` command creates an empty file, or updates the timestamp of a file if it already exists. Use `ls -l` to confirm this behaviour.

Three more useful commands for files are: `cp` for copying, `mv` (short for 'move') for renaming, and `rm` ('remove') for deleting. Experiment with them.

There are more commands for displaying a file, parts of a file, or information about a file.

**Exercise.** Do `ls /usr/share/words` or `ls /usr/share/dict/words` to confirm that a file with words exists on your system. Now experiment with the commands `head`, `tail`, `more`, and `wc` using that file.

*Expected outcome.* `head` displays the first couple of lines of a file, `tail` the last, and `more` uses the same viewer that is used for `man` pages. Read the `man` pages for these commands and experiment with increasing and decreasing the amount of output. The `wc` ('word count') command reports the number of words, characters, and lines in a file.

Another useful command is `which`: it tells you what type of file you are dealing with. See what it tells you about one of the text files you just created.

### 19.1.2 Directories

**Purpose.** Here you will learn about the Unix directory tree, how to manipulate it and how to move around in it.

A unix file system is a tree of directories, where a directory is a container for files or more directories. We will display directories as follows:

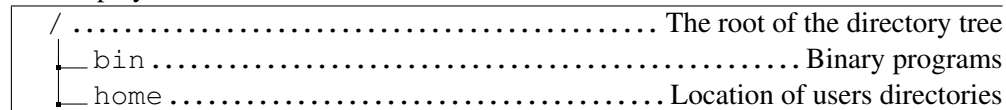

The root of the Unix directory tree is indicated with a slash. Do `ls /` to see what the files and directories there are in the root. Note that the root is not the location where you start when you reboot your personal machine, or when you log in to a server.

**Exercise.** The command to find out your current working directory is `pwd`. Your home directory is your working directory immediately when you log in. Find out your home directory.

*Expected outcome.* You will typically see something like `/home/yourname` or `/Users/yourname`. This is system dependent.

Do `ls` to see the contents of the working directory. In the displays in this section, directory names will be followed by a slash: `dir/` but this character is not part of their name. You can get this output by using `ls -F`, and you can tell your shell to use this output consistently by stating `alias ls=ls -F` at the start of your session. Example:

```
/home/you/  
├─ adirectory/  
└─ afile
```

The command for making a new directory is *mkdir*.

**Exercise.** Make a new directory with `mkdir newdir` and view the current directory with `ls`

*Expected outcome.* You should see this structure:

```
/home/you/  
├─ newdir/ ..... the new directory
```

The command for going into another directory, that is, making it your working directory, is *cd* ('change directory'). It can be used in the following ways:

- `cd` Without any arguments, `cd` takes you to your home directory.
- `cd <absolute path>` An absolute path starts at the root of the directory tree, that is, starts with `/`. The `cd` command takes you to that location.
- `cd <relative path>` A relative path is one that does not start at the root. This form of the `cd` command takes you to `<yourcurrentdir>/<relative path>`.

**Exercise.** Do `cd newdir` and find out where you are in the directory tree with `pwd`. Confirm with `ls` that the directory is empty. How would you get to this location using an absolute path?

*Expected outcome.* `pwd` should tell you `/home/you/newdir`, and `ls` then has no output, meaning there is nothing to list. The absolute path is `/home/you/newdir`.

**Exercise.** Let's quickly create a file in this directory: `touch onefile`, and another directory: `mkdir otherdir`. Do `ls` and confirm that there are a new file and directory.

*Expected outcome.* You should now have:

```
/home/you/  
├─ newdir/ ..... you are here  
│   └─ onefile  
└─ otherdir/
```

The `ls` command has a very useful option: with `ls -a` you see your regular files and hidden files, which have a name that starts with a dot. Doing `ls -a` in your new directory should tell you that there are the following files:

```
/home/you/  
├─ newdir/ ..... you are here  
│   ├── .  
│   ├── ..  
│   └─ onefile  
└─ otherdir/
```

The single dot is the current directory, and the double dot is the directory one level back.

**Exercise.** Predict where you will be after `cd ./otherdir/..` and check to see if you were right.

*Expected outcome.* The single dot sends you to the current directory, so that does not change anything. The `otherdir` part makes that subdirectory your current working directory. Finally, `..` goes one level back. In other words, this command puts you right back where you started.

Since your home directory is a special place, there are shortcuts for `cd`'ing to it: `cd` without arguments, `cd ~`, and `cd $HOME` all get you back to your home.

Go to your home directory, and from there do `ls newdir` to check the contents of the first directory you created, without having to go there.

**Exercise.** What does `ls ..` do?

*Expected outcome.* Recall that `..` denotes the directory one level up in the tree: you should see your own home directory, plus the directories of any other users.

**Exercise.** Can you use `ls` to see the contents of someone else's home directory? In the previous exercise you saw whether other users exist on your system. If so, do `ls ../thatotheruser`.

*Expected outcome.* If this is your private computer, you can probably view the contents of the other user's directory. If this is a university computer or so, the other directory may very well be protected – permissions are discussed in the next section – and you get `ls: ../otheruser: Permission denied`.

Make an attempt to move into someone else's home directory with `cd`. Does it work?

You can make copies of a directory with `cp`, but you need to add a flag to indicate that you recursively copy the contents: `cp -r`. Make another directory `somedir` in your home so that you have

```

/home/you/
├─ newdir/.....you have been working in this one
└─ somedir/.....you just created this one

```

What is the difference between `cp -r newdir somedir` and `cp -r newdir thirddir` where `thirddir` is not an existing directory name?

### 19.1.3 Permissions

**Purpose.** In this section you will learn about how to give various users on your system permission to do (or not to do) various things with your files.

Unix files, including directories, have permissions, indicating 'who can do what with this file'. Actions that can be performed on a file fall into three categories:

- reading `r`: any access to a file (displaying, getting information on it) that does not change the file;
- writing `w`: access to a file that changes its content, or even its metadata such as 'date modified';
- executing `x`: if the file is executable, to run it; if it is a directory, to enter it.

The people who can potentially access a file are divided into three classes too:

- the user *u*: the person owning the file;
- the group *g*: a group of users to which the owner belongs;
- other *o*: everyone else.

These nine permissions are rendered in sequence

<i>user</i>	<i>group</i>	<i>other</i>
<i>rw</i>	<i>rw</i>	<i>x</i>

For instance `rw-r--r--` means that the owner can read and write a file, the owner's group and everyone else can only read.

Permissions are also rendered numerically in groups of three bits, by letting  $r = 4$ ,  $w = 2$ ,  $x = 1$ :

<i>rw</i>
421

Common codes are  $7 = rwx$  and  $6 = rw$ . You will find many files that have permissions `755` which stands for an executable that everyone can run, but only the owner can change, or `644` which stands for a data file that everyone can see but again only the owner can alter. You can set permissions by the `chmod` command:

```
chmod <permissions> file           # just one file
chmod -R <permissions> directory # directory, recursively
```

Examples:

```
chmod 766 file # set to rwxrw-rw-
chmod g+w file # give group write permission
chmod g=rx file # set group permissions
chod o-w file # take away write permission from others
chmod o= file # take away all permissions from others.
chmod g+r,o-x file # give group read permission
                  # remove other execute permission
```

The man page gives all options.

**Exercise.** Make a file `foo` and do `chmod u-r foo`. Can you now inspect its contents? Make the file readable again, this time using a numeric code. Now make the file readable to your classmates. Check by having one of them read the contents.

*Expected outcome.* When you've made the file 'unreadable' by yourself, you can still `ls` it, but not `cat` it: that will give a 'permission denied' message.

Make a file `com` with the following contents:

```
#!/bin/sh
echo "Hello world!"
```

This is a legitimate shell script. What happens when you type `./com`? Can you make the script executable?

In the three permission categories it is who ‘you’ and ‘others’ refer to. How about ‘group’? The command `groups` tells you all the groups you are in, and `ls -l` tells you what group a file belongs to. Analogous to `chmod`, you can use `chgrp` to change the group to which a file belongs, to share it with a user who is also in that group. Adding a user to a group sometimes needs system privileges.

### 19.1.4 Wildcards

You already saw that `ls filename` gives you information about that one file, and `ls` gives you all files in the current directory. To see files with certain conditions on their names, the *wildcard* mechanism exists. The following wildcards exist:

- \* any number of characters.
- ? any character.

Example:

```
%% ls
s      sk      ski      skiing  skill
%% ls ski*
ski      skiing  skill
```

The second option lists all files whose name start with `ski`, followed by any number of other characters’; below you will see that in different contexts `ski*` means ‘sk followed by any number of i characters’. Confusing, but that’s the way it is.

## 19.2 Text searching and regular expressions

**Purpose.** In this section you will learn how to search for text in files.

For this section you need at least one file that contains some amount of text. You can for instance get random text from <http://www.lipsum.com/feed/html>.

The `grep` command can be used to search for a text expression in a file.

**Exercise.** Search for the letter `q` in your text file with `grep q yourfile` and search for it in all files in your directory with `grep q *`. Try some other searches.

*Expected outcome.* In the first case, you get a listing of all lines that contain a `q`; in the second case, `grep` also reports what file name the match was found in: `qfile:this line has q in it`.

*Caveats.* If the string you are looking for does not occur, `grep` will simply not output anything. Remember that this is standard behaviour for Unix commands if there is nothing to report.

In addition to searching for literal strings, you can look for more general expressions.

<code>^</code>	the beginning of the line
<code>\$</code>	the end of the line
<code>.</code>	any character
<code>*</code>	any number of repetitions
<code>[xyz]</code>	any of the characters <code>xyz</code>

This looks like the wildcard mechanism you just saw (section 19.1.4) but it's subtly different. Compare the example above with:

```
%% cat s
sk
ski
skill
skiing
%% grep "ski*" s
sk
ski
skill
skiing
```

In the second case you search for a string consisting of `sk` and any number of `i` characters, including zero of them.

Some more examples: you can find

- All lines that contain the letter 'q' with `grep q yourfile`;
- All lines that start with an 'a' with `grep "^a" yourfile` (if your search string contains special characters, it is a good idea to use quote marks to enclose it);
- All lines that end with a digit with `grep "[0-9]$" yourfile`.

**Exercise.** Construct the search strings for finding

- lines that start with an uppercase character, and
- lines that contain exactly one character.  
*Expected outcome.* For the first, use the range characters `[A-Z]`, for the second use the period to match any character.

**Exercise.** Add a few lines `x = 1`, `x = 2`, `x = 3` (that is, have different numbers of spaces between `x` and the equals sign) to your test file, and make `grep` commands to search for all assignments to `x`.

The characters in the table above have special meanings. If you want to search that actual character, you have to *escape* it.

**Exercise.** Make a test file that has both `abc` and `a.c` in it, on separate lines. Try the commands `grep "a.c" file`, `grep a\.c file`, `grep "a\.c" file`.

*Expected outcome.* You will see that the period needs to be escaped, and the search string needs to be quoted. In the absence of either, you will see that `grep` also finds the `abc` string.

### 19.2.1 Stream editing with `sed`

Unix has various tools for processing text files on a line-by-line basis. The stream editor `sed` is one example. If you have used the `vi` editor, you are probably used to a syntax like `s/foo/bar/` for making changes. With `sed`, you can do this on the commandline. For instance

```
sed 's/foo/bar/' myfile > mynewfile
```

will apply the substitute command `s/foo/bar/` to every line of `myfile`. The output is shown on your screen so you should capture it in a new file; see section 19.3.2 for more on output *redirection*.

### 19.2.2 Cutting up lines with `cut`

Another tool for editing lines is `cut`, which will cut up a line and display certain parts of it. For instance,

```
cut -c 2-5 myfile
```

will display the characters in position 2–5 of every line of `myfile`. Make a test file and verify this example.

Maybe more useful, you can give `cut` a delimiter character and have it split a line on occurrences of that delimiter. For instance, your system will mostly likely have a file `/etc/passwd` that contains user information<sup>2</sup>, with every line consisting of fields separated by colons. For instance:

```
daemon:*:1:1:System Services:/var/root:/usr/bin/false
nobody:*:-2:-2:Unprivileged User:/var/empty:/usr/bin/false
root:*:0:0:System Administrator:/var/root:/bin/sh
```

The seventh and last field is the login shell of the user; `/bin/false` indicates that the user is unable to log in.

You can display users and their login shells with:

```
cut -d ":" -f 1,7 /etc/passwd
```

This tells `cut` to use the colon as delimiter, and to print fields 1 and 7.

## 19.3 Command execution

### 19.3.1 Search paths

**Purpose.** In this section you will learn how Unix determines what to do when you type a command name.

2. This is traditionally the case; on Mac OS information about users is kept elsewhere and this file only contains system services.



If you type a command such as `ls`, the shell does not just rely on a list of commands: it will actually go searching for a program by the name `ls`. This means that you can have multiple different commands with the same name, and which one gets executed depends on which one is found first.

**Exercise.** What you may think of as ‘Unix commands’ are often just executable files in a system directory. Do *which* `ls`, and do an `ls -l` on the result

*Expected outcome.* The location of `ls` is something like `/bin/ls`. If you `ls` that, you will see that it is probably owned by root. Its executable bits are probably set for all users.

The locations where unix searches for commands is the ‘search path’, which is stored in the *environment variable* (for more details see below) `PATH`.

**Exercise.** Do `echo $PATH`. Can you find the location of `cd`? Are there other commands in the same location? Is the current directory ‘.’ in the path? If not, do `export PATH=".: $PATH"`. Now create an executable file `cd` in the current director (see above for the basics), and do `cd`.

*Expected outcome.* The path will be a list of colon-separated directories, for instance `/usr/bin:/usr/local/bin:/usr/X11R6/bin`. If the working directory is in the path, it will probably be at the end: `/usr/X11R6/bin:.` but most likely it will not be there. If you put ‘.’ at the start of the path, unix will find the local `cd` command before the system one.

Some people consider having the working directory in the path a security risk. If your directory is writable, someone could put a malicious script named `cd` (or any other system command) in your directory, and you would execute it unwittingly.

It is possible to define your own commands as aliases of existing commands.

**Exercise.** Do `alias chdir=cd` and convince yourself that now `chdir` works just like `cd`. Do `alias rm='rm -i'`; look up the meaning of this in the man pages. Some people find this alias a good idea; can you see why?

*Expected outcome.* The `-i` ‘interactive’ option for `rm` makes the command ask for confirmation before each delete. Since unix does not have a trashcan that needs to be emptied explicitly (as on Windows or the Mac OS), this can be a good idea.

### 19.3.2 Redirection and Pipelines

**Purpose.** In this section you will learn how to feed one command into another, and how to connect commands to input and output files.

So far, the unix commands you have used have taken their input from your keyboard, or from a file named on the command line; their output went to your screen. There are other possibilities for providing input from a file, or for storing the output in a file.

### 19.3.2.1 Input redirection

The `grep` command had two arguments, the second being a file name. You can also write `grep string < yourfile`, where the less-than sign means that the input will come from the named file, `yourfile`. This is known as *input redirection*.

### 19.3.2.2 Output redirection

Conversely, `grep string yourfile > outfile` will take what normally goes to the terminal, and *redirect* the output to `outfile`. The output file is created if it didn't already exist, otherwise it is overwritten. (To append, use `grep text yourfile >> outfile`.)

**Exercise.** Take one of the `grep` commands from the previous section, and send its output to a file. Check that the contents of the file are identical to what appeared on your screen before. Search for a string that does not appear in the file and send the output to a file. What does this mean for the output file?

*Expected outcome.* Searching for a string that does not occur in a file gives no terminal output. If you redirect the output of this `grep` to a file, it gives a zero size file. Check this with `ls` and `wc`.

### 19.3.2.3 Standard files

Unix has three standard files that handle input and output:

- `stdin` is the file that provides input for processes.
- `stdout` is the file where the output of a process is written.
- `stderr` is the file where error output is written.

In an interactive session, all three files are connected to the user terminal. Using input or output redirection then means that the input is taken or the output sent to a different file than the terminal.

### 19.3.2.4 Command redirection

Instead of taking input from a file, or sending output to a file, it is possible to connect two commands together, so that the second takes the output of the first as input. The syntax for this is `cmdone | cmdtwo`; this is called a pipeline. For instance, `grep a yourfile | grep b` finds all lines that contains both an `a` and a `b`.

**Exercise.** Construct a pipeline that counts how many lines there are in your file that contain the string `th`. Use the `wc` command (see above) to do the counting.

There are a few more ways to combine commands. Suppose you want to present the result of `wc` a bit nicely. Type the following command

```
echo The line count is wc -l foo
```

where `foo` is the name of an existing file. The way to get the actual line count echoed is by the backquote:

```
echo The line count is `wc -l foo`
```

Anything in between backquotes is executed before the rest of the command line is evaluated. The way `wc` is used here, it prints the file name. Can you find a way to prevent that from happening?

### 19.3.3 Processes

The Unix operating system can run many programs at the same time, by rotating through the list and giving each only a fraction of a second to run each time. The command `ps` can tell you everything that is currently running.

**Exercise.** Type `ps`. How many programs are currently running? By default `ps` gives you only programs that you explicitly started. Do `ps guwax` for a detailed list of everything that is running. How many programs are running? How many belong to the root user, how many to you?

*Expected outcome.* To count the programs belonging to a user, pipe the `ps` command through an appropriate `grep`, which can then be piped to `wc`.

In this long listing of `ps`, the second column contains the process numbers. Sometimes it is useful to have those. The `cut` command explained above can cut certain position from a line: type `ps guwax | cut -c 10-14`.

To get dynamic information about all running processes, use the `top` command. Read the man page to find out how to sort the output by CPU usage.

When you type a command and hit return, that command becomes, for the duration of its run, the *foreground process*. Everything else that is running at the same time is a *background process*.

Make an executable file `hello` with the following contents:

```
#!/bin/sh
while [ 1 ] ; do
    sleep 2
    date
done
```

and type `./hello`.

**Exercise.** Type `Control-z`. This suspends the foreground process. It will give you a number like `[1]` or `[2]` indicating that it is the first or second program that has been suspended or put in the background. Now type `bg` to put this process in the background. Confirm that there is no foreground process by hitting return, and doing an `ls`.

*Expected outcome.* After you put a process in the background, the terminal is available again to accept foreground commands. If you hit return, you should see the command prompt. However, the background process still keeps generating output.

**Exercise.** Type `jobs` to see the processes in the current session. If the process you just put in the background was number 1, type `fg %1`. Confirm that it is a foreground process again.

*Expected outcome.* If a shell is executing a program in the foreground, it will not accept command input, so hitting return should only produce blank lines.

**Exercise.** When you have made the `hello` script a foreground process again, you can kill it with `Control-C`. Try this. Start the script up again, this time as `./hello &` which immediately puts it in the background. You should also get output along the lines of `[1] 12345` which tells you that it is the first job you put in the background, and that 12345 is its process ID. Kill the script with `kill %1`. Start it up again, and kill it by using the process number.

*Expected outcome.* The command `kill 12345` using the process number is usually enough to kill a running program. Sometimes it is necessary to use `kill -9 12345`.

### 19.3.4 Shell customization

Above it was mentioned that `ls -F` is an easy way to see which files are regular, executable, or directories; by typing `alias ls='ls -F'` the `ls` command will automatically expanded to `ls -F` every time it is invoked. If you would like this behaviour in every login session, you can add the `alias` command to your `.profile` file. Other shells than `sh/bash` have other files for such customizations.

## 19.4 Scripting

The unix shells are also programming environments. You will learn more about this aspect of unix in this section.

### 19.4.1 Shell environment variables

Above you encountered `PATH`, which is an example of an shell, or environment, variable. These are variables that are known to the shell and that can be used by all programs run by the shell. You can see the full list of all variables known to the shell by typing `env`.

You can get the value of a shell variable by prefixing it with a dollar sign. Type the following two commands and compare the output:

```
echo PATH
echo $PATH
```

**Exercise.** Check on the value of the `HOME` variable by typing `echo $HOME`. Also find the value of `HOME` by piping `env` through `grep`.

Environment variables can be set in a number of ways. The simplest is by an assignment as in other programming languages.

**Exercise.** Type `a=5` on the commandline. This defines a variable `a`; check on its value by using the `echo` command.

*Expected outcome.* The shell will respond by typing the value 5.

*Caveats.* Beware not to have space around the equals sign; also be sure to use the dollar sign to print the value.

A variable set this way will be known to all subsequent commands you issue in this shell, but not to commands in new shells you start up. For that you need the *export* command. Reproduce the following session (the double percent sign is the command prompt):

```
%% a=20
%% echo $a
20
%% /bin/bash
%% echo $a

%% exit
exit
%% export a=21
%% /bin/bash
%% echo $a
21
%% exit
```

You can also temporarily set a variable. Replay this scenario:

1. Find an environment variable that does not have a value:

```
%% echo $b

%%
```

2. Write a short shell script to print this variable:

```
%% cat > echob
#!/bin/bash
echo $b
```

and of course make it executable: `chmod +x echob`.

3. Now call the script, preceding it with a setting of the variable `b`:

```
%% b=5 ./echob
5
```

The syntax where you set the value, as a prefix without using a separate command, sets the value just for that one command.

4. Show that the variable is still undefined:

```
%% echo $b

%%
```

That is, you defined the variable just for the execution of a single command.

In section 19.4.2 you will see that the `for` construct also defines a variable; section 19.4.3 shows some more built-in variables that apply in shell scripts.

## 19.4.2 Control structures

Like any good programming system, the shell has some control structures. Their syntax takes a bit of getting used to. (Different shells have different syntax; in this tutorial we only discuss the bash shell.)

In the bash shell, control structures can be written over several lines:

```
if [ $PATH = "" ] ; then
    echo "Error: path is empty"
fi
```

or on a single line:

```
if [ `wc -l file` -gt 100 ] ; then echo "file too long" ; fi
```

There are a number of tests defined, for instance `-f somefile` tests for the existence of a file. Change your script so that it will report `-1` if the file does not exist.

There are also loops. A `for` loop looks like

```
for var in listofitems ; do
    something with $var
done
```

This does the following:

- for each item in `listofitems`, the variable `var` is set to the item, and
- the loop body is executed.

As a simple example:

```
%% for x in a b c ; do echo $x ; done
a
b
c
```

In a more meaningful example, here is how you would make backups of all your `.c` files:

```
for cfile in *.c ; do
    cp $cfile $cfile.bak
done
```

Shell variables can be manipulated in a number of ways. Execute the following commands to see that you can remove trailing characters from a variable:

```
%% a=b.c
%% echo ${a%.c}
b
```

With this as a hint, write a loop that renames all your `.c` files to `.x` files.

### 19.4.3 Scripting

It is possible to write programs of unix shell commands. First you need to know how to put a program in a file and have it be executed. Make a file `script1` containing the following two lines:

```
#!/bin/bash
echo "hello world"
```

and type `./script1` on the command line. Result? Make the file executable and try again.

You can give your script command line arguments. If you want to be able to call

```
./script1 foo bar
```

you can use variables `$1`, `$2` et cetera in the script:

```
#!/bin/bash

echo "The first argument is $1"
echo "There were $# arguments in all"
```

Write a script that takes as input a file name argument, and reports how many lines are in that file.

Edit your script to test whether the file has less than 10 lines (use the `foo -lt bar` test), and if it does, `cat` the file. Hint: you need to use backquotes inside the test.

The number of command line arguments is available as `$#`. Add a test to your script so that it will give a helpful message if you call it without any arguments.

## 19.5 Expansion

The shell performs various kinds of expansion on a command line, that is, replacing part of the command-line with different text.

Brace expansion:

```
%% echo a{b,cc,ddd}e
abe acce addde
```

This can for instance be used to delete all extension of some base file name:

```
%% rm tmp.{c,s,o} # delete tmp.c tmp.s tmp.o
```

Tilde expansion gives your own, or someone else's home directory:

```
%% echo ~
/share/home/00434/eijkhout
%% echo ~eijkhout
/share/home/00434/eijkhout
```

Parameter expansion gives the value of shell variables:

```
%% x=5
%% echo $x
5
```

Undefined variables do not give an error message:

```
%% echo $y
```

There are many variations on parameter expansion. Above you already saw that you can strip trailing characters:

```
%% a=b.c
%% echo ${a%.c}
b
```

Here is how you can deal with undefined variables:

```
%% echo ${y:-0}
0
```

The backquote mechanism (section 19.3.2 above) is known as command substitution. It allows you to evaluate part of a command and use it as input for another. For example, if you want to ask what type of file the command `ls` is, do

```
%% file `which ls`
```

This first evaluates `which ls`, giving `/bin/ls`, and then evaluates `file /bin/ls`. As another example, here we backquote a whole pipeline, and do a test on the result:

```
%% echo 123 > w
%% cat w
123
%% wc -c w
 4 w
%% if [ `cat w | wc -c` -eq 4 ] ; then echo four ; fi
four
```



Unix shell programming is very much oriented towards text manipulation, but it is possible to do arithmetic. Arithmetic substitution tells the shell to treat the expansion of a parameter as a number:

```
%% x=1
%% echo $((x*2))
2
```

Integer ranges can be used as follows:

```
%% for i in {1..10} ; do echo $i ; done
1
2
3
4
5
6
7
8
9
10
```

### 19.6 Startup files

In this tutorial you have seen several mechanisms for customizing the behaviour of your shell. For instance, by setting the `PATH` variable you can extend the locations where the shell looks for executables. Other environment variables (section 19.4.1) you can introduce for your own purposes. Many of these customizations will need to apply to every sessions, so you can have *shell startup files* that will be read at the start of any session.

Unfortunately, there are several startup files, and which one gets read is a complicated functions of circumstances. Here is a good common sense guideline<sup>3</sup>:

- Have a `.profile` that does nothing but read the `.bashrc`:

```
# ~/.profile
if [ -f ~/.bashrc ]; then
    source ~/.bashrc
fi
```

- Your `.bashrc` does the actual customizations:

```
# ~/.bashrc
# make sure your path is updated
if [ -z ``$MYPATH`` ]; then
    export MYPATH=1
```

---

3. Many thanks for Robert McLay for figuring this out.

```
export PATH=$HOME/bin:$PATH
fi
```

## 19.7 Shell interaction

Interactive use of Unix, in contrast to script writing (section 19.4), is a complicated conversation between the user and the shell. You, the user, type a line, hit return, and the shell tries to interpret it. There are several cases.

- Your line contains one full command, such as `ls foo`: the shell will execute this command.
- You can put more than one command on a line, separated by semicolons: `mkdir foo; cd foo`. The shell will execute these commands in sequence.
- Your input line is not a full command, for instance `while [ 1 ]`. The shell will recognize that there is more to come, and use a different prompt to show you that it is waiting for the remainder of the command.
- Your input line would be a legitimate command, but you want to type more on a second line. In that case you can end your input line with a backslash character, and the shell will recognize that it needs to hold off on executing your command. In effect, the backslash will hide (*escape*) the return.

When the shell has collected a command line to execute, by using one or more of your input line or only part of one, as described just now, it will apply expansion to the command line (section 19.5). It will then interpret the commandline as a command and arguments, and proceed to invoke that command with the arguments as found.

There are some subtleties here. If you type `ls *.c`, then the shell will recognize the wildcard character and expand it to a command line, for instance `ls foo.c bar.c`. Then it will invoke the `ls` command with the argument list `foo.c bar.c`. Note that `ls` does not receive `*.c` as argument! In cases where you do want the unix command to receive an argument with a wildcard, you need to escape it so that the shell will not expand it. For instance, `find . -name \*.c` will make the shell invoke `find` with arguments `.-name *.c`.

## 19.8 The system and other users

Unix is a multi-user operating system. Thus, even if you use it on your own personal machine, you are a user with an *account* and you may occasionally have to type in your username and password.

If you are on your personal machine, you may be the only user logged in. On university machines or other servers, there will often be other users. Here are some commands relating to them.

`whoami` show your login name.

`who` show the other users currently logged in.

`finger otheruser` get information about another user; you can specify a user's login name here, or their real name, or other identifying information the system knows about.

`top` which processes are running on the system; use `top -u` to get this sorted the amount of cpu time they are currently taking. (On Linux, try also the `vmstat` command.)  
`uptime` how long has it been since your last reboot?

## 19.9 The `sed` and `awk` tools

Apart from fairly small utilities such as `tr` and `cut`, Unix some more powerful ones. In this section you will see two tools for line-by-line transformations on text files. Of course this tutorial merely touches on the depth of these tools; for more information see [1, 46].

### 19.9.1 `sed`

The streaming editor `sed` is like an editor by remote control, doing simple line edits with a commandline interface. Most of the time you will use `sed` as follows:

```
cat somefile | sed 's/abc/def/:g' > newfile
```

(The use of `cat` here is not strictly necessary.) The `s/abc/def/` part has the effect of replacing `abc` by `def` in every line; the `:g` modifier applies it to every instance in every line rather than just the first.

- If you have more than one edit, you can specify them with

```
sed -e 's/one/two/' -e 's/three/four/'
```

- If an edit needs to be done only on certain lines, you can specify that by prefixing the edit with the match string. For instance

```
sed '/^a/s/b/c/'
```

only applies the edit on lines that start with an `a`. (See section 19.2 for regular expressions.)

- Traditionally, `sed` could only function in a stream, so you the output file was always different from the input. The GNU version, which is standard on Linux systems, has a flag `-i` which edits ‘in place’:

```
sed -e 's/ab/cd/' -e 's/ef/gh/' -i thefile
```

### 19.9.2 `awk`

The `awk` utility also operates on each line, but it can be described as having a memory. An `awk` program consists of a sequence of pairs, where each pair consists of a match string and an action. The simplest `awk` program is

```
cat somefile | awk '{ print }'
```

where the match string is omitted, meaning that all lines match, and the action is to print the line. `Awk` breaks each line into fields separated by whitespace. A common application of `awk` is to print a certain field:

```
awk '{print $2}' file
```

prints the second field of each line.

Suppose you want to print all subroutines in a Fortran program; this can be accomplished with

```
awk '/subroutine/ {print}' yourfile.f
```

**Exercise 19.1.** Build a commandpipeline that prints of each subroutine header only the subroutine name. For this you first use `sed` to replace the parentheses by spaces, then `awk` to print the subroutine name field.

Awk has variables with which it can remember things. For instance, instead of just printing the second field of every line, you can make a list of them and print that later:

```
cat myfile | awk 'BEGIN {v="Fields:"} {v=v " " $2} END {print v}'
```

As another example of the use of variables, here is how you would print all lines in between a `BEGIN` and `END` line:

```
cat myfile | awk '/END/ {p=0} p==1 {print} /BEGIN/ {p=1} '
```

**Exercise 19.2.** The placement of the match with `BEGIN` and `END` may seem strange. Rearrange the `awk` program, test it out, and explain the results you get.

## 19.10 Review questions

**Exercise 19.3.** Write a shell script for making backups. When you call this script as `./backup somefile` it should test whether `somefile.bak` exists, and give a warning if it does. In either case, it should copy the original file to a backup.

## Chapter 20

### Compilers and libraries

#### 20.1 An introduction to binary files

**Purpose.** In this section you will be introduced to the different types of binary files that you encounter while programming.

One of the first things you become aware of when you start programming is the distinction between the readable source code, and the unreadable, but executable, program code. In this tutorial you will learn about a couple more file types:

- A source file can be compiled to an *object file*, which is a bit like a piece of an executable: by itself it does nothing, but it can be combined with other object files to form an executable.
- A *library* is a bundle of object files that can be used to form an executable. Often, libraries are written by an expert and contain code for specialized purposes such as linear algebra manipulations. Libraries are important enough that they can be commercial, to be bought if you need expert code for a certain purpose.

You will now learn how these types of files are created and used.

#### 20.2 Simple compilation

**Purpose.** In this section you will learn about executables and object files.

Let's start with a simple program that has the whole source in one file.

One file: `hello.c`

```
#include <stdlib.h>
#include <stdio.h>

int main() {
    printf("hello world\n");
    return 0;
}
```

Compile this program with your favourite compiler; we will use `gcc` in this tutorial, but substitute your own as desired. As a result of the compilation, a file `a.out` is created, which is the executable.

```
%% gcc hello.c
%% ./a.out
hello world
```

You can get a more sensible program name with the `-o` option:

```
%% gcc -o helloprog hello.c
%% ./helloprog
hello world
```

Now we move on to a program that is in more than one source file.

Main program: `fooprogram.c`

```
#include <stdlib.h>
#include <stdio.h>

extern bar(char*);

int main() {
    bar("hello world\n");
    return 0;
}
```

Subprogram: `fooprogram.c`

```
#include <stdlib.h>
#include <stdio.h>

void bar(char *s) {
    printf("%s", s);
    return;
}
```

As before, you can make the program with one command.

```
%% gcc -o foo fooprogram.c foosub.c
%% ./foo
hello world
```

However, you can also do it in steps, compiling each file separately and then linking them together.

```
%% gcc -c fooprogram.c
%% gcc -c foosub.c
%% gcc -o foo fooprogram.o foosub.o
%% ./foo
```

```
hello world
```

The `-c` option tells the compiler to compile the source file, giving an *object file*. The third command then acts as the *linker*, tying together the object files into an executable. (With programs that are spread over several files there is always the danger of editing a subroutine definition and then forgetting to update all the places it is used. See the ‘make’ tutorial, section 21, for a way of dealing with this.)

### 20.3 Libraries

**Purpose.** In this section you will learn about libraries.

If you have written some subprograms, and you want to share them with other people (perhaps by selling them), then handing over individual object files is inconvenient. Instead, the solution is to combine them into a library. First we look at *static libraries*, for which the *archive utility* `ar` is used. A static library is linked into your executable, becoming part of it. This may lead to large executables; you will learn about shared libraries next, which do not suffer from this problem.

Create a directory to contain your library (depending on what your library is for this can be a system directory such as `/usr/bin`), and create the library file there.

```
%% mkdir ../lib
%% ar cr ../lib/libfoo.a foosub.o
```

The `nm` command tells you what’s in the library:

```
%% nm ../lib/libfoo.a

../lib/libfoo.a(foosub.o) :
00000000 T _bar
          U _printf
```

Line with `T` indicate functions defined in the library file; a `U` indicates a function that is used.

The library can be linked into your executable by explicitly giving its name, or by specifying a library path:

```
%% gcc -o foo fooprogram.o ../lib/libfoo.a
# or
%% gcc -o foo fooprogram.o -L../lib -lfoo
%% ./foo
hello world
```

A third possibility is to use the `LD_LIBRARY_PATH` shell variable. Read the man page of your compiler for its use, and give the commandlines that create the `foo` executable, linking the library through this path.

Although they are somewhat more complicated to use, *shared libraries* have several advantages. For instance, since they are not linked into the executable but only loaded at runtime, they lead to (much) smaller executables. They are not created with `ar`, but through the compiler. For instance:

```

%% gcc -dynamiclib -o ../lib/libfoo.so foosub.o
%% nm ../lib/libfoo.so

../lib/libfoo.so(single module):
00000fc4 t __dyld_func_lookup
00000000 t __mh_dylib_header
00000fd2 T _bar
          U _printf
00001000 d dyld__mach_header
00000fb0 t dyld_stub_binding_helper

```

Shared libraries are not actually linked into the executable; instead, the executable will contain the information where the library is to be found at execution time:

```

%% gcc -o foo fooprogram.o -L../lib -Wl,-rpath,'pwd'../lib -lfoo
%% ./foo
hello world

```

The link line now contains the library path twice:

1. once with the `-L` directive so that the linker can resolve all references, and
2. once with the linker directive `-Wl,-rpath,'pwd'../lib` which stores the path into the executable so that it can be found at runtime.

Build the executable again, but without the `-Wl` directive. Where do things go wrong and why? You can also fix this problem by using `LD_LIBRARY_PATH`. Explore this.

Use the command `ldd` to get information about what shared libraries your executable uses. (On Mac OS X, use `otool -L` instead.)



## Chapter 21

### Managing projects with Make

The *Make* utility helps you manage the building of projects: its main task is to facilitate rebuilding only those parts of a multi-file project that need to be recompiled or rebuilt. This can save lots of time, since it can replace a minutes-long full installation by a single file compilation. *Make* can also help maintaining multiple installations of a program on a single machine, for instance compiling a library with more than one compiler, or compiling a program in debug and optimized mode.

*Make* is a Unix utility with a long history, and traditionally there are variants with slightly different behaviour, for instance on the various flavours of Unix such as HP-UX, AIX, IRIX. These days, it is advisable, no matter the platform, to use the GNU version of *Make* which has some very powerful extensions; it is available on all Unix platforms (on Linux it is the only available variant), and it is a *de facto* standard. The manual is available at <http://www.gnu.org/software/make/manual/make.html>, or you can read the book [121].

There are other build systems, most notably *Scons* and *Bjam*. We will not discuss those here. The examples in this tutorial will be for the C and Fortran languages, but *Make* can work with any language, and in fact with things like T<sub>E</sub>X that are not really a language at all; see section 21.6.

#### 21.1 A simple example

**Purpose.** In this section you will see a simple example, just to give the flavour of *Make*.

The files for this section can be downloaded from <http://tinyurl.com/ISTC-make-tutorial>.

##### 21.1.1 C

Make the following files:

```
foo.c
```

```
#include "bar.h"
int c=3;
int d=4;
int main()
{
    int a=2;
    return(bar(a*c*d));
}
```

bar.c

```
#include "bar.h"
int bar(int a)
{
    int b=10;
    return(b*a);
}
```

bar.h

```
extern int bar(int);
```

and a makefile:

Makefile

```
fooprogram : foo.o bar.o
    cc -o fooprogram foo.o bar.o
foo.o : foo.c
    cc -c foo.c
bar.o : bar.c
    cc -c bar.c
clean :
    rm -f *.o fooprogram
```

The makefile has a number of rules like

```
foo.o : foo.c
<TAB>cc -c foo.c
```

which have the general form

```
target : prerequisite(s)
<TAB>rule(s)
```

where the rule lines are indented by a TAB character.

A rule, such as above, states that a ‘target’ file `foo.o` is made from a ‘prerequisite’ `foo.c`, namely by executing the command `cc -c foo.c`. The precise definition of the rule is:

- if the target `foo.o` does not exist or is older than the prerequisite `foo.c`,
- then the command part of the rule is executed: `cc -c foo.c`
- If the prerequisite is itself the target of another rule, than that rule is executed first.

Probably the best way to interpret a rule is:

- if any prerequisite has changed,
- then the target needs to be remade,
- and that is done by executing the commands of the rule;
- checking the prerequisite requires a recursive application of `make`:
  - if the prerequisite does not exist, find a rule to create it;
  - if the prerequisite already exists, check applicable rules to see if it needs to be remade.

If you call `make` without any arguments, the first rule in the makefile is evaluated. You can execute other rules by explicitly invoking them, for instance `make foo.o` to compile a single file.

**Exercise.** Call `make`.

*Expected outcome.* The above rules are applied: `make` without arguments tries to build the first target, `fooprogram`. In order to build this, it needs the prerequisites `foo.o` and `bar.o`, which do not exist. However, there are rules for making them, which `make` recursively invokes. Hence you see two compilations, for `foo.o` and `bar.o`, and a link command for `fooprogram`.

*Caveats.* Typos in the makefile or in file names can cause various errors. In particular, make sure you use tabs and not spaces for the rule lines. Unfortunately, debugging a makefile is not simple. `Make`'s error message will usually give you the line number in the make file where the error was detected.

**Exercise.** Do `make clean`, followed by `mv foo.c boo.c` and `make` again. Explain the error message. Restore the original file name.

*Expected outcome.* `Make` will complain that there is no rule to make `foo.c`. This error was caused when `foo.c` was a prerequisite for making `foo.o`, and was found not to exist. `Make` then went looking for a rule to make it and no rule for creating `.c` files exists.

Now add a second argument to the function `bar`. This requires you to edit `bar.c` and `bar.h`: go ahead and make these edits. However, it also requires you to edit `foo.c`, but let us for now 'forget' to do that. We will see how `Make` can help you find the resulting error.

**Exercise.** Call `make` to recompile your program. Did it recompile `foo.c`?

*Expected outcome.* Even through conceptually `foo.c` would need to be recompiled since it uses the `bar` function, `Make` did not do so because the makefile had no rule that forced it.

In the makefile, change the line

```
foo.o : foo.c
```

to

```
foo.o : foo.c bar.h
```

which adds `bar.h` as a prerequisite for `foo.o`. This means that, in this case where `foo.o` already exists, *Make* will check that `foo.o` is not older than any of its prerequisites. Since `bar.h` has been edited, it is younger than `foo.o`, so `foo.o` needs to be reconstructed.

**Exercise.** Confirm that the new makefile indeed causes `foo.o` to be recompiled if `bar.h` is changed. This compilation will now give an error, since you ‘forgot’ to edit the use of the `bar` function.

### 21.1.2 Fortran

Make the following files:

```
foomain.F
```

```
program test
use testmod

call func(1,2)

end program
```

```
foomod.F
```

```
module testmod

contains

subroutine func(a,b)
integer a,b
print *,a,b,c
end subroutine func

end module
```

and a makefile:

```
Makefile
```

```
fooprogram : foomain.o foomod.o
    gfortran -o fooprogram foo.o foomod.o
foomain.o : foomain.F
    gfortran -c foomain.F
foomod.o : foomod.F
    gfortran -c foomod.F
clean :
    rm -f *.o fooprogram
```

If you call `make`, the first rule in the makefile is executed. Do this, and explain what happens.

**Exercise.** Call `make`.

*Expected outcome.* The above rules are applied: `make` without arguments tries to build the first target, `foomain`. In order to build this, it needs the prerequisites `foomain.o` and `foomod.o`, which do not exist. However, there are rules for making them, which `make` recursively invokes. Hence you see two compilations, for `foomain.o` and `foomod.o`, and a link command for `fooprogram`.

*Caveats.* Typos in the makefile or in file names can cause various errors. Unfortunately, debugging a makefile is not simple. You will just have to understand the errors, and make the corrections.

**Exercise.** Do `make clean`, followed by `mv foomod.c boomod.c` and `make` again. Explain the error message. Restore the original file name.

*Expected outcome.* `Make` will complain that there is no rule to make `foomod.c`. This error was caused when `foomod.c` was a prerequisite for `foomod.o`, and was found not to exist. `Make` then went looking for a rule to make it, and no rule for making `.F` files exists.

Now add an extra parameter to `func` in `foomod.F` and recompile.

**Exercise.** Call `make` to recompile your program. Did it recompile `foomain.F`?

*Expected outcome.* Even though conceptually `foomain.F` would need to be recompiled, `Make` did not do so because the makefile had no rule that forced it.

Change the line

```
foomain.o : foomain.F
```

to

```
foomain.o : foomain.F foomod.o
```

which adds `foomod.o` as a prerequisite for `foomain.o`. This means that, in this case where `foomain.o` already exists, `Make` will check that `foomain.o` is not older than any of its prerequisites. Recursively, `Make` will then check if `foomode.o` needs to be updated, which is indeed the case. After recompiling `foomode.F`, `foomode.o` is younger than `foomain.o`, so `foomain.o` will be reconstructed.

**Exercise.** Confirm that the corrected makefile indeed causes `foomain.F` to be recompiled.

### 21.1.3 About the make file

The make file needs to be called `makefile` or `Makefile`; it is not a good idea to have files with both names in the same directory. If you want `Make` to use a different file as make file, use the syntax `make -f My_Makefile`.

## 21.2 Variables and template rules

**Purpose.** In this section you will learn various work-saving mechanisms in *Make*, such as the use of variables and of template rules.

### 21.2.1 Makefile variables

It is convenient to introduce variables in your makefile. For instance, instead of spelling out the compiler explicitly every time, introduce a variable in the makefile:

```
CC = gcc
FC = gfortran
```

and use `${CC}` or `${FC}` on the compile lines:

```
foo.o : foo.c
    ${CC} -c foo.c
foomain.o : foomain.F
    ${FC} -c foomain.F
```

**Exercise.** Edit your makefile as indicated. First do `make clean`, then `make foo(C)` or `make fooprogram` (Fortran).

*Expected outcome.* You should see the exact same compile and link lines as before.

*Caveats.* Unlike in the shell, where braces are optional, variable names in a makefile have to be in braces or parentheses. Experiment with what happens if you forget the braces around a variable name.

One advantage of using variables is that you can now change the compiler from the commandline:

```
make CC="icc -O2"
make FC="gfortran -g"
```

**Exercise.** Invoke *Make* as suggested (after `make clean`). Do you see the difference in your screen output?

*Expected outcome.* The compile lines now show the added compiler option `-O2` or `-g`.

*Make* also has *automatic variables*:

- `$@` The target. Use this in the link line for the main program.
- `^` The list of prerequisites. Use this also in the link line for the program.
- `<` The first prerequisite. Use this in the compile commands for the individual object files.
- `*` The stem of the target by stripping any extension.

Using these variables, the rule for `fooprogram` becomes

```
fooprogram : foo.o bar.o
             ${CC} -o $@ $^
```

and a typical compile line becomes

```
foo.o : foo.c bar.h
       ${CC} -c $<
```

You can also declare a variable

```
THEPROGRAM = fooprogram
```

and use this variable instead of the program name in your makefile. This makes it easier to change your mind about the name of the executable later.

**Exercise.** Edit your makefile to add this variable definition, and use it instead of the literal program name. Construct a commandline so that your makefile will build the executable `fooprogram_v2`.

*Expected outcome.* You need to specify the `THEPROGRAM` variable on the commandline using the syntax `make VAR=value`.

*Caveats.* Make sure that there are no spaces around the equals sign in your commandline.

### 21.2.2 Template rules

So far, you wrote a separate rule for each file that needed to be compiled. However, the rules for the various `.c` files are very similar:

- the rule header (`foo.o : foo.c`) states that a source file is a prerequisite for the object file with the same base name;
- and the instructions for compiling (`${CC} -c $<`) are even character-for-character the same, now that you are using *Make's* built-in variables;
- the only rule with a difference is

```
foo.o : foo.c bar.h
       ${CC} -c $<
```

where the object file depends on the source file and another file.

We can take the commonalities and summarize them in one *template rule*<sup>1</sup>:

```
%.o : %.c
     ${CC} -c $<
%.o : %.F
     ${FC} -c $<
```

---

1. This mechanism is the first instance you'll see that only exists in GNU make, though in this particular case there is a similar mechanism in standard make. That will not be the case for the wildcard mechanism in the next section.

This states that any object file depends on the C or Fortran file with the same base name. To regenerate the object file, invoke the C or Fortran compiler with the `-c` flag. These template rules can function as a replacement for the multiple specific targets in the makefiles above, except for the rule for `foo.o`.

The dependence of `foo.o` on `bar.h`, or `foomain.o` on `foomod.o`, can be handled by adding a rule

```
# C
foo.o : bar.h
# Fortran
foomain.o : foomod.o
```

with no further instructions. This rule states, ‘if file `bar.h` or `foomod.o` changed, file `foo.o` or `foomain.o` needs updating’ too. *Make* will then search the makefile for a different rule that states how this updating is done, and it will find the template rule.

**Exercise.** Change your makefile to incorporate these ideas, and test.

### 21.2.3 Wildcards

Your makefile now uses one general rule for compiling any source file. Often, your source files will be all the `.c` or `.F` files in your directory, so is there a way to state ‘compile everything in this directory’? Indeed there is.

Add the following lines to your makefile, and use the variable `COBJECTS` or `FOBJECTS` wherever appropriate. The command *wildcard* gives the result of `ls`, and you can manipulate file names with *patsubst*.

```
# wildcard: find all files that match a pattern
CSOURCES := ${wildcard *.c}
# pattern substitution: replace one pattern string by another
COBJECTS := ${patsubst %.c,%.o,${SOURCES}}

FSOURCES := ${wildcard *.F}
FOBJECTS := ${patsubst %.F,%.o,${SOURCES}}
```

### 21.2.4 Conditionals

There are various ways of making the behaviour of a makefile dynamic. You can for instance put a shell conditional in an action line. However, this can make for a cluttered makefile; an easier way is to use makefile conditionals. There are two types of conditionals: tests on string equality, and tests on environment variables.

The first type looks like



```
ifeq "${HOME}" "/home/thisisme"
  # case where the executing user is me
else
  # case where it's someone else
endif
```

and in the second case the test looks like

```
ifdef SOME_VARIABLE
```

The text in the true and false part can be most any part of a makefile. For instance, it is possible to let one of the action lines in a rule be conditionally included. However, most of the times you will use conditionals to make the definition of variables dependent on some condition.

**Exercise.** Let's say you want to use your makefile at home and at work. At work, your employer has a paid license to the Intel compiler `icc`, but at home you use the open source Gnu compiler `gcc`. Write a makefile that will work in both places, setting the appropriate value for `CC`.

### 21.3 Miscellanea

#### 21.3.1 What does this makefile do?

Above you learned that issuing the `make` command will automatically execute the first rule in the makefile. This is convenient in one sense<sup>2</sup>, and inconvenient in another: the only way to find out what possible actions a makefile allows is to read the makefile itself, or the – usually insufficient – documentation.

A better idea is to start the makefile with a target

```
info :
    @echo "The following are possible:"
    @echo "  make"
    @echo "  make clean"
```

Now `make` without explicit targets informs you of the capabilities of the makefile.

If your makefile gets longer, you might want to document each section like this. This runs into a problem: you can not have two rules with the same target, `info` in this case. However, if you use a double colon it is possible. Your makefile would have the following structure:

```
info ::
    @echo "The following target are available:"
    @echo "  make install"
```

---

2. There is a convention among software developers that a package can be installed by the sequence `./configure ; make ; make install`, meaning: Configure the build process for this computer, Do the actual build, Copy files to some system directory such as `/usr/bin`.

```

install :
    # ..... instructions for installing
info ::
    @echo "  make clean"
clean :
    # ..... instructions for cleaning

```

### 21.3.2 Phony targets

The example makefile contained a target `clean`. This uses the *Make* mechanisms to accomplish some actions that are not related to file creation: calling `make clean` causes *Make* to reason ‘there is no file called `clean`, so the following instructions need to be performed’. However, this does not actually cause a file `clean` to spring into being, so calling `make clean` again will make the same instructions being executed.

To indicate that this rule does not actually make the target, declare

```
.PHONY : clean
```

One benefit of declaring a target to be phony, is that the *Make* rule will still work, even if you have a file named `clean`.

### 21.3.3 Predefined variables and rules

Calling `make -p yourtarget` causes `make` to print out all its actions, as well as the values of all variables and rules, both in your makefile and ones that are predefined. If you do this in a directory where there is no makefile, you’ll see that `make` actually already knows how to compile `.c` or `.F` files. Find this rule and find the definition of the variables in it.

You see that you can customize `make` by setting such variables as `CFLAGS` or `FFLAGS`. Confirm this with some experimentation. If you want to make a second makefile for the same sources, you can call `make -f othermakefile` to use this instead of the default `Makefile`.

Note, by the way, that both `makefile` and `Makefile` are legitimate names for the default makefile. It is not a good idea to have both `makefile` and `Makefile` in your directory.

### 21.3.4 Using the target as prerequisite

Suppose you have two different targets that are treated largely the same. You would want to write:

```

PROGS = myfoo other
${PROGS} : $@.o # this is wrong!!
    ${CC} -o $@ $@.o ${list of libraries goes here}

```

and saying `make myfoo` would cause

## 21. Managing projects with Make

---

```
cc -c myfoo.c
cc -o myfoo myfoo.o ${list of libraries}
```

and likewise for `make other`. What goes wrong here is the use of `$.o` as prerequisite. In Gnu Make, you can repair this as follows<sup>3</sup>:

```
.SECONDEXPANSION:
${PROGS} : $$@.o
          ${CC} -o $@ $@.o ${list of libraries goes here}
```

**Exercise.** Write a second main program `foosecond.c` or `foosecond.F`, and change your makefile so that the calls `make foo` and `make foosecond` both use the same rule.

### 21.4 Shell scripting in a Makefile

**Purpose.** In this section you will see an example of a longer shell script appearing in a makefile rule.

In the makefiles you have seen so far, the command part was a single line. You can actually have as many lines there as you want. For example, let us make a rule for making backups of the program you are building.

Add a `backup` rule to your makefile. The first thing it needs to do is make a backup directory:

```
.PHONY : backup
backup :
    if [ ! -d backup ] ; then
        mkdir backup
    fi
```

Did you type this? Unfortunately it does not work: every line in the command part of a makefile rule gets executed as a single program. Therefore, you need to write the whole command on one line:

```
backup :
    if [ ! -d backup ] ; then mkdir backup ; fi
```

or if the line gets too long:

```
backup :
    if [ ! -d backup ] ; then \
        mkdir backup ; \
    fi
```

---

3. Technical explanation: Make will now look at lines twice: the first time `$$` gets converted to a single `$`, and in the second pass `$@` becomes the name of the target.

Next we do the actual copy:

```
backup :
    if [ ! -d backup ] ; then mkdir backup ; fi
    cp myprog backup/myprog
```

But this backup scheme only saves one version. Let us make a version that has the date in the name of the saved program.

The Unix `date` command can customize its output by accepting a format string. Type the following:  
`date` This can be used in the makefile.

**Exercise.** Edit the `cp` command line so that the name of the backup file includes the current date.

*Expected outcome.* Hint: you need the backquote. Consult the Unix tutorial, section 19.3.2.4, if you do not remember what backquotes do.

If you are defining shell variables in the command section of a makefile rule, you need to be aware of the following. Extend your `backup` rule with a loop to copy the object files:

```
backup :
    if [ ! -d backup ] ; then mkdir backup ; fi
    cp myprog backup/myprog
    for f in ${OBJS} ; do \
        cp $f backup ; \
    done
```

(This is not the best way to copy, but we use it for the purpose of demonstration.) This leads to an error message, caused by the fact that *Make* interprets `$f` as an environment variable of the outer process. What works is:

```
backup :
    if [ ! -d backup ] ; then mkdir backup ; fi
    cp myprog backup/myprog
    for f in ${OBJS} ; do \
        cp $$f backup ; \
    done
```

(In this case *Make* replaces the double dollar by a single one when it scans the commandline. During the execution of the commandline, `$f` then expands to the proper filename.)

## 21.5 Practical tips for using Make

Here are a couple of practical tips.

- *Debugging* a makefile is often frustratingly hard. Just about the only tool is the `-p` option, which prints out all the rules that *Make* is using, based on the current makefile.

- You will often find yourself first typing a make command, and then invoking the program. Most Unix shells allow you to use commands from the *shell command history* by using the up arrow key. Still, this may get tiresome, so you may be tempted to write

```
make myprogram ; ./myprogram -options
```

and keep repeating this. There is a danger in this: if the make fails, for instance because of compilation problems, your program will still be executed. Instead, write

```
make myprogram && ./myprogram -options
```

which executes the program conditional upon make concluding successfully.

### 21.6 A Makefile for L<sup>A</sup>T<sub>E</sub>X

The *Make* utility is typically used for compiling programs, but other uses are possible too. In this section, we will discuss a makefile for L<sup>A</sup>T<sub>E</sub>X documents.

We start with a very basic makefile:

```
info :
    @echo "Usage: make foo"
    @echo "where foo.tex is a LaTeX input file"

%.pdf : %.tex
    pdflatex $<
```

The command `make myfile.pdf` will invoke `pdflatex myfile.tex`, if needed, once. Next we repeat invoking `pdflatex` until the log file no longer reports that further runs are needed:

```
%.pdf : %.tex
    pdflatex $<
    while [ `cat ${basename $@}.log | grep "Rerun to get" \
        | wc -l` -gt 0 ] ; do \
        pdflatex $< ; \
    done
```

We use the `${basename fn}` macro to extract the base name without extension from the target name.

In case the document has a bibliography or index, we run `bibtex` and `makeindex`.

```
%.pdf : %.tex
    pdflatex ${basename $@}
    -bibtex ${basename $@}
    -makeindex ${basename $@}
    while [ `cat ${basename $@}.log | grep "Rerun to get" \
```

```

        | wc -l` -gt 0 ] ; do \
    pdflatex ${basename $@} ; \
done

```

The minus sign at the start of the line means that *Make* should not abort if these commands fail.

Finally, we would like to use *Make*'s facility for taking dependencies into account. We could write a makefile that has the usual rules

```
mainfile.pdf : mainfile.tex includefile.tex
```

but we can also discover the include files explicitly. The following makefile is invoked with

```
make pdf TEXTFILE=mainfile
```

The pdf rule then uses some shell scripting to discover the include files (but not recursively), and it calls *Make* again, invoking another rule, and passing the dependencies explicitly.

```

pdf :
    export includes=`grep "^input " ${TEXTFILE}.tex \
        | awk '{v=v FS $$2".tex"} END {print v}'` ; \
    ${MAKE} ${TEXTFILE}.pdf INCLUDES="$$includes"

%.pdf : %.tex ${INCLUDES}
    pdflatex $< ; \
    while [ `cat ${basename $@}.log \
        | grep "Rerun to get" | wc -l` -gt 0 ] ; do \
        pdflatex $< ; \
    done

```

This shell scripting can also be done outside the makefile, generating the makefile dynamically.

## Chapter 22

### Source code control

*Source code control* systems, also called *revision control* or *version control* systems, are a way of storing software, where not only the current version is stored, but also all previous versions. This is done by maintaining a *repository* for all versions, while one or more users work on a ‘checked out’ copy of the latest version. Those of the users that are developers can then commit their changes to the repository. Other users then update their local copy. The repository typically resides on a remote machine that is reliably backup up.

There are various reasons for keeping your source in a repository.

- If you work in a team, it is the best way to synchronize your work with your colleagues. It is also a way to document what changes were made, by whom, and why.
- It will allow you to roll back a defective code to a version that worked.
- It allows you to have branches, for instance for customizations that need to be kept out of the main development line. If you are working in a team, a branch is a way to develop a major feature, stay up to date with changes your colleagues make, and only add your feature to the main development when it is sufficiently tested.
- If you work alone, it is a way to synchronize between more than one machine. (You could even imagine traveling without all your files, and installing them from the repository onto a borrowed machine as the need arises.)
- Having a source code repository is one way to backup your work.

There are various source code control systems; in this tutorial you can learn the basics of *Subversion* (also called *svn*), which is probably the most popular of the traditional source code control systems, and Mercurial (or *hg*), which is an example of the new generation of *distributed source code control* systems.

#### 22.1 Workflow in source code control systems

Source code control systems are built around the notion of *repository*: a central store of the files of a project, together with their whole history. Thus, a repository allows you to share files with multiple people, but also to roll back changes, apply patches to old version, et cetera.

The basic actions on a repository are:

- Creating the repository; this requires you to have space and write permissions on some server. Maybe your sysadmin has to do it for you.
- Checking out the repository, that is, making a local copy of its contents in your own space.
- Adding your changes to the repository, and
- Updating your local copy with someone else's changes.

Adding your own changes is not always possible: there are many projects where the developer allows you to check out the repository, but not to incorporate changes. Such a repository is said to be read-only.

Figure 22.1 illustrates these actions for the Subversion system. Users who have checked out the repository

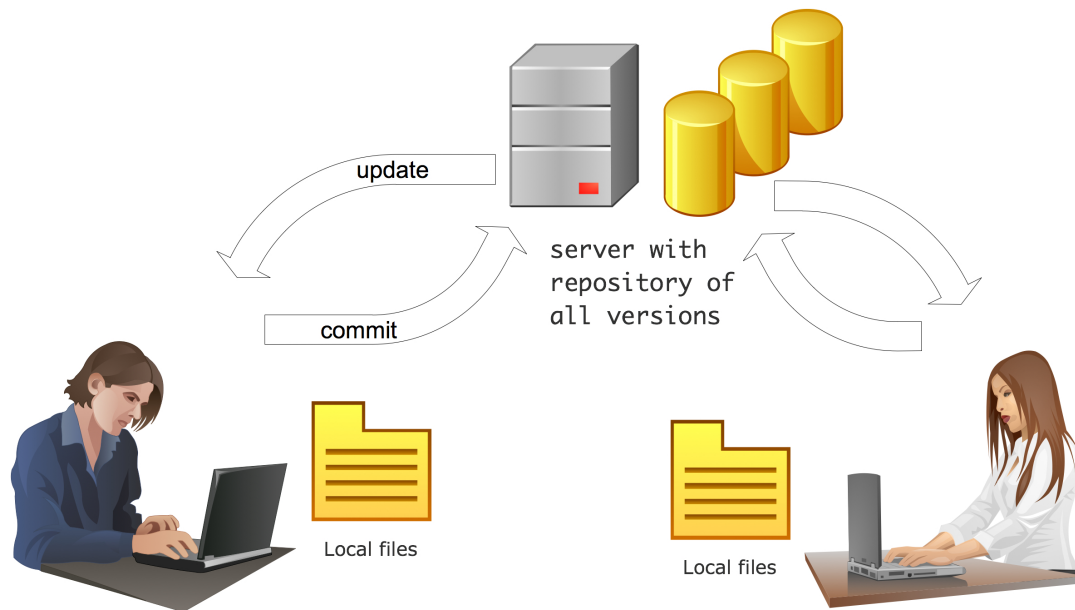

Figure 22.1: Workflow in traditional source code control systems such as Subversion

can edit files, and check in the new versions with the `commit` command; to get the changes committed by other users you use `update`.

One of the uses of committing is that you can roll your code back to an earlier version if you realize you made a mistake or introduced a bug. It also allows you to easily see the difference between different code version. However, committing many small changes may be confusing to other developers, for instance if they come to rely on something you introduce which you later remove again. For this reason, *distributed source code control* systems use two levels of repositories.

There is still a top level that is authoritative, but now there is a lower level, typically of local copies, where you can commit your changes and accumulate them until you finally add them to the central repository. This also makes it easier to contribute to a read-only repository: you make your local changes, and when you are finished you tell the developer to inspect your changes and pull them into the top level repository. This structure is illustrated in figure 22.2.



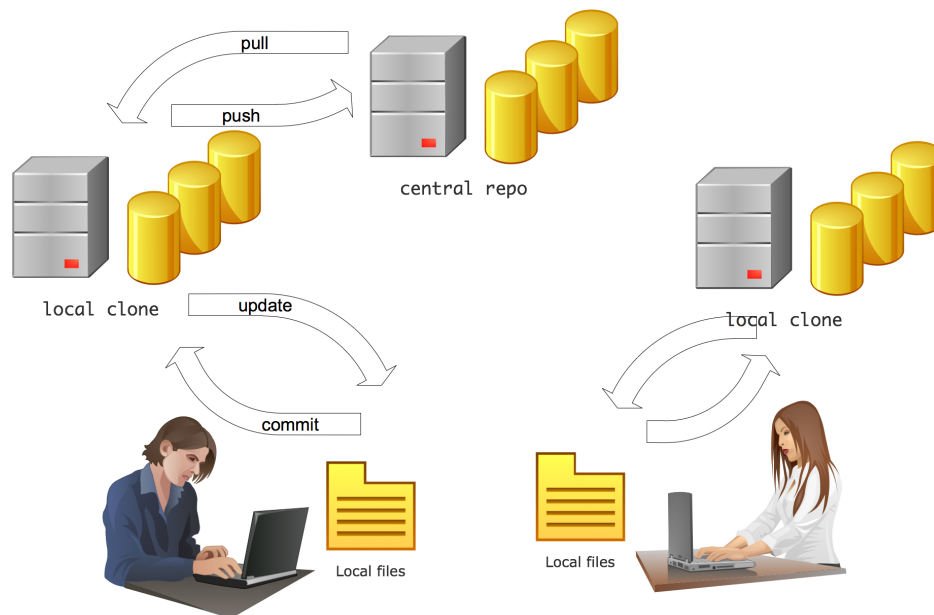

Figure 22.2: Workflow in distributed source code control systems such as Mercurial

## 22.2 Subversion or SVN

This lab should be done two people, to simulate a group of programmers working on a joint project. You can also do this on your own by using two copies of the repository.

### 22.2.1 Create and populate a repository

**Purpose.** In this section you will create a repository and make a local copy to work on.

First we need to have a repository. In practice, you will often use one that has been set up by a sysadmin, but there are several ways to set up a repository yourself.

- There are commercial and free hosting services such as *Google code* <http://code.google.com/projecthosting> (open source only) or *BitBucket* <https://bitbucket.org/> (this has favourable academic licenses). Once you create a repository there, you can make a local copy on your computer:

```
%% svn co http://yourservice.com//yourproject/ project
Checked out revision 0.
```

where `co` is short for ‘check out’<sup>1</sup>.

1. Alternatively, you can create a repository in the local file system with `svnadmin create ./repository --fs-type=fsfs` and check it out with `svn co file://path.../`; we will not go into this.

You now have an empty directory `project`.

**Exercise.** Go into the project directory and see if it is really empty.

*Expected outcome.* There is a hidden directory `.svn`

The project directory knows where the master copy of the repository is stored.

**Exercise.** Do `svn info`

*Expected outcome.* You will see the URL of the repository and the revision number

*Caveats.* Make sure you are in the right directory. In the outer directories, you will get `svn:`

`warning: '.' is not a working copy`

### 22.2.2 New files

**Purpose.** In this section you will make some simple changes: editing an existing file and creating a new file.

One student now makes a file to add to the repository<sup>2</sup>.

```
%% cat > firstfile
a
b
c
d
e
f
^D
```

This file is unknown to `svn`:

```
%% svn status
?      firstfile
```

We need to declare the file as belonging to the repository; a subsequent `svn commit` command then copies it into the master repository.

```
%% svn add firstfile
A      firstfile
%% svn status
A      firstfile
%% svn commit -m "made a first file"
Adding      firstfile
Transmitting file data .
Committed revision 1.
```

---

2. It is also possible to use `svn import` to create a whole repository from an existing directory tree.

**Exercise.** The second student can now do `svn update` to update their copy of the repository

*Expected outcome.* `svn` should report `A firstfile` and `Updated to revision 1..` Check that the contents of the file are correct.

*Caveats.* In order to do the update command, you have to be in a checked-out copy of the repository. Do `svn info` to make sure that you are in the right place.

**Exercise.** Let both students create a new directory with a few files. Declare the directory and commit it. Do `svn update` to obtain the changes the other mde.

*Expected outcome.* You can do `svn add` on the directory, this will also add the files contained in it.

*Caveats.* Do not forget the `commit`.

In order for `svn` to keep track of your files, you should never do `cp` or `mv` on files that are in the repository. Instead, do `svn cp` or `svn mv`. Likewise, there are commands `svn rm` and `svn mkdir`.

### 22.2.3 Conflicts

**Purpose.** In this section you will learn about how do deal with conflicting edits by two users of the same repository.

Now let's see what happens when two people edit the same file. Let both students make an edit to `firstfile`, but one to the top, the other to the bottom. After one student commits the edit, the other will see

```
%% emacs firstfile # make some change
%% svn commit -m "another edit to the first file"
Sending          firstfile
svn: Commit failed (details follow):
svn: Out of date: 'firstfile' in transaction '5-1'
```

The solution is to get the other edit, and commit again. After the update, `svn` reports that it has resolved a conflict successfully.

```
%% svn update
G firstfile
Updated to revision 5.
%% svn commit -m "another edit to the first file"
Sending          firstfile
Transmitting file data .
Committed revision 6.
```

The `G` at the start of the line indicates that `svn` has resolved a conflicting edit.

If both students make edits on the same part of the file, `svn` can no longer resolve the conflicts. For instance, let one student insert a line between the first and the second, and let the second student edit the second line. Whoever tries to commit second, will get messages like this:

```
%% svn commit -m "another edit to the first file"
svn: Commit failed (details follow):
svn: Aborting commit: '/share/home/12345/yourname/myproject/firstfile'
remains in conflict
%% svn update
C firstfile
Updated to revision 7.
```

Subversion will give you several options. For instance, you can type `e` to open the file in an editor. You can also type `p` for ‘postpone’ and edit it later. Opening the file in an editor, it will look like

```
aa
<<<<<<< .mine
bb
=====
123
b
>>>>>>> .r7
cc
```

indicating the difference between the local version (‘mine’) and the remote. You need to edit the file to resolve the conflict.

After this, you tell `svn` that the conflict was resolved, and you can commit:

```
%% svn resolved firstfile
Resolved conflicted state of 'firstfile'
%% svn commit -m "another edit to the first file"
Sending          firstfile
Transmitting file data .
Committed revision 8.
```

The other student then needs to do another update to get the correction.

#### 22.2.4 Inspecting the history

**Purpose.** In this section, you will learn how to get information about the repository.

You’ve already seen `svn info` as a way of getting information about the repository. To get the history, do `svn log` to get all log messages, or `svn log 2:5` to get a range.

To see differences in various revisions of individual files, use `svn diff`. First do `svn commit` and `svn update` to make sure you are up to date. Now do `svn diff firstfile`. No output, right? Now make an edit in `firstfile` and do `svn diff firstfile` again. This gives you the difference between the last committed version and the working copy.

You can also ask for differences between committed versions with `svn diff -r 4:6 firstfile`.

The output of this diff command is a bit cryptic, but you can understand it without too much trouble. There are also fancy GUI implementations of `svn` for every platform that show you differences in a much nicer way.

If you simply want to see what a file used to look like, do `svn cat -r 2 firstfile`. To get a copy of a certain revision of the repository, do `svn export -r 3 . ../rev3`, which exports the repository at the current directory ('dot') to the directory `../rev3`.

If you save the output of `svn diff`, it is possible to apply it with the Unix `patch` command. This is a quick way to send patches to someone without them needing to check out the repository.

### 22.2.5 Shuffling files around

We now realize that we really wanted all these files in a subdirectory in the repository. First we create the directory, putting it under `svn` control:

```
%% svn mkdir trunk
A      trunk
```

Then we move all files there, again prefixing all commands with `svn`:

```
%% for f in firstfile otherfile myfile mysecondfile ; do \
    svn mv $f trunk/ ; done
A      trunk/firstfile
D      firstfile
A      trunk/otherfile
D      otherfile
A      trunk/myfile
D      myfile
A      trunk/mysecondfile
D      mysecondfile
```

Finally, we commit these changes:

```
%% svn commit -m "trunk created"
Deleting      firstfile
Adding        trunk/firstfile
Deleting      myfile
Deleting      mysecondfile
Deleting      otherfile
Adding        trunk
Adding        trunk/myfile
Adding        trunk/mysecondfile
Adding        trunk/otherfile
```

You probably now have picked up on the message that you always use `svn` to do file manipulations. Let's pretend this has slipped your mind.

**Exercise.** Create a file `somefile` and commit it to the repository. Then do `rm somefile`, thereby deleting a file without `svn` knowing about it. What is the output of `svn status`?

*Expected outcome.* `svn` indicates with an exclamation point that the file has disappeared.

You can fix this situation in a number of ways:

- `svn revert` restores the file to the state in which it was last restored. For a deleted file, this means that it is brought back into existence from the repository. This command is also useful to undo any local edits, if you change your mind about something.
- `svn rm firstfile` is the official way to delete a file. You can do this even if you have already deleted the file outside `svn`.
- Sometimes `svn` will get confused about your attempts to delete a file. You can then do `svn --force rm yourfile`.

### 22.2.6 Branching and merging

Suppose you want to tinker with the repository, while still staying up to date with changes that other people make.

```
%% svn copy \  
  <the URL of your repository>/trunk \  
  <the URL of your repository>/onebranch \  
  -m "create a branch"
```

```
Committed revision 11.
```

You can check this out as before:

```
%% svn co <the URL of your repository>/onebranch \  
  projectbranch  
A projectbranch/mysecondfile  
A projectbranch/otherfile  
A projectbranch/myfile  
A projectbranch/firstfile  
Checked out revision 11.
```

Now, if you make edits in this branch, they will not be visible in the trunk:

```
%% emacs firstfile # do some edits here  
%% svn commit -m "a change in the branch"  
Sending          firstfile  
Transmitting file data .  
Committed revision 13.
```

## 22. Source code control

---

```
%% (cd ../myproject/trunk/ ; svn update )
At revision 13.
```

On the other hand, edits in the main trunk can be pulled into this branch:

```
%% svn merge ^/trunk
--- Merging r13 through r15 into '.':
U    secondfile
```

When you are done editing, the branch edits can be added back to the trunk. For this, it is best to have a clean checkout of the branch:

```
%% svn co file://`pwd`/repository/trunk mycleanproject
A    # all the current files
```

and then do a special merge:

```
%% cd mycleanproject
%% svn merge --reintegrate ^/branch
--- Merging differences between repository URLs into '.':
U    firstfile
U    .
%% svn info
Path: .
URL: <the URL of your repository>/trunk
Repository Root: <the URL of your repository>
Repository UUID: dc38b821-b9c6-4a1a-a194-a894fbald7e7
Revision: 16
Node Kind: directory
Schedule: normal
Last Changed Author: build
Last Changed Rev: 14
Last Changed Date: 2009-05-18 13:34:55 -0500 (Mon, 18 May 2009)
%% svn commit -m "trunk updates from the branch"
Sending          .
Sending          firstfile
Transmitting file data .
Committed revision 17.
```

### 22.2.7 Repository browsers

The `svn` command can give you some amount of information about a repository, but there are graphical tools that are easier to use and that give a better overview of a repository. For the common platforms, several such tools exist, free or commercial. Here is a browser based tool: <http://www.websvn.info>.

## 22.3 Mercurial or hg

Mercurial is one of a new generation of *distributed source code control* systems. Many of its commands are the same as for subversion, but there are some new ones, corresponding to the new level of sophistication.

A good introduction to Mercurial can be found at <http://www.hginit.com/>.

This lab should be done two people, to simulate a group of programmers working on a joint project. You can also do this on your own by using two clones of the repository, preferably opening two windows on your computer.

### 22.3.1 Create and populate a repository

**Purpose.** In this section you will create a repository and make a local copy to work on.

First we need to have a repository. In practice, you will often use one that has been previously set up, but there are several ways to set up a repository yourself. There are commercial and free hosting services such as <http://bitbucket.org>. (Academic users can have more private repositories.)

Let's assume that one student has created a repository `your-project` on Bitbucket. Both students can then clone it:

```
%% hg clone https://YourName@bitbucket.org/YourName/your-project
updating to branch default
0 files updated, 0 files merged, 0 files removed,
  0 files unresolved
```

You now have an empty directory `your-project`.

**Exercise.** Go into the project directory and see if it is really empty.

*Expected outcome.* There is a hidden directory `.hg`

### 22.3.2 New files

**Purpose.** In this section you will make some simple changes: editing an existing file and creating a new file.

One student now makes a file to add to the repository:

```
%% cat > firstfile
a
b
c
d
e
```



```
f
^D
```

(where `^D` stands for control-D, which terminates the input.) This file is unknown to hg:

```
%% hg status
? firstfile
```

We need to declare the file as belonging to the repository; a subsequent `hg commit` command then copies it into the repository.

```
%% hg add firstfile
%% hg status
A firstfile
%% hg commit -m "made a first file"
```

Unlike with Subversion, the file has now only been copied into the local repository, so that you can, for instance, roll back your changes. If you want this file added to the master repository, you need the `hg push` command:

```
%% hg push https://YourName@bitbucket.org/YourName/your-project
pushing to https://YourName@bitbucket.org/YourName/your-project
searching for changes
remote: adding changesets
remote: adding manifests
remote: adding file changes
remote: added 1 changesets with 1 changes to 1 files
remote: bb/acl: YourName is allowed. accepted payload.
```

In the push step you were probably asked for your password. You can prevent that by having some lines in your `$HOME/.hgrc` file:

```
[paths]
projectrepo = https://YourName:yourpassword@bitbucket.org/YourName/my-project
[ui]
username=Your Name <you@somewhere.youruniversity.edu>
```

Now the command `hg push projectrepo` will push the local changes to the global repository without asking for your password. Of course, now you have a file with a cleartext password, so you should set the permissions of this file correctly.

The second student now needs to update their repository. Just like the upload took two commands, this pass also takes two. First you do `hg pull` to update your local repository. This does not update the local files you have: for that you need to do `hg update`.

**Exercise.** Do this and check that the contents of the file are correct.

*Expected outcome.* In order to do the update command, you have to be in a checked-out copy of the repository.

*Caveats.*

**Exercise.** Let both students create a new directory with a few files. Declare the directory and commit it. Pull and update to obtain the changes the other made.

*Expected outcome.* You can do `hg add` on the directory, this will also add the files contained in it.

In order for Mercurial to keep track of your files, you should never do the shell commands `cp` or `mv` on files that are in the repository. Instead, do `hg cp` or `hg mv`. Likewise, there is a command `hg rm`.

### 22.3.3 Conflicts

**Purpose.** In this section you will learn about how to deal with conflicting edits by two users of the same repository.

Now let's see what happens when two people edit the same file. Let both students make an edit to `firstfile`, but one to the top, the other to the bottom. After one student commits the edit, the other can commit changes, after all, these only affect the local repository. However, trying to push that change gives an error:

```
%% emacs firstfile # make some change
%% hg commit -m ``first again``
%% hg push test
abort: push creates new remote head b0d31ea209b3!
(you should pull and merge or use push -f to force)
```

The solution is to get the other edit, and commit again. This takes a couple of commands:

```
%% hg pull myproject
searching for changes
adding changesets
adding manifests
adding file changes
added 1 changesets with 1 changes to 1 files (+1 heads)
(run 'hg heads' to see heads, 'hg merge' to merge)

%% hg merge
merging firstfile
0 files updated, 1 files merged, 0 files removed, 0 files unresolved
(branch merge, don't forget to commit)

%% hg status
M firstfile
%% hg commit -m ``my edit again``
%% hg push test
pushing to https://VictorEijkhout:***@bitbucket.org/
VictorEijkhout/my-project
searching for changes
```

## 22. Source code control

---

```
remote: adding changesets
remote: adding manifests
remote: adding file changes
remote: added 2 changesets with 2 changes to 1 files
remote: bb/acl: VictorEijkhout is allowed. accepted payload.
```

This may seem complicated, but you see that Mercurial prompts you for what commands to execute, and the workflow is clear, if you refer to figure 22.2.

**Exercise.** Do a `cat` on the file that both of you have been editing. You should find that both edits are incorporated. That is the ‘merge’ that Mercurial referred to.

If both students make edits on the same part of the file, Mercurial can no longer resolve the conflicts. For instance, let one student insert a line between the first and the second, and let the second student edit the second line. Whoever tries to push second, will get messages like this:

```
%% hg pull test
added 3 changesets with 3 changes to 1 files (+1 heads)
(run 'hg heads' to see heads, 'hg merge' to merge)
%% hg merge
merging firstfile
warning: conflicts during merge.
merging firstfile incomplete!
(edit conflicts, then use 'hg resolve --mark')
0 files updated, 0 files merged, 0 files removed, 1 files unresolved
use 'hg resolve' to retry unresolved file merges
or 'hg update -C .' to abandon
```

Mercurial will give you several options. It is easiest to resolve the conflict with a text editor. If you open the file that has the conflict you’ll see something like:

```
<<<<<<< local
aa
bbbb
=====
aaa
a2
b
>>>>>>> other
c
```

indicating the difference between the local version (‘mine’) and the other, that is the version that you pulled and tried to merge. You need to edit the file to resolve the conflict.

After this, you tell hg that the conflict was resolved:

```
hg resolve --mark
%% hg status
```

```
M firstfile
? firstfile.orig
```

After this you can commit and push again. The other student then needs to do another update to get the correction.

Not all files can be merged: for binary files Mercurial will ask you:

```
%% hg merge
merging proposal.tex
merging summary.tex
merking references.tex
no tool found to merge proposal.pdf
keep (l)ocal or take (o)ther? o
```

This means that the only choices are to keep your local version (type `l` and hit return) or take the other version (type `o` and hit return). In the case of a binary file that was obviously generated automatically, some people argue that they should not be in the repository to begin with.

#### 22.3.4 Inspecting the history

**Purpose.** In this section, you will learn how to get information about the repository.

If you want to know where you cloned a repository from, look in the file `.hg/hgrc`.

The main sources of information about the repository are `hg log` and `hg id`. The latter gives you global information, depending on what option you use. For instance, `hg id -n` gives the local revision number.

`hg log` gives you a list of all changesets so far, with the comments you entered.

`hg log -v` tells you what files were affected in each changeset.

`hg log -r 5` or `hg log -r 6:8` gives information on one or more changesets.

To see differences in various revisions of individual files, use `hg diff`. First make sure you are up to date. Now do `hg diff firstfile`. No output, right? Now make an edit in `firstfile` and do `hg diff firstfile` again. This gives you the difference between the last committed version and the working copy.

Check for yourself what happens when you do a commit but no push, and you issue the above diff command.

You can also ask for differences between committed versions with `hg diff -r 4:6 firstfile`.

The output of this diff command is a bit cryptic, but you can understand it without too much trouble. There are also fancy GUI implementations of hg for every platform that show you differences in a much nicer way.

If you simply want to see what a file used to look like, do `hg cat -r 2 firstfile`. To get a copy of a certain revision of the repository, do `hg export -r 3 . ../rev3`, which exports the repository at the current directory ('dot') to the directory `../rev3`.

If you save the output of `hg diff`, it is possible to apply it with the Unix `patch` command. This is a quick way to send patches to someone without them needing to check out the repository.

## Chapter 23

### Scientific Data Storage

There are many ways of storing data, in particular data that comes in arrays. A surprising number of people stores data in spreadsheets, then exports them to ascii files with comma or tab delimiters, and expects other people (or other programs written by themselves) to read that in again. Such a process is wasteful in several respects:

- The ascii representation of a number takes up much more space than the internal binary representation. Ideally, you would want a file to be as compact as the representation in memory.
- Conversion to and from ascii is slow; it may also lead to loss of precision.

For such reasons, it is desirable to have a file format that is based on binary storage. There are a few more requirements on a useful file format:

- Since binary storage can differ between platforms, a good file format is platform-independent. This will, for instance, prevent the confusion between *big-endian* and *little-endian* storage, as well as conventions of 32 versus 64 bit floating point numbers.
- Application data can be heterogeneous, comprising integer, character, and floating point data. Ideally, all this data should be stored together.
- Application data is also structured. This structure should be reflected in the stored form.
- It is desirable for a file format to be *self-documenting*. If you store a matrix and a right-hand side vector in a file, wouldn't it be nice if the file itself told you which of the stored numbers are the matrix, which the vector, and what the sizes of the objects are?

This tutorial will introduce the HDF5 library, which fulfills these requirements. HDF5 is a large and complicated library, so this tutorial will only touch on the basics. For further information, consult <http://www.hdfgroup.org/HDF5/>. While you do this tutorial, keep your browser open on <http://www.hdfgroup.org/HDF5/doc/> or [http://www.hdfgroup.org/HDF5/RM/RM\\_H5Front.html](http://www.hdfgroup.org/HDF5/RM/RM_H5Front.html) for the exact syntax of the routines.

#### 23.1 Introduction to HDF5

As described above, HDF5 is a file format that is machine-independent and self-documenting. Each HDF5 file is set up like a directory tree, with subdirectories, and leaf nodes which contain the actual data. This means that data can be found in a file by referring to its name, rather than its location in the file. In this

section you will learn to write programs that write to and read from HDF5 files. In order to check that the files are as you intend, you can use the `h5dump` utility on the command line.<sup>1</sup>

Just a word about compatibility. The HDF5 format is not compatible with the older version HDF4, which is no longer under development. You can still come across people using `hdf4` for historic reasons. This tutorial is based on HDF5 version 1.6. Some interfaces changed in the current version 1.8; in order to use 1.6 APIs with 1.8 software, add a flag `-DH5_USE_16_API` to your compile line.

Many HDF5 routines are about creating objects: file handles, members in a dataset, et cetera. The general syntax for that is

```
hid_t h_id;
h_id = H5Xsomething(...);
```

Failure to create the object is indicated by a negative return parameter, so it would be a good idea to create a file `myh5defs.h` containing:

```
#include "hdf5.h"
#define H5REPORT(e) \
    {if (e<0) {printf("\nHDF5 error on line %d\n\n",__LINE__); \
    return e;}}
```

and use this as:

```
#include "myh5defs.h"

hid_t h_id;
h_id = H5Xsomething(...); H5REPORT(h_id);
```

## 23.2 Creating a file

First of all, we need to create an HDF5 file.

```
hid_t file_id;
herr_t status;

file_id = H5Fcreate( filename, ... );
...
status = H5Fclose(file_id);
```

This file will be the container for a number of data items, organized like a directory tree.

**Exercise.** Create an HDF5 file by compiling and running the `create.c` example below.

1. In order to do the examples, the `h5dump` utility needs to be in your path, and you need to know the location of the `hdf5.h` and `libhdf5.a` and related library files.

*Expected outcome.* A file `file.h5` should be created.

*Caveats.* Be sure to add HDF5 include and library directories:

```
cc -c create.c -I. -I/opt/local/include
```

and

```
cc -o create create.o -L/opt/local/lib -lhdf5. The include and lib directories will be system dependent.
```

```
/*
 * File: create.c
 * Author: Victor Eijkhout
 */
#include "myh5defs.h"
#define FILE "file.h5"

main() {

    hid_t      file_id;    /* file identifier */
    herr_t      status;

    /* Create a new file using default properties. */
    file_id = H5Fcreate(FILE, H5F_ACC_TRUNC, H5P_DEFAULT, H5P_DEFAULT);
    H5REPORT(file_id);

    /* Terminate access to the file. */
    status = H5Fclose(file_id);
}

```

You can display the created file on the commandline:

```
%% h5dump file.h5
HDF5 "file.h5" {
GROUP "/" {
}
}

```

Note that an empty file corresponds to just the root of the directory tree that will hold the data.

### 23.3 Datasets

Next we create a dataset, in this example a 2D grid. To describe this, we first need to construct a dataspace:

```
dims[0] = 4; dims[1] = 6;
dataspace_id = H5Screate_simple(2, dims, NULL);
dataset_id = H5Dcreate(file_id, "/dset", dataspace_id, .... );
....
status = H5Dclose(dataset_id);

```

```
status = H5Sclose(dataspace_id);
```

Note that datasets and dataspace need to be closed, just like files.

**Exercise.** Create a dataset by compiling and running the `dataset.c` code below

*Expected outcome.* This creates a file `dset.h5` that can be displayed with `h5dump`.

```
/*
 * File: dataset.c
 * Author: Victor Eijkhout
 */
#include "myh5defs.h"
#define FILE "dset.h5"

main() {

    hid_t      file_id, dataset_id, dataspace_id; /* identifiers */
    hsize_t    dims[2];
    herr_t     status;

    /* Create a new file using default properties. */
    file_id = H5Fcreate(FILE, H5F_ACC_TRUNC, H5P_DEFAULT, H5P_DEFAULT);

    /* Create the data space for the dataset. */
    dims[0] = 4;
    dims[1] = 6;
    dataspace_id = H5Screate_simple(2, dims, NULL);

    /* Create the dataset. */
    dataset_id = H5Dcreate(file_id, "/dset", H5T_NATIVE_INT,
                          dataspace_id, H5P_DEFAULT);
    /*H5T_STD_I32BE*/

    /* End access to the dataset and release resources used by it. */
    status = H5Dclose(dataset_id);

    /* Terminate access to the data space. */
    status = H5Sclose(dataspace_id);

    /* Close the file. */
    status = H5Fclose(file_id);
}
```

We again view the created file online:

```
%% h5dump dset.h5
HDF5 "dset.h5" {
GROUP "/" {
```



```
DATASET "dset" {
  DATATYPE  H5T_STD_I32BE
  DATASPACE SIMPLE { ( 4, 6 ) / ( 4, 6 ) }
  DATA {
    (0,0): 0, 0, 0, 0, 0, 0,
    (1,0): 0, 0, 0, 0, 0, 0,
    (2,0): 0, 0, 0, 0, 0, 0,
    (3,0): 0, 0, 0, 0, 0, 0
  }
}
}
```

The datafile contains such information as the size of the arrays you store. Still, you may want to add related scalar information. For instance, if the array is output of a program, you could record with what input parameter was it generated.

```
parmspace = H5Screate(H5S_SCALAR);
parm_id = H5Dcreate
    (file_id, "/parm", H5T_NATIVE_INT, parmspace, H5P_DEFAULT);
```

**Exercise.** Add a scalar dataspace to the HDF5 file, by compiling and running the `parmwrite.c` code below.

*Expected outcome.* A new file `wdset.h5` is created.

```
/*
 * File: parmdatset.c
 * Author: Victor Eijkhout
 */
#include "myh5defs.h"
#define FILE "pdset.h5"

main() {

  hid_t      file_id, dataset_id, dataspace_id; /* identifiers */
  hid_t      parm_id, parmspace;
  hsize_t    dims[2];
  herr_t     status;

  /* Create a new file using default properties. */
  file_id = H5Fcreate(FILE, H5F_ACC_TRUNC, H5P_DEFAULT, H5P_DEFAULT);

  /* Create the data space for the dataset. */
  dims[0] = 4;
  dims[1] = 6;
  dataspace_id = H5Screate_simple(2, dims, NULL);
```

```

/* Create the dataset. */
dataset_id = H5Dcreate
    (file_id, "/dset", H5T_STD_I32BE, dataspace_id, H5P_DEFAULT);

/* Add a descriptive parameter */
parmspace = H5Screate(H5S_SCALAR);
parm_id = H5Dcreate
    (file_id, "/parm", H5T_NATIVE_INT, parmspace, H5P_DEFAULT);

/* End access to the dataset and release resources used by it. */
status = H5Dclose(dataset_id);
status = H5Dclose(parm_id);

/* Terminate access to the data space. */
status = H5Sclose(dataspace_id);
status = H5Sclose(parmspace);

/* Close the file. */
status = H5Fclose(file_id);
}

%% h5dump wdset.h5
HDF5 "wdset.h5" {
GROUP "/" {
  DATASET "dset" {
    DATATYPE  H5T_IEEE_F64LE
    DATASPACE  SIMPLE { ( 4, 6 ) / ( 4, 6 ) }
    DATA {
      (0,0): 0.5, 1.5, 2.5, 3.5, 4.5, 5.5,
      (1,0): 6.5, 7.5, 8.5, 9.5, 10.5, 11.5,
      (2,0): 12.5, 13.5, 14.5, 15.5, 16.5, 17.5,
      (3,0): 18.5, 19.5, 20.5, 21.5, 22.5, 23.5
    }
  }
  DATASET "parm" {
    DATATYPE  H5T_STD_I32LE
    DATASPACE  SCALAR
    DATA {
      (0): 37
    }
  }
}
}
}

```

## 23.4 Writing the data

The datasets you created allocate the space in the hdf5 file. Now you need to put actual data in it. This is done with the `H5Dwrite` call.

```
/* Write floating point data */
for (i=0; i<24; i++) data[i] = i+.5;
status = H5Dwrite
    (dataset, H5T_NATIVE_DOUBLE, H5S_ALL, H5S_ALL, H5P_DEFAULT,
     data);
/* write parameter value */
parm = 37;
status = H5Dwrite
    (parmset, H5T_NATIVE_INT, H5S_ALL, H5S_ALL, H5P_DEFAULT,
     &parm);

/*
 * File: parmwrite.c
 * Author: Victor Eijkhout
 */
#include "myh5defs.h"
#define FILE "wdset.h5"

main() {

    hid_t      file_id, dataset, dataspace; /* identifiers */
    hid_t      parmset, parmspace;
    hsize_t    dims[2];
    herr_t     status;
    double data[24]; int i, parm;

    /* Create a new file using default properties. */
    file_id = H5Fcreate(FILE, H5F_ACC_TRUNC, H5P_DEFAULT, H5P_DEFAULT);

    /* Create the dataset. */
    dims[0] = 4; dims[1] = 6;
    dataspace = H5Screate_simple(2, dims, NULL);
    dataset = H5Dcreate
        (file_id, "/dset", H5T_NATIVE_DOUBLE, dataspace, H5P_DEFAULT);

    /* Add a descriptive parameter */
    parmspace = H5Screate(H5S_SCALAR);
    parmset = H5Dcreate
        (file_id, "/parm", H5T_NATIVE_INT, parmspace, H5P_DEFAULT);

    /* Write data to file */
    for (i=0; i<24; i++) data[i] = i+.5;
    status = H5Dwrite
        (dataset, H5T_NATIVE_DOUBLE, H5S_ALL, H5S_ALL, H5P_DEFAULT,
         data); H5REPORT(status);
}
```

```

/* write parameter value */
parm = 37;
status = H5Dwrite
    (parmset, H5T_NATIVE_INT, H5S_ALL, H5S_ALL, H5P_DEFAULT,
     &parm); H5REPORT(status);

/* End access to the dataset and release resources used by it. */
status = H5Dclose(dataset);
status = H5Dclose(parmset);

/* Terminate access to the data space. */
status = H5Sclose(dataspace);
status = H5Sclose(parmspace);

/* Close the file. */
status = H5Fclose(file_id);
}

%% h5dump wdset.h5
HDF5 "wdset.h5" {
GROUP "/" {
  DATASET "dset" {
    DATATYPE  H5T_IEEE_F64LE
    DATASPACE  SIMPLE { ( 4, 6 ) / ( 4, 6 ) }
    DATA {
      (0,0): 0.5, 1.5, 2.5, 3.5, 4.5, 5.5,
      (1,0): 6.5, 7.5, 8.5, 9.5, 10.5, 11.5,
      (2,0): 12.5, 13.5, 14.5, 15.5, 16.5, 17.5,
      (3,0): 18.5, 19.5, 20.5, 21.5, 22.5, 23.5
    }
  }
  DATASET "parm" {
    DATATYPE  H5T_STD_I32LE
    DATASPACE  SCALAR
    DATA {
      (0): 37
    }
  }
}
}
}

```

If you look closely at the source and the dump, you see that the data types are declared as ‘native’, but rendered as LE. The ‘native’ declaration makes the datatypes behave like the built-in C or Fortran data types. Alternatively, you can explicitly indicate whether data is *little-endian* or *big-endian*. These terms describe how the bytes of a data item are ordered in memory. Most architectures use little endian, as you can see in the dump output, but, notably, IBM uses big endian.

### 23.5 Reading

Now that we have a file with some data, we can do the mirror part of the story: reading from that file. The essential commands are

```
h5file = H5Fopen( .... )
....
H5Dread( dataset, .... data .... )
```

where the `H5Dread` command has the same arguments as the corresponding `H5Dwrite`.

**Exercise.** Read data from the `wdset.h5` file that you create in the previous exercise, by compiling and running the `allread.c` example below.

*Expected outcome.* Running the `allread` executable will print the value 37 of the parameter, and the value 8.5 of the (1,2) data point of the array.

*Caveats.* Make sure that you run `parmwwrite` to create the input file.

```
/*
 * File: allread.c
 * Author: Victor Eijkhout
 */
#include "myh5defs.h"
#define FILE "wdset.h5"

main() {

    hid_t      file_id, dataset, parmset;
    herr_t     status;
    double data[24]; int parm;

    /* Open an existing file */
    file_id = H5Fopen(FILE, H5F_ACC_RDONLY, H5P_DEFAULT);
    H5REPORT(file_id);

    /* Locate the datasets. */
    dataset = H5Dopen(file_id, "/dset"); H5REPORT(dataset);
    parmset = H5Dopen(file_id, "/parm"); H5REPORT(parmset);

    /* Read data back */
    status = H5Dread
        (parmset, H5T_NATIVE_INT, H5S_ALL, H5S_ALL, H5P_DEFAULT,
         &parm); H5REPORT(status);
    printf("parameter value: %d\n", parm);

    status = H5Dread
        (dataset, H5T_NATIVE_DOUBLE, H5S_ALL, H5S_ALL, H5P_DEFAULT,
         data); H5REPORT(status);
    printf("arbitrary data point [1,2]: %e\n", data[1*6+2]);
```

```
/* Terminate access to the datasets */
status = H5Dclose(dataset); H5REPORT(status);
status = H5Dclose(parmset); H5REPORT(status);

/* Close the file. */
status = H5Fclose(file_id);
}
```

```
%% ./allread
parameter value: 37
arbitrary data point [1,2]: 8.500000e+00
```

## Chapter 24

### Scientific Libraries

There are many libraries for scientific computing. Some are specialized to certain application areas, others are quite general. In this section we will take a brief look at the PETSc library for sparse matrix computations, and the BLAS/Lapack libraries for dense computations.

#### 24.1 The Portable Extendable Toolkit for Scientific Computing

PETSc, the Portable Extendable Toolkit for Scientific Computation [], is a large powerful library, mostly concerned with linear and nonlinear system of equations that arise from discretized PDEs. Since it has many hundreds of routines (and a good manual already exists) we limit this tutorial to going through a few simple, yet representative, PETSc programs.

##### 24.1.1 What is in PETSc?

PETSc can be used as a library in the traditional sense, where you use some high level functionality, such as solving a nonlinear system of equations, in your program. However, it can also be used as a toolbox, to compose your own numerical applications using low-level tools.

- Linear system solvers (sparse/dense, iterative/direct)
- Nonlinear system solvers
- Tools for distributed matrices
- Support for profiling, debugging, graphical output

The basic functionality of PETSc can be extended through external packages:

- Dense linear algebra: Scalapack, Plapack
- Grid partitioning software: ParMetis, Jostle, Chaco, Party
- ODE solvers: PVODE
- Eigenvalue solvers (including SVD): SLEPc
- Optimization: TAO

### 24.1.2 Design of PETSc

PETSc has an object-oriented design, even though it is implemented in C, a not object oriented language. PETSc is also parallel: all objects in Petsc are defined on an MPI communicator (section 2.7.3.3). For an object such as a matrix this means that it is stored distributed over the processors in the communicator; for objects such as solvers it means that their operation is distributed over the communicator. PETSc objects can only interact if they are based on the same communicator. Most of the time objects will be defined on the `MPI_COMM_WORLD` communicator, but subcommunicators can be used too. This way, you can define a matrix or a linear system on all your available processors, or on a subset.

Parallelism is handled through MPI. You may need to have occasional MPI calls in a PETSc code, but the vast bulk of communication is done behind the scenes inside PETSc calls. Shared memory parallel (such as through OpenMP; section 2.7.2) is not used explicitly, but the user can incorporate it without problems.

The object-oriented design means that a call such as matrix-vector multiplication

```
MATMult(A, x, y); // y <- A x
```

looks the same, regardless whether  $A$  is sparse or dense, sequential or parallel.

One implication of this is that the actual data are usually hidden from the user. Data can be accessed through routines such as

```
double *array;  
VecGetArray(myvector, &array);
```

but most of the time the application does not explicitly maintain the data, only the PETSc objects containing the data. As the ultimate consequence of this, the user usually does not allocate data; rather, matrix and vector arrays get created through the PETSc create calls, and subsequent values are inserted through PETSc calls:

```
MatSetValue(A, i, j, v, INSERT_VALUES); // A[i, j] <- v
```

This may feel like the user is giving up control, but it actually makes programming a lot easier, since the user does not have to worry about details of storage schemes, especially in parallel.

### 24.1.3 Small examples

In this section we will go through a number of successively more complicated examples of the use of PETSc. The files can be downloaded from the repository of this book. While doing these examples it is a good idea to keep the manual page open:

<http://tinyurl.com/PETSc-man-page>.

When you do these examples, make sure to use a version of PETSc that has debug mode enabled!



### 24.1.3.1 Program structure

The first example (we only list C sources in this book; the download includes their Fortran equivalents) illustrates the basic structure of a PETSc program: the include file at the top and the calls to `PetscInitialize`, `PetscFinalize`. Furthermore it uses two routines:

- `PetscOptionsGetInt` is used to check if the program was invoked with a `-n` option and a numerical value: if you ran your program as `./init -n 45`, the variable `n` should have the value 45.
- `PetscPrintf` functions like the `printf` function, except that only one processor executes the print command. If you ran your program as `mpiexec -np 4 init` and you used `printf`, you would get four copies of the output.

```
// init.c
int main(int argc, char **argv)
{
    MPI_Comm      comm;
    PetscInt      n = 20;
    PetscErrorCode ierr;

    PetscFunctionBegin;
    ierr = PetscInitialize(&argc, &argv, 0, 0); CHKERRQ(ierr);
    comm = PETSC_COMM_WORLD;
    ierr = PetscOptionsGetInt(PETSC_NULL, "-n", &n, PETSC_NULL); CHKERRQ(ierr);
    ierr = PetscPrintf(comm, "Input parameter: %d\n", n); CHKERRQ(ierr);

    ierr = PetscFinalize(); CHKERRQ(ierr);
    PetscFunctionReturn(0);
}
```

Just about the only lines of MPI that you need to know when programming PETSc are:

```
C:
ierr = MPI_Comm_size(comm, &ntids);
ierr = MPI_Comm_rank(comm, &mytid);
F:
call MPI_Comm_size(comm, &ntids, ierr);
call MPI_Comm_rank(comm, &mytid, ierr);
```

The first line gives the size of the communicator, meaning how many processes there are; the second one gives the rank of the current process as a number from zero to the number of processes minus one.

**Exercise 24.1.** Add these two lines to your program. Look up the routine `PetscSynchronizedPrintf` in the documentation and use it to let each process print out a line like `Process 3 out of 7`. You may also need to use `PetscSynchronizedFlush`.

## 24.1.3.2 Vectors

Next we start making PETSc objects, first a vector.

```
vec.c
```

```
#include "petsc.h"

#undef __FUNCT__
#define __FUNCT__ "main"
int main(int argc, char **argv)
{
    MPI_Comm      comm;
    int ntids, mytid, myfirst, mylast;
    Vec           x;
    PetscInt      n = 20;
    PetscReal     one = 1.0;
    PetscErrorCode ierr;

    PetscFunctionBegin;
    ierr = PetscInitialize(&argc, &argv, 0, 0); CHKERRQ(ierr);
    comm = PETSC_COMM_WORLD;
    ierr = PetscOptionsGetInt(PETSC_NULL, "-n", &n, PETSC_NULL);
        CHKERRQ(ierr);

    MPI_Comm_size(comm, &ntids); MPI_Comm_rank(comm, &mytid);

    ierr = VecCreate(comm, &x); CHKERRQ(ierr);
    ierr = VecSetSizes(x, PETSC_DECIDE, n); CHKERRQ(ierr);
    ierr = VecSetType(x, VECMPI); CHKERRQ(ierr);

    ierr = VecGetOwnershipRange(x, &myfirst, &mylast); CHKERRQ(ierr);
    ierr = PetscSynchronizedPrintf(comm, "Proc %d, range %d--%d\n",
        mytid, myfirst, mylast); CHKERRQ(ierr);

    ierr = VecSet(x, one); CHKERRQ(ierr);
    ierr = VecAssemblyBegin(x); CHKERRQ(ierr);
    ierr = VecAssemblyEnd(x); CHKERRQ(ierr);
    ierr = VecView(x, 0); CHKERRQ(ierr);

    ierr = VecDestroy(&x); CHKERRQ(ierr);
    ierr = PetscFinalize(); CHKERRQ(ierr);
    PetscFunctionReturn(0);
}
```

Note how it takes several calls to fully create the vector object:

- The type `VECMPI` means that the vector will be distributed.
- The routine setting the size has two size parameters; the second specifies that the global size is `n`, and the first one says that you leave the distribution for PETSc to decide.

At the end of the program there is a `VecDestroy`, which deallocates the memory for the vector. While this is strictly speaking not necessary for the functioning of the program, it is a good idea to issue `Destroy` calls for each `Create` call, since it can prevent potential *memory leaks*.

**Exercise 24.2.** Comment out the `VecDestroy` call, and run the program with the option `-malloc_dump`. PETSc will now report on all memory that had not been freed at the time of the `PetscFinalize` call.

If you run the program in parallel the vector will be created distributed over the processors. The program contains a call to `VecGetOwnershipRange` to discover what part of the vector lives on what processor. You see that the `VecView` calls display for each processor precisely that part of the vector.

**Exercise 24.3.** The listing has a call to `VecSet` to set the vector elements to a constant value. Remove this line. Use the `myfirst, mylast` variables and the PETSc routine `VecSetValue` to let every process set its local vector elements to the processor number. (The last argument of `VecSetValue` should be `INSERT_VALUES`.) That is, if the vector is six elements long and there are three processors, the resulting vector should be  $(0, 0, 1, 1, 2, 2)$ .

**Exercise 24.4.** Change the code from the previous exercise. Now every vector element should be the sum of the processor number and the previous processor numbers; in the above example the result should be  $(0, 0, 1, 1, 3, 3)$ . Read the man page for `VecSetValue`!

Run the code from the previous two exercises again, adding a commandline argument `-log_summary`. Observe that the first code has no messages in the `VecAssemblyBegin/End` calls, but the second one does.

### 24.1.3.3 Matrices

Let's move up to matrices. Creating a matrix is similar to creating a vector. In this case the type is `MPIAIJ` which stands for a distributed sparse matrix.

mat.c

```

/* %%%%%%%%%%%%%%%%%%%%%%%%%%%%%%%%%%%%%%%%%%%%%%%%%%%%%%%%%%%%%%%%%%%%%%%%%
   %%%%%%%%%%%%%%%%%%%%%%%%%%%%%%%%%%%%%%%%%%%%%%%%%%%%%%%%%%%%%%%%%%%%%%%%%
   %%%
   %%% This program file is part of the textbook and course
   %%% 'Introduction to High-Performance Scientific Computing'
   %%% by Victor Eijkhout, copyright 2012/3/4/5
   %%%
   %%% This book is distributed under a Creative Commons Attribution 3.0
   %%% Unported (CC BY 3.0) license and made possible by funding from
   %%% The Saylor Foundation \url{http://www.saylor.org}.
   %%%
   %%%
   %%%%%%%%%%%%%%%%%%%%%%%%%%%%%%%%%%%%%%%%%%%%%%%%%%%%%%%%%%%%%%%%%%%%%%%%%
   %%%%%%%%%%%%%%%%%%%%%%%%%%%%%%%%%%%%%%%%%%%%%%%%%%%%%%%%%%%%%%%%%%%%%%%%%
*/
#include "petsc.h"

```

```

#undef __FUNCT__
#define __FUNCT__ "main"
int main(int argc, char **argv)
{
    MPI_Comm      comm;
    int ntids, mytid, localsize, myfirst, mylast, i;
    Mat           A;
    PetscInt      n = 20;
    PetscErrorCode ierr;

    PetscFunctionBegin;
    ierr = PetscInitialize(&argc, &argv, 0, 0); CHKERRQ(ierr);
    comm = PETSC_COMM_WORLD;
    ierr = PetscOptionsGetInt(PETSC_NULL, "-n", &n, PETSC_NULL);
        CHKERRQ(ierr);

    MPI_Comm_size(comm, &ntids); MPI_Comm_rank(comm, &mytid);
    localsize = PETSC_DECIDE;
    ierr = PetscSplitOwnership(comm, &localsize, &n); CHKERRQ(ierr);

    ierr = MatCreate(comm, &A); CHKERRQ(ierr);
    ierr = MatSetType(A, MATMPIAIJ); CHKERRQ(ierr);
    ierr = MatSetSizes(A, localsize, localsize,
        PETSC_DECIDE, PETSC_DECIDE); CHKERRQ(ierr);
    ierr = MatGetOwnershipRange(A, &myfirst, &mylast); CHKERRQ(ierr);

    for (i=myfirst; i<mylast; i++) {
        PetscReal v=1.0*mytid;
        ierr = MatSetValues(A, 1, &i, 1, &i, &v, INSERT_VALUES); CHKERRQ(ierr);
        /*
         * Exercise: add some off-diagonal matrix elements
         */
    }
    ierr = MatAssemblyBegin(A, MAT_FINAL_ASSEMBLY); CHKERRQ(ierr);
    ierr = MatAssemblyEnd(A, MAT_FINAL_ASSEMBLY); CHKERRQ(ierr);
    ierr = MatView(A, 0); CHKERRQ(ierr);

    ierr = MatDestroy(&A); CHKERRQ(ierr);
    ierr = PetscFinalize(); CHKERRQ(ierr);
    PetscFunctionReturn(0);
}

```

In this example a diagonal matrix is constructed, with each processor setting only its locally stored elements.

**Exercise 24.5.** In addition to setting the diagonal, also set the first subdiagonal and the first superdiagonal, that is, the elements  $(i, i - 1)$  and  $(i, i + 1)$ . To set all three elements in a row with one call you can do this:

```
vm = 1.*mytid;
```

```
for (i=myfirst; i<mylast; i++) {
    PetscInt j[3]; PetscReal v[3];
    j[0] = i-1; j[1] = i; j[2] = i+1;
    v[0] = --vm-1; v[1] = 2*vm; v[2] = -vm+1;
    ierr = MatSetValues
        (A, 1, &i, 3, j, v, INSERT_VALUES); CHKERRQ(ierr);
}
```

However, this code is not entirely correct. Edit the program using this fragment and run it. Diagnose the problem and fix it.

#### 24.1.3.4 Matrix-vector operations

Next we will create a file `mul.c` based on `mat.c` and multiply the matrix and the vector. Make sure that the size declarations of the matrix and the vector are compatible. You also need a second vector to store the result of the multiplication. This is easiest done by

```
ierr = VecDuplicate(x, &y); CHKERRQ(ierr);
```

**Exercise 24.6.** Look up the `MatMult` routine in the documentation and use it your program. Use `VecView` to inspect the result. Note that no size parameters or anything pertaining to parallelism appears in the calling sequence.

#### 24.1.3.5 Solvers

Copy your `mat.c` file to `sys.c`: we are going to explore linear system solving. First you need to create a solver object and give it the matrix as operator:

```
ierr = KSPCreate(comm, &solver); CHKERRQ(ierr);
ierr = KSPSetOperators(solver, A, A, 0); CHKERRQ(ierr);
ierr = KSPSolve(solver, x, y); CHKERRQ(ierr);
ierr = VecView(y, 0); CHKERRQ(ierr);
```

**Exercise 24.7.** Add these lines to your code. Make sure you know what the correct solution is by using `MatMult` to obtain the right hand side.

You have just used the default linear system solver. Run the program again, but with the option `-ksp_view`. This will tell you all the details of what solver was used.

Solving the linear system is a one line call to `KSPSolve`. The story would end there if it weren't for some complications:

- Iterative methods can fail, and the solve call does not tell us whether that happened.
- If the system was solved successfully, we would like to know in how many iterations.
- There can be other reason for the iterative method to halt, such as reaching its maximum number of iterations without converging.

- Exercise 24.8.** Use the routine `KSPGetConvergedReason` to inspect the status of the solution vector. Use `KSPGetIterationNumber` to see how many iterations it took.
- Exercise 24.9.** Add code to your program to compute the residual and its norm. For the residual, look up the routines `VecDuplicate` and `VecAXPY`; for computing its norm look up `VecNorm`.
- Exercise 24.10.** Add a call to `KSPSetFromOptions` to your code. Use the option `-ksp_monitor` to observe the convergence behaviour.

The workings of a PETSc program can be customized to a great degree through the use of commandline options. This includes setting the type of the solver. In order for such options to be obeyed, you first need to put a command `KSPSetFromOptions` before the `KSPSolve` call.

- Exercise 24.11.** The `-ksp_view` option told you what solver and preconditioner were used. Look up the routines `KSPSetType` and `PCSetType` and use those to change the iterative method to CG and the preconditioner to Jacobi. Do this first by using commandline options, and then by editing the code.

#### 24.1.4 A realistic program

This section will give you some further help towards solving a realistic PDE problem.

##### 24.1.4.1 Construction of the coefficient matrix

In the examples above you used a commandline argument to determine the matrix size directly. Here we construct the matrix of 5-point stencil for the Poisson operator (see section 4.2.3 and in particular figure 4.1). Determining its size takes two steps: you need to read the domain size  $n = 1/h - 1$  and compute the matrix size from it.

C:

```
int domain_size, matrix_size;
PetscOptionsGetInt
    (PETSC_NULL, "-n", &domain_size, &flag);
matrix_size = domain_size*domain_size;
```

Fortran:

```
integer :: domain_size, matrix_size
call PetscOptionsGetInt (PETSC_NULL_CHARACTER,
>    "-n", domain_size, flag)
matrix_size = domain_size*domain_size;
```

Now you use the `matrix_size` parameter for constructing the matrix.

#### 24.1.4.2 Filling in matrix elements

Just like in the examples above, you want each processor to set only its local rows. The easiest way to iterate over those is to iterate over all variables / matrix rows and select only the local ones.

We will now set matrix elements (refer to the full domain, but only inserting those elements that are in its matrix block row).

C:

```
MatGetOwnershipRange (A, &myfirst, &mylast);
for ( i=0; i<domain_size; i++ ) {
  for ( j=0; j<domain_size; j++ ) {
    I = j + matrix_size*i;
    if (I>=myfirst && I<mylast) {
      J = I; // for the diagonal element
      MatSetValues
        (A, 1, &I, 1, &J, &v, INSERT_VALUES);
      J = .... // for the other points
      J = ....
    }
  }
}
MatAssemblyBegin (A, MAT_FINAL_ASSEMBLY);
MatAssemblyEnd (A, MAT_FINAL_ASSEMBLY);
```

Fortran:

```
call MatGetOwnershipRange (A, myfirst, mylast)
do i=0, matrix_size-1
  do j=0, domain_size-1
    ii = j + domain_size*i
    if (ii>=myfirst .and. ii<mylast) then
      jj = ii ; for the diagonal element
      call MatSetValues
>      (A, 1, ii, 1, jj, v, INSERT_VALUES)
      jj = ii... ; for the other elements
      jj = ii...
    end if
  end do
end do
call MatAssemblyBegin (A, MAT_FINAL_ASSEMBLY)
call MatAssemblyEnd (A, MAT_FINAL_ASSEMBLY)
```

**Exercise 24.12.** Construct the matrix from equation (4.14) in section 4.2.3. Compute and output the product with the identity vector (meaning that all elements are 1), and check

that the result is correct. Make sure to test your program in parallel.

#### 24.1.4.3 Finite Element Matrix assembly

PETSc's versatility in dealing with Finite Element matrices (see sections 4.2.5 and 6.6.2), where elements are constructed by adding together contributions, sometimes from different processors. This is no problem in PETSc: any processor can set (or add to) any matrix element. The assembly calls will move data to their eventual location on the correct processors.

```

for (e=myfirstelement; e<mylastelement; e++) {
  for (i=0; i<nlocalnodes; i++) {
    I = localtglobal(e, i);
    for (j=0; j<nlocalnodes; j++) {
      J = localtglobal(e, j);
      v = integration(e, i, j);
      MatSetValues
          (mat, 1, &I, 1, &J, &v, ADD_VALUES);
      ....
    }
  }
}
MatAssemblyBegin(mat, MAT_FINAL_ASSEMBLY);
MatAssemblyEnd(mat, MAT_FINAL_ASSEMBLY);

```

#### 24.1.4.4 Linear system solver

We have covered the basics of setting up the solver and solving the system above.

As an illustration of the toolbox nature of PETSc, you can now use routines you have already seen to compute the residual and its norm.

**Exercise 24.13.** Create a new vector `z` (use `VecDuplicate`) and store the product of `A` and the computed solution `y` (use `MatMult`) in it. If you solved the system accurately, `z` should now be equal to `x`. To see how close it is, use

```

PetscReal norm;
VecXPY(z, -1, x);
VecNorm(z, NORM_2, &norm);

```

to subtract `x` from `z` and compute the norm of the result.

#### 24.1.5 Quick experimentation

Reading a parameter from the commandline above is actually a special case of a general mechanism for influencing PETSc's workings through commandline options.

Here is an example of setting the iterative solver and preconditioner from the commandline:



```
yourprog -ksp_type gmres -ksp_gmres_restart 25
        -pc_type ilu -pc_factor_levels 3
```

In order for this to work, your code needs to call

```
KSPSetFromOptions(solver);
```

before the system solution. This mechanism is very powerful, and it obviates the need for much code recompilation.

## 24.2 Libraries for dense linear algebra: BLAS, Lapack, Scalapack

In this section we will discuss libraries for dense linear algebra operations.

Dense linear algebra, that is linear algebra on matrices that are stored as two-dimensional arrays (as opposed to sparse linear algebra; see section 5.4, as well as the tutorial on PETSc 24) has been standardized for a considerable time. The basic operations are defined by the three levels of *Basic Linear Algebra Subprograms (BLAS)*:

- Level 1 defines vector operations that are characterized by a single loop [111].
- Level 2 defines matrix vector operations, both explicit such as the matrix-vector product, and implicit such as the solution of triangular systems [45].
- Level 3 defines matrix-matrix operations, most notably the matrix-matrix product [44].

The name ‘BLAS’ suggests a certain amount of generality, but the original authors were clear [111] that these subprograms only covered dense linear algebra. Attempts to standardize sparse operations have never met with equal success.

Based on these building blocks libraries have been built that tackle the more sophisticated problems such as solving linear systems, or computing eigenvalues or singular values. *Linpack*<sup>1</sup> and *Eispack* were the first to formalize these operations involved, using Blas Level 1 and Blas Level 2 respectively. A later development, *Lapack* uses the blocked operations of Blas Level 3. As you saw in section 1.5.1, this is needed to get high performance on cache-based CPUs. (Note: the reference implementation of the BLAS [13] will not give good performance with any compiler; most platforms have vendor-optimized implementations, such as the *MKL* library from Intel.)

With the advent of parallel computers, several projects arose that extended the Lapack functionality to distributed computing, most notably *Scalapack* [26, 12], *PLapack* [156, 155], and most recently *Elemental* [137]. These packages are harder to use than Lapack because of the need for a two-dimensional cyclic distribution; sections 6.2.2 and 6.3.2. We will not go into the details here.

---

1. The linear system solver from this package later became the *Linpack benchmark*; see section 2.11.5.

### 24.2.1 Some general remarks

#### 24.2.1.1 *The Fortran heritage*

The original BLAS routines were written in Fortran, and the reference implementation is still in Fortran. For this reason you will see the routine definitions first in Fortran in this tutorial. It is possible to use the Fortran routines from a C/C++ program:

- You typically need to append an underscore to the Fortran name;
- You need to include a prototype file in your source, for instance `mk1.h`;
- Every argument needs to be a 'star'-argument, so you can not pass literal constants: you need to pass the address of a variable.
- You need to create a column-major matrix.

There are also C/C++ interfaces:

- The C routine names are formed by prefixing the original name with `cblas_`; for instance `dasum` becomes `cblas_dasum`.
- Fortran character arguments have been replaced by enumerated constants, for instance `CblasNoTrans` instead of the 'N' parameter.
- The Cblas interface can accommodate both row-major and column-major storage.
- Array indices are 1-based, rather than 0-based; this mostly becomes apparent in error messages and when specifying pivot indices.

#### 24.2.1.2 *Routine naming*

Routines conform to a general naming scheme: `XYZZZ` where

**X** precision: *S*, *D*, *C*, *Z* stand for single and double, single complex and double complex, respectively.

**YY** storage scheme: general rectangular, triangular, banded.

**ZZZ** operation. See the manual for a list.

#### 24.2.1.3 *Data formats*

Lapack and Blas use a number of data formats, including

**GE** General matrix: stored two-dimensionally as `A(LDA, *)`

**SY/HE** Symmetric/Hermitian: general storage; `UPLO` parameter to indicate upper or lower (e.g. `SPOTRF`)

**GB/SB/HB** General/symmetric/Hermitian band; these formats use column-major storage; in `SGBTRF` over-allocation needed because of pivoting

**PB** Symmetric or Hermitian positive definite band; no overallocation in `SPDTRF`

#### 24.2.1.4 *Lapack operations*

For Lapack, we can further divide the routines into an organization with three levels:

- Drivers. These are powerful top level routines for problems such as solving linear systems or computing an SVD. There are simple and expert drivers; the expert ones have more numerical sophistication.

- Computational routines. These are the routines that drivers are built up out of<sup>2</sup>. A user may have occasion to call them by themselves.
- Auxiliary routines.

Expert driver names end on 'X'.

- Linear system solving. Simple drivers: `-SV` (e.g., `DGESV`) Solve  $AX = B$ , overwrite A with LU (with pivoting), overwrite B with X.  
Expert driver: `-SVX` Also transpose solve, condition estimation, refinement, equilibration
- Least squares problems. Drivers:  
`xGELS` using QR or LQ under full-rank assumption  
`xGELSY` "complete orthogonal factorisation"  
`xGELSS` using SVD  
`xGELSD` using divide-conquer SVD (faster, but more workspace than `xGELSS`)  
 Also: LSE & GLM linear equality constraint & general linear model
- Eigenvalue routines. Symmetric/Hermitian: `xSY` or `xHE` (also `SP`, `SB`, `ST`)  
 simple driver `-EV`  
 expert driver `-EVX`  
 divide and conquer `-EVD`  
 relative robust representation `-EVR`  
 General (only `xGE`)  
 Schur decomposition `-ES` and `-ESX`  
 eigenvalues `-EV` and `-EVX`  
 SVD (only `xGE`)  
 simple driver `-SVD`  
 divide and conquer `SDD`  
 Generalized symmetric (`SY` and `HE`; `SP`, `SB`)  
 simple driver `GV`  
 expert `GVX`  
 divide-conquer `GVD`  
 Nonsymmetric:  
 Schur: simple `GGES`, expert `GGESX`  
 eigen: simple `GGEV`, expert `GGEVX`  
 svd: `GSVD`

#### 24.2.1.5 BLAS matrix storage

There are a few points to bear in mind about the way matrices are stored in the BLAS and LAPACK<sup>3</sup>:

**24.2.1.5.1 Array indexing** Since these libraries originated in a Fortran environment, they use 1-based indexing. Users of languages such as C/C++ are only affected by this when routines use index arrays, such as the location of pivots in LU factorizations.

---

2. Ha! Take that, Winston.

3. We are not going into band storage here.

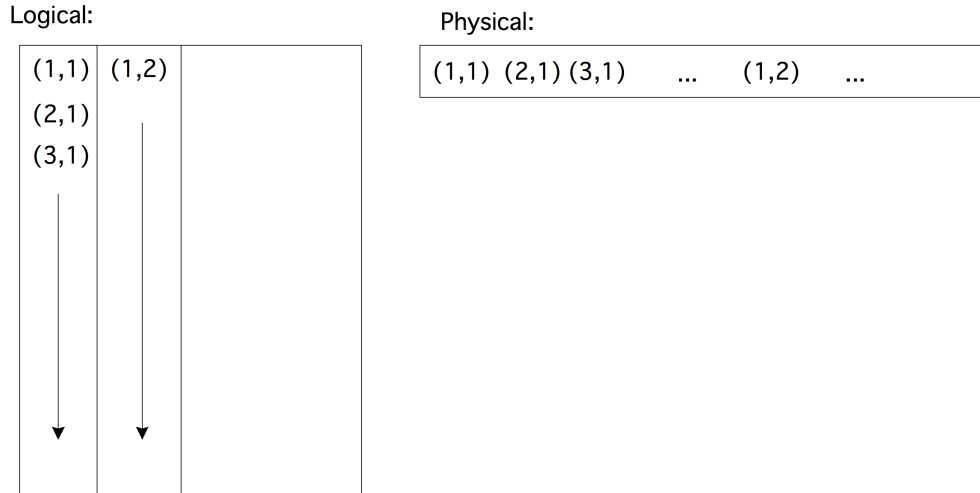

Figure 24.1: Column-major storage of an array in Fortran

**24.2.1.5.2 Fortran column-major ordering** Since computer memory is one-dimensional, some conversion is needed from two-dimensional matrix coordinates to memory locations. The *Fortran* language uses *column-major* storage, that is, elements in a column are stored consecutively; see figure 24.1. This is also described informally as ‘the leftmost index varies quickest’.

Arrays in C, on the other hand, are laid out in *row-major* order. How to create a C array that can be handled by Blas routines is discussed in section 28.2.

#### 24.2.1.6 Submatrices and the LDA parameter

Using the storage scheme described above, it is clear how to store an  $m \times n$  matrix in  $mn$  memory locations. However, there are many cases where software needs access to a matrix that is a subblock of another, larger, matrix. As you see in figure 24.2 such a subblock is no longer contiguous in memory. The way to describe this is by introducing a third parameter in addition to  $M, N$ : we let LDA be the ‘leading dimension of A’, that is, the allocated first dimension of the surrounding array. This is illustrated in figure 24.3. To pass the subblock to a routine, you would specify it as

```
call routine( A(3,2), /* M= */ 2, /* N= */ 3, /* LDA= */ Mbig, ... )
```

### 24.2.2 Performance issues

The collection of BLAS and LAPACK routines are a *de facto* standard: the Application Programmer Interface (API) is fixed, but the implementation is not. You can find reference implementations on the *netlib* website ([netlib.org](http://netlib.org)), but these will be very low in performance.

On the other hand, many LAPACK routines can be based on the matrix-matrix product (BLAS routine `gemm`), which you saw in section 1.6.11 has the potential for a substantial fraction of peak performance. To achieve this, you should use an optimized version, such as

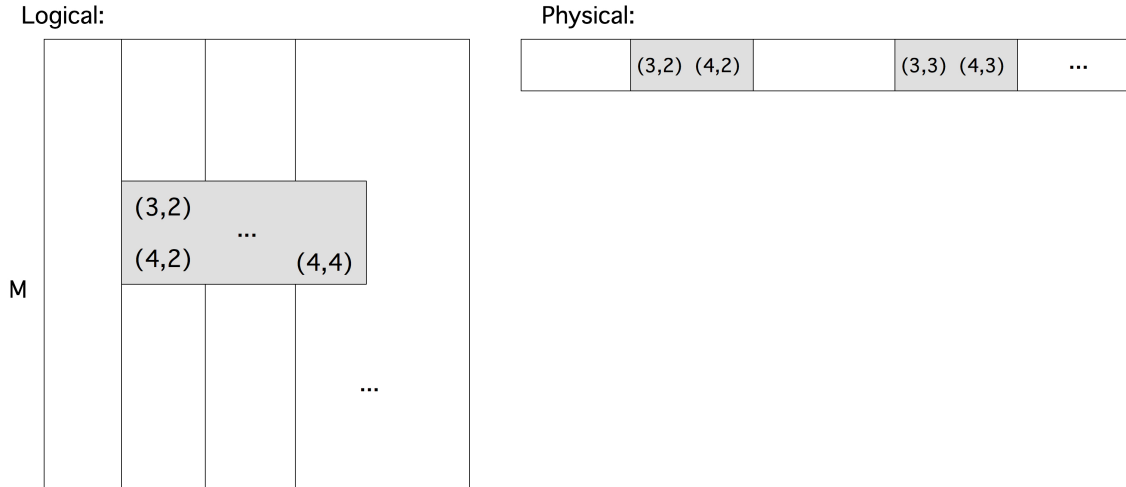

Figure 24.2: A subblock out of a larger matrix

- *MKL*, the Intel math-kernel library;
- OpenBlas (<http://www.openblas.net/>), an open source version of the original *Goto BLAS*; or
- *blis* (<https://code.google.com/p/blis/>), a BLAS replacement and extension project.

### 24.2.3 Some simple examples

Let's look at some simple examples.

The routine `xscal` scales a vector in place.

```
! Fortran
subroutine dscal(integer N, double precision DA,
               double precision, dimension(*) DX, integer INCX )
// C
void cblas_dscal (const MKL_INT n, const double a,
                 double *x, const MKL_INT incx);
```

A simple example:

```
// example1.F90
do i=1,n
  xarray(i) = 1.d0
end do
call dscal(n, scale, xarray, 1)
do i=1,n
  if (.not.assert_equal( xarray(i), scale )) print *, "Error in index", i
end do
```

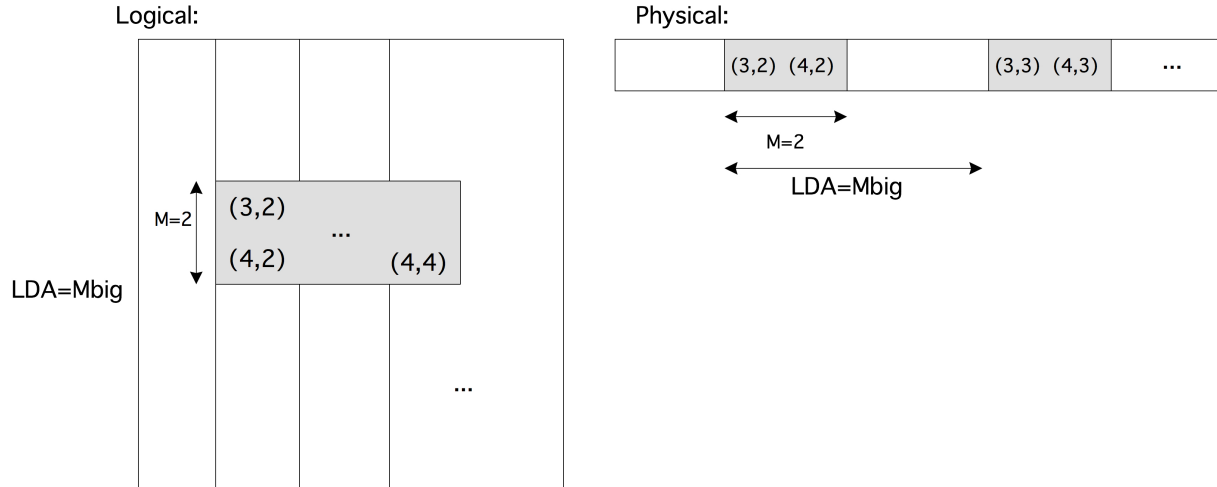

Figure 24.3: A subblock out of a larger matrix, using LDA

The same in C:

```
// example1c.cxx
xarray = new double[n]; yarray = new double[n];

for (int i=0; i<n; i++)
    xarray[i] = 1.;
cblas_dscal(n, scale, xarray, 1);
for (int i=0; i<n; i++)
    if (!assert_equal( xarray[i], scale ))
        printf("Error in index %d", i);
```

Many routines have an increment parameter. For `xscale` that's the final parameter:

```
// example2.F90
integer :: inc=2
call dscal(n/inc, scale, xarray, inc)
do i=1, n
    if (mod(i, inc)==1) then
        if (.not.assert_equal( xarray(i), scale )) print *, "Error in index", i
    else
        if (.not.assert_equal( xarray(i), 1.d0 )) print *, "Error in index", i
    end if
end do
```

The matrix-vector product `xgemv` computes  $y \leftarrow \alpha Ax + \beta y$ , rather than  $y \leftarrow Ax$ . The specification of

the matrix takes the  $M, N$  size parameters, and a character argument 'N' to indicate that the matrix is not transposed. Both of the vectors have an increment argument.

```
subroutine dgemv(character TRANS,
               integer M, integer N,
               double precision ALPHA,
               double precision, dimension(lda,*) A, integer LDA,
               double precision, dimension(*) X, integer INCX,
               double precision BETA, double precision, dimension(*) Y, integer INCY
               )
```

An example of the use of this routine:

```
// example3.F90
do j=1,n
  xarray(j) = 1.d0
  do i=1,m
    matrix(i,j) = 1.d0
  end do
end do

alpha = 1.d0; beta = 0.d0
call dgemv( 'N',M,N, alpha,matrix,M, xarray,1, beta,yarray,1)
do i=1,m
  if (.not.assert_equal( yarray(i),dble(n) )) &
    print *, "Error in index",i,":",yarray(i)
end do
```

The same example in C has an extra parameter to indicate whether the matrix is stored in row or column major storage:

```
// example3c.cxx
for (int j=0; j<n; j++) {
  xarray[j] = 1.;
  for (int i=0; i<m; i++)
    matrix[ i+j*m ] = 1.;
}

alpha = 1.; beta = 0.;
cblas_dgemv(CblasColMajor,
           CblasNoTrans,m,n, alpha,matrix,m, xarray,1, beta,yarray,1);

for (int i=0; i<m; i++)
  if (!assert_equal( yarray[i],(double)n ))
    printf("Error in index %d",i);
```

## Chapter 25

### Plotting with GNUplot

The *gnuplot* utility is a simple program for plotting sets of points or curves. This very short tutorial will show you some of the basics. For more commands and options, see the manual <http://www.gnuplot.info/docs/gnuplot.html>.

#### 25.1 Usage modes

The two modes for running *gnuplot* are *interactive* and *from file*. In interactive mode, you call *gnuplot* from the command line, type commands, and watch output appear; you terminate an interactive session with *quit*. If you want to save the results of an interactive session, do *save "name.plt"*. This file can be edited, and loaded with *load "name.plt"*.

Plotting non-interactively, you call *gnuplot <your file>*.

The output of *gnuplot* can be a picture on your screen, or drawing instructions in a file. Where the output goes depends on the setting of the *terminal*. By default, *gnuplot* will try to draw a picture. This is equivalent to declaring

```
set terminal x11
```

or *aqua*, *windows*, or any choice of graphics hardware.

For output to file, declare

```
set terminal pdf
```

or *fig*, *latex*, *pbm*, et cetera. Note that this will only cause the pdf commands to be written to your screen: you need to direct them to file with

```
set output "myplot.pdf"
```

or capture them with

```
gnuplot my.plt > myplot.pdf
```



### 25.2 Plotting

The basic plot commands are `plot` for 2D, and `splot` ('surface plot') for 3D plotting.

#### 25.2.1 Plotting curves

By specifying

```
plot x**2
```

you get a plot of  $f(x) = x^2$ ; `gnuplot` will decide on the range for  $x$ . With

```
set xrange [0:1]
plot 1-x title "down", x**2 title "up"
```

you get two graphs in one plot, with the  $x$  range limited to  $[0, 1]$ , and the appropriate legends for the graphs. The variable `x` is the default for plotting functions.

Plotting one function against another – or equivalently, plotting a parametric curve – goes like this:

```
set parametric
plot [t=0:1.57] cos(t), sin(t)
```

which gives a quarter circle.

To get more than one graph in a plot, use the command `set multiplot`.

#### 25.2.2 Plotting data points

It is also possible to plot curves based on data points. The basic syntax is `plot 'datafile'`, which takes two columns from the data file and interprets them as  $(x, y)$  coordinates. Since data files can often have multiple columns of data, the common syntax is `plot 'datafile' using 3:6` for columns 3 and 6. Further qualifiers like `with lines` indicate how points are to be connected.

Similarly, `splot "datafile3d.dat" 2:5:7` will interpret three columns as specifying  $(x, y, z)$  coordinates for a 3D plot.

If a data file is to be interpreted as level or height values on a rectangular grid, do `splot "matrix.dat" matrix` for data points; connect them with

```
split "matrix.dat" matrix with lines
```

#### 25.2.3 Customization

Plots can be customized in many ways. Some of these customizations use the `set` command. For instance,

```
set xlabel "time"  
set ylabel "output"  
set title "Power curve"
```

You can also change the default drawing style with

```
set style function dots
```

(dots, lines, dots, points, et cetera), or change on a single plot with

```
plot f(x) with points
```

## 25.3 Workflow

Imagine that your code produces a dataset that you want to plot, and you run your code for a number of inputs. It would be nice if the plotting can be automated. Gnuplot itself does not have the facilities for this, but with a little help from shell programming this is not hard to do.

Suppose you have data files

```
data1.dat data2.dat data3.dat
```

and you want to plot them with the same gnuplot commands. You could make a file `plot.template`:

```
set term pdf  
set output "FILENAME.pdf"  
plot "FILENAME.dat"
```

The string `FILENAME` can be replaced by the actual file names using, for instance `sed`:

```
for d in data1 data2 data3 ; do  
  cat plot.template | sed s/FILENAME/$d/ > plot.cmd  
  gnuplot plot.cmd  
done
```

Variations on this basic idea are many.

## Chapter 26

### Good coding practices

Sooner or later, and probably sooner than later, every programmer is confronted with code not behaving as intended. In this section you will learn some techniques of dealing with this problem. At first we will see a number of techniques for *preventing* errors; in the next chapter we will discuss debugging, the process of finding the inevitable errors in a program, once they have occurred.

#### 26.1 Defensive programming

In this section we will discuss a number of techniques that are aimed at preventing the likelihood of programming errors, or increasing the likelihood of them being found at runtime. We call this *defensive programming*.

Scientific codes are often large and involved, so it is a good practice to code knowing that you are going to make mistakes and prepare for them. Another good coding practice is the use of tools: there is no point in reinventing the wheel if someone has already done it for you. Some of these tools are described in other sections:

- Build systems, such as Make, Scons, Bjam; see section 21.
- Source code management with SVN, Git; see section 22.
- Regression testing and designing with testing in mind (unit testing)

First we will have a look at runtime sanity checks, where you test for things that can not or should not happen.

##### 26.1.1 Assertions

In the things that can go wrong with a program we can distinguish between errors and bugs. Errors are things that legitimately happen but that should not. File systems are common sources of errors: a program wants to open a file but the file doesn't exist because the user mistyped the name, or the program writes to a file but the disk is full. Other errors can come from arithmetic, such as *overflow* errors.

On the other hand, a *bug* in a program is an occurrence that cannot legitimately occur. Of course, 'legitimately' here means 'according to the programmer's intentions'. Bugs can often be described as 'the computer always does what you ask, not necessarily what you want'.

Assertions serve to detect bugs in your program: an *assertion* is a predicate that should be true at a certain point in your program. Thus, an assertion failing means that you didn't code what you intended to code. An assertion is typically a statement in your programming language, or a preprocessor macro; upon failure of the assertion, your program will take some abortive action.

Some examples of assertions:

- If a subprogram has an array argument, it is a good idea to test whether the actual argument is a null pointer before indexing into the array.
- Similarly, you could test a dynamically allocated data structure for not having a null pointer.
- If you calculate a numerical result for which certain mathematical properties hold, for instance you are writing a sine function, for which the result has to be in  $[-1, 1]$ , you should test whether this property indeed holds for the result.

Assertions are often disabled in a program once it's sufficiently tested. The reason for this is that assertions can be expensive to execute. For instance, if you have a complicated data structure, you could write a complicated integrity test, and perform that test in an assertion, which you put after every access to the data structure.

Because assertions are often disabled in the 'production' version of a code, they should not affect any stored data. If they do, your code may behave differently when you're testing it with assertions, versus how you use it in practice without them. This is also formulated as 'assertions should not have *side-effects*'.

#### 26.1.1.1 The C `assert` macro

The C standard library has a file `assert.h` which provides an `assert()` macro. Inserting `assert(foo)` has the following effect: if `foo` is zero (false), a diagnostic message is printed on standard error:

```
Assertion failed: foo, file filename, line line-number
```

which includes the literal text of the expression, the file name, and line number; and the program is subsequently aborted. Here is an example:

```
#include<assert.h>

void open_record(char *record_name)
{
    assert(record_name!=NULL);
    /* Rest of code */
}

int main(void)
{
    open_record(NULL);
}
```

The `assert` macro can be disabled by defining the `NDEBUG` macro.

### 26.1.1.2 An assert macro for Fortran

(Thanks to Robert Mclay for this code.)

```
#if (defined( GFORTRAN ) || defined( G95 ) || defined ( PGI) )
# define MKSTR(x) "x"
#else
# define MKSTR(x) #x
#endif
#ifndef NDEBUG
# define ASSERT(x, msg) if (.not. (x) ) \
                        call assert( FILE , LINE ,MKSTR(x),msg)
#else
# define ASSERT(x, msg)
#endif
subroutine assert(file, ln, testStr, msgIn)
implicit none
character(*) :: file, testStr, msgIn
integer :: ln
print *, "Assert: ",trim(testStr)," Failed at ",trim(file),":",ln
print *, "Msg:", trim(msgIn)
stop
end subroutine assert
```

which is used as

```
ASSERT(nItemsSet.gt.arraySize,"Too many elements set")
```

### 26.1.2 Use of error codes

In some software libraries (for instance MPI or PETSc) every subprogram returns a result, either the function value or a parameter, to indicate success or failure of the routine. It is good programming practice to check these error parameters, even if you think that nothing can possibly go wrong.

It is also a good idea to write your own subprograms in such a way that they always have an error parameter. Let us consider the case of a function that performs some numerical computation.

```
float compute(float val)
{
    float result;
    result = ... /* some computation */
    return result;
}

float value,result;
result = compute(value);
```

Looks good? What if the computation can fail, for instance:

```
result = ... sqrt(val) ... /* some computation */
```

How do we handle the case where the user passes a negative number?

```
float compute(float val)
{
    float result;
    if (val<0) { /* then what? */
    } else
        result = ... sqrt(val) ... /* some computation */
    return result;
}
```

We could print an error message and deliver some result, but the message may go unnoticed, and the calling environment does not really receive any notification that something has gone wrong.

The following approach is more flexible:

```
int compute(float val, float *result)
{
    float result;
    if (val<0) {
        return -1;
    } else {
        *result = ... sqrt(val) ... /* some computation */
    }
    return 0;
}

float value, result; int ierr;
ierr = compute(value, &result);
if (ierr!=0) { /* take appropriate action */
}
```

You can save yourself a lot of typing by writing

```
#define CHECK_FOR_ERROR(ierr) \
    if (ierr!=0) { \
        printf("Error %d detected\n", ierr); \
        return -1 ; }
....
ierr = compute(value, &result); CHECK_FOR_ERROR(ierr);
```

Using some cpp macros you can even define

```
#define CHECK_FOR_ERROR(ierr) \
    if (ierr!=0) { \
        printf("Error %d detected in line %d of file %s\n", \
            ierr, __LINE__, __FILE__); \
        return -1 ; }
```

Note that this macro not only prints an error message, but also does a further return. This means that, if you adopt this use of error codes systematically, you will get a full backtrace of the calling tree if an error occurs. (In the Python language this is precisely the wrong approach since the backtrace is built-in.)

### 26.2 Guarding against memory errors

In scientific computing it goes pretty much without saying that you will be working with large amounts of data. Some programming languages make managing data easy, others, one might say, make making errors with data easy.

The following are some examples of *memory violations*.

- Writing outside array bounds. If the address is outside the user memory, your code may abort with an error such as *segmentation violation*, and the error is reasonably easy to find. If the address is just outside an array, it will corrupt data but not crash the program; such an error may go undetected for a long time, as it can have no effect, or only introduce subtly wrong values in your computation.
- Reading outside array bounds can be harder to find than errors in writing, as it will often not abort your code, but only introduce wrong values.
- The use of uninitialized memory is similar to reading outside array bounds, and can go undetected for a long time. One variant of this is through attaching memory to an unallocated pointer. This particular kind of error can manifest itself in interesting behaviour. Let's say you notice that your program misbehaves, you recompile it with debug mode to find the error, and now the error no longer occurs. This is probably due to the effect that, with low optimization levels, all allocated arrays are filled with zeros. Therefore, your code was originally reading a random value, but is now getting a zero.

This section contains some techniques to prevent errors in dealing with memory that you have reserved for your data.

#### 26.2.1 Array bound checking and other memory techniques

In parallel codes, memory errors will often show up by a crash in an MPI routine. This is hardly ever an MPI problem or a problem with your cluster.

Compilers for Fortran often have support for array bound checking. Since this makes your code much slower, you would only enable it during the development phase of your code.

### 26.2.2 Memory leaks

We say that a program has a *memory leak*, if it allocates memory, and subsequently loses track of that memory. The operating system then thinks the memory is in use, while it is not, and as a result the computer memory can get filled up with allocated memory that serves no useful purpose.

In this example data is allocated inside a lexical scope:

```
for (i=.... ) {
    real *block = malloc( /* large number of bytes */ )
    /* do something with that block of memory */
    /* and forget to call "free" on that block */
}
```

The block of memory is allocated in each iteration, but the allocation of one iteration is no longer available in the next. A similar example can be made with allocating inside a conditional.

It should be noted that this problem is far less serious in Fortran, where memory is deallocated automatically as a variable goes out of scope.

There are various tools for detecting memory errors: Valgrind, DMALLOC, Electric Fence. For valgrind, see section [27.3](#).

### 26.2.3 Roll-your-own malloc

Many programming errors arise from improper use of dynamically allocated memory: the program writes beyond the bounds, or writes to memory that has not been allocated yet, or has already been freed. While some compilers can do bound checking at runtime, this slows down your program. A better strategy is to write your own memory management. Some libraries such as PETSc already supply an enhanced malloc; if this is available you should certainly make use of it.

If you write in C, you will probably know the malloc and free calls:

```
int *ip;
ip = (int*) malloc(500*sizeof(int));
if (ip==0) { /* could not allocate memory */}
..... do stuff with ip .....
free(ip);
```

You can save yourself some typing by

```
#define MYMALLOC(a,b,c) \
    a = (c*)malloc(b*sizeof(c)); \
    if (a==0) { /* error message and appropriate action */}

int *ip;
MYMALLOC(ip, 500, int);
```



Runtime checks on memory usage (either by compiler-generated bounds checking, or through tools like `valgrind` or `Rational Purify`) are expensive, but you can catch many problems by adding some functionality to your `malloc`. What we will do here is to detect memory corruption after the fact.

We allocate a few integers to the left and right of the allocated object (line 1 in the code below), and put a recognizable value in them (line 2 and 3), as well as the size of the object (line 2). We then return the pointer to the actually requested memory area (line 4).

```
#define MEMCOOKIE 137
#define MYMALLOC(a,b,c) { \
    char *aa; int *ii; \
    aa = malloc(b*sizeof(c)+3*sizeof(int)); /* 1 */ \
    ii = (int*)aa; ii[0] = b*sizeof(c); \
        ii[1] = MEMCOOKIE; /* 2 */ \
    aa = (char*)(ii+2); a = (c*)aa ; /* 4 */ \
    aa = aa+b*sizeof(c); ii = (int*)aa; \
        ii[0] = MEMCOOKIE; /* 3 */ \
}
```

Now you can write your own `free`, which tests whether the bounds of the object have not been written over.

```
#define MYFREE(a) { \
    char *aa; int *ii,; ii = (int*)a; \
    if (*(--ii)!=MEMCOOKIE) printf("object corrupted\n"); \
    n = *(--ii); aa = a+n; ii = (int*)aa; \
    if (*ii!=MEMCOOKIE) printf("object corrupted\n"); \
}
```

You can extend this idea: in every allocated object, also store two pointers, so that the allocated memory areas become a doubly linked list. You can then write a macro `CHECKMEMORY` which tests all your allocated objects for corruption.

Such solutions to the memory corruption problem are fairly easy to write, and they carry little overhead. There is a memory overhead of at most 5 integers per object, and there is practically no performance penalty.

(Instead of writing a wrapper for `malloc`, on some systems you can influence the behaviour of the system routine. On linux, `malloc` calls hooks that can be replaced with your own routines; see [http://www.gnu.org/s/libc/manual/html\\_node/Hooks-for-Malloc.html](http://www.gnu.org/s/libc/manual/html_node/Hooks-for-Malloc.html).)

### 26.2.4 Specific techniques: Fortran

Use `Implicit none`.

Put all subprograms in modules so that the compiler can check for missing arguments and type mismatches. It also allows for automatic dependency building with `fdepend`.

Use the C preprocessor for conditional compilation and such.

## 26.3 Testing

There are various philosophies for testing the correctness of a code.

- Correctness proving: the programmer draws up predicates that describe the intended behaviour of code fragments and proves by mathematical techniques that these predicates hold [88, 40].
- Unit testing: each routine is tested separately for correctness. This approach is often hard to do for numerical codes, since with floating point numbers there is essentially an infinity of possible inputs, and it is not easy to decide what would constitute a sufficient set of inputs.
- Integration testing: test subsystems
- System testing: test the whole code. This is often appropriate for numerical codes, since we often have model problems with known solutions, or there are properties such as bounds that need to hold on the global solution.
- Test-driven design: the program development process is driven by the requirement that testing is possible at all times.

With parallel codes we run into a new category of difficulties with testing. Many algorithms, when executed in parallel, will execute operations in a slightly different order, leading to different roundoff behaviour. For instance, the parallel computation of a vector sum will use partial sums. Some algorithms have an inherent damping of numerical errors, for instance stationary iterative methods (section 5.5.1), but others have no such built-in error correction (nonstationary methods; section 5.5.7). As a result, the same iterative process can take different numbers of iterations depending on how many processors are used.

### 26.3.1 Test-driven design and development

In test-driven design there is a strong emphasis on the code always being testable. The basic ideas are as follows.

- Both the whole code and its parts should always be testable.
- When extending the code, make only the smallest change that allows for testing.
- With every change, test before and after.
- Assure correctness before adding new features.

## Chapter 27

### Debugging

When a program misbehaves, *debugging* is the process of finding out *why*. There are various strategies of finding errors in a program. The crudest one is debugging by print statements. If you have a notion of where in your code the error arises, you can edit your code to insert print statements, recompile, rerun, and see if the output gives you any suggestions. There are several problems with this:

- The edit/compile/run cycle is time consuming, especially since
- often the error will be caused by an earlier section of code, requiring you to edit, compile, and rerun repeatedly. Furthermore,
- the amount of data produced by your program can be too large to display and inspect effectively, and
- if your program is parallel, you probably need to print out data from all processors, making the inspection process very tedious.

For these reasons, the best way to debug is by the use of an interactive *debugger*, a program that allows you to monitor and control the behaviour of a running program. In this section you will familiarize yourself with *gdb*, which is the open source debugger of the *GNU* project. Other debuggers are proprietary, and typically come with a compiler suite. Another distinction is that *gdb* is a commandline debugger; there are graphical debuggers such as *ddd* (a frontend to *gdb*) or *DDT* and *TotalView* (debuggers for parallel codes). We limit ourselves to *gdb*, since it incorporates the basic concepts common to all debuggers.

In this tutorial you will debug a number of simple programs with *gdb* and *valgrind*. The files can be downloaded from <http://tinyurl.com/ISTC-debug-tutorial>.

#### 27.1 Invoking *gdb*

There are three ways of using *gdb*: using it to start a program, attaching it to an already running program, or using it to inspect a *core dump*. We will only consider the first possibility.

Here is an example of how to start *gdb* with program that has no arguments (Fortran users, use `hello.F`):

```
tutorials/gdb/c/hello.c
```

```
#include <stdlib.h>
#include <stdio.h>
int main() {
    printf("hello world\n");
    return 0;
}

%% cc -g -o hello hello.c
# regular invocation:
%% ./hello
hello world
# invocation from gdb:
%% gdb hello
GNU gdb 6.3.50-20050815 # ..... version info
Copyright 2004 Free Software Foundation, Inc. .... copyright info ....
(gdb) run
Starting program: /home/eijkhout/tutorials/gdb/hello
Reading symbols for shared libraries +. done
hello world

Program exited normally.
(gdb) quit
%%
```

Important note: the program was compiled with the *debug flag* `-g`. This causes the *symbol table* (that is, the translation from machine address to program variables) and other debug information to be included in the binary. This will make your binary larger than strictly necessary, but it will also make it slower, for instance because the compiler will not perform certain optimizations<sup>1</sup>.

To illustrate the presence of the symbol table do

```
%% cc -g -o hello hello.c
%% gdb hello
GNU gdb 6.3.50-20050815 # ..... version info
(gdb) list
```

and compare it with leaving out the `-g` flag:

```
%% cc -o hello hello.c
%% gdb hello
GNU gdb 6.3.50-20050815 # ..... version info
(gdb) list
```

---

1. Compiler optimizations are not supposed to change the semantics of a program, but sometimes do. This can lead to the nightmare scenario where a program crashes or gives incorrect results, but magically works correctly with compiled with debug and run in a debugger.

For a program with commandline input we give the arguments to the `run` command (Fortran users use `say.F`):

```
tutorials/gdb/c/say.c
```

```
#include <stdlib.h>
#include <stdio.h>
int main(int argc, char **argv) {
    int i;
    for (i=0; i<atoi(argv[1]); i++)
        printf("hello world\n");
    return 0;
}

%% cc -o say -g say.c
%% ./say 2
hello world
hello world
%% gdb say
.... the usual messages ...
(gdb) run 2
Starting program: /home/eijkhout/tutorials/gdb/c/say 2
Reading symbols for shared libraries +. done
hello world
hello world

Program exited normally.
```

### 27.2 Finding errors

Let us now consider some programs with errors.

#### 27.2.1 C programs

```
// square.c
int nmax, i;
float *squares, sum;

fscanf(stdin, "%d", nmax);
for (i=1; i<=nmax; i++) {
    squares[i] = 1./(i*i); sum += squares[i];
}
printf("Sum: %e\n", sum);
```

```

%% cc -g -o square square.c
%% ./square
5000
Segmentation fault

```

The *segmentation fault* (other messages are possible too) indicates that we are accessing memory that we are not allowed to, making the program abort. A debugger will quickly tell us where this happens:

```

%% gdb square
(gdb) run
50000

Program received signal EXC_BAD_ACCESS, Could not access memory.
Reason: KERN_INVALID_ADDRESS at address: 0x000000000000eb4a
0x00007fff824295ca in __svfscanf_l ()

```

Apparently the error occurred in a function `__svfscanf_l`, which is not one of ours, but a system function. Using the backtrace (or `bt`, also `where` or `w`) command we quickly find out how this came to be called:

```

(gdb) backtrace
#0  0x00007fff824295ca in __svfscanf_l ()
#1  0x00007fff8244011b in fscanf ()
#2  0x0000000100000e89 in main (argc=1, argv=0x7fff5fbfc7c0) at square.c:7

```

We take a close look at line 7, and see that we need to change `nmax` to `&nmax`.

There is still an error in our program:

```

(gdb) run
50000

Program received signal EXC_BAD_ACCESS, Could not access memory.
Reason: KERN_PROTECTION_FAILURE at address: 0x000000010000f000
0x0000000100000ebe in main (argc=2, argv=0x7fff5fbfc7a8) at square1.c:9
9      squares[i] = 1./(i*i); sum += squares[i];

```

We investigate further:

```

(gdb) print i
$1 = 11237
(gdb) print squares[i]
Cannot access memory at address 0x10000f000
(gdb) print squares
$2 = (float *) 0x0

```

and we quickly see that we forgot to allocate `squares`.

Memory errors can also occur if we have a legitimate array, but we access it outside its bounds.

```
// up.c
int nlocal = 100,i;
double s, *array = (double*) malloc(nlocal*sizeof(double));
for (i=0; i<nlocal; i++) {
    double di = (double)i;
    array[i] = 1/(di*di);
}
s = 0.;
for (i=nlocal-1; i>=0; i++) {
    double di = (double)i;
    s += array[i];
}
```

```
Program received signal EXC_BAD_ACCESS, Could not access memory.
Reason: KERN_INVALID_ADDRESS at address: 0x0000000100200000
0x0000000100000f43 in main (argc=1, argv=0x7fff5fbfe2c0) at up.c:15
15          s += array[i];
(gdb) print array
$1 = (double *) 0x100104d00
(gdb) print i
$2 = 128608
```

### 27.2.2 Fortran programs

Compile and run the following program:

```
tutorials/gdb/f/square.F
```

```
Program square
real squares(1)
integer i

do i=1,100
    squares(i) = sqrt(1.*i)
    sum = sum + squares(i)
end do
print *, "Sum:", sum

End
```

It should abort with a message such as ‘Illegal instruction’. Running the program in gdb quickly tells you where the problem lies:

```
(gdb) run
Starting program: tutorials/gdb//fsquare
```

```

Reading symbols for shared libraries ++++. done

Program received signal EXC_BAD_INSTRUCTION,
Illegal instruction/operand.
0x0000000100000da3 in square () at square.F:7
7          sum = sum + squares(i)

```

We take a close look at the code and see that we did not allocate `squares` properly.

### 27.3 Memory debugging with Valgrind

Insert the following allocation of `squares` in your program:

```
squares = (float *) malloc( nmax*sizeof(float) );
```

Compile and run your program. The output will likely be correct, although the program is not. Can you see the problem?

To find such subtle memory errors you need a different tool: a memory debugging tool. A popular (because open source) one is *valgrind*; a common commercial tool is *purify*.

```
tutorials/gdb/c/square1.c
```

```

#include <stdlib.h>
#include <stdio.h>
int main(int argc, char **argv) {
    int nmax, i;
    float *squares, sum;

    fscanf(stdin, "%d", &nmax);
    squares = (float*) malloc(nmax*sizeof(float));
    for (i=1; i<=nmax; i++) {
        squares[i] = 1./(i*i);
        sum += squares[i];
    }
    printf("Sum: %e\n", sum);

    return 0;
}

```

Compile this program with `cc -o square1 square1.c` and run it with `valgrind square1` (you need to type the input value). You will lots of output, starting with:

```

%% valgrind square1
==53695== Memcheck, a memory error detector
==53695== Copyright (C) 2002-2010, and GNU GPL'd, by Julian Seward et al.
==53695== Using Valgrind-3.6.1 and LibVEX; rerun with -h for copyright info
==53695== Command: a.out

```



```
==53695==
10
==53695== Invalid write of size 4
==53695==    at 0x100000EB0: main (square1.c:10)
==53695==    Address 0x10027e148 is 0 bytes after a block of size 40 alloc'd
==53695==    at 0x1000101EF: malloc (vg_replace_malloc.c:236)
==53695==    by 0x100000E77: main (square1.c:8)
==53695==
==53695== Invalid read of size 4
==53695==    at 0x100000EC1: main (square1.c:11)
==53695==    Address 0x10027e148 is 0 bytes after a block of size 40 alloc'd
==53695==    at 0x1000101EF: malloc (vg_replace_malloc.c:236)
==53695==    by 0x100000E77: main (square1.c:8)
```

Valgrind is informative but cryptic, since it works on the bare memory, not on variables. Thus, these error messages take some exegesis. They state that a line 10 writes a 4-byte object immediately after a block of 40 bytes that was allocated. In other words: the code is writing outside the bounds of an allocated array. Do you see what the problem in the code is?

Note that valgrind also reports at the end of the program run how much memory is still in use, meaning not properly freed.

If you fix the array bounds and recompile and rerun the program, valgrind still complains:

```
==53785== Conditional jump or move depends on uninitialised value(s)
==53785==    at 0x10006FC68: __dtoa (in /usr/lib/libSystem.B.dylib)
==53785==    by 0x10003199F: __vfprintf (in /usr/lib/libSystem.B.dylib)
==53785==    by 0x1000738AA: vfprintf_l (in /usr/lib/libSystem.B.dylib)
==53785==    by 0x1000A1006: printf (in /usr/lib/libSystem.B.dylib)
==53785==    by 0x100000EF3: main (in ./square2)
```

Although no line number is given, the mention of `printf` gives an indication where the problem lies. The reference to an ‘uninitialized value’ is again cryptic: the only value being output is `sum`, and that is not uninitialized: it has been added to several times. Do you see why valgrind calls it uninitialized all the same?

## 27.4 Stepping through a program

Often the error in a program is sufficiently obscure that you need to investigate the program run in detail. Compile the following program

```
tutorials/gdb/c/roots.c
```

```
#include <stdlib.h>
#include <stdio.h>
#include <math.h>

float root(int n)
{
```

```

float r;
r = sqrt(n);
return r;
}

int main() {
int i;
float x=0;
for (i=100; i>-100; i--)
x += root(i+5);
printf("sum: %e\n",x);
return 0;
}

```

and run it:

```

%% ./roots
sum: nan

```

Start it in gdb as before:

```

%% gdb roots
GNU gdb 6.3.50-20050815
Copyright 2004 Free Software Foundation, Inc.
....

```

but before you run the program, you set a *breakpoint* at main. This tells the execution to stop, or ‘break’, in the main program.

```

(gdb) break main
Breakpoint 1 at 0x100000ea6: file root.c, line 14.

```

Now the program will stop at the first executable statement in main:

```

(gdb) run
Starting program: tutorials/gdb/c/roots
Reading symbols for shared libraries +. done

Breakpoint 1, main () at roots.c:14
14          float x=0;

```

If execution is stopped at a breakpoint, you can do various things, such as issuing the `step` command:

```

Breakpoint 1, main () at roots.c:14
14          float x=0;
(gdb) step
15          for (i=100; i>-100; i--)
(gdb)

```

```
16          x += root(i);  
(gdb)
```

(if you just hit return, the previously issued command is repeated). Do a number of `steps` in a row by hitting return. What do you notice about the function and the loop?

Switch from doing `step` to doing `next`. Now what do you notice about the loop and the function?

Set another breakpoint: `break 17` and do `cont`. What happens?

Rerun the program after you set a breakpoint on the line with the `sqrt` call. When the execution stops there do `where` and `list`.

### 27.5 Inspecting values

Run the previous program again in `gdb`: set a breakpoint at the line that does the `sqrt` call before you actually call `run`. When the program gets to line 8 you can do `print n`. Do `cont`. Where does the program stop?

If you want to repair a variable, you can do `set var=value`. Change the variable `n` and confirm that the square root of the new value is computed. Which commands do you do?

### 27.6 Breakpoints

If a problem occurs in a loop, it can be tedious keep typing `cont` and inspecting the variable with `print`. Instead you can add a condition to an existing breakpoint. First of all, you can make the breakpoint subject to a condition: with

```
condition 1 if (n<0)
```

breakpoint 1 will only obeyed if `n<0` is true.

You can also have a breakpoint that is only activated by some condition. The statement

```
break 8 if (n<0)
```

means that breakpoint 8 becomes (unconditionally) active after the condition `n<0` is encountered.

Another possibility is to use `ignore 1 50`, which will not stop at breakpoint 1 the next 50 times.

Remove the existing breakpoint, redefine it with the condition `n<0` and rerun your program. When the program breaks, find for what value of the loop variable it happened. What is the sequence of commands you use?

You can set a breakpoint in various ways:

- `break foo.c` to stop when code in a certain file is reached;

- `break 123` to stop at a certain line in the current file;
- `break foo` to stop at subprogram `foo`
- or various combinations, such as `break foo.c:123`.
- Finally,
- If you set many breakpoints, you can find out what they are with `info breakpoints`.
- You can remove breakpoints with `delete n` where `n` is the number of the breakpoint.
- If you restart your program with `run` without leaving `gdb`, the breakpoints stay in effect.
- If you leave `gdb`, the breakpoints are cleared but you can save them: `save breakpoints <file>`. Use `source <file>` to read them in on the next `gdb` run.

Finally, you can execute commands at a breakpoint:

```
break 45
command
print x
cont
end
```

This states that at line 45 variable `x` is to be printed, and execution should immediately continue.

If you want to run repeated `gdb` sessions on the same program, you may want to save and reload breakpoints. This can be done with

```
save-breakpoint filename
source filename
```

## 27.7 Parallel debugging

Debugging in parallel is harder than sequentially, because you will run errors that are only due to interaction of processes such as *deadlock*; see section [2.7.3.6](#).

As an example, consider this segment of MPI code:

```
MPI_Init(0,0);
// set comm, ntids, mytid
for (int it=0; ; it++) {
    double randomnumber = ntids * ( rand() / (double)RAND_MAX );
    printf("[%d] iteration %d, random %e\n",mytid,it,randomnumber);
    if (randomnumber>mytid && randomnumber<mytid+1./(ntids+1))
        MPI_Finalize();
}
MPI_Finalize();
```

Each process computes random numbers until a certain condition is satisfied, then exits. However, consider introducing a barrier (or something that acts like it, such as a reduction):

## 27. Debugging

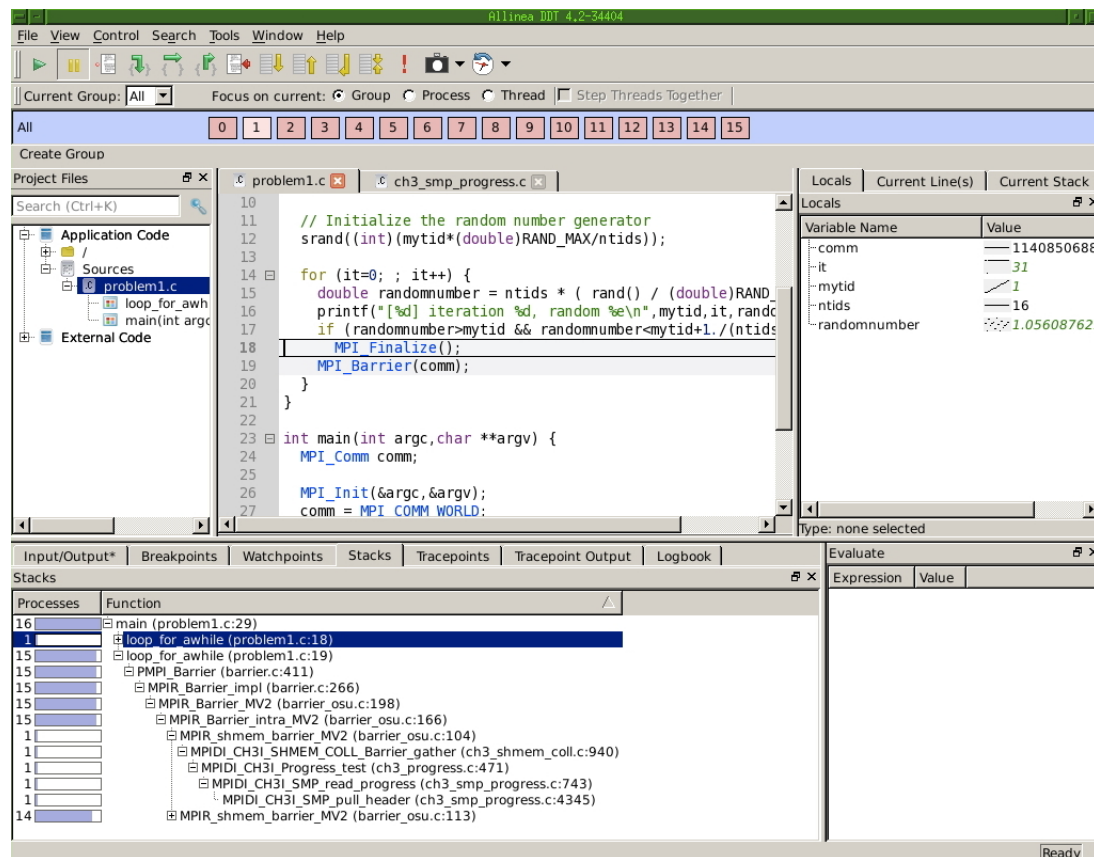

Figure 27.1: Display of 16 processes in the DDT debugger

```
for (int it=0; ; it++) {
    double randomnumber = ntids * ( rand() / (double)RAND_MAX );
    printf("[%d] iteration %d, random %e\n",mytid,it,randomnumber);
    if (randomnumber>mytid && randomnumber<mytid+1./(ntids+1))
        MPI_Finalize();
    MPI_Barrier(comm);
}
MPI_Finalize();
```

Now the execution will hang, and this is not due to any particular process: each process has a code path from init to finalize that does not develop any memory errors or other runtime errors. However as soon as one process reaches the finalize call in the conditional it will stop, and all other processes will be waiting at the barrier.

Figure 27.1 shows the main display of the Alinea DDT debugger (<http://www.allinea.com/products/ddt>) at the point where this code stops. Above the source panel you see that there are 16 processes, and that the status is given for process 1. In the bottom display you see that out of 16 processes

15 are calling `MPI_Barrier` on line 19, while one is at line 18. In the right display you see a listing of the local variables: the value specific to process 1. A rudimentary graph displays the values over the processors: the value of `ntids` is constant, that of `mytid` is linearly increasing, and `it` is constant except for one process.

**Exercise 27.1.** Make and run `ring_1a`. The program does not terminate and does not crash.

In the debugger you can interrupt the execution, and see that all processes are executing a receive statement. This is probably a case of deadlock. Diagnose and fix the error.

**Exercise 27.2.** The author of `ring_1c` was very confused about how MPI works. Run the program. While it terminates without a problem, the output is wrong. Set a breakpoint at the send and receive statements to figure out what is happening.

## 27.8 Further reading

A good tutorial: <http://www.dirac.org/linux/gdb/>.

Reference manual: [http://www.ofb.net/gnu/gdb/gdb\\_toc.html](http://www.ofb.net/gnu/gdb/gdb_toc.html).

## Chapter 28

### C/Fortran interoperability

Most of the time, a program is written in a single language, but in some circumstances it is necessary or desirable to mix sources in more than one language for a single executable. One such case is when a library is written in one language, but used by a program in another. In such a case, the library writer will probably have made it easy for you to use the library; this section is for the case that you find yourself in the place of the library writer. We will focus on the common case of *interoperability* between C/C++ and Fortran.

This issue is complicated by the fact that both languages have been around for a long time, and various recent language standards have introduced mechanisms to facilitate interoperability. However, there is still a lot of old code around, and not all compilers support the latest standards. Therefore, we discuss both the old and the new solutions.

#### 28.1 Linker conventions

As explained above, a compiler turns a source file into a binary, which no longer has any trace of the source language: it contains in effect functions in machine language. The linker will then match up calls and definitions, which can be in different files. The problem with using multiple languages is then that compilers have different notions of how to translate function names from the source file to the binary file.

Let's look at codes (you can find example files in `tutorials/linking`):

```
// C:
    Subroutine foo()
    Return
    End Subroutine
! Fortran
void foo() {
    return;
}
```

After compilation you can use `nm` to investigate the binary *object file*:

```

%% nm fprog.o
000000000000000000 T _foo_
....
%% nm cprog.o
000000000000000000 T _foo
....

```

You see that internally the `foo` routine has different names: the Fortran name has an underscore appended. This makes it hard to call a Fortran routine from C, or vice versa. The possible name mismatches are:

- The Fortran compiler appends an underscore. This is the most common case.
- Sometimes it can append two underscores.
- Typically the routine name is lowercase in the object file, but uppercase is a possibility too.

Since C is a popular language to write libraries in, this means that the problem is often solved in the C library by:

- Appending an underscore to all C function names; or
- Including a simple wrapper call:

```

int SomeCFunction(int i, float f)
{
    .....
}
int SomeCFunction_(int i, float f)
{
    return SomeCFunction(i, f);
}

```

### 28.1.1 C bindings in Fortran 2003

With the latest Fortran standard there are explicit *C bindings*, making it possible to declare the external name of variables and routines:

```

module operator
  real, bind(C) :: x
contains
  subroutine s() bind(C,name='s')
    return
  end subroutine
end module

%% ifort -c fbind.F90
%% nm fbind.o
.... T _s
.... C _x

```



It is also possible to declare data types to be C-compatible:

```
Program fdata

  use iso_c_binding

  type, bind(C) :: c_comp
    real (c_float)  :: data
    integer (c_int) :: i
    type (c_ptr)    :: ptr
  end type

end Program fdata
```

### 28.1.2 C++ linking

Libraries written in C++ offer further problems. The C++ compiler makes external symbols by combining the names a class and its methods, in a process known as *name mangling*. You can force the compiler to generate names that are intelligible to other languages by

```
#ifdef __cplusplus
  extern"C" {
#endif
  .
  .
  place declarations here
  .
  .
#ifdef __cplusplus
  }
#endif
```

Example: compiling

```
#include <stdlib.h>

int foo(int x) {
  return x;
}
```

and inspecting the output with nm gives:

```
00000000000000010 s EH_frame1
00000000000000000 T _foo
```

On the other hand, the identical program compiled as C++ gives

```
00000000000000010 s EH_frame1
00000000000000000 T __Z3fooi
```

You see that the name for `foo` is something mangled, so you can not call this routine from a program in a different language. On the other hand, if you add the `extern` declaration:

```
#include <stdlib.h>

#ifdef __cplusplus
extern "C" {
#endif
int foo(int x) {
    return x;
}
#ifdef __cplusplus
}
#endif
```

you again get the same linker symbols as for C, so that the routine can be called from both C and Fortran.

If your main program is in C, you can use the C++ compiler as linker. If the main program is in Fortran, you need to use the Fortran compiler as linker. It is then necessary to link in extra libraries for the C++ system routines. For instance, with the Intel compiler `-lstdc++ -lc` needs to be added to the link line.

## 28.2 Arrays

C and Fortran have different conventions for storing multi-dimensional arrays. You need to be aware of this when you pass an array between routines written in different languages.

Fortran stores multi-dimensional arrays in *column-major* order; see figure 28.1. For two dimensional arrays  $A(i, j)$  this means that the elements in each column are stored contiguously: a  $2 \times 2$  array is stored as  $A(1, 1)$ ,  $A(2, 1)$ ,  $A(1, 2)$ ,  $A(2, 2)$ . Three and higher dimensional arrays are an obvious extension: it is sometimes said that ‘the left index varies quickest’.

C arrays are stored in *row-major* order: elements in each row are stored contiguous, and columns are then placed sequentially in memory. A  $2 \times 2$  array  $A[2][2]$  is stored as  $A[1][1]$ ,  $A[1][2]$ ,  $A[2][1]$ ,  $A[2][2]$ .

A number of remarks about arrays in C.

- C (before the C99 standard) has multi-dimensional arrays only in a limited sense. You can declare them, but if you pass them to another C function, they no longer look multi-dimensional: they have become plain `float*` (or whatever type) arrays. That brings us to the next point.

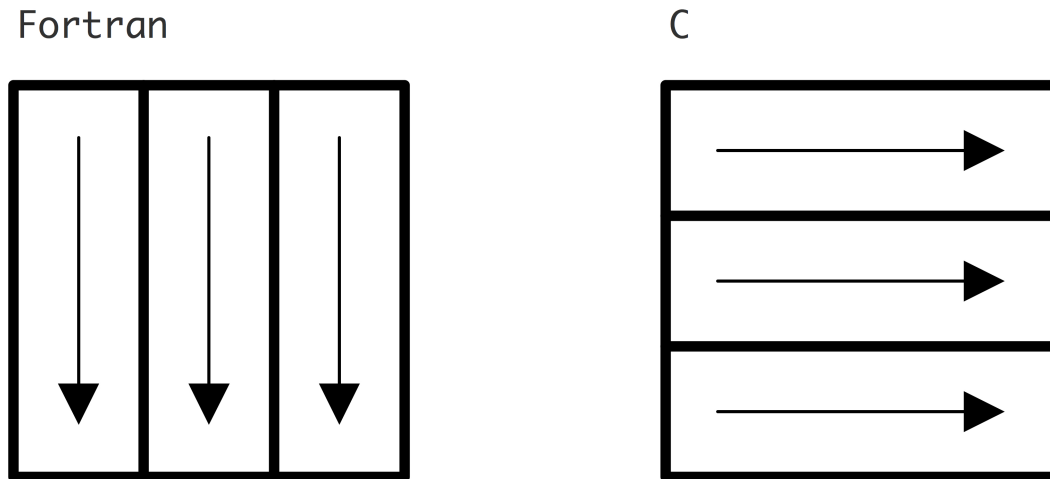

Figure 28.1: Fortran and C array storage by columns and rows respectively

- Multi-dimensional arrays in C look as if they have type `float**`, that is, an array of pointers that point to (separately allocated) arrays for the rows. While you could certainly implement this:

```
float **A;
A = (float**)malloc(m*sizeof(float*));
for (i=0; i<n; i++)
    A[i] = (float*)malloc(n*sizeof(float));
```

careful reading of the standard reveals that a multi-dimensional array is in fact a single block of memory, no further pointers involved.

Given the above limitation on passing multi-dimensional arrays, and the fact that a C routine can not tell whether it's called from Fortran or C, it is best not to bother with multi-dimensional arrays in C, and to emulate them:

```
float *A;
A = (float*)malloc(m*n*sizeof(float));
#define SUB(i, j, m, n) i+j*m
for (i=0; i<m; i++)
    for (j=0; j<n; j++)
        .... A[SUB(i, j, m, n)] ....
```

where for interoperability we store the elements in column-major fashion.

### 28.3 Strings

Programming languages differ widely in how they handle strings.

- In C, a string is an array of characters; the end of the string is indicated by a null character, that is the ascii character zero, which has an all zero bit pattern. This is called *null termination*.
- In Fortran, a string is an array of characters. The length is maintained in an internal variable, which is passed as a hidden parameter to subroutines.
- In Pascal, a string is an array with an integer denoting the length in the first position. Since only one byte is used for this, strings can not be longer than 255 characters in Pascal.

As you can see, passing strings between different languages is fraught with peril. This situation is made even worse by the fact that passing strings as subroutine arguments is not standard.

Example: the main program in Fortran passes a string

```
Program Fstring
  character(len=5) :: word = "Word"
  call cstring(word)
end Program Fstring
```

and the C routine accepts a character string and its length:

```
#include <stdlib.h>
#include <stdio.h>

void cstring_(char *txt,int txtlen) {
  printf("length = %d\n",txtlen);
  printf("<<");
  for (int i=0; i<txtlen; i++)
    printf("%c",txt[i]);
  printf(">>\n");
}
```

which produces:

```
length = 5
<<Word >>
```

To pass a Fortran string to a C program you need to append a null character:

```
call cfunction ('A string'//CHAR(0))
```

Some compilers support extensions to facilitate this, for instance writing

```
DATA forstring /'This is a null-terminated string.'C/
```

Recently, the 'C/Fortran interoperability standard' has provided a systematic solution to this.

## 28.4 Subprogram arguments

In C, you pass a `float` argument to a function if the function needs its value, and `float*` if the function has to modify the value of the variable in the calling environment. Fortran has no such distinction: every variable is passed *by reference*. This has some strange consequences: if you pass a literal value `37` to a subroutine, the compiler will allocate a nameless variable with that value, and pass the address of it, rather than the value<sup>1</sup>.

For interfacing Fortran and C routines, this means that a Fortran routine looks to a C program like all its argument are ‘star’ arguments. Conversely, if you want a C subprogram to be callable from Fortran, all its arguments have to be star-this or that. This means on the one hand that you will sometimes pass a variable by reference that you would like to pass by value.

Worse, it means that C subprograms like

```
void mysub(int **iarray) {
    *iarray = (int*)malloc(8*sizeof(int));
    return;
}
```

can not be called from Fortran. There is a hack to get around this (check out the Fortran77 interface to the Petsc routine `VecGetValues`) and with more cleverness you can use `POINTER` variables for this.

## 28.5 Input/output

Both languages have their own system for handling input/output, and it is not really possible to meet in the middle. Basically, if Fortran routines do I/O, the main program has to be in Fortran. Consequently, it is best to isolate I/O as much as possible, and use C for I/O in mixed language programming.

## 28.6 Fortran/C interoperability in Fortran2003

The latest version of Fortran, unsupported by many compilers at this time, has mechanisms for interfacing to C.

- There is a module that contains named kinds, so that one can declare  

```
INTEGER, KIND(C_SHORT) :: i
```
- Fortran pointers are more complicated objects, so passing them to C is hard; Fortran2003 has a mechanism to deal with C pointers, which are just addresses.
- Fortran derived types can be made compatible with C structures.

---

1. With a bit of cleverness and the right compiler, you can have a program that says `print *, 7` and prints 8 because of this.

## Chapter 29

### LaTeX for scientific documentation

#### 29.1 The idea behind L<sup>A</sup>T<sub>E</sub>X, some history of T<sub>E</sub>X

T<sub>E</sub>X is a typesetting system that dates back to the late 1970s. In those days, graphics terminals where you could design a document layout and immediately view it, the way you can with for instance Microsoft Word, were rare. Instead, T<sub>E</sub>X uses a two-step workflow, where you first type in your document with formatting instructions in an ascii document, using your favourite text editor. Next, you would invoke the `latex` program, as a sort of compiler, to translate this document to a form that can be printed or viewed.

```
%% edit mydocument.tex
%% latex mydocument
%% # print or view the resulting output
```

The process is comparable to making web pages by typing HTML commands.

This way of working may seem clumsy, but it has some advantages. For instance, the T<sub>E</sub>X input files are plain ascii, so they can easily be generated automatically, for instance from a database. Also, you can edit them with whatever your favourite editor happens to be.

Another point in favour of T<sub>E</sub>X is the fact that the layout is specified by commands that are written in a sort of programming language. This has some important consequences:

- Separation of concerns: when you are writing your document, you do not have to think about layout. You give the ‘chapter’ command, and the implementation of that command will be decided independently, for instance by you choosing a document style.
- Changing the layout of a finished document is easily done by choosing a different realization of the layout commands in the input file: the same ‘chapter’ command is used, but by choosing a different style the resulting layout is different. This sort of change can be as simple as a one-line change to the document style declaration.
- If you have unusual typesetting needs, it is possible to write new T<sub>E</sub>X commands for this. For many needs such extensions have in fact already been written; see section [29.4](#).

The commands in T<sub>E</sub>X are fairly low level. For this reason, a number of people have written systems on top of T<sub>E</sub>X that offer powerful features, such as automatic cross-referencing, or generation of a table of contents. The most popular of these systems is L<sup>A</sup>T<sub>E</sub>X. Since T<sub>E</sub>X is an interpreted system, all of its mechanisms are still available to the user, even though L<sup>A</sup>T<sub>E</sub>X is loaded on top of it.

### 29.1.1 Installing L<sup>A</sup>T<sub>E</sub>X

The easiest way to install L<sup>A</sup>T<sub>E</sub>X on your system is by downloading the T<sub>E</sub>Xlive distribution from <http://tug.org/texlive>. Apple users can also use `fink` or `macports`. Various front-ends to T<sub>E</sub>X exist, such as T<sub>E</sub>Xshop on the Mac.

### 29.1.2 Running L<sup>A</sup>T<sub>E</sub>X

**Purpose.** In this section you will run the L<sup>A</sup>T<sub>E</sub>X compiler

Originally, the `latex` compiler would output a device independent file format, named `dvi`, which could then be translated to PostScript or PDF, or directly printed. These days, many people use the `pdflatex` program which directly translates `.tex` files to `.pdf` files. This has the big advantage that the generated PDF files have automatic cross linking and a side panel with table of contents. An illustration is found below.

Let us do a simple example.

```
\documentclass{article}
\begin{document}
Hello world!
\end{document}
```

Figure 29.1: A minimal L<sup>A</sup>T<sub>E</sub>X document

**Exercise.** Create a text file `minimal.tex` with the content as in figure 29.1. Try the command `pdflatex minimal` or `latex minimal`. Did you get a file `minimal.pdf` in the first case or `minimal.dvi` in the second case? Use a pdf viewer, such as Adobe Reader, or `dvips` respectively to view the output.

*Caveats.* If you make a typo, T<sub>E</sub>X can be somewhat unfriendly. If you get an error message and T<sub>E</sub>X is asking for input, typing `x` usually gets you out, or `Ctrl-C`. Some systems allow you to type `e` to go directly into the editor to correct the typo.

## 29.2 A gentle introduction to LaTeX

Here you will get a very brief run-through of L<sup>A</sup>T<sub>E</sub>X features. There are various more in-depth tutorials available, such as the one by Oetiker [128].

### 29.2.1 Document structure

Each L<sup>A</sup>T<sub>E</sub>X document needs the following lines:

```
\documentclass{ .... } % the dots will be replaced

\begin{document}

\end{document}
```

The ‘documentclass’ line needs a class name in between the braces; typical values are ‘article’ or ‘book’. Some organizations have their own styles, for instance ‘ieeeproc’ is for proceedings of the IEEE.

All document text goes between the `\begin{document}` and `\end{document}` lines. (Matched ‘begin’ and ‘end’ lines are said to denote an ‘environment’, in this case the document environment.)

The part before `\begin{document}` is called the ‘preamble’. It contains customizations for this particular document. For instance, a command to make the whole document double spaced would go in the preamble. If you are using `pdflatex` to format your document, you want a line

```
\usepackage{hyperref}
```

here.

Have you noticed the following?

- The backslash character is special: it starts a  $\LaTeX$  command.
- The braces are also special: they have various functions, such as indicating the argument of a command.
- The percent character indicates that everything to the end of the line is a comment.

### 29.2.2 Some simple text

**Purpose.** In this section you will learn some basics of text formatting.

**Exercise.** Create a file `first.tex` with the content of figure 29.1 in it. Type some text in the preamble, that is, before the `\begin{document}` line and run `pdflatex` on your file.

*Expected outcome.* You should get an error message because you are not allowed to have text in the preamble. Only commands are allowed there; all text has to go after `\begin{document}`.

**Exercise.** Edit your document: put some text in between the `\begin{document}` and `\end{document}` lines. Let your text have both some long lines that go on for a while, and some short ones. Put superfluous spaces between words, and at the beginning or end of lines. Run `pdflatex` on your document and view the output.

*Expected outcome.* You notice that the white space in your input has been collapsed in the output.  $\TeX$  has its own notions about what space should look like, and you do not have to concern yourself with this matter.

**Exercise.** Edit your document again, cutting and pasting the paragraph, but leaving a blank line between the two copies. Paste it a third time, leaving several blank lines. Format, and view the output.



*Expected outcome.* T<sub>E</sub>X interprets one or more blank lines as the separation between paragraphs.

**Exercise.** Add `\usepackage{pslatex}` to the preamble and rerun `pdflatex` on your document. What changed in the output?

*Expected outcome.* This should have the effect of changing the typeface from the default to Times Roman.

*Caveats.* Typefaces are notoriously unstandardized. Attempts to use different typefaces may or may not work. Little can be said about this in general.

Add the following line before the first paragraph:

```
\section{This is a section}
```

and a similar line before the second. Format. You see that L<sup>A</sup>T<sub>E</sub>X automatically numbers the sections, and that it handles indentation different for the first paragraph after a heading.

**Exercise.** Replace `article` by `artikel3` in the documentclass declaration line and reformat your document. What changed?

*Expected outcome.* There are many documentclasses that implement the same commands as `article` (or another standard style), but that have their own layout. Your document should format without any problem, but get a better looking layout.

*Caveats.* The `artikel3` class is part of most distributions these days, but you can get an error message about an unknown documentclass if it is missing or if your environment is not set up correctly. This depends on your installation. If the file seems missing, download the files from <http://tug.org/texmf-dist/tex/latex/ntgclass/> and put them in your current directory; see also section 29.2.9.

### 29.2.3 Math

**Purpose.** In this section you will learn the basics of math typesetting

One of the goals of the original T<sub>E</sub>X system was to facilitate the setting of mathematics. There are two ways to have math in your document:

- Inline math is part of a paragraph, and is delimited by dollar signs.
- Display math is, as the name implies, displayed by itself.

**Exercise.** Put  $x+y$  somewhere in a paragraph and format your document. Put  $[x+y]$  somewhere in a paragraph and format.

*Expected outcome.* Formulas between single dollars are included in the paragraph where you declare them. Formulas between  $[ \dots ]$  are typeset in a display.

For display equations with a number, use an `equation` environment. Try this.

Here are some common things to do in math. Make sure to try them out.

- Subscripts and superscripts:  $x_i^2$ . If the sub or superscript is more than a single symbol, it needs to be grouped:  $x_{i+1}^{2n}$ . If you need a brace in a formula, use  $\{ \}$ .
- Greek letters and other symbols:  $\alpha \otimes \beta_i$ .
- Combinations of all these  $\int_{t=0}^{\infty} t dt$ .

**Exercise.** Take the last example and typeset it as display math. Do you see a difference with inline math?

*Expected outcome.* TeX tries not to include the distance between text lines, even if there is math in a paragraph. For this reason it typesets the bounds on an integral sign differently from display math.

### 29.2.4 Referencing

**Purpose.** In this section you will see TeX's cross referencing mechanism in action.

So far you have not seen LaTeX do much that would save you any work. The cross referencing mechanism of LaTeX will definitely save you work: any counter that LaTeX inserts (such as section numbers) can be referenced by a label. As a result, the reference will always be correct.

Start with an example document that has at least two section headings. After your first section heading, put the command `\label{sec:first}`, and put `\label{sec:other}` after the second section heading. These label commands can go on the same line as the `section` command, or on the next. Now put

```
As we will see in section~\ref{sec:other}.
```

in the paragraph before the second section. (The tilde character denotes a non-breaking space.)

**Exercise.** Make these edits and format the document. Do you see the warning about an undefined reference? Take a look at the output file. Format the document again, and check the output again. Do you have any new files in your directory?

*Expected outcome.* On a first pass through a document, the TeX compiler will gather all labels with their values in a `.aux` file. The document will display a double question mark for any references that are unknown. In the second pass the correct values will be filled in.

*Caveats.* If after the second pass there are still undefined references, you probably made a typo. If you use the `bibtex` utility for literature references, you will regularly need three passes to get all references resolved correctly.

Above you saw that the `equation` environment gives displayed math with an equation number. You can add a label to this environment to refer to the equation number.

**Exercise.** Write a formula in an `equation` environment, and add a label. Refer to this label anywhere in the text. Format (twice) and check the output.

*Expected outcome.* The `\label` and `\ref` command are used in the same way for formulas as for section numbers. Note that you must use `\begin/end{equation}` rather than `[...]` for the formula.

### 29.2.5 Lists

**Purpose.** In this section you will see the basics of lists.

Bulleted and numbered lists are provided through an environment.

```
\begin{itemize}
\item This is an item;
\item this is one too.
\end{itemize}
\begin{enumerate}
\item This item is numbered;
\item this one is two.
\end{enumerate}
```

**Exercise.** Add some lists to your document, including nested lists. Inspect the output.

*Expected outcome.* Nested lists will be indented further and the labeling and numbering style changes with the list depth.

**Exercise.** Add a label to an item in an `enumerate` list and refer to it.

*Expected outcome.* Again, the `\label` and `\ref` commands work as before.

### 29.2.6 Source code and algorithms

As a computer scientist, you will often want to include algorithms in your writings; sometimes even source code.

In this tutorial so far you have seen that some characters have special meaning to  $\LaTeX$ , and just can not just type them and expect them to show up in the output. Since funny characters appear quite regularly in programming languages, we need a tool for this: the *verbatim mode*.

To display bits of code inside a paragraph, you use the `\verb` command. This command delimits its argument with two identical characters that can not appear in the verbatim text. For instance, the output `if (x%5>0) { ... }` is produced by `\verb+if (x%5>0) { ... }+`. (Exercise: how did the author of this book get that verbatim command in the text?)

For longer stretches of verbatim text, that need to be displayed by themselves you use

```
\begin{verbatim}
stuff
\end{verbatim}
```

Finally, in order to include a whole file as verbatim listing, use `.`

Verbatim text is one way of displaying algorithms, but there are more elegant solutions. For instance, in this book the following is used:

```
\usepackage[algo2e,noline,noend]{algorithm2e}
```

The result can be seen, for instance, on page [271](#).

### 29.2.7 Graphics

Since you can not immediately see the output of what you are typing, sometimes the output may come as a surprise. That is especially so with graphics.  $\LaTeX$  has no standard way of dealing with graphics, but the following is a common set of commands:

```
\usepackage{graphicx} % this line in the preamble

\includegraphics{myfigure} % in the body of the document
```

The figure can be in any of a number of formats, except that PostScript figures (with extension `.ps` or `.eps`) can not be used if you use `pdflatex`.

Since your figure is often not the right size, the include line will usually have something like:

```
\includegraphics[scale=.5]{myfigure}
```

A bigger problem is that figures can be too big to fit on the page if they are placed where you declare them. For this reason, they are usually treated as ‘floating material’. Here is a typical declaration of a figure:

```
\begin{figure}[ht]
  \includegraphics{myfigure}
  \caption{This is a figure}
  \label{fig:first}
\end{figure}
```

It contains the following elements:

- The `figure` environment is for ‘floating’ figures; they can be placed right at the location where they are declared, at the top or bottom of the next page, at the end of the chapter, et cetera.
- The `[ht]` argument of the `\begin{figure}` line states that your figure should be attempted to be placed here; if that does not work, it should go top of the next page. The remaining possible specifications are `b` for placement at the bottom of a page, or `p` for placement on a page by itself. For example

```
\begin{figure}[hbp]
```

declares that the figure has to be placed here if possible, at the bottom of the page if that’s not possible, and on a page of its own if it is too big to fit on a page with text.

- A caption to be put under the figure, including a figure number;
- A label so that you can refer to the figure number by its label: `figure~\ref{fig:first}`.
- And of course the figure material. There are various ways to fine-tune the figure placement. For instance

```
\begin{center}
  \includegraphics{myfigure}
\end{center}
```

gives a centered figure.

### 29.2.8 Bibliography references

The mechanism for citing papers and books in your document is a bit like that for cross referencing. There are labels involved, and there is a `\cite{thatbook}` command that inserts a reference, usually numeric. However, since you are likely to refer to a paper or book in more than one document you write,  $\LaTeX$  allows you to have a database of literature references in a file by itself, rather than somewhere in your document.

Make a file `mybibliography.bib` with the following content:

```
@article{JoeDoe1985,  
  author = {Joe Doe},  
  title = {A framework for bibliography references},  
  journal = {American Library Assoc. Mag.},  
  year = {1985}  
}
```

In your document `mydocument.tex`, put

```
For details, refer to Doe~\cite{JoeDoe1985} % somewhere in the text  
  
\bibliography{mybibliography} % at the end of the document  
\bibliographystyle{plain}
```

Format your document, then type on the commandline

```
bibtex mydocument
```

and format your document two more times. There should now be a bibliography in it, and a correct citation. You will also see that files `mydocument.bbl` and `mydocument.blg` have been created.

### 29.2.9 Environment variables

On Unix systems,  $\TeX$  investigates the `TEXINPUTS` *environment variable* when it tries to find an include file. Consequently, you can create a directory for your styles and other downloaded include files, and set this variable to the location of that directory. Similarly, the `BIBINPUTS` variable indicates the location of bibliography files for `bibtex` (section [29.2.8](#)).

## 29.3 A worked out example

The following example `demo.tex` contains many of the elements discussed above.

```
\documentclass{artikel3}  
  
\usepackage{pslatex,graphicx,amsmath,amssymb}  
\usepackage{pdflatex}  
  
\newtheorem{theorem}{Theorem}
```

```

\newcounter{excounter}
\newenvironment{exercise}
  {\refstepcounter{excounter}
   \begin{quotation}\textbf{Exercise \arabic{excounter}.} }
  {\end{quotation}}

\begin{document}
\title{SSC 335: demo}
\author{Victor Eijkhout}
\date{today}
\maketitle

\section{This is a section}
\label{sec:intro}

This is a test document, used in~\cite{latexdemo}. It contains a
discussion in section~\ref{sec:discussion}.

\begin{exercise}\label{easy-ex}
  Left to the reader.
\end{exercise}
\begin{exercise}
  Also left to the reader, just like in exercise~\ref{easy-ex}
\end{exercise}

\begin{theorem}
  This is cool.
\end{theorem}
This is a formula:  $a \rightarrow b$ .
\begin{equation}
  \label{eq:one}
  x_i \rightarrow y_{ij} \cdot x^{(k)}_j
\end{equation}
Text:  $\int_0^1 \sqrt{x} \, dx$ 
\[
  \int_0^1 \sqrt{x} \, dx
\]
\section{This is another section}
\label{sec:discussion}

\begin{table}[ht]
  \centering
  \begin{tabular}{|r|}
    \hline one&value \\ \hline another&values \\ \hline
  \end{tabular}
  \caption{This is the only table in my demo}
  \label{tab:thetable}
\end{table}

```

```
\begin{figure}[ht]
  \centering
  \includegraphics{graphics/caches}
  \caption{this is the only figure}
  \label{fig:thefigure}
\end{figure}
As I showed in the introductory section~\ref{sec:intro}, in the
paper~\cite{AdJo:colorblind}, it was shown that
equation~\eqref{eq:one}
\begin{itemize}
\item There is an item.
\item There is another item
  \begin{itemize}
    \item sub one
    \item sub two
  \end{itemize}
\end{itemize}
\begin{enumerate}
\item item one
\item item two
  \begin{enumerate}
    \item sub one
    \item sub two
  \end{enumerate}
\end{enumerate}

\tableofcontents
\listoffigures

\bibliography{math}
\bibliographystyle{plain}

\end{document}
```

You also need the file `math.bib`:

```
@article{AdJo:colorblind,
author = {Loyce M. Adams and Harry F. Jordan},
title = {Is {SOR} color-blind?},
journal = {SIAM J. Sci. Stat. Comput.},
year = {1986},
volume = {7},
pages = {490--506},
abstract = {For what stencils do ordinary and multi-colour SOR have
the same eigenvalues.},
keywords = {SOR, colouring}
}

@misc{latexdemo,
```

```
author = {Victor Eijkhout},  
title = {Short {\LaTeX}\ demo},  
note = {SSC 335, oct 1, 2008}  
}
```

The following sequence of commands

```
pdflatex demo  
bibtex demo  
pdflatex demo  
pdflatex demo
```

gives



## SSC 335: demo

Victor Eijkhout

today

### 1 This is a section

This is a test document, used in [2]. It contains a discussion in section 2.

**Exercise 1.** Left to the reader.

**Exercise 2.** Also left to the reader, just like in exercise 1

**Theorem 1** *This is cool.*

This is a formula:  $a \Leftarrow b$ .

$$x_i \leftarrow y_{ij} \cdot x_j^{(k)} \tag{1}$$

Text:  $\int_0^1 \sqrt{x} dx$

$$\int_0^1 \sqrt{x} dx$$

### 2 This is another section

one	value
another	values

Table 1: This is the only table in my demo

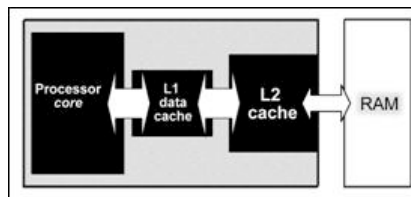

Figure 1: this is the only figure

As I showed in the introductory section 1, in the paper [1], it was shown that equation (1)

- There is an item.

- There is another item
  - sub one
  - sub two
- 1. item one
- 2. item two
  - (a) sub one
  - (b) sub two

**Contents**

- 1 This is a section *I*
- 2 This is another section *I*

**List of Figures**

- 1 this is the only figure *I*

**References**

- [1] Loyce M. Adams and Harry F. Jordan. Is SOR color-blind? *SIAM J. Sci. Stat. Comput.*, 7:490–506, 1986.
- [2] Victor Eijkhout. Short L<sup>A</sup>T<sub>E</sub>X demo. SSC 335, oct 1, 2008.

## 29.4 Where to take it from here

This tutorial touched only briefly on some essentials of  $\TeX$  and  $\LaTeX$ . You can find longer intros on-line [128], or read a book [106, 100, 126]. Macro packages and other software can be found on the Comprehensive  $\TeX$  Archive <http://www.ctan.org>. For questions you can go to the newsgroup `comp.text.tex`, but the most common ones can often already be found on web sites [152].

**PART V**

**PROJECTS, CODES, INDEX**

## Chapter 30

### Class projects

#### 30.1 Cache simulation and analysis

In this project you will build a cache simulator and analyze the cache hit/miss behaviour of code, either real or simulated.

##### 30.1.1 Cache simulation

A simulated cache is a simple data structure that records for each cache address what memory address it contains, and how long the data has been present. Design this data structure and write the access routines. (Use of an object oriented language is recommended.)

Write your code so that your cache can have various levels of associativity, and different replacement policies.

For simplicity, do not distinguish between read and write access. Therefore, the execution of a program becomes a stream of

```
cache.access_address( 123456 );  
cache.access_address( 70543 );  
cache.access_address( 12338383 );  
.....
```

calls where the argument is the memory address. Your code will record whether the request can be satisfied from cache, or whether the data needs to be loaded from memory.

##### 30.1.2 Code simulation

Find some example codes, for instance from a scientific project you are involved in, and translate the code to a sequence of memory address.

You can also simulate codes by generating a stream of access instructions as above:

- Some access will be to random locations, corresponding to use of scalar variables;
- At other times access will be to regularly space addresses, corresponding to the use of an array;

- Array operations with indirect addressing will cause prolonged episodes of random address access.

Try out various mixes of the above instruction types. For the array operations, try smaller and larger arrays with various degrees of reuse.

Does your simulated code behave like a real code?

### 30.1.3 Investigation

First implement a single cache level and investigate the behaviour of cache hits and misses. Explore different associativity amounts and different replacement policies.

### 30.1.4 Analysis

Do a statistical analysis of the cache hit/miss behaviour. You can start with [140]<sup>1</sup>. Hartstein [80] found a power law behaviour. Are you finding the same?

---

1. Strictly speaking that paper is about page swapping out of virtual memory (section 1.3.8), but everything translates to cacheline swapping out of main memory.

## 30.2 Evaluation of Bulk Synchronous Programming

In this project you're asked to analyze the Bulk Synchronous Parallel (BSP) model, both abstractly and by simulation.

### 30.2.1 Discussion

For your assignment you need to investigate Bulk Synchronous Programming. Read the wikipedia article [http://en.wikipedia.org/wiki/Bulk\\_synchronous\\_parallel](http://en.wikipedia.org/wiki/Bulk_synchronous_parallel) and section 2.7.8 in the book.

Consider the following questions.

1. Discuss the relation between the complexity model of BSP and the  $\alpha, \beta, \gamma$  model you learned in section 6.1.
2. BSP uses barrier synchronisations. Are these necessary in practice? Consider separately two different classes of algorithms, namely PDE solving, and large scale graph computations.

### 30.2.2 Simulation

In the defining paper on BSP, Valiant [154] advocates making more tasks than processors, and distributing them randomly. Program a simulation and test if this strategy solves the load balance problem. Discuss the random placement strategy in the context of various algorithms.

### 30.3 Heat equation

In this project you will combine some of the theory and practical skills you learned in class to solve a real world problem. In addition to writing code that solves the program, you will use the following software practices:

- use source code control,
- give the program checkpoint/restart capability, and
- use basic profiling and visualization of the results.

The Heat Equation (see section 4.3) is given by

$$\frac{\partial T(x, t)}{\partial t} = \begin{cases} \alpha \frac{\partial^2 T(x, y)}{\partial x^2} + q(x, t) & \text{1D} \\ \alpha \frac{\partial^2 T(x, y)}{\partial x^2} + \alpha \frac{\partial^2 T(x, y)}{\partial y^2} + q(x, t) & \text{2D} \\ \dots & \text{3D} \end{cases}$$

where  $t \geq 0$  and  $x \in [0, 1]$ , subject to boundary conditions

$$T(x, 0) = T_0(x), \quad \text{for } x \in [0, 1],$$

and similar in higher dimensions, and

$$T(0, t) = T_a(t), \quad T(1, t) = T_b(t), \quad \text{for } t > 0.$$

You will solve this problem using the explicit and implicit Euler methods.

#### 30.3.1 Software

Write your software using the PETSc library (see tutorial 24). In particular, use the `MatMult` routine for matrix-vector multiplication and `KSPSolve` for linear system solution. Exception: code the Euler methods yourself.

Be sure to use a Makefile for building your project (tutorial 21).

Add your source files, Makefile, and job scripts to an svn repository (tutorial 22); do not add binaries or output files. Make sure that there is a README file with instructions on how to build and run your code.

Implement a checkpoint/restart facility by writing vector data, size of the time step, and other necessary items, to an hdf5 file (tutorial 23). Your program should be able to read this file and resume execution.

#### 30.3.2 Tests

Do the following tests on a single core.



**Method stability**

Run your program for the 1D case with

$$\begin{cases} q = \sin \ell \pi x \\ T_0(x) = e^x \\ T_a(t) = T_b(t) = 0 \\ \alpha = 1 \end{cases}$$

Take a space discretization at least  $h = 10^{-2}$  but especially in parallel do not be afraid to try large problem sizes. Try various time steps and show that the explicit method can diverge. What is the maximum time step for which it is stable?

For the implicit method, at first use a direct method to solve the system. This corresponds to PETSc options `KSPPREONLY` and `PCLU` (see section 5.5.10 and the PETSc tutorial, 24).

Now use an iterative method (for instance `KSPCG` and `PCJACOBI`); is the method still stable? Explore using a low convergence tolerance and large time steps.

Since the forcing function  $q$  and the boundary conditions have no time dependence, the solution  $u(\cdot, t)$  will converge to a *steady state* solution  $u_\infty(x)$  as  $t \rightarrow \infty$ . What is the influence of the time step on the speed with which implicit method converges to this steady state?

Hint: the steady state is described by  $u_t \equiv 0$ . Substitute this in the PDE. Can you find explicitly what the steady state is?

Run these tests with various values for  $\ell$ .

**Timing**

If you run your code with the commandline option `-log_summary`, you will get a table of timings of the various PETSc routines. Use that to do the following timing experiments. Make sure you use a version of PETSc that was *not* compiled with debug mode.

Construct your coefficient matrix as a dense matrix, rather than sparse. Report on the difference in total memory, and the runtime and flop rate of doing one time step. Do this for both the explicit and implicit method and explain the results.

With a sparse coefficient matrix, report on the timing of a single time step. Discuss the respective flop counts and the resulting performance.

**Restart**

Implement a restart facility: every 10 iterations write out the values of the current iterate, together with values of  $\Delta x$ ,  $\Delta t$ , and  $\ell$ . Add a flag `-restart` to your program that causes it to read the restart file and resume execution, reading all parameters from the restart file.

Run your program for 25 iterations, and restart, causing it to run again from iteration 20. Check that the values in iterations 20 . . . 25 match.

### 30.3.3 Parallelism

Do the following tests to determine the parallel scaling of your code.

At first test the explicit method, which should be perfectly parallel. Report on actual speedup attained. Try larger and smaller problem sizes and report on the influence of the problem size.

The above settings for the implicit method (`KSPPREONLY` and `PCLU`) lead to a runtime error. One way out is to let the system be solved by an iterative method. Read the PETSc manual and web pages to find out some choices of iterative method and preconditioner and try them. Report on their efficacy.

### 30.3.4 Comparison of solvers

In the implicit timestepping method you need to solve linear systems. In the 2D (or 3D) case it can make a big difference whether you use a direct solver or an iterative one.

Set up your code to run with  $q \equiv 0$  and zero boundary conditions everywhere; start with a nonzero initial solution. You should now get convergence to a zero steady state, thus the norm of the current solution is the norm of the iterate.

Now do the following comparison; take several values for the time step.

#### Direct solver

If your PETSc installation includes direct solvers such as *MUMPS*, you can invoke them with

```
myprog -pc_type lu -ksp_type preonly \
      -pc_factor_mat_solver_package mumps
```

Run your code with a direct solver, both sequentially and in parallel, and record how long it takes for the error to get down to  $10^{-6}$ .

#### Iterative Solver

Use an iterative solver, for instance *KSPCG* and *KSPBCGS*. Experiment with the convergence tolerance: how many timesteps does it take to get a  $10^{-6}$  error if you set the iterative method tolerance to  $10^{-12}$ , how much if you take a lesser tolerance?

Compare timings between direct and iterative method.

### 30.3.5 Reporting

Write your report using L<sup>A</sup>T<sub>E</sub>X (tutorial 29). Use both tables and graphs to report numerical results. Use `gnuplot` (tutorial 25) or a related utility for graphs.

### 30.4 The memory wall

In this project you explore the ramifications of the *memory wall*; see section 1.3. This project involves literature search, but little programming.

#### 30.4.1 Background

Wulf and McKee [166] observed trends in the average latency in processors. Let  $t_m$  be the latency from memory,  $t_c$  the latency from cache, and  $p$  the probability of a cache hit, then the average latency is

$$t_{\text{avg}} = pt_c + (1 - p)t_m.$$

As the gap between processor speed and memory speed increases, this latency will grow, unless one can drive  $p$  down, that is, reduce the number of cache misses or at least lessen their importance.

#### 30.4.2 Assignment

Do a literature search and discuss the following topics.

- What have the trends been in processor speed and memory speed? What bearing does the introduction of multicore chips have on this balance?
- Section 1.3.4.3 discussed various types of cache misses. Some misses are more related to the algorithm and some more to the hardware. What strategies have hardware designers used to lessen impact of cache misses?
- Compulsory cache misses seem unavoidable, since they are a property of the algorithm. However, if they can be hidden (see section 1.3.2 for ‘latency hiding’) their performance impact disappears. Research the topic of prefetch streams and their relation to latency hiding.
- How does the size of a cacheline interact with this behaviour?
- Discuss compiler techniques that lessen the incidence of cache misses.
- Can you find examples of algorithm options, that is, algorithms that compute the same result (not necessarily in the arithmetic sense; compare direct square root versus iterative approximation) but with different computational behaviour?

For all of these topics you are encouraged to write simulations.

## Chapter 31

### Codes

This section contains several simple codes that illustrate various issues relating to the performance of a single CPU. The explanations can be found in section 1.6.

#### 31.1 Preliminaries

##### 31.1.1 Hardware event counting

The codes in this chapter make calls to a library named PAPI for ‘Performance Application Programming Interface’ [19, 135]. This is a portable set of calls to query the hardware counters that are built into most processors. Since these counters are part of the processor hardware, they can measure detailed events such as cache misses without this measurement process disturbing the phenomenon it is supposed to observe.

While using hardware counters is fairly straightforward, the question of whether what they are reporting is what you actually meant to measure is another matter altogether. For instance, the presence of hardware prefetch streams (section 1.3.5) implies that data can be loaded into cache without this load being triggered by a cache miss. Thus, the counters may report numbers that seem off, or even impossible, under a naive interpretation.

##### 31.1.2 Test setup

In the next sections you will see several codes that try to do precise timings on some phenomenon. This requires some care if you want to be sure you are actually timing what you’re interested in, and not something else.

First of all, of course you perform your experiment multiple times to get a good average timing. If the individual timings are too far apart, you can decide to throw away outliers, or maybe rethink your experiment: there may be a variable that you haven’t accounted for.

Let’s assume that your timings are all within an acceptable spread; next you have to compensate for cache effects stemming from the fact that you are doing an experiment multiple times. If your problem sizes is small, the first timing will bring all data in cache, and the second run will find it there, leading to much faster runtimes. You can solve this problem by, in between any pair of timings, touching an array that is larger than the cache size. This has the effect of flushing all experiment data from the cache.

On the other hand, if you want to time something that happens on data in cache, you want to be sure that your data is in cache, so you could for instance write to the array, bringing it in cache, prior to your experiment. This is sometimes referred to as *cache warming*, and a cache that contains the problem data is called a *hot cache*. Failure to warm the cache leads to an results where the first run takes appreciably longer than the rest.

### 31.1.3 Memory issues

For performance reasons it is often desirable to enforce *cacheline boundary alignment* of data. The easiest solution is to use *static allocation*, which puts the data on cacheline boundaries.

To put dynamically aligned data on cacheline boundaries, the following code does the tric:

```
double *a;
a = malloc( /* some number of bytes */ +8 );
if ( (int)a % 8 != 0 ) { /* it is not 8-byte aligned */
    a += 1; /* advance address by 8 bytes, then */
    /* either: */
    a = ( (a>>3) <<3 );
    /* or: */
    a = 8 * ( ( (int)a )/8 );
}
```

This code allocates a block of memory, and, if necessary, shifts it right to have a starting address that is a multiple of 8.

However, a better solution is to use *posix\_memalign*:

```
int posix_memalign(
    void **memptr, size_t alignment, size_t size);
```

which allocates *size* bytes, aligned to a multiple of *alignment* bytes. For example:

```
double x;
posix_memalign( (void**)&x, 64, N*sizeof(double) );
```

will allocate 64 doubles for *x*, and align the array to cacheline boundaries if there are 8 words per cacheline.

## 31.2 Cache size

This code demonstrates the fact that operations are more efficient if data is found in L1 cache, than in L2, L3, or main memory. To make sure we do not measure any unintended data movement, we perform one iteration to bring data in the cache before we start the timers.

```

/*
 * File:    size.c
 * Author:  Victor Eijkhout <eijkhout@tacc.utexas.edu>
 *
 * Usage:  size
 */

#include "papi_test.h"
extern int TESTS_QUIET;          /* Declared in test_utils.c */

#define PCHECK(e) \
    if (e!=PAPI_OK) \
        {printf("Problem in papi call, line %d\n",__LINE__); return 1;}
#define NEVENTS 3
#define NRUNS 200
#define L1WORDS 8096
#define L2WORDS 100000

int main(int argc, char **argv)
{
    int events[NEVENTS] =
        {
            PAPI_TOT_CYC, /* total cycles */
            PAPI_L1_DCM, /* stalls on L1 cache miss */
            PAPI_L2_DCM, /* stalls on L2 cache miss */
        };
    long_long values[NEVENTS];
    PAPI_event_info_t info, info1;
    const PAPI_hw_info_t *hwinfo = NULL;
    int retval, event_code, m, n, i, j, size, arraysize;
    const PAPI_substrate_info_t *s = NULL;
    double *array;

    tests_quiet(argc, argv); /* Set TESTS_QUIET variable */
    retval = PAPI_library_init(PAPI_VER_CURRENT);
    if (retval != PAPI_VER_CURRENT)
        test_fail(__FILE__, __LINE__, "PAPI_library_init", retval);
    {
        int i;
        for (i=0; i<NEVENTS; i++) {
            retval = PAPI_query_event(events[i]) ; PCHECK(retval);
        }
    }

    /* declare an array that is more than twice the L2 cache size */
    arraysize=2*L2WORDS;
    array = (double*) malloc(arraysize*sizeof(double));

    for (size=L1WORDS/4; size<arraysize; size+=L1WORDS/4) {

```

```
printf("Run: data set size=%d\n",size);

/* clear the cache by dragging the whole array through it */
for (n=0; n<arraysize; n++) array[n] = 0.;
/* now load the data in the highest cache level that fits */
for (n=0; n<size; n++) array[n] = 0.;

retval = PAPI_start_counters(events,NEVENTS); PCHECK(retval);
/* run the experiment */
for (i=0; i<NRUNS; i++) {
    for (j=0; j<size; j++) array[j] = 2.3*array[j]+1.2;
}
retval = PAPI_stop_counters(values,NEVENTS); PCHECK(retval);
printf("size=%d\nTot cycles: %d\n",size,values[0]);
printf("cycles per array loc: %9.5f\n",size,values[0]/(1.*NRUNS*size));
printf("L1 misses:\t%d\nfraction of L1 lines missed:\t%9.5f\n",
values[1],values[1]/(size/8.));
printf("L2 misses:\t%d\nfraction of L2 lines missed:\t%9.5f\n",
values[2],values[2]/(size/8.));
printf("\n");
}
free(array);

return 0;
}
```

### 31.3 Cachelines

This code illustrates the need for small strides in vector code. The main loop operates on a vector, progressing by a constant stride. As the stride increases, runtime will increase, since the number of cachelines transferred increases, and the bandwidth is the dominant cost of the computation.

There are some subtleties to this code: in order to prevent accidental reuse of data in cache, the computation is preceded by a loop that accesses at least twice as much data as will fit in cache. As a result, the array is guaranteed not to be in cache.

```
/*
 * File:    line.c
 * Author:  Victor Eijkhout <eijkhout@tacc.utexas.edu>
 *
 * Usage:  line
 */

#include "papi_test.h"
extern int TESTS_QUIET;          /* Declared in test_utils.c */

#define PCHECK(e) \
```

```

    if (e!=PAPI_OK) \
        {printf("Problem in papi call, line %d\n",__LINE__); return 1;}
#define NEVENTS 4
#define MAXN 10000
#define L1WORDS 8096
#define MAXSTRIDE 16

int main(int argc, char **argv)
{
    int events[NEVENTS] =
        {PAPI_L1_DCM, /* stalls on L1 cache miss */
         PAPI_TOT_CYC, /* total cycles */
         PAPI_L1_DCA, /* cache accesses */
         1073872914 /* L1 refills */};
    long_long values[NEVENTS];
    PAPI_event_info_t info, info1;
    const PAPI_hw_info_t *hwinfo = NULL;
    int retval, event_code, m, n, i, j, stride, arraysize;
    const PAPI_substrate_info_t *s = NULL;
    double *array;

    tests_quiet(argc, argv); /* Set TESTS_QUIET variable */
    retval = PAPI_library_init(PAPI_VER_CURRENT);
    if (retval != PAPI_VER_CURRENT)
        test_fail(__FILE__, __LINE__, "PAPI_library_init", retval);
    {
        int i;
        for (i=0; i<NEVENTS; i++) {
            retval = PAPI_query_event(events[i]) ; PCHECK(retval);
        }
    }

    /* declare an array that is more than twice the cache size */
    arraysize=2*L1WORDS*MAXSTRIDE;
    array = (double*) malloc(arraysize*sizeof(double));

    for (stride=1; stride<=MAXSTRIDE; stride++) {
        printf("Run: stride=%d\n", stride);
        /* clear the cache by dragging the whole array through it */
        for (n=0; n<arraysize; n++) array[n] = 0.;

        retval = PAPI_start_counters(events, NEVENTS); PCHECK(retval);
        /* run the experiment */
        for (i=0, n=0; i<L1WORDS; i++, n+=stride) array[n] = 2.3*array[n]+1.2;
        retval = PAPI_stop_counters(values, NEVENTS); PCHECK(retval);
        printf("stride=%d\nTot cycles: %d\n", stride, values[1]);
        printf("L1 misses:\t%d\naccesses per miss:\t%9.5f\n",
            values[0], (1.*L1WORDS)/values[0]);
        printf("L1 refills:\t%d\naccesses per refill:\t%9.5f\n",

```



```

    values[3], (1.*L1WORDS)/values[3]);
    printf("L1 accesses:\t%d\naccesses per operation:\t%9.5f\n",
    values[2], (1.*L1WORDS)/values[2]);
    printf("\n");
}
free(array);

return 0;
}

```

Note that figure 1.17 in section 1.6.4 only plots up to stride 8, while the code computes to 16. In fact, at stride 12 the prefetch behaviour of the Opteron changes, leading to peculiarities in the timing, as shown in figure 31.1.

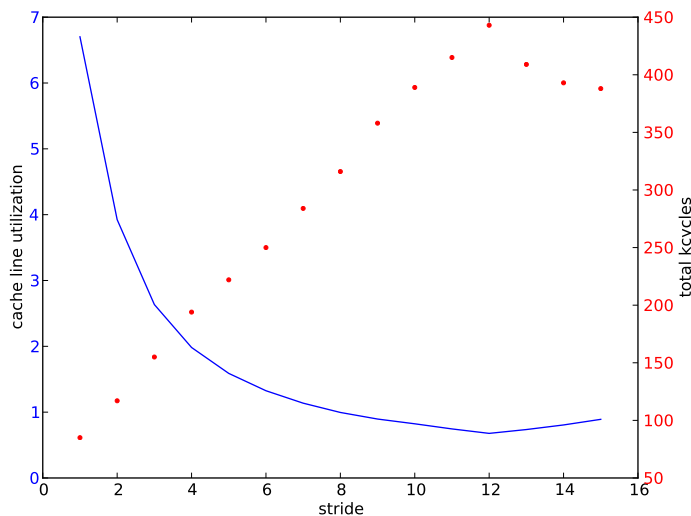

Figure 31.1: Run time in cycles and L1 reuse as a function of stride

### 31.4 Cache associativity

This code illustrates the effects of cache associativity; see sections 1.3.4.9 and 1.6.6 for a detailed explanation. A number of vectors (dependent on the inner loop variable  $i$ ) is traversed simultaneously. Their lengths are chosen to induce cache conflicts. If the number of vectors is low enough, cache associativity will resolve these conflicts; for higher values of  $m$  the runtime will quickly increase. By allocating the vectors with a larger size, the cache conflicts go away.

```

/*
 * File:    assoc.c
 * Author:  Victor Eijkhout <eijkhout@tacc.utexas.edu>

```

```

*
* Usage: assoc m n
*/

#include "papi_test.h"
extern int TESTS_QUIET;          /* Declared in test_utils.c */

#define PCHECK(e) if (e!=PAPI_OK) \
    {printf("Problem in papi call, line %d\n",__LINE__); \
    return 1;}
#define NEVENTS 2
#define MAXN 20000

/* we are assuming array storage in C row mode */
#if defined(SHIFT)
#define INDEX(i,j,m,n) (i)*(n+8)+(j)
#else
#define INDEX(i,j,m,n) (i)*(n)+(j)
#endif

int main(int argc, char **argv)
{
    int events[NEVENTS] = {PAPI_L1_DCM,PAPI_TOT_CYC};
    long_long values[NEVENTS];
    PAPI_event_info_t info, info1;
    const PAPI_hw_info_t *hwinfo = NULL;
    int retval,event_code, m,n, i,j;
    const PAPI_substrate_info_t *s = NULL;
    double *array;

    tests_quiet(argc, argv);      /* Set TESTS_QUIET variable */
    retval = PAPI_library_init(PAPI_VER_CURRENT);
    if (retval != PAPI_VER_CURRENT)
        test_fail(__FILE__, __LINE__, "PAPI_library_init", retval);
    {
        int i;
        for (i=0; i<NEVENTS; i++) {
            retval = PAPI_query_event(events[i]); PCHECK(retval);
        }
    }
    /*
    if (argc<3) {
        printf("Usage: assoc m n\n"); return 1;
    } else {
        m = atoi(argv[1]); n = atoi(argv[2]);
    } printf("m,n = %d,%d\n",m,n);
    */

    #if defined(SHIFT)

```

```

    array = (double*) malloc(13*(MAXN+8)*sizeof(double));
#else
    array = (double*) malloc(13*MAXN*sizeof(double));
#endif

    /* clear the array and bring in cache if possible */
    for (m=1; m<12; m++) {
        for (n=2048; n<MAXN; n=2*n) {
            printf("Run: %d,%d\n",m,n);
#ifdef SHIFT
            printf("shifted\n");
#endif

            for (i=0; i<=m; i++)
                for (j=0; j<n; j++)
                    array[INDEX(i,j,m+1,n)] = 0.;

            /* access the rows in a way to cause cache conflicts */
            retval = PAPI_start_counters(events,NEVENTS); PCHECK(retval);
            for (j=0; j<n; j++)
                for (i=1; i<=m; i++)
                    array[INDEX(0,j,m+1,n)] += array[INDEX(i,j,m+1,n)];
            retval = PAPI_stop_counters(values,NEVENTS); PCHECK(retval);
            printf("m,n=%d,%d\n#elements:\t%d\nTot cycles: %d\n",
m,n,m*n,values[1]);
            printf("L1 misses:\t%d\nmisses per accumulation:\t%.5f\n\n",
values[0],values[0]/(1.*n));

        }
    }
    free(array);

    return 0;
}

```

### 31.5 TLB

This code illustrates the behaviour of a *TLB*; see sections 1.3.8 and 1.6.5 for a thorough explanation. A two-dimensional array is declared in column-major ordering (Fortran style). This means that striding through the data by varying the  $i$  coordinate will have a high likelihood of TLB hits, since all elements on a page are accessed consecutively. The number of TLB entries accessed equals the number of elements divided by the page size. Striding through the array by the  $j$  coordinate will have each next element hitting a new page, so TLB misses will ensue when the number of columns is larger than the number of TLB entries.

```

/*
 * File:      tlb.c
 * Author:    Victor Eijkhout <eijkhout@tacc.utexas.edu>

```

```

*/

#include "papi_test.h"
extern int TESTS_QUIET;          /* Declared in test_utils.c */

#define PCHECK(e) if (e!=PAPI_OK) \
    {printf("Problem in papi call, line %d\n",__LINE__); \
    return 1;}
#define NEVENTS 2
/* we are assuming array storage in Fortran column mode */
#define INDEX(i,j,m,n) i+j*m

double *array;

void clear_right(int m,int n) {
    int i,j;
    for (j=0; j<n; j++)
        for (i=0; i<m; i++)
            array[INDEX(i,j,m,n)] = 0;
    return;
}

void clear_wrong(int m,int n) {
    int i,j;
    for (i=0; i<m; i++)
        for (j=0; j<n; j++)
            array[INDEX(i,j,m,n)] = 0;
    return;
}

void do_operation_right(int m,int n) {
    int i,j;
    for (j=0; j<n; j++)
        for (i=0; i<m; i++)
            array[INDEX(i,j,m,n)] = array[INDEX(i,j,m,n)]+1;
    return;
}

void do_operation_wrong(int m,int n) {
    int i,j;
    for (i=0; i<m; i++)
        for (j=0; j<n; j++)
            array[INDEX(i,j,m,n)] = array[INDEX(i,j,m,n)]+1;
    return;
}

#define COL 1
#define ROW 2
int main(int argc, char **argv)

```

```
{
    int events[NEVENTS] = {PAPI_TLB_DM,PAPI_TOT_CYC};
    long_long values[NEVENTS];
    int retval,order=COL;
    PAPI_event_info_t info, info1;
    const PAPI_hw_info_t *hwinfo = NULL;
    int event_code;
    const PAPI_substrate_info_t *s = NULL;

    tests_quiet(argc, argv);      /* Set TESTS_QUIET variable */
    if (argc==2 && !strcmp(argv[1],"row")) {
        printf("wrong way\n"); order=ROW;
    } else printf("right way\n");

    retval = PAPI_library_init(PAPI_VER_CURRENT);
    if (retval != PAPI_VER_CURRENT)
        test_fail(__FILE__, __LINE__, "PAPI_library_init", retval);

    {
        int i;
        for (i=0; i<NEVENTS; i++) {
            retval = PAPI_query_event(events[i]); PCHECK(retval);
        }
    }

#define M 1000
#define N 2000
    {
        int m,n;
        m = M;
        array = (double*) malloc(M*N*sizeof(double));
        for (n=10; n<N; n+=10) {
            if (order==COL)
clear_right(m,n);
            else
clear_wrong(m,n);
            retval = PAPI_start_counters(events,NEVENTS); PCHECK(retval);
            if (order==COL)
do_operation_right(m,n);
            else
do_operation_wrong(m,n);
            retval = PAPI_stop_counters(values,NEVENTS); PCHECK(retval);
            printf("m,n=%d,%d\n#elements:\t%d\n",m,n,m*n);
            printf("Tot cycles: %d\nTLB misses:\t%d\nmisses per column:\t%9.5f\n\n",
                values[1],values[0],values[0]/(1.*n));
        }
        free(array);
    }
}
```

```
    return 0;
}
```

## 31.6 Unrepresentable numbers

Section 3.2.1 mentioned that many fractions are not representable in binary. This code illustrates that by dividing a number first by 7, then multiplying it by 7 and dividing by 49. Compile and execute this code, and see that an input of 3.5 gives equality, but 3.6 doesn't.

```
#include <stdlib.h>
#include <stdio.h>
int main(){
    double x, div1, div2;
    scanf("%lg", &x);
    div1 = x/7; div2 = (7*x)/49;
    printf("%e %2.17e %2.17e\n", x, div1, div2);
    if (div1==div2) printf("Lucky guess\n");
    else printf("Bad luck\n");
}
```

## Chapter 32

### Bibliography, index, and list of acronyms

#### 32.1 Bibliography

- [1] Alfred V. Aho, Brian W. Kernighan, and Peter J. Weinberger. *The Awk Programming Language*. Addison-Wesley Series in Computer Science. Addison-Wesley Publ., 1988. ISBN 020107981X, 9780201079814.
- [2] G. Amdahl. The validity of the single processor approach to achieving large scale computing capabilities. In *Proceedings of the AFIPS Computing Conference*, volume 30, pages 483–485, 1967.
- [3] O. Axelsson and A.V. Barker. *Finite element solution of boundary value problems. Theory and computation*. Academic Press, Orlando, Fl., 1984.
- [4] Owe Axelsson and Ben Polman. Block preconditioning and domain decomposition methods II. *J. Comp. Appl. Math.*, 24:55–72, 1988.
- [5] Josh Barnes and Piet Hut. A hierarchical  $o(n \log n)$  force-calculation algorithm. *Nature*, 324:446–449, 1986.
- [6] Richard Barrett, Michael Berry, Tony F. Chan, James Demmel, June Donato, Jack Dongarra, Victor Eijkhout, Roldan Pozo, Charles Romine, and Henk van der Vorst. *Templates for the Solution of Linear Systems: Building Blocks for Iterative Methods*. SIAM, Philadelphia PA, 1994. <http://www.netlib.org/templates/>.
- [7] K.E. Batcher. MPP: A high speed image processor. In *Algorithmically Specialized Parallel Computers*. Academic Press, New York, 1985.
- [8] Gordon Bell. The outlook for scalable parallel processing. Decision Resources, Inc, 1994.
- [9] Abraham Berman and Robert J. Plemmons. *Nonnegative Matrices in the Mathematical Sciences*. SIAM, 1994. originally published by Academic Press, 1979, New York.
- [10] Petter E. Bjorstad, William Gropp, and Barry Smith. *Domain decomposition : parallel multilevel methods for elliptic partial differential equations*. Cambridge University Press, 1996.
- [11] Fischer Black and Myron S Scholes. The pricing of options and corporate liabilities. *Journal of Political Economy*, 81(3):637–54, May-June 1973.
- [12] L.S. Blackford, J. Choi, A. Cleary, E. D’Azevedo, J. Demmel, I. Dhillon, J. Dongarra, S. Hammerling, G. Henry, A. Petitet, K. Stanley, D. Walker, and R.C. Whaley. *ScaLAPACK Users’ Guide*. SIAM, 1997.
- [13] Netlib.org BLAS reference implementation. <http://www.netlib.org/blas>.
- [14] Guy E. Blelloch, Michael A. Heroux, and Marco Zagha. Segmented operations for sparse matrix computation on vector multiprocessors. Technical Report CMU-CS-93-173, CMU, 1993.

- 
- [15] Mark Bohr. A 30 year retrospective on Dennard's MOSFET scaling paper. *Solid-State Circuits Newsletter, IEEE*, 12(1):11–13, winter 2007.
- [16] Mark Bohr. The new era of scaling in an soc world. In *ISSCC*, pages 23–28, 2009.
- [17] Jeff Bolz, Ian Farmer, Eitan Grinspun, and Peter Schröder. Sparse matrix solvers on the gpu: conjugate gradients and multigrid. *ACM Trans. Graph.*, 22(3):917–924, July 2003.
- [18] BOOST interval arithmetic library. <http://www.boost.org/libs/numeric/interval/doc/interval.htm>.
- [19] S. Browne, J Dongarra, N. Garner, G. Ho, and P. Mucci. A portable programming interface for performance evaluation on modern processors. *International Journal of High Performance Computing Applications*, 14:189–204, Fall 2000.
- [20] Alfredo Buttari, Victor Eijkhout, Julien Langou, and Salvatore Filippone. Performance optimization and modeling of blocked sparse kernels. *Int. J. High Perf. Comput. Appl.*, 21:467–484, 2007.
- [21] P. M. Campbell, K. D. Devine, J. E. Flaherty, L. G. Gervasio, and J. D. Teresco. Dynamic octree load balancing using space-filling curves, 2003.
- [22] Ernie Chan, Marcel Heimlich, Avi Purkayastha, and Robert van de Geijn. Collective communication: theory, practice, and experience. *Concurrency and Computation: Practice and Experience*, 19:1749–1783, 2007.
- [23] A. P. Chandrakasan, R. Mehra, M. Potkonjak, J. Rabaey, and R. W. Brodersen. Optimizing power using transformations. *IEEE Transaction on Computer Aided Design of Integrated Circuits and Systems*, pages 13–32, January 1995.
- [24] Chapel programming language homepage. <http://chapel.cray.com/>.
- [25] Barbara Chapman, Gabriele Jost, and Ruud van der Pas. *Using OpenMP: Portable Shared Memory Parallel Programming*, volume 10 of *Scientific Computation Series*. MIT Press, ISBN 0262533022, 9780262533027, 2008.
- [26] Yaeyoung Choi, Jack J. Dongarra, Roldan Pozo, and David W. Walker. Scalapack: a scalable linear algebra library for distributed memory concurrent computers. In *Proceedings of the fourth symposium on the frontiers of massively parallel computation (Frontiers '92), McLean, Virginia, Oct 19–21, 1992*, pages 120–127, 1992.
- [27] A. Chronopoulos and C.W. Gear.  $s$ -step iterative methods for symmetric linear systems. *Journal of Computational and Applied Mathematics*, 25:153–168, 1989.
- [28] Barry A. Cipra. An introduction to the ising model. *The American Mathematical Monthly*, pages 937–959, 1987.
- [29] Charles Clos. A study of non-blocking switching networks. *Bell System Technical Journal*, 32:406–242, 1953.
- [30] E. Cuthill and J. McKee. Reducing the bandwidth of sparse symmetric matrices. In *ACM proceedings of the 24th National Conference*, 1969.
- [31] Eduardo F. D'Azevedo, Mark R. Fahey, and Richard T. Mills. Vectorized sparse matrix multiply for compressed row storage format. *Lecture Notes in Computer Science, Computational Science ICCS 2005*, pages 99–106, 2005.
- [32] E.F. D'Azevedo, V.L. Eijkhout, and C.H. Romine. A matrix framework for conjugate gradient methods and some variants of cg with less synchronization overhead. In *Proceedings of the Sixth SIAM Conference on Parallel Processing for Scientific Computing*, pages 644–646, Philadelphia, 1993. SIAM.



- 
- [33] Jeffrey Dean and Sanjay Ghemawat. MapReduce: Simplified data processing on large clusters. In *OSDI'04: Sixth Symposium on Operating System Design and Implementation*, 2004.
- [34] J. Demmel, M. Heath, and H. Van der Vorst. Parallel numerical linear algebra. In *Acta Numerica 1993*. Cambridge University Press, Cambridge, 1993.
- [35] James Demmel, Mark Hoemmen, Marghoob Mohiyuddin, and Katherine Yelick. Avoiding communication in sparse matrix computations. In *IEEE International Parallel and Distributed Processing Symposium*, 2008.
- [36] Jim Demmel, Jack Dongarra, Victor Eijkhout, Erika Fuentes, Antoine Petitet, Rich Vuduc, R. Clint Whaley, and Katherine Yelick. Self adapting linear algebra algorithms and software. *Proceedings of the IEEE*, 93:293–312, February 2005.
- [37] R.H. Dennard, F.H. Gaensslen, V.L. Rideout, E. Bassous, and A.R. LeBlanc. Design of ion-implanted mosfet's with very small physical dimensions. *Solid-State Circuits, IEEE Journal of*, 9(5):256 – 268, oct 1974.
- [38] Ashish Deshpande and Martin Schultz. Efficient parallel programming with linda. In *In Supercomputing '92 Proceedings*, pages 238–244, 1992.
- [39] E. W. Dijkstra. Cooperating sequential processes. <http://www.cs.utexas.edu/users/EWD/transcriptions/EWD01xx/EWD123.html>. Technological University, Eindhoven, The Netherlands, September 1965.
- [40] Edsger W. Dijkstra. Programming as a discipline of mathematical nature. *Am. Math. Monthly*, 81:608–612, 1974.
- [41] Edsger W. Dijkstra. Programming considered as a human activity. published as EWD:EWD117pub, n.d.
- [42] J. Dongarra, A. Geist, R. Manchek, and V. Sunderam. Integrated PVM Framework Supports Heterogeneous Network Computing. *Computers in Physics*, 7(2):166–75, April 1993.
- [43] J. J. Dongarra. *The LINPACK benchmark: An explanation*, volume 297, chapter Supercomputing 1987, pages 456–474. Springer-Verlag, Berlin, 1988.
- [44] Jack J. Dongarra, Jeremy Du Croz, Sven Hammarling, and Iain Duff. A set of level 3 basic linear algebra subprograms. *ACM Transactions on Mathematical Software*, 16(1):1–17, March 1990.
- [45] Jack J. Dongarra, Jeremy Du Croz, Sven Hammarling, and Richard J. Hanson. An extended set of FORTRAN basic linear algebra subprograms. *ACM Transactions on Mathematical Software*, 14(1):1–17, March 1988.
- [46] Dale Dougherty and Arnold Robbins. *sed & awk*. O'Reilly Media, 2nd edition edition. Print ISBN: 978-1-56592-225-9 , ISBN 10:1-56592-225-5; Ebook ISBN: 978-1-4493-8700-6, ISBN 10:1-4493-8700-4.
- [47] Dr. Dobbs. Complex arithmetic: in the intersection of C and C++. <http://www.ddj.com/cpp/184401628>.
- [48] I. S. Duff, R. G. Grimes, and J. G. Lewis. Users' guide for the Harwell-Boeing sparse matrix collection (release I). Technical Report RAL 92-086, Rutherford Appleton Laboratory, 1992.
- [49] C. Edwards, P. Geng, A. Patra, and R. van de Geijn. Parallel matrix distributions: have we been doing it all wrong? Technical Report TR-95-40, Department of Computer Sciences, The University of Texas at Austin, 1995.
- [50] Victor Eijkhout. A general formulation for incomplete blockwise factorizations. *Comm. Appl. Numer. Meth.*, 4:161–164, 1988.

- 
- [51] Victor Eijkhout, Paolo Bientinesi, and Robert van de Geijn. Towards mechanical derivation of Krylov solver libraries. *Procedia Computer Science*, 1(1):1805–1813, 2010. Proceedings of ICCS 2010, <http://www.sciencedirect.com/science/publication?issn=18770509&volume=1&issue=1>.
- [52] Paul Erdős and A. Rnyi. On the evolution of random graphs. *Publications of the Mathematical Institute of the Hungarian Academy of Sciences*, 5:17–61, 1960.
- [53] V. Faber and T. Manteuffel. Necessary and sufficient conditions for the existence of a conjugate gradient method. *SIAM J. Numer. Anal.*, 21:352–362, 1984.
- [54] R.D. Falgout, J.E. Jones, and U.M. Yang. Pursuing scalability for hypre’s conceptual interfaces. Technical Report UCRL-JRNL-205407, Lawrence Livermore National Lab, 2004. submitted to ACM Transactions on Mathematical Software.
- [55] M. Fiedler. A property of eigenvectors of nonnegative symmetric matrices and its applications to graph theory. *Czechoslovak Mathematical Journal*, 25:618–633, 1975.
- [56] D. C. Fisher. Your favorite parallel algorithms might not be as fast as you think. *IEEE Trans. Computers*, 37:211–213, 1988.
- [57] M. Flynn. Some computer organizations and their effectiveness. *IEEE Trans. Comput.*, C-21:948, 1972.
- [58] Project fortress homepage. <http://projectfortress.sun.com/Projects/Community>.
- [59] D. Frenkel and B. Smit. Understanding molecular simulations: From algorithms to applications, 2nd edition. 2002.
- [60] Roland W. Freund and Noël M. Nachtigal. QMR: a quasi-minimal residual method for non-Hermitian linear systems. *Numer. Math.*, 60:315–339, 1991.
- [61] M. Frigo, Charles E. Leiserson, H. Prokop, and S. Ramachandran. Cache oblivious algorithms. In *Proc. 40th Annual Symposium on Foundations of Computer Science*, 1999.
- [62] A. Geist, A. Beguelin, J. Dongarra, W. Jiang, R. Manchek, and V. Sunderam. *PVM: A Users’ Guide and Tutorial for Networked Parallel Computing*. MIT Press, 1994. The book is available electronically, the url is <ftp://www.netlib.org/pvm3/book/pvm-book.ps>.
- [63] David Gelernter. Generative communication in Linda. *ACM Transactions on Programming Languages and Systems*, 7:80–112, 1985.
- [64] David Gelernter and Nicholas Carriero. Coordination languages and their significance. *Commun. ACM*, 35(2):97–107, 1992.
- [65] GNU multiple precision library. <http://gmplib.org/>.
- [66] Stefan Goedecker and Adolfo Hoesie. *Performance Optimization of Numerically Intensive Codes*. SIAM, 2001.
- [67] D. Goldberg. Computer arithmetic. Appendix in [84].
- [68] David Goldberg. What every computer scientist should know about floating-point arithmetic. *Computing Surveys*, March 1991.
- [69] G. H. Golub and D. P. O’Leary. Some history of the conjugate gradient and Lanczos algorithms: 1948-1976. 31:50–102, 1989.
- [70] G. H. Golub and C. F. Van Loan. *Matrix Computations*. North Oxford Academic, Oxford, 1983.
- [71] Gene H. Golub and Charles F. Van Loan. *Matrix Computations*. The Johns Hopkins University Press, Baltimore, second edition edition, 1989.

- 
- [72] Kazushige Goto and Robert A. van de Geijn. Anatomy of high-performance matrix multiplication. *ACM Trans. Math. Softw.*, 34(3):1–25, 2008.
- [73] F. Gray. Pulse code communication. U.S. Patent 2,632,058, March 17, 1953 (filed Nov. 1947).
- [74] Ronald I. Greenberg and Charles E. Leiserson. Randomized routing on fat-trees. In *Advances in Computing Research*, pages 345–374. JAI Press, 1989.
- [75] W. Gropp, E. Lusk, and A. Skjellum. *Using MPI*. The MIT Press, 1994.
- [76] William Gropp, Steven Huss-Lederman, Andrew Lumsdaine, Ewing Lusk, Bill Nitzberg, William Saphir, and Marc Snir. *MPI: The Complete Reference, Volume 2 - The MPI-2 Extensions*. MIT Press, 1998.
- [77] William Gropp, Thomas Sterling, and Ewing Lusk. *Beowulf Cluster Computing with Linux, 2nd Edition*. MIT Press, 2003.
- [78] Hadoop wiki. <http://wiki.apache.org/hadoop/FrontPage>.
- [79] Louis A. Hageman and David M. Young. *Applied Iterative Methods*. Academic Press, New York, 1981.
- [80] A. Hartstein, V. Srinivasan, T. R. Puzak, and P. G. Emma. Cache miss behavior: is it &#8730;2? In *Proceedings of the 3rd conference on Computing frontiers*, CF '06, pages 313–320, New York, NY, USA, 2006. ACM.
- [81] Michael T. Heath. *Scientific Computing: an introductory survey; second edition*. McGraw Hill, 2002.
- [82] Don Heller. A survey of parallel algorithms in numerical linear algebra. *SIAM Review*, 20:740–777, 1978.
- [83] B. A. Hendrickson and D. E. Womble. The torus-wrap mapping for dense matrix calculations on massively parallel computers. *SIAM J. Sci. Comput.*, 15(5):1201–1226, 1994.
- [84] John L. Hennessy and David A. Patterson. *Computer Architecture, A Quantitative Approach*. Morgan Kaufman Publishers, 3rd edition edition, 1990, 3rd edition 2003.
- [85] M.R. Hestenes and E. Stiefel. Methods of conjugate gradients for solving linear systems. *Nat. Bur. Stand. J. Res.*, 49:409–436, 1952.
- [86] Nicholas J. Higham. *Accuracy and Stability of Numerical Algorithms*. Society for Industrial and Applied Mathematics, Philadelphia, PA, USA, second edition, 2002.
- [87] Jonathan. Hill, Bill McColl, Dan C. Stefanescu, Mark W. Goudreau, Kevin Lang, Satish B. Rao, Torsten Suel, Thanasis Tsantilas, and Rob H. Bisseling. BSPlib: The BSP programming library. *Parallel Computing*, 24(14):1947–1980, 1998.
- [88] C. A. R. Hoare. An axiomatic basis for computer programming. *Communications of the ACM*, pages 576–580, October 1969.
- [89] Torsten Hoefler, Christian Siebert, and Andrew Lumsdaine. Scalable communication protocols for dynamic sparse data exchange. *SIGPLAN Not.*, 45(5):159–168, January 2010.
- [90] IEEE 754: Standard for binary floating-point arithmetic. <http://grouper.ieee.org/groups/754>.
- [91] Interval arithmetic. [http://en.wikipedia.org/wiki/Interval\\_\(mathematics\)](http://en.wikipedia.org/wiki/Interval_(mathematics)).
- [92] C.R. Jesshope and R.W. Hockney editors. The DAP approach, volume 2. pages 311–329. Infotech Intl. Ltd., Maidenhead, 1979.
- [93] M. T. Jones and P. E. Plassmann. The efficient parallel iterative solution of large sparse linear

- 
- systems. In A. George, J.R. Gilbert, and J.W.H. Liu, editors, *Graph Theory and Sparse Matrix Computations*, IMA Vol 56. Springer Verlag, Berlin, 1994.
- [94] L. V. Kale and S. Krishnan. Charm++: Parallel programming with message-driven objects. In *Parallel Programming using C++*, G. V. Wilson and P. Lu, editors, pages 175–213. MIT Press, 1996.
- [95] Michael Karbo. PC architecture. <http://www.karbosguide.com/books/pcarchitecture/chapter00.htm>.
- [96] R.M. Karp and Y. Zhang. A randomized parallel branch-and-bound procedure. In *Proceedings of the Twentieth Annual ACM Symposium on Theory of Computing, Chicago, IL, USA, 2-4 May 1988*, pages 290–300. ACM Press, 1988.
- [97] J. Katzenelson. Computational structure of the n-body problem. *SIAM Journal of Scientific and Statistical Computing*, 10:787–815, July 1989.
- [98] Kendall Square Research. [http://en.wikipedia.org/wiki/Kendall\\_Square\\_Research](http://en.wikipedia.org/wiki/Kendall_Square_Research).
- [99] Donald Knuth. *The Art of Computer Programming, Volume 2: Seminumerical algorithms*. Addison-Wesley, Reading MA, 3rd edition edition, 1998.
- [100] Helmut Kopka and Patrick W. Daly. *A Guide to L<sup>A</sup>T<sub>E</sub>X*. Addison-Wesley, first published 1992.
- [101] Ulrich Kulisch. Very fast and exact accumulation of products. *Computing*, 91(4):397–405, April 2011.
- [102] Ulrich Kulisch and Van Snyder. The exact dot product as basic tool for long interval arithmetic. *Computing*, 91(3):307–313, 2011.
- [103] Milind Kulkarni, Martin Burtscher, Rajasekhar Inkulu, Keshav Pingali, and Calin Cascaval. How much parallelism is there in irregular applications? In *Principles and Practices of Parallel Programming (PPoPP)*, 2009.
- [104] Vipin Kumar, Ananth Grama, Anshul Gupta, and George Karypis. *Introduction to Parallel Computing*. Benjamin Cummings, 1994.
- [105] U. Kung, Charalampos E. Tsourakakis, and Christos Faloutsos. Pegasus: A peta-scale graph mining system - implementation and observations. In *Proc. Intl. Conf. Data Mining*, pages 229–238, 2009.
- [106] L. Lamport. *L<sup>A</sup>T<sub>E</sub>X, a Document Preparation System*. Addison-Wesley, 1986.
- [107] C. Lanczos. Solution of systems of linear equations by minimized iterations. *Journal of Research, Nat. Bu. Stand.*, 49:33–53, 1952.
- [108] Rubin H Landau, Manuel José Páez, and Cristian C. Bordeianu. *A Survey of Computational Physics*. Princeton University Press, 2008.
- [109] J. Langou. *Iterative methods for solving linear systems with multiple right-hand sides*. Ph.D. dissertation, INSA Toulouse, June 2003. CERFACS TH/PA/03/24.
- [110] Amy N. Langville and Carl D. Meyer. A survey of eigenvector methods for web information retrieval. *SIAM Review*, 47(1):135–161, 2005.
- [111] C. L. Lawson, R. J. Hanson, D. R. Kincaid, and F. T. Krogh. Basic linear algebra subprograms for fortran usage. *ACM Trans. Math. Softw.*, 5(3):308–323, September 1979.
- [112] P. L’Ecuyer. Combined multiple recursive generators. *Operations Research*, 44, 1996.
- [113] Charles E. Leiserson. Fat-Trees: Universal networks for hardware-efficient supercomputing. *IEEE Trans. Comput*, C-34:892–901, 1985.
- [114] Richard J. Lipton, Donald J. Rose, and Robert Endre Tarjan. Generalized nested dissection. *SIAM J. Numer. Anal.*, 16:346–358, 1979.

- 
- [115] Richard J. Lipton and Robert Endre Tarjan. A separator theorem for planar graphs. *SIAM J. Appl. Math.*, 36:177–189, 1979.
- [116] J.D.C. Little. A proof of the queueing formula  $L = \lambda W$ . *Op. Res.*, pages 383–387, 1961.
- [117] Yongchao Liu, Douglas L. Maskell, and Bertil Schmidt. CUDASW++: optimizing Smith-Waterman sequence database searches for CUDA-enabled graphics processing units. *BMC Res Notes*, 2:73, 2009. PMID- 19416548.
- [118] M. Luby. A simple parallel algorithm for the maximal independent set problem. *SIAM Journal on Computing*, 4, 1986.
- [119] Grzegorz Malewicz, Matthew H. Austern, Aart J.C. Bik, James C. Dehnert, Ilan Horn, Naty Leiser, and Grzegorz Czajkowski. Pregel: a system for large-scale graph processing. In *Proceedings of the 28th ACM symposium on Principles of distributed computing*, PODC '09, pages 6–6, New York, NY, USA, 2009. ACM.
- [120] M. Mascagni and A. Srinivasan. Algorithm 806: Sprng: A scalable library for pseudorandom number generation,. *ACM Transactions on Mathematical Software*, 26:436–461, 2000.
- [121] Robert Mecklenburg. *Managing Projects with GNU Make*. O'Reilly Media, 3rd edition edition, 2004. Print ISBN:978-0-596-00610-5 ISBN 10:0-596-00610-1 Ebook ISBN:978-0-596-10445-0 ISBN 10:0-596-10445-6.
- [122] J.A. Meijerink and H.A. van der Vorst. An iterative solution method for linear systems of which the coefficient matrix is a symmetric M-matrix. *Math Comp*, 31:148–162, 1977.
- [123] N. Metropolis, A. W. Rosenbluth, M. N. Rosenbluth, A. H. Teller, and E. Teller. Equation of state calculations by fast computing machines. *Journal of Chemical Physics*, 21:1087–1092, June 1953.
- [124] Gerard Meurant. Multitasking the conjugate gradient method on the CRAY X-MP/48. *Parallel Computing*, 5:267–280, 1987.
- [125] Gérard Meurant. Domain decomposition methods for partial differential equations on parallel computers. *Int. J. Supercomputing Appls.*, 2:5–12, 1988.
- [126] Frank Mittelbach, Michel Goossens, Johannes Braams, David Carlisle, and Chris Rowley. *The L<sup>A</sup>T<sub>E</sub>X Companion, 2nd edition*. Addison-Wesley, 2004.
- [127] Kenneth Moreland and Ron Oldfield. Formal metrics for large-scale parallel performance. In Julian M. Kunkel and Thomas Ludwig, editors, *High Performance Computing*, volume 9137 of *Lecture Notes in Computer Science*, pages 488–496. Springer International Publishing, 2015.
- [128] Tobi Oetiker. The not so short introductino to L<sup>A</sup>T<sub>E</sub>X. <http://tobi.oetiker.ch/lshort/>.
- [129] National Institute of Standards and Technology. Matrix market. <http://math.nist.gov/MatrixMarket>.
- [130] Andrew T. Ogielski and William Aiello. Sparse matrix computations on parallel processor arrays. *SIAM J. Sci. Stat. Comput.* in press.
- [131] S. Otto, J. Dongarra, S. Hess-Lederman, M. Snir, and D. Walker. *Message Passing Interface: The Complete Reference*. The MIT Press, 1995.
- [132] Michael L. Overton. *Numerical Computing with IEEE Floating Point Arithmetic*. SIAM, Philadelphia PA, 2001.
- [133] Larry Page, Sergey Brin, R. Motwani, and T. Winograd. The pagerank citation ranking: Bringing order to the web, 1998.
- [134] V. Ya. Pan. New combination sof methods for the acceleration of matrix multiplication. *Comp. & Maths. with Appls.*, 7:73–125, 1981.

- 
- [135] Performance application programming interface. <http://icl.cs.utk.edu/papi/>.
- [136] S. Plimpton. Fast parallel algorithms for short-range molecular dynamics. *J. Comput. Phys.*, 117:1–19, 1995.
- [137] Jack Poulson, Bryan Marker, Jeff R. Hammond, and Robert van de Geijn. Elemental: a new framework for distributed memory dense matrix computations. *ACM Transactions on Mathematical Software*. submitted.
- [138] M. Püschel, B. Singer, J. Xiong, J. M. F. Moura, J. Johnson, D. Padua, M. Veloso, and R. W. Johnson. SPIRAL: A generator for platform-adapted libraries of signal processing algorithms. *Int'l Journal of High Performance Computing Applications*, 18(1):21–45, 2004.
- [139] Texas Advanced Computing Center: Sun Constellation Cluster: Ranger. <http://www.tacc.utexas.edu/resources/hpc/constellation>.
- [140] Gururaj S. Rao. Performance analysis of cache memories. *J. ACM*, 25:378–395, July 1978.
- [141] J.K. Reid. On the method of conjugate gradients for the solution of large sparse systems of linear equations. In J.K. Reid, editor, *Large sparse sets of linear equations*, pages 231–254. Academic Press, London, 1971.
- [142] Y. Saad. *Iterative methods for sparse linear systems*. PWS Publishing Company, Boston, 1996.
- [143] Tetsuya Sato. The earth simulator: Roles and impacts. *Nuclear Physics B - Proceedings Supplements*, 129-130:102 – 108, 2004. Lattice 2003.
- [144] David Schade. Canfar: Integrating cyberinfrastructure for astronomy. <https://wiki.bc.net/atl-conf/display/BCNETPUBLIC/CANFAR++Integrating+Cyberinfrastructure+for+Astronomy>.
- [145] R. Schreiber. Scalability of sparse direct solvers. In A. George, J.R. Gilbert, and J.W.-H. Liu, editors, *Sparse Matrix Computations: Graph Theory Issues and Algorithms (An IMA Workshop Volume)*. Springer-Verlag, New York, 1993, 1993. also: Technical Report RIACS TR 92.13, NASA Ames Research Center, Moffet Field, Calif., May 1992.
- [146] D. E. Shaw. A fast, scalable method for the parallel evaluation of distance-limited pairwise particle interactions. *J. Comput. Chem.*, 26:1318–1328, 2005.
- [147] D. B. Skillicorn, Jonathan M. D. Hill, and W. F. McColl. Questions and answers about BSP, 1996.
- [148] Marc Snir, Steve Otto, Steven Huss-Lederman, David Walker, and Jack Dongarra. *MPI: The Complete Reference, Volume 1, The MPI-1 Core*. MIT Press, second edition edition, 1998.
- [149] Dan Spielman. Spectral graph theory, fall 2009. <http://www.cs.yale.edu/homes/spielman/561/>.
- [150] G. W. Stewart. Communication and matrix computations on large message passing systems. *Parallel Computing*, 16:27–40, 1990.
- [151] V. Strassen. Gaussian elimination is not optimal. *Numer. Math.*, 13:354–356, 1969.
- [152] T<sub>E</sub>X frequently asked questions.
- [153] Universal Parallel C at George Washington University. <http://upc.gwu.edu/>.
- [154] Leslie G. Valiant. A bridging model for parallel computation. *Commun. ACM*, 33:103–111, August 1990.
- [155] R. van de Geijn, Philip Alpatov, Greg Baker, Almadena Chtchelkanova, Joe Eaton, Carter Edwards, Murthy Guddati, John Gunnels, Sam Guyer, Ken Klimkowski, Calvin Lin, Greg Morrow, Peter Nagel, James Overfelt, and Michelle Pal. Parallel linear algebra package (PLAPACK): Release r0.1 (beta) users' guide. 1996.

- 
- [156] Robert A. van de Geijn. *Using PLAPACK: Parallel Linear Algebra Package*. The MIT Press, 1997.
- [157] Robert A. van de Geijn and Enrique S. Quintana-Ortí. *The Science of Programming Matrix Computations*. [www.lulu.com](http://www.lulu.com), 2008.
- [158] Henk van der Vorst. Bi-CGSTAB: a fast and smoothly converging variant of Bi-CG for the solution of nonsymmetric linear systems. *SIAM J. Sci. Stat. Comput.*, 13:631–644, 1992.
- [159] Richard S. Varga. *Matrix Iterative Analysis*. Prentice-Hall, Englewood Cliffs, NJ, 1962.
- [160] R. Vuduc, J. Demmel, and K. Yelikk. Oski: A library of automatically tuned sparse matrix kernels. In *(Proceedings of SciDAC 2005, Journal of Physics: Conference Series, to appear., 2005)*.
- [161] Richard W. Vuduc. *Automatic Performance Tuning of Sparse Matrix Kernels*. PhD thesis, University of California Berkeley, 2003.
- [162] R. Clint Whaley, Antoine Petitet, and Jack J. Dongarra. Automated empirical optimization of software and the ATLAS project. *Parallel Computing*, 27(1–2):3–35, 2001. Also available as University of Tennessee LAPACK Working Note #147, UT-CS-00-448, 2000 ([www.netlib.org/lapack/lawns/lawn147.ps](http://www.netlib.org/lapack/lawns/lawn147.ps)).
- [163] O. Widlund. On the use of fast methods for separable finite difference equations for the solution of general elliptic problems. In D.J. Rose and R.A. Willoughby, editors, *Sparse matrices and their applications*, pages 121–134. Plenum Press, New York, 1972.
- [164] J.H. Wilkinson. *Rounding Errors in Algebraic Processes*. Prentice-Hall, Englewood Cliffs, N.J., 1963.
- [165] Samuel Williams, Andrew Waterman, and David Patterson. Roofline: an insightful visual performance model for multicore architectures. *Commun. ACM*, 52:65–76, April 2009.
- [166] Wm. A. Wulf and Sally A. McKee. Hitting the memory wall: implications of the obvious. *SIGARCH Comput. Archit. News*, 23(1):20–24, March 1995.
- [167] L. T. Yand and R. Brent. The improved bicgstab method for large and sparse unsymmetric linear systems on parallel distributed memory architectures. In *Proceedings of the Fifth International Conference on Algorithms and Architectures for Parallel Processing*. IEEE, 2002.
- [168] Randy Yates. Fixed point: an introduction. <http://www.digitalsignallabs.com/fp.pdf>, 2007.
- [169] Andy Yoo, Edmond Chow, Keith Henderson, William McLendon, Bruce Hendrickson, and Umit Catalyurek. A scalable distributed parallel breadth-first search algorithm on BlueGene/L. In *Proceedings of the 2005 ACM/IEEE conference on Supercomputing, SC '05*, pages 25–, Washington, DC, USA, 2005. IEEE Computer Society.
- [170] David M. Young. *Iterative method for solving partial differential equations of elliptic type*. PhD thesis, Harvard Univ., Cambridge, MA, 1950.

## 32.2 List of acronyms

<b>AMR</b> Adaptive Mesh Refinement	<b>ILP</b> Instruction Level Parallelism
<b>AOS</b> Array-Of-Structures	<b>ILU</b> Incomplete LU
<b>API</b> Application Programmer Interface	<b>IVP</b> Initial Value Problem
<b>AVX</b> Advanced Vector Extensions	<b>LAN</b> Local Area Network
<b>BEM</b> Boundary Element Method	<b>LBM</b> Lattice Boltzmann Method
<b>BFS</b> Breadth-First Search	<b>LRU</b> Least Recently Used
<b>BLAS</b> Basic Linear Algebra Subprograms	<b>MIC</b> Many Integrated Cores
<b>BSP</b> Bulk Synchronous Parallel	<b>MIMD</b> Multiple Instruction Multiple Data
<b>BVP</b> Boundary Value Problem	<b>MGS</b> Modified Gram-Schmidt
<b>CAF</b> Co-array Fortran	<b>MPI</b> Message Passing Interface
<b>CCS</b> Compressed Column Storage	<b>MSI</b> Modified-Shared-Invalid
<b>CG</b> Conjugate Gradients	<b>MTA</b> Multi-Threaded Architecture
<b>CGS</b> Classical Gram-Schmidt	<b>NUMA</b> Non-Uniform Memory Access
<b>COO</b> Coordinate Storage	<b>ODE</b> Ordinary Differential Equation
<b>CRS</b> Compressed Row Storage	<b>OS</b> Operating System
<b>DAG</b> Directed Acyclic Graph	<b>PGAS</b> Partitioned Global Address Space
<b>DRAM</b> Dynamic Random-Access Memory	<b>PDE</b> Partial Differential Equation
<b>DSP</b> Digital Signal Processing	<b>PRAM</b> Parallel Random Access Machine
<b>FD</b> Finite Difference	<b>RDMA</b> Remote Direct Memory Access
<b>FMA</b> Fused Multiply-Add	<b>SAN</b> Storage Area Network
<b>FDM</b> Finite Difference Method	<b>SAS</b> Software As a Service
<b>FEM</b> Finite Element Method	<b>SFC</b> Space-Filling Curve
<b>FMM</b> Fast Multipole Method	<b>SIMD</b> Single Instruction Multiple Data
<b>FOM</b> Full Orthogonalization Method	<b>SIMT</b> Single Instruction Multiple Thread
<b>FPU</b> Floating Point Unit	<b>SM</b> Streaming Multiprocessor
<b>FFT</b> Fast Fourier Transform	<b>SMP</b> Symmetric Multi Processing
<b>FSA</b> Finite State Automaton	<b>SOA</b> Structure-Of-Arrays
<b>FSB</b> Front-Side Bus	<b>SOR</b> Successive Over-Relaxation
<b>FPGA</b> Field-Programmable Gate Array	<b>SP</b> Streaming Processor
<b>GMRES</b> Generalized Minimum Residual	<b>SPMD</b> Single Program Multiple Data
<b>GPU</b> Graphics Processing Unit	<b>SPD</b> symmetric positive definite
<b>GPGPU</b> General Purpose Graphics Processing Unit	<b>SRAM</b> Static Random-Access Memory
<b>GS</b> Gram-Schmidt	<b>SSE</b> SIMD Streaming Extensions
<b>HDFS</b> Hadoop File System	<b>TLB</b> Translation Look-aside Buffer
<b>HPC</b> High-Performance Computing	<b>UMA</b> Uniform Memory Access
<b>HPF</b> High Performance Fortran	<b>UPC</b> Unified Parallel C
<b>IBVP</b> Initial Boundary Value Problem	<b>WAN</b> Wide Area Network



## 32.3 Index

- `.bashrc`, see shell, startup files
- `.profile`, see shell, startup files
- 2's complement, 153
  
- $\alpha$ , see latency
- $\beta$ , see bandwidth
- $\gamma$ , see computation rate
  
- active messages, 115
- acyclic graph, 351
- Adaptive Mesh Refinement (AMR), 308
- address space, 81
  - shared, 81
- adjacency
  - matrix, 322
- adjacency graph, 209, 353
- adjacency matrix, 352
- Advanced Vector Extensions (AVX), 79, 137, 328
- affinity, 94–95
- allgather, 237–238, 242, 246
- Alliant FX/8, 37
- allocation
  - static, 500
- allreduce, 237
- AMD, 79, 149
  - Barcelona, 32, 34
  - Opteron, 35, 46, 51, 52
- Amdahl's law, 72–74
- AMR, see Adaptive Mesh Refinement
- analytics
  - graph, 315
- AOS, see Array-Of-Structures
- API, see Application Programmer Interface
- Apple
  - iCloud, 145
- archive utility, 390
- arithmetic
  - computer, see floating point arithmetic
  - finite precision, 152
  - intensity, 39
- array processors, 78, 133
- array syntax, 109
  
- Array-Of-Structures (AOS), 117
- assembly
  - inline, 33
  - language, 24
- assertion, 451
- assertions, 450–452
- associative, see also cache, associative
- associativity
  - of mathematical operations, 163
- asynchronous communication, 119
- atomic operation, 37, 91–93
- atomicity, see atomic operation
- automaton, 359–360
  - linear bounded, 360
- autotuning, 56
- AVX, see Advanced Vector Extensions
- axpy, 40
  
- background process, 378
- backwards stability, 167
- banded matrix, 182
  - storage, 205–206
- bandwidth, 22, 131, 136, 235
  - aggregate, 121
  - measure in GT/s, 134
  - of a matrix, see halfbandwidth
  - of a matrix, 205
- bandwidth bound algorithm, 149
- bandwidth-bound, 41, 261
- Barnes-Hut algorithm, 326–327
- barrier, 116
- base, 155
- bash, 367
- Basic Linear Algebra Subprograms (BLAS), 440
- BBN
  - Butterfly, 126
- BEM, see Boundary Element Method
- benchmarking, 28, 40
- BFS, see Breadth-First Search
- bidirectional exchange, 238
- big-endian, 420, 427
- binary-coded-decimal, 156

- bisection bandwidth, 121  
 bisection width, 121  
 BitBucket, 408  
 bitonic sequence, 312  
 Bitonic sort, 309  
 bitonic sort, 75, 312–313  
   sequential complexity of, 313  
 bits, 152  
 Bjam, 392  
 Black-Scholes model, 331  
 BLAS, see Basic Linear Algebra Subprograms  
   data format, 442–443  
 blis, 444  
 block Jacobi, 263–264, 279  
 block matrix, 184, 252, 272  
 block tridiagonal, 184, 215, 275  
 blocking communication, 99, 106  
 blocking for cache reuse, 49  
 Boundary Element Method (BEM), 256  
 Boundary Value Problem (BVP), 179–186  
 branch misprediction, 21  
 branch penalty, 21  
 breakpoint, 465, 466–467  
 Brent’s theorem, 70, 139  
 broadcast, 102, 235–236  
 BSP, see Bulk Synchronous Parallel  
 bubble sort, 309  
 bucket brigade algorithm, 236  
 buffering, 240  
 bug, 450  
 Bulk Synchronous Parallel (BSP), 116  
 bus, 21  
   memory, 122  
   speed, 23  
   width, 23  
 butterfly exchange, 126  
 BVP, see Boundary Value Problem  
 by reference, 476  
 bytes, 152
- C  
   array layout, 473–474  
   language standard, 168  
 C++  
   language standard, 168  
   linking to, 472–473  
   name mangling, 472
- cache, 20, 21, 25–32  
   associative, 31  
   block, 28  
   blocking, 49, 54, 203  
   coherence, 27, 36–39, 46, 83, 122, 286  
   hierarchy, 26, 57  
   hit, 26  
   hot, 500  
   line, 28–29, 43  
   mapping, 29  
   miss, 26, 33  
   miss, capacity, 27  
   miss, compulsory, 27  
   miss, conflict, 27  
   miss, invalidation, 27  
   oblivious programming, 57–58  
   replacement policies, 28  
   shared, 82  
   warming, 500
- cacheline  
   boundary alignment, 29, 500  
   invalidation, 37
- CAF, see Co-array Fortran  
 Cannon’s algorithm, see matrix-matrix product,  
   Cannon’s algorithm  
 capability computing, 146  
 capacity computing, 146  
 cartesian mesh, 122  
 cartesian product, 115  
 cat, 368  
 Cayley-Hamilton theorem, 225  
 ccNUMA, 83  
 CCS, see Compressed Column Storage  
 cd, 370  
 CDC  
   Cyber205, 80  
 Cell processor, 133  
 CG, see Conjugate Gradients  
 CGS, see Classical Gram-Schmidt  
 channel rate, 131

- channel width, 131
- Chapel, 110, 113
- characteristic polynomial, 225
- Charm++, 115
- checkerboard ordering, 184
- Cheeger's
  - constant, 357
  - inequality, 357
- chess, 86
- chgrp, 373
- chmod, 372
- Cholesky factorization, 198, 284
- Chomsky hierarchy, 360
- Cilk Plus, 96
- cleanup code, 48
- clique, 353
- clock speed, 19
- Clos network, 129
- cloud computing, 143–146
  - service models, 145
- cluster
  - node, see node
- clusters, 79, 80
  - Beowulf, 80
- Co-array Fortran (CAF), 112
- co-processor, 133–134, 151
- coherence
  - cache, 109
- collective communication, 102, 105, 235–238
- collective operation, 103, 131, 235–238
  - long vector, 236
  - short vector, 236
- colour number, 274, 352
- colouring, 273
- column-major, 61, 443, 473
- communication
  - blocking, 105
  - overhead, 72
  - overlapping computation with, 118, 283
- compare-and-swap, 309, 313
- compiler, 56, 85, 111
  - directives, 96, 112
  - flags, 169
  - optimization, 24
    - vs round-off, 168–169
  - optimization levels, 159
  - parallelizing, 87
- complexity, 344
  - computational, 202–203, 344
  - of iterative methods, 233
  - space, 212–214, 344
- Compressed Column Storage (CCS), 208
- Compressed Row Storage (CRS), 207–209, 256
- Compressed Row Storage (CRS)
  - performance of the matrix-vector product, 261
- computation rate, 131, 235
- compute-bound, 41, 148
- concurrency, 95
- condition number, 167, 338
- conditionally stable, 176
- congestion, 121
- Conjugate Gradients (CG), 232, 283
- Connection Machine, 78, 150
- contention, 121
- context, 91
  - switch, 91, 132, 136
- control flow, 12, 20, 77, 285
- conveniently parallel, 86
- COO, see Coordinate Storage
- coordinate storage, 208
- coordination language, 114
- core, 36, 14–36
  - vs processor, 36
- core dump, 458
- correct rounding, 161
- Courant-Friedrichs-Lewy condition, 179
- CPU-bound, see compute-bound
- cpu-bound, 14
- Cramer's rule, 192
- Crank-Nicolson method, 190
- Cray, 252
  - Cray-1, 80
  - Cray-2, 80
  - T3E, 107
  - X/MP, 80
  - XE6, 83

- XMT, 91, 133
- Y/MP, 80
- Cray Inc., 133
- Cray Research, 133
- critical path, 70, 286
- critical section, 92
- crossbar, 82, 126
- CRS, *see* Compressed Row Storage
- csh, 367
- CUDA, 78, 134, 135, 151
- cut, 375
- Cuthill-McKee ordering, 215–216, 277
- cycle (in graph), 351
- cyclic distribution, 250
- Cywin, 367
  
- DAG, *see* Directed Acyclic Graph
- data decomposition, 239
- data flow, 12, 20, 77, 285
- data parallel, 132, 135, 137
- data parallelism, 67, 134
- data race, *see* race condition
- data reuse, 21, 39
- ddd, 458
- DDT, 458, 468
- deadlock, 96, 101, 106, 467
- debug flag, 459
- debugger, 458
- debugging, 458–469
  - in parallel, 467–469
- DEC
  - Alpha, 17, 80
- defensive programming, 450
- degree, 120, 350
- Delauney mesh refinement, 85
- Dennard scaling, 61
- denormal, *see* floating point numbers, unnormalized
- Dense linear algebra, 238–251
- dependency, 19
- dgemm, 59
- diagonal dominance, 201
- diagonal storage, 205–207, 253
- diameter, 120, 351
- die, 14, 26
  
- difference stencil, 185
- differential operator, 180
- Dijkstra’s shortest path algorithm, 319
- direct mapping, 30
- direct methods
  - for linear systems, 261
- Directed Acyclic Graph (DAG), 285, 351
- directives, *see* compiler, directives
- directories, 367
- Dirichlet boundary condition, 179, 181
- discretization, 175
- distributed computing, 143–146
- divide-and-conquer, 57
- domain decomposition, 266
- double precision, 136
- DRAM, *see* Dynamic Random-Access Memory
- DSP, *see* Digital Signal Processing
- dynamic programming, 317
- Dynamic Random-Access Memory (DRAM), 25
  
- Earth Simulator, 149
- ebook, 145
- edges, 350
- efficiency, 68
- eigenvector
  - dominant, 341
- Eispack, 440
- Elliptic PDEs, 180
- embarrassingly parallel, 68, 86
- embedding, 122
- environment variable, 376, 379–381
- Eratosthenes
  - sieve of, 313
- escape, 374, 385
- ETA-10, 80
- Euler
  - explicit, 174–176
  - implicit, 176–178
- evicted, 38
- excess, 155
- executable, 367
- exponent, 155
- export, 380
- extended precision, 162, 169, 170

- Facebook, 315
- factorization, see LU factorization
- false sharing, 39, 99, 109
- Fast Fourier Transform (FFT), 51
- Fast Multipole Method (FMM), 327
- fast solvers, 222
- fat tree, 126–129
  - bisection width of a, 128
  - clusters based on, 129
- fault tolerance, 147
- FD, see Finite Difference
- FDM, see Finite Difference Method
- FEM, see Finite Element Method
- fenv.h, 160
- FFT, see Fast Fourier Transform
- Fiedler vector, 357
- Fiedler’s theorem, 357
- field scaling, 61
- files, 367
- fill locations, 212
- fill-in, 211–216, 275
  - estimates, 212–214
  - reduction, 214–216
- finger, 385
- finite difference, 175
- Finite Difference Method (FDM), 181
- Finite Element Method (FEM), 186, 260
- Finite State Automaton (FSA), 38, 359–360
- finite volume method, 186
- first-touch policy, 95
- floating point
  - unit, 15–16
- floating point arithmetic
  - associativity of, 167, 361
- floating point arithmetic, 152–171
- floating point numbers
  - normalized, 157
  - representation, 155–156
  - unnormalized, 157
- floating point pipeline, 47
- flops, 19
- Floyd-Warshall algorithm, 317–319
  - parallelization of the, 323
- flushed, 28
- flushing
  - pipeline, 93
- Flynn’s taxonomy, 77
- FMA, see Fused Multiply-Add
- FMM, see Fast Multipole Method
- FOM, see Full Orthogonalization Method
- foreground process, 378
- fork-join, 88, 89
- Fortran, 443
  - array layout, 473–474
  - declarations in, 169
  - iso C bindings, 471
  - language standard, 168
- Fortress, 113–114
- FPGA, see Field-Programmable Gate Array
- FPU, see Floating Point Unit
- Front-Side Bus (FSB), 21
- FSA, see Finite State Automaton
- FSB, see Front-Side Bus
- Full Orthogonalization Method (FOM), 228
- fully associative, 31
- fully connected, 120
- functional parallelism, 67
- functional programming, 146–148
- Fused Multiply-Add (FMA), 15, 162, 170
- gather, 102, 167, 237
- Gauss-Seidel, 220
- GCC, 97
- gdb, 458–467
- General Purpose Graphics Processing Unit (GPGPU), 134
- Generalized Minimum Residual (GMRES), 233
- ghost region, 114, 254, 281, 282, 334
- Global Arrays, 115
- GMRES, see Generalized Minimum Residual
- GNU, 458
  - gdb, see gdb
  - gnuplot, see gnuplot
  - Make, see Make
- gnuplot, 447
- Goodyear
  - MPP, 78

- Google, 117, 256, 320  
 code, 408  
 Google Docs, 144, 145
- Goto  
 Kazushige, 59
- GPGPU, *see* General Purpose Graphics Processing Unit
- GPU, *see* Graphics Processing Unit
- Gram-Schmidt, 228, 338–340  
 modified, 228, 339
- granularity, 87, 91
- Grape computer, 133, 327
- graph  
 adjacency, 215, *see* adjacency graph  
 colouring, 264, 274, 352  
 directed, 350  
 Laplacian, 140, 356  
 random, 320  
 social, 315  
 theory, 350–358  
   of parallel computers, 120  
 undirected, 120, 210, 350
- Graphics Processing Unit (GPU), 80, 134–137, 150, 160, 257, 277
- Gray code, 125
- grep, 373
- grid (CUDA), 135
- grid computing, 143
- groups, 373
- GS, *see* Gram-Schmidt
- guard digit, 161, 163
- Gustafson’s law, 73
- Hadoop, 147
- Hadoop File System (HDFS), 147
- halfbandwidth, 213  
 left, 206  
 right, 206
- halo, *see* ghost region
- handshake protocol, 109
- hardware prefetch, 33
- Harwell-Boeing matrix format, 208
- HDFS, *see* Hadoop File System
- heap, 88
- heat equation, 179, 186
- Hessenberg matrix, 227
- heterogeneous computing, 151
- hg, *see* mercurial
- High Performance Fortran (HPF), 109, 112
- High-Performance Computing (HPC), 114, 143
- HITS, 321–322
- Horner’s rule, 280, 323
- host process, 133
- host processor, 151
- Householder reflectors, 343  
 in LU factorization, 197
- HPC, *see* High-Performance Computing
- HPF, *see* High Performance Fortran
- hybrid computing, 108–109
- hyper-threading, 89
- Hyperbolic PDEs, 179
- hypercube, 124
- hyperthreading, 35, 91, 96
- hypervisor, 83
- I/O subsystem, 20
- IBM, 114, 120, 155–157, 427  
 BlueGene, 83, 130, 150  
 BlueGene Q, 33  
 Power 5, 17  
 Power series, 80  
 Power6, 156  
 Roadrunner, 63, 133
- IBVP, *see* Initial Boundary Value Problem
- ICL  
 DAP, 78, 133
- idle, 138
- idle time, 106
- ILP, *see* Instruction Level Parallelism
- ILU, *see* Incomplete LU
- imbalance  
 load, 116
- incidence matrix, 321
- Incomplete LU (ILU), 222
- Incomplete LU (ILU)  
 parallel, 264–265
- independent sets, 352
- indirect addressing, 208

- Inf, 156
- Initial Boundary Value Problem (IBVP), 186–190
- Initial Boundary Value Problems (IBVP), 179
- Initial Value Problem (IVP), 172–178
- inner products, 259–260
- input redirection, *see* redirection
- instruction
  - handling
    - in-order, 15
    - out-of-order, 15
  - issue, 79
  - pipeline, 21
- Instruction Level Parallelism (ILP), 14, 20, 62, 85
- Intel, 20, 35, 36, 79, 149
  - 80287 co-processor, 170
  - Haswell, 17
  - i860, 80, 133
  - Itanium, 24, 149
  - MIC, 151
  - Paragon, 133
  - Sandy Bridge, 14, 17, 26
  - Woodcrest, 32
  - Xeon Phi, 15, 78, 91, 96, 109, 134, 137
    - bandwidth, 134
- inter-node communication, 108
- interior nodes, 352
- interoperability
  - C to Fortran, 470–476
- interrupt, 157
- intra-node communication, 108
- irreducible, 354, *see* reducible
- Ising model, 333–334
- ispc, 118
- iterative methods, 216–233
  - floating point performance of, 261
- iterative refinement, 221
- IVP, *see* Initial Value Problem
- Jacobi method, 219
- kernel
  - CUDA, 135
- Krylov methods, 216–233
- ksh, 367
- LAN, *see* Local Area Network
- language
  - context-free, 360
  - context-sensitive, 360
  - recursively enumerable, 360
  - regular, 360
- language interoperability, *see* interoperability
- Lapack, 148, 440
  - routines, 441–442
- Laplace equation, 345, 357
- latency, 22, 130, 235
  - hiding, 23, 39
- latency hiding, 118
- L<sup>A</sup>T<sub>E</sub>X, *see also* T<sub>E</sub>X, 477–490
- Lattice Boltzmann Methods (LBM), 160
- LBM, *see* Lattice Boltzmann Method
- leaf nodes, 352
- level sets, 215
- lexicographic ordering, 183, 184, 265
- libraries
  - creating and using, 390–391
  - numerical, 430–446, *see* Lapack, *see* PETSc
- Linda, 114
- linear algebra, 337–343
  - software
    - dense, 440–446
    - sparse, 430–440
- linear array (of processors), 122
- linker, 390
- LINPACK
  - benchmark, 40
- Linpack, 148, 440
  - benchmark, 46, 148, 440
- Linux
  - distributions, 367
  - kernel, 83
- Lisp, 148
- Little’s law, 33
- little-endian, 420, 427
- load
  - balancing, 138–142
  - balancing, dynamic, 139
  - balancing, static, 139

- rebalancing, 140, 141, 328
- redistributing, 140, 141
- unbalance, 68, 80, 87, 98, 138
- Local Area Network (LAN), 143
- local solve, 263
- locality, 14
  - core, 46
  - in parallel computing, 131–132
  - spatial, 41, 43
  - temporal, 41
- lock, 90, 92
- loop unrolling, 47, 59, 168
- LRU, *see* Least Recently Used
- ls, 368
- LU factorization, 196–204
  - computation in parallel, 249–250
  - solution in parallel, 248–249
- M-matrix, 182, 223
- machine epsilon, *see* machine precision
- machine precision, 158
- Make, 392–405
  - and L<sup>A</sup>T<sub>E</sub>X, 404–405
  - automatic variables, 397
  - debugging, 403
  - template rules, 398
- malloc, 88
- Mandelbrot set, 86, 139
- mantissa, 155–159, 162, 163
- manycore, 135
- MapReduce, 146–148
- Markov
  - chains, 355
  - matrix, 356
- MasPar, 78
- master-worker paradigm, 85
- matrix
  - adjacency, 316, *see* adjacency matrix
  - nonnegative, 321
  - norms, 338
    - associated, 338
  - permutation, 353
  - reducible, 322
  - stochastic, 322
  - storage, dense, 249–250
  - storage, sparse, 205–209
  - strictly upper triangular, 279
  - structurally symmetric, 140, 210, 258
  - tessellation, 252
  - transposition, 57
  - unit upper triangular, 279
- Matrix Market, 208
  - matrix format, 208
- matrix-matrix product, 59, 250
  - Cannon’s algorithm for, 251
  - Goto implementation, 59–61, 444
  - reuse in, 40
- matrix-vector product, 58
  - sparse, *see* sparse, matrix-vector product
- memory
  - access pattern, 27
  - banks, 34
  - distributed, 81
  - distributed shared, 83
  - hierarchy, 21
  - leak, 434, 455
  - model, 93
  - pages, 34
  - shared, 81
  - stall, 22
  - violations, 454
  - virtual shared, 83
  - wall, 21, 498
- memory model
  - relaxed, 93
- memory-bound, 14
- mercurial, 415–419
- Message Passing Interface (MPI), 102–108
- Metropolis algorithm, 334
- MGS, *see* Modified Gram-Schmidt
- MIC, *see* Many Integrated Cores
- MIMD, *see* Multiple Instruction Multiple Data
- minimum
  - spanning tree, 235, 319
- minimum degree ordering, 216
- MIPS, 80
- mkdir, 370



- MKL, 137, 440, 444
- modified Gram-Schmidt, see Gram-Schmidt, modified
- Moore's law, 61
- MPI, see Message Passing Interface
  - MPI 3.0 draft, 105
- MSI, see Modified-Shared-Invalid
- MTA, see Multi-Threaded Architecture
- multi-colouring, 274
- Multi-Threaded Architecture (MTA), 132
- multi-threading, 96, 132
- multicore, 21, 27, 35–39, 62, 82, 203, 284
  - motivated by power, 62
- multigrid, 227
- Multiple Instruction Multiple Data (MIMD), 80
- MUMPS, 497
  
- $n_{1/2}$ , 17
- N-body problems, 325–329
- NaN, 156
- natural ordering, 184
- NBODY6, 327
- nearest neighbour, 123
- nested dissection, 215, 265–272, 320
- netlib, 443
- Neumann boundary condition, 181
- Newton method, 223
- nm, 390, 470
- node, 108, 123
- nodes, 350
- non-blocking communication, 102, 105, 106, 119
- non-local operation, 106
- Non-Uniform Memory Access (NUMA), 82, 132
- norm, 337
- NP-complete, 146
- null termination, 475
- NUMA, see Non-Uniform Memory Access
- NVidia, 134
  - Tesla, 160
  
- object file, 390, 470
- octtree, 327
  - hashed, 328
- odd-even transposition sort, 309, 309
  
- ODE, see Ordinary Differential Equation
- offloading, 137
- one-sided communication, 107–108, 114–116
- OpenMP, 96–99
  - version 4, 80
- Operating System (OS), 95, 367
- option pricing, 331
- order, 344
- Ordinary Differential Equation (ODE), 172–178
- OS, see Operating System
- out-of-order, see instruction, handling, out-of-order
- output redirection, see redirection
- overdecomposition, 87, 116, 139, 249
- overflow, 154, 156, 450
- overflow bit, 154
- overlays, 34
- owner computes, 138
  
- page table, 35
- PageRank, 256, 320, 322–323
- pages
  - memory, see memory, pages
- Parabolic PDEs, 179
- parallel fraction, 72
- parallel prefix, see prefix operation
- Parallel Random Access Machine (PRAM), 71
- parallelism
  - average, 69
  - data, 78, 84, 111
  - dynamic, 97
  - fine-grained, 84
  - instruction-level, 64
  - irregular, 86
- parallelization
  - incremental, 97
- parameter sweep, 86
- partial derivatives, 345
- Partial Differential Equation (PDE), 179–190
- partial differential equations, 345–346
- partial ordering, 285
- partial pivoting, 195
- Partitioned Global Address Space (PGAS), 83, 109–115
- path (graph theory), 351

- patsubst, 399  
 PCI bus, 134  
 PCI-X, 137  
 PCI-X bus, 136  
 PDE, *see* Partial Differential Equation  
 peak performance, 19, 40, 41, 46  
 penta-diagonal, 184  
 permutation, 215  
 Perron vector, 321, 323  
 Perron-Frobenius theorem, 342  
 PETSc, 430–440  
 PGAS, *see* Partitioned Global Address Space  
 pipeline, 16–19, 46–48
  - depth, 21, 62
  - flush, 21
  - length, 21
  - processor, 79
  - stall, 21
- pivoting, 193–195, 200–201
  - diagonal, 195
  - full, 195
  - partial, 195
- pivots, 193  
 PLapack, 440  
 point-to-point communication, 102  
 Poisson equation, 180, 345  
 posix\_memalign, 500  
 power
  - consumption, 61–63
  - efficiency, 78
  - wall, 62
- power method, 321, 322, 340  
 PowerPC, 79  
 PRAM, *see* Parallel Random Access Machine  
 precision
  - double, *see* double precision
  - extended, *see* extended precision
  - machine, *see* machine precision
  - of the intermediate result, 162, 168
  - single, *see* single precision
- preconditioner, 221–223  
 predicate, 316  
 prefetch data stream, 32  
 prefix operation, 279, 311, 361–363  
 prefix operations
  - sparse matrix vector product, 362–363
- Pregel, 117  
 Prim’s algorithm, 319  
 prime number
  - finding, 313–314
- priority queue, 320  
 probability vector, 322  
 process, 88
  - affinity, *see* affinity
- program counter, 13, 88, 96  
 protein interactions, 315  
 ps, 378  
 pseudo-random numbers, *see* random numbers  
 pthreads, 89–91  
 purify, 463  
 PVM, 107  
 QR factorization, 339  
 Quicksort, 308, 310–312  
 race condition, 92, 93  
 radix point, 155  
 random numbers, 332–333
  - generator, 332–333
  - lagged Fibonacci, 332
  - linear congruential, 332
- random placement, 116, 140  
 rate
  - computational, 76
- RDMA, *see* Remote Direct Memory Access  
 re-association, 168  
 real numbers
  - representation of, 152
- recursive doubling, 19, 29, 275, 277–279  
 Red Hat, 367  
 red-black ordering, 184, 272–274  
 redirection, 375, 377  
 reduce-scatter, 238, 245, 246, 258  
 reducible, 210  
 reduction, 236–237
  - and thread safety, 92
  - under multi-threading, 92

- reduction operations, 98
- redundancy, 121
- redundant computation, 282
- refinement
  - adaptive, 141
- region of influence, 179
- register, 13, 21, 23–25
  - file, 23
  - resident in, 24, 25
  - spill, 24, 48
  - variable, 25
  - vector, 79, 79
- Remote Direct Memory Access (RDMA), 107
- remote method invocation, 115
- remote procedure call, 143
- repository, 406
- representation error
  - absolute, 158
  - relative, 158
- reproducibility, 168
  - bitwise, 168
- residual, 217
- resource contention, 95
- revision control systems, *see* source code control
- Riemann sums, 331
- ring network, 122
- roofline model, 41
- round-off error analysis, 161–167
  - in parallel computing, 167
- round-robin
  - storage assignment, 111
  - task scheduling, 98
- rounding, 157
  - correct, 159
- row-major, 443, 473
  
- SAN, *see* Storage Area Network
- SAS, *see* Software As a Service
- satisfiability, 67
- scalability, 74–77
  - strong, 74, 243
  - weak, 74, 243
- Scalapack, 148, 440
- ScaleMP, 83
  
- scaling, 74–77
- scheduling
  - dynamic, 87, 98
  - fair-share, 146
  - job, 146
  - static, 98
- Scons, 392
- search direction, 229, 233
- sed, 375
- segmentation fault, 461
- segmentation violation, 454
- semaphore, 92
- separable problem, 222
- separator, 265, 320
- Sequent Symmetry, 37
- sequential complexity, 309
- sequential consistency, 93, 96, 285
- sequential fraction, 72
- serialized execution, 100
- SFC, *see* Space-Filling Curve
- SGE, 146
- SGI, 133
  - UV, 83
- sh, 367
- shared libraries, 390
- shell, 367
  - command history, 404
  - startup files, 384–385
- shortest path
  - all-pairs, 315
  - single source, 315
- side effects, 148
- side-effects, 451
- sign bit, 153, 155
- significant, 155
- significant digits, 163
- SIMD, *see* Single Instruction Multiple Data
  - lanes, 79
  - width, 41, 118
- SIMD Streaming Extensions (SSE), 79, 133, 328
- SIMT, *see* Single Instruction Multiple Thread
- Single Instruction Multiple Data (SIMD), 118
- Single Instruction Multiple Thread (SIMT), 135

- single precision, 136
- Single Program Multiple Data (SPMD), 80, 118
- skyline storage, 213
- Slurm, 146
- SM, see Streaming Multiprocessor
- small world, 321
- smoothers, 227
- SMP, see Symmetric Multi Processing
- snooping, 38, 122
- SOA, see Structure-Of-Arrays
- socket, 27, 36, 108, 150
- Software As a Service (SAS), 144
- SOR, see Successive Over-Relaxation
- sorting, 308–313
  - network, 309, 313
- source code control, 406
  - distributed, 406, 407, 415
- source-to-source transformations, 48
- SP, see Streaming Processor
- space-filling curve, 138, 140–142
- spanning tree, 319
- Spark, 147
- sparse
  - linear algebra, 204–216
  - matrix, 182, 205, 353
    - from PDEs, 183
  - matrix-vector product
    - implementation, 208
    - in graph theory, 315
    - locality in, 209
    - parallel, 253–258
    - parallel setup, 258
    - performance of, 261
- spatial locality, see locality, spatial
- SPD, see symmetric positive definite
- speculative execution, 21
- speedup, 68, 80
- SPMD, see Single Program Multiple Data
- SRAM, see Static Random-Access Memory
- SSE, see SIMD Streaming Extensions
- stall, 33
- static libraries, 390
- Static Random-Access Memory (SRAM), 25
- stationary iteration, 218
- statistical mechanics, 334
- steady state, 177, 179, 180, 187, 346, 496
- stochastic matrix, 356
- Storage Area Network (SAN), 143
- storage by diagonals, 205
- stride, 28, 43, 50
- strip mining, 59
- structurally symmetric, 353
- Structure-Of-Arrays (SOA), 117
- subdomain, 266
- substructuring, 266
- Subversion, 406, 408–414
- Successive Over-Relaxation (SOR), 221
- Sun
  - Ray, 144
- superlinear speedup, 68
- superscalar, 14, 20, 85
- superstep, 66
- supersteps, 108, 116
- surface-to-volume, 87
- svn, see Subversion
- swapped, 34
- switch, 126
  - leaf, 128, 132
- symbol table, 459
- Symmetric Multi Processing (SMP), 81, 122
- symmetric positive definite (SPD), 201, 227, 232, 233
- TACC, 128
  - ranger cluster, 129
  - Stampede cluster, 129, 134
- task
  - parallelism, 85–86
  - queue, 86, 95, 317
- task parallelism, 67
- Taylor series, 174, 347–349
- tcsh, 367
- temporal locality, see locality, temporal
- Tera Computer
  - MTA, 133
- ternary arithmetic, 156
- TeX, 477

- environment variables, 484
- thin client, 144
- thread, 88–96, 136
  - affinity, *see* affinity
  - blocks, 135
  - master, 88
  - private data, 91
  - safe, 92, 97
  - shared data, 91
  - spawning, 88
  - team, 88
  - use in OpenMP, 97
- throughput computing, 134
- Tianhe-1A, 134
- Tianhe-2, 134
- Titanium, 112
- TLB, *see* Translation Look-aside Buffer
  - miss, 35
- top, 386
- top 500, 148–150
- topology, 119
- torus, 123
  - clusters based on, 130
- TotalView, 458
- touch, 370
- transactional memory, 93
- Translation Look-aside Buffer (TLB), 35, 506
- tree graph, 352
- tridiagonal, 184
- tridiagonal matrix, 182
- truncation, 157
- truncation error, 175, 181
- tuple space, 114
- Turing machine, 360
  
- Ubuntu, 367
- UMA, *see* Uniform Memory Access
- unconditionally stable, 177
- underflow, 156
  - gradual, 156, 157, 169
  
- Unified Parallel C (UPC), 110–112
- Uniform Memory Access (UMA), 81, 122, 126
- unitary basis transformations, 215
- Unix
  - user account, 385
- unsigned, 153
- UPC, *see* Unified Parallel C
- uptime, 386
- utility computing, 143
  
- valgrind, 463–464
- value safety, 168
- vector
  - instructions, 79, 277
  - norms, 337
  - pipeline, *see* pipeline, processor
  - register, *see* register, vector
- vector processor, 79, 277
- verbatim mode, 482
- version control systems, *see* source code control
- vertices, 350
- Virtual memory, 34
- virtualization, 143
- von Neumann architectures, 12
  
- WAN, *see* Wide Area Network
- wavefront, 276–277
- weak scaling, 72
- weighted graph, 351
- which, 369, 376
- who, 385
- whoami, 385
- Wide Area Network (WAN), 143
- wildcard, 373, 399
- work pool, 139
- World Wide Web, 315
  
- X10, 114
- x86, 149, 150
- zsh, 367

