



HAL
open science

Traffic Distributions and Independence II: Universal Constructions for Traffic Spaces

Guillaume Cébron, Antoine Dahlqvist, Camille Male

► **To cite this version:**

Guillaume Cébron, Antoine Dahlqvist, Camille Male. Traffic Distributions and Independence II: Universal Constructions for Traffic Spaces. 2016. hal-01249890v2

HAL Id: hal-01249890

<https://hal.science/hal-01249890v2>

Preprint submitted on 5 Dec 2019

HAL is a multi-disciplinary open access archive for the deposit and dissemination of scientific research documents, whether they are published or not. The documents may come from teaching and research institutions in France or abroad, or from public or private research centers.

L'archive ouverte pluridisciplinaire **HAL**, est destinée au dépôt et à la diffusion de documents scientifiques de niveau recherche, publiés ou non, émanant des établissements d'enseignement et de recherche français ou étrangers, des laboratoires publics ou privés.

Traffic Distributions and Independence II: Universal Constructions for Traffic Spaces

Guillaume Cébron*, Antoine Dahlqvist†, Camille Male‡

ABSTRACT:

We investigate questions related to the notion of *traffics* introduced by the third author as a non-commutative probability space with additional operations and equipped with the notion of *traffic independence*. We prove that any sequence of unitarily invariant random matrices that converges in non-commutative distribution converges as well in traffic distribution whenever it fulfils some factorisation property. We provide an explicit description of the limit which allows to recover and extend some applications (a result by Mingo and Popa on the asymptotic freeness from the transposed ensembles, and of Accardi, Lenczewski and Salapata on the freeness of infinite transitive graphs). We also improve the theory of traffic spaces by considering a positivity axiom related to the notion of *state* in non-commutative probability. We construct the free product of traffic spaces and prove that it preserves the positivity condition. This analysis leads to our main result stating that every non-commutative probability space endowed with a tracial state can be enlarged and equipped with a structure of traffic space.

Contents

1	Introduction	3
1.1	Presentation of the results	3
1.1.1	Motivations for traffics	3
1.1.2	Limiting traffic distribution of large unitarily invariant random matrices	4
1.1.3	Non-commutative probability spaces and traffic spaces	5
1.1.4	Independence and positivity	6
1.1.5	Three canonical models of traffics	7
1.2	Definitions	8
1.2.1	Algebras over an operad	8
1.2.2	Algebraic traffic spaces	11

*Institut de Mathématiques de Toulouse; UMR5219; Université de Toulouse; CNRS; UPS, F-31062 Toulouse, FRANCE. Partially supported by the ERC advanced grant “Non-commutative distributions in free probability”, held by Roland Speicher.

†University of Sussex. Supported in part by RTG 1845 and EPSRC grant EP/I03372X/1.

‡Université de Bordeaux UMR 5251 and CNRS. Partially supported by the Fondation Sciences Mathématiques de Paris, the University Paris Descartes UMR 8145. The three authors have been partially supported by the INSMI-CNRS through a PEPS JCJC grant.

1.2.3	Möbius inversion and injective trace	13
1.2.4	Traffic independence	14
I	General traffic spaces	16
2	A natural characterization of traffic independence	17
2.1	Statement	17
2.2	Proof of Theorem 2.8	21
2.2.1	A decomposition of graph polynomials	21
2.2.2	Solidity, validity and primitivity	23
2.2.3	End of the proof	28
3	Products of traffic spaces	29
3.1	The free product of algebraic traffic spaces	29
3.2	Definition of positivity and traffic spaces	31
3.3	Positivity of the free product	33
3.4	The tensor product of traffic spaces	39
4	Conclusion of Part I and perspectives	40
4.1	Operadic aspects: bigraph operations and wiring diagrams	41
4.2	Definition of traffics of arbitrary ranks and their independence	42
4.3	Potential perspectives	43
II	On the three types of traffics associated to non-commutative independences	44
5	Generalities on unitarily invariant traffics	45
5.1	Cacti and non crossing partitions	45
5.2	Unitarily invariant traffics	46
5.3	Relation with freeness and large random matrices	48
5.3.1	Abstract statement	48
5.3.2	Asymptotic freeness of random matrices	50
6	Equivalence between unitary invariance and cactus type	52
6.1	On the geometry of cacti	52
6.2	Proof of the equivalence	54
7	Asymptotically unitarily invariant random matrices	55
7.1	Applications	55
7.2	The Weingarten function.	57
7.3	Free cumulants and the Möbius function μ	57
7.4	Asymptotics of the Weingarten function.	58
8	Canonical construction of spaces of free type	61
8.1	Free \mathcal{G} -algebra generated by an algebra	61
8.2	Algebraic construction	62
8.3	Positivity	64

9	Three types of traffics	67
9.1	Boolean type	68
9.2	Tensor type	69
9.3	Canonical traffic spaces	69
9.4	Relations between the traffics of different types, conclusion	70

1 Introduction

1.1 Presentation of the results

1.1.1 Motivations for traffics

Thanks to the fundamental work of Voiculescu [31], it is now understood that free probability is a good framework for the study of large random matrices. Here are two important considerations which sum up the role of non-commutative probability in the description of the macroscopic behavior of large random matrices:

1. A large class of families of random matrices $\mathbf{A}_N \in M_N(\mathbb{C})$ converge in non-commutative distribution as N tends to ∞ (in the sense that the normalized trace of any polynomial in the matrices converges).
2. If two independent families of random matrices \mathbf{A}_N and \mathbf{B}_N converge separately in non-commutative distribution and are invariant in law when conjugating by a unitary matrix, then the joint non-commutative distribution of the family $\mathbf{A}_N \cup \mathbf{B}_N$ converges as well. The joint limit can be described from the separate limits thanks to the relation of *free independence* introduced by Voiculescu.

In [16, 17, 18], it was pointed out that there are cases where other important macroscopic convergences occur in the study of large random matrices and graphs. One example is the adjacency matrix of the so-called sparse Erdős-Reényi graph: it is the symmetric real random matrix X_N whose sub-diagonal entries are independent and distributed according to Bernoulli random variable with parameter $\frac{p}{N}$, where p is fixed. Let Y_N be a deterministic matrix bounded in operator norm. Then the possible limiting *-distributions of (X_N, Y_N) depend on more than the limiting *-distribution of Y_N [17].

The notion of non-commutative probability is too restrictive and should be generalized to get more information about the limit in large dimension. This is precisely the motivation to introduce the concept of *traffic space*, which comes together with its own notions of distribution and independence: a traffic space is a non-commutative probability space where one can consider not only the usual operations of algebras, but also more general n -ary operations called *graph operations*. We will introduce those concept in detail, but let us first describe the role of traffics enlightened in [16] for the description of large N asymptotics of random matrices:

1. A large class of families of random matrices $\mathbf{A}_N \in M_N(\mathbb{C})$ converge in traffic distribution as N tends to ∞ (in the sense that the normalized trace of any graph operation in the matrices converges).
2. If two independent families of random matrices \mathbf{A}_N and \mathbf{B}_N converge separately in traffic distribution, satisfy a factorization property and are invariant in law when conjugating by a permutation matrix, then the joint traffic distribution of the family $\mathbf{A}_N \cup \mathbf{B}_N$ converges as well. Moreover, the joint limit can be described from the separate limits thanks to the relation of *traffic independence* introduced in [16].

As a sequel of [16], the purpose of this monograph is to develop the theory of traffics and provide more examples.

1.1.2 Limiting traffic distribution of large unitarily invariant random matrices

For concreteness, we first describe how we encode new operations on matrix spaces and state one example of matrices that are considered in this monograph.

For all $K \geq 0$, a K -graph operation is a connected graph g with K oriented and ordered edges, and two distinguished vertices (one input and one output, not necessarily distinct). The set \mathcal{G} of graph operations is the set of all K -graph operations for all $K \geq 0$. A K -graph operation g has to be thought as an operation that accepts K objects and produces a new one.

For example, it acts on the space $M_N(\mathbb{C})$ of N by N complex matrices as follows. For each K -graph operation $g \in \mathcal{G}$, we define a linear map $Z_g : M_N(\mathbb{C}) \otimes \cdots \otimes M_N(\mathbb{C}) \rightarrow M_N(\mathbb{C})$ in the following way. Denoting by

- V the vertex set of g ,
- $(v_1, w_1), \dots, (v_K, w_K)$ the ordered edges of g ,
- in and out the distinguished vertices of g ,
- $E_{k,l}$ the matrix unit $(\delta_{ik}\delta_{jl})_{i,j=1}^N \in M_N(\mathbb{C})$,

we set, for all $A_1, \dots, A_K \in M_N(\mathbb{C})$,

$$Z_g(A_1 \otimes \cdots \otimes A_K) = \sum_{\phi: V \rightarrow \{1, \dots, N\}} \left(\prod_{k=1}^K A_k(\phi(w_k), \phi(v_k)) \right) \cdot E_{\phi(out), \phi(in)}.$$

Those operations appear quite naturally in investigations of random matrices, see for instance [3, Appendix A.4] and [21]. Following [21], we can think of the linear map $\mathbb{C}^N \rightarrow \mathbb{C}^N$ associated to $Z_g(A^{(1)} \otimes \cdots \otimes A^{(K)})$ as an algorithm, where we feed a vector into the input vertex and then operate it through the graph, each edge doing some calculation thanks to the corresponding matrix $A^{(i)}$, and each vertex acting like a logic gate, doing some compatibility checks. This description relies only on the so-called *commutative special \dagger -Frobenius comonoid structure* of matrix spaces [6].

The linear maps Z_g encode naturally the product of matrices, but also other natural operations, like the Hadamard (entry-wise) product $(A, B) \mapsto A \circ B$, the real transpose $A \mapsto A^t$ or the degree matrix $deg(A) = diag(\sum_{j=1}^N A_{i,j})_{i=1, \dots, N}$.

Starting from a family $\mathbf{A} = (A_j)_{j \in J}$ of random matrices of size $N \times N$, the smallest algebra close by adjunction and by the action of the K -graph operations is the *traffic space* generated by \mathbf{A}_N . The *traffic distribution* of \mathbf{A}_N is the data of the non-commutative distribution of the matrices which are in the traffic space generated by \mathbf{A}_N . More concretely, it is the collection of the quantities

$$\frac{1}{N} \mathbb{E} \left[\text{Tr} \left(Z_g \left(A_{j_1}^{\epsilon_1} \otimes \cdots \otimes A_{j_K}^{\epsilon_K} \right) \right) \right]$$

for all K -graph operations $g \in \mathcal{G}$, indices $j_1, \dots, j_K \in J$ and labels $\epsilon_1, \dots, \epsilon_K \in \{1, *\}$.

In this monograph, we prove the following theorem. It shows that for a general class of unitarily invariant matrices, the convergence of the $*$ -distribution is sufficient to deduce the convergence in traffic distribution.

Theorem 1.1. For all $N \geq 1$, let $\mathbf{A}_N = (A_j)_{j \in J}$ be a family of random matrices in $M_N(\mathbb{C})$. We assume

1. The unitary invariance: for all $N \geq 1$ and all $U \in M_N(\mathbb{C})$ which is unitary, $U\mathbf{A}_N U^* := (UA_j U^*)_{j \in J}$ and \mathbf{A}_N have the same law.
2. The convergence in $*$ -distribution of \mathbf{A}_N : for all indices $j_1, \dots, j_K \in J$ and labels $\epsilon_1, \dots, \epsilon_K \in \{1, *\}$, the quantity $(1/N)\mathbb{E}[\text{Tr}(A_{j_1}^{\epsilon_1} \dots A_{j_K}^{\epsilon_K})]$ converges.
3. The factorization property: for all $*$ -monomials m_1, \dots, m_k , we have the following convergence

$$\begin{aligned} \lim_{N \rightarrow \infty} \mathbb{E} \left[\frac{1}{N} \text{Tr}(m_1(\mathbf{A}_N)) \dots \frac{1}{N} \text{Tr}(m_k(\mathbf{A}_N)) \right] \\ = \lim_{N \rightarrow \infty} \mathbb{E} \left[\frac{1}{N} \text{Tr}(m_1(\mathbf{A}_N)) \right] \dots \lim_{N \rightarrow \infty} \mathbb{E} \left[\frac{1}{N} \text{Tr}(m_k(\mathbf{A}_N)) \right]. \end{aligned}$$

Then, \mathbf{A}_N converges in traffic distribution: for all K -graph operation $g \in \mathcal{G}$, indices $j_1, \dots, j_K \in J$ and labels $\epsilon_1, \dots, \epsilon_K \in \{1, *\}$, the following quantity converges

$$\frac{1}{N} \mathbb{E} \left[\text{Tr}(Z_g(A_{j_1}^{\epsilon_1} \otimes \dots \otimes A_{j_K}^{\epsilon_K})) \right].$$

The limit of the traffic distribution of \mathbf{A}_N is unitarily invariant and depends explicitly on the limit of the non-commutative $*$ -distribution of \mathbf{A}_N .

Note that the convergence is about macroscopic quantities build from the matrices. However, it contains more information than the convergence in $*$ -moments.

For example, a recent result of Mingo and Popa [20] tells that for all sequence of unitarily invariant random matrices \mathbf{A}_N the family \mathbf{A}_N^t of the transposes of \mathbf{A}_N has the same non-commutative $*$ -distribution as \mathbf{A}_N and is asymptotically freeness with \mathbf{A}_N (under assumptions stronger than those of Theorem 1.1 that also imply the asymptotic free independence of second order). Thanks to the description of the limiting traffic distribution of unitarily invariant matrices, we will get that for a family $\mathbf{A}_N = (A_j)_{j \in J}$ as in Theorem 1.1, \mathbf{A}_N , \mathbf{A}_N^t and $\text{deg}(\mathbf{A}_N)$ are asymptotically free independent.

It has to be noticed that a result similar to Theorem 1.1, about the convergence of the permutation invariant observables on random matrices, is also proved independently by Gabriel in [11]. More generally, up to some conventions the framework developed in [10, 11, 9] is equivalent to the framework of traffics. Interestingly, it develops aspects that are not yet considered for traffics, such as the central notion of cumulants.

1.1.3 Non-commutative probability spaces and traffic spaces

We now leave the example of random matrices and introduce the abstract notion of traffic spaces. The purpose is to define a structure for the limit of large matrices that captures the limiting traffic distribution, in a similar way the model of non-commutative random variables captures the limiting joint distribution of large matrices in the theory of free probability.

Let us start by recalling the setting of non-commutative probability. A non-commutative probability space is a pair (\mathcal{A}, Φ) , where \mathcal{A} is an algebra and Φ is linear form. One often assumes that \mathcal{A} is unital and $\Phi(1_{\mathcal{A}}) = 1$, and that Φ is a trace,

that is $\Phi(ab) = \Phi(ba)$ for any $a, b \in \mathcal{A}$. A $*$ -probability space is a unital non-commutative probability space equipped with an anti-linear involution \cdot^* satisfying $(ab)^* = b^*a^*$ and such that Φ is positive, that is $\Phi(a^*a) \geq 0$ for any $a \in \mathcal{A}$. The distribution of a family \mathbf{a} of elements of a non-commutative probability space is the linear form $\Phi_{\mathbf{a}} : P \mapsto \Phi(P(\mathbf{a}))$ defined for non-commutative polynomials in elements of \mathbf{a} . On $*$ -probability spaces, the $*$ -distribution is defined by the same formula for non-commutative polynomials in the elements and their adjoints. The convergence in ($*$ -)distribution of a sequence \mathbf{a}_N is the pointwise convergence of $\Phi_{\mathbf{a}_N}$.

An algebraic traffic space is equivalent to the data of a non-commutative probability space (\mathcal{A}, Φ) and of a collection of K -linear maps from \mathcal{A}^K to \mathcal{A} indexed by the K -graph operations satisfying mild assumptions. More precisely, to each K -graph operation $g \in \mathcal{G}$ there is a linear map

$$Z_g : \underbrace{\mathcal{A} \otimes \cdots \otimes \mathcal{A}}_{K \text{ times}} \rightarrow \mathcal{A}$$

subject to some requirements of compatibility. Namely, it should be a so-called operad algebra over the set of graph operations (Definition 1.7). The traffic distribution of a family $\mathbf{a} = (a_j)_{j \in J} \in \mathcal{A}^J$ is equivalent to the collection of the quantities $\Phi[Z_g(a_{\gamma(1)} \otimes \cdots \otimes a_{\gamma(K)})]$ for any K graph operation g and for any map $\gamma : \{1, \dots, K\} \rightarrow J$. Actually, the definition of the traffic spaces will be given as pairs (\mathcal{A}, τ) , where τ is a combinatorial function that is equivalent to the data of Φ , although it is more intrinsic.

Finally, a *traffic* (an element of \mathcal{A}) is a non-commutative random variable, albeit coming with more information, as the action of graph operations permits to consider additional operations: the Hadamard product, the transpose, the degree... natural operations on matrices. As an example, let us highlight that if a matrix A_N converges in traffic distribution to $a \in \mathcal{A}$, the joint non-commutative distribution of $A_N, A_N \circ A_N, A_N^t, \deg(A_N), \dots$ converges to the distribution of $a, a \circ a, a^t, \deg(a), \dots$ in (\mathcal{A}, Φ) .

1.1.4 Independence and positivity

In non-commutative probability theory, it is possible to consider three different products of noncommutative probability spaces, each one corresponding to a particular notion of independence: the tensor independence, the free independence and the Boolean independence. Moreover, these products are the only existing ones in a certain sense (see [26, 12]). Interestingly, all three products preserve the positivity of the linear form.

One important contribution of the present paper is the definition of the free product of traffic spaces which yields to the appropriate notion of independence for traffics defined in [16]. More precisely, in Section 3.1, for any collection $\mathcal{A}_j, j \in J$ of algebraic traffic spaces (with traces Φ_j), we define their free product $*_{j \in J} \mathcal{A}_j$, in such a way that the algebras \mathcal{A}_j seen as traffic subspaces of $*_{j \in J} \mathcal{A}_j$ are traffic independent with respect to the canonical trace.

It has to be noted that the positivity of the traces Φ_j on the spaces \mathcal{A}_j is not sufficient to ensure the positivity of the resulting trace on $*_{j \in J} \mathcal{A}_j$. One has to require more positivity conditions on Φ_j to get positivity at the end. This is one motivation to define the good notion of positivity for traffic spaces. In Definition 1.11 of Section 1.2, we define a *traffic space* as an algebraic traffic space \mathcal{A} with trace Φ with two additional properties: the compatibility of the involution \cdot^* with graph operations, and a positivity condition on Φ which is stronger than assuming that Φ is a state. The main point is to prove the compatibility between traffic independence and the notion of positivity, stated in the following theorem.

Theorem 1.2. *The free product of traffic spaces preserves the positivity of traffic spaces, so that the free product of traffic spaces is well-defined as a traffic space.*

In particular, for any traffic a , there exists a traffic space that contains a sequence of traffic independent variables distributed as a . Moreover, a traffic space can always be enlarged in order to introduce traffic independent random variables.

Interestingly, the proof of Theorem 1.2 requires a new characterization of traffic independence (contained in Theorem 2.8) which is much more similar to the usual definition of free independence (the trace of an alternated product of centered elements is centered) than the original one. We deduce from it a simple criterion to characterize the free independence of variables assuming their traffic independence. An example of application is a new proof of the free independence of the spectral distributions of the free product of infinite deterministic graphs [1]. Part I of the monograph starts by presenting this aspect.

1.1.5 Three canonical models of traffics

We turn now to our last result, which was the first motivation of this monograph and whose demonstration uses both Theorem 1.1 and Theorem 1.2. It states that there exist three different ways of enlarging a $*$ -probability space into a traffic space, each one related to respectively the tensor, the free and the Boolean independence. Let us be more explicit, starting with the model related to freeness. As explained, Theorem 1.1 in its full form gives a formula for the limiting traffic distribution of large unitary invariant random matrices which involves only the limiting non-commutative distribution. Replacing in this formula the limiting non-commutative distribution of matrices by an arbitrary distribution, we obtain a traffic distribution which is related to free independence as the following result highlights.

Theorem 1.3. *Let (\mathcal{A}, Φ) be a tracial $*$ -probability space. There exists a traffic space \mathcal{B} such that :*

1. $\mathcal{A} \subset \mathcal{B}$ as $*$ -algebras and the trace induced by \mathcal{B} on \mathcal{A} is Φ ;
2. two families \mathbf{a} and $\mathbf{b} \in \mathcal{A} \subset \mathcal{B}$ are freely independent in \mathcal{A} if and only if they are traffic independent in \mathcal{B} .

The formula for the traffic distribution given, the difficulty consists in proving that this distribution satisfies the positivity condition.

Remark that, as described in [16] and recalled in Section 9, an Abelian non-commutative probability space can be endowed with a structure of traffic space.

Theorem 1.4. *Let (\mathcal{A}, Φ) be a Abelian $*$ -probability space. There exists a traffic space \mathcal{B} such that :*

1. $\mathcal{A} \subset \mathcal{B}$ as $*$ -algebras and the trace induced by \mathcal{B} on \mathcal{A} is Φ ;
2. two families \mathbf{a} and $\mathbf{b} \in \mathcal{A} \subset \mathcal{B}$ are tensor independent in \mathcal{A} if and only if they are traffic independent in \mathcal{B} .

Finally, thanks to Section 9.1, one can produce an analogue construction for Boolean independence. We recall that any traffic space is endowed with two linear forms: a trace and a second linear form called the *anti-trace*.

Theorem 1.5. *Let (\mathcal{A}, Ψ) be a $*$ -probability space. There exists a traffic space \mathcal{B} such that :*

1. $\mathcal{A} \subset \mathcal{B}$ as $*$ -algebras and the anti-trace induced by \mathcal{B} on \mathcal{A} is Ψ ;
2. two families \mathbf{a} and $\mathbf{b} \in \mathcal{A} \subset \mathcal{B}$ are Boolean independent in \mathcal{A} if and only if they are traffic independent in \mathcal{B} .

This construction comes together with a large model for asymptotically Boolean independent random matrices.

In other words, the free product of traffic space leads to the tensor product, Boolean product or the free product of the probability spaces, depending on the way the $*$ -distribution and the traffic distribution of our random variables are linked. It corresponds to three different types of traffic that we will define in Section 9 : the traffics of free, tensor, or Boolean types. Interestingly, we also see that the last notions of monotone and anti-monotone independence (see [22, 23]) appear to describe the relations between traffics of different types when they are traffic independent. We sum up the non-commutative independences which follows from traffic independence in Figure 1.

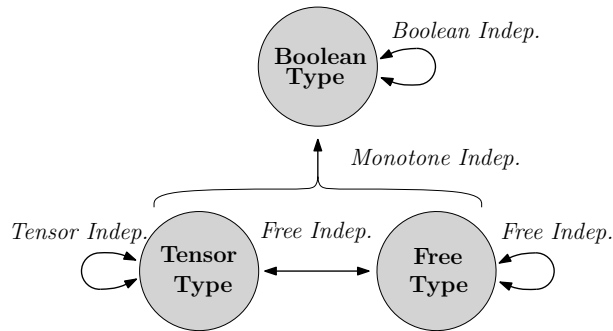

Figure 1: The non-commutative independences of traffics of free, tensor, and Boolean types which are traffic independent

Organization of the monograph: In the rest of this introduction, we first recall the definitions of algebraic traffic spaces and traffic independence. Part I is dedicated to general facts on traffics. In Section 2 we introduce an equivalent definition of traffic independence. In Section 3 we define the free product of traffic spaces and prove Theorem 1.2. Part II is devoted to particular types of traffics, starting with the so-called unitarily invariant traffics that are introduced and described in Section 5 and 6. Theorem 1.1 on unitarily invariant matrices is proved in Section 7. In Section 8, we prove Theorem 1.3 on the canonical extension of $*$ -probability spaces via traffics of free type. In Section 9, we investigate the canonical extensions of tensor and Boolean type, and prove Theorems 1.4 and 1.5.

1.2 Definitions

This section provides basic definitions from [16, Chapter 4] in the theory of traffic spaces.

1.2.1 Algebras over an operad

We first make more precise the definition of graph operations given in the introduction.

Definition 1.6. For all $K \geq 0$, a K -graph operation is a finite, connected and oriented graph with K ordered edges, and two particular vertices (one input and one output). The set of K -graph operations is denoted by \mathcal{G}_K , and we define $\mathcal{G} = \bigcup_{K \geq 0} \mathcal{G}_K$.

A K -graph operation can produce a new graph operation from K different graph operations thanks to the following *composition maps*

$$\begin{aligned} \mathcal{G}_K \times \mathcal{G}_{L_1} \times \cdots \times \mathcal{G}_{L_K} &\rightarrow \mathcal{G}_{L_1 + \cdots + L_K} \\ (g, g_1, \dots, g_K) &\mapsto g(g_1, \dots, g_K), \end{aligned}$$

for $K \geq 1$ and $L_i \geq 0$, $i = 1, \dots, K$ which consist in replacing the i -th edge of $g \in \mathcal{G}_K$ by the L_i -graph operation g_i (leading at the end to a $(L_1 + \cdots + L_K)$ -graph operation). Let also consider the *action of the symmetric group*

$$\begin{aligned} S_K \times \mathcal{G}_K &\rightarrow \mathcal{G}_K \\ (\sigma, g) &\mapsto g^{(\sigma)}, \end{aligned}$$

for $K \geq 2$ which consists in reordering the edges of g according to σ : if e_1, \dots, e_K are the ordered edges of g , $e_{\sigma^{-1}(1)}, \dots, e_{\sigma^{-1}(K)}$ are the ordered edges in $g^{(\sigma)}$. Finally, let us denote by *id* the graph operation which consists in two vertices and one edge from the input to the output. Endowed with those composition maps and the action of the symmetric groups, the set \mathcal{G} is a *symmetric operad*, in the sense that it satisfies

1. the *identity* property $g(id, \dots, id) = g = id(g)$,
2. the *associativity* property

$$\begin{aligned} g(g_1(g_{1,1}, \dots, g_{1,k_1}), \dots, g_K(g_{K,1}, \dots, g_{K,k_K})) \\ = (g(g_1, \dots, g_K))(g_{1,1}, \dots, g_{1,k_1}, \dots, g_{K,1}, \dots, g_{K,k_K}), \end{aligned}$$

3. the *equivariance* properties $g^{(\sigma)}(g_{\sigma^{-1}(1)}, \dots, g_{\sigma^{-1}(K)}) = g(g_1, \dots, g_K)$; and $g(g_1^{(\sigma_1)}, \dots, g_K^{(\sigma_K)}) = (g(g_1, \dots, g_K))^{(\sigma_1 \times \dots \times \sigma_K)}$.

The element $id \in \mathcal{G}_1$ is called the *identity* of the operad.

Let us now define how a K -graph operation can produce a new element from K elements of a vector space in a linear way.

Definition 1.7. An action of an operad $\mathcal{G} = \bigcup_{K \geq 0} \mathcal{G}_K$ on a vector space \mathcal{A} is the data, for all $K \geq 0$ and $g \in \mathcal{G}_K$, of a linear map $Z_g : \mathcal{A}^{\otimes K} \rightarrow \mathcal{A}$ such that: $\forall g \in \mathcal{G}_K, g_i \in \mathcal{G}, a_i \in \mathcal{A}, \sigma \in S_K$,

1. Z_{id} is the identity on \mathcal{A} , where $id \in \mathcal{G}_1$ is the identity of the operad,
2. $Z_g(Z_{g_1} \otimes \dots \otimes Z_{g_K}) = Z_{g(g_1, \dots, g_K)}$,
3. $Z_g(a_1 \otimes \dots \otimes a_K) = Z_{g_\sigma}(a_{\sigma^{-1}(1)} \otimes \dots \otimes a_{\sigma^{-1}(K)})$.

A vector space on which acts \mathcal{G} is called a \mathcal{G} -algebra. A \mathcal{G} -subalgebra is a vector subspace of a \mathcal{G} -algebra stable by the action of \mathcal{G} . A \mathcal{G} -morphism between two \mathcal{G} -algebras \mathcal{A} and \mathcal{B} is a linear map $f : \mathcal{A} \rightarrow \mathcal{B}$ such that $f(Z_g(a_1, \dots, a_K)) = Z_g(f(a_1), \dots, f(a_K))$ for any K -graph operation g and $a_1, \dots, a_K \in \mathcal{A}$.

In the following, \mathcal{G} always denotes the operad of graph operations. We now review some linear maps Z_g of particular interest by describing the underlying graphs g . At each time, we shall represent g graphically, forgetting the mention of the ordering of edges when it is not relevant, and assuming the input is the rightmost vertex of the graph and the output the leftmost one when they are not equal.

- The only element of \mathcal{G}_0 is the graph (\cdot) with a single vertex and no edge. By convention, the map $Z_{(\cdot)}$ is a linear map $\mathbb{C} \rightarrow \mathcal{A}$. It is then characterized by the image of $1 \in \mathbb{C}$ that is denoted by $\mathbb{1} := Z_{(\cdot)}(1)$ and is called the unit of \mathcal{A} .
- By definition, $Z_{\leftarrow} = id_{\mathcal{A}}$. The graph $(\cdot \rightarrow \cdot) \in \mathcal{G}_1$, which consists in two vertices and one edge from the output to the input, induces another involution on \mathcal{A} which will be denoted by $a \mapsto a^t := Z_{\rightarrow}(a)$. We call a^t the transpose of a .
- The graph operation $(\cdot \xleftarrow{1} \cdot \xrightarrow{2} \cdot)$, which consists in three vertices and two successive edges from the input to the output, induces a bilinear map $(a, b) \in \mathcal{A}^2 \mapsto ab := Z_{\xrightarrow{1,2}}(a \otimes b) \in \mathcal{A}$ which gives to \mathcal{A} a structure of associative algebra over \mathbb{C} , with unit $\mathbb{1}$. Hence, every \mathcal{G} -algebra is in particular a unital algebra.
- The Hadamard product is the bilinear map $(a, b) \in \mathcal{A}^2 \mapsto a \circ b := Z_{\leftarrow\leftarrow}(a \otimes b)$, where the graph operation consists in two vertices and two edges from the input to the output. It defines an associative and commutative product.
- The diagonal of an element $a \in \mathcal{A}$ is defined by $\Delta(a) := Z_{\circlearrowleft}(a)$, for the graph \circlearrowleft with one vertex and one edge (which is a self loop). The space $\Delta(\mathcal{A}) := \{\Delta(a), a \in \mathcal{A}\}$ is a commutative \mathcal{G} -subalgebra of \mathcal{A} .
- The degree of an element $a \in \mathcal{A}$ is defined by $deg(a) := Z_{\downarrow}(a)$, for the graph \downarrow with two vertices, where one is both the input and the output, and an edge from the second vertex to the input/output. The map deg is a projection with image $\Delta(\mathcal{A})$.

Example 1.8. Denote $M_N(\mathbb{C})$ the algebra of N by N complex matrices. For any $K \geq 1$ and $g \in \mathcal{G}_K$ with vertex set V and ordered edges $(v_1, w_1), \dots, (v_K, w_K)$, let us define Z_g by setting, for all $A_1, \dots, A_K \in M_N(\mathbb{C})$, the (i, j) -coefficient of $Z_g(A_1 \otimes \dots \otimes A_K)$ as

$$[Z_g(A_1 \otimes \dots \otimes A_K)](i, j) := \sum_{\substack{\phi: V \rightarrow [N] \\ \phi(in)=j, \phi(out)=i}} \prod_{k=1}^K A_k(\phi(w_k), \phi(v_k)).$$

This defines an action of the operad \mathcal{G} on $M_N(\mathbb{C})$. The product $AB = Z_{\xrightarrow{1,2}}(A \otimes B)$ induced by this action coincides with the classical product of matrices. The Hadamard product $A \circ B = Z_{\leftarrow\leftarrow}(A \otimes B)$ is the entry-wise product of matrices $(A(i, j)B(i, j))_{i,j=1}^N$. The diagonal of a matrix $\Delta(A) := Z_{\circlearrowleft}(A)$ and the transpose $A^t = Z_{\rightarrow}(A)$ are the diagonal $(\delta_{ij}A(i, i))_{i,j=1}^N$ and the transpose $(A(j, i))_{i,j=1}^N$ in the usual sense. The degree $deg(A) := Z_{\downarrow}(A)$ is the row sum diagonal matrix $(\delta_{ij} \sum_k A(i, k))_{i,j=1}^N$. For more information about the traffic distribution of matrices, see [16, Section 1.2].

Example 1.9. Let \mathcal{V} be an infinite set and let $M_{\mathcal{V}}(\mathbb{C})$ denotes the set of complex matrices $A = (A(v, w))_{v,w \in \mathcal{V}}$ indexed by \mathcal{V} (of possible infinite size) such that each row and column have a finite number of nonzero entries. For any $g \in \mathcal{G}$ and $A_1, \dots, A_K \in M_{\mathcal{V}}(\mathbb{C})$, we define $Z_g(A_1 \otimes \dots \otimes A_K)$ by the same formula as in Example 1.8 with summation now over the maps $\phi : V \rightarrow \mathcal{V}$. This defines as well a structure of \mathcal{G} -algebra for $M_{\mathcal{V}}(\mathbb{C})$. When the entries of the matrices are non negative integers, they encode the adjacency operator of a locally finite directed graph: the graph associated to a matrix A has $A(v, w)$ edges from a vertex $v \in V$ to a vertex $w \in V$.

The graph operations can be equivalently encoded in terms of analogues of polynomials, turning the linearity on $\mathcal{A}^{\otimes K}$ into K -linearity on \mathcal{A} , $K \geq 2$. We also define now a notion with no input and output for the purpose of the next section, and later we will consider a generalization with arbitrary numbers of in/outputs.

Definition 1.10. *Let J be a labelling set.*

- *A test graph labeled in J is a collection $T = (V, E, \gamma)$, where (V, E) is a finite, connected and oriented graph and $\gamma : E \rightarrow J$ is a labeling of the edges by indices.*
- *A graph monomial labeled in J is a collection $g = (V, E, \gamma, \mathbf{v})$, where $T = (V, E, \gamma)$ is a test graph and $\mathbf{v} = (in, out)$ is an ordered pair of vertices of T , considered respectively as the input and the output of T .*

We denote by $\mathcal{T}\langle J \rangle$ the set of test graphs labeled in J , and by $\mathcal{G}\langle J \rangle$ the set of graph monomials labeled in J . We denote by $\mathbb{C}\mathcal{T}\langle J \rangle$ and $\mathbb{C}\mathcal{G}\langle J \rangle$ the vector spaces generated by elements of the respective sets.

The labelling map γ of a graph monomial is not a bijection in general, so that a same variable can appear on several edges of the graph.

Let us consider a family $\mathbf{a} = (a_j)_{j \in J} \in \mathcal{A}^J$ of elements of a \mathcal{G} -algebra, and consider a graph monomial $t = (V, E, \gamma)$ with labels in J . Let us list arbitrarily the edges $E = \{e_1, \dots, e_K\}$ and denote by g the K -graph operation (V, E) with the ordered edges e_1, \dots, e_K . We set $t(\mathbf{a}) = Z_g(a_{\gamma(e_1)} \otimes \dots \otimes a_{\gamma(e_K)})$, which does not depend on the choice of the ordering of e_1, \dots, e_K , thanks to the equivariance property. For more details about graph polynomials, see [16, Section 4.2.2.]

1.2.2 Algebraic traffic spaces

Definition 1.11. *An algebraic traffic space is a couple (\mathcal{A}, τ) where \mathcal{A} is a \mathcal{G} -algebra and $\tau : \mathbb{C}\mathcal{T}\langle \mathcal{A} \rangle \rightarrow \mathbb{C}$ is a linear functional, called the combinatorial trace, defined on the space of test graphs labeled in \mathcal{A} , satisfying*

- *the unity property $\tau[(\cdot)] = 1$ for (\cdot) the graph with a single vertex and no edge,*
- *the multi-linearity w.r.t. the edges $\tau[T_{a+\lambda b}] = \tau[T_a] + \lambda\tau[T_b]$, for any test graph $T_{a+\lambda b} \in \mathcal{T}\langle \mathcal{A} \rangle$ having an edge e_0 with label $a + \lambda b$, where $a, b \in \mathcal{A}$ and $\lambda \in \mathbb{C}$, and for T_a and T_b defined as T with label a and b respectively for the edge e_0 ,*
- *the substitution property $\tau[T] = \tau[T_g]$ for any test graph $T \in \mathcal{T}\langle \mathcal{A} \rangle$ having an edge e_0 with label $g(\mathbf{a})$, where g is a graph monomial and \mathbf{a} a family of elements of \mathcal{A} , and T_g obtained from T by replacing the edge e_0 by the graph g whose edges are labelled by the element of \mathbf{a} .*

An element of an algebraic traffic space is called a traffic. A homomorphism between two algebraic traffic spaces (\mathcal{A}, τ) and (\mathcal{A}', τ') is a \mathcal{G} -morphism $f : \mathcal{A} \rightarrow \mathcal{A}'$ such that $\tau'[T(f(\mathbf{a}))] = \tau[T(\mathbf{a})]$, for any $T \in \mathcal{T}\langle J \rangle$ and $\mathbf{a} = (a_j)_{j \in J} \in \mathcal{A}^J$, where $f(\mathbf{a}) := (f(a_j))_{j \in J}$.

The map τ takes as entry a test graph whose edges are labeled by elements of \mathcal{A} and produces a complex number from. There is no meaning in the expression $\tau[a]$ for an element $a \in \mathcal{A}$.

In particular, (\mathcal{A}, τ) is not an algebraic non-commutative probability spaces. It can always be endowed with two different structures of algebraic non-commutative probability spaces.

Definition 1.12. Let (\mathcal{A}, τ) be an algebraic traffic space. The trace $\Phi : \mathcal{A} \rightarrow \mathbb{C}$ and the anti-trace $\Psi : \mathcal{A} \rightarrow \mathbb{C}$ are the linear maps given by the application of τ on a self loop and on a simple edge, namely

$$\Phi : a \mapsto \tau[\mathcal{O}^a], \quad \Psi : a \mapsto \tau[\cdot \xleftarrow{a} \cdot].$$

Recall that the product of two elements $a, b \in \mathcal{A}$ is defined by $ab := Z \xrightarrow{1} \cdot \xrightarrow{2} (a \otimes b)$, and that endowed with this product \mathcal{A} is an associative algebra. Then (\mathcal{A}, Φ) and (\mathcal{A}, Ψ) are two algebraic non-commutative probability spaces. The map Φ is tracial in the sense that $\Phi(ab) = \Phi(ba)$ for any $a, b \in \mathcal{A}$, and it satisfies $\Phi(\Delta(a)) = \Phi(a)$ for any $a \in \mathcal{A}$. Properties relating the different functionals τ , Φ and Ψ are explained in [16, Section 4.2.4.]

In the following definition, for a test graph T of $\mathcal{T}\langle J \rangle$ and a family $\mathbf{a} \in \mathcal{A}^J$ of elements of a set \mathcal{A} , we denote $T(\mathbf{a}) \in \mathcal{T}\langle \mathcal{A} \rangle$ the test graph obtained by replacing labels $j \in J$ of the edges of T by a_j . This definition is extended for $T \in \mathbb{C}\mathcal{T}\langle J \rangle$ by linearity.

Definition 1.13. Let (\mathcal{A}, τ) and $(\mathcal{A}_N, \tau_N), N \geq 1$, be algebraic traffic spaces, and J be an index set.

1. The traffic distribution of a family $\mathbf{a} = (a_j)_{j \in J}$ of elements in \mathcal{A} is the linear map $\tau_{\mathbf{a}} : T \in \mathbb{C}\mathcal{T}\langle J \rangle \mapsto \tau[T(\mathbf{a})] \in \mathbb{C}$.
2. A sequence of families $\mathbf{a}_N \in \mathcal{A}_N^J$ converges in traffic distribution to \mathbf{a} if the traffic distribution of \mathbf{a}_N converges pointwise to the traffic distribution of \mathbf{a} on $\mathbb{C}\mathcal{T}\langle J \rangle$.

Example 1.14. (Example 1.8 continued) Let $(\Omega, \mathcal{F}, \mathbb{P})$ be a probability space in the classical sense and let us consider the algebra $M_N(L^{\infty-}(\Omega, \mathbb{C}))$ of matrices whose coefficients are random variables with finite moments of all orders. Endowed with the action of the operad \mathcal{G} described in Example 1.8, it is a \mathcal{G} -algebra, and it becomes an algebraic traffic space endowed with the combinatorial trace τ_N given by: for any test graph $T = (V, E, M)$ labeled in $M_N(L^{\infty-}(\Omega, \mathbb{C}))$, where $M : E \rightarrow M_N(L^{\infty-}(\Omega, \mathbb{C}))$,

$$\tau_N[T] = \mathbb{E} \left[\frac{1}{N} \sum_{\phi: V \rightarrow [N]} \prod_{e=(v,w) \in E} (M(e))(\phi(w), \phi(v)) \right]. \quad (1.1)$$

The trace associated to τ_N is the usual normalized trace $\Phi_N : A \mapsto \mathbb{E}[\text{Tr}A]/N$ and the anti-trace is the map $\Psi_N : A \mapsto \mathbb{E}[\sum_{i,j} A(i,j)/N]$.

Example 1.15. (Example 1.9 continued) Let \mathcal{V} be an infinite set. A locally finite rooted graph on \mathcal{V} is a pair (G, ρ) where G is a directed graph such that each vertex has a finite number of neighbors (or equivalently an element of the space $M_{\mathcal{V}}(\mathbb{C})$ of Example 1.9 with integers entries) and ρ is an element of \mathcal{V} . Recall briefly that the so-called weak local topology is induced by the sets of (G, ρ) such that the subgraph induced by vertices at fixed distance of the root is given, see for instance [4]. The notion of locally finite random rooted graphs refers to the Borel σ -algebra given by this topology. Let $(\Omega, \mathcal{F}, \mathbb{P})$ be a probability space, let \mathcal{V} be a set and let $\rho \in \mathcal{V}$. Let \mathbf{G} be a family of locally finite random rooted graphs on Ω with vertex set \mathcal{V} and common root ρ . Consider the \mathcal{G} -subalgebra \mathcal{A} of $M_{\mathcal{V}}(\mathbb{C})$ induced by the adjacency matrices of \mathbf{G} . For any test graph $T = (V, E, M)$ labeled in \mathcal{A} and any root $r \in V$ of T , denote

$$\tau_{\rho}[(T, r)] = \mathbb{E} \left[\sum_{\substack{\phi: V \rightarrow \mathcal{V} \\ \phi(r) = \rho}} \prod_{e=(v,w) \in E} (M(e))(\phi(w), \phi(v)) \right]. \quad (1.2)$$

We assume that all the above quantities exist, which is true for instance if the degree of the vertices of the graphs \mathbf{G} are bounded by a deterministic constant. If moreover the random graph is *unimodular* [4, Section 2.2], then τ is independent of the root of T , and (\mathcal{A}, τ) is an algebraic traffic space (by applying [4, Equation (2.3)] to graph operations). This covers the case of random groups with given generator $(\Gamma, \gamma_1, \dots, \gamma_n)$ which is identified with the Cayley graph of Γ generated by $(\gamma_1, \dots, \gamma_n)$.

1.2.3 Möbius inversion and injective trace

In order to define traffic independence, we need first to define a transform of combinatorial traffic traces. It is based on a general principle that is used several times in this monograph. Recall that a poset is a set \mathcal{X} with a partial order \leq (see [24, Lecture 10] and [29, Section 3.7]). Moreover \mathcal{X} is a lattice whenever every two elements have a unique supremum and a unique infimum. If \mathcal{X} is a finite lattice, then there exists a map $\text{Mob}_{\mathcal{X}} : \mathcal{X} \times \mathcal{X} \rightarrow \mathbb{C}$, called the Möbius function on \mathcal{X} , such that for two functions $F, G : \mathcal{X} \rightarrow \mathbb{C}$ the statement that

$$F(x) = \sum_{x' \geq x} G(x'), \quad \forall x \in \mathcal{X}$$

is equivalent to

$$G(x) = \sum_{x' \geq x} \text{Mob}_{\mathcal{X}}(x, x') F(x'), \quad \forall x \in \mathcal{X}.$$

Hence the first formula implicitly defines the function G in terms of F .

For any set X , denote by $\mathcal{P}(X)$ the poset of partitions of X equipped with refinement order, that is $\pi \leq \pi'$ if the blocks of π are included in blocks of π' . Let (\mathcal{A}, Φ) be a non-commutative probability space and denote by $\text{N.C.}(K) \subset \mathcal{P}(\{1, \dots, K\})$ the poset of non-crossing partitions of $\{1, \dots, K\}$ [24, Lecture 9]. We recall that in an algebraic non-commutative probability space (\mathcal{A}, Φ) , the free cumulants are the multi-linear maps $(\kappa)_{L \geq 1}$ on \mathcal{A}^L given implicitly by

$$\Phi(a_1 \times \dots \times a_K) = \sum_{\pi \in \text{N.C.}(K)} \underbrace{\prod_{\{i_1 < \dots < i_L\} \in \pi} \kappa_L(a_{i_1}, \dots, a_{i_L})}_{=: \kappa(\pi)}. \quad (1.3)$$

With $\Phi(\pi)$ defined as $\kappa(\pi)$ using $\Phi(a_{i_1} \dots a_{i_L})$ instead of $\kappa_L(a_{i_1}, \dots, a_{i_L})$, we can express $\kappa(\pi)$ in terms of $\Phi(\pi')$ for $\pi' \geq \pi$ thanks to Möbius inversion in the poset on non crossing partitions.

Let now $T = (V, E, \gamma)$ be a test graph in $\mathcal{T}\langle \mathcal{A} \rangle$, with vertex set V . For any partition $\pi \in \mathcal{P}(V)$ of V , we denote by $T^\pi = (V^\pi, E^\pi, \gamma^\pi)$ the test graph obtained by identifying vertices in a same block of π . More precisely:

- the vertex set of T_π is the set of blocks of π ,
- each edge $e = (v, w)$ of T generates an edge $e^\pi = (B_v, B_w)$, where B_v denotes the block of π containing v ,
- the label of e^π is the label of e , namely $\gamma^\pi(e^\pi) = \gamma(e)$.

We say that T^π is a *quotient* of T . Denote 0_V the partition of V with singletons only (it then satisfies $T^{0_V} = T$).

Definition 1.16. Let \mathcal{A} be an ensemble and let $\tau : \mathbb{C}\mathcal{T}\langle\mathcal{A}\rangle \rightarrow \mathbb{C}$ be a linear form. We define the injective version of τ , and denote τ^0 , the linear form on $\mathbb{C}\mathcal{T}\langle\mathcal{A}\rangle$ implicitly given by the following formula: for any test graph $T \in \mathcal{T}\langle\mathcal{A}\rangle$

$$\tau[T] = \sum_{\pi \in \mathcal{P}(V)} \tau^0[T^\pi], \quad (1.4)$$

in such a way for any test graph T one has

$$\tau^0[T] = \sum_{\pi \in \mathcal{P}(V)} \text{Mob}_{\mathcal{P}(V)}(0_V, \pi) \cdot \tau[T^\pi].$$

The injective version of a combinatorial trace (resp. a traffic distribution) is called the injective trace (resp. the injective distribution).

Example 1.17. The injective version Tr^0 of the trace of test graph in random matrices of $M_N(\mathbb{C})$ defined in (1.1) is given, for $T = (V, E, M)$ a test graph labeled in $M_N(L^{\infty}(\Omega, \mathbb{C}))$, by

$$\tau_N^0[T] = \mathbb{E} \left[\frac{1}{N} \sum_{\substack{\phi: V \rightarrow [N] \\ \text{injective}}} \prod_{e=(w,v) \in E} (M(e))(\phi(w), \phi(v)) \right]. \quad (1.5)$$

Limiting injective combinatorial distributions of usual matrix models (unitary Haar matrices, uniform permutation matrices, certain Wigner matrices) are proved to exist [16, Chapter 3] and are shown to have simple and natural expressions.

Remark 1.18. The map τ^0 satisfies the property of multi-linearity w.r.t. the edges of Definition 1.11, but not the substitution property, see [16, Section 2.1.].

1.2.4 Traffic independence

Let J be a fixed index set and, for each $j \in J$, let \mathcal{A}_j be some sets. Given a family of linear maps $\tau_j : \mathbb{C}\mathcal{T}\langle\mathcal{A}_j\rangle \rightarrow \mathbb{C}$, $j \in J$, sending the graph with no edge to one, we shall define a linear map denoted $\star_{j \in J} \tau_j : \mathbb{C}\mathcal{T}\langle\sqcup_{j \in J} \mathcal{A}_j\rangle$ with the same property and called the free product of the τ_j 's. The terminology *free* product should be understood as *canonical* product, and may not be confused with the terminology *free* independence. Therein, $\sqcup_{j \in J} \mathcal{A}_j$ denotes the disjoint union of copies of \mathcal{A}_j , although the sets \mathcal{A}_j can originally intersect or be equal: it is formally defined as the set of all couples (j, a) where $j \in J$ and $a \in \mathcal{A}_j$.

Let us consider a test graph T in $\mathcal{T}\langle\sqcup_{j \in J} \mathcal{A}_j\rangle$ and introduce an undirected graph as follow. We first call colored components of T with respect to the families $(\mathcal{A}_j)_{j \in J}$ the maximal nontrivial connected subgraphs of T whose edges are labelled by elements of \mathcal{A}_j for some $j \in J$ (they are elements of $\mathcal{T}\langle\mathcal{A}_j\rangle$). There is no confusion about the definition of colored components because of the convention for $\sqcup_{j \in J} \mathcal{A}_j$. When there is no ambiguity about the collection $(\mathcal{A}_j)_{j \in J}$, we denote by $\mathcal{CC}(T)$ the set of colored components of T . We call connectors of T the vertices of T belonging to at least two different colored components. The graph $\mathcal{GCC}(T)$ defined below is called graph of colored components of T with respect to $(\mathcal{A}_j)_{j \in J}$:

- the vertices of $\mathcal{GCC}(T)$ are the colored components of T and its connectors;
- there is an edge between a colored component in $\mathcal{CC}(T)$ and a connector if the connector belongs to the component.

The following definition is from [16, Section 2.2].

Definition 1.19. 1. For each $j \in J$, let \mathcal{A}_j be a set and $\tau_j : \mathbb{C}\mathcal{T}\langle\mathcal{A}_j\rangle \rightarrow \mathbb{C}$ be a linear map sending the test graph with no edges to one. The free product of the maps τ_j is the linear map $\star_{j \in J} \tau_j : \mathbb{C}\mathcal{T}\langle\coprod_j \mathcal{A}_j\rangle \rightarrow \mathbb{C}$ whose injective version is given by: for any test graph T ,

$$(\star_{j \in J} \tau_j)^0[T] = \mathbb{1}(\mathcal{GCC}(T) \text{ is a tree}) \times \prod_{S \in \mathcal{CC}(T)} \tau_{j(S)}^0[S], \quad (1.6)$$

where $j(S)$ is the index of the labels of S .

2. Let (\mathcal{A}, τ) be an algebraic traffic space and let J be a fixed index set. For each $j \in J$, let $\mathcal{A}_j \subset \mathcal{A}$ be a \mathcal{G} -subalgebra. The subalgebras $(\mathcal{A}_j)_{j \in J}$ are called traffic independent whenever the restriction of τ on the test graphs labeled by elements of $\mathcal{A}_j, j \in J$, coincides with $\star_{j \in J} \tau_j$.
3. Let $X_j, j \in J$ be subsets of \mathcal{A} and let $(\mathbf{a}_j)_{j \in J}$ be a family of elements of \mathcal{A} . Then $(X_j)_{j \in J}$ (resp. $(\mathbf{a}_j)_{j \in J}$) are called traffic independent whenever the \mathcal{G} -subalgebra induced by the X_j 's (resp. by the \mathbf{a}_j 's) are traffic independent.

The motivation for introducing this definition is, in the context of large matrices, Example 1.14, the asymptotic traffic independence for permutation invariant matrices, see [16, Theorem 1.8].

We end this section by the following elementary property of traffic independence.

Lemma 1.20. Traffic independence is symmetric and associative, i.e. \mathcal{A}_1 and \mathcal{A}_2 are independent if and only if \mathcal{A}_2 and \mathcal{A}_1 are independent, and $\mathcal{A}_j, j = 1, 2, 3$ are independent if and only if \mathcal{A}_1 and $(\mathcal{A}_2, \mathcal{A}_3)$ are independent and \mathcal{A}_2 and \mathcal{A}_3 are independent.

Part I

General traffic spaces

Presentation

According to Section 1.2, traffic independence in an algebraic traffic space (\mathcal{A}, τ) is defined in terms of the injective version τ^0 of τ , thanks to the formula involving the graph of colored components. Such a definition of independence is unusual in non-commutative probability, where the injective trace has no analogue. As a comparison, let us remind the two equivalent definitions of free independence in free probability. It is usually defined by a relation of moments, namely the centering of alternated products of centered elements. The second usual characterization of free independence is the vanishing of mixed free cumulants.

We propose in Theorem 2.8 of Section 2 a characterization of traffic independence in terms of moment functions as the centering of some *generalized alternated products of reduced elements*, in an appropriate sense that we shall make precise. Note that Gabriel proposes in [10] a definition of traffic cumulants, and traffic independence is the vanishing of these mixed traffic cumulants.

In Section 3, we construct the product of traffic spaces: given for each $j \in J$ an algebraic traffic space (\mathcal{A}_j, τ_j) , we construct a new algebraic traffic space (\mathcal{A}, τ) that contains the \mathcal{A}_j as independent \mathcal{G} -subalgebras. The space \mathcal{A} will be made with equivalent classes of graph operations with an input and output whose edges are labelled by the \mathcal{A}_j . The combinatorial trace τ will be the extension to \mathcal{A} of the free product of the combinatorial traces τ_j , $j \in J$.

Positivity of state is another important notion in noncommutative probability. We propose a definition of positivity for combinatorial trace in Section 3.3. We prove that the free product traffic spaces with positive traces also admits a positive trace.

2 A natural characterization of traffic independence

2.1 Statement

In order to give the characterization of traffic independence which is the analogue of the usual presentation of freeness, we need a generalization of test graphs and graph polynomials with arbitrary numbers of marked vertices. To explain this fact, recall that the definition of traffic independence involves the graph of colored components. To define correctly the operation which consists in reconstructing a test graph from its colored components and its graph of colored components, we need formal objects that are specified in the two following definitions (see Figure 2).

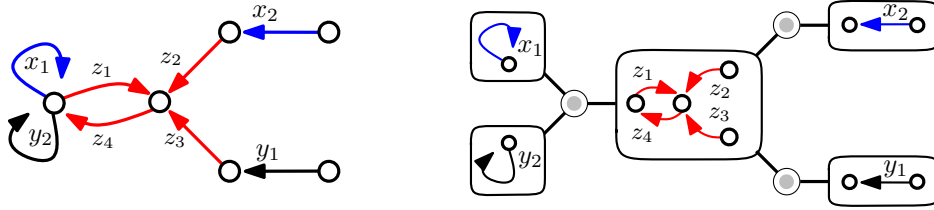

Figure 2: Left: a test graph T in three families of traffics (x_1, x_2) , (y_1, y_2) and (z_1, z_2, z_3, z_4) . Note that $\tau[T] = \Phi[\Delta(x_1)\Delta(y_2)(z_4 \circ z_1^t) \deg(z_2 x_2) \deg(z_3 y_1) z_2 \Delta(y_1)]$. Right: the graph of colored component $\mathcal{G}^{\text{CC}}(T)$.

Definition 2.1. A graph monomial of rank $n \geq 1$ (in short a n -graph monomial) labeled in J is the data $g = (V, E, \gamma, \mathbf{v})$ of a test graph $T = (V, E, \gamma)$ and of a n -tuple $\mathbf{v} = (v_1, \dots, v_n)$ of vertices of T , called the outputs. We denote by $\mathcal{G}^{(n)}\langle J \rangle$ the set of n -graph monomials and by $\mathbb{C}\mathcal{G}^{(n)}\langle J \rangle$ the space of n -graph polynomials.

We have $\mathbb{C}\mathcal{G}^{(2)}\langle J \rangle = \mathbb{C}\mathcal{G}\langle J \rangle$ where a graph monomial of rank 2 is identified with the graph monomial whose input is the first output. A test graph is also called a 0-graph monomial and we set $\mathbb{C}\mathcal{G}^{(0)}\langle J \rangle := \mathbb{C}\mathcal{T}\langle J \rangle$. To define generalized products of graph polynomials of arbitrary rank, we use the following objects, drawn in Figure 3.

Definition 2.2. A bigraph operation of rank $n \geq 1$ (in short a n -bigraph operation) in $L \geq 0$ variables is the data of

- a finite, connected, undirected and bipartite graph g , endowed with a bipartition of its vertices into two sets $V_{\text{in}}(g)$ and $V_{\text{co}}(g)$, whose elements are called inputs and connectors,
- with exactly L ordered inputs, given together with an ordering of its edges around each input
- and the data of an ordered subset $V_{\text{out}}(g)$ consisting in n elements of the connectors $V_{\text{co}}(g)$ that we call outputs,

and such that all connectors that are not an output have degree greater than or equal to 2. We denote by $\mathcal{B}^{(n)}$ the set of n -bigraph operations. For any $L, n \geq 0$ and any tuple $\mathbf{d} = (d_1, \dots, d_L) \in (\mathbb{N}^*)^L$, we denote by $\mathcal{B}_{L, \mathbf{d}}^{(n)}$ if $L \neq 0$ and by $\mathcal{B}_0^{(n)}$ otherwise the set of n -bigraph operations with L inputs such that the ℓ -th one has degree d_ℓ .

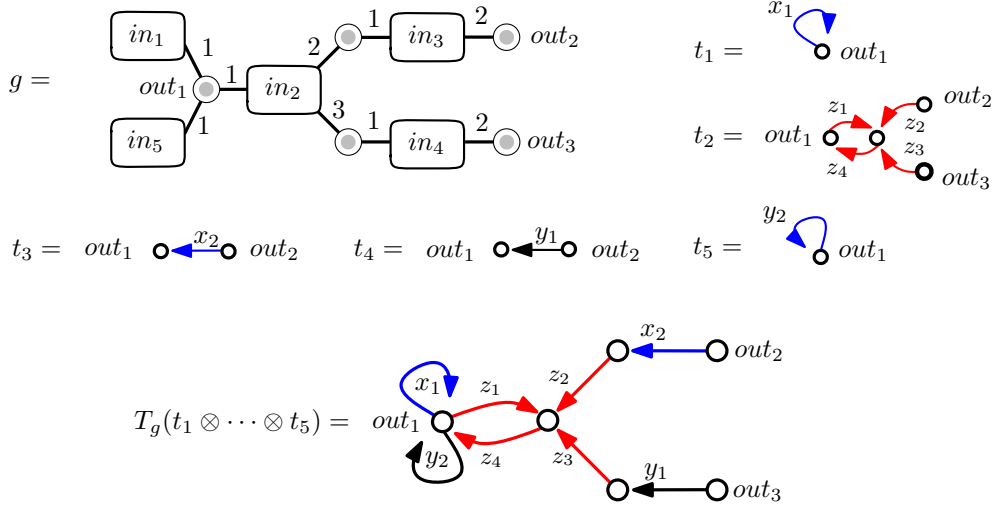

Figure 3: A bigraph operation g of order 3 with 5 inputs and 3 outputs with degree sequence $(1, 3, 2, 2, 1)$; the numbers in the figure describe the order of the edges around each input. Five graph operations t_1, \dots, t_5 which satisfy that $t_1 \otimes \dots \otimes t_5$ is g -alternated. The graph operation $T_g(t_1 \otimes \dots \otimes t_5)$

A n -bigraph operation in L variables with degrees d_1, \dots, d_L has to be thought as an operation that accepts L objects with ranks d_1, \dots, d_L , and produces a new object of rank n . The set of bi-graph operations is actually an operad, although we do not use this fact (see Section 4 for comments).

In particular, a n -bigraph operation can produce a new n -graph monomial from L different graph monomials in the following way, see Figure 3. Let us consider L graph monomials t_1, \dots, t_L labeled on some set \mathcal{A} , with respective number of outputs given by $\mathbf{d} \in (\mathbb{N}^*)^L$ (that is $t_\ell \in \mathcal{G}^{(d_\ell)}\langle \mathcal{A} \rangle$), and a bigraph operation $g \in \mathcal{B}_{L, \mathbf{d}}^{(n)}$. Replacing the ℓ -th input of g and its adjacent ordered edges (e_1, \dots, e_{d_ℓ}) by the graph of t_ℓ , identifying for each $k \in [L]$ the connector attached to e_k with the k -th output of t_ℓ , yields a connected graph. We denote by $T_g(t_1 \otimes \dots \otimes t_L) \in \mathcal{G}^{(n)}\langle \mathcal{A} \rangle$ the n -graph monomial whose labelling is induced by those of t_1, \dots, t_L , and with outputs given by the outputs of g . We then define by linear extension

$$T_g : \mathbb{C}\mathcal{G}^{(d_1)}\langle \mathcal{A} \rangle \otimes \dots \otimes \mathbb{C}\mathcal{G}^{(d_L)}\langle \mathcal{A} \rangle \longrightarrow \mathbb{C}\mathcal{G}^{(n)}\langle \mathcal{A} \rangle$$

$$t_1 \otimes \dots \otimes t_L \longmapsto T_g(t_1 \otimes \dots \otimes t_L).$$

Example 2.3. • Let $\mathbf{A}_N = (A_j)_{j \in J}$ be a family of matrices and $t = (V, E, \gamma, \mathbf{v})$ be a n -graph monomial labeled in J . We define a random tensor matrix $t(\mathbf{A}_N) \in (\mathbb{C}^N)^{\otimes n}$ as follows. Denoting by $\mathbf{v} = (v_1, \dots, v_n)$ the sequence of outputs of t and by $(\xi_i)_{i=1, \dots, N}$ the canonical basis of \mathbb{C}^N , we set,

$$t(\mathbf{A}_N) = \sum_{\phi: V \rightarrow [N]} \prod_{e=(v, w) \in E} A_{\gamma(e)}(\phi(v), \phi(w)) \xi_{\phi(v_1)} \otimes \dots \otimes \xi_{\phi(v_n)}. \quad (2.1)$$

- More generally, let g be a n -bigraph operation with K inputs and A_1, \dots, A_K be tensors matrices such that the rank n_k of A_k (so that $A_k \in (\mathbb{C}^N)^{\otimes n_k}$) is the degree of the k -th input of g . Denote by (v_1, \dots, v_n) the outputs of g and for

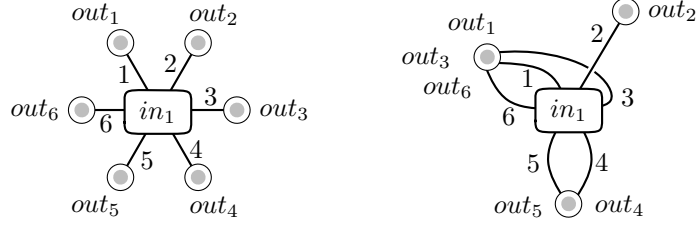

Figure 4: The bi-graph operations Δ_{0_6} (left) and $\Delta_{\{\{1,3,6\},\{2\},\{4,5\}\}}$ (right).

each $k = 1, \dots, K$ denote by $(w_1^k, \dots, w_{n_k}^k)$ the ordered neighborhood connectors of the k -th input. Then we define an element of $(\mathbb{C}^N)^n$ by

$$T_g(\mathbf{A}_N) = \sum_{\phi: V_{\infty}(g) \rightarrow [N]} \prod_{k=1}^K A_k(\phi(w_1^k), \dots, \phi(w_{n_k}^k)) \xi_{\phi(v_1)} \otimes \dots \otimes \xi_{\phi(v_n)}. \quad (2.2)$$

Definition 2.4. Let J be an index set and $(\mathcal{A}_j)_{j \in J}$ be a family of ensembles, and let $g \in \mathcal{B}_{L, \mathbf{d}}^{(n)}$ be a bigraph operation with $\mathbf{d} = (d_1, \dots, d_L)$. A tensor product $(t_1 \otimes \dots \otimes t_L)$ of graph polynomials labeled by $\bigsqcup_j \mathcal{A}_j$ is alternated along g (in short g -alternated) whenever

1. $L' = L$,
2. $t_i \in \mathbb{C}\mathcal{G}^{(d_i)} \langle \mathcal{A}_{j_i} \rangle$ for each $i = 1, \dots, L$, and
3. for all $p, q \in [L]$ such that the p -th and the q -th inputs are neighbors of a same connector, then $j_p \neq j_q$.

Let T_g be a bigraph operation and let $m_1 \otimes \dots \otimes m_L$ be a tensor product of graph monomials, labeled in a set $\bigsqcup_j \mathcal{A}_j$, $j \in J$, alternated along $g \in \mathcal{B}_{L, \mathbf{d}}^{(0)}$. Assume that T_g does not identify any pair of outputs of each m_ℓ and that the output vertices of each m_ℓ are pairwise distinct. Then $T_g(m_1 \otimes \dots \otimes m_L)$ is a test graph with graph of colored components g , and its colored components are m_1, \dots, m_L , (considered as graphs with no outputs). Reciprocally, the graph of colored component gives a decomposition of any test graph as an element of the form $T_g(m_1 \otimes \dots \otimes m_L)$. This decomposition is unique up to the symmetry of a certain automorphism group introduced later in Section 3.3.

We shall now define a notion of *reduced* n -graph polynomials. For any $n \geq 2$, any partition $\pi \in \mathcal{P}(n)$ of $\{1, \dots, n\}$, and any n -graph monomial g with outputs (v_1, \dots, v_n) , let us denote by g^π the quotient graph obtained by identifying vertices v_1, \dots, v_n that belong to a same block of π , with outputs given by the images of (v_1, \dots, v_n) by the quotient map, so that the edges of g^π can be identified with the one of g . This defines a linear map $\Delta_\pi : \mathbb{C}\mathcal{G}^{(n)} \langle \mathcal{A} \rangle \rightarrow \mathbb{C}\mathcal{G}^{(n)} \langle \mathcal{A} \rangle$ such that $\Delta_\pi(g) = g^\pi$ for n -graph monomials g . The map Δ_π can also be seen as the action of a bigraph operation (see an example in Figure 4). Denote respectively by 0_n and 1_n the partitions of $\{1, \dots, n\}$ made of n singletons and of one single block respectively. Note that $\Delta_{0_n}(g) = g$ for any $g \in \mathbb{C}\mathcal{G}^{(n)} \langle \mathcal{A} \rangle$,

Definition 2.5. Let \mathcal{A} be an ensemble and $\tau : \mathbb{C}\mathcal{T} \langle \mathcal{A} \rangle \rightarrow \mathbb{C}$ be a linear form. We extend τ in a linear map $\mathbb{C}\mathcal{T} \langle \mathcal{A} \rangle \oplus \mathbb{C}\mathcal{G}^{(1)} \langle \mathcal{A} \rangle \rightarrow \mathbb{C}$ by forgetting the position of the output in 1-graph monomials. A n -graph polynomial $t \in \mathbb{C}\mathcal{G}^{(n)} \langle \mathcal{A} \rangle$ is called reduced with respect to τ , if

- $n \in \{0, 1\}$ and $\tau(t) = 0$, or
- $n \geq 2$ and for any $\pi \in \mathcal{P}(n) \setminus \{0_n\}$ one has $\Delta_\pi(t) = 0$.

Note that the reduceness condition does not depend on τ when $n \geq 2$.

Example 2.6. If $n = 2$, then $\Delta_{1_2}(t) = \Delta(t)$, where we recall that the diagonal operator Δ is the graph operation with one vertex and one edge. So t is reduced if and only if $\Delta(t) = 0$.

Example 2.7. Let \mathbf{A}_N be a family of matrices of size N by N and let t be a n -graph polynomial, $n \geq 2$. Then the tensor matrix $t(\mathbf{A}_N)$ defined in Example 2.3 is reduced if and only if, denoting by $B_{\mathbf{i}}, \mathbf{i} \in [N]^n$, its components in the canonical basis, one has $B_{\mathbf{i}} = 0$ as soon as two indices of \mathbf{i} are equal. In particular for $n = 2$, a matrix is reduced whenever its diagonal entries are equal to zero.

We can now state the main result of the section.

Theorem 2.8. *Let (\mathcal{A}, τ) be an algebraic traffic space with trace Φ and anti-trace Ψ . For each $j \in J$ let \mathcal{A}_j be a \mathcal{G} -subalgebra. The following properties are equivalent:*

1. *The \mathcal{G} -subalgebras $\mathcal{A}_j, j \in J$, are traffic independent (Definition 1.19),*
2. *One has $\tau[h] = 0$ for any $h = T_g(t_1 \otimes \cdots \otimes t_L)$ in $\mathbb{C}\mathcal{T}\langle \bigsqcup_j \mathcal{A}_j \rangle$ where $g \in \mathcal{B}^{(0)}$ is a bigraph operation and $t_1 \otimes \cdots \otimes t_L$ is a g -alternated tensor product of reduced elements with respect to τ .*
3. *One has $\Phi[h] = 0$ for any $h = T_g(t_1 \otimes \cdots \otimes t_L)$ in $\mathbb{C}\mathcal{G}^{(2)}\langle \bigsqcup_j \mathcal{A}_j \rangle$, where $g \in \mathcal{B}^{(2)}$ is a bigraph operation and $t_1 \otimes \cdots \otimes t_L$ is a g -alternated tensor product of reduced elements with respect to τ .*
4. *One has $\Psi[h] = 0$ for any $h = T_g(t_1 \otimes \cdots \otimes t_L)$ in $\mathbb{C}\mathcal{G}^{(2)}\langle \bigsqcup_j \mathcal{A}_j \rangle$, where $g \in \mathcal{B}^{(2)}$ is a bigraph operation and $t_1 \otimes \cdots \otimes t_L$ is a g -alternated tensor product of reduced elements with respect to τ .*

Hence traffic independence is the centering of alternated bigraph operations of reduced elements with respect to τ, Φ or Ψ indifferently. The proof of the proposition is given in the next section.

As a direct application, we get a useful criterion of free independence.

Corollary 2.9. *Let (\mathcal{A}, τ) be an algebraic traffic space such that \mathcal{A} is a $*$ -algebra and the associated trace Φ is a state. Denote for any $a \in \mathcal{A}$*

$$\eta(a) = \tau \left[\begin{array}{c} \circlearrowleft \\ \circlearrowright \end{array} \circlearrowleft \circlearrowright^{a^*} \right] - |\tau[\circlearrowleft^a]|^2 = \Phi(\Delta(a^*)\Delta(a)) - |\Phi(a)|^2 = \Phi(a^* \circ a) - |\Phi(a)|^2,$$

where we recall (see section 1.2.1) that $\Delta = Z_{\circlearrowleft}$ is the diagonal operator and $(a \circ b) = Z_{\circlearrowleft}(a \otimes b)$ is the Hadamard product. Let $\mathcal{B} \subset \mathcal{A}$ be a unital $*$ -subalgebra such that $\eta(a) = 0$ for any $a \in \mathcal{B}$, and let $\mathcal{B}_j \subset \mathcal{B}, j \in J$, be subalgebras. If $(\mathcal{B}_j)_{j \in J}$ are traffic independent in (\mathcal{A}, τ) , then they are freely independent in the $*$ -probability space $(\mathcal{B}, \Phi|_{\mathcal{B}})$.

Example 2.10. 1. In [16, Proposition 2.16], it is proved that two independent traffics a and b such that $\eta(a) \neq 0 \neq \eta(b)$ are not free independent with respect to the trace. If $\eta(a) \neq 0$ and $\eta(b) = 0$, both situations can happen as we can see with the limits of Wigner matrices, uniform permutation matrices and diagonal matrices [16]: the map η vanishes only for the two first models, a Wigner matrices is asymptotically free from a diagonal matrix, but a uniform permutation matrix is not asymptotically free from a diagonal matrix.

2. In the context of the so-called *asymptotically unitarily invariant* random matrices defined in Part II, the assumption of Corollary 2.9 is satisfied. Nevertheless we will see that in this particular case the free independence is explained in a more direct way and has stronger implications.
3. Yet, the above corollary covers a much larger situation than the example previously mentioned. The example of the large uniform permutation matrix can be generalized for infinite rooted graphs. More precisely, recall Example 3.9 of the \mathcal{G} -algebra \mathcal{A} of locally finite rooted graphs on a set of vertices \mathcal{V} . It is a classical fact that an element A of \mathcal{A} which is both deterministic and unimodular is vertex-transitive (there exist automorphisms exchanging each pair of vertices). This property implies that the diagonal $\Delta(A) = (A(v, v)\mathbb{1}_{v=w})_{v, w \in \mathcal{V}}$ of A is constant, and so one can apply the lemma. This gives a new proof of a result of Accardi, Lenczewski and Salapata [1] stating that the spectral distribution of the free product of infinite deterministic graphs is the free product of the spectral distributions.

Proof of Corollary 2.9. Since the trace defined on \mathcal{A} is a state, the assumption implies, for every $a \in \mathcal{B}$, that $\Delta(a)$ has the same $*$ -distribution as $\Phi(a)\mathbb{1}$. Let $(\mathcal{B}_j)_{j \in J}$ traffic independent $*$ -subalgebras of \mathcal{B} . Let $a_1, \dots, a_n \in \mathcal{B}$, such that for any $k \in [n]$, $\Phi(a_k) = 0$ and $a_k \in \mathcal{B}_{j_k}$, with $j_1 \neq j_2 \neq \dots \neq j_n$. Then,

$$\Phi\left((a_1 - \Delta(a_1)) \dots (a_n - \Delta(a_n))\right) = \Phi\left((a_1 - \Phi(a_1)) \dots (a_n - \Phi(a_n))\right) = \Phi(a_1 \dots a_n).$$

Let g be the bigraph operation with two outputs *in* and *out*, n inputs and n connectors, whose graph is a directed line from *in* to *out*, with input vertices (alternating with the connectors) ordered consecutively from *in* to *out*. Then one has

$$\Phi\left((a_1 - \Delta(a_1)) \dots (a_n - \Delta(a_n))\right) = \Phi\left[T_g\left((a_1 - \Delta(a_1)) \otimes \dots \otimes (a_n - \Delta(a_n))\right)\right],$$

and $(a_1 - \Delta(a_1)) \otimes \dots \otimes (a_n - \Delta(a_n))$ is a g -alternated tensor product of reduced elements, so that by Theorem 2.8 we get $\Phi(a_1 \dots a_n) = 0$. \square

2.2 Proof of Theorem 2.8

2.2.1 A decomposition of graph polynomials

We start by stating several preliminary lemmas. The first three statements are about the space of n -graph polynomials $\mathbb{C}\mathcal{G}\langle \bigsqcup_j \mathcal{A}_j \rangle$. Note that in these lemmas we only assume that the sets \mathcal{A} and \mathcal{A}_j , $j \in J$, are arbitrary ensembles, we do not use their \mathcal{G} -algebra structure. The first lemma gives an explicit characterization of reducedness.

Lemma 2.11. *Let \mathcal{A} be an ensemble and for $n \geq 0$ let m a n -graph monomial labeled in \mathcal{A} . Denote by \mathcal{O} the output set of m (empty if $n = 0$). For each partition σ of \mathcal{O} , recall that $\Delta_\sigma(m) = m^\sigma$ denotes the graph monomial obtained by identifying the outputs of m that belong to a same block of σ . Let us denote by Mob the Möbius function for the poset of partitions of \mathcal{O} (Section 1.2.3) and $0_{\mathcal{O}}$ the partition of \mathcal{O} made of singletons. Then, with (\cdot) denoting the graph with no edges,*

$$p(m) := \begin{cases} m - \tau(m) \times (\cdot) & \text{if } n = 1, 0, \\ \sum_{\sigma \in \mathcal{P}(\mathcal{O})} \text{Mob}(0_{\mathcal{O}}, \sigma) m^\sigma & \text{if } n \geq 2, \end{cases}$$

is a reduced n -graph polynomial with respect to τ . Moreover, extending p by linearity on n -graph polynomials, every reduced n -graph polynomial t satisfies $t = p(t)$.

Proof. The proposition is clear if $n = 0, 1$. Assume $n \geq 2$ in the following. For any $\nu \in \mathcal{P}(\mathcal{O})$,

$$\Delta_\nu(p(m)) = \Delta_\nu \left(\sum_{\sigma \in \mathcal{P}(\mathcal{O})} \text{Mob}(0_{\mathcal{O}}, \sigma) m^\sigma \right) = \sum_{\mu \in \mathcal{P}(\mathcal{O})} \left(\sum_{\sigma \in \mathcal{P}(\mathcal{O}): \sigma \vee \nu = \mu} \text{Mob}(0_{\mathcal{O}}, \sigma) \right) m^\mu,$$

where $\sigma \vee \nu$ is the join of the partitions σ and ν , i.e. the smallest partition whose blocks contain those of σ and ν . Now, for any $\mu \in \mathcal{P}(\mathcal{O})$, by [29, Sections 3.6 and 3.7] for the first and last equalities, one has

$$\begin{aligned} \sum_{\sigma \in \mathcal{P}(\mathcal{O}): \sigma \vee \nu = \mu} \text{Mob}(0_{\mathcal{O}}, \sigma) &= \sum_{\sigma \leq \mu} \sum_{\sigma \vee \nu \leq \xi \leq \mu} \text{Mob}(\xi, \mu) \text{Mob}(0_{\mathcal{O}}, \sigma) \\ &= \sum_{\nu \leq \xi \leq \mu} \text{Mob}(\xi, \mu) \left(\sum_{\sigma \leq \xi} \text{Mob}(0_{\mathcal{O}}, \sigma) \right) \\ &= \sum_{\nu \leq \xi \leq \mu} \text{Mob}(\xi, \mu) \delta_{\xi, 0_{\mathcal{O}}} = \delta_{\nu, 0_{\mathcal{O}}} \text{Mob}(0_{\mathcal{O}}, \mu), \end{aligned}$$

Hence we have obtained $\Delta_\nu(p(m)) = \delta_{\nu, 0_{\mathcal{O}}} p(m)$, that is $p(m)$ is reduced.

Let us now prove that every reduced graph polynomial t satisfies $t = p(t)$. For any $\eta \in \mathcal{P}(\mathcal{O})$ let us define $p_\eta(m) = \sum_{\pi \geq \eta} \text{Mob}(\eta, \pi) m^\pi$. Extended by linearity, the p_σ 's define a partition of the unity, that is $t = \sum_{\eta \in \mathcal{P}(\mathcal{O})} p_\eta(t)$ for any t . By the same computation as above, one sees that t is reduced if and only if $p_\eta(t) = \delta_{\eta=0_{\mathcal{O}}} t$ for any η . Hence we obtain $t = p_{0_{\mathcal{O}}}(t) = p(t)$ as expected. \square

The second lemma tells that any n -graph polynomial in $\mathbb{C}\mathcal{G}\langle \bigsqcup_j \mathcal{A}_j \rangle$ can be written as a linear combination of bigraph operations evaluated in alternated and reduced elements.

Definition 2.12. Let J be an index set and, for each $j \in J$, let \mathcal{A}_j be an ensemble.

- A colored bigraph operation with color set J is a couple (g, γ) where $g \in \bigcup_{n \geq 0} \mathcal{B}^{(n)}$ is a bigraph operation with $L \geq 1$ inputs and $\gamma : [L] = \{1, \dots, L\} \rightarrow J$ is a map telling that the ℓ -th input is of color $\gamma(\ell)$. With small abuse, we still denote g instead of (g, γ) the colored bigraph operation with implicit mention of γ . We say that g is alternated if γ associates distinct colors to the neighbours of a same connector. We denote by $\mathcal{B}_{\text{col}}^{(n)}$ the set of colored bigraph operations with $n \geq 0$ outputs and by $\mathcal{B}_{\text{alt}}^{(n)}$ the set of alternated colored bigraph operations.
- Let t_1, \dots, t_L be graph polynomials of arbitrary ranks in $\bigsqcup_j \mathcal{A}_j$. We say that the tensor product $\mathbf{t} = (t_1 \otimes \dots \otimes t_L)$ is g -colored if $t_\ell \in \mathbb{C}\mathcal{G}^{(d_\ell)} \langle \mathcal{A}_{\gamma(\ell)} \rangle$ for any $\ell = 1, \dots, L$.

Lemma 2.13. Let J be an index set, let \mathcal{A}_j be an ensemble for each $j \in J$, and let $\tau : \mathbb{C}\mathcal{T}\langle \bigsqcup_j \mathcal{A}_j \rangle \rightarrow \mathbb{C}$ be a unital linear form. Then we have the decomposition

$$\mathbb{C}\mathcal{G}^{(n)} \langle \bigsqcup_{j \in J} \mathcal{A}_j \rangle = \mathbb{C}(\cdot) + \sum_{g \in \mathcal{B}_{\text{alt}}^{(n)}} \mathcal{W}_g$$

where \mathcal{W}_g is the space generated by $T_g(t_1 \otimes \dots \otimes t_L)$, for any $(t_1 \otimes \dots \otimes t_L)$ which is a g -colored tensor product of reduced elements with respect to τ , and $\mathbb{C}(\cdot)$ denotes the space generated by the graph monomial (\cdot) with a single vertex and no edge in $\mathbb{C}\mathcal{G}^{(n)} \langle \bigsqcup_{j \in J} \mathcal{A}_j \rangle$.

Proof. Let us denote by \mathcal{E}^0 the vector space on the right hand side, spanned by (\cdot) and the \mathcal{W}_g 's. For any $k \geq 1$, let us denote by \mathcal{E}_k the vector space generated by the graph polynomials $T_g(\mathbf{t})$, where $g \in \mathcal{B}_{col}$ has a number of vertices less than or equal to k and \mathbf{t} is g -colored. Let us prove by induction that for any $k \geq 1$, $\mathcal{E}_k \subset \mathcal{E}^0$. Since $\mathbb{C}\mathcal{G}^{(n)}\langle \bigsqcup_{j \in J} \mathcal{A}_j \rangle = \bigcup_{k \geq 0} \mathcal{E}_k$, this shall conclude the proof.

To begin with, note that for any $n \geq 1$ the only element of \mathcal{E}_1 is $g = (\cdot)$ consists in a single connector vertex which is the common values of all outputs. Hence $\mathcal{E}_1 = \mathbb{C}(\cdot) \subset \mathcal{E}^0$. If $n = 0$, then $g = (\cdot)$ consists in a single input vertex and $\mathcal{W}_{g,\gamma}$ is the linear space generated by the $\mathbb{C}\mathcal{T}\langle \mathcal{A}_j \rangle$, $j \in J$. Every element T in this space can be written $T = \tau[T](\cdot) + (T - \tau[T](\cdot)) \in \mathbb{C}\mathbb{I} \oplus_j \mathcal{W}_{(\cdot),j}$.

Let us now assume the claim for $k \in \mathbb{N}$. For any $k' \geq 1$ and any $s \geq 0$ we denote by $\mathcal{E}_{k'}^s$, the vector space spanned by the graph polynomials $T_g(\mathbf{t})$ of $\mathcal{E}_{k'}$ where at most s elements are non reduced in \mathbf{t} . Note in particular that $\mathcal{E}^0 = \bigcup_{k' \geq 0} \mathcal{E}_{k'}^0$ and $\mathcal{E}_{k'} = \bigcup_{s \geq 0} \mathcal{E}_{k'}^s$. Let us prove by induction on $s \geq 0$ that $\mathcal{E}_{k+1}^s \subset \mathcal{E}$.

We first assume that $\mathcal{E}_{k+1}^s \subset \mathcal{E}$ for some $s \geq 0$ and consider $T_g(\mathbf{t})$, a bigraph operation g with $k+1$ vertices evaluated in a g -colored tensor product \mathbf{t} with $s+1$ non reduced elements. Without loss of generality, we can assume the first graph t_1 is not reduced. We will denote $t_1 \in \mathbb{C}\mathcal{G}^{(d_1)}\langle \mathcal{A}_{\gamma(1)} \rangle$. If the rank d_1 of t_1 is one, then we can write $T_g(\mathbf{t}) = T_g((t_1 - \Phi(t_1)) \otimes t_2 \dots \otimes t_L) + \Phi(t_1)T_g((\cdot) \otimes t_2 \dots \otimes t_L) =: a + b$ where $a \in \mathcal{E}_{k+1}^s$ and $b \in \mathcal{E}_k$, so that $T_g(\mathbf{t}) \in \mathcal{E}$. If the rank of t_1 is greater than one, according to Lemma 2.11 we can write $t_1 = r + \sum_{i=1}^m x_i$, where $r \in \mathbb{C}\mathcal{G}^{(d_1)}\langle \mathcal{A}_{\gamma(1)} \rangle$ is a reduced graph polynomial and $x_1, \dots, x_m \in \mathbb{C}\mathcal{G}^{(d_1)}\langle \mathcal{A}_{\gamma(1)} \rangle$ are graph monomials having at least two outputs equal to the same vertex. Then, for any $i = 1, \dots, m$, $T_g(x_i \otimes t_2 \dots \otimes t_L) \in \mathcal{E}_k$ and $T_g(r \otimes t_2 \dots \otimes t_L) \in \mathcal{E}_{k+1}^s$, so that $T_g(\mathbf{t}) \in \mathcal{E}$. \square

Below, p denotes the operator defined in Lemma 2.11.

Corollary 2.14. *In the setting of Lemma 2.13, the linear space $\mathbb{C}\mathcal{G}^{(n)}\langle \bigsqcup_{j \in J} \mathcal{A}_j \rangle$ is generated by the n -graph polynomials of the form $T_g(p(m_1) \otimes \dots \otimes p(m_L))$, where $g \in \mathcal{B}_{alt}^{(n)}$ and $m_1 \otimes \dots \otimes m_L$ is a g -colored tensor product of monomials, such that outputs of the m_ℓ 's are pairwise distinct and T_g does not identify any pair of outputs of each input.*

Proof. Let $\mathbf{t}' = (t_1, \dots, t_L)$ be an arbitrary sequence of g -alternated, reduced graph polynomials and denote $t_\ell = \sum_i \alpha_i^{(\ell)} m_{i,\ell}$ where the $m_{i,\ell}$'s are graph monomials. Then we have

$$\begin{aligned} T_g(t_1 \otimes \dots \otimes t_L) &= T_g(p(t_1) \otimes \dots \otimes p(t_L)) \\ &= \sum_{i_1, \dots, i_L} \left(\prod_{\ell=1}^L \alpha_{i_\ell}^{(\ell)} \right) \times T_g(p(m_{i_1,1}) \otimes \dots \otimes p(m_{i_L,L})). \end{aligned}$$

By Lemma 2.13, we get that $\mathbb{C}\mathcal{G}^{(n)}\langle \bigsqcup_{j \in J} \mathcal{A}_j \rangle$ is generated by the elements of the form $T_g(p(m_1) \otimes \dots \otimes p(m_L))$, where $m_1 \otimes \dots \otimes m_L$ is a g -alternated tensor product of monomials. Moreover, if m has two outputs that are equal, then $p(m) = 0$. Hence one can assume that the outputs are pairwise distinct for each m_ℓ . \square

2.2.2 Solidity, validity and primitivity

This section contains most of the arguments of the proof of Theorem 2.8 and it introduces tools that will be used later, in particular in Section 3.3 to prove the positivity of the free product.

In the first statement, we see how the reducedness of n -graph polynomials for $n \geq 2$ simplifies the computation of combinatorial traces (reducedness when $n = 1$ plays a role at the last stage of the proof). We shall need the following definition.

Definition 2.15. *Let \mathcal{A} be an ensemble and let $T = T_g(m_1 \otimes \cdots \otimes m_L)$ be a test graph in $\mathcal{T}\langle\mathcal{A}\rangle$, where g is a bigraph operation and $(m_1 \otimes \cdots \otimes m_L)$ is a tensor product of graph monomials, such that outputs of a same m_ℓ are pairwise distinct and the operation T_g does not identify any pair of outputs of each m_ℓ . Consider the graphs of the m_ℓ 's as subgraphs of T and denote*

- by V the vertex set of T ,
- by $\mathcal{O}_\ell \subset V$ the set of outputs of m_ℓ ,
- by $\pi|_{\mathcal{O}_\ell}$ the restriction of $\pi \in \mathcal{P}(V)$ on \mathcal{O}_ℓ , namely $\{B \cup \mathcal{O}_\ell, B \in \pi\}$,
- by $0_{\mathcal{O}_\ell}$ the partition of \mathcal{O}_ℓ made of singletons.

Consider a partition $\pi \in \mathcal{P}(V)$. For each ℓ in $\{1, \dots, L\}$, we say that m_ℓ is solid for π whenever $\pi|_{\mathcal{O}_\ell} = 0_{\mathcal{O}_\ell}$. In other words, in T^π there is no identification of outputs of the graph m_ℓ . In a context where there is no confusion about m_1, \dots, m_L , we simply say that π is solid, when m_ℓ is solid for π for any $\ell = 1, \dots, L$.

Beware that there is no uniqueness in the decomposition $T = T_g(m_1 \otimes \cdots \otimes m_L)$.

Lemma 2.16. *Let \mathcal{A} be an ensemble and let $h = T_g(t_1 \otimes \cdots \otimes t_L) \in \mathcal{CT}\langle\mathcal{A}\rangle$ be a 0-graph polynomial, where $g \in \mathcal{B}^{(0)}$ is a bigraph operation and*

- $t_\ell = m_\ell$ is a monomial if $n_\ell = 1$,
- $t_\ell = p(m_\ell)$ where m_ℓ is a monomial with pairwise distinct outputs if $n_\ell \geq 2$.

Let T denote the test graph $T_g(m_1 \otimes \cdots \otimes m_L) \in \mathcal{T}\langle\mathcal{A}\rangle$. Then the trace of h is the sum of the quotient graphs of T by solid partitions: with notations of Definition 2.15, one has

$$\tau[h] = \sum_{\substack{\pi \in \mathcal{P}(V) \\ \text{solid}}} \tau^0[T^\pi].$$

Proof. Without loss of generality, we can assume that the indices $\ell \in \{1, \dots, L\}$ such that $n_\ell \geq 2$ are $1, \dots, K$ for $K \leq L$. Let us denote $c_{\sigma_k} = \text{Mob}(0_{\mathcal{O}_k}, \sigma_k)$ for any $\sigma_k \in \mathcal{P}(\mathcal{O}_k)$ and any $k = 1, \dots, K$. Consider the graph $T_\sigma = T_g(m_1^{\sigma_1} \otimes \cdots \otimes m_L^{\sigma_L})$, with the convention that $m_\ell^{\sigma_\ell} = m_\ell$ if $\ell > K = 1$. The definition of p in Lemma 2.11 allows to write

$$\tau[h] = \sum_{\substack{\sigma_\ell \in \mathcal{P}(\mathcal{O}_\ell) \\ \forall \ell=1, \dots, K}} \left(\prod_{k=1}^K c_{\sigma_k} \right) \tau[T_\sigma].$$

Denoting by V_σ the vertex set of T_σ , the linearity of τ and the definition of the injective trace lead to

$$\tau[h] = \sum_{\substack{\sigma_\ell \in \mathcal{P}(\mathcal{O}_\ell) \\ \forall \ell=1, \dots, K}} \left(\prod_{k=1}^K c_{\sigma_k} \right) \sum_{\pi \in \mathcal{P}(V_\sigma)} \tau^0[T_\sigma^\pi]. \quad (2.3)$$

Recall that for two partitions π and π' of some set, $\pi \leq \pi'$ means that the blocks of π are included in blocks of π' . Given $\sigma_1, \dots, \sigma_L$ as above, forming a graph T_σ^μ with a choice of a partition μ of V_σ is equivalent to forming a graph T^π with a choice of a partition π of V with the restriction below.

1. We consider firstly for each $\ell = 1, \dots, L$ a partition π_ℓ of the vertex set V_ℓ of m_ℓ . We assume that π_ℓ does more identifications of outputs of m_ℓ than σ_ℓ : for any $\ell = 1, \dots, K$, one has $\pi_{\ell|\mathcal{O}_\ell} \geq \sigma_\ell$.
2. Given a collection $\Pi = (\pi_1, \dots, \pi_L) \in \prod_{\ell=1}^L \mathcal{P}(V_\ell)$ of partitions as in the previous point, we consider a partition π of V with same identification as the π_ℓ for vertices of the monomials: for any $\ell = 1, \dots, L$, one has $\pi_{V_\ell} \geq \pi_\ell$. We denote by $\mathcal{P}_\Pi(V)$ the set of partitions $\pi \in \mathcal{P}(V)$ with this condition.

We then obtain as expected, using the property of the Möbius map [29, Sections 3.6 and 3.7] in the third identity,

$$\begin{aligned}
\tau[h] &= \sum_{\substack{\sigma_\ell \in \mathcal{P}(\mathcal{O}_\ell) \\ \forall \ell=1, \dots, K}} \left(\prod_{k=1}^K c_{\sigma_k} \right) \sum_{\substack{\pi_\ell \in \mathcal{P}(V_\ell) \\ \forall \ell=1, \dots, L \\ \text{s.t. } \sigma_\ell \leq \pi_{\ell|\mathcal{O}_\ell} \\ \forall \ell=1, \dots, K}} \sum_{\pi \in \mathcal{P}_\Pi(V)} \tau^0[T^\pi] \\
&= \sum_{\substack{\pi_\ell \in \mathcal{P}(V_\ell) \\ \forall \ell=1, \dots, L}} \left(\prod_{k=1}^K \sum_{\substack{\sigma_k \in \mathcal{P}(\mathcal{O}_k) \\ \text{s.t. } \sigma_k \leq \pi_{k|\mathcal{O}_k}}} c_{\sigma_k} \right) \sum_{\pi \in \mathcal{P}_\Pi(V)} \tau^0[T^\pi] \\
&= \sum_{\substack{\pi_\ell \in \mathcal{P}(V_\ell) \\ \pi_{\ell|\mathcal{O}_\ell} = 0_{\mathcal{O}_\ell} \\ \forall \ell=1, \dots, L}} \sum_{\pi \in \mathcal{P}_\Pi(V)} \tau^0[T^\pi] = \sum_{\substack{\pi \in \mathcal{P}(V) \\ \pi_{|\mathcal{O}_\ell} = 0_{\mathcal{O}_\ell} \\ \forall \ell=1, \dots, L}} \tau^0[T^\pi].
\end{aligned}$$

□

The next lemma highlights an elementary property of the graph of colored components that we will use several times. We use the following terminology.

Definition 2.17. *We say that a partition π of the vertex set of $T \in \mathcal{T}\langle \bigsqcup_j \mathcal{A}_j \rangle$ is valid whenever $\mathcal{GCC}(T^\pi)$ is a tree.*

Lemma 2.18. *Let J be an index set and, for each $j \in J$, let \mathcal{A}_j be an ensemble. Let consider the data of*

- a test graph $T \in \mathcal{T}\langle \bigsqcup_j \mathcal{A}_j \rangle$ such that $\mathcal{GCC}(T)$ is not a tree,
- a valid partition π of the vertex set of T ,
- a simple cycle $\mathcal{C} : o_1, S_1, o_2, S_2, \dots, o_K, S_K$ of $\mathcal{GCC}(T)$, $K \geq 2$, where S_k is a colored component of T attached to the connectors o_k and o_{k+1} , with indices k modulo K (the o_k 's and S_k 's are pairwise distinct).

Then, identifying connectors o_k 's with their image in T , there exist at least two indices $k, k' \in \{1, \dots, K\}$ such that $o_k \sim_\pi o_{k+1}$ and $o_{k'} \sim_\pi o_{k'+1}$, with indices modulo K . If moreover $K \geq 4$ then there exist non consecutive such k, k' , i.e. one can choose $|k - k'| \geq 2$ with distance in $\mathbb{Z}/K\mathbb{Z}$.

In simple words, we cannot fold a cycle into a tree of colored components without pinching at least two colored components.

Proof. Given $\pi \in \mathcal{P}(V)$, the cycle \mathcal{C} on $\mathcal{GCC}(T)$ induces a closed path on $\mathcal{GCC}(T^\pi)$. Since $\mathcal{GCC}(T^\pi)$ is a tree, the closed path visits a subtree of $\mathcal{GCC}(T^\pi)$. This subtree has at least two leaves (vertices of degree one). They do not consist in connectors, since

colors are alternated along the cycle. Hence each leaf corresponds to one or several graphs S_k for which we have identified o_k and o_{k+1} . When $K \geq 4$ it is clear that we can choose separated connectors. Hence the result. \square

We deduce the following corollary which implies that traces of alternated bi-graph operations in reduced elements vanish, by a simple argument of linearity that is given explicitly in next section. .

Corollary 2.19. *Let J be an index set and, for each $j \in J$, let \mathcal{A}_j be an ensemble. Let $\tau : \mathbb{C}\mathcal{T}\langle \bigsqcup_j \mathcal{A}_j \rangle \rightarrow \mathbb{C}$ be a unital linear form such that τ is the free product of its restrictions on test graphs labeled in \mathcal{A}_j , $j \in J$. Let $h = T_g(t_1 \otimes \cdots \otimes t_L)$ in $\mathbb{C}\mathcal{T}\langle \bigsqcup_j \mathcal{A}_j \rangle$ where $g \in \mathcal{B}_{alt}^{(0)}$ and $(t_1 \otimes \cdots \otimes t_L)$ is g -colored and satisfies $t_\ell = m_\ell$ for $n_\ell = 1$ and $t_\ell = p(m_\ell)$ for $n_\ell \geq 2$ as in Lemma 2.16. Then if g is not a tree, $\tau[h] = 0$, and otherwise*

$$\tau[h] = \prod_{\ell=1}^L \tau[t_\ell],$$

where in the above formula we extend τ as a linear map $\tau : \bigoplus_{n \geq 0} \mathbb{C}\mathcal{G}^{(n)}\langle \mathcal{A} \rangle$ by forgetting the position of the outputs.

The proof of the corollary can be summarised as follows. Let $h = T_g(t_1 \otimes \cdots \otimes t_L)$ and $T = T_g(m_1 \otimes \cdots \otimes m_L)$ be as in the above corollary. By Lemma 2.16 and since τ is the free product of its restriction on the \mathcal{A}_j 's, one has $\tau[h] = \sum_{\pi} \tau^0[T^\pi]$, where the sum is over valid and solid partitions π . By Lemma 2.18 the set of such maps is empty if g is not a tree. The first part of the corollary is then a direct consequence of the lemmas. It will be enough to prove the following.

Lemma 2.20. *We say that a partition π of the vertex set of $T \in \mathcal{T}\langle \bigsqcup_j \mathcal{A}_j, j \in J \rangle$ is primitive whenever it satisfies one of the following equivalent properties:*

1. *the graph of colored components is preserved after a quotient by π : $\mathcal{GCC}(T^\pi) = \mathcal{GCC}(T)$;*
2. *for any vertices v, w of T belonging to different colored components such that $v \sim_\pi w$, the components of v and w in T have exactly one connector o in common and $v \sim_\pi o \sim_\pi w$;*
3. *the colored components m_1, \dots, m_L of T are solid for π and given its restriction $\Pi = (\pi|_{V_1}, \dots, \pi|_{V_L})$ on the vertex sets of the m_ℓ 's, it is the smallest partition of the set $\mathcal{P}_\Pi(V)$ constructed in the proof of Lemma 2.16.*

Let T be a test-graph such that $\mathcal{GCC}(T)$ is a tree and let π be a valid partition which is solid for the colored components of T . Then π is primitive.

The lemma implies that the trace of h is the sum of the injective trace of quotient graphs of T by primitive partitions. Denote by T_ℓ the test graph of t_ℓ and V_ℓ its vertex set. By multiplicativity with respect to the colored components in the definition of traffic independence, for any π primitive we have $\tau^0[T^\pi] = \prod_{\ell=1}^L \tau^0[T_\ell^{\pi_\ell}]$ where π_ℓ is the restriction of π to V_ℓ . Hence $\tau[h] = \prod_{\ell=1}^L \sum_{\pi_\ell} \tau^0[T_\ell^{\pi_\ell}]$ where the sums are over the solid partitions π_ℓ of V_ℓ with respect to m_ℓ . By Lemma 2.16 again, the sum of quotients of T_ℓ by solid partitions is $\tau[p(T_\ell)]$. Hence this last lemma implies the corollary.

Proof of Lemma 2.20. We prove that a solid partition π which is not primitive is not valid: that is if π does not identify outputs of a same m_ℓ but identifies vertices of different colored components in a non trivial way, then $\mathcal{GCC}(T^\pi)$ is not a tree. So let v and w be two vertices in different colored components and denote by $T_{v \sim w}$ the graph obtained from T by identifying v and w . Then T^π is a quotient of $T_{v \sim w}$, and we apply Lemma 2.18 to the graph $T_{v \sim w}$, the induced partition $\pi_{v \sim w}$ such that $T^\pi = (T_{v \sim w})^{\pi_{v \sim w}}$, and the cycle coming from the path between v and w . All colored components of this cycle are not solid, but only those that are attached to v and w , as we explain thanks to the enumeration below. Lemma 2.18 tells that $\pi_{v \sim w}$ is not valid if the cycle has length at least 4, which implies that π is not valid. The remaining case ($K = 2, 3$) are considered after the description of the different possibilities for $\mathcal{GCC}(T_{v \sim w})$, see Figure 5.

Say that a vertex of V_ℓ that is not an output is an internal vertex. A vertex which is not internal is associated to a connector. We decompose five alternatives:

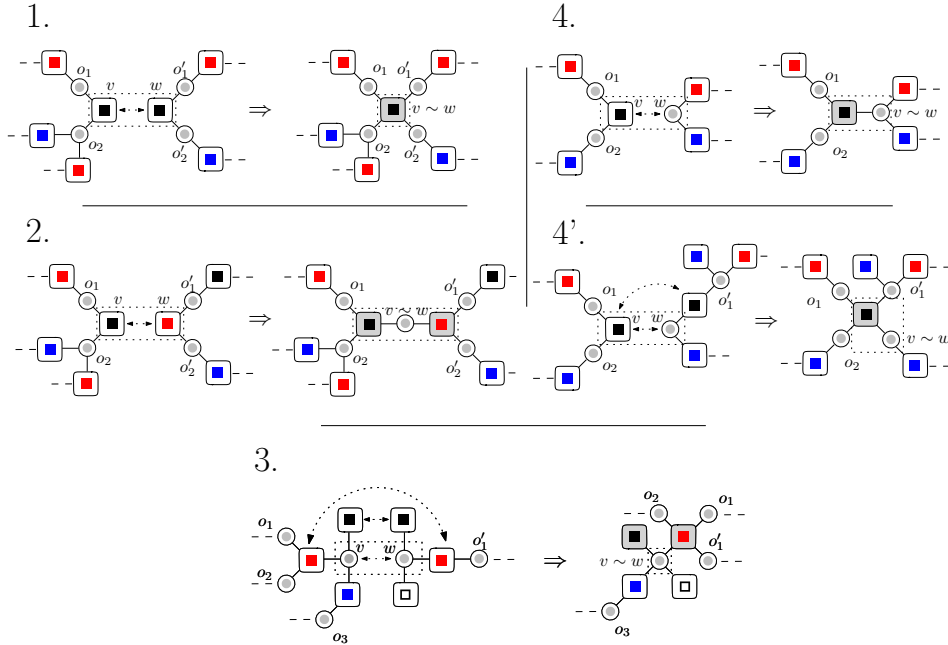

Figure 5: For each of the five items of the figure, the left-most picture is a local detail of the graph $\mathcal{GCC}(T)$. Square vertices represent inputs, circle vertices represent connectors, and the different colors for inputs represent different labels \mathcal{A}_j . They are two different parts of $\mathcal{GCC}(T)$ (on the left and on the right) that contain respectively the vertex v and w (inside the dotted rectangle) identified to give the right-most picture for each item. The right-most picture of each item is a detail of $\mathcal{GCC}(T_{v \sim w})$. They are different cases, depending if v and w are input or output vertices and on the colors of the input vertices. An input vertex is in grey when it is involved in the identification (it is not a colored component of the original graph T).

1. If v and w are internal vertices of components of the same color, then $\mathcal{GCC}(T_{v \sim w})$ is obtained by identifying these components in $\mathcal{GCC}(T)$.
2. If v and w are internal vertices of components of different colors, then $\mathcal{GCC}(T_{v \sim w})$ is obtained by creating a new connector between them in $\mathcal{GCC}(T)$.

3. If v and w are not internal vertices, then $\mathcal{GCC}(T_{v\sim w})$ is obtained by identifying them in $\mathcal{GCC}(T)$, then identifying the possible components of same colors attached to v and w , and then reducing the number of edges attaching them to the connectors from two to one. In general for a partition π of $\mathcal{P}(V)$, there may exist a component attached both to v and w (which results in other operations), but this is not possible if v and w do not belong to a same component.
4. If v is an internal vertex and w a connector that is not attached to a component of the same color as the one containing v , then $\mathcal{GCC}(T_{v\sim w})$ is obtained by putting an edge between the component of v and w in $\mathcal{GCC}(T)$.
- 4' If v is an internal vertex and w a connector attached to a component of the same color as the one containing v , then $\mathcal{GCC}(T_{v\sim w})$ is obtained by identifying these components in $\mathcal{GCC}(T)$.

Hence the path between v and w in T induces a cycle $\mathcal{C} : o_1, S_1, \dots, o_K, S_K$ on $\mathcal{GCC}(T_{v\sim w})$. The components S_1, \dots, S_K of $\mathcal{GCC}(T_{v\sim w})$ are the original components of $\mathcal{GCC}(T)$ except at most for two new components attached to a same connector (in grey in Figure 5). The partition π cannot be valid.

When $K = 2$, then a partition of the vertices of $T_{v\sim w}$ is possibly valid only if the two connectors of the cycle are identified, and so are the two outputs of the colored components S_1 and S_2 . At least one of the components is an original one, except if v and w are in the second situation in the above list: they are internal vertices of colored components of different colored, and a new connector appears in $T_{v\sim w}$. In that case the \mathcal{GCC} of a quotient of $T_{v\sim w}$ is a tree only if $v \sim w$ is identified with the connector between the initial components of v and w (this is the particular case). For $K = 3$, getting a tree needs at least one identification that reduces the problem to the case $K = 2$. This concludes the proof of the corollary. \square

2.2.3 End of the proof

We can now achieve the proof of Theorem 2.8. To start with, we prove that the first two properties are equivalent. Assume first that the $\mathcal{A}_j, j \in J$, are independent and let us prove that every alternated 0-bigraph polynomial in reduced elements is centered using the preliminary results of the section. By Lemma 2.13 and Corollary 2.14, it is sufficient to consider $h = T_g(t_1 \otimes \dots \otimes t_L) \in \mathcal{CT}\langle \bigsqcup_j \mathcal{A}_j \rangle$ where $g \in \mathcal{B}_{alt}^{(0)}$ and $t_1 \otimes \dots \otimes t_L$ g -colored such that $t_\ell = p(m_\ell)$ for a graph monomial m_ℓ for each $\ell = 1, \dots, L$. Without loss of generality, assume that the indices ℓ for which $n_\ell = 1$ are $1, \dots, K$ for $K \leq L$. For any $\mathbf{i} = (i_1, \dots, i_K)$ in $\{0, 1\}^K$, let $h_{\mathbf{i}}$ be the graph polynomial $T_g(\tilde{t}_1 \otimes \dots \otimes \tilde{t}_L)$ where

- $\tilde{t}_\ell = t_\ell$ if $\ell > K$,
- $\tilde{t}_\ell = m_\ell$ if $\ell \leq K$ and $i_\ell = 0$,
- $\tilde{t}_\ell = -\tau[m_\ell] \times (\cdot)$ if $\ell \leq K$ and $i_\ell = 1$, where (\cdot) is the 1-graph monomial with a single vertex and no edges,

in such a way one has $h = \sum_{\mathbf{i} \in \{0,1\}^K} h_{\mathbf{i}}$. We apply Corollary 2.19 to each $h_{\mathbf{i}}$: one has

$$\tau[h] = \mathbb{1}(g \text{ is a tree}) \times \prod_{\ell=1}^L \tau[p(T_\ell)],$$

where for $n_\ell = 1$ we denote $p(T_\ell) = T_\ell - \tau[T_\ell] \times (\cdot)$. Since a tree has leaves for which $\tau[p(T_\ell)] = 0$, we get $\tau[h] = 0$ as expected.

Reciprocally, let τ be an unital linear form on $\mathbb{C}\langle \bigsqcup_j \mathcal{A}_j \rangle$. Assume it satisfies $\tau[h] = 0$ for any h given by an alternated bigraph operation in alternated and reduced elements. Then by Lemma 2.13 and the previous paragraph, it coincides with the free product of the traffic distribution of the \mathcal{A}_ℓ 's on $\mathbb{C}\mathcal{T}\langle \bigsqcup_j \mathcal{A}_j \rangle$. Hence the \mathcal{G} -subalgebras \mathcal{A}_ℓ are independent.

The second and fourth items (the same property for 2-bigraph polynomials and w.r.t. the anti-trace Ψ) are equivalent since an element $h = T_g(t_1 \otimes \cdots \otimes t_L)$ of $\mathbb{C}\mathcal{G}^{(2)}\langle \mathcal{A} \rangle$ is an alternated bigraph operation in reduced elements if and only if the element $\tilde{h} = T_{\tilde{g}}(t_1 \otimes \cdots \otimes t_L)$ of $\mathbb{C}\mathcal{T}\langle \mathcal{A} \rangle$ is as well, where in \tilde{g} we forget the position of the input and output. We recall that $\Psi(h) = \tau(\tilde{h})$ by definition of Ψ .

The third item (the property for 2-bigraph polynomials and w.r.t. the trace Φ) implies the second one since if an element $h = T_g(t_1 \otimes \cdots \otimes t_L)$ of $\mathbb{C}\mathcal{T}\langle \mathcal{A} \rangle$ is an alternated bigraph operation in reduced elements, then so is the element $\tilde{h} = T_{\tilde{g}}(t_1 \otimes \cdots \otimes t_L)$ of $\mathbb{C}\mathcal{G}^{(2)}\langle \mathcal{A} \rangle$ obtained by declaring that a vertex is both the input and the outputs.

Assume now that the second item is satisfied and let us prove the third one. There we use again an argument of the previous section. Let $h = T_g(\mathbf{t})$ in $\mathbb{C}\mathcal{G}^{(2)}\langle \mathcal{A} \rangle$ where \mathbf{t} is g -alternated reduced and given by monomials $t_\ell = p(m_\ell)$ as usual. If the two outputs v and w of g are equal, then $g = \Delta(g)$ so $\Phi(h) = 0$. Assume the outputs are distinct, so that $\Delta(g)$ is possibly not alternated at the position where w and v are identified (Figure 5). We apply Lemma 2.18 to the graph $T_{v \sim w}$, any partition, and a cycle given by a path between v and w in T . As in the proof of Lemma 2.20, we get $\Phi(h) = 0$.

3 Products of traffic spaces

This section is mainly devoted to the construction of the free product of traffic spaces, in particular under the context where we assume a positivity condition for the combinatorial trace. In the last subsection we also consider the tensor product of traffic spaces which will be used a couple of times in Part II.

3.1 The free product of algebraic traffic spaces

Let us first consider an arbitrary ensemble X . The free \mathcal{G} -algebra generated by X is the space $\mathbb{C}\mathcal{G}\langle X \rangle$ generated by graph monomials whose edges are labeled by elements of X . It is endowed with the natural structure of \mathcal{G} -algebra given by the composition maps of the operad \mathcal{G} (Section 1.2.1): for any graph operation $g \in \mathcal{G}_K$ and any graph polynomials $g_1, \dots, g_K \in \mathbb{C}\mathcal{G}\langle X \rangle$ labeled in X ,

$$Z_g(g_1 \otimes \cdots \otimes g_K) = g(g_1, \dots, g_K),$$

where in the right hand side we identify the graph operation $g \in \mathcal{G}_K$ with the associated graph monomial in K variables. Hence $\mathbb{C}\mathcal{G}\langle X \rangle$ is well a \mathcal{G} -algebra.

Let $\tau : \mathbb{C}\mathcal{T}\langle X \rangle \rightarrow \mathbb{C}$ be an arbitrary linear map, unital in the sense that $\tau[(\cdot)] = 1$. Then it always induces a structure of algebraic traffic space on $\mathbb{C}\mathcal{G}\langle X \rangle$. To explain this fact, we first define a combinatorial trace $\tilde{\tau} : \mathbb{C}\mathcal{T}\langle \mathbb{C}\mathcal{G}\langle X \rangle \rangle \rightarrow \mathbb{C}$ as follow. For any test graph T labeled in $\mathbb{C}\mathcal{G}\langle X \rangle$ with $K \geq 1$ edges denoted e_1, \dots, e_K and labeled respectively by monomials g_1, \dots, g_K in $\mathbb{C}\mathcal{G}\langle X \rangle$, we set $\tilde{\tau}[T] = \tau[T_{\mathbf{g}}]$, where $T_{\mathbf{g}}$ is the graph labeled in X obtained from T by replacing the edge e_k by the graph g_k for any

$k = 1, \dots, K$. Then we extend $\tilde{\tau}$ by multi-linearity with respect to the edges and set $\tilde{\tau}[(\cdot)] = 1$.

Lemma 3.1. *The map $\tilde{\tau} : \mathbb{C}\mathcal{T}\langle\mathbb{C}\mathcal{G}\langle X \rangle\rangle \rightarrow \mathbb{C}$ satisfies the associativity property, and so endows $\mathbb{C}\mathcal{G}\langle X \rangle$ with a structure of algebraic traffic space.*

Proof. Let $T \in \mathcal{T}\langle X \rangle$ whose edges are denoted e_1, \dots, e_n , where e_1 has label $Z_h(g_1 \otimes \dots \otimes g_K) = h(g_1, \dots, g_K)$ and $e_i, i \geq 2$, has label g_{K+i-1} for graph monomials g_1, \dots, g_{K+n-1} labeled in X . We have by definition $\tilde{\tau}[T] = \tau[\tilde{T}]$ where \tilde{T} is the graph labeled in X obtained by replacing e_1 by $h(g_1, \dots, g_K)$ and $e_i, i \geq 2$, by g_{K+i-1} . But we have $\tau[\tilde{T}] = \tilde{\tau}[T_h]$, where T_h is the graph labeled in $\mathcal{G}\langle X \rangle$ obtained by replacing in T the edge e_1 by h . This implies the associativity property $\tilde{\tau}[T] = \tilde{\tau}[T_h]$. \square

Let now J be a labeling set and for each $j \in J$ let X_j be an ensemble. Recall that we denote by $\bigsqcup_{j \in J} X_j$ the set of couples (j, x) where $j \in J$ and $x \in X_j$. Assume that for each $j \in J$ we are given a unital linear map $\tau_j : \mathbb{C}\mathcal{T}\langle X_j \rangle \rightarrow \mathbb{C}$, and denote by $\tau : \mathbb{C}\mathcal{T}\langle \bigsqcup_{j \in J} X_j \rangle \rightarrow \mathbb{C}$ the free product of the $\tau_j, j \in J$. Denote by $\tilde{\tau}$ the combinatorial trace on $\mathbb{C}\mathcal{T}\langle \mathbb{C}\mathcal{G}\langle \bigsqcup_{j \in J} X_j \rangle \rangle \rightarrow \mathbb{C}$ induced by τ and by $\tilde{\tau}_j$ the restrictions of $\tilde{\tau}$ to the subspaces $\mathbb{C}\mathcal{T}\langle \mathbb{C}\mathcal{G}\langle X_j \rangle \rangle$ generated by test graphs whose labels are graphs labeled in $X_j, j \in J$.

Lemma 3.2. *The map $\tilde{\tau}$ is the free product of the $\tilde{\tau}_j$'s, $j \in J$. Hence the \mathcal{G} -subalgebras $\mathbb{C}\mathcal{G}\langle X_j \rangle, j \in J$ are traffic independent in $(\mathbb{C}\mathcal{G}\langle \bigsqcup_j X_j \rangle, \star_j \tau_j)$.*

This fact is proved in [16, Proposition 2.14], based only on the definition of traffic independence in terms of the injective trace. The proof of Theorem 2.8 is somehow a strengthening of this proof, and now the lemma is actually a direct consequence of the new characterization of traffic independence.

Proof. Let $h = T_g(t_1 \otimes \dots \otimes t_L)$ be an alternated bigraph operation in reduced elements labeled in $\bigsqcup_j \mathbb{C}\mathcal{G}\langle X_j \rangle$ and let us prove that $\tilde{\tau}[h] = 0$. Let $\tilde{t}_1 \otimes \dots \otimes \tilde{t}_L$ be the tensor product of elements labeled in $\bigsqcup_j X_j$ obtained as follow: for each graph t_ℓ , we replace each edge by the linear combination of the graphs that appear on their labels. By definition of $\tilde{\tau}$, we have $\tilde{\tau}[h] = \tau[\tilde{h}]$ where $\tilde{h} = T_g(\tilde{t}_1 \otimes \dots \otimes \tilde{t}_L)$. Moreover, \tilde{h} is still an alternated bigraph operation in reduced elements. By Corollary 2.19, we hence get $\tilde{\tau}[h] = 0$. \square

We can now define the free product of \mathcal{G} -algebras. The map $g \mapsto Z_g$ is extended for g by linearity for linear combinations of graph operations.

Definition 3.3. *For any family of \mathcal{G} -algebras $(\mathcal{A}_j)_{j \in J}$, we denote by $\star_{j \in J} \mathcal{A}_j$ the vector space $\mathbb{C}\mathcal{G}\langle \bigsqcup_{j \in J} \mathcal{A}_j \rangle$, quotiented by the following relations: for any $i \in J$, any $a_1, \dots, a_k \in \mathcal{A}_i, a_{k+1}, \dots, a_n \in \bigcup_{j \in J} \mathcal{A}_j$, any g in \mathcal{G}_{n-k+1} and any linear combination of graph operations h in \mathcal{G}_k ,*

$$\begin{aligned} Z_g(\cdot \xleftarrow{Z_h(a_1 \otimes \dots \otimes a_k)} \cdot \otimes \cdot \xleftarrow{a_{k+1}} \cdot \otimes \dots \otimes \cdot \xleftarrow{a_n} \cdot) \\ \sim Z_g(Z_h(\cdot \xleftarrow{a_1} \cdot \otimes \dots \otimes \cdot \xleftarrow{a_k} \cdot) \otimes \cdot \xleftarrow{a_{k+1}} \cdot \otimes \dots \otimes \cdot \xleftarrow{a_n} \cdot). \end{aligned}$$

This relation implies that, for a_1, \dots, a_K in a same algebra \mathcal{A}_i ,

$$Z_h(\cdot \xleftarrow{a_1} \cdot \otimes \dots \otimes \cdot \xleftarrow{a_K} \cdot) \sim (\cdot \xleftarrow{Z_h(a_1 \otimes \dots \otimes a_K)} \cdot),$$

and in particular, an edge labeled by the unit $(\cdot \xleftarrow{1_{\mathcal{A}}} \cdot)$ is equal to the graph with no edge (\cdot) . The other relations involving several algebras make the \mathcal{G} -algebra structure

of $\mathbb{C}\mathcal{G}\langle\coprod_{j \in J} \mathcal{A}_j\rangle$ compatible with this quotient (similar to the proof of Lemma 3.1). This allows to consider the \mathcal{G} -algebra homomorphisms $V_j : \mathcal{A}_j \rightarrow *_{j \in J} \mathcal{A}_j$ given by the image of $a \mapsto (\cdot \xleftarrow{a} \cdot)$ by the quotient map.

The \mathcal{G} -algebra $*_{j \in J} \mathcal{A}_j$ is the free product of the \mathcal{G} -algebras in the following sense.

Proposition 3.4. *Let \mathcal{B} be a \mathcal{G} -algebra, and $f_j : \mathcal{A}_j \rightarrow \mathcal{B}$ a family of \mathcal{G} -morphisms. There exists a unique \mathcal{G} -morphism $*_{j \in J} f_j : *_{j \in J} \mathcal{A}_j \rightarrow \mathcal{B}$ such that $f_j = (*_{j \in J} f_j) \circ V_j$ for all $j \in J$. As a consequence, the maps V_j are injective.*

Proof. The existence is given by the following definition of $*_{j \in J} f_j$ on $\mathbb{C}\mathcal{G}^{(2)}\langle\coprod_{j \in J} \mathcal{A}_j\rangle$:

$$*_{j \in J} f_j(g(\cdot \xleftarrow{a_1} \cdot, \dots, \cdot \xleftarrow{a_n} \cdot)) = g(f_{j(1)}(a_1), \dots, f_{j(n)}(a_n))$$

whenever $a_1 \in \mathcal{A}_{j(1)}, \dots, a_n \in \mathcal{A}_{j(n)}$. It obviously respects the relation defining $*_{j \in J} \mathcal{A}_j$.

The uniqueness follows from the fact that $*_{j \in J} f_j$ is uniquely determined on $\bigcup_j V_j(\mathcal{A}_j)$ (indeed, $*_{j \in J} f_j(a)$ must be equal to $f_j(b)$ whenever $a = V_j(b)$) and that $\bigcup_j V_j(\mathcal{A}_j)$ generates $*_{j \in J} \mathcal{A}_j$ as a \mathcal{G} -algebra. \square

We now construct the free product of algebraic traffic spaces.

Proposition 3.5. *Let $(\mathcal{A}_j, \tau_j)_{j \in J}$ be a family of algebraic traffic spaces. Let $\tilde{\tau} : \mathbb{C}\mathcal{T}\langle\mathbb{C}\mathcal{G}\langle\coprod_{j \in J} \mathcal{A}_j\rangle\rangle \rightarrow \mathbb{C}$ be the unital linear map induced by $*_{j \in J} \tau_j : \mathbb{C}\mathcal{T}\langle\coprod_{j \in J} \mathcal{A}_j\rangle \rightarrow \mathbb{C}$ as in the first paragraph of the section. Then $\tilde{\tau}$ respects the quotient structure of $*_{j \in J} \mathcal{A}_j$. Still denoting the quotient map $*_{j \in J} \tau_j : \mathbb{C}\mathcal{T}\langle*_{j \in J} \mathcal{A}_j\rangle \rightarrow \mathbb{C}$, we then get an algebraic traffic space $(*_{j \in J} \mathcal{A}_j, *_{j \in J} \tau_j)$ called the free product of the algebraic traffic spaces. Furthermore, we have $\tau_i = (*_{j \in J} \tau_j) \circ V_i$, where V_i is the canonical injective algebra homomorphism from \mathcal{A}_i to $*_{j \in J} \mathcal{A}_j$, and the \mathcal{A}_i , $i \in J$, are traffic independent in $(*_{j \in J} \mathcal{A}_j, *_{j \in J} \tau_j)$.*

Proof. Let $T \in \mathbb{C}\mathcal{T}\langle\mathbb{C}\mathcal{G}\langle\coprod_{j \in J} \mathcal{A}_j\rangle\rangle$ such that an edge e has label $(\cdot \xleftarrow{Z_h(a_1 \otimes \dots \otimes a_k)} \cdot)$, where $h = \sum_i a_i h_i$ is linear combination of graph operations labeled in a same \mathcal{A}_i . It suffices to prove that $\tilde{\tau}[T] = \tilde{\tau}[T_h]$, where $T_h = \sum_i a_i T_{h_i}$ with T_{h_i} the graph obtained by replacing e_1 by the graph h_i evaluated in $(\cdot \xleftarrow{a_1} \cdot, \dots, \cdot \xleftarrow{a_k} \cdot)$. But when decomposing T and T_h on $\mathbb{C}\mathcal{T}\langle\mathbb{C}\mathcal{G}\langle\coprod_{j \in J} \mathcal{A}_j\rangle\rangle$ according to the direct sum of Lemma 2.13, we get the same coefficient on $\mathbb{C}(\cdot)$. Since the \mathcal{G} -subalgebra are independent, $\tilde{\tau}[T]$ and $\tilde{\tau}[T_h]$ are equal to these constants and so they are equal. Hence $\tilde{\tau}$ respects the quotient structure defining $*_{j \in J} \mathcal{A}_j$. \square

3.2 Definition of positivity and traffic spaces

We first define an analogue of $*$ -algebras. On the set of graph operations \mathcal{G} , we define an *involution* $t : g \rightarrow g^t$, where g^t is obtained from g by reversing the orientation of its edges and interchanging the input and the output.

Definition 3.6. *A \mathcal{G}^* -algebra is a \mathcal{G} -algebra \mathcal{A} endowed with an anti-linear involution $* : \mathcal{A} \rightarrow \mathcal{A}$ which is compatible with the action of \mathcal{G} , in the following sense: for all K -graph operation g and $a_1, \dots, a_K \in \mathcal{A}$, $(Z_g(a_1 \otimes \dots \otimes a_K))^* = Z_{g^t}(a_1^* \otimes \dots \otimes a_K^*)$. A \mathcal{G}^* -subalgebra is a \mathcal{G} -subalgebra closed by adjoint. A \mathcal{G}^* -morphism between \mathcal{A} and \mathcal{B} is a \mathcal{G} -morphism $f : \mathcal{A} \rightarrow \mathcal{B}$ such that $f(a^*) = f(a)^*$ for any $a \in \mathcal{A}$.*

Recall that for any $n \geq 1$, a n -graph monomial is a test graph with the data of a n -tuple of vertices. Let g, g' be two n -graph monomials labeled in some set \mathcal{A} . We set $g|g'$ the test graph obtained by merging the i -th output of g and g' for any $i = 1, \dots, n$.

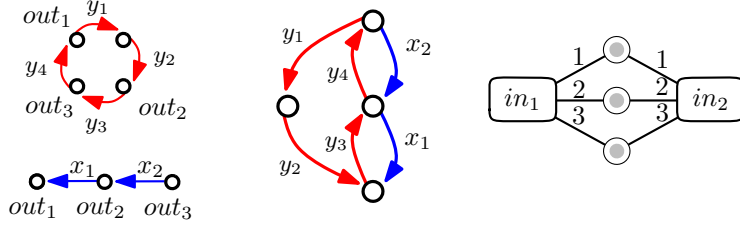

Figure 6: Left: two 3-graph monomials t and t' . Middle: the test graph $t'|t'$. Right: the bi-graph operation g such that $t'|t' = T_g(t \otimes t')$.

We extend the map $(g, g') \mapsto t|t'$ to a bilinear application $\mathbb{C}\mathcal{G}^{(n)}\langle\mathcal{A}\rangle^2 \rightarrow \mathbb{C}\mathcal{T}\langle\mathcal{A}\rangle$. Note that one can also realize $g|g'$ as a bigraph operation evaluated in $g \otimes g'$, see Figure 6.

Assume moreover that \mathcal{A} is endowed with an anti-linear involution $*$: $\mathcal{A} \rightarrow \mathcal{A}$. Given an n -graph monomial $g = (V, E, \gamma, \mathbf{v})$ we set $g^\dagger = (V, E^\dagger, \gamma^\dagger, \mathbf{v})$, where E^\dagger is obtained by reversing the orientation of the edges in E and with γ^\dagger given by $e \mapsto \gamma(e)^*$. Note that for $n = 2$, $g^\dagger(a_1 \otimes \cdots \otimes a_n) \neq g^t(a_1^* \otimes \cdots \otimes a_n^*)$ since there is no inversion of the two outputs in the definition of g^\dagger as in Definition 3.6. We extend the map $g \mapsto g^\dagger$ to an anti-linear map on $\mathbb{C}\mathcal{G}^{(n)}\langle\mathcal{A}\rangle$.

Definition 3.7. A traffic space is an algebraic traffic space (\mathcal{A}, τ) such that:

- \mathcal{A} is a \mathcal{G}^* -algebra,
- the combinatorial trace on \mathcal{A} satisfies the following positivity condition : for any $n \geq 1$ and any n -graph polynomials g labeled in \mathcal{A} ,

$$\tau[g|g^\dagger] \geq 0. \quad (3.1)$$

We call τ a combinatorial state.

A homomorphism between two traffic spaces is a \mathcal{G}^* -morphism which is a homomorphism of algebraic traffic space.

Note that (3.1) for $n = 2$ is equivalent to the positivity of the trace Φ induced by τ on the $*$ -algebra \mathcal{A} . Moreover, (3.1) for $n = 1$ implies the positivity of the anti-trace Ψ (Definition 1.12): indeed we have $\Psi[aa^*] = \tau[g|g^\dagger]$ where g is the 1-graph monomial with one simple edge whose source is the output.

By consequence, every traffic space (\mathcal{A}, τ) have two structures of $*$ -probability space (\mathcal{A}, Φ) and (\mathcal{A}, Ψ) (endowed with the product $Z_{\cdot, \underline{1}, \underline{2}}$). Positivity of τ implies the Cauchy Schwarz inequality $|\tau[t_1|t_2]| \leq \sqrt{\tau[t_1|t_1^\dagger]\tau[t_2|t_2^\dagger]}$.

Example 3.8. (Example 1.14 continued) The algebraic traffic space of random matrices is actually a traffic space since τ_N is positive. Indeed, recall that in Remark 2.3 for any n -graph monomial t labeled in J and a family $\mathbf{A}_N = (A_j)_{j \in J}$ we have defined a random tensor matrix $t(\mathbf{A}_N) \in (\mathbb{C}^N)^{\otimes n}$. The positivity is clear since one has

$$\tau_N[(t|t^\dagger)(\mathbf{A}_N)] := \mathbb{E}\left[\frac{1}{N} \sum_{\mathbf{i} \in [N]^n} t(\mathbf{A}_N)_{\mathbf{i}} \overline{t(\mathbf{A}_N)_{\mathbf{i}}}\right] \geq 0$$

Example 3.9. (Example 1.15 continued) The algebraic traffic space of a unimodular random graph is also a traffic space. As in the previous example, for a test graph

t and a family \mathbf{A} of infinite matrices we define an infinite tensor matrix $t(\mathbf{A})$ as in Remark 2.1 but with summation over $k : V \rightarrow \mathcal{V}$ with $k(r) = \rho$, for an arbitrary vertex r of V and with $(\xi_i)_{i \in \mathcal{V}}$ the canonical basis of $\mathbb{C}^{\mathcal{V}}$. The positivity of τ follows as well since

$$\tau_\rho[t(\mathbf{A})|t(\mathbf{A})^\dagger] := \mathbb{E}\left[\sum_{\mathbf{i} \in \mathcal{V}^n : i_1 = \rho} t(\mathbf{A})_{\mathbf{i}} \overline{t(\mathbf{A})_{\mathbf{i}}}\right] \geq 0.$$

We see now a consequence of the positivity, which will be an additional motivation for Part II. Let (\mathcal{A}, τ) be a traffic space and let $a_1, \dots, a_n \in \mathcal{A}$ such that $\Phi(a_1 \dots a_n) \neq 0$. Denote by T_1 the oriented simple cycle with n edges labeled $\dots \xleftarrow{a_i} \cdot \xleftarrow{a_{i+1}} \dots$ along the cycle. Let t_1 be a 1-graph monomial with test graph T_1 and whose output is an arbitrary vertex. With (\cdot) denoting the 1-graph monomial with no edge, we have

$$\Phi(a_1 \dots a_n) = \tau[T_1] = \tau[t_1|(\cdot)] \neq 0.$$

Then, since τ is positive, the Cauchy-Schwarz inequality gives

$$\left|\tau[t_1|(\cdot)]\right|^2 \leq \tau[t_1|t_1^\dagger] \times \tau[(\cdot)|(\cdot)] = \tau[t_1|t_1^\dagger].$$

Hence the test graph $T_2 = t_1|t_1^\dagger$ satisfies $\tau[T_2] \neq 0$. It consists in two simple cycles that share exactly one vertex. We iterate, assuming we have a test graph T_n such that $\tau[T_n] \neq 0$. Let t_n be a 1-graph monomial with test graph T_n and output an arbitrary vertex. Then $T_{n+1} = t_n|t_n^\dagger$ satisfies $\tau[T_{n+1}] \neq 0$. We have proved the following.

Lemma 3.10. *Let (\mathcal{A}, τ) be a traffic space such that τ is not constant to zero. Then τ is nonzero on an infinite number of cacti, that are test graphs such that each edge belong to a unique cycle (see Part II).*

In the second part of the monograph, given a non-commutative probability space (\mathcal{A}, Φ) we construct a traffic space (\mathcal{B}, τ) such that \mathcal{B} contains \mathcal{A} and the trace associated to τ and restricted on \mathcal{A} is Φ . The lemma shows that the naive answer for this question,

- $\tau[T] = \Phi(a_1 \dots a_n)$ if T is an oriented simple cycle with consecutive edges a_1, \dots, a_n ,
- $\tau[T] = 1$ for the test graph with no edge,
- and $\tau[T] = 0$ otherwise,

does not yield a positive combinatorial trace. There are no matrices converging to a traffic with such a simple distribution.

3.3 Positivity of the free product

For each $j \in J$, let (\mathcal{A}_j, τ_j) be a traffic space. By Section 3.1, we can consider the algebraic traffic space $(\star_{j \in J} \mathcal{A}_j, \star_{j \in J} \tau_j)$, the free product of the (\mathcal{A}_j, τ_j) 's. We shall now prove that $\tau := \star_{j \in J} \tau_j$ satisfies the positivity condition (3.1). Therefore, we give in Lemma 3.12 a structural result for the canonical space $\mathbb{C}\mathcal{G}^{(n)}\langle \bigsqcup_{j \in J} \mathcal{A}_j \rangle$, introduced in Definition 1.10. The ideas of the current section are inspired by the counterpart of this construction for the free product of unital algebras with identification of units (see [24, Chapter 6] and [24, Formula (6.2)]). The proofs build on the preliminary material presented in Section 2.2.

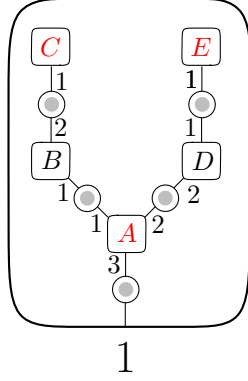

Figure 7: The above colored bigraph operation (g, γ) has a single non trivial automorphism σ , corresponding to vertical mirror symmetry.

Definition 3.11. Let us consider for $n \geq 1$ a colored bigraph operation $g \in \mathcal{B}_{col}^{(n)}$ (Definition 2.12). A bijection of the vertex set of g is called an automorphism of g if it preserves the adjacency, the bipartition, the ordered set of outputs and the coloring of g . Their set forms a group denoted Aut_g that acts on $\mathcal{B}_{col}^{(n)}$ and on the subspace $\mathcal{B}_{alt}^{(n)}$ of alternated colored bigraph operations with n outputs. The quotient space is denoted by $\tilde{\mathcal{B}}_{col}^{(n)}$ (resp. $\tilde{\mathcal{B}}_{alt}^{(n)}$) and the equivalent class of a colored bigraph operations $g \in \mathcal{B}_{col}^{(n)}$ is denoted by \bar{g} .

See figure 7 for an example. Note that an automorphism does not necessarily respect the ordering of the inputs nor the ordering of the neighbor connectors.

Every $\sigma \in Aut_g$ and every g -alternated tensor product $\mathbf{m} = (m_1 \otimes \cdots \otimes m_L)$ of graph monomials induces a new g -alternated tensor product $\mathbf{m}_\sigma = (m_{1,\sigma} \otimes \cdots \otimes m_{L,\sigma})$, such that $T_\sigma(\mathbf{m}) = T_g(\mathbf{m}_\sigma)$ by reordering the labels of the inputs and of neighbor connectors as follow (see Figures 7 and 8):

- if ℓ_v denotes the order of the input vertex v of g , then $m_{\ell_v,\sigma} = m_{\ell_{\sigma^{-1}(v)}}$,
- the order of neighbor connectors of an input of $m_{\ell,\sigma}$ is the order of its pre-image by σ .

We extend this definition by linearity for graph polynomials. Note that we have the property $(\mathbf{t}_{\sigma_1})_{\sigma_2} = \mathbf{t}_{\sigma_2\sigma_1}$ for all $\sigma_1, \sigma_2 \in Aut_g$. For every alternated bigraph operation g , the space $W_{\bar{g}}$ spanned by $T_g(\mathbf{t})$ for \mathbf{t} reduced and g -colored does not depends on g but only on the class $\bar{g} \in \tilde{\mathcal{B}}_{alt}^{(n)}$.

Lemma 3.12. Let (\mathcal{A}, τ) be a traffic space and \mathcal{A}_j , $j \in J$, be independent \mathcal{G} -subalgebras.

1. When considering the non-negative Hermitian form $\tau[\cdot | \cdot^\dagger]$ defined in (3.1), the space of graph-polynomials admits the orthogonal decomposition

$$\mathbb{C}\mathcal{G}^{(n)}\langle \bigsqcup_{j \in J} \mathcal{A}_j \rangle = \mathbb{C}(\cdot) \oplus^\perp \bigoplus_{\bar{g} \in \tilde{\mathcal{B}}_{alt}^{(n)}}^\perp W_{\bar{g}}.$$

2. If g is not a tree, then $W_{\bar{g}}$ is included in the kernel of $\tau[\cdot | \cdot^\dagger]$, that is for any $h \in W_{\bar{g}}$ and $h' \in \mathbb{C}\mathcal{G}^{(n)}\langle \bigsqcup_{j \in J} \mathcal{A}_j \rangle$, $\tau[h|h'] = 0$.

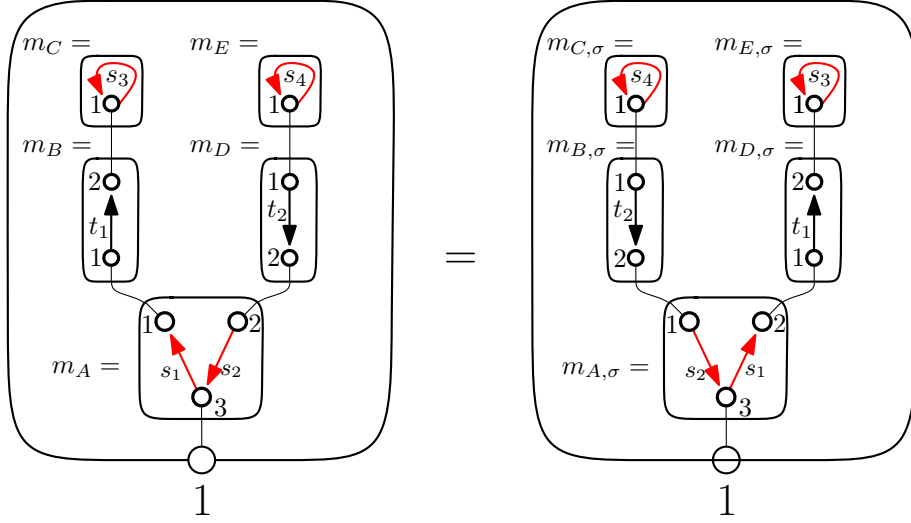

Figure 8: Illustration of the equality $T_g(\mathbf{m}) = T_g(\mathbf{m}_\sigma)$. With g the colored bigraph operation of Figure 7 and $(m_A \otimes \cdots \otimes m_E)$ a g -colored tensor product of graph monomials, then $(m_A \otimes \cdots \otimes m_E)_\sigma$ is obtained by exchanging m_B and m_D , m_C and m_E , and by permuting the outputs 1 and 2 of m_A , m_B and m_D .

3. If g is a tree, then for any $h = T_g(t_1 \otimes \cdots \otimes t_L)$, $h' = T_g(t'_1 \otimes \cdots \otimes t'_L)$ in W_g , we have

$$\tau[h|h'] = \sum_{\sigma \in \text{Aut}_g} \tau[t_1|t'_{1,\sigma}] \cdots \tau[t_L|t'_{L,\sigma}].$$

Example 3.13. With g consisting in a single path between two outputs, the only automorphism of g is the identity, and we then get the following formula: for any $L, L' \geq 2$, any $j_1 \neq j_2 \neq \cdots \neq j_L$ and $j'_1 \neq j'_2 \neq \cdots \neq j'_{L'}$ in J , and any $a_{j_\ell} \in \mathcal{A}_{j_\ell}$, $a'_{j'_\ell} \in \mathcal{A}_{j'_\ell}$, $\ell = 1, \dots, L$, $\ell' = 1, \dots, L'$, one has

$$\begin{aligned} & \Phi\left((a_{j_1} - \Delta(a_{j_1})) \cdots (a_{j_L} - \Delta(a_{j_L})) \times (a'_{j'_{L'}} - \Delta(a'_{j'_{L'}})) \cdots (a'_{j'_1} - \Delta(a'_{j'_1}))\right) = \\ & = \mathbb{1}(L = L', j_\ell = j'_\ell \forall \ell = 1, \dots, L) \prod_{\ell=1}^L \Phi\left((a_{j_\ell} - \Delta(a_{j_\ell})) \times (a'_{j'_\ell} - \Delta(a'_{j'_\ell}))\right). \end{aligned}$$

With g the colored bigraph operation of Figure 7, the automorphisms of g are the identity and the vertical mirror symmetry: hence for any $h = g(t_A \otimes \cdots \otimes t_E)$ where $(t_1 \otimes \cdots \otimes t_E)$ reduced and g -colored, one has

$$\tau[h|h] = \tau[t_A|t_A] \cdots \tau[t_E|t_E] + \tau[t_A|\tilde{t}_A] \tau[t_B|\tilde{t}_D] \tau[t_D|\tilde{t}_B] \tau[t_C|t_E]^2,$$

where \tilde{t}_X is obtained from t_X by permuting outputs 1 and 2 for $X \in \{A, B, D\}$.

Proof of Theorem 1.2. Assuming Lemma 3.12 for now, let us deduce Theorem 1.2. By Corollary 2.14, it suffices to prove that $\tau[h|h^\dagger] \geq 0$ for each finite combination $h = \sum_i \beta_i T_{g_i}(\mathbf{t}^i)$ for bigraph operations g_i and tensor products of reduced polynomials $\mathbf{t}^i = t_1^i \otimes \cdots \otimes t_{L_i}^i$, where $t_\ell^i = p(m_\ell^i)$ with a graph monomial m_ℓ^i . Moreover the previous lemma allows to restrict our consideration to the case where all g_i are in the equivalent class of one particular colored tree g and the color of m_ℓ^i depends only on ℓ , not on i .

In particular, the automorphism group of colored graph Aut_{g_i} is equal to Aut_g for any i . With this notation at hand, we can write

$$\begin{aligned}
\tau[h|h^\dagger] &= \sum_{i,j} \beta_i \bar{\beta}_j \tau[T_g(\mathbf{t}^i)|T_g(\mathbf{t}^j)^\dagger] \\
&= \frac{1}{\#Aut_g} \sum_{\substack{i,j \\ \sigma \in Aut_g}} \beta_i \bar{\beta}_j \tau[T_g(\mathbf{t}_\sigma^i)|T_g(\mathbf{t}_\sigma^j)^\dagger], \\
&= \frac{1}{\#Aut_g} \sum_{\substack{i,j \\ \sigma, \sigma' \in Aut_g}} \beta_i \bar{\beta}_j \tau[t_{1,\sigma}^i | t_{1,\sigma' \circ \sigma}^j] \cdots \tau[t_{L,\sigma}^i | t_{L,\sigma' \circ \sigma}^j]^\dagger, \\
&= \frac{1}{\#Aut_g} \sum_{\substack{i,j \\ \sigma, \sigma' \in Aut_g}} \beta_i \bar{\beta}_j \tau[t_{1,\sigma}^i | t_{1,\sigma'}^j] \cdots \tau[t_{L,\sigma}^i | t_{L,\sigma'}^j]^\dagger.
\end{aligned}$$

We shall now see that the r.h.s. is nonnegative. First, for any $\ell = 1, \dots, L$, the matrices $(\tau[t_{\ell,\sigma}^i | t_{\ell,\sigma'}^j]^\dagger)_{(i,\sigma),(j,\sigma')}$ are non-negative since τ is non-negative on each \mathcal{G} -subalgebra \mathcal{A}_j . Moreover, their entrywise product $(\tau[t_{1,\sigma}^i | t_{1,\sigma'}^j] \cdots \tau[t_{L,\sigma}^i | t_{L,\sigma'}^j]^\dagger)_{(i,\sigma),(j,\sigma')}$ is also non-negative ([24, Lemma 6.11]). This yields the positivity of above right-hand-side. \square

Proof of Lemma 3.12. According to Lemmas 2.13 and Corollary 2.14, in order to prove any of these three statements, it is enough to consider $\tau[h|h']$, where $h = T_g(\mathbf{t})$ and $h' = T_{g'}(\mathbf{t}')$, with $g, g' \in \mathcal{B}_{alt}^{(n)}$, $\mathbf{t} = t_1 \otimes \cdots \otimes t_L$ a g -colored tensor product, $\mathbf{t}' = t'_1 \otimes \cdots \otimes t'_{L'}$ a g' -colored tensor product, such that for each $\ell = 1, \dots, L, \ell' = 1, \dots, L'$, $t_\ell = p(m_\ell)$, $t'_{\ell'} = p(m'_{\ell'})$, where m_ℓ (respectively $m'_{\ell'}$) is n_ℓ -graph monomial (respectively a $n'_{\ell'}$ -graph monomial) whose outputs are pairwise distinct. It suffices to prove that $\tau[h|h'] = 0$ if g or g' is not a tree and if g and g' do not belong to the same class of alternated colored bigraph operations, and to prove the formula of the third statement.

Assume that the integers ℓ, ℓ' such that $n_\ell, n_{\ell'} = 1$ are $\{1, \dots, K\}$ and $\{1, \dots, K'\}$ respectively. For any multi-index $(\mathbf{i}, \mathbf{i}') = (i_1, \dots, i_K, i'_1, \dots, i'_{K'})$ in $\{0, 1\}^{K+K'}$, let $h_{\mathbf{i}, \mathbf{i}'}$ be the graph polynomial $T_g(\tilde{t}_1 \otimes \cdots \otimes \tilde{t}_L) | T_{g'}(\tilde{t}'_1 \otimes \cdots \otimes \tilde{t}'_{L'})$ where

- $\tilde{t}_\ell = t_\ell$ if $\ell > K$,
- $\tilde{t}_\ell = m_\ell$ if $\ell \leq K$ and $i_\ell = 0$,
- $\tilde{t}_\ell = (\cdot)$ if $i_\ell = 1$,

and $\tilde{t}'_{\ell'}$ is defined similarly, so that

$$h|h' = \sum_{(\mathbf{i}, \mathbf{i}') \in \{0, 1\}^{K+K'}} \prod_{\substack{\ell=1, \dots, K \\ \text{s.t. } i_\ell=1}} (-\tau[t_k]) \times \prod_{\substack{k'=1, \dots, K' \\ \text{s.t. } i'_{k'}=1}} (-\tau[t_{k'}]) \times h_{\mathbf{i}, \mathbf{i}'}. \quad (3.2)$$

We can apply Lemma 2.16 to each graph polynomial $h_{\mathbf{i}, \mathbf{i}'}$. Denote by $g_{\mathbf{i}}$ and $g'_{\mathbf{i}'}$ the colored bigraph operations obtained by erasing 1-graph monomials such that $i_\ell = 1$ and $i'_{\ell'} = 1$ respectively, and $g_{\mathbf{i}}|g'_{\mathbf{i}'}$ the bigraph operation obtained by identifying the i -th outputs of $g_{\mathbf{i}}$ and $g'_{\mathbf{i}'}$ for any $i = 1, \dots, n$. Denote by $(\tilde{t}_1 \otimes \cdots \otimes \tilde{t}_L \otimes \tilde{t}'_1 \otimes \cdots \otimes \tilde{t}'_{L'})_{\mathbf{i}, \mathbf{i}'}$

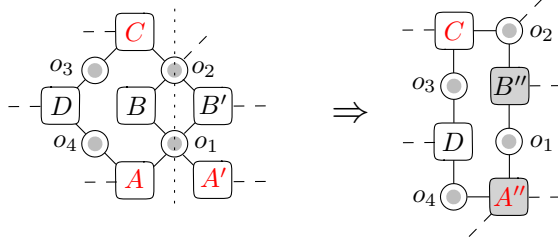

Figure 9: Left: a local detail of the bigraph operation $g_{\mathbf{i}}|g'_{\mathbf{i}'}$, with the vertical dotted line separating $g_{\mathbf{i}}$ and $g'_{\mathbf{i}'}$. Right: the bigraph operation $g_{alt,\mathbf{i},\mathbf{i}'}$. The sequence $A, o_1, B, o_2, C, o_3, D, o_4$ forms a simple cycle in g . Going from $g_{\mathbf{i}}|g'_{\mathbf{i}'}$ to $g_{alt,\mathbf{i},\mathbf{i}'}$, the inputs A and A' are identified. Yet, if a partition does not identify o_1 and o_4 in the leftmost picture, then it does not identify o'_1 and o_4 in the rightmost one.

the tensor product where 1-graph monomials are discarded when $\ell \leq K$ and $i_\ell = 1$ and $\ell' \leq K'$ and $i'_{\ell'} = 1$. Then we have the identity

$$h_{\mathbf{i},\mathbf{i}'} = T_{g_{\mathbf{i}}|g'_{\mathbf{i}'}}(\tilde{t}_1 \otimes \cdots \otimes \tilde{t}_L \otimes \tilde{t}'_1 \otimes \cdots \otimes \tilde{t}'_{L'})_{\mathbf{i},\mathbf{i}'},$$

and this graph polynomial satisfies the assumptions of Lemma 2.16. Hence, we get

$$\tau[h_{\mathbf{i},\mathbf{i}'}] = \sum_{\substack{\pi \in \mathcal{P}(V_{\mathbf{i},\mathbf{i}'}) \\ \text{solid}}} \tau^0[T_{\mathbf{i},\mathbf{i}'}^\pi], \quad (3.3)$$

where we denote

- the graph monomial $T_{\mathbf{i},\mathbf{i}'} = T_g(\tilde{m}_1 \otimes \cdots \otimes \tilde{m}_L) | T_g(\tilde{m}'_1 \otimes \cdots \otimes \tilde{m}'_{L'})$, with \tilde{m}_ℓ defined as \tilde{t}_ℓ with m_ℓ instead of t_ℓ in the first case,
- $V_{\mathbf{i},\mathbf{i}'}$ the vertex set of $T_{\mathbf{i},\mathbf{i}'}$,
- \mathcal{O}_ℓ and $\mathcal{O}'_{\ell'}$ are the sets of outputs of m_ℓ and $m'_{\ell'}$, respectively, seen in $V_{\mathbf{i},\mathbf{i}'}$ for $\ell > K, \ell' > K'$,
- $\pi|_{\mathcal{O}_\ell}$ and $\pi|_{\mathcal{O}'_{\ell'}}$ the restriction of π to these sets.

Solidity is with respect to the graph monomials $m_1, \dots, m_L, m'_1, \dots, m'_{L'}$ (out of 1-graph monomials such that $i_\ell = i'_{\ell'} = 1$). Note that these graphs are not the colored components of T , because of possible identifications between inputs of $g_{\mathbf{i}}$ and $g'_{\mathbf{i}'}$ that are neighbors of the outputs when forming $g_{\mathbf{i}}|g'_{\mathbf{i}'}$, as in the third example of Figure 5 of the previous section.

We first assume that g or g' is not a tree and prove that a solid partition is not valid, so we will conclude that $\tau[h|h'] = 0$ for any h' , as we expect. Note that for any \mathbf{i}, \mathbf{i}' , we have that $g_{\mathbf{i}}$ or $g'_{\mathbf{i}'}$ is not a tree. We apply Lemma 2.18 to $T_{\mathbf{i},\mathbf{i}'}$, any partition π solid w.r.t. the m_ℓ 's and $m'_{\ell'}$'s, and a cycle C on $\mathcal{GCC}(T_{\mathbf{i},\mathbf{i}'})$ coming from a simple cycle of $g_{\mathbf{i}}$. Note that C is indeed simple since identifications with inputs of g' do not change the cycle, see Figure 9. Solidity of the m_ℓ 's implies that there is no possible identifications of connectors neighbouring a same input on the cycle C . Hence π cannot be valid. From now on, we shall assume that g and g' are trees.

Let us use now the centering of 1-graph polynomials. Let $k = 1, \dots, K$ be an index such that $i_k = 0$ (m_k is in $g_{\mathbf{i}}$) and let π be a partition of $V_{\mathbf{i},\mathbf{i}'}$. We say that m_k is *isolated* by π whenever no vertex of m_k is identified with a vertex of another

colored component except in the trivial way for a vertex of a neighboring component identified with the connector linking them. We say that π is not isolating whenever no m_k nor $m'_{k'}$ is isolated, for $k = 1, \dots, K$ and $k' = 1, \dots, K'$. By the multiplicativity property w.r.t. the colored components in the definition of traffic independence, for any valid partition π

$$\tau^0[T_{\mathbf{i}, \mathbf{i}}^\pi] = \left(\prod_{\substack{\ell=1, \dots, L \\ \text{s.t. } m_\ell \text{ isolated}}} \tau^0[T_\ell^{\pi|V_\ell}] \times \prod_{\substack{\ell'=1, \dots, L' \\ \text{s.t. } m'_{\ell'} \text{ isolated}}} \tau^0[T_{\ell'}^{\pi|V'_{\ell'}}] \right) \times \tau^0[T_{\mathbf{j}, \mathbf{j}'}^{\pi|V_{\mathbf{j}, \mathbf{j}'}}],$$

where $(\mathbf{j}, \mathbf{j}') \in \{0, 1\}^{K+K'}$ is defined by $j_\ell = 1$ if and only if $i_\ell = 1$ or m_ℓ is isolated. Note that $\pi|_{V_{\mathbf{j}, \mathbf{j}'}}$ is not isolated. Hence, with the notations

- $\varepsilon(\mathbf{i}, \mathbf{i}') := \prod_{k=1}^K (-1)^{i_k} \prod_{k'=1}^{K'} (-1)^{i'_{k'}}$,
- $\alpha(\mathbf{i}, \mathbf{i}') = \prod_{k=1, \dots, K} \tau[t_k]^{i_k} \prod_{k'=1, \dots, K'} \tau[t'_{k'}]^{i'_{k'}}$,

we have

$$\begin{aligned} \tau[h] &= \sum_{(\mathbf{i}, \mathbf{i}')} \varepsilon(\mathbf{i}, \mathbf{i}') \times \left(\sum_{\substack{(\mathbf{j}, \mathbf{j}') \\ j_k \geq i_k \forall k \\ j'_{k'} \geq i'_{k'} \forall k'}} \alpha(\mathbf{i}, \mathbf{i}') \times \left(\sum_{\substack{\pi \in \mathcal{P}(V_{\mathbf{j}, \mathbf{j}'}) \\ \text{solid} \\ \text{non isolating}}} \tau^0[T_{\mathbf{j}, \mathbf{j}'}^\pi] \right) \right) \\ &= \sum_{(\mathbf{j}, \mathbf{j}')} \left(\sum_{\substack{(\mathbf{i}, \mathbf{i}') \\ i_k \leq j_k \forall k \\ i'_{k'} \leq j'_{k'} \forall k'}} \varepsilon(\mathbf{i}, \mathbf{i}') \right) \times \alpha(\mathbf{j}, \mathbf{j}') \sum_{\substack{\pi \in \mathcal{P}(V_{\mathbf{j}, \mathbf{j}'}) \\ \text{solid} \\ \text{non isolating}}} \tau^0[T_{\mathbf{j}, \mathbf{j}'}^\pi] \\ &= \sum_{\substack{\pi \in \mathcal{P}(V) \\ \text{solid} \\ \text{non isolating}}} \tau^0[T^\pi], \end{aligned} \tag{3.4}$$

where $T = T_{g|g}(m_1 \otimes \dots \otimes m_L \otimes m'_1 \otimes \dots \otimes m'_{L'})$ and V its vertex set. In words, the trace of h is the sum of the injective traces of quotients of T by solid and non isolating partitions.

On the other hand, we claim that the valid partitions of T solid w.r.t. the m_ℓ 's and $m'_{\ell'}$'s satisfy half of the primitivity property of Lemma 2.20: two vertices v and w of $T_{\mathbf{i}, \mathbf{i}'}$ that come from g_i (respectively from $g'_{i'}$) can be identified by a valid partition solid w.r.t. the m_ℓ 's only in the trivial situation: they belong to a same colored component, or they belong to neighboring components and are identified with the vertex that belong to both the components. Indeed, let us assume conversely that π is a solid partition that identifies v and w . We apply as usual Lemma 2.18 to the graph $(g_i)_{v \sim w}$, the induced partition, and the cycle given by a path between v and w in g . Solidity of the m_ℓ 's implies that there is no possible identifications of connectors which are neighbors of a same input, except possibly around $v \sim w$, see Figure 10. So π is not valid except in the trivial case.

We are now ready to prove that if $\tau[h] \neq 0$ then g and g' are isomorphic. Recall that we assume g and g' are trees. Let π be a valid and solid partition which does not isolate 1-graph monomials, as in Formula (3.4). Because of the argument of the previous paragraph, each 1-graph monomial of g must be identified with a single 1-graph monomial of g' , which defines a bijection σ between the leaves of g and g' . We now show that

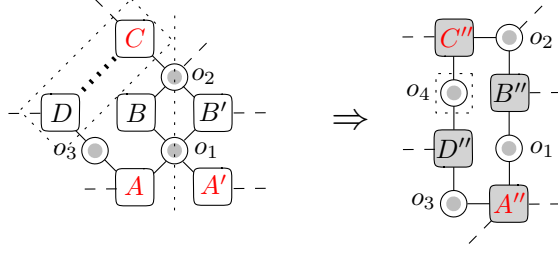

Figure 10: Left: the bigraph operation $g_i|g'_i$ with the dot rectangle representing the identification of two vertices. Right: the graph of colored components of $(S_{i,i'})_{v \sim w}$. Identifications $o_4 \sim_\pi o_3$ and $o_4 \sim_\pi o_3$ are possible since o_4 appeared while identifying v and w , but other identifications $o_2 \sim_\pi o_1$ and $o_1 \sim_\pi o_3$ are not possible if they are not allowed in the leftmost graph.

- for any $i_1, i_2 = 1, \dots, n$, the unique path from the i_1 -th to the i_2 -th outputs of g is isomorphic to the unique path between the same outputs in g' .
- if S and S' are two leaves of g and g' such that $\sigma(S) = \sigma(S')$, then for any $i = 1, \dots, n$, the unique path from S to the i -th output of g is isomorphic to the unique path from S' to the same output in g' ,

This clearly implies that g and g' must be isomorphic. For the first point, consider a simple path $\mathcal{D} : o_1, S_1, \dots, S_Q, o_{Q+1}$ between two outputs in g and the simple path $\mathcal{D}' : o'_1, S'_1, \dots, S'_{Q'}, o'_{Q'+1}$ in g' between the same outputs. We apply Lemma 2.18 to $T_{i,i'}$, a solid and valid partition π , and a cycle \mathcal{C} formed by identifying extremities of the paths. Denote by j_q the color of S_q and j'_q the one of S'_q . The inputs S_q, S'_q different from S_1, S'_1, S_Q, S'_Q are components of g or g' and they are therefore solid in π . The inputs S_1 and S'_1 are identified \mathcal{C} if and only if $j_1 = j'_1$, and the same holds for the last inputs S_Q and S'_Q . Hence necessarily they are the only pairs of identification. If $Q \geq 2$ and $Q' \geq 2$, we can iterate this reasoning on the graph obtained from $S_{i,i'}$ with these two identifications, see Figure 11. Hence the two colored paths \mathcal{D} and \mathcal{D}' are isomorphic: one has $Q = Q'$ and $j_q = j'_q$ for any $q = 1, \dots, Q$, and moreover the partition π identifies pairwise $o_k \sim_\pi o'_k$ for any $k = 1, \dots, K$. For the second point, the proof is the same with paths from the colored components to the outputs.

Valid partitions identifying pairwise a connectors of g with connectors of g' , the multiplicativity property in the definition of traffic independence yields the expected formula. \square

3.4 The tensor product of traffic spaces

Let J be an integer and for each $j = 1, \dots, J$, let (\mathcal{A}_j, τ_j) be an algebraic traffic space. We construct a traffic space $(\bigotimes_j \mathcal{A}_j, \bigotimes_j \tau_j)$, that contain each traffic space \mathcal{A}_j and such that the \mathcal{A}_j commute. Their algebraic tensor product $\bigotimes_j \mathcal{A}_j$ is indeed a \mathcal{G} -algebra with action of K -graph operations

$$\begin{aligned} Z_g((a_{1,1} \otimes \dots \otimes a_{1,J}) \otimes \dots \otimes (a_{K,1} \otimes \dots \otimes a_{K,J})) \\ = Z_g^{(1)}(a_{1,1} \otimes \dots \otimes a_{K,1}) \otimes \dots \otimes Z_g^{(J)}(a_{1,J} \otimes \dots \otimes a_{K,J}), \end{aligned}$$

for any $g \in \mathcal{G}_K$ and any $a_{k,j} \in \mathcal{A}_j$, where $Z^{(j)}$ denotes the action of graph operations on \mathcal{A}_j , $j = 1, \dots, J$. The tensor product of the combinatorial traces is defined, for

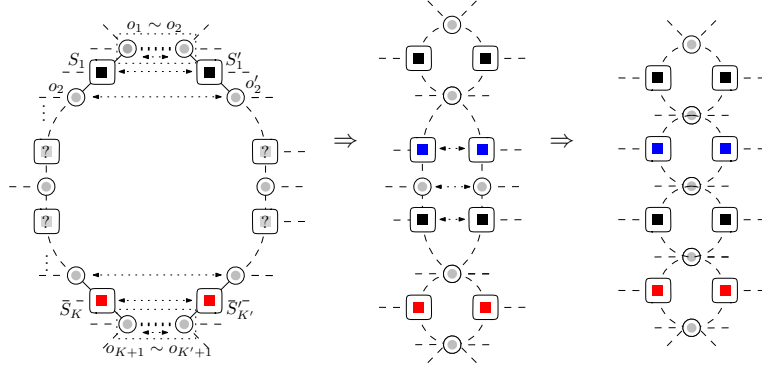

Figure 11: Left: two paths from the same outputs that form a simple cycle in $g|g'$. The pair of extremal inputs must be of a same color if a quotient whose \mathcal{GCC} is a tree exists. Such a quotient must be a quotient of the graph with identifications $o_2 \sim o'_2$ and $o_Q \sim o_{Q'}$, so we can iterate the reasoning.

any $T \in \mathcal{T}\langle \otimes_j \mathcal{A}_j \rangle$ whose edges are labeled by pure tensor products, by $\otimes_j \tau_j[T] = \tau_1[T_1] \cdots \tau_J[T_J]$, where T_j is obtained from T by replacing a label $a_1 \otimes \cdots \otimes a_J$ by a_j .

We will need later the following lemma.

Lemma 3.14. *The injective version of $\otimes_j \tau_j$ is given as follow. For any test graph $T \in \mathcal{T}\langle \otimes_j \mathcal{A}_j \rangle$, denote by Λ_T the set of J -tuples $(\pi_1, \dots, \pi_J) \in \mathcal{P}(V)^J$ such that if two elements belong to a same block of π_i then they belong to different blocks of π_j for some $j \neq i$. Then*

$$\left(\otimes_j \tau_j \right)^0 [T] = \sum_{(\pi_1, \dots, \pi_J) \in \Lambda_T} \tau_1^0 [T_1^{\pi_1}] \cdots \tau_J^0 [T_J^{\pi_J}].$$

Proof. We clearly have

$$\sum_{\pi \in \mathcal{P}(V)} \left(\sum_{(\pi_1, \dots, \pi_J) \in \Lambda_T \pi} \prod_{j=1}^J \tau_j^0 [T_j^{\pi_j}] \right) = \prod_{j=1}^J \sum_{\pi_j \in \mathcal{P}(V)} \tau_j^0 [T_j^{\pi_j}] = \otimes_j \tau_j [T].$$

This implies the expected result by uniqueness of Möbius transform. \square

If the spaces are traffic spaces, i.e. if the maps τ_j 's are positive, then their tensor product is also a traffic space by the usual argument of positivity of the Hadamard product [24, Lemma 6.11].

4 Conclusion of Part I and perspectives

Our initial motivation was to prove the positivity of traffic independence. This is indeed important since many statements about traffics involve the consideration of independent variables, for instance the law of large numbers and the central limit theorem. Doing so, we have discovered a natural characterization of traffic independence and understood more about the nature of this notion. In particular, Corollary 2.9 gives a tool to use traffic independence in order to prove the free independence of variables.

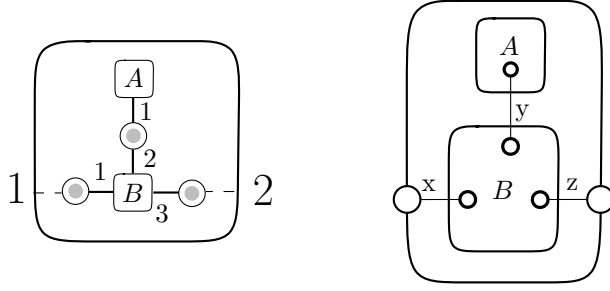

Figure 12: On the left, a bi-graph operation t , and on the right, the associated wiring diagram t' . The inputs of t (resp. its outputs) are represented by internal boxes (resp. by the external box). Connectors of t are represented by bonds between the boxes. Note that general wiring diagrams are not assumed to be connected.

In this section we would like to emphasize an aspect which is present in this analysis we hardly mentioned: the notion of traffics, made initially for the analysis of large matrices, can be generalized to cover the case of tensor matrices of arbitrary order. Whereas a matrix $A = (A_{i,j})_{i,j=1}^N \in M_N(\mathbb{C}) \sim \mathbb{C}^N \otimes \mathbb{C}^N$ is a collection of complex numbers labeled by two variables, a tensor matrix $A = (A_{\mathbf{i}})_{\mathbf{i} \in [N]^n} \in (\mathbb{C}^N)^{\otimes n}$, $n \geq 1$, is labeled by a multi-index $\mathbf{i} \in [N]^n$.

4.1 Operadic aspects: bigraph operations and wiring diagrams

Recall that $\mathcal{B} = \bigcup_{n \geq 0} \mathcal{B}^{(n)}$ denotes the set of bigraph operations. It is actually a so-called *colored operad*, encoding operations on objects of different kinds (the rank of the graph polynomials in the preceding sections). It is in bijection with the so-called operad of (undirected, connected) *wiring diagrams*, initially introduced by Rupel and Spivak [25] and developed in several variants in [27, 28, 30]. They have an important potential to model and design complex systems in many different disciplines, such as computer science and cognitive neuroscience. They are applied to study open dynamical systems, certain differential equations, databases recursions, plug-and-play circuits, etc. See [34] for an extended presentation of wiring diagrams. Formulating the notion of traffic independence is then a new application of wiring diagrams.

As for graph operations, we can define a notion of algebra over the operad \mathcal{B} of bigraph operations (or equivalently of wiring diagrams), in short \mathcal{B} -algebra. Since the operad is colored, a \mathcal{B} -algebra is a graded vector space $\mathcal{A} = \bigoplus_{n \geq 0} \mathcal{A}^{(n)}$ endowed with an action of the elements of \mathcal{B} as follows. For any bigraph operation $g \in \mathcal{B}_{L,\mathbf{d}}^{(n)}$, i.e. with L inputs and sequence of input degree $\mathbf{d} = (d_1, \dots, d_L)$, there is a linear map $T_g : \mathcal{A}^{(d_1)} \otimes \dots \otimes \mathcal{A}^{(d_L)} \rightarrow \mathcal{A}^{(n)}$ satisfying the following properties:

1. For the bigraph operation $id_n \in \mathcal{B}^{(n)}$ with n distinct outputs, a single input of degree n and such that the i -th neighbor of the input is the i -th output, one has $T_g = id_{\mathcal{A}^{(n)}}$,
2. $T_g(T_{g_1} \otimes \dots \otimes T_{g_L}) = T_{g(g_1, \dots, g_L)}$, for any $g \in \mathcal{B}_{L,\mathbf{d}}^{(n)}$ and $g_\ell \in \mathcal{B}^{(d_\ell)}$, $\ell = 1, \dots, L$,
3. $T_g(a_1 \otimes \dots \otimes a_L) = T_{g_\sigma}(a_{\sigma^{-1}(1)} \otimes \dots \otimes a_{\sigma^{-1}(L)})$ for any permutation σ that only permutes elements of same degree, where g_σ is as g with the i -th input becoming the $\sigma^{-1}(i)$ -th input.

The definition of Example 2.3 defines a structure of \mathcal{B} -algebra on the space of random variables with values on $\bigoplus_{n \geq 0} (\mathbb{C}^N)^{\oplus n}$.

Another operadic aspects of bigraph operations to be commented is about its relations with the work of Jones [15] on planar algebras. Firstly, we can mention that the action of graph operations on tensor matrices appears in this paper as a slight generalization of [15, Example 2.6]. Recall that a *combinatorial map*, i.e. a graph embedded into a surface such that the connected components of the complementary of the graph are isomorphic to discs. Then by a result of Heffter [14] a combinatorial map is a bigraph operation with no output such that each connector has degree two. It would be interesting to know if this set of observables is associated to some distributional symmetry of random tensor matrices.

4.2 Definition of traffics of arbitrary ranks and their independence

Most of the analysis provided for traffic spaces can be generalized *in extenso* in the context of \mathcal{B} -algebra. We briefly describe in this section this generalization.

Definition 4.1. *An algebraic traffic space of arbitrary rank is a pair (\mathcal{A}, τ) where $\mathcal{A} = \bigoplus_{n \geq 0} \mathcal{A}^{(n)}$ is a \mathcal{B} -algebra and τ is a linear form on $\mathcal{A}^{(0)}$ such that $\tau[\cdot] = 1$.*

The term *algebraic* can be dropped provided τ satisfies the positivity property of Section 3.2. Contrary to the rank two case, there is no need for associativity and multi-linearity properties for τ since there are encoded in the structure. An element of \mathcal{A}_n is called a traffic of rank n . Hence the theory of traffics is the theory of traffics of rank two. By Example 2.3, the space of tensor matrices is a traffic space of arbitrary rank.

Notions of \mathcal{B} -subalgebras and reduced elements are defined as for \mathcal{G} -algebras.

Definition 4.2. *The \mathcal{B} -subalgebras $\mathcal{A}_1, \dots, \mathcal{A}_L \subset \mathcal{A}$ are said to be independent whenever any bigraph operation in alternated reduced elements is centered.*

With minor modifications of the proof, we can prove the following extension of the asymptotic traffic independence theorem. Let $\mathbf{A}_1^{(N)}, \dots, \mathbf{A}_L^{(N)}$ be independent families of tensors, namely for each $\ell = 1, \dots, L$, $\mathbf{A}_\ell^{(N)} = (A_{\ell,j})_{j \in J_\ell}$ where $A_j \in (\mathbb{C}^N)^{\otimes n_j}$ for some $n_j \geq 1$. Assume the following properties:

1. For each $\ell = 1, \dots, L$, the family $\mathbf{A}_\ell^{(N)}$ is permutation invariant in law in the sense that for any permutation σ of $[N]$,

$$\mathbf{A}_\ell^{(N)} = (A_{\ell,j})_{j \in J_\ell} \stackrel{\mathcal{L}}{=} \left(A_{\ell,j}(\sigma(i_1), \dots, \sigma(i_{n_j}))_{i \in [N]^{n_j}} \right)_{j \in J_\ell}.$$

2. For any bigraph operation g of rank 0, the quantity $\mathbb{E}[T_g(\mathbf{A}_{\ell_1, j_1} \otimes \dots \otimes \mathbf{A}_{\ell_K, j_K})]$ converges as N goes to infinity for any compatible \mathbf{A}_{ℓ_k, j_k} .
3. One has the asymptotic factorization property:

$$\begin{aligned} & \prod_{i=1}^n \mathbb{E} \left[T_{g_i} (A_{\ell_1, i, j_{1,i}} \otimes \dots \otimes A_{\ell_{K_i}, i, j_{K_i, i}}) \right] \\ & - \mathbb{E} \left[\prod_{i=1}^n T_{g_i} (A_{\ell_1, i, j_{1,i}} \otimes \dots \otimes A_{\ell_{K_i}, i, j_{K_i, i}}) \right] \xrightarrow{N \rightarrow \infty} 0, \end{aligned}$$

for any g_1, \dots, g_n and any tensors such that the evaluation makes sense.

Then the families $\mathbf{A}_1^{(N)}, \dots, \mathbf{A}_L^{(N)}$ are asymptotically independent. This can be proved in two steps analogous to the random matrices case. The first determines the limit in terms of an analogue for the injective trace, following the argument of [16] for random matrices. The second characterises traffic independence in terms of the latter injective trace, replacing graph polynomials by elements of a \mathcal{B} -algebra (let us stress emphasis that this proof does not rely on the \mathcal{G} -algebra structure of traffic spaces).

4.3 Potential perspectives

Traffics of arbitrary ranks may be interesting to study new objects, e.g. simplicial complexes, in a similar fashion we study the non-commutative distributions of large random graphs. Moreover, it could also open new perspectives, for instance in the setting of Voiculescu's notion of bi-freeness [32]. Let (\mathcal{A}, Φ) be a $*$ -probability space such that Φ is a faithful state. Denote by H the closure of \mathcal{A} for the Hilbert norm $a \mapsto \sqrt{\Phi(aa^*)}$. There are two commuting actions of \mathcal{A} on H given by left and right multiplications. Recall that the theory of bi-freeness is about the relations of free operators from these two points of view. Let now (\mathcal{A}, τ) be a traffic space of arbitrary rank. Assume that τ is positive and for any $a \in \mathcal{A}^{(n)}$ one has $\|a\|_2 := \sqrt{\tau[a|a^\dagger]} = 0$ implies $a = 0$ (the definition of $a|a^*$ is the same as for $g|g^*$ in traffic spaces as it only involves bigraph operations). Consider the closure of $\mathcal{A}^{(n)}$ by $\|\cdot\|_2$. Then we have now n commuting actions of \mathcal{A} , one in the direction of each output, and so we can develop a theory of *multi-freeness* dedicated in the relations between these actions.

Part II

On the three types of traffics associated to non-commutative independences

Presentation

In [16] three types of traffics were identified, one for each notion of the three non-commutative notions independence.

Definition 4.3. Let (\mathcal{A}, τ) be an algebraic traffic space and let $\mathbf{a} = (a_j)_{j \in J}$ a family of elements of \mathcal{A} . We said that \mathbf{a} is of

- free type if it is unitarily invariant, in the sense that \mathbf{a} has the same traffic distribution as $\mathbf{uau}^* = (ua_ju^*)_{j \in J}$, where (u, u^*) is traffic independent of \mathbf{a} and limit of (U_N, U_N^*) for a Haar unitary random matrix U_N ;
- Boolean type if, for any $T \in \mathcal{T}\langle \mathcal{Y} \rangle$, one has $\tau[T] = 0$ if T is not a tree;
- tensor type if the traffics are diagonals, in the sense that $a_j = \Delta(a_j)$ for all $j \in J$.

The precise link with the usual notions of independences is given by [16, Theorem 5.5]:

- the traffic independence of traffics of *free type* implies the *free independence* with respect to the trace Φ of (\mathcal{A}, τ) ;
- the traffic independence of traffics of *Boolean type* implies the *Boolean independence* with respect to the anti-trace Ψ of (\mathcal{A}, τ) ;
- the traffic independence of traffics of *tensor type* implies the *tensor independence* with respect to the trace Φ of (\mathcal{A}, τ) ;

This section is mostly devoted to the study of traffics of free types. We give an explicit description of the injective distribution of traffics of this type, and we prove Theorems 1.1 and 5.7 about unitarily invariant random matrices.

More generally, we give, for each type of traffic, a characterization as a particular symmetry of the traffic distribution, a characterization with respect to the injective distribution, and for any non-commutative probability space we construct a canonical traffic space containing the initial space as a subalgebra of traffics of each type, under mild assumptions. The whole picture is contained in Section 9.

5 Generalities on unitarily invariant traffics

The canonical construction of free type consists in proving that any tracial non-commutative probability space (\mathcal{A}, Φ) can be realized as an algebra of unitarily invariant traffics. A crucial step is an explicit description of the distribution of traffics of this type, which is given in the two next sections.

5.1 Cacti and non crossing partitions

Recall that we call simple cycle of a graph a closed path visiting pairwise distinct vertices (orientation of the edges is ignored).

Definition 5.1. *A cactus is a finite connected graph such that each edge belongs exactly to one simple cycle. A well oriented cactus is a cactus such that the simple cycles of the graph are oriented.*

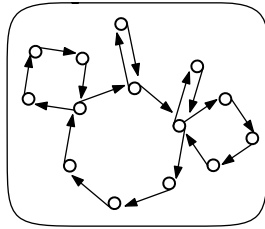

Figure 13: A well oriented cactus.

Well oriented cacti are related to non crossing partitions in the following way. Let T be a test graph consisting in a simple cycle with consecutive edges $(\cdot \xrightarrow{1} \cdots \xrightarrow{n} \cdot)$. Let σ be a non crossing partition of the set $E := \{1, \dots, n\}$ of edges of T . Let us denote by $V = \{1', \dots, n'\}$ the set of vertices of T , so that i' is neighbor of i and $i + 1$ with notation modulo n . The Kreweras complement $\hat{\sigma}$ of σ is the largest partition of V such that the partition $\sigma \sqcup \hat{\sigma}$ of $E \sqcup V$ is non crossing (with the convention $1 < 1' < 2 < \cdots < n < n'$).

Lemma 5.2. *For any partition π of V , the quotient T^π is a well oriented cactus if and only if there exists σ a non crossing partition of E such that $\pi = \hat{\sigma}$.*

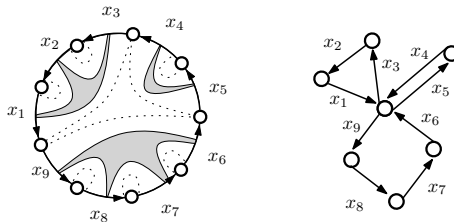

Figure 14: Left: A cycle of length nine, a non crossing partition ν of its edges (grey) and the Kreweras complement π (dotted) of ν . Right: the quotient of the cycle by π .

The Kreweras operation $\sigma \mapsto \hat{\sigma}$ is a bijection $\text{NC}(n) \rightarrow \text{NC}(n')$. Hence the content of the lemma is unchanged if we replace the sentence " $\exists \sigma \in \text{NC}(n)$ such that $\pi = \hat{\sigma}$ "

by " $\pi \in \text{NC}(n')$ ". There we emphasize the role of σ since this is how non crossing partitions play a role in free probability theory.

Proof. For any partition π of V , denote $\sigma(\pi)$ the partition of the edges of T such that $i \sim_{\sigma} i'$ if and only if i and i' belong to a same simple cycle of T . Note first that T^{π} is a cactus if and only if there exists at least one *isolated* simple cycle, that is a subgraph attached to the rest of the graph by a single vertex, and the graph without this simple graph is a cactus. Indeed, let \mathcal{G} be the (undirected) graph whose vertices are the simple cycles of T with an edge between two cycles for each vertex they have in common. Then T^{π} is a cactus if and only if \mathcal{G} is a tree. A leaf of this tree is a simple cycle with the expected property. On the other hand, σ is a non crossing partition if and only if there is at least one block of σ interval I of $[n]$ and the restriction of σ to $[n] \setminus I$ is non crossing (the proof is similar, see for instance [13, Property 17.9]). Since isolated simple cycles of T correspond to intervals of σ , we get the expected property. \square

Corollary 5.3. *Let (\mathcal{A}, τ) be an algebraic traffic space with trace Φ and let \mathbf{a} be a family of elements of \mathcal{A} . Assume that the injective distribution of \mathbf{a} is supported on well oriented cacti and is multiplicative w.r.t. their cycles, that is: for any test graph $T \in \mathcal{T}\langle \mathbf{a} \rangle$,*

$$\tau^0[T] = \mathbb{1}(T \text{ is a well oriented cactus}) \times \prod_C \tau^0[C],$$

where the product is over the simple cycles of T . Then for any simple cycle C with consecutive edges $(\cdot \xleftarrow{a_1} \dots \xleftarrow{a_n} \cdot)$ we have $\tau^0[C] = \kappa_n(a_1, \dots, a_n)$ where κ_n is the n -th free cumulant function relative to the trace Φ .

Proof. Let T denotes a simple cycle with consecutive edges $(\cdot \xleftarrow{a_1} \dots \xleftarrow{a_n} \cdot)$. Then the definition of Φ , the formula for τ^0 , and the lemma yield

$$\begin{aligned} \Phi(a_1 \dots a_n) &= \tau[T] = \sum_{\pi \in \mathcal{P}(V)} \mathbb{1}(T^{\pi} \text{ well oriented cactus}) \prod_C \tau^0[C] \\ &= \sum_{\sigma \in \text{NC}(n)} \prod_{C \in \sigma} \tau^0[C], \end{aligned}$$

with in the second line the abuse of notation that a cycle C with consecutive edges $(\cdot \xleftarrow{a_{i_1}} \dots \xleftarrow{a_{i_\ell}} \cdot)$ of a cactus $T^{\hat{\sigma}}$ is identified with the corresponding block $\{i_1, \dots, i_\ell\}$ of σ . Since τ^0 is multi-linear when seen as function of the labels of its edges, this property characterizes the free cumulants functions by Möbius inversion formula stated in Section 1.2.3. \square

The motivation to introduce this notion is that the traffic distribution of \mathbf{a} is completely determined by its non-commutative distribution in (\mathcal{A}, Φ) since free cumulants are determined by Φ . This is the starting point of the canonical construction which is developed in Section 8. Before stating this, we first present properties and example of such traffics.

5.2 Unitarily invariant traffics

Let us temporarily say that a family of traffics is *of cactus type* when its injective distribution is supported on well oriented cacti and multiplicative w.r.t. their cycles, as in Corollary 5.3. We characterize this ensemble of traffics in terms on the following distributional symmetry.

Definition 5.4. Let (\mathcal{A}, τ) be an algebraic traffic space and $\mathbf{a} = (a_j)_{j \in J}$ be a family of elements of \mathcal{A} . We say that \mathbf{a} is unitarily invariant if and only if it has the same traffic distribution as $u\mathbf{a}u^* = (ua_ju^*)_{j \in J}$, where (u, u^*) is traffic independent of \mathbf{a} and limit of (U_N, U_N^*) for a Haar unitary random matrix U_N .

Proposition 5.5. A family of traffics is unitarily invariant if and only if it is of cactus type.

The proof of the proposition is given in Section 6 and requires an analysis of the geometry of cacti and graph of colored components.

Corollary 5.6. Let (\mathcal{A}, τ) be an algebraic traffic space and let \mathbf{a} be a family of traffics of cactus type. Then the unital algebra spanned by \mathbf{a} is of cactus type.

Proof. Let $\mathbf{b} = (P_j(\mathbf{a}))_{j \in J}$ for some non-commutative polynomials P_j , $j \in J$. Then $u\mathbf{b}u^* = (P_j(u\mathbf{a}u^*))_{j \in J}$ has the same traffic distribution as \mathbf{b} , so it is of cactus type. \square

For all $N \geq 1$, let \mathbf{A}_N be a family of random matrices in $M_N(\mathbb{C})$. We recall that under the assumptions of Theorem 1.1 (the convergence in *-distribution and the asymptotic factorization of *-moments), \mathbf{A}_N converges in traffic distribution toward a unitarily invariant family.

Theorem 5.7. Under the above setting, the asymptotic factorization property holds for the traffic distribution: for all test graphs T_1, \dots, T_k , we have the following convergence

$$\begin{aligned} & \lim_{N \rightarrow \infty} \mathbb{E} \left[\frac{1}{N} \text{Tr}(T_1(\mathbf{A}_N)) \cdots \frac{1}{N} \text{Tr}(T_k(\mathbf{A}_N)) \right] \\ &= \lim_{N \rightarrow \infty} \mathbb{E} \left[\frac{1}{N} \text{Tr}(T_1(\mathbf{A}_N)) \right] \cdots \lim_{N \rightarrow \infty} \mathbb{E} \left[\frac{1}{N} \text{Tr}(T_k(\mathbf{A}_N)) \right]. \end{aligned} \quad (5.1)$$

The proof of Theorems 1.1 and 5.7 is given in Section 7 and is based on Weingarten calculus. Factorization property of *-moments is required to get the multiplicativity of the injective distribution with respect to the cycles of cacti as in Corollary 5.3. Let us give now some examples of large random matrices converging to traffics of free types.

Example 5.8. 1. A Haar unitary matrix U_N converges to a unitarily invariant traffic u in some traffic space (\mathcal{A}, τ) , and we can assume that u is unitary ($u^*u = uu^* = 1$), see [16]. Denote by Φ the trace associated to τ . It is known that in the non-commutative probability space (\mathcal{A}, Φ) , u is a *Haar unitary*, characterized by $\Phi(u^k(u^*)^\ell) = \mathbb{1}(k = \ell)$ for any $k, \ell \geq 0$. Recall that the only nonzero free cumulants of u are

$$\kappa_{2n}(u, u^*, \dots, u, u^*) = \kappa_{2n}(u^*, u, \dots, u^*, u) = c_{n-1}(-1)^{n-1}$$

where $c_n = \frac{2n!}{(n+1)!n!}$ are the Catalan numbers. In particular, the injective traffic distribution of u is supported on well oriented cacti whose cycles have even size and whose labels are alternated.

2. Let $X_N = \left(\frac{x_{i,j}}{\sqrt{n}}\right)_{i,j=1,\dots,N}$ be a complex Wigner matrix (the $x_{i,j}$ are independent and identically distributed along and out of the diagonal, the distribution of $x_{i,j}$ does not depend on N and admit moments of all orders). Assume the

entries are centered, invariant in law by complex conjugation ($x_{i,j} \stackrel{\text{law}}{=} \overline{x_{i,j}}$) and that $\mathbb{E}[|x_{i,j}|^2] = 1$, $\mathbb{E}[x_{i,j}^2] = 0$. Then X_N converges to a unitarily invariant traffic x in some traffic space (\mathcal{A}, τ) , and we can assume that x is self-adjoint ($x^* = x$), see [16]. It is known that in the non-commutative probability space (\mathcal{A}, Φ) , x is a *semicircular variable*, characterized $\Phi(a^k) = \mathbb{1}(k \text{ even})c_{k/2}$ for any k , where c_n are the n -th Catalan numbers. The only nonzero free cumulant of x is $\kappa_2(x, x) = 1$. In particular, the injective traffic distribution of x is supported on cacti whose cycles have size two (called the double trees in [16]).

3. An interest of the notion of unitarily invariant traffics is that it is not restricted to the limit of unitarily invariant matrices, as we have seen in the previous example with Wigner matrices. Matrices which are asymptotically unitarily invariant can even be more structured. For instance, convergence to a unitarily invariant semicircular traffic remains true when Wigner matrix models is generalized to Wigner matrices with intermediated exploding moments (like diluted Erdős-Reényi graphs) [17], for uniform regular graphs with large degree [18] (when restricting the traffic distribution to *cyclic test graphs*), periodic band Wigner matrices and band Wigner matrices with slow growth [2]. Hence, the properties of unitarily invariant traffic we state below are asymptotically true for these models.

5.3 Relation with freeness and large random matrices

5.3.1 Abstract statement

The following proposition motivates that unitarily invariant traffics are referred as traffics of *free type*.

Proposition 5.9. *Let (\mathcal{A}, τ) be an algebraic traffic space with trace Φ . For each $j \in J$ let \mathbf{a}_j be a family of traffics in \mathcal{A} and set $\mathbf{a} = \cup_j \mathbf{a}_j$. Let \mathbf{b} be an arbitrary family of traffics in \mathcal{A} .*

1. *If \mathbf{a}_j is unitarily invariant for each $j \in J$ and the \mathbf{a}_j 's are traffic independent then \mathbf{a} is unitarily invariant and the \mathbf{a}_j 's are free independent in (\mathcal{A}, Φ) .*
2. *Reciprocally if \mathbf{a} is unitarily invariant and the \mathbf{a}_j 's are free independent in (\mathcal{A}, Φ) then they are traffic independent in (\mathcal{A}, τ) .*
3. *If \mathbf{a} is unitarily invariant and is traffic independent from \mathbf{b} then \mathbf{a} and \mathbf{b} are freely independent in (\mathcal{A}, Φ) .*

Remark 5.10. For the first and third parts of the statement, it is sufficient to assume, instead of the unitary invariance of the \mathbf{a}_j 's that for any test graph T with no cutting edge, $\tau^0[T] = 0$ whenever T is not a cactus.

A proof of the proposition is given in [16, Section 5.2] based on the property of unitary invariance (Definition 5.4). For completeness, we give a proof using the cactus property.

Proof. 1. Let $T \in \mathcal{T}\langle \sqcup_j \mathbf{a}_j \rangle$. Under the assumptions of the proposition, we can write, using *w.o.* as a shortcut for *well oriented*,

$$\tau^0[T] = \mathbb{1}(\mathcal{GCC}(T) \text{ is a tree}) \prod_{S \in \mathcal{CC}(T)} \mathbb{1}(S \text{ w.o. cactus}) \prod_{C \text{ cycle of } S} \tau^0[C].$$

Let us say that a cactus T in variables $\mathbf{a} = \bigsqcup_j \mathbf{a}_j$ is well colored (in short w.c.) whenever each cycle of T is labeled by variables in a same family \mathbf{a}_j . Note that T is well colored if and only if σ is a non-mixing non crossing partitions, that is each of its blocks contain variables in a same family \mathbf{a}_j . Since the graph of colored components of a cactus is a tree if and only if it is well colored, we then get

$$\tau^0[T] = \mathbb{1}(T \text{ w.o.w.c. cactus}) \prod_{C \text{ cycle of } S} \tau^0[C]. \quad (5.2)$$

Moreover, let $C \in \mathcal{T}\langle \bigsqcup_j \mathbf{a}_j \rangle$ be a simple cycle with consecutive edges $(\cdot \xleftarrow{a_{i_1}} \dots \xleftarrow{a_{i_n}} \cdot)$, where the a_i are elements of the \mathbf{a}_j 's. The above formula yields

$$\Phi(a_{i_1} \dots a_{i_n}) = \tau[C] = \sum_{\substack{\sigma \in \text{NC}(n) \\ \text{non-mixing}}} \prod_{\{i_1 < \dots < i_\ell\} \in \sigma} \kappa_\ell(a_{i_1}, \dots, a_{i_\ell}),$$

which characterizes free variables. Moreover, this implies the correspondance between injective traces of well-oriented cycles and free cumulants. Hence, coming back to Equation (5.2) for general T we can write

$$\tau^0[T] = \mathbb{1}(T \text{ w.o. cactus}) \prod_{C \text{ cycle of } S} \tau^0[C]. \quad (5.3)$$

since for test graphs T that are not well colored, there are mixed cumulants along some cycles. Hence \mathbf{a} is of cactus type, so it is unitarily invariant.

2. Reciprocally, let us assume that \mathbf{a} is unitarily invariant and that the \mathbf{a}_j 's are free independent. Let us prove that they are traffic independent. Since \mathbf{a} is of cactus type, for any test graph $T \in \mathcal{T}\langle \bigsqcup_j \mathbf{a}_j \rangle$, Equation (5.3) is satisfied. Freeness of the \mathbf{a}_j 's implies vanishing of mixed cumulants, so that $\tau^0[C] = 0$ for some cycle if T is not a well colored cactus. But T is a w.o.w.c. cactus if and only if $\mathcal{GCC}(T)$ is a tree and the colored components are cacti. This yields the formula (5.2) and by the above computation that the \mathbf{a}_j 's are traffic independent.

3. Let now \mathbf{a} be a unitarily invariant family of traffics independent of an arbitrary family \mathbf{b} , and let us prove that \mathbf{a} and \mathbf{b} are free independent in (\mathcal{A}, Φ) . Without loss of generality, we can assume that the families of matrices contain the identity. By [24, Theorem 14.4], it suffices to prove that for any a_1, \dots, a_n in \mathbf{a} and any b_1, \dots, b_n in \mathbf{b} , the following is satisfied

$$\Phi(a_1 b_1 \dots a_n b_n) = \sum_{\sigma \in \text{NC}(n)} \kappa_\sigma(a_1, \dots, a_n) \times \Phi_{\hat{\sigma}}(b_1, \dots, b_n),$$

where $\hat{\sigma}$ is the Kreweras complement of σ , that is the largest non crossing partition of $\{1', \dots, n'\}$ such that $\sigma \sqcup \hat{\sigma}$ is a non crossing partition of $\{1, 1', \dots, n, n'\}$, and

$$\kappa_\sigma(a_1, \dots, a_n) = \prod_{\{i_1 < \dots < i_\ell\} \in \sigma} \kappa_\ell(a_{i_1}, \dots, a_{i_\ell}),$$

with a similar definition for $\Phi_{\hat{\sigma}}$.

Let T be a simple cycle with consecutive edges $(\cdot \xleftarrow{a_1} \cdot \xleftarrow{b_1} \dots \xleftarrow{a_n} \cdot \xleftarrow{b_n} \cdot)$. Then by definition of traffic independence and the cactus property of \mathbf{a} , denoting by V the

vertex set of T one has

$$\begin{aligned} \Phi(a_1 b_1 \dots a_n b_n) &= \tau[T] \\ &= \sum_{\pi \in \mathcal{P}(V)} \mathbb{1}(\mathcal{GCC}(T^\pi) \text{ is a tree}) \\ &\quad \times \left(\prod_{S \in \mathcal{CC}_b(T^\pi)} \tau^0[S] \times \prod_{S \in \mathcal{CC}_a(T^\pi)} \left(\mathbb{1}(S \text{ w.o. cactus}) \prod_{C \text{ cycle of } S} \tau^0[C] \right) \right), \end{aligned}$$

where $\mathcal{CC}_a(T)$ is the set of colored components of T labeled in \mathbf{a} , and $\mathcal{CC}_b(T)$ is defined similarly.

The arguments of the proof are those used in [17] (replacing the so-called *fat trees* by the cacti). Given $\pi \in \mathcal{P}(V)$, denote by $S_{\mathbf{a},\pi}$ the graph obtained from T^π by identifying the source and target of each edge labeled in \mathbf{b} and suppressing these edges. If $\mathcal{GCC}(T^\pi)$ is a tree and \mathcal{CC}_a is a set of cacti, then $S_{\mathbf{a},\pi}$ is a cactus. By Lemma 5.2, π induces a non crossing partition $\sigma_{\mathbf{a},\pi}$ of the set $E_{\mathbf{a}}$ of edges of T labeled \mathbf{a} , whose blocks are associated to variables labeled \mathbf{a} in a same cycle of T (the cyclic order of $E_{\mathbf{a}}$ is the one around the cycle T).

Reciprocally, consider a non crossing partition $\sigma_{\mathbf{a}}$ of $E_{\mathbf{a}}$ and then a cactus $S(\sigma_{\mathbf{a}})$ labeled \mathbf{a} . Let $\sigma_{\mathbf{b}} = \hat{\sigma}_{\mathbf{a}}$ be the Kreweas complement of $\sigma_{\mathbf{a}}$, which is a partition of the set $E_{\mathbf{b}}$ of edges of T labeled \mathbf{b} , and let $S(\sigma_{\mathbf{b}})$ denotes the cactus associated to $\sigma_{\mathbf{b}}$. Once more we consider the Kreweas complement of $\sigma = \sigma_{\mathbf{a}} \sqcup \sigma_{\mathbf{b}}$, which is now a partition $\pi_0 \in \mathcal{P}(V)$ of the vertex set of T . By Lemma 5.2, T^{π_0} and $S(\sigma_{\mathbf{b}})$ are cacti. Moreover, the partitions $\pi \in \mathcal{P}(V)$ such that $\mathcal{GCC}(T^\pi)$ is a tree, \mathcal{CC}_a is a set of cacti and $S_{\mathbf{a},\pi} = S(\sigma_{\mathbf{a}})$ are those that only identifies vertices in a same cycle of T^{π_0} labeled \mathbf{b} , which are the cycles of $S(\sigma_{\mathbf{b}})$, see Figure 15. Then we have, using that \mathbf{a} is of cactus type and the definition of τ^0 in the second line,

$$\begin{aligned} \tau[T] &= \sum_{\sigma_{\mathbf{a}} \in \mathcal{NC}(E_{\mathbf{a}})} \prod_{C_{\mathbf{a}} \text{ cycle of } S(\sigma_{\mathbf{a}})} \tau^0[C_{\mathbf{a}}] \times \prod_{C_{\mathbf{b}} \text{ cycle of } S(\hat{\sigma}_{\mathbf{a}})} \sum_{\pi \in \mathcal{P}(V(C_{\mathbf{b}}))} \tau^0[C_{\mathbf{b}}^\pi] \\ &= \sum_{\sigma_{\mathbf{a}} \in \mathcal{NC}(E_{\mathbf{a}})} \prod_{C_{\mathbf{a}} \text{ cycle of } S(\sigma_{\mathbf{a}})} \kappa(C_{\mathbf{a}}) \times \prod_{C_{\mathbf{b}} \text{ cycle of } S(\hat{\sigma}_{\mathbf{a}})} \Phi(C_{\mathbf{b}}), \end{aligned}$$

where $V(C_{\mathbf{b}})$ denoting the vertex set of $C_{\mathbf{b}}$, $\kappa(C)$ means the free cumulants $\kappa(x_1, \dots, x_\ell)$ for a cycle with consecutive edges (x_1, \dots, x_ℓ) , and $\Phi(C)$ is defined similarly. With this notation, this is the desired formula. \square

5.3.2 Asymptotic freeness of random matrices

The previous proposition implies a universal property of free independence for asymptotically unitarily invariant matrices.

Corollary 5.11. *Let $\mathbf{A}_j^{(N)}$, $j \in J$, be independent families of random matrices such for each $j \in J$,*

(H0) $U \mathbf{A}_j^{(N)} U^*$ has the same law as $\mathbf{A}_j^{(N)}$ for any permutation matrices U .

(H1) $\mathbf{A}_j^{(N)}$ converges in traffic distribution to a unitarily invariant family traffics.

(H2) $\mathbf{A}_j^{(N)}$ satisfies the factorization property (5.1).

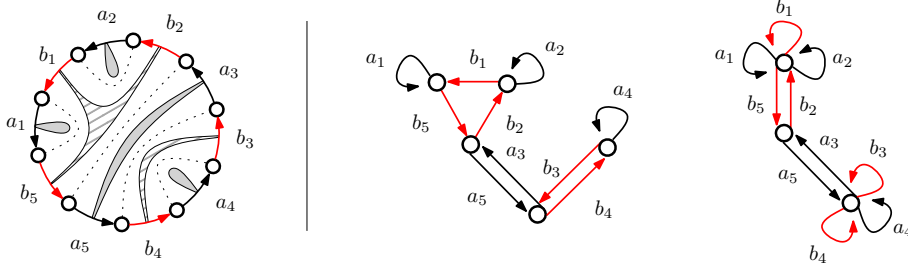

Figure 15: Left: the cycle T with a non crossing partition $\sigma_{\mathbf{a}}$ (full grey blocks), its kreweras complement $\sigma_{\mathbf{b}}$ (striped grey blocks), and the Kreweras complement π_0 of $\sigma_{\mathbf{a}} \sqcup \sigma_{\mathbf{b}}$ (dotted lines). Center and right: the quotient graph T^{π_0} , and another quotient graphs T^{π} such that S_{π} is the cactus of $\sigma_{\mathbf{a}}$.

Then the $\mathbf{A}_j^{(N)}$'s are asymptotically freely independent with respect to $\mathbb{E}[\frac{1}{N} \text{Tr}]$ and $\cup_j \mathbf{A}_j^{(N)}$ is asymptotically freely independent from any auxiliary independent family of random matrices converging in traffic distribution and satisfying (H2).

The *universal* aspect of this statement is that it holds for any auxiliary matrices, without assumptions on the form of their limiting traffic distribution.

Proof. The three first assumptions implies the asymptotic traffic independence by [16], so the corollary follows directly from Proposition 5.9. \square

One can work under a slightly weaker assumption than the convergence in traffics distribution of the matrices, since the conclusion is about non-commutative distribution. This is allowed by the modification of the asymptotic traffic independence theorem of [17]. Let us say that a test graph T is *cyclic* if there exists a cycle visiting each edge once in the sense of the orientation. For a family \mathbf{B}_N of matrices, we denote by $\|\mathbf{B}_N\|$ the supremum of the operation norm (square-root of the largest singular value) of the matrices of \mathbf{B}_N .

Corollary 5.12. *Let $\mathbf{A}_j^{(N)}$, $j \in J$, be independent families of random matrices such for each $j \in J$, $\mathbf{A}_j^{(N)}$ satisfies (H0) and the following modifications of the previous hypotheses:*

- (H1') $\mathbb{E}[\frac{1}{N} \text{Tr} T(\mathbf{A}_N)]$ converges for any cyclic test graph T and the limit satisfies the cactus formula.
- (H2') \mathbf{A}_N satisfies the factorization property on cyclic test graphs, and furthermore it satisfies the tightness condition of [17], for instance $\|\mathbf{A}_N\|$ is uniformly bounded as N goes to infinity.

Then the $\mathbf{A}_j^{(N)}$'s are asymptotically free independent and $\cup_j \mathbf{A}_j^{(N)}$ is asymptotically free independent from any independent family of random matrices converging in traffic distribution on cyclic test graphs and satisfying (H2').

For instance, a normalized adjacency matrix \mathbf{A}_N of a regular large graph with large degree may converges to a unitarily invariant traffics a on cyclic graphs (see [18]). It cannot converges to a on all test graphs since $\text{deg}(\mathbf{A}_N)$ is a constant matrix whereas $\text{deg}(a)$ is a non trivial random variable for a nonzero unitarily invariant traffic a .

Proof. The first assumptions implies the asymptotic traffic independence when distribution are restricted to cyclic graphs by [17]. Computation of trace of cyclic test graphs involves only computation of injective trace of cyclic graphs and reciprocally. Moreover the trace depends only on combinatorial traces of such graphs. Hence all the computation of the section is valid with this restriction. \square

6 Equivalence between unitary invariance and cactus type

This section is dedicated to the proof of Proposition 5.5.

6.1 On the geometry of cacti

Definition 6.1. • A cutting edge of a finite graph is an edge whose removal increases the number of connected component. A two-edge connected (t.e.c.) graph is a connected graph with no cutting edges.

- The cut number between two vertices is the minimal number of edges whose removal separate them.
- Two vertices of a graph form a 3-connection whenever there exist three edge-distinct paths joining them.

We will use Menger's theorem [19]:

Theorem 6.2. Let v and w two distinct vertices of a connected graph. The cut number between v and w is equal to the maximum number of edge-disjoint paths from v to w .

In particular, a 3-connection consists in vertices with cut number at least three. A t.e.c. graph is a graph whose vertices have cutting numbers at least two. We can then deduce the following characterization of cacti.

Proposition 6.3. A finite graph is a cactus if and only if the cut number between two vertices is constant, equal to two.

Proof. Let T be a finite graph with cut number constant to two. It is connected since the cut number is finite. There is no vertices v and w with cut number equal to one, so every edge $e = (v, w)$ is contained in a simple cycle. Moreover, if an edge e of a graph belongs to more than two distinct simple cycles, the union of these cycles with e remove is still t.e.c. so one can find a 3-connection in the graph. Hence T is a cactus.

Let now T be a cactus. The cut number between two vertices is greater than one since the graph is connected and each edge belong to a cycle. Moreover, the cut number between two vertices v and w is always two. Indeed, consider a simple path between v and w and remove one of its edges. In the cycle with this edge removed, we can remove an edge to separate v and w : the two vertices cannot be in a same connected component of the graph outside this cycle because the path between them is simple. \square

Let T be a test graph and let π be a partition of its vertices. Since edge-disjoint paths on T induce edge-disjoint paths on the quotient graph T^π , the cut number of two vertices v and w in T cannot decrease if v and w are not identified in T^π . This implies the following lemma.

Lemma 6.4. *Let T be a connected finite graph, let two vertices v, w forming a 3-connection, and let π a partition of the vertex set of T . If the quotient graph T^π is a cactus then $v \sim_\pi w$.*

We now deduce from this lemma three properties characterizing unitarily invariant traffics that we use in next section.

Corollary 6.5. *Let \mathbf{a} be a family of traffics of cactus type in an algebraic traffic space (\mathcal{A}, τ) . Let T be a test graph labeled in \mathbf{a} with two vertices v and w forming a 3-connection. Let $T_{v \sim w}$ be the test graph obtained by identifying v and w in T . Then one has $\tau[T] = \tau[T_{v \sim w}]$.*

In particular, by iterating this procedure, we get that $\tau[T] = \tau[\tilde{T}]$ where \tilde{T} is obtained by identifying all pairs of 3-connections. The cut number of pairs of vertices of \tilde{T} is always smaller than or equal to two.

Proof. If a quotient graph T^π of T is a cactus then $v \sim w$. Since τ^0 is supported on cacti Lemma 6.4 implies

$$\tau[T] = \sum_{\pi \in \mathcal{P}(V)} \tau^0[T^\pi] = \sum_{\substack{\pi \in \mathcal{P}(V) \\ v \sim_\pi w}} \tau^0[T^\pi] = \tau[T_{v \sim w}].$$

□

Corollary 6.6. *Let \mathbf{a} be a family of traffics of cactus type in an algebraic traffic space (\mathcal{A}, τ) . Let T be a test graph that can be obtained by identifying two vertices of test graphs S and S' , where S is t.e.c. Then*

$$\tau[T] = \tau[S] \times \tau[S'].$$

In particular, by iterating this procedure, we get that if T is a cactus then

$$\tau[T] = \prod_{C \text{ cycle of } T} \tau[C].$$

Proof. Denote by o the vertex of T that belong both to S and S' . Let v (resp. v') be a vertex of S (resp. S'), seen in T and different from o . Let π be a partition of T such that $v \sim_\pi v'$ and T^π is a cactus. Then T^π is a quotient of $T_{v \sim_\pi v'}$ for which (v, o) forms a 3-connection and so by Lemma 6.4 one has $v \sim_\pi o \sim_\pi v'$. Hence, each partition π such that T^π is a cactus is the union $\pi = \sigma \cup \sigma'$ of a partition σ of the vertices of S and a partition σ' of those of S' . For such a partition $\pi = \sigma \cup \sigma'$, by definition of cactus type traffics we have $\tau^0[T^\pi] = \tau^0[S^\sigma] \times \tau^0[(S')^{\sigma'}$. Hence we get, denoting by V_S and $V_{S'}$ the vertex sets of S and S' respectively,

$$\tau[T] = \sum_{\sigma \in \mathcal{P}(V_S)} \tau^0[S^\sigma] \times \sum_{\sigma' \in \mathcal{P}(V_{S'})} \tau^0[(S')^{\sigma'}] = \tau[S] \times \tau[S'].$$

□

It remains to show how to handle test graphs with cutting edges.

Lemma 6.7. *Let \mathbf{a} be a family of traffics of cactus type in an algebraic traffic space (\mathcal{A}, τ) . Let T be a test graph labeled in \mathbf{a} and denote by \mathcal{O} the set of vertices of T with odd degree (the degree is the number of neighbors, here we forget the orientation of the edges). For any partition σ of \mathcal{O} , let us denote*

$$p_\sigma(T) = \sum_{\sigma' \geq \sigma} \text{Mob}_{\mathcal{P}(\mathcal{O})}(\sigma, \sigma') T^{\sigma'},$$

where $\text{Mob}_{\mathcal{P}(\mathcal{O})}$ denotes the Möbius function of the poset of partitions of \mathcal{O} and T^σ the graph obtained by identifying vertices in a same block of T . Then one has

$$\tau[T] = \sum_{\substack{\sigma \in \mathcal{P}(\mathcal{O}) \\ |B| \text{ is even } \forall B \in \sigma}} \tau[p_\sigma(T)].$$

In particular, we get that $\tau[T]$ can be written as a linear combination of $\tau[S]$ where S has no cutting edges. Since the cutting number can always increase when taking quotients, together with the above lemmas, one gets an expression of $\tau[T]$ in terms of linear combinations of products of $\tau[C]$ where C are simple cycles.

Proof. Cacti have only vertices of even degree. Hence, if π is a partition such that T is a cactus then it must re-group the vertices in \mathcal{O} in blocks of even size. Hence

$$\tau[T] = \sum_{\substack{\sigma \in \mathcal{P}(\mathcal{O}) \\ |B| \text{ is even } \forall B \in \sigma}} \sum_{\substack{\pi \in \mathcal{P}(V) \\ \pi_{\mathcal{O}} = \sigma}} \tau^0[T^\pi].$$

By the same proof as Lemma 2.15 applied to T^σ , the second sum is nothing else than $\tau[p_\sigma(T)]$. \square

6.2 Proof of the equivalence

Let $\mathbf{a} = (a_j)_{j \in J}$ be an arbitrary family of traffics, independent from the limit (u, u^*) of a Haar unitary matrix and its conjugate, and denote $\mathbf{b} = (ua_ju^*)_{j \in J}$. We shall prove that \mathbf{a} and \mathbf{b} have the same traffic distribution.

For a test graph T labeled in \mathbf{b} we denote by \tilde{T} the graph labeled in \mathbf{a}, u, u^* obtained by replacing each edge $(\cdot \xleftarrow{b} \cdot)$ by the sequence of edges $(\cdot \xleftarrow{u} \cdot \xleftarrow{a} \cdot \xleftarrow{u^*} \cdot)$ and by \tilde{V} the vertex set of \tilde{T} . In this section, we say that a partition π of \tilde{V} is *valid* whenever $\mathcal{GCC}(\tilde{T}^\pi)$ is a tree and the colored components of \tilde{T}^π labeled in (u, u^*) are well oriented cacti whose edges along each cycle alternate between u and u^* .

Lemma 6.4 is replaced by the following.

Lemma 6.8. *If π is a valid partition then for any 3-connection (v, w) of \tilde{T} one has $v \sim_\pi w$.*

Proof. Let (v, w) be such a pair in \tilde{T} and π a valid partition. Assume moreover $v \not\sim_\pi w$ and let us find a contradiction. Let S_1, \dots, S_n be the path in $\mathcal{GCC}(\tilde{T})$ between the colored components S_1 and S_n containing v and w respectively. If $n \geq 2$, then one of these components is labeled in (u, u^*) and it is traversed by at least three edge disjoint paths, so it cannot be a cactus. If $n = 1$, then \tilde{T}^π has a cycle with an odd number of variables in u and u^* , so there are colored components labeled in (u, u^*) which are not cacti whose edges are labeled alternatively by u and u^* . \square

We now prove that the tree properties stated in Corollary 6.5, Corollary 6.6 and Lemma 6.7 hold for \mathbf{b} . By independence of \mathbf{a} and (u, u^*) and by the formula for the traffic distribution of (u, u^*) , we have

$$\begin{aligned} \tau[T] = \tau[\tilde{T}] &= \sum_{\pi \in \mathcal{P}(\tilde{V})} \mathbb{1}(\mathcal{GCC}(\tilde{T}^\pi) \text{ is a tree}) \prod_{S \in \mathcal{CC}_{\mathbf{a}}(\tilde{T}^\pi)} \tau^0[S] \\ &\times \prod_{S \in \mathcal{CC}_{(u, u^*)}(\tilde{T}^\pi)} \mathbb{1}(S \text{ w.o. cactus}) \prod_{C \text{ cycle of } S} \tau^0[S], \end{aligned}$$

where $\mathcal{CC}_{\mathbf{a}}$ and $\mathcal{CC}_{(u, u^*)}$ denote the set of colored components labeled in \mathbf{a} and (u, u^*) respectively.

The 3-connections of T correspond to those of \tilde{T} . Hence for any such pair (v, w) in T , we get $\tau[T] = \tau[\tilde{T}] = \tau[\tilde{T}_{v,w}] = \tau[T_{v,w}]$, so the first property is clear. The proof of the second property is similar: if T is a t.e.c. graph that can be obtained by identifying two vertices of disjoint test graphs S and S' , then \tilde{T} can be obtained by identifying two vertices \tilde{S} and \tilde{S}' and the proof is unchanged, using the above lemma instead of Lemma 6.4.

Let now T be an arbitrary test graph and denote by \mathcal{O} the set of vertices of odd degree. Corresponds in \tilde{T} a set $\tilde{\mathcal{O}}$. Moreover, denote by $\tilde{\mathcal{O}}'$ the set of vertices of \tilde{T} both adjacent to an edge labeled in \mathbf{a} and in (u, u^*) . If a partition π of the vertices of \tilde{T} is valid, it must regroup the vertices of $\tilde{\mathcal{O}} \cup \tilde{\mathcal{O}}'$ in blocks of even size (since vertices of considered cacti are of even degree). But if π identifies a vertex of $\tilde{\mathcal{O}}$ and a vertex of $\tilde{\mathcal{O}}'$, then T^π has a cycle with an odd number of edges in (u, u^*) , so π is not valid. We hence get

$$\tau[\tilde{T}] = \sum_{\substack{\sigma \in \mathcal{P}(\tilde{\mathcal{O}}) \\ |B| \text{ even } \forall B \in \sigma}} \tau[p_\sigma[\tilde{T}]] = \sum_{\substack{\sigma \in \mathcal{P}(\mathcal{O}) \\ |B| \text{ even } \forall B \in \sigma}} \tau[p_\sigma[T]].$$

Hence $\tau[T]$ has the same expression as if labels were in \mathbf{a} . Since for a simple cycle C labeled b_{j_1}, \dots, b_{j_n} one has $\tau[S] = \Phi(b_{j_1}, \dots, b_{j_n}) = \Phi(a_{j_1}, \dots, a_{j_n})$, we get as expected that \mathbf{a} and \mathbf{b} have the same traffic distribution.

7 Asymptotically unitarily invariant random matrices

The purpose of this section is to prove Theorems 1.1 and 5.7. Namely, for any unitarily invariant families of matrices \mathbf{X}_N satisfying the assumptions, for any test graphs T_1, \dots, T_m ,

$$\tau_{\mathbf{X}_N}(T_1, \dots, T_m) := \frac{1}{N^m} \mathbb{E} \left[\prod_{i=1}^m \text{Tr } T_i(\mathbf{X}_N) \right]$$

converges to

$$\prod_{i=1}^m \sum_{\pi \in \mathcal{P}(V_i)} \left(\mathbb{1}(T_i^\pi \text{ well oriented cactus}) \prod_{C \in \text{Cycle}(T_i^\pi)} \lim_{N \rightarrow \infty} \left(\tau_{\mathbf{X}_N}^0[C] \right) \right), \quad (7.1)$$

where V_i denotes the vertex set of T_i .

Before reviewing some results about the free cumulants, some results about the Weingarten function, and the links between those two objects in large dimension, let us mention two applications of this result.

7.1 Applications

Lemma 7.1. *If \mathbf{A}_N is a family of matrices converging in traffic distribution to a unitarily invariant family, then \mathbf{A}_N , \mathbf{A}_N^t and $(\deg(\mathbf{A}_N), \deg(\mathbf{A}_N^t))$ are asymptotically freely independent.*

This generalize a recent result of Mingo and Popa [20] stating the asymptotic free independence of \mathbf{A}_N and \mathbf{A}_N^t for unitarily invariant matrices. There we only assume that unitary invariance holds asymptotically.

Proof. Let (\mathcal{A}, τ) be an algebraic traffic space with trace Φ and let $\mathbf{a} = (a_j)_{j \in J}$ be a unitarily invariant family of traffics. It is sufficient to prove that the families \mathbf{a} , $\mathbf{a}^t = (a_j^t)_{j \in J}$ and $(\deg(\mathbf{a}), \deg(\mathbf{a}^t)) = (\deg(a_j), \deg(a_j^t))$ are free independent in (\mathcal{A}, Φ) .

We first prove that \mathbf{a} and \mathbf{a}^t are free. Let us consider $2n$ elements c_1, \dots, c_{2n} alternatively in $\mathbb{C}\langle \overset{a}{\leftarrow} \cdot : a \in \mathcal{A} \rangle$ and $\mathbb{C}\langle \cdot \overset{a}{\rightarrow} : a \in \mathcal{A} \rangle$ such that $\tau_\Phi(c_1) = \dots = \tau_\Phi(c_{2n}) = 0$. We want to prove that $\tau_\Phi(\Delta(c_1 \dots c_{2n})) = 0$. Using Proposition 8.3 in order to regroup consecutive edges which are oriented in the same direction, we can assume that the c'_i s are written as $\cdot \overset{a_i}{\leftarrow} \cdot$ with $a_i \in \mathcal{A}$ such that $\Phi(a_i) = 0$, and c_i and c_{i+1} not oriented in the same direction.

Consider now a partition π such that $\tau_\Phi^0(\Delta(c_1 \dots c_{2n})^\pi) \neq 0$. Then, take a leaf of the oriented cactus $\Delta(c_1 \dots c_{2n})^\pi$. This leaf is a cycle of only one edge, because if not, the cycle cannot be oriented, since two consecutive edges in $\Delta(c_1 \dots c_{2n})$ are not oriented in the same way. This produces a term $\tau_\Phi^0(\Delta(c_i)) = 0$ in the product $\tau_\Phi^0(\Delta(c_1 \dots c_{2n})^\pi)$, which leads at the end to a vanishing contribution. Finally, $\tau_\Phi(c_1 \dots c_{2n}) = 0$ and we have the freeness wanted.

Now, let us prove that $\mathbb{C}\langle \overset{a}{\uparrow} : a \in \mathcal{A} \rangle$ is free from $\mathbb{C}\langle \overset{a}{\leftarrow} \cdot, \cdot \overset{a}{\rightarrow} : a \in \mathcal{A} \rangle$. By the same argument as above, we can consider that we have a cycle $\Delta(c_1 \dots c_n)$ which consists in an alternating sequence of c'_i s written as $\cdot \overset{a_i}{\leftarrow} \cdot$ with $a_i \in \mathcal{A}$ such that $\Phi(a_i) = 0$, $\cdot \overset{a_i}{\rightarrow} \cdot$ with $a_i \in \mathcal{A}$ such that $\Phi(a_i) = 0$, and $c_i \in \mathbb{C}\langle \overset{a}{\uparrow} : a \in \mathcal{A} \rangle$ such that $\tau_\Phi(c_i) = 0$. We want to prove that $\tau_\Phi(\Delta(c_1 \dots c_n)) = 0$. If there is no term $c_i \in \mathbb{C}\langle \overset{a}{\uparrow} : a \in \mathcal{A} \rangle$, we are in the case of the previous paragraph. Let us assume that there exists at least one such term, say c_1 . By linearity, we can consider that the term $c_1 \in \mathbb{C}\langle \overset{a}{\uparrow} : a \in \mathcal{A} \rangle$ is written as $\overset{b_1}{\uparrow} \dots \overset{b_k}{\uparrow} \tau_\Phi(\overset{b_1}{\uparrow} \dots \overset{b_k}{\uparrow})$, where $\overset{b_1}{\uparrow} \dots \overset{b_k}{\uparrow}$ is some vertex input/output from which start k edges labelled by $b_1, \dots, b_k \in \mathcal{A}$. Let us prove that $\tau_\Phi(\Delta((\overset{b_1}{\uparrow} \dots \overset{b_k}{\uparrow})c_2 \dots c_n))$ and $\tau_\Phi(\overset{b_1}{\uparrow} \dots \overset{b_k}{\uparrow})\tau_\Phi(\Delta(c_2 \dots c_n))$ are equal, which implies by linearity that $\tau_\Phi(\Delta(c_1 \dots c_n)) = 0$. Decomposing into injective trace, we are left to prove that for all partition π of the vertices of $\Delta((\overset{b_1}{\uparrow} \dots \overset{b_k}{\uparrow})c_2 \dots c_n)$ which do not respect the blocks $(\overset{b_1}{\uparrow} \dots \overset{b_k}{\uparrow})$ and $\Delta(c_2 \dots c_n)$, $\tau_\Phi^0(\Delta((\overset{b_1}{\uparrow} \dots \overset{b_k}{\uparrow})c_2 \dots c_n)^\pi) = 0$. The same argument as previous paragraph works again. If one of the vertex of $(\overset{b_1}{\uparrow} \dots \overset{b_k}{\uparrow})$ is identified by π with one of the vertex of $\Delta(c_2 \dots c_n)$, and $\Delta((\overset{b_1}{\uparrow} \dots \overset{b_k}{\uparrow})c_2 \dots c_n)^\pi$ is a cactus there exists a cycle not oriented or a leaf labelled by one a_i , which leads to a vanishing contribution. \square

Lemma 7.2. *Let $\mathbf{A}_1^{(N)}, \dots, \mathbf{A}_L^{(N)}$ (resp. $\mathbf{B}_1^{(M)}, \dots, \mathbf{B}_L^{(M)}$) be independent families of N by N (resp. M by M) random matrices, that converge in traffic distribution to unitarily invariant variables and satisfy the factorization property as N (resp. M) goes to infinity. Let U_1, \dots, U_L be independent uniform permutation matrices of size $N \times M$. Assume that $(\mathbf{A}_\ell^{(N)})_{\ell=1, \dots, L}$, $(\mathbf{B}_\ell^{(M)})_{\ell=1, \dots, L}$ and $(U_\ell)_{\ell=1, \dots, L}$ are independent. Then the families $U_1(\mathbf{A}_1^{(N)} \otimes \mathbf{B}_1^{(M)})U_1, \dots, U_L(\mathbf{A}_L^{(N)} \otimes \mathbf{B}_L^{(M)})U_L$ are asymptotically freely independent with respect to $\frac{1}{NM} \text{Tr}$. If moreover \mathbf{C}_{NM} is a family of NM by NM random matrices that converge in traffic distribution and satisfies the factorization property, then it is asymptotically free independent from the previous families.*

Proof. For each $\ell = 1, \dots, L$, the family of matrices $\mathbf{A}_\ell^{(N)} \otimes \mathbf{B}_\ell^{(M)}$ converges in traffic distribution to the tensor product $\mathbf{a}_\ell \otimes \mathbf{b}_\ell$ of the limits of each factor, and it satisfy the factorization property. Hence by the asymptotic traffic independence theorem, the families of matrices $U_\ell(\mathbf{A}_\ell^{(N)} \otimes \mathbf{B}_\ell^{(M)})U_\ell$, $\ell = 1, \dots, L$, are asymptotically traffic independent.

On the other hand, let us compute the limiting distribution of each family. Let T be a test graph in $\mathcal{T}\langle \mathbf{a}_\ell \otimes \mathbf{b}_\ell \rangle$. Assume that it has not cutting edge, which is sufficient

to characterize the limiting *-distribution. Recall that we denote by Λ_T the set of pairs $(\pi_1, \pi_2) \in \mathcal{P}(V)^2$ such that if two elements belong to a same block of π_i then they belong to different blocks of π_j , $i \neq j \in \{1, 2\}$. We have by Lemma 3.14

$$(\tau_1 \otimes \tau_2)^0[T] = \sum_{(\pi_1, \pi_2) \in \Lambda_T} \tau^0[T_1^{\pi_1}] \times \tau^0[T_2^{\pi_2}],$$

where T_i is the graph whose edges are labeled the variables of the i -th factor.

If $(\pi_1, \pi_2) \in \Lambda_T$ contributes in the above term then T^{π_1} and T^{π_2} are cacti with oriented cycles. Since T is t.e.c., it is a cactus if and only if it has a 3-connection. But if T has a 3-connection, it must be identified to produce a cactus. Hence there is no (π_1, π_2) in Λ_T such that both $T_1^{\pi_1}$ and $T_2^{\pi_2}$ are cacti.

By Lemma 5.9 and Remark 5.10, we then get that the matrices are asymptotically freely independent. \square

7.2 The Weingarten function.

We need to integrate against the $U(N)$ -Haar measure. Expressions for these integrals appeared in [33] and were first proven in [7] and given in terms of a function on symmetric group called the Weingarten function. We recall here its definition and some of its properties. For any $n \in \mathbb{N}^*$ and any permutation $\sigma \in \mathcal{S}_n$, let us set

$$\Omega_{n,N}(\sigma) = N^{\#\sigma},$$

where $\#\sigma$ is the number of cycles of σ . When n is fixed and $N \rightarrow \infty$, $N^{-n}\Omega_{n,N} \rightarrow \delta_{\text{Id}_n}$. For any pair of functions $f, g : \mathcal{S}_n \rightarrow \mathbb{C}$ and $\pi \in \mathcal{S}_n$, let us define the convolution product

$$f \star g(\sigma) = \sum_{\pi \preceq \sigma} f(\pi)g(\pi^{-1}\sigma),$$

Hence, for N large enough, $\Omega_{n,N}$ is invertible in the algebra of function on \mathcal{S}_n endowed with convolution as a product. We denote by $\text{Wg}_{n,N}$ the unique function on \mathcal{S}_n such that

$$\text{Wg}_{n,N} * \Omega_{n,N} = \Omega_{n,N} * \text{Wg}_{n,N} = \delta_{\text{Id}_n}.$$

Then, [7, Corollary 2.4] says that, for any indices $i_1, i'_1, j_1, j'_1 \dots, i_n, i'_n, j_n, j'_n \in \{1, \dots, N\}$ and $U = (U(i, j))_{i,j=1, \dots, N}$ a Haar distributed random matrix on $U(N)$,

$$\mathbb{E}[U(i_1, j_1) \dots U(i_n, j_n) \bar{U}(i'_1, j'_1) \dots \bar{U}(i'_n, j'_n)] = \sum_{\substack{\alpha, \beta \in \mathcal{S}_n \\ i_{\alpha(k)} = i'_k, j_{\beta(k)} = j'_k}} \text{Wg}_{n,N}(\alpha\beta^{-1}). \quad (7.2)$$

7.3 Free cumulants and the Möbius function μ .

As explained in [5], it is equivalent to consider lattices of non-crossing partitions or sets of permutations endowed with an appropriate distance. For our purposes, it is more suitable to define the free cumulants using sets of permutations. Let us endow \mathcal{S}_n with the metric d , by setting for any $\alpha, \beta \in \mathcal{S}_n$,

$$d(\alpha, \beta) = n - \#(\beta\alpha^{-1}),$$

where $\#(\beta\alpha^{-1})$ is the number of cycles of $\beta\alpha^{-1}$. We endow the set \mathcal{S}_n with the partial order given by the relation $\sigma_1 \leq \sigma_2$ if $d(\text{Id}_n, \sigma_1) + d(\sigma_1, \sigma_2) = d(\text{Id}_n, \sigma_2)$, or similarly if σ_1 is on a geodesic between Id_n and σ_2 .

Given a state $\Phi : \mathbb{C}\langle x_j, x_j^* \rangle_{j \in J} \rightarrow \mathbb{C}$, we define the free cumulants $(\kappa_n)_{n \in \mathbb{N}}$ recursively on $\mathbb{C}\langle x_j, x_j^* \rangle_{j \in J}$ by the system of equations: $\forall y_1, \dots, y_n \in \mathbb{C}\langle x_j, x_j^* \rangle_{j \in J}$

$$\Phi(y_1 \cdots y_n) = \sum_{\sigma \leq (1 \cdots n)} \prod_{\substack{(c_1 \dots c_k) \\ \text{cycle of } \sigma}} \kappa(y_{c_1}, \dots, y_{c_k}). \quad (7.3)$$

Let us fix $y_1, \dots, y_n \in \mathbb{C}\langle x_j, x_j^* \rangle_{j \in J}$ and denote by respectively ϕ and k the functions from \mathcal{S}_n to \mathbb{C} given by

$$\phi(\alpha) = \prod_{\substack{(c_1 \dots c_k) \\ \text{cycle of } \sigma}} \Phi(y_{c_1} \cdots y_{c_k}) \quad \text{and} \quad k(\alpha) = \prod_{\substack{(c_1 \dots c_k) \\ \text{cycle of } \sigma}} \kappa(y_{c_1}, \dots, y_{c_k}),$$

which are such that $\phi((1 \cdots n)) = \sum_{\pi \leq (1 \cdots n)} k(\pi)$. In fact, we have more generally the relation

$$\phi(\alpha) = \sum_{\pi \leq \sigma} k(\pi).$$

Note that $\phi = k \star \zeta$, where ζ is identically equal to one. The identically one function ζ is invertible for the convolution \star (see [5]), and its inverse μ is called Möbius function. It allows us to express the free cumulants in terms of the trace:

$$k = \phi \star \mu. \quad (7.4)$$

7.4 Asymptotics of the Weingarten function.

One can observe that, for any pair of functions $f, g : \mathcal{S}_n \rightarrow \mathbb{C}$ and $\pi \in \mathcal{S}_n$,

$$\sum_{\pi \in \mathcal{S}_n} N^{d(\text{Id}_n, \sigma) - d(\text{Id}_n, \pi) - d(\pi, \sigma)} f(\pi) g(\pi^{-1} \sigma) = f \star g(\sigma) + o(1).$$

Defining the convolution \star_N as

$$\begin{aligned} f \star_N g &= N^n \Omega_{n,N}^{-1} ((N^{-n} \Omega_{n,N} f) * (N^{-n} \Omega_{n,N} g)) \\ &= \sum_{\pi \in \mathcal{S}_n} N^{d(\text{Id}_n, \sigma) - d(\text{Id}_n, \pi) - d(\pi, \sigma)} f(\pi) g(\pi^{-1} \sigma), \end{aligned}$$

it follows that \star is the limit of \star_N . Because $\text{Wg}_{n,N}$ is the inverse of $\Omega_{n,N}$ for the convolution $*$, we have $(N^{2n} \Omega_{n,N}^{-1} \text{Wg}_{n,N}) \star_N \zeta = N^{-n} \Omega_{n,N}$, from which we deduce that $(N^{2n} \Omega_{n,N}^{-1} \text{Wg}_{n,N}) \star \zeta = \delta_{\text{Id}_n} + o(1)$, or similarly that

$$N^{2n} \Omega_{n,N}^{-1} \text{Wg}_{n,N} = \mu + o(1).$$

More generally, if $f, f_N : \mathcal{S}_n \rightarrow \mathbb{C}$ are such that $f_N = f + o(1)$, then

$$N^n \Omega_{n,N}^{-1} ((\Omega_{n,N} f_N) * \text{Wg}_{n,N}) = (f_N) \star_N (\text{Wg}_{n,N}) = f \star \mu + o(1). \quad (7.5)$$

Proof of Theorem 1.1. Let $\mathbf{X}_N = (X_j)_{j \in J}$ a family of unitarily invariant random matrices which converges in $*$ -distribution, as N goes to infinity, to $\mathbf{x} = (x_j)_{j \in J}$ family of some non-commutative probability space (\mathcal{A}, Φ) . We fix $m \geq 1$ and test graph $T_i = (V_i, E_i, j_i) \in \mathcal{CT}\langle J \rangle, i = 1, \dots, m$, and show the convergence stated in (7.1).

By taking the real and the imaginary parts, we can assume that the matrices of \mathbf{X}_N are Hermitian and so we do not consider adjoint of the matrices. We shall denote by $T = (V, E, j)$ the labeled graph obtained from the disjoint unions of T_1, \dots, T_m , where the label map is given by restriction: $j|_{V_i} = j_i$ for $i = 1, \dots, m$.

We consider a random unitary matrix U , distributed according to the Haar distribution, and independent of \mathbf{X}_N . By assumption $\mathbf{Z}_N := U\mathbf{X}_N U^* \in M_N(\mathbb{C})$ has the same distribution as \mathbf{X}_N . We denote respectively by \underline{e} and \bar{e} the origin vertex and the goal vertex of e . Then

$$\begin{aligned} \tau_{\mathbf{X}_N}[T_1, \dots, T_m] &= \frac{1}{N^m} \sum_{\phi: V \rightarrow [N]} \mathbb{E} \left[\prod_{e \in E} Z_{j(e)}(\phi(\underline{e}), \phi(\bar{e})) \right] \\ &= \frac{1}{N^m} \sum_{\substack{\phi: V \rightarrow [N] \\ \varphi, \varphi': E \rightarrow [N]}} \mathbb{E} \left[\prod_{e \in E} U(\phi(\underline{e}), \varphi(e)) \bar{U}(\phi(\bar{e}), \varphi'(e)) \right] \mathbb{E} \left[\prod_{e \in E} X_{j(e)}(\varphi(e), \varphi'(e)) \right]. \end{aligned}$$

In the integration formula (7.2), the number n of occurrence of each term $U(i, j)$ is the cardinality of E and the sum over permutations of $\{1, \dots, n\}$ is replaced by a sum over the set \mathcal{S}_E of permutations of the edge set E . By identifying E with the set of integers $\{1, \dots, |E|\}$, we consider that $\text{Wg}_{n, N}$ is defined on \mathcal{S}_E instead of \mathcal{S}_n . Then, one has

$$\begin{aligned} \tau_{\mathbf{X}_N}[T_1, \dots, T_m] &= \frac{1}{N^m} \sum_{\alpha, \beta \in \mathcal{S}_E} \text{Wg}_{n, N}(\alpha\beta^{-1}) \sum_{\substack{\phi: V \rightarrow \{1, \dots, N\} \\ \varphi, \varphi': E \rightarrow \{1, \dots, N\} \\ \phi(\alpha(e)) = \phi(\bar{e}), \varphi(\beta(e)) = \varphi'(e)}} \mathbb{E} \left[\prod_{e \in E} X_{j(e)}(\varphi(e), \varphi'(e)) \right]. \end{aligned}$$

For any permutation $\alpha \in \mathcal{S}_E$, let $\pi(\alpha)$ be the smallest partition of V such that, for all $e \in E$, \bar{e} is in the same block as $\underline{\alpha(e)}$. Summing over ϕ in the previous expression yields

$$\begin{aligned} \tau_{\mathbf{X}_N}[T_1, \dots, T_m] &= \sum_{\alpha, \beta \in \mathcal{S}_E} N^{\#\pi(\alpha) - m} \text{Wg}_{n, N}(\alpha\beta^{-1}) \sum_{\substack{\varphi, \varphi': E \rightarrow \{1, \dots, N\} \\ \varphi(\beta(e)) = \varphi'(e)}} \mathbb{E} \left[\prod_{e \in E} X_{j(e)}(\varphi(e), \varphi'(e)) \right] \\ &= \sum_{\alpha, \beta \in \mathcal{S}_E} N^{\#\pi(\alpha) - m} \text{Wg}_{n, N}(\alpha\beta^{-1}) \mathbb{E} \left[\prod_{\substack{(e_1 \dots e_k) \\ \text{cycle of } \beta}} \text{Tr}(X_{j(e_1)} X_{j(e_2)} \dots X_{j(e_k)}) \right] \end{aligned}$$

To conclude we will need the following

Lemma 7.3. *i) For any permutation $\alpha \in \mathcal{S}_E$, $\#\pi(\alpha) + \#\alpha \leq \#E + m$ and the equality implies that the graph of $T^{\pi(\alpha)}$ is the disjoint union of m oriented cacti, with resp. set of edges E_1, \dots, E_m , and that α fixes the sets E_1, \dots, E_m .*

ii) The map

$$\pi : \{\alpha : \#\pi(\alpha) + \#\alpha = \#E + m\} \longrightarrow \{\pi : \text{the graph of } T^\pi \text{ is the disjoint union of } m \text{ oriented cacti with resp. edges set } E_1, \dots, E_m\}$$

is a bijection whose inverse γ is given, for all $\pi \in \mathcal{P}(V)$ such that T^π is a disjoint union of m oriented cacti with resp. edges E_1, \dots, E_m , by the permutation $\gamma(\pi)$ whose cycles are the biconnected components of T^π .

Proof Lemma 7.3. i) Let $\alpha \in \mathcal{S}_E$. Let us define a connected graph G_α whose vertices are the cycles of α altogether with the blocks of $\pi(\alpha)$, and whose edges are defined as follow. There is an edge between a cycle c of α and a block b of $\pi(\alpha)$ if and only if there is an edge e of T such that $e \in c$ and $\bar{e} \in b$. This way, the edges of G_α are in bijective correspondence with the edges of T . Therefore, $\#\pi(\alpha) + \#\alpha \leq \#E + m$ with equality if and only G_α is the disjoint unions of two trees.

In fact, each cycle of α yields a cycle in $T^{\pi(\alpha)}$, and in the case where G_α is acyclic, there exist no other cycle in $T^{\pi(\alpha)}$. What is more, since T_1, \dots, T_m are connected, if T^π has m connected components, the latter cannot use edges of several sets among E_1, \dots, E_m . Hence, the biconnected component of $T^{\pi(\alpha)}$ are exactly the cycles of α , that cannot use edges from several sets E_1, \dots, E_m , and $T^{\pi(\alpha)}$ is therefore the disjoint union of m oriented cacti, with α fixing each set E_i , $i = 1, \dots, m$.

ii) $\pi \circ \gamma$ and $\gamma \circ \pi$ are the identity functions: π is one-to-one and its inverse is γ . \square

For all $\alpha \in \mathcal{S}_E$, set

$$\phi_N(\alpha) = N^{-\#\alpha} \mathbb{E} \left[\prod_{\substack{(e_1 \dots e_k) \\ \text{cycle of } \sigma}} \text{Tr}(X_{\gamma(e_1)} X_{\gamma(e_2)} \dots X_{\gamma(e_k)}) \right]$$

and

$$\phi(\alpha) = \prod_{\substack{(e_1 \dots e_k) \\ \text{cycle of } \sigma}} \Phi(x_{\gamma(e_1)} x_{\gamma(e_2)} \dots x_{\gamma(e_k)})$$

in such a way that that $\phi_N = \phi + o(1)$. Let us fix $\alpha \in \mathcal{S}_E$. On the one hand we have

$$N^{\#\pi(\alpha) + \#\alpha - \#E - m} = \mathbb{1}_{\#\pi(\alpha) + \#\alpha = \#E + m} + o(1).$$

On the other hand, according to (7.5), the quantity

$$\sum_{\beta \in \mathcal{S}_E} N^{\#E - \#\alpha} \text{Wg}_{n,N}(\alpha \beta^{-1}) \mathbb{E} \left[\prod_{\substack{(e_1 \dots e_k) \\ \text{cycle of } \beta}} \text{Tr}(X_{\gamma(e_1)} X_{\gamma(e_2)} \dots X_{\gamma(e_k)}) \right]$$

is equal to $((\phi_N) \star_N \text{Wg}_{n,N})(\alpha) = (\phi \star \mu)(\alpha) + o(1)$. Let us write $\alpha_1 \times \dots \times \alpha_m$ for the permutation whose restriction to E_1, \dots, E_m is given by $\alpha_i \in \mathcal{S}_{E_i}$, for $i = 1, \dots, m$. It follows that

$$\tau_{\mathbf{X}_N}(T_1, \dots, T_m) = \sum_{\substack{\alpha_i \in \mathcal{S}_{E_i}, i=1, \dots, m \\ \#\pi(\alpha_1 \times \dots \times \alpha_m) + \#\alpha_1 \times \dots \times \alpha_m = \#E + m}} (\phi \star \mu)(\alpha_1 \times \dots \times \alpha_m) + o(1).$$

From (7.4), we know that $(\phi \star \mu)(\alpha) = k(\alpha) = \prod_{\substack{(e_1 \dots e_k) \\ \text{cycle of } \alpha}} \kappa(x_{\gamma(e_1)}, \dots, x_{\gamma(e_k)})$. Let

us write now $\pi_1 \sqcup \pi_2$, the partition of E that is finer than $\{E_1, \dots, E_m\}$ and whose restriction of these m sets is fixed, when $\pi_i \in \mathcal{P}(V_i)$, $i = 1, \dots, m$. Thanks to Lemma 7.3, we can now write

$$\begin{aligned} \tau_{\mathbf{X}_N}(T) &= \sum_{\substack{\pi_i \in \mathcal{P}(V_i), i=1, \dots, m \\ T_i^{\pi_i} \text{ is an oriented cactus}}} \prod_{\substack{(e_1 \dots e_k) \\ \text{cycle of } \gamma(\pi_1 \sqcup \dots \sqcup \pi_m)}} \kappa(x_{\gamma(e_1)}, \dots, x_{\gamma(e_k)}) + o(1) \\ &= \sum_{\substack{\pi_i \in \mathcal{P}(V_i), i=1, \dots, m \\ T_i^{\pi_i} \text{ is an oriented cactus}}} \prod_{\substack{(e_1 \dots e_k) \\ \text{simple cycle of one graph } T_i^{\pi_i}}} \kappa(x_{\gamma(e_1)}, \dots, x_{\gamma(e_k)}) + o(1). \end{aligned}$$

In order to pursue the computation, let t_i be the test graph $(V_i, E_i, \lambda_i(e)) \in \mathbb{CT}\langle \mathcal{G}(\mathcal{A}) \rangle$ such that $\lambda_i(e) = x_{j_i(e)}$, for $i = 1, 2$. By Definition of unitarily invariant traffics, we get

$$\begin{aligned} \tau_{\mathbf{X}_N}(T_1, \dots, T_m) &= \sum_{\pi_i \in \mathcal{P}(V_i), i=1, \dots, m} \prod_{i=1}^m \tau_{\Phi}^0[t_i^{\pi_i}] + o(1) \\ &= \prod_{i=1}^m \tau_X[t_i] + o(1) \end{aligned}$$

so that $\tau_{\mathbf{X}_N}(T_1, \dots, T_m)$ converges towards the expected limit. \square

Remark 7.4. From the above proof, it is tempting to believe that expansions of moments of the evaluation of test graphs in powers of N^{-1} should actually be expansions in powers of N^{-2} , so that for any $*$ -test graph $T = (V, E, j \times e) \in \mathbb{CT}\langle J \times \{1, *\} \rangle$, the fluctuations of $\frac{1}{N} \text{Tr}(T(\mathbf{X}_N)) - \mathbb{E}[\frac{1}{N} \text{Tr}(T(\mathbf{X}_N))]$ should be of order N^{-1} . This is nonetheless wrong as shows the following simple example. Consider a random $N \times N$ matrix A , whose law is invariant by unitary conjugation and the test graph T with one simple edge labeled by A and one extremity equal both to the input and output. For the associated traffic distribution as in Example 1.8, $\text{Tr}(T(\mathbf{X}_N)) = \sum_{1 \leq i, j \leq N} A_{i,j}$. In the setting of the central limit theorem where entries of A have variance of order $\frac{1}{N}$, the fluctuations of $\frac{1}{N} \text{Tr}(T(\mathbf{X}_N))$ are of order $O(\frac{1}{\sqrt{N}})$.

8 Canonical construction of spaces of free type

The purpose of this section is to prove the Theorem 1.3, which states that any tracial $*$ -probability space can be enlarged into a traffic space.

8.1 Free \mathcal{G} -algebra generated by an algebra

We first describe how an algebra can be canonically extended into a \mathcal{G} -algebra.

Definition 8.1. *Let \mathcal{A} be an algebra. We denote by $\mathcal{G}(\mathcal{A})$ the \mathcal{G} -algebra $\mathbb{CG}\langle \mathcal{A} \rangle$ of graph polynomials labeled in \mathcal{A} , quotiented by the following relations: for all $g \in \mathcal{G}_{n-k+1}$, $a_1, \dots, a_n \in \mathcal{A}$ and P non-commutative polynomial in n variables, we have*

$$Z_g(\cdot \xleftarrow{(a_1, \dots, a_k)} \cdot \otimes \cdot \xleftarrow{a_{k+1}} \cdot \otimes \dots \otimes \cdot \xleftarrow{a_n} \cdot) = Z_g(P(\cdot \xleftarrow{a_1} \cdot, \dots, \cdot \xleftarrow{a_k} \cdot) \otimes \cdot \xleftarrow{a_{k+1}} \cdot \otimes \dots \otimes \cdot \xleftarrow{a_n} \cdot) \quad (8.1)$$

which allows to consider the algebra homomorphism $V : \mathcal{A} \rightarrow \mathcal{G}(\mathcal{A})$ given by $a \mapsto (\cdot \xleftarrow{a} \cdot)$.

As for the free product of \mathcal{G} -algebra of Section 3.1, the space $\mathcal{G}(\mathcal{A})$ is a \mathcal{G} -algebra. Moreover, it is the free \mathcal{G} -algebra generated by the algebra \mathcal{A} in the following sense.

Proposition 8.2. *Let \mathcal{B} be a \mathcal{G} -algebra and $f : \mathcal{A} \rightarrow \mathcal{B}$ a algebra homomorphism. There exists a unique \mathcal{G} -algebra homomorphism $f' : \mathcal{G}(\mathcal{A}) \rightarrow \mathcal{B}$ such that $f = f' \circ V$. As a consequence, the algebra homomorphism $V : \mathcal{A} \rightarrow \mathcal{G}(\mathcal{A})$ is injective.*

Proof. The existence is given by the following definition of f' on $\mathcal{G}(\mathcal{A})$:

$$f'(Z_g(\cdot \xleftarrow{a_1} \cdot \otimes \dots \otimes \cdot \xleftarrow{a_n} \cdot)) = Z_g(f(a_1) \otimes \dots \otimes f(a_n))$$

for all $a_1, \dots, a_n \in \mathcal{A}$; which obviously respects the relation defining $*_{j \in J} \mathcal{A}_j$.

The uniqueness follows from the fact that f' is uniquely determined on $V(\mathcal{A})$ (indeed, $f'(a)$ must be equal to $f(b)$ whenever $a = V(b)$) and that $V(\mathcal{A})$ generates $\mathcal{G}(\mathcal{A})$ as a \mathcal{G} -algebra. \square

For example, the free \mathcal{G} -algebra generated by the variables $\mathbf{x} = (x_i)_i \in J$ and $\mathbf{x}^* = (x_i^*)_i \in J$ is the \mathcal{G} -algebra $\mathbb{C}\mathcal{G}\langle\mathbf{x}, \mathbf{x}^*\rangle$ of graphs whose edges are labelled by \mathbf{x} and \mathbf{x}^* .

8.2 Algebraic construction

Let (\mathcal{A}, Φ) be a non-commutative probability space such that Φ is a trace. We want to equip the \mathcal{G} -algebra $\mathcal{G}(\mathcal{A})$ with a combinatorial distribution that is of cactus type and whose induced distribution on $\mathcal{A} \subset \mathcal{G}(\mathcal{A})$ is Φ . We firstly define $\tau : \mathcal{CT}\langle\mathcal{A}\rangle \rightarrow \mathbb{C}$ by the cactus formula, namely for any test graph T labeled in \mathcal{A} ,

$$\tau^0[T] = \mathbb{1}(T \text{ is a w.o. cactus}) \prod_{C \text{ cycle of } T} \kappa(C),$$

where as usual κ is the free cumulant function with respect to Φ of the variable along the oriented cycle. Then, as in Section 3.1, we consider the map $\tilde{\tau} : \mathcal{CT}\langle\mathbb{C}\mathcal{G}\langle\mathcal{A}\rangle\rangle \rightarrow \mathbb{C}$ defined as follow: for any test graph T with edges e_1, \dots, e_k labeled respectively by graph monomial g_1, \dots, g_k , we set $\tilde{\tau}[T] = \tau[T_g]$ where T_g is obtained by replacing the edge e_k by the graph g_k for any $k = 1, \dots, k$. We extend the definition by multilinearity with respect to the edges and set $\tilde{\tau}[\langle \cdot \rangle] = 1$. By Lemma 3.1, $\tilde{\tau}$ satisfies the associativity property and then endows $\mathbb{C}\mathcal{G}\langle\mathcal{A}\rangle$ with a structure of algebraic traffic space. It remains to prove that it induces a same structure on $\mathcal{G}(\mathcal{A})$.

Proposition 8.3. *The linear form $\tilde{\tau}$ is invariant under the relations (8.1) defining $\mathcal{G}(\mathcal{A})$, and consequently yields to an algebraic traffic space $(\mathcal{G}(\mathcal{A}), \tilde{\tau})$. Furthermore, the trace induced by $\tilde{\tau}$ coincides with Φ on \mathcal{A} , seen as a subalgebra of $\mathcal{G}(\mathcal{A})$.*

Proof. It is sufficient to prove the following:

1. For any test graph T having an edge e labeled $a_1 + \alpha a_2$, where $a_1, a_2 \in \mathcal{A}$ and $\alpha \in \mathbb{C}$, one has $\tau[T] = \tau[T_1] + \alpha\tau[T_2]$ where T_i is obtained from T by putting label a_i on e .
2. For any test graph T having an edge e labeled $1_{\mathcal{A}}$, one has $\tau[T] = \tau[T_{\bullet}]$ where T_{\bullet} is obtained by identifying source and target of e and suppressing this edge.
3. For any test graph T having an edge e labeled $a_1 a_2$, where $a_1, a_2 \in \mathcal{A}$, one has $\tau[T] = \tau[T_{\times}]$ where T_{\times} is obtained by replacing e by two consecutive edges $(\cdot \xrightarrow{a_1} \cdot \xrightarrow{a_2} \cdot)$.

The first property is an immediate consequence of the linearity of the cumulants. Let us prove the others properties at the level of the injective trace.

Lemma 8.4. *With notations as above, we have the following formulas:*

1. *Whenever e has label $1_{\mathcal{A}}$, one has $\tau^0[T] = \tau^0[T_{\bullet}]$ if the goal and the source of the edge e are equal in T , and $\tau^0[T] = 0$ otherwise.*
2. *Whenever e has label $a_1 a_2$, denote by V the vertex set of T and by v_0 the new vertex in T_{\times} . Then for any partition π of V , one has $\tau^0[T^{\pi}] = \sum_{\substack{\sigma \in \mathcal{P}(V \cup \{v_0\}) \\ \sigma \setminus \{v_0\} = \pi}} \tau^0[T_{\times}^{\sigma}]$.*

This implies the proposition as we see now. When e has label $1_{\mathcal{A}}$, we get

$$\tau[T] = \sum_{\pi \in \mathcal{P}(V)} \tau^0[T^\pi] = \sum_{\pi \in \mathcal{P}(V_\bullet)} \tau^0[T^\pi] = \tau[T_\bullet].$$

Moreover, when e has label $a_1 a_2$, one has

$$\begin{aligned} \tau[T] &= \sum_{\pi \in \mathcal{P}(V)} \tau^0[T^\pi] = \sum_{\pi \in \mathcal{P}(V)} \sum_{\substack{\sigma \in \mathcal{P}(V \cup \{v_0\}) \\ \sigma \setminus \{v_0\} = \pi}} \tau^0[T_\times^\sigma] \\ &= \sum_{\sigma \in \mathcal{P}(V \cup \{v_0\})} \tau^0[T_\times^\sigma] = \tau[T_\times]. \end{aligned}$$

Finally, for any $a \in \mathcal{A}$, seen as an element of \mathcal{A} , its trace associated to τ is given by $\tau(\mathcal{C}_a) = \tau^0(\mathcal{C}_a) = \kappa(a) = \Phi(a)$ as expected. This finishes the proof of the proposition. \square

Proof of Lemma 8.4. The first item follows from the fact that a cumulant involving $1_{\mathcal{A}}$ is equal to 0, except $\kappa(1_{\mathcal{A}}) = 1$ (see [24, Proposition 11.15]). As a consequence, for a cactus T having a loop labeled $1_{\mathcal{A}}$, we can remove the loop without changing the value of the invective trace.

Let us prove the second item, and consider a test graph T with an edge e labeled $a_1 a_2$ and T_\times defined as before. Let π be a partition of the vertex set of T . If T^π is not a cactus, then the two side of the equation are equal to zero. Assume that T^π is a cactus. We denote by c the cycle of $\cdot \xrightarrow{a_1 a_2} \cdot$ in T^π and $a_1 a_2, b_2, \dots, b_{k-1}$ the elements of the cycle c starting at $a_1 a_2$.

Let us consider a partition $\sigma \in \mathcal{P}(V \cup \{v_0\})$ such that T_\times^σ is a cactus and $\pi = \sigma \setminus \{v_0\}$. Then, we have two cases:

1. v_0 is of degree 2 (this occurs for only one partition σ given by $\pi \cup \{\{v_0\}\}$). Denoting by c^+ the cycle of T_\times^σ which contains v_0 , we have $c^+ = (a_2, b_2, \dots, b_{k-1}, a_1)$. The cycles of T^π and T_\times^σ different from c and c^+ are the same, and by consequence

$$\tau^0[T^\pi]/k(a_1 a_2, b_2, \dots, b_{k-1}) = \tau^0[T_\times^\sigma]/k(a_2, b_2, \dots, b_{k-1}, a_1).$$

2. v_0 is of degree > 2 . We denote by c_1 the cycle of $\cdot \xrightarrow{a_2} \cdot$ in T_\times^σ , c_2 the cycle of $\cdot \xrightarrow{a_1} \cdot$ in T_\times^σ (of course, c_1 and c_2 are not equal, because if it is the case, T^π would be disconnected, which is not possible). The cycles of T^π different from c are exactly the cycles of T_\times^σ different from c_1 or c_2 . We have $c_1 = (a_2, b_2, \dots, b_l)$ and $c_2 = (b_{l+1}, \dots, b_k, a_1)$ with l the place of the vertex which is identified with v_0 in T_\times^σ . By definition, we have

$$\tau^0[T^\pi]/k(a_1 a_2, b_2, \dots, b_{k-1}) = \tau^0[T_\times^\sigma]/(k(a_2, b_2, \dots, b_l) \cdot k(b_{l+1}, \dots, b_k, a_1)).$$

Conversely, for each vertex v_1 in the cycle c , we are in the above situation for $\sigma = \pi|_{v_0 \simeq v_1}$.

Finally, using [24, Theorem 11.12] for computing $k(a_1 a_2, b_2, \dots, b_{k-1})$, we can com-

pute

$$\begin{aligned}
\tau^0[T^\pi] &= \tau^0[T^\pi]/k(a_1 a_2, b_2, \dots, b_{k-1}) \cdot k(a_1 a_2, b_2, \dots, b_{k-1}) \\
&= \tau^0[T^\pi]/k(a_1 a_2, b_2, \dots, b_{k-1}) \\
&\quad \cdot \left(k(a_2, b_2, \dots, b_{k-1}, a_1) + \sum_{1 \leq l \leq k} k(a_2, b_2, \dots, b_l) \cdot k(b_{l+1}, \dots, b_k, a_1) \right) \\
&= \tau^0[T_\times^{\pi \cup \{v_0\}}] + \sum_{\substack{\sigma \in \mathcal{P}(V \cup \{v_0\}) \setminus \{\pi \cup \{v_0\}\} \\ \sigma \setminus \{v_0\} = \pi}} \tau^0[T_\times^\sigma] \\
&= \sum_{\substack{\sigma \in \mathcal{P}(V \cup \{v_0\}) \\ \sigma \setminus \{v_0\} = \pi}} \tau^0(T_\times^\sigma).
\end{aligned}$$

□

8.3 Positivity

Let (\mathcal{A}, Φ) be a $*$ -probability space. We define $\tau : \mathbb{C}\langle \mathcal{A} \rangle \rightarrow \mathbb{C}$ by the cactus formula with respect to Φ and then $(\mathcal{G}(\mathcal{A}), \tilde{\tau})$ as in Proposition 8.3. It remains to prove that $\tilde{\tau}$ satisfies the positivity condition (3.1), and it is actually sufficient to prove that τ is positive.

In the four steps of the proof, we will prove successively that $\tau[t|t^*] \geq 0$ for n -graph polynomials $t = \sum_{i=1}^L \alpha_i t_i$ with an increasing generality:

1. the t_i are 2-graph monomials without cycles and the leaves are outputs, that is chains of edges with possibly different orientations;
2. the t_i are trees whose leaves are the outputs;
3. the t_i are such that $t_i|t_i^*$ have no cutting edges (see Definition 6.1);
4. the t_i are n -graph monomials.

Step 1 By Proposition 8.3, the trace associated to τ coincides with Φ on $\mathcal{A} \subset \mathcal{G}(\mathcal{A})$. We still denote it by Φ . Hence we get the positivity if all the t_i 's consist in chains of edges all oriented in the same direction. Indeed, we can write $t_i = \cdot \xrightarrow{a_i}$ for all i (or $t_i = \cdot \xleftarrow{a_i}$ for all i) and so, we get

$$\tau[t|t^*] = \tau \left[\sum_{i,j=1}^L \alpha_i \bar{\alpha}_j t_i t_j^* \right] = \Phi \left(\sum_{i,j=1}^L \alpha_i \bar{\alpha}_j a_i a_j^* \right) \geq 0,$$

by positivity of Φ on \mathcal{A} . We deduce that Φ is positive on the subalgebras $\mathbb{C}\langle \cdot \xleftarrow{a} \cdot : a \in \mathcal{A} \rangle$ and $\mathbb{C}\langle \cdot \xrightarrow{a} \cdot : a \in \mathcal{A} \rangle$ of $\mathcal{G}(\mathcal{A})$. From Lemma 7.1 these subalgebras are freely independent, so Φ is also positive on the mixed algebra $\mathbb{C}\langle \cdot \xleftarrow{a} \cdot, \cdot \xrightarrow{a} \cdot : a \in \mathcal{A} \rangle$ (the free product of positive trace is positive [24, Lecture 6]). Finally, if the t_i 's consist in chains of edges labeled by elements of \mathcal{A} , we know that

$$\tau[t|t^*] = \Phi \left[\sum_{i,j=1}^L \alpha_i \bar{\alpha}_j t_i t_j^* \right] \geq 0.$$

Step 2 Assume that the t_i 's are trees whose leaves are the outputs. Let us prove by induction on the number D of all edges of the t_i 's that we have $\tau[t|t^*] \geq 0$.

If the number of edges of the t_i 's is 0, we have $\tau_\Phi[t|t^*] = \sum_{i,j} \alpha_i \alpha_j^* \geq 0$. We suppose that $D \geq 1$ and that this result is true whenever the number of edges of the t_i 's is less than $D - 1$.

We can remove one edge in the following way. Let us choose one leaf v of one of the t_i 's which has at least one edge. It is an output and for each tree t_i we denote by $v^{(i)}$ the first node (or distinct leaf if there is no node) of the tree of t_i encountered by starting from this output v , and by $t^{(i)}$ the branch of t_i between this output v and $v^{(i)}$. Of course, $v^{(i)}$ can be equal to v and $t^{(i)}$ can be trivial, but there is at least one of the $t^{(i)}$'s which is not trivial. Denote by \check{t}_i the n -graph obtained from t_i after discarding the $t^{(i)}$'s, and whose output v is replaced by $v^{(i)}$. We claim that

$$\tau[t|t^*] = \tau[t|t^*] \times \tau[\check{t}_i|\check{t}_j^*].$$

Firstly, we can identify the pairs $v^{(i)}$ and $v^{(j)}$ in the computation of the left hand-side. Indeed, we write $\tau[t_i|t_j^*] = \sum_\pi \tau^0[(t_i|t_j^*)^\pi]$, and consider a term in the sum for which π does not identify $v^{(i)}$ and $v^{(j)}$. Because $\check{t}_i|\check{t}_j^*$ is t.e.c., there exists two disjoint paths between $v^{(i)}$ and $v^{(j)}$. But because $t^{(i)}|t^{(j)*}$ contains a third distinct path, by Lemma 6.4 π cannot be a cactus if it does not identify $v^{(i)}$ and $v^{(j)}$ and so $\tau^0[(t_i|t_j^*)^\pi]$ is zero.

Consider a term in the sum $\sum_\pi \tau^0[(t_i|t_j^*)^\pi]$ for which π identifies the pairs $v^{(i)}, v^{(j)}$. Assume that a vertex v_1 of $\check{t}_i|\check{t}_j^*$ is identified with a vertex v_2 which is not in $\check{t}_i|\check{t}_j^*$. Assume that π does not identify $v^{(i)}$ with v_1 and v_2 . Because $\check{t}_i|\check{t}_j^*$ is t.e.c. there exists two distinct paths between v_1 and $v^{(i)}$ out of $\tau[t^{(i)}|t^{(j)*}]$. But there exists also a path between v_2 and $v^{(i)}$ in $t^{(i)}|t^{(j)*}$. By Lemma 6.4, we get that $(t_i|t_j^*)^\pi$ is not a cactus and so $\tau^0[(t_i|t_j^*)^\pi]$ is zero.

Hence, to determine which vertices of $\check{t}_i|\check{t}_j^*$ are identified with some vertices of $t^{(i)}|t^{(j)*}$, one can first determine which vertices of $\check{t}_i|\check{t}_j^*$ are identified with $v^{(i)} = v^{(j)}$ and which vertices of $t^{(i)}|t^{(j)*}$ are identified with this vertex. Hence the sum over π partition of the set of vertices of $t_i|t_j^*$ can be reduced to a sum over π_1 partition of the set of vertices of $\check{t}_i|\check{t}_j^*$ and a sum over π_2 partition of the set of vertices of the graph $t^{(i)}|t^{(j)*}$. Moreover, by definition of τ , for two test graphs T_1 and T_2 , if T is obtained by considering the disjoint union of T_1 and T_2 and merging one of their vertices, one has $\tau^0[T] = \tau^0[T_1] \times \tau^0[T_2]$. Hence, the contribution of $\check{t}_i|\check{t}_j^*$ factorizes in $\tau[\check{t}_i|\check{t}_j^*]$ and the contribution of $t^{(i)}|t^{(j)*}$ factorizes in $\tau[t^{(i)}|t^{(j)*}]$, and we get the expected result.

From Step 1, we know that $A = (\tau[t^{(i)}|t^{(j)*}])_{i,j}$ is nonnegative. By induction hypothesis, we know that $B = (\tau[\check{t}_i|\check{t}_j^*])_{i,j}$ is also nonnegative. We obtain as desired that the Hadamard product of A and B is nonnegative ([24, Lemma 6.11]) and in particular, for all α_i , we have

$$\sum_{i,j} \alpha_i \bar{\alpha}_j \tau[t_i|t_j^*] \geq 0.$$

Step 3 Let us prove that, for all t_i such that $t_i|t_i^*$ have no cutting edges, we have $\tau[t|t^*] \geq 0$.

For a graph T , recall that the t.e.c. components are the maximal subgraphs of T with no cutting edges. We call tree of t.e.c. of T the graph whose vertices are the t.e.c. components of T and whose edges are the cutting edges of T . First of all, our condition is equivalent to the condition that, for each t_i , any leaf of the tree of the

t.e.c. components of t_i is a component containing an output. Here again, we can proceed by induction. Let D be the total number of t.e.c. components of the t_i 's which do not consists in a single vertex.

If $D = 0$, we are in the case of the previous step. Let us assume that $D > 0$ and that the result is true up to the case $D - 1$. We can remove one t.e.c. in the following way. Let us choose a t.e.c. component $t^{(k)}$ which is not a single vertex of a certain n -graph monomial t_k , for some k in $\{1, \dots, L\}$. We consider $t^{(k)}$ as a multi *-graph monomial, where the outputs are the vertices which are attached to cutting edges. Let \check{t}_k be the n -graph monomial obtained from t_k by replacing the component $t^{(k)}$ by one single vertex. We define also for $i \neq k$ the *-graph monomial $t^{(i)}$ to be the trivial leaf and set $\check{t}_i = t_i$. We claim that

$$\tau[T(t_i, t_j^*)] = \tau[T(\check{t}_i, \check{t}_j^*)] \times \tau[t^{(i)}] \times \tau[t^{(j)*}]$$

(of course, this equality is nontrivial only if we consider $i = k$ or $j = k$).

Firstly, the outputs of $t^{(i)}$ can be identified. Indeed, consider v_1, v_2 two distinct outputs of $t^{(i)}$. Writing $\tau[t_i|t_j^*] = \sum_{\pi} \tau^0[(t_i|t_j^*)^{\pi}]$, consider a term in the sum for which π does not identify v_1 and v_2 . Since $t^{(i)}$ is t.e.c. there exist two distinct simple paths γ_1 and γ_2 between v_1 and v_2 . Consider a path from v_2 to v_1 that does not visit $t^{(i)}$ in $t_i|t_j^*$. Such a path exists as v_1 and v_2 belong to two subtrees of t_i that are attached to outputs of t_i , themselves being attached to the connected graph t_j^* . The quotient by π yields three distinct paths γ between v_1 and v_2 in $(t_i|t_j^*)^{\pi}$ which implies that $(t_i|t_j^*)^{\pi}$ is not a cactus by Lemma 6.4. Hence, by definition of τ , $\tau^0[(t_i|t_j^*)^{\pi}]$ is zero. Thus, when we write $\tau[t_i|t_j^*] = \sum_{\pi} \tau^0[(t_i|t_j^*)^{\pi}]$ we can restrict the sum over the partition π that identify v_1 and v_2 , therefore, we can replace t_i by the graph \check{t}_i where we have identify v_1 and v_2 . Hence we have $\tau[t_i|t_j^*] = \tau[\check{t}_i|t_j^*]$.

Let us write $\tau[\check{t}_i|\check{t}_j^*] = \sum_{\pi} \tau^0[(\check{t}_i|\check{t}_j^*)^{\pi}]$. Let π be as in the sum. Assume that a vertex v_1 of $t^{(i)}$ is identified by π with a vertex v_2 which is not in $t^{(i)}$. Assume that π does not identify $w^{(i)}$ with v_1 and v_2 . Since $t^{(i)}$ is t.e.c. there exist two distinct paths between v_1 and $w^{(i)}$ in $t^{(i)}$. But \check{t}_i is connected and there exists a third path between v_2 and $w^{(i)}$. As usual this implies that $(\check{t}_i|\check{t}_j^*)^{\pi}$ is not a cactus and so $\tau_{\Phi}^0[(\check{t}_i|\check{t}_j^*)^{\pi}]$ is zero.

Hence, to determine which vertices of $t^{(i)}$ are identified with some vertices out of $t^{(i)}$, one can first determine which vertices of $t^{(i)}$ are identified with $w^{(i)}$ and which vertices out of $t^{(i)}$ are identified with this vertex. Thus the sum over π partition of the set of vertices of $\check{t}_i|\check{t}_j^*$ can be reduced to a sum over π_1 partition of the set of vertices of $t^{(i)}$ and a sum over π_2 partition of the set of vertices of the graph with $t^{(i)}$ removed. Moreover, by definition of τ , for two *- test graphs T_1 and T_2 , if T is obtained by considering the disjoint union of T_1 and T_2 and merging one of their vertices, one has $\tau^0[T] = \tau^0[T_1] \times \tau^0[T_2]$. Hence, the contribution of $T(t_i, t_j^*)$ factorizes in $\tau[T(\check{t}_i, \check{t}_j^*)]$ and the contribution of $t^{(i)}$ factorizes in $\tau[t^{(i)}]$. We can do the same factorization for the n -graph monomial t_j^* , and we get the expected result.

Now, setting $\beta_i = \alpha_i \tau[t^{(i)}]$, we have

$$\tau[T(t, t^*)] = \sum_{i,j} \beta_i \bar{\beta}_j \tau[T(\check{t}_i, \check{t}_j^*)]$$

which is nonnegative thanks to the induction hypothesis.

Step 4 A direct proof of the positivity in general case requires appropriate tools, and we bypass this difficulty using both the positivity of the free product (Theorem 1.2) and the fact that unitary invariant traffics are of cactus type (Proposition 5.5).

We define an auxiliary distribution of traffic $\tau' : \mathbb{C}\mathcal{T}\langle\mathcal{A}\rangle \rightarrow \mathbb{C}$ which is defined to be equal to τ on the test graphs without cutting edges and equal to 0 on those with cutting edges. This map τ' induces a combinatorial distribution on the \mathcal{G} -algebra $\mathbb{C}\mathcal{G}\langle\mathcal{A}\rangle$ of graph polynomials labeled in \mathcal{A} .

On the one hand, the map τ' does satisfy the positivity property since for any n -graph polynomial $t = \sum_i \alpha_i t_i$, we have

$$\tau'[t|t^*] = \sum_{i,j} \alpha_i \bar{\alpha}_j \tau'[t_i|t_j^*] = \sum_{\substack{i,j \\ t_i|t_j^* \\ \text{without cutting edges}}} \alpha_i \bar{\alpha}_j \tau[t_i|t_j^*] = \sum_{\substack{i,j \\ t_i|t_i^*, t_j|t_j^* \\ \text{without cutting edges}}} \alpha_i \bar{\alpha}_j \tau_{\Phi}[t_i|t_j^*] \geq 0,$$

using the result of the previous step. By positivity of the free product, the distribution remains positive if we enlarge $\mathbb{C}\mathcal{G}\langle\mathcal{A}\rangle$ into a traffic space \mathcal{B} with a unitary traffic u such that (u, u^*) is the limit of a Haar unitary matrix, traffic independent from the elements of $\mathbb{C}\mathcal{G}\langle\mathcal{A}\rangle$. We consider the function $f : \mathbb{C}\mathcal{T}\langle\mathcal{A}\rangle \rightarrow \mathbb{C}\mathcal{T}\langle\mathcal{B}\rangle$ which replaces each edge $e_a := \xleftarrow{a}$ of a graph in $\mathbb{C}\mathcal{T}\langle\mathcal{A}\rangle$ by the edges $\xleftarrow{u} \cdot \xleftarrow{e_a} \cdot \xleftarrow{u^*}$, obtaining a graph whose edges are labelled by elements of $\mathcal{G}\langle\mathcal{A}\rangle \cup \{u, u^*\} \subset \mathcal{B}$. By unitary invariance, the traffic distribution $\tau' \circ f$ is exactly τ because they coincide on cycles. Hence τ is the restriction of a positive combinatorial distribution, so it is positive.

9 Three types of traffics

From Proposition 5.5, we recall the following for traffics of free type. Let (\mathcal{A}, τ) be a traffic space. A family $\mathbf{a} = (a_j)_{j \in J}$ of elements of \mathcal{B} is of **free type** if one of the following equivalent properties holds :

1. **Cactus type.** The injective distribution is supported on well oriented cacti that are multiplicative w.r.t. their cycles.
2. **Unitary invariance.** The family \mathbf{a} has the same traffic distribution as $u\mathbf{a}u^* = (ua_ju^*)_{j \in J}$ where u is traffic independent from \mathbf{a} and is a Haar unitary on \mathcal{A} (i.e. u is unitary and $\Phi(u^k u^{*\ell}) = \delta_{k,\ell}$ for any $k, \ell \geq 0$).

Thus we have two different characterizations of traffic of free type. A distributional symmetry and a property of the injective distribution. In this section, we will state the corresponding characterization for the two other types of traffics (see Table 1).

Table 1: The three types of traffics

Type	Distributional symmetry	Injective distribution
Tensor	Diagonality: $a = \Delta(a)$ where $\Delta = Z_{\bigcirc}$ is the diagonal projection	Supported on flowers
Boolean	\mathbb{J}-Invariance: $a \equiv \mathbb{J} \otimes a$ in distribution, for \mathbb{J} the limit of the matrix whose entries are $\frac{1}{N}$	Supported on trees
Free	Unitary Invariance: $a \equiv uau^*$ in distribution, for u traffic independent and limit of Haar unitary matrix	Supported on cacti and multiplicative on cycles

9.1 Boolean type

Let (\mathcal{A}, τ) be an algebraic traffic space and let \mathcal{Y} a family of elements of \mathcal{A} . Let us remark that \mathcal{Y} is of Boolean type whenever one of the following equivalent conditions is satisfied:

1. For any $T \in \mathcal{T}\langle\mathcal{Y}\rangle$, one has $\tau[T] = 0$ if T is not a tree, or
2. for any $T \in \mathcal{T}\langle\mathcal{Y}\rangle$, one has $\tau^0[T] = 0$ if T is not a tree.

In that case, the plain and injective combinatorial distributions coincides, namely $\tau[T] = \tau^0[T]$ for any $T \in \mathcal{T}\langle\mathcal{Y}\rangle$. With respect to the trace Φ associated to τ , \mathcal{Y} has the null distribution since $\Phi(y) = \tau[\Omega(y)] = 0$ for any y in the algebra spanned by \mathcal{Y} .

Lemma 9.1. *If \mathcal{Y} is of Boolean type, then the non unital algebra generated by \mathcal{Y} is of Boolean type.*

Proof. Let T be a test graph whose edges are labeled by monomials $m_i = y_{i,1} \dots y_{i,n_i}$ with $y_{i,j}$ in \mathcal{Y} . Then $\tau[T] = \tau[\tilde{T}]$ where \tilde{T} is obtained by replacing each edge of T by the sequence of edges $(\cdot \xleftarrow{y^1} \dots \xleftarrow{y^n} \cdot)$. The graph T is a tree if and only if \tilde{T} is a tree, hence the result. \square

We now associate a *distributional symmetry* for Boolean type variables. The matrix \mathbb{J}_N whose all entries are $\frac{1}{N}$ converges in traffic distribution to a traffic \mathbb{J} of Boolean type, whose distribution is given by $\tau[T] = \tau^0[T] = \mathbb{1}(T \text{ is a tree})$ for any $T \in \mathcal{T}\langle\mathbb{J}\rangle$.

Proposition 9.2. *Let (\mathcal{A}, τ) be an algebraic traffic space and let \mathcal{Y} a family of elements of \mathcal{A} . A family of traffics \mathbf{A} is of Boolean type whenever one of the following equivalent conditions is satisfied:*

1. **Trees.** *for any $T \in \mathcal{T}\langle\mathcal{Y}\rangle$, one has $\tau^0[T] = 0$ if T is not a tree.*
2. **\mathbb{J} -invariance** *The family \mathbf{A} as the same distribution as $\mathbb{J} \otimes \mathbf{A}$ in the tensor product of traffic spaces.*

Proof. We have for any $T \in \mathcal{T}\langle\mathbb{J} \otimes \mathcal{A}\rangle$,

$$\tau[T] = \tau[T_{\mathbb{J}}] \times \tau[T_{\mathcal{A}}] = \mathbb{1}(T \text{ is a tree})\tau[T_{\mathcal{A}}].$$

Hence the \mathbb{J} -invariance is equivalent to the fact that the traffic distribution of \mathcal{A} is supported on tree, or equivalently the fact that the injective combinatorial distribution of \mathcal{A} is supported on tree. \square

Example 9.3. Let \mathbf{A}_N be a family of random matrices that converges in traffic distribution (such families can be built from Theorem 1.1). Then for any $M = M_N$, sequence of integers that converges to infinity, the family $\mathbb{J}_M \otimes \mathbf{A}_N$ converges to a family of traffics of Boolean type. Moreover the distribution of $\mathbb{J}_M \otimes \mathbf{A}_N$ with respect to Ψ_N is the same as for \mathbf{A}_N .

Together with the asymptotic traffic independence theorem, this gives a new procedure to produce asymptotically Boolean independent matrices. More precisely, if \mathbf{A}_N and \mathbf{B}_N are independent families of random matrices that converge in traffic distribution, and S is a uniform matrix of permutation of size $(M_N \cdot N) \times (M_N \cdot N)$, then $S(\mathbb{J}_M \otimes \mathbf{A}_N)S^*$ and $\mathbb{J}_M \otimes \mathbf{B}_N$ are independent and asymptotically traffic independent, thanks to [16, Theorem 1.8]. Because the limiting traffics are of Boolean

type, $S(\mathbb{J}_M \otimes \mathbf{A}_N)S^*$ and $\mathbb{J}_M \otimes \mathbf{B}_N$ are asymptotically Boolean independent with respect to the anti-trace $\Psi_N = \frac{1}{N} \sum_{i,j} \langle E_{ij}, \cdot \rangle$

Note that the size of the matrices is $(M_N \cdot N) \times (M_N \cdot N)$. In contrast, in [8, Section 3.1], the author describe a procedure that leads to Boolean independence using tensor product, which produces matrices of size N^n , where n is the number of Boolean independent variables.

9.2 Tensor type

A test-graph is a *flower* if it has only one vertex. Let (\mathcal{A}, τ) be an algebraic traffic space and let \mathcal{Y} a family of elements of \mathcal{A} ; [16, Proposition 5.8] says that if \mathcal{Y} is of tensor type, for any $T \in \mathcal{T}\langle \mathcal{Y} \rangle$, one has $\tau^0[T] = 0$ if T is not a flower.

In fact, the converse is also true and we have the following.

Proposition 9.4. *Let (\mathcal{A}, τ) be an algebraic traffic space and let \mathcal{Y} a family of elements of \mathcal{A} . \mathcal{Y} is of tensor type whenever one of the following equivalent conditions is satisfied:*

1. **Diagonality.** *For any $a \in \mathcal{Y}$, one has $a = \Delta(a)$.*
2. **Flowers.** *for any $T \in \mathcal{T}\langle \mathcal{Y} \rangle$, one has $\tau^0[T] = 0$ if T is not a flower.*

Proof. It remains to prove that if the injective distribution of \mathcal{Y} is supported on flowers, we have $a = \Delta(a)$ for all $a \in \mathcal{Y}$. It suffices to compute $\Phi((a - \Delta(a))(a - \Delta(a))^*) = 0$ and we deduce that $a = \Delta(a)$. \square

Lemma 9.5. *If \mathcal{Y} is of tensor type, then the traffic space generated by \mathcal{Y} is of tensor type.*

Proof. For all K -graph operation g , we have

$$\begin{aligned} Z_g(a_1 \otimes \cdots \otimes a_K) &= Z_g(\Delta(a_1) \otimes \cdots \otimes \Delta(a_K)) \\ &= Z_{g \circ (\Delta, \dots, \Delta)}(a_1 \otimes \cdots \otimes a_K) \\ &= Z_{\Delta \circ g \circ (\Delta, \dots, \Delta)}(a_1 \otimes \cdots \otimes a_K) \\ &= \Delta(Z_{g \circ (\Delta, \dots, \Delta)}(a_1 \otimes \cdots \otimes a_K)) \\ &= \Delta(Z_g(\Delta(a_1) \otimes \cdots \otimes \Delta(a_K))) \\ &= \Delta(Z_g(a_1 \otimes \cdots \otimes a_K)). \end{aligned}$$

\square

9.3 Canonical traffic spaces

Proposition 8.3 and Section 8.3 allow also to conclude the following.

Proposition 9.6. *Let (\mathcal{A}, Φ) be a tracial $*$ -probability space. There exists a traffic space \mathcal{B} such that $\mathcal{A} \subset \mathcal{B}$ as $*$ -algebras, the trace induced by \mathcal{B} on \mathcal{A} is Φ , and the family of traffics \mathcal{A} is of free type.*

We now deduce from this canonical construction of traffic spaces of free type an analogue construction for traffics of Boolean type.

Proposition 9.7. *Let (\mathcal{A}, Ψ) be a non-unital $*$ -probability space. Then, there exists a traffic space (\mathcal{B}, τ) , and an injective morphism of non-commutative probability space $\psi : \mathcal{A} \rightarrow \mathcal{B}$ such that $\psi(\mathcal{A})$ is a family of traffics of Boolean type.*

Proof. On the one hand, let $\psi_1 : (\mathcal{A}, \Phi) \rightarrow (\mathcal{B}_1, \tau_1)$ be the universal construction of Part II, namely whose image consists in unitarily invariant traffics. On the other hand, let (\mathcal{B}_2, τ_2) be a traffic space generated by the limit \mathbb{J} of the matrix \mathbb{J}_N . Then $(\mathcal{B}, \tau) := (\mathcal{B}_1 \otimes \mathcal{B}_2, \tau_1 \otimes \tau_2)$ and $\psi : a \mapsto \psi_1(a) \otimes \mathbb{J}$ satisfy the expected properties. \square

Finally, we have the same result for traffics of tensor types.

Proposition 9.8. *Let (\mathcal{A}, Φ) be a commutative $*$ -probability space. There exists a traffic space \mathcal{B} such that $\mathcal{A} \subset \mathcal{B}$ as $*$ -algebras, the trace induced by \mathcal{B} on \mathcal{A} is Φ , and the family of traffics \mathcal{A} is of tensor type.*

Proof. It is the first example of [16, Example 4.10.]. One has just to remind that, for a test-graph T whose edges are labelled by $\gamma : E \rightarrow \mathcal{A}$, we have

$$\tau(T) = \Phi\left(\prod_{e \in E} \gamma(e)\right),$$

which allows to prove the positivity of the traffic space easily from the positivity of Φ . \square

9.4 Relations between the traffics of different types, conclusion

We now investigate the independence relations between traffics of tensor, Boolean and free types.

Proposition 9.9. *Let \mathcal{Y} be a family of traffics of Boolean type, traffic independent from a unital subalgebra \mathcal{Z} of traffics of free or tensor type. Then, with respect to the anti-trace, \mathcal{Z} is monotone independent from \mathcal{Y} .*

More generally, the result holds whenever the unital subalgebra \mathcal{Z} is such that $\Psi(z) = \Phi(z)$ for any $z \in \mathcal{Z}$.

Proof. For any $n \geq 2$, any z_i in \mathcal{Z} , $i = 0, \dots, n$ and any y_i in \mathcal{Y} , $i = 1, \dots, n$,

$$\Psi[z_0 y_1 z_1 \dots y_n z_n] = \tau \left[\cdot \xrightarrow{z_0} \cdot \xleftarrow{y_1} \cdot \dots \xleftarrow{z_{n-1}} \cdot \xleftarrow{y_n} \cdot \xleftarrow{z_n} \cdot \right].$$

Let π be a partition of the above test graph T such that the graph of colored components of T^π is a tree and the colored components of T^π labeled in \mathcal{Y} are tree. Then π do not identify vertices that are not extremal vertices of an edge labeled z_i , $i = 1, \dots, n$. If π does not identify two vertices of an edge labeled z_i , then one can factorizes $\tau^0[\cdot \xleftarrow{z_i} \cdot]$ in the expression of $\tau^0[T^\pi]$. But $\tau^0[\cdot \xleftarrow{z_i} \cdot] = \Psi(z_i) - \Phi(z_i) = 0$. Hence we have $\Psi[z_0 y_1 z_1 \dots y_n z_n] = \tau^0[T^\pi]$ where π is the partition identifying the source and target of each edge labeled in \mathcal{Z} . We then get

$$\begin{aligned} \Psi[z_0 y_1 z_1 \dots y_n z_n] &= \prod_{i=1}^n \tau^0 \left[\begin{array}{c} z_i \\ \circlearrowleft \end{array} \cdot \right] \times \tau^0 \left[\xleftarrow{y_1} \cdot \xleftarrow{y_2} \dots \xleftarrow{y_n} \cdot \right] \\ &= \prod_{i=1}^n \Phi(z_i) \times \Psi[y_1 y_2 \dots y_n]. \end{aligned}$$

We use in the last line the fact that τ and τ^0 coincide for test graphs labeled by traffics of Boolean types. Since $\Phi = \Psi$ for elements of \mathcal{Z} , we get the result. \square

References

- [1] Luigi Accardi, Romuald Lenczewski, and Rafal Salapata. Decompositions of the free product of graphs. *Infinite Dimensional Analysis, Quantum Probability and Related Topics*, 10(03):303–334, sep 2007.
- [2] Benson Au. Traffic distributions of random band matrices. *Electron. J. Probab.*, 23:Paper No. 77, 48, 2018.
- [3] Zhidong Bai and Jack W Silverstein. *Spectral analysis of large dimensional random matrices*, volume 20. Springer, 2010.
- [4] Itai Benjamini and Nicolas Curien. Ergodic theory on stationary random graphs. *Electron. J. Probab.*, 17:no. 93, 20, 2012.
- [5] Philippe Biane. Some properties of crossings and partitions. *Discrete Mathematics*, 175(1):41–53, 1997.
- [6] Bob Coecke, Dusko Pavlovic, and Jamie Vicary. A new description of orthogonal bases. *Mathematical Structures in Computer Science*, 23(3):555–567, 2013.
- [7] Benoit Collins and Piotr Śniady. Integration with respect to the Haar measure on unitary, orthogonal and symplectic group. *Communications in Mathematical Physics*, 264(3):773–795, 2004.
- [8] Uwe Franz. Unification of Boolean, monotone, anti-monotone, and tensor independence and Lévy processes. *Math. Z.*, 243(4):779–816, 2003.
- [9] Franck Gabriel. A combinatorial theory of random matrices III: random walks on $\mathfrak{S}(N)$, ramified coverings and the $\mathfrak{S}(\infty)$ Yang-Mills measure. *arXiv preprint*, (arXiv:1510.01046), oct 2015.
- [10] Franck Gabriel. Combinatorial theory of permutation-invariant random matrices I: Partitions, geometry and renormalization. *arXiv preprint*, (arXiv:1503.02792), mar 2015.
- [11] Franck Gabriel. Combinatorial theory of permutation-invariant random matrices II: cumulants, freeness and Lévy processes. *arXiv preprint*, (arXiv:1507.02465), jul 2015.
- [12] Anis Ben Ghorbal and Michael Schürmann. Non-commutative notions of stochastic independence. In *Mathematical Proceedings of the Cambridge Philosophical Society*, volume 133-3, pages 531–561. Cambridge University Press, 2002.
- [13] Alice Guionnet. *Large random matrices: lectures on macroscopic asymptotics*, volume 1957 of *Lecture Notes in Mathematics*. Springer-Verlag, Berlin, 2009. Lectures from the 36th Probability Summer School held in Saint-Flour, 2006.
- [14] Lothar Heffter. Ueber das Problem der Nachbargebiete. *Math. Ann.*, 38(4):477–508, 1891.
- [15] Vaughan F. R. Jones. Planar algebras, I. *arXiv preprint*, (arXiv:9909.027), 1999.
- [16] Camille Male. Traffic distributions and independence: permutation invariant random matrices and the three notions of independence. *arXiv preprint, accepted for publication at* *Memoirs of the AMS*, (arXiv:1111.4662), nov 2011.

- [17] Camille Male. The limiting distributions of large heavy Wigner and arbitrary random matrices. *Journal of Functional Analysis*, 272(1):1 – 46, 2017.
- [18] Camille Male and Sandrine Péché. Uniform regular weighted graphs with large degree: Wigner’s law, asymptotic freeness and graphons limit. *arXiv preprint*, (1410.8126), Oct 2014.
- [19] Karl Menger. Zur allgemeinen Kurventheorie. *Fundamenta Mathematicae*, 10(1):96–115, 1927.
- [20] James A. Mingo and Mihai Popa. Freeness and the transposes of unitarily invariant random matrices. *J. Funct. Anal.*, 271(4):883–921, 2016.
- [21] James A. Mingo and Roland Speicher. Sharp bounds for sums associated to graphs of matrices. *Journal of Functional Analysis*, 262(5):2272–2288, mar 2012.
- [22] Naofumi Muraki. The five independences as quasi-universal products. *Infinite Dimensional Analysis, Quantum Probability and Related Topics*, 5(01):113–134, 2002.
- [23] Naofumi Muraki. The five independences as natural products. *Infinite Dimensional Analysis, Quantum Probability and Related Topics*, 6(03):337–371, 2003.
- [24] Alexandru Nica and Roland Speicher. *Lectures on the Combinatorics of Free Probability*, volume 335 of *London Mathematical Society Lecture Note Series*. Cambridge University Press, 2006.
- [25] Dylan Rupel and David I. Spivak. The operad of temporal wiring diagrams: formalizing a graphical language for discrete-time processes. *ArXiv e-prints*, July 2013.
- [26] Roland Speicher. On universal products. In *The Fields Institute Communications*. Citeseer, 1997.
- [27] David I. Spivak. The operad of wiring diagrams: formalizing a graphical language for databases, recursion, and plug-and-play circuits. *arXiv e-prints*, (1305.0297), May 2013.
- [28] David I. Spivak. The steady states of coupled dynamical systems compose according to matrix arithmetic. *ArXiv e-prints*, December 2015.
- [29] Richard P. Stanley. *Enumerative combinatorics. Volume 1*, volume 49 of *Cambridge Studies in Advanced Mathematics*. Cambridge University Press, Cambridge, second edition, 2012.
- [30] Dmitry Vagner, David I. Spivak, and Eugene Lerman. Algebras of open dynamical systems on the operad of wiring diagrams. *Theory Appl. Categ.*, 30:Paper No. 51, 1793–1822, 2015.
- [31] Dan-Virgil Voiculescu. Limit laws for random matrices and free products. *Invent. Math.*, 104(1):201–220, 1991.
- [32] Dan-Virgil Voiculescu. Free probability for pairs of faces I. *Comm. Math. Phys.*, 332(3):955–980, 2014.
- [33] Don Weingarten. Asymptotic behavior of group integrals in the limit of infinite rank. *Journal of Mathematical Physics*, 19(5):999, 1978.

- [34] Donald Yau. *Operads of wiring diagrams*, volume 2192 of *Lecture Notes in Mathematics*. Springer, Cham, 2018.