



HAL
open science

ON THE SIZING OF BUILDING ENVELOPPE AND ENERGY SYSTEM INTEGRATING MANAGEMENT STRATEGY IN SKETCH PHASE

van Binh Dinh, Benoît Delinchant, Frédéric Wurtz

► **To cite this version:**

van Binh Dinh, Benoît Delinchant, Frédéric Wurtz. ON THE SIZING OF BUILDING ENVELOPPE AND ENERGY SYSTEM INTEGRATING MANAGEMENT STRATEGY IN SKETCH PHASE. Building Simulation 2015, Dec 2015, Hyderabad, India. hal-01245078

HAL Id: hal-01245078

<https://hal.science/hal-01245078v1>

Submitted on 20 Apr 2020

HAL is a multi-disciplinary open access archive for the deposit and dissemination of scientific research documents, whether they are published or not. The documents may come from teaching and research institutions in France or abroad, or from public or private research centers.

L'archive ouverte pluridisciplinaire **HAL**, est destinée au dépôt et à la diffusion de documents scientifiques de niveau recherche, publiés ou non, émanant des établissements d'enseignement et de recherche français ou étrangers, des laboratoires publics ou privés.

ON THE SIZING OF BUILDING ENVELOPPE AND ENERGY SYSTEM INTEGRATING MANAGEMENT STRATEGY IN SKETCH PHASE

Van-Binh Dinh, Benoit Delinchant, and Frederic Wurtz
Univ. Grenoble Alps, CNRS, G2Elab, F-38000 Grenoble, France

ABSTRACT

This paper presents a methodology of simultaneous sizing of building envelope and heating system integrating management strategies in sketch phase. This method uses a global optimization approach taking into consideration a lot of parameters and constraints. Our goal is to implement it in performance software tools, which allow architects and designers to analyze and quickly compare design solutions taking into account the cost over the building life cycle (including the envelope investment, heating system investment and operating cost) with respect to the need of comfort and budget. These tools are being developed and are valued as part of Vesta-System company (www.vesta-system.fr). Collaborations between academics are of course possible and established case by case. Our study in this paper is a building in Grenoble, France.

INTRODUCTION

For completely new buildings, it is essential to have a global vision in the sketch phase for sizing the envelope and the heating system taking into account the long-term cost. The classic method is very sequential: it just takes in consideration the system after the envelope design. In the past, the building envelope was designed without taking into account the energy consumption strategy in operation phase and its possible optimization. The recent studies begin to consider optimization approaches in design phase. Comakli and Yükelas (e.g. Comakli et al., 2002) focuses on the optimum insulation thickness of external walls to minimize the insulation investment and energy consumption cost which is simply calculated thanks to the heat loss. Karaguzel, Zhang and Lam (e.g. Karaguzel et al., 2013) couples EnergyPlus whole-building energy simulation program with GenOpt generic optimization tool to search the optimum insulation thickness of external wall and roof, glazing unit types, solar heat gain coefficient and visible transmittance for minimizing the life cycle cost etc. However, in any case the heating system cost has not been integrated in the global cost and the nominal heating power choice also has not been mentioned. The size of heating system is in reality oversized according to EN 12831 which calculates the heat loss in steady state conditions assuming constant properties, such as values for temperature, characteristics of building elements etc. The oversized equipment has a higher first-cost, also costs more to operate due to increased cycling losses.

In this paper, we propose the optimal design of building envelope and heating system at the same time thanks to a global optimization. In our study, we consider the global cost over the life cycle composed of the envelope investment cost, heating system investment, maintenance, replacement costs and the cost of energy bought from the grid, which helps designers to have a good vision about components cost in the initial phase of design process. Thanks to the simultaneous sizing, we hope to find out the optimal solutions with a best combination of the envelope parameters and heating system for minimizing the global cost and maximizing the thermal comfort. In other words, this is a multi-objective optimization problem. Hence, we will not only seek to ensure the perfect thermal comfort regardless of cost but also we will propose many optimal solutions according to the need of comfort and the budget. In addition, the size of heating system will be optimally chosen by taking into account the smart management that will be implemented in the building: this is the real novelty and originality of the approach we propose. As a result, our approach will help to support the decision instead of a choice based on the oversizing. Regarding the envelope parameters, we will not only consider the internal and external insulation thickness of wall, roof, floor, solar heat gain coefficient (SHGC) and window area but also the inertia thickness. The inertia will be considered as a cooling solution in summer while the winter comfort will be assured by the heating system. All tasks will be carried out in the sketch phase.

ENERGY SKETCH PHASE

Position and role of energy sketch phase

The energy sketch phase is the first step of the building design process (Figure 1).

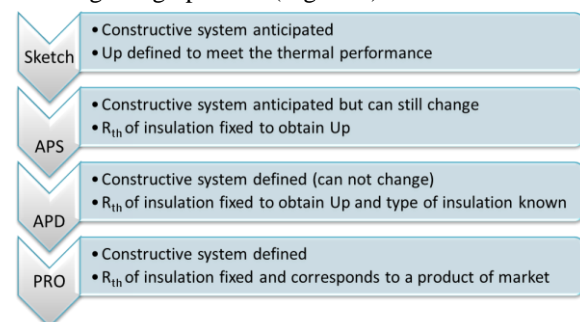

Figure 1 Position of the energy sketch phase in the building design process

Its goal is to roughly pre-design characteristics of the building envelope and of the energy system. Theoretical studies (e.g. Visser et al., 2004) showed that the sketch phase, and all the initial designs phases, represents only 5% of the final project cost, but have a significant impact (75%) of the total project expenses. Therefore, it is important to explore, in this phase, as many possibilities as possible in order to obtain a good building sketch up which supports the next phases of the design process.

Problematic of design in the sketch phase

There are many difficulties to solve in the sketch phase (e.g. Wurtz et al., 2013):

- the building, and the project in general, is not well defined and precisely defined, it is just sketched;
- the designer must use an effective model, with a right level of precision, in order to explore different solutions with an optimization tool;
- in the same time the model mustn't be too accurate, because all the parameter's building are not known;
- the simulation must be done on the life cycle cost.

As an illustration, we lack of information about the building in the sketch phase such as building orientation, number of stages.... Or we must obtain cost equations related to sizing parameters without the knowledge of material. All of them are major challenges for designers in this initial phase.

Proposed solutions of modelling: the necessity of choosing the right level of complexity for the models

Jan Hensen was one of 17 participants to the Expert Meeting, which is organized in 2012 at University of Strathclyde, Glasgow (UK), on "Evaluating and Modelling Near-Zero Energy Building; are we ready for 2018?". At this meeting, he gave his point of view by the presentation: "Building performance simulation: current state and challenges", (e.g. Hensen et al., 2012). According to him, there is a wide-spread misconception that increasing the model complexity will decrease the uncertainty of the results. He and his colleague (e.g. Trcka et al., 2010) have insisted that the required validity will be met by the model depends not only on the system modelling complexity, but also on the available system knowledge. Indeed, higher explicitness in system representation requires more knowledge about the system because of the increasing number of model parameters for system specification, often difficult to obtain. If the modelled system is well known, the input parameters are less uncertain and the rate of increasing predictive uncertainty with model complexity is low. In contrast, it will increase the predictive uncertainty. They showed in Figure 2 that with the increase of modelling complexity, the models approach reality and the bias decreases but

the predictive uncertainty rises as there are more parameters to consider. Hence, the minimal total error obtained is not for the too complex model. Moreover, an increase in model complexity increases the cost of using the model. Thus, they concluded that the model should be of the lowest complexity while preserving its validity for the intended simulation objectives.

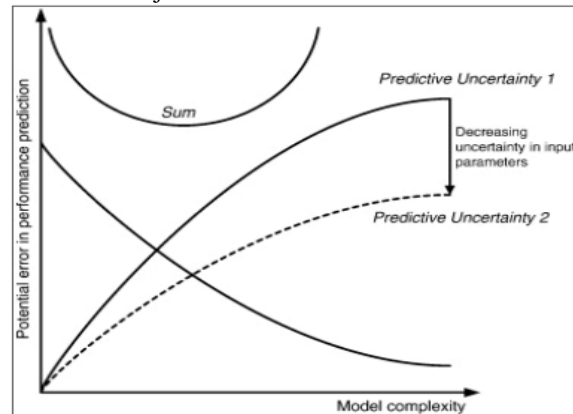

Figure 2 Potential errors in performance prediction vs. model complexity/level of detail

Furthermore, the modelling of building envelope in the form of an electrical equivalent circuit RC has been used from the mid-1980s. This method uses the thermal-electrical analogy to analyse transient state of thermal building systems. The modelling has good accuracy and robustness, as well as simplicity (e.g. Park et al., 2013).

Sharing this analysis, results in selecting a complexity of model that should not be too high, especially for sketch phases in which by definition, the details of the projects are not available. Thus, our choices of models (typically electrical equivalent model for the envelope) result from all the previous considerations.

Modelling of the thermal envelope by electrical equivalent circuit

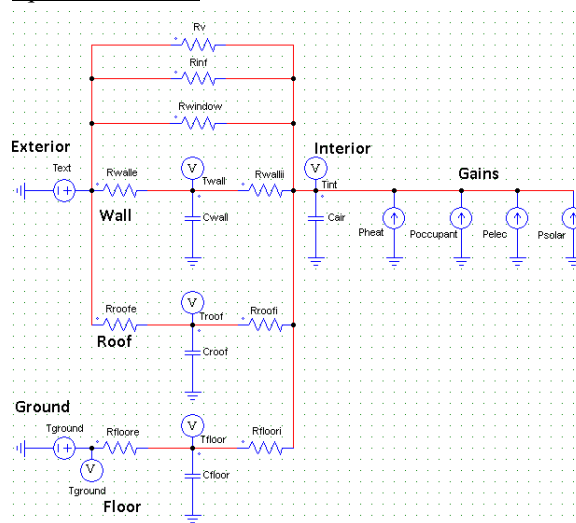

Figure 3 Electrical equivalent circuit

The electrical equivalent circuit (Figure 3) considers the resistances and capacitances as the insulations and inertias respectively of the building. These resistances and capacitances of the circuit depend on the constructor parameters and can be analytically expressed by equations (e.g. Dang et al., 2013):

$$R = \frac{e_R}{\lambda \cdot S} \quad (1)$$

$$C = \rho \cdot e_c \cdot S \cdot C_p$$

In previous equation R, C are the resistance (K/W) and the capacitance (J/K) respectively; e_R and e_C are the insulation and inertia thickness (m); λ is the thermal conductivity (W/(m.K)); S is the wall surface (m²); ρ is the mass density (kg/m³); C_p is the specific heat (J/(kg.K)).

The electrical equivalent circuit is firstly integrated in PSIM software¹. This circuit is saved as a “netlist” (a standard format for electrical circuit description). Starting from it, the model equations and simulation are generated automatically, as well as the jacobian, thanks to Thermotool (an experimental software developed in our team). Indeed, the equation system is transformed using a dedicated scheme for time integration of the form:

$$A.T(t) = B.U(t) + C.T(t-1) \quad (2)$$

where $T(t)$ and $T(t-1)$ contain the interior, wall, roof and floor temperatures at hour t and t-1 respectively; $U(t)$ includes sources of temperature (ground and exterior temperature) and gains (heat, occupant, electrical equipment, and solar gains); A, B, C are incidence matrix that represents all the circuit elements (resistances and capacitances included) and nodes to which they relate. It is to be noted that the heat gain is generated by the heating system for heating the building in winter. Meanwhile the solar gain is computed from the solar radiation admitted through windows. The thermal envelope model allows to dynamically calculate the interior temperature at each time t and then thermal discomfort for each scenario of external temperature, heating system power, building parameters (insulation, inertia), which will be used for the design.

Modelling of cost equations

Envelope investment cost

In this study, the envelope cost consists of the investment cost of insulation, inertia, window. Nonetheless, once the material is not still chosen, it is a challenge to have a cost function depending to the envelope parameters: cost of wall inertia for example. Then, we have decided to start working with a defined material (eg concrete for walls), for which we can obtain an average price:

$$Cost_{inertia_wall} = e_{Cwall} \cdot S_{wall} \cdot c_{unit_inertia} \quad (3)$$

In which, $Cost_{inertia_wall}$ is the investment cost of wall inertia (€); e_{Cwall} is wall inertia thickness (m); S_{wall} is the wall surface (m²); $c_{unit_inertia}$ is the unit cost of inertia (€/m³).

We have defined a price related to the inertia based on concrete material. We will take into consideration the concrete thickness in the range [10cm; 100cm] for the optimization problem. But if the optimization result obtains at the concrete lower limit (10cm here), it is the signal that concrete is not the good material and a more light structure like wood would be better. In that case, the optimization will be taken with the wood.

For the heating system, its cost function depends on the initial capital cost, the present value of replacement cost, the present value of operation and maintenance cost. Therefore, the cost of heating system $Cost_{heat}$ (€) is expressed as follows:

$$Cost_{heat} = C_{inv_heat} + C_{rep_heat} + C_{OM_heat} \quad (4)$$

Initial capital cost of heating system

The initial capital cost of the heating system C_{inv_heat} (€) is linear with the size of system:

$$C_{inv_heat} = Heat_size \cdot c_{unit_heat} \quad (5)$$

Where $Heat_size$ and c_{unit_heat} are the nominal power (W) and unit cost (€/W) of the heating system.

Replacement cost of heating system

The present value of replacement cost of heating system C_{rep_heat} (€) depends on its life cycle and can be expressed by (e.g. Kamjoo et al., 2012):

$$C_{rep_heat} = C_{inv_heat} \cdot \sum_{i=1}^{N_{rep}} \left(\frac{1+f}{1+k_d} \right)^{LC \cdot i} \quad (6)$$

In which, f is the inflation rate (8%) of system replacements; k_d is the annual real interest rate (4%); LC is the life cycle of system (years); N_{rep} is the number of system replacements over the building life period (L_p years), which can be given by the following equation (e.g. Ramoji et al., 2014):

$$N_{rep} = floor \left[\frac{L_p - 1}{LC} \right] \quad (7)$$

Operation and maintenance cost of heating system

The present value of operation and maintenance cost

¹ <http://powersimtech.com/products/psim>

C_{OM_heat} (€) is taken into consideration as follows:

$$C_{OM_heat} = k \cdot C_{inv_heat} \cdot \frac{1+f}{k_d - f} \cdot \left[1 - \left(\frac{1+f}{1+k_d} \right)^{L_p} \right] \quad k_d \neq f \quad (8)$$

$$C_{OM_heat} = k \cdot C_{inv_heat} \cdot L_p \quad k_d = f$$

The value of k is assumed to be as 1%.

The present value of buying electricity from grid

The electricity bill at the initial year C_{grid0} (€) is described by:

$$C_{grid0} = \sum_{t=1}^T \left(\frac{P_{grid}(t)}{1000} \cdot c_{grid}(t) \right) \cdot \frac{8760}{T} + c_{subs} \quad (9)$$

Where $c_{grid}(t)$ expresses the electricity unit price (€/KW) at step t; c_{subs} is the subscription cost (€) with the electrical producer; T is the computing period; $P_{grid}(t)$ is the electrical power bought from grid (W).

As a result, the cost of buying electricity over the building life period is deduced by:

$$C_{buy,grid} = \sum_{i=1}^{L_p} \left[C_{grid0} \left(\frac{1+f}{1+k_d} \right)^{i-1} \right] \quad (10)$$

PROBLEM FORMULATION TO SOLVE

Objective Function

In reality depending from the climate of the area in which they are localized, many buildings are built for more comfort in summer. The others are designed for more comfort in winter. Our study takes in account the design for the comfort of all season. Furthermore, the final objective is to minimize the global cost over the life cycle and maximize the thermal comfort, which is a trade-off. Consequently, we choose the multi-objective approach as an efficient method. The global problem can be formulated as follows:

$$\min fobj = \alpha \cdot \overline{discomf} + (1-\alpha) \cdot \overline{LCC} \quad (11)$$

where \overline{LCC} is the normalized global cost over the life cycle (composed of the envelope investment cost, heating system investment, maintenance, replacement costs and the cost of energy bought from the grid):

$$\overline{LCC} = \frac{LCC}{LCC_{max}} \quad (12)$$

LCC_{max} can be chosen thanks to the simulation such that \overline{LCC} and $\overline{discomf}$ have the same order of

magnitude. $\overline{discomf}$ expresses the sum of winter thermal discomfort normalized $\overline{discomf}_{winter}$ (°C) and summer thermal discomfort normalized $\overline{discomf}_{summer}$ (°C) which are defined as follows:

$$\overline{discomf}_{winter} = \frac{1}{T_w} \sum_{t=1}^{T_w} \frac{e_T(t)}{\max |e_T(t)|} \quad (13)$$

for $e_T(t) > 0$

$$\overline{discomf}_{summer} = \frac{1}{T_s} \sum_{t=1}^{T_s} \frac{e_T(t)}{\max |e_T(t)|} \quad (14)$$

for $e_T(t) < 0$

With $e_T(t)$ is the difference between the interior temperature and the set point temperature at hour t:

$$e_T(t) = (T_{set}(t) - T_{int}(t)) \quad (15)$$

T_s and T_w are the computing period in winter and summer respectively. The thermal discomfort is increasing when the building inside temperature is smaller, respectively greater, than the set point value in winter, respectively in summer.

$\alpha \in [0;1]$ is the weight adjusting the compromise between the 2 optimization criterions.

Example of investigated design and management parameters

In this study, we suppose at the beginning that the building is constructed by concrete material and insulated by glass wool material. Therefore, their thermal conductivity, the mass density, the specific heat are known. The design parameters considered for wall, roof and floor are the thicknesses of insulation and inertia materials. Table 1 describes the list of optimization parameters and their range of values. For example, $eSext_wall$ (m) is the external insulation thickness of wall made by glass wool; $eCwall$ (m) is the inertia layer thickness in the wall made by concrete. In this table, it is to note that all design parameters concerning 'thickness' are expressed in the equation 1. The internal and external insulation thicknesses are considered as separating optimization parameters. In this study, we also optimize the inertia which can be a technique for cooling the building in summer without an active cooling system. The window orientation and size are interesting to take into account because of their influence on the solar gain in winter and summer. In this paper, the optimization will be done on two typical weeks (one of winter and one of summer) with a time step of one hour. Thus, we will carry out making the management of heating power at each hour of the winter days (168 management parameters). This period is extrapolated over one year and the building is supposed to be uses 50 years. Thanks to the management using the typical week,

the size of heating system will be optimally chosen with the dynamic calculation.

Table 1
Optimization parameters

ITEM	PARAMETER	RANGE OF VALUES
1	External insulation thickness of wall (<i>eISext_wall</i>) (m)	[0.03;0.3]
2	Internal insulation thickness of wall (<i>eISint_wall</i>) (m)	[0.03;0.3]
3	External insulation thickness of roof (<i>eISext_roof</i>) (m)	[0.03;0.3]
4	Internal insulation thickness of roof (<i>eISint_roof</i>) (m)	[0.03;0.3]
5	External insulation thickness of floor (<i>eISext_floor</i>) (m)	[0.03;0.3]
6	Internal insulation thickness of floor (<i>eISint_floor</i>) (m)	[0.03;0.3]
7	Inertia thickness of wall (<i>eCwall</i>) (m)	[0.1;1]
8	Inertia thickness of roof (<i>eCroof</i>) (m)	[0.1;1]
9	Inertia thickness of floor (<i>eCfloor</i>) (m)	[0.1;1]
10	Window area in South (<i>AwindS</i>) (m ²)	[0;30]
11	Window area in North (<i>AwindN</i>) (m ²)	[0;30]
12	Window area in East (<i>AwindE</i>) (m ²)	[0;30]
13	Window area in West (<i>AwindO</i>) (m ²)	[0;30]
14	<i>SHGC</i>	[0.1;0.9]
15	Nominal heating power (<i>Heat_size</i>) (W)	[0;20000]

Example of constraints

In this study, there are 337 constraints for the optimization problem. For the envelope, the total window area must be bigger than 1/6 the living surface of building. For the heating, the power at each hour can not exceed the nominal power...

Optimization problem of big size and optimization tool

The problem considered is a nonlinear optimization problem. Indeed, regarding the equation 1 for example, the resistance depends on one parameter at numerator (wall insulation thickness) and one parameter at denominator (wall surface). Moreover, this is also an optimization problem of big size with 183 parameters and 337 constraints. Therefore, we decide to choose the deterministic algorithm SQP (Sequential Quadratic Programming) to solve it. This algorithm allows to solve problems very quickly in which we discretized state variables (temperature for example) on two operating weeks with a time step of 1h. In the sketch phase, the rapidity is very important because the designers would like to quickly compare solutions and modify the formulation of the problem. Finally, the problem models are modular and

integrated in the gradient-based optimization software Cades (e.g. Delinchant et al., 2007).

RESULTS

Regarding the equation 11, we can obtain the different solutions according to the thermal comfort need or the cost by varying the weight α . As an illustration, we show optimization results in Table 2 for $\alpha = 0.7$ and $\alpha = 0.9$.

Table 2
Optimization results

OPTIMIZATION	$\alpha = 0.7$	$\alpha = 0.9$
GLOBAL COST USED IN DESIGN (€)	59939	79783
WINTER MEAN DISCOMFORT (°C)	0.13	0.02
SUMMER MEAN DISCOMFORT (°C)	0.84	0.67

Firstly, it is observed in Table 2 that when we spend more money, we receive more thermal comfort. Our result shows that if we accept a little more discomfort, we can save 25% of the global cost. This approach is able to support the designers to choose the solution which is appropriate to their wishes. It is noticed that, in any case, the comfort in summer is a bit little less than in winter because we do not use the air-conditioning system for summer. The cooling is primarily obtained thanks to the inertia of wall, roof and the limit of solar gain through windows. Meanwhile, the heating system is available in winter, and it is controlled to satisfy the comfort demand at each hour.

Secondly, Figure 4 illustrates the components cost contributing to the global cost over the life cycle.

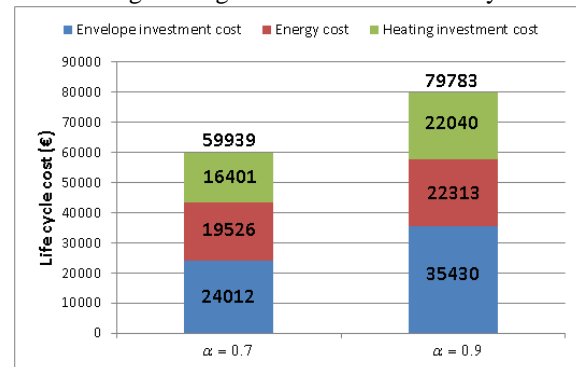

Figure 4 Components cost over the life cycle

As be seen in this figure, in order to obtain more comfort (case $\alpha = 0.9$ compared to case $\alpha = 0.7$), the cost of each component increases significantly. For instance, the cost of envelope (insulation, inertia, window) steps up from 24 thousand € to 35 thousand €.

Figure 5 indicates a change of structure of components cost from the case of $\alpha = 0.7$ to the

case of $\alpha = 0.9$. With $\alpha = 0.7$, the envelope investment cost includes about 40% of total cost over the life time while the energy consumption cost account for 33%. With $\alpha = 0.9$, the proportion of envelope investment increases to 45% of the global cost while the energy cost decreases to 28%. From this analysis, we have a global vision on the price over 50 years for each scenario considered.

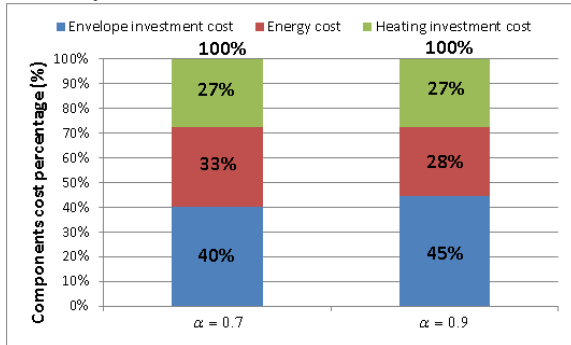

Figure 5 Components cost percentage over the life cycle

Thirdly, we analyze the optimum configurations of envelope and system for 2 cases of weight α , which are presented in Figure 6.

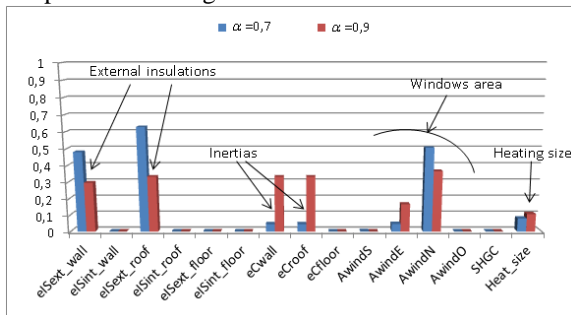

Figure 6 Normalized optimized parameters

In this figure, we use the normalization of parameters. The name of parameters is explained in Table 1. It is found that when we want to have more comfort (case $\alpha = 0.9$ compared to case $\alpha = 0.7$) for whole year, the inertias of wall and roof increase to cool the building in summer and the heating system size also rises to heat the building in winter. Concerning the windows, in any case of α , it is seen in Figure 6 that their surfaces are toward East and North but not toward South. This solution is consistent because the management of window opening and cooling system are not taken into account in this study. Therefore, the windows should not be toward South in order to avoid the solar gain in summer which overheats the building. The loss of this solution is the fact that we do not benefit the free solar gain for the building in winter but the heating system can be activated to assure the desired comfort. Regarding the insulations, the optimization result shows that wall and roof should be insulated from the outside (externally) and not from the inside

(internally) to enable the inertia operation. In summary, the combination of envelope (insulations, inertias, windows) and heating system is optimal for each case of comfort and cost.

Finally, we mention the smart management supporting to choose the optimal heating system size. In fact, we made the control strategy of the interior temperature of building for one typical winter week for each case of α . As an illustration below, we show the interest of our smart management method compared to the conventional method with $\alpha = 0.95$. Figure 7 presents the interior temperature of building at each hour controlled by the heating power in Figure 8.

The conventional method requires that the interior temperature must be equal to the set point at each hour. As a result, Figure 7 shows that the building interior temperature with this method (red curve) keeps track of the set point (black curve) at each time step t . To obtain that, the heating system is turned on and off (red curve in Figure 8) according to the need of comfort at each hour without the prediction. Thus, there are heating power peaks when the exterior temperature is so low (at $t=55$ for example). Consequently, we have a heating system of big size which requires a high investment cost.

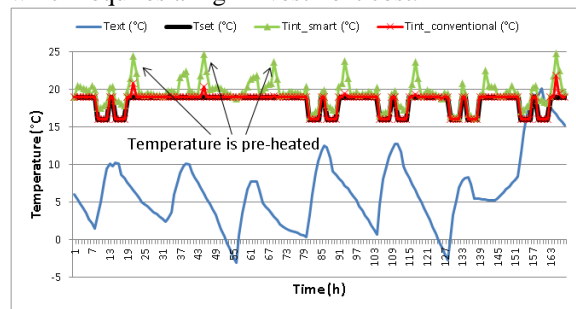

Figure 7 Controlled temperature with conventional method and smart method

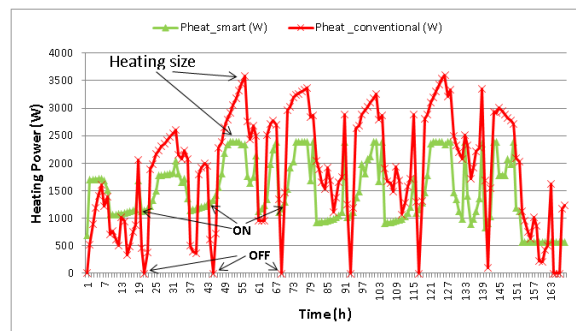

Figure 8 Heating power with conventional method and smart method

Our smart method says that the discomfort is only increasing when the interior temperature is smaller than the set point. The optimization predicts when the exterior temperature is very low and decides to turn on earlier the heating system ($t=45$ in Figure 8 for instance) to pre-heat the interior temperature ($t=45$ in

Figure 7). Thanks to the inertias, the heat can be stored and then released later, which helps to avoid a high peak of heating power. Although this method causes a light increase of energy consumption but the global cost with this smart method is 12% smaller than with the conventional method due to the decrease of the heating system investment cost. Therefore, the heating system size is chosen based on the smart optimal management strategy and is not an oversizing.

CONCLUSION

In conclusion, we have proposed a new design method of building envelope and heating system integrating the management strategy in the sketch phase. The difficulties in establishing models in the initial phase of design process were given and the solving approaches were proposed. We also showed that the optimization problem considered has the big size with many parameters and constraints and we succeed to solve it with the approach that we propose. The results give many optimal solutions for the cost and the human comfort. For each solution, this paper helps designers to have a general vision on the global cost by showing the envelope investment cost, system investment and operation cost over the building life cycle. The optimal configurations of insulations, inertias, windows and heating system were also illustrated for the different demand of thermal comfort. Finally, we indicated that the heating system was sized thanks to the smart management and not chosen based on the calculation of heat loss. The limit of use of this method now concerns the size of the formulated problem for design. Indeed, the size of the formulated problem in this study was only for two typical weeks. Our perspective is to formulate and to solve the problem for one year.

REFERENCES

- Wurtz F., Pouget J., Brunotte J., Gaulier M., Rifonneau Y., Ploix S., L'Henoret B., 2013. Sketch systemic optimal design integrating management strategy, thermal insulation, production and storage energy systems (thermal and electrical): Application to an energy-positive train station, Grenoble Electrical Engineering Laboratory, France.
- Visser W., 2004. Dynamic Aspects of Design Cognition: Elements for a Cognitive Model of Design, INRIA, Rapport de recherche N°5144, Grenoble, France.
- Comakli K., Yükelas B., 2002. Optimum insulation thickness of external walls for energy saving, Ataturk University, Erzurum, Turkey.
- Karaguzel, O.T., Zhang R., Lam, K.P., 2013. Coupling of whole-building energy simulation and multi-dimensional numerical optimization for minimizing the life cycle costs of office buildings, Carnegie Mellon University, Pittsburgh, USA.
- Dang, H.A, Gaaloul S., Delinchant B., Wurtz F., 2013. Building simulation of energy consumption and ambient temperature : Application to the Predis platform, Grenoble Electrical Engineering Laboratory, France.
- Delinchant B., Duret D., Estrabaut L., Gerbaud L., Nguyen Huu H., Du Peloux B., Rakotoarison H.L., Verdier F., Bergeon S., Wurtz F., 2007. An Optimizer using the Software Component Paradigm for the Optimization of Engineering Systems, Grenoble Electrical Engineering Laboratory, France.
- BS EN 12831:2003 Heating systems in buildings-Method for calculation of the design heat load.
- Kamjoo A., Maheri A., Putrus, G.A., Dizqah, A.M., 2012. Optimal sizing of grid-connected hybrid wind-PV systems with battery bank storage, Northumbria University, Newcastle upon Tyne, UK.
- Ramoji, S.K., Kumar, B.J., 2014. Optimal Economical sizing of a PV-Wind hybrid Energy System using Genetic Algorithm and Teaching Learning Based Optimization, Centurion University, Paralakhemundi, Odisha, India.
- Hensen J., 2014. Building performance simulation: current state and challenges, Eindhoven University of Technology, Netherlands.
- Trcka M., Hensen J., 2010. Overview of HVAC system simulation, Eindhoven University of Technology, Netherlands.
- Park H., 2013. Dynamic Thermal Modeling of Electrical Appliances for Energy Management of Low Energy Buildings, University of Cergy Pontoise, Korea.