



HAL
open science

A level set model for the numerical modeling of composite delamination with nonconforming mesh and minimal remeshing

Elia Picault, Patrick Rozycki, Bastien Tranquart

► **To cite this version:**

Elia Picault, Patrick Rozycki, Bastien Tranquart. A level set model for the numerical modeling of composite delamination with nonconforming mesh and minimal remeshing. 20th International Conference on Composite Materials - ICCM20, Jul 2015, Copenhagen, Denmark. hal-01240730

HAL Id: hal-01240730

<https://hal.science/hal-01240730>

Submitted on 9 Dec 2015

HAL is a multi-disciplinary open access archive for the deposit and dissemination of scientific research documents, whether they are published or not. The documents may come from teaching and research institutions in France or abroad, or from public or private research centers.

L'archive ouverte pluridisciplinaire **HAL**, est destinée au dépôt et à la diffusion de documents scientifiques de niveau recherche, publiés ou non, émanant des établissements d'enseignement et de recherche français ou étrangers, des laboratoires publics ou privés.



Distributed under a Creative Commons Attribution 4.0 International License

A LEVEL SET MODEL FOR THE NUMERICAL MODELING OF COMPOSITES DELAMINATION WITH NONCONFORMING MESH AND MINIMAL REMESHING.

E. Picault ¹, P. Rozycki ¹ and B. Tanquart ²

¹ Ecole Centrale de Nantes, GeM Institut, UMR CNRS 6183,
1 rue de la Noë, F-44321 Nantes, France.

Emails : elia.picault@ec-nantes.fr and patrick.rozycki@ec-nantes.fr

Web page : <http://gem.ec-nantes.fr/>

² SAFRAN Composites, 33 rue de la Gare, F-91790 Itteville, France.

Email : bastien.tranquart@safran.fr

Web page : <http://www.safran-group.com/>

Keywords: delamination, composite, level set method, crack propagation, finite element analysis.

ABSTRACT

Delamination is one of the main failure processes for composite laminates. Modeling progressive delamination of such materials is thus of particular interest. A new approach has been proposed by F. P. van der Meer *et al.* a few years ago, which allows for the use of elements larger than the cohesive zone. With this method, the crack front is represented implicitly using a level set field whereas the cohesive zone is supposed to reduce to a line. Consequently, the crack front does not have to remain aligned with the mesh and remeshing is no longer necessary. Weak discontinuities are inserted in the displacement field at crack front location, allowing for a sharp transition between the cracked and uncracked parts. Crack growth is driven by an explicit energy-based relation in which the configurational force is defined as the jump in Eshelby tensor over the front. In this paper, we investigate the case of isotropic multilayered membranes with several crack fronts evolving independently or interacting with each others.

1. INTRODUCTION

In numerical simulations of the delamination process of composite materials especially or of multi-materials with strong interfaces more generally, the methodology used in the industry usually consists in using interface elements such as cohesive ones. This approach can be time consuming or lead to mesh size problems, which currently limits the dimension of parts that can be optimized in the pre-design stage of an industrial project. Moreover, the use of interface elements also requires a mesh conforming with the delamination front which implies frequent remeshing as the front propagates or a sufficiently fine mesh in a potentially large area.

In order to avoid that, an interesting approach has been proposed by F. P. van der Meer *et al.* [1, 2]. The central idea is to use an implicit description of the delamination front based on a level set field while assuming that the cohesive zone reduces to a line. As a consequence of this choice, the front does not need to remain aligned with the mesh and larger elements can be used in the front vicinity whereas crack growth can be driven using an explicit energy-based criterion which brings in the jump in Eshelby tensor over the configurational interface (see Figure 1). At the delamination front, Heaviside enriched elements or duplicate partially active elements are used to allow for a strong discontinuity in the displacement field across the front whereas several techniques can be used to close the gap and come down to the desired weak discontinuity.

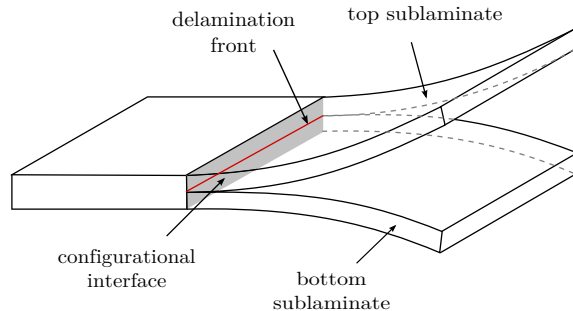

Figure 1. Partially delaminated plate.

This model showed good results in agreement with cohesive zone ones for the two-dimensional case of a membrane under tension but it has some restrictions. To begin with, solely one level set (i.e. delamination front) was introduced in the numerical examples treated in [1] and [2]. Furthermore, the three-dimensional case was not really considered since it was shown in [2] that the question of characterizing the fracture toughness for mixed-mode delamination of composites was still an open one.

In this paper we consider the case of several delamination fronts growing simultaneously. In the next section, the model of a partially delaminated plate with several delamination fronts growing in the same interface and interacting with each others will be presented. In the last section, some results from several numerical simulations will be analyzed.

2. BILAYER PARTIALLY DELAMINATED MEMBRANE

The approach presented by F. P. van der Meer *et al.* is based on two models solved in a staggered fashion. First, a partially delaminated membrane model with given crack location is solved for displacements using the extended or classical finite element method and a gap closure technique. Second, the normal velocity on the front is computed in order to determine crack growth. The level set field is then updated to match the new crack front location. Reinitialization of the level set field is also necessary after several time steps in order for it to remain a signed distance function.

The second step is relatively cheap in terms of computational effort compared to the global solve in the first step [1]. The algorithm for a single time step is thus more efficient than for cohesive methods, for which the global solve has to be repeated several times per time step in an iterative scheme. Moreover, this gain in efficiency comes on top of the primary gain due to possible increase in element size.

2.1. Partially cracked laminate model

In a partially cracked plate with only one crack location, the damaged and intact areas are separated by the crack front location described implicitly with a level set field denoted by Φ . This level set field is defined as the signed distance function to the front Γ such that :

$$|\nabla\Phi| = 1 \text{ on } \Omega \quad \text{and} \quad \Phi = 0 \text{ on } \Gamma. \quad (1)$$

In next subsection, we will see how Φ evolves in time but at this point it is assumed to be given. The plate is delaminated where $\Phi > 0$ and intact where $\Phi < 0$. Hence, the crack front is located where $\Phi = 0$ as illustrated in Figure 2.

In the case of a plate with n crack fronts growing in the same interface and described implicitly by the n level set fields Φ_i , the damaged and intact areas will be defined thanks to a main level set Φ . This new level set is defined as the combination of the n other level sets: at each node of the mesh, only the value associated to the nearest level set is considered (*i.e.* the highest value). Consequently,

the intact area will be where all level set fields take negative values: $\Phi_i < 0 \forall i \in [1, n]$, whereas the damaged area will be where at least one level set field take positive values: $\exists i \in [1, n]$ tel que $\Phi_i > 0$.

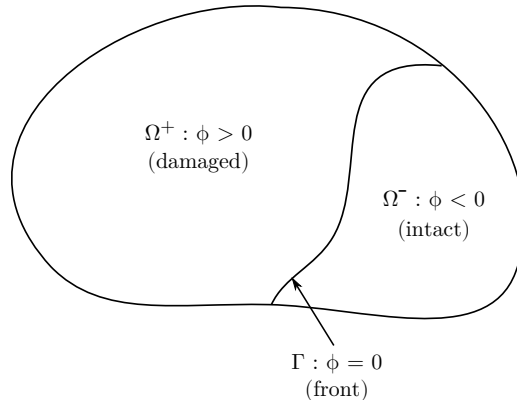

Figure 2. Implicit definition of crack front using level set Φ .

Away from the fronts implementation of the delamination model is straightforward. In the damaged area, two layers of standard finite elements are defined and associated to the displacement fields u_{top} and u_{bot} . In the intact area, only one layer of element can be defined in the case of an homogeneous material or an homogenized constitutive law (associated to the displacement field u^-) whereas two layers of elements should be defined in the case of plies with different material properties. In this case, the top and bottom layers must be linked thanks to kinematic constraints (u_{top} and u_{bot} should be equal in the intact area).

At each front location, a weak discontinuity in the displacement field associated to a jump in strain must be represented. In the elements cut by one of the delamination fronts, a non-standard formulation is thus required. When using level sets, embedding weak discontinuities in the element formulation can be done by enriching the finite element basis with special functions having a discontinuity in their derivative exactly where $\Phi = 0$. However this is not working in our case where the two fields u_{top} and u_{bot} would have to be equal in the intact part of the enriched elements and not equal in the damaged part of the elements (see [1] for more details).

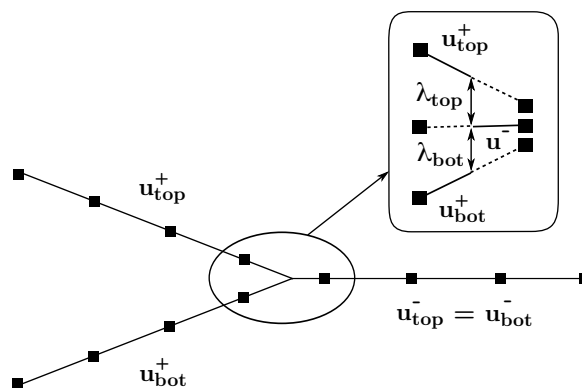

Figure 3. Discretisation of the domain with duplicate partially active elements.

A solution to this problem is to introduce a strong discontinuity in the element formulation and to use a gap closure technique to constrain the jumps that may appear. This strong discontinuity can be obtained with an Heaviside enrichment [3] or using duplicate partially active elements [4] as done in [1] and in this paper. This means that the elements cut by the front consist in four layers of elements that are only partially active as shown in Figure 3 (*i.e.* integration will be done only on the adequate part of the element for each layer using sub-triangulation). For gap closure, several approaches were considered in [1] such as Lagrange multipliers, Nitsche's method and a traction formulation. We choose

here to use Lagrange multipliers, which implies to be careful when defining the Lagrange multiplier space as mentioned by Meer *et al.* and showed in [5].

The complete displacement field finally consists in three independent vector fields $\mathbf{u}_{\text{top}}^+$, $\mathbf{u}_{\text{bot}}^+$ and \mathbf{u}^- or four dependent vector fields $\mathbf{u}_{\text{top}}^+$, $\mathbf{u}_{\text{bot}}^+$, $\mathbf{u}_{\text{top}}^-$ and $\mathbf{u}_{\text{bot}}^-$ depending on how the intact area has been modeled. The positive sign superscript is associated to the damaged area ($\Phi \geq 0$), whereas the negative sign superscript is associated to the intact area ($\Phi \leq 0$). In 2D, each pair $(\mathbf{u}_{\text{top}}^+, \mathbf{u}_{\text{bot}}^+)$ and $(\mathbf{u}_{\text{top}}^-, \mathbf{u}_{\text{bot}}^-)$ is defined on the same domain (intact or damaged area) since integration through the thickness is implicit:

$$\int_{\Omega} f \, d\Omega = h_{\text{top}} \int_{\bar{\Omega}} f_{\text{top}} \, dx \, dy + h_{\text{bot}} \int_{\bar{\Omega}} f_{\text{bot}} \, dx \, dy, \quad (2)$$

$\bar{\Omega}$ is the projection of the volume Ω on the plate plane, whereas h_{top} and h_{bot} are the thickness of the top and bottom layers.

Neglecting body forces, the potential energy of the system writes:

$$\Pi(\mathbf{u}, \lambda) = \int_{\Omega} \Psi(\nabla_s \mathbf{u}) \, d\Omega + \int_{\Gamma} \lambda \cdot \llbracket \mathbf{u} \rrbracket \, d\Gamma - \int_{\Gamma_n} \mathbf{u} \cdot \mathbf{t}_n \, d\Gamma, \quad (3)$$

where Γ is the fronts surface and Γ_n the part of the domain boundary on which a traction \mathbf{t}_n is applied (Neumann boundary conditions). $\Psi(\nabla_s \mathbf{u})$ is the strain energy density, whereas λ and \mathbf{u} are the primary vector fields. We denote by $\llbracket \mathbf{u} \rrbracket$ the jumps in the displacement fields: $\llbracket \mathbf{u}_{\text{top}} \rrbracket = \mathbf{u}_{\text{top}}^- - \mathbf{u}_{\text{top}}^+$ associated to Lagrange multiplier field λ_{top} and $\llbracket \mathbf{u}_{\text{bot}} \rrbracket = \mathbf{u}_{\text{bot}}^- - \mathbf{u}_{\text{bot}}^+$ associated to λ_{bot} .

As already mentioned, the definition of the Lagrange multiplier space should be handled with care to avoid instability due to extra degrees of freedom. The solution proposed by [5] to constrain the Lagrange multiplier space by tying the degrees of freedom related to node pairs connected across the front as been used here as in [1] and is illustrated with Figure 4.

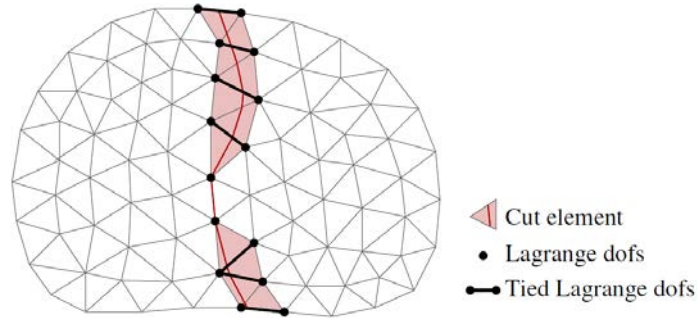

Figure 4. Stabilized definition of the Lagrange multiplier space for a triangular mesh.

2.2. Front propagation model

The model presented in previous subsection is used to compute the displacement field for a given position of the delamination fronts that can be arbitrarily located. The next step of the computation process consists in predicting the fronts advance thanks to an adequate propagation law. In the absence of cohesive zone, the front will grow according to the principle of fracture mechanics. This means that growth occurs if the energy release upon the front advance G is higher than the energy needed to form the additional crack surface G_c :

$$v_n(s) = \frac{1}{\mu} \left\langle \frac{G(s)}{G_c} - 1 \right\rangle_+. \quad (4)$$

v_n is the normal velocity that can vary along the front and the constant μ can be interpreted as a viscous resistance against front propagation. s stands for the location on the front, whereas the

brackets denote the positivity condition ($\langle \cdot \rangle_+ = (|\cdot| + \cdot)/2$) and reflects the irreversibility of the front advance.

Zou *et al.* [6] have already mentioned that the assumptions of shell, plate or membrane theories remove the stress singularity from the linear elastic displacement field around the delamination front and introduce instead a discontinuity in the stress and strain fields. This is due to the fact that out-of-plane variations (through the thickness of the plate) in the displacement fields are eliminated and this discontinuity can be used as a configurational force to predict crack growth.

The formulation chosen by van der Meer *et al.* will be used in this paper. It is based on the computation of the jump in Eshelby tensor $\llbracket \mathbf{P} \rrbracket = \mathbf{P}^- - \mathbf{P}^+$ since the energy dissipation due to the front movement per unit of crack front length G can be expressed as:

$$G(s) = \int_h g(s, z) dz = h_{top} (\mathbf{n} \cdot \llbracket \mathbf{P}_{top} \rrbracket \cdot \mathbf{n}) + h_{bot} (\mathbf{n} \cdot \llbracket \mathbf{P}_{bot} \rrbracket \cdot \mathbf{n}), \quad (5)$$

where \mathbf{n} is the normal to the front in the plate plane oriented in the front propagation direction (towards the intact area).

For linear elasticity, \mathbf{P} is defined as:

$$\mathbf{P} = \Psi \mathbf{I} - \nabla \mathbf{u}^T \cdot \boldsymbol{\sigma} \quad \text{with} \quad \Psi = \frac{1}{2} \nabla_s \mathbf{u} : \mathbb{C} : \nabla_s \mathbf{u}. \quad (6)$$

In this paper, we work under the assumption of small perturbation. However this formulation is also applicable to the large displacements case, as long as $\nabla \mathbf{u}$, $\boldsymbol{\sigma}$ and \mathbf{n} are expressed in the current spatial configuration. Also, any material law derived from a potential Ψ such that $\boldsymbol{\sigma} = \partial \Psi / \partial (\nabla_s \mathbf{u})$ can be used. However in the case of a nonlinear material interpolation of history variables will be necessary to evaluate v_n on the front, which is not where the history variables are stored.

Since v_n is defined on the front, the same difficulty in defining the velocity space than for the Lagrange multiplier space arises. The constrained space introduced previously is thus an adequate basis for the discretization of the normal velocity field. The velocity degrees of freedom are then defined on nodes that are not necessarily located on the front. Consequently, a weak form of equation (4) has to be derived and solved for the nodal velocities.

However, when using equation (4) to compute the front velocity, local inaccuracies in the value of the G (the energy release per crack front length unit) may lead to oscillations of the front. To avoid that, a diffusion term that vanishes upon mesh refinement is added in equation (4):

$$v_n(s) + \frac{\kappa d^2}{\mu} \frac{\partial^2 v_n}{\partial s^2} = \frac{1}{\mu} \left\langle \frac{G(s)}{G_c} - 1 \right\rangle_+, \quad (7)$$

where κ is the stabilization parameter and d is the typical element size defined as

$$d = \min_{i=1}^{n_{elt}} \left(\sqrt{\Delta x_i \Delta y_i} \right). \quad (8)$$

2.3. Level set update

In order to update the level set field which is defined on the whole domain Ω , the velocity field computed on a smaller domain should be extended. This can be done for example using a fast marching method [7]. The current level set values are used to sort the nodes on which v_n has not been solved yet and to determine the order in which the nodes can be updated, marching away from the front. The condition of normality between $\nabla \Phi$ and ∇v_n is used to compute the nodal velocity for an element with two value of v_n known and one unknown:

$$\nabla \Phi \cdot \nabla v_n = 0. \quad (9)$$

In case of a node with multiple elements for which two values of v_n are already known, the element that is most normal to the level set will be used.

Update of the level set is then very simple since the level set field is defined as a signed function and the velocity field is normal to the level set [8]. Using forward Euler time discretization, the update is performed with:

$$\Phi \leftarrow \Phi + \langle v_n \rangle_+ \Delta t, \quad (10)$$

where Δt is the time increment computed as:

$$\Delta t = \min \left\{ \Delta t_0, \frac{d}{1 \max(v_n)} \right\}, \quad (11)$$

Δt_0 being the default and maximum time increment.

In combination with a loading scheme in which the displacement (or load increment) for the subsequent time step can be adapted accordingly:

$$u \leftarrow u + \Delta u_0 \frac{\Delta t}{\Delta t_0}, \quad (12)$$

this ensure the stability of the explicit level set update and make it possible to capture sharp load drops.

Finally, occasional reinitialization of the level set field is necessary due to errors introduced by the discretization in time and space. This can also be achieved thanks to a fast marching method based on equation (1). Since it is a relatively cheap operation, it can be performed every time step without real drop on performance.

3. NUMERICAL RESULTS

To investigate the case of several delamination fronts growing in the same interface and interacting with each other, two cases will be presented in this section. The first one is a cracked shear lap made of an isotropic material. The second one is a square plate with a central circular hole made of the same isotropic material.

3.1. Cracked shear lap

The geometry of the cracked shear lap is presented in figure 5. Two initial symmetric linear delamination fronts are introduced in the model such that $a = 25$ mm. On one half of the plate thickness a load is applied on the right side whereas the other side is clamped, such that the cracks grow in mode II as a splitting phenomenon. The material parameters for the plate are given in table 3.1.

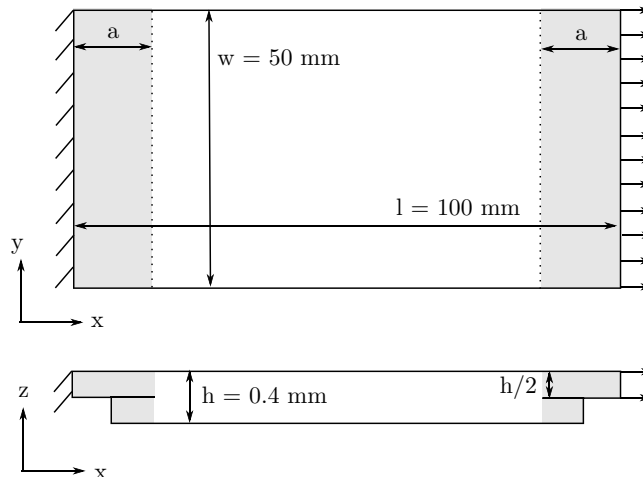

Figure 5. Geometry and boundary conditions for the cracked shear lap test.

E (GPa)	ν	G_c (N/mm)	μ (mm/s)	κ (mm/s)
140	0.21	0.01	0.01	0.001

Table 1. Material properties.

Looking at figure 6) it can be noticed that the fronts growth is mainly smooth and symmetric as long as the front is defined on enough elements. Indeed, due to its discretization the front is piecewise linear. Consequently, a minimal number of elements are needed for the front to remain a smooth curve. This explains why the front becomes irregular at the end of the simulation after merging.

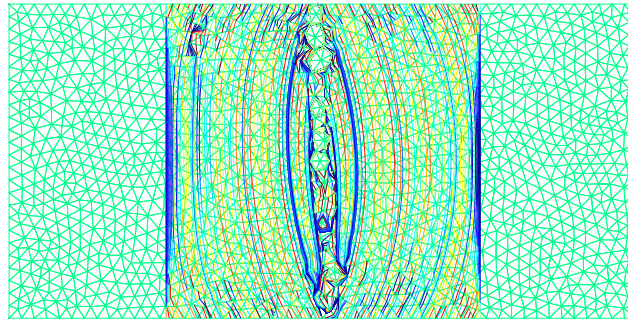

Figure 6. Evolution of the front location (1st to 104th time steps).

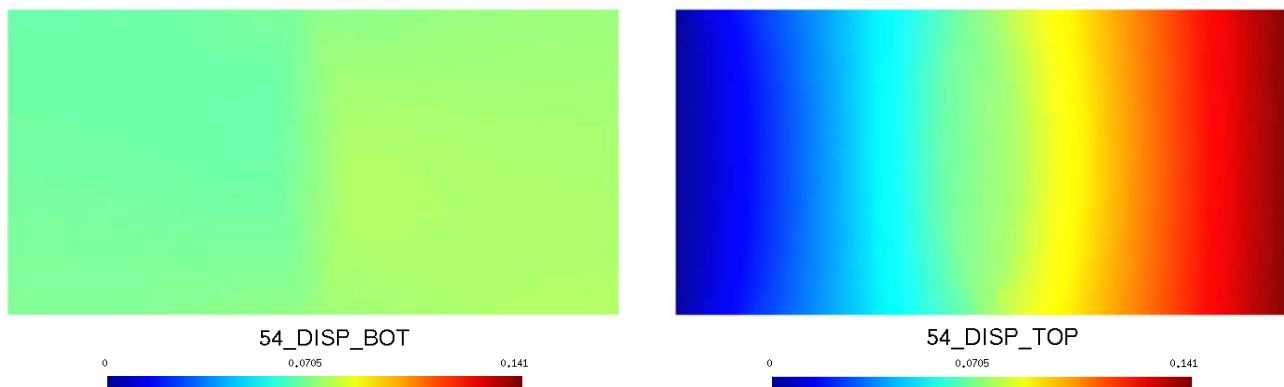

Figure 7. Displacement fields in the top and bottom layers at the 54th time step.

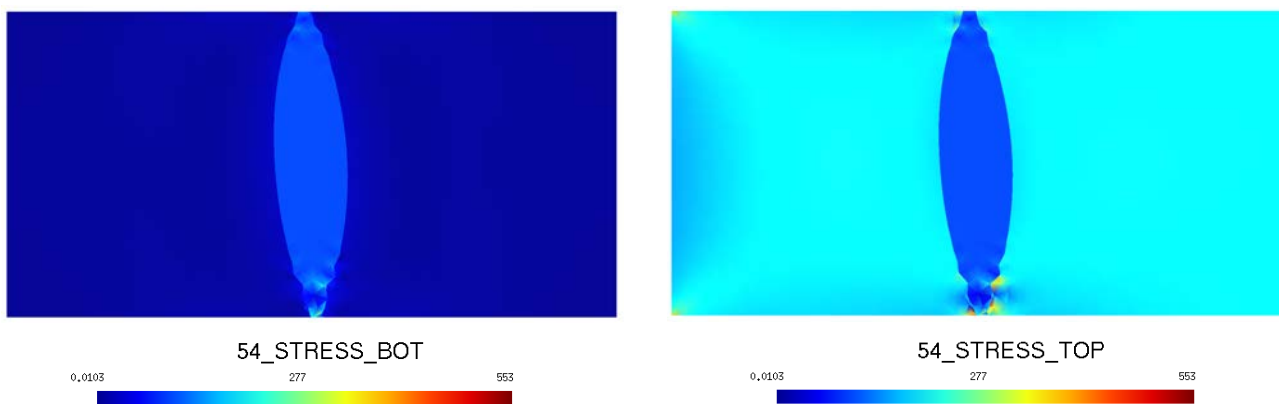

Figure 8. Stress fields in the top and bottom layers at the 54th time step.

It can also be noticed in this example that there are still some numerical issues when the front passes exactly by the edge of an element. When this phenomenon occurs, a delay in the front advance near the location of this edge is observed at the next time increment that disappear after some time. This problem should soon be corrected.

Looking at the displacement fields of the top and bottom layers (see figure 7) it can be noticed that the strong discontinuity introduced in the formulation at the front location is correctly changed into a weak discontinuity thanks to the Lagrange multipliers. Furthermore, this weak discontinuity in the displacement field leads as expected to a strong discontinuity in the stress field as showed by figure 8.

3.2. Square plate with circular hole

For this second example, the same material properties than for the first example are used (see table 3.1). Only a quarter of the plate is modeled with adequate symmetric boundary conditions and a uniform load is applied on only one half of the plate thickness on the right side. The plate geometry is presented in figure 9. A circular delamination of width 10 mm is placed around the central hole and another linear front is placed at the right side ($a = 10$ mm).

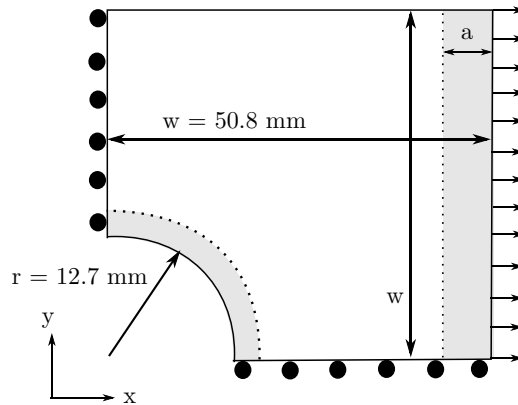

Figure 9. Geometry and boundary conditions for the plate with central hole test.

As expected (see figure 10, the circular delamination front that is not directly loaded does not move until it has merged with the other front. The front growth is smooth as long as the two fronts have not merged. It becomes more irregular at the end of the simulation due to the reduce number of elements crossed by the part of the front that is the most curved.

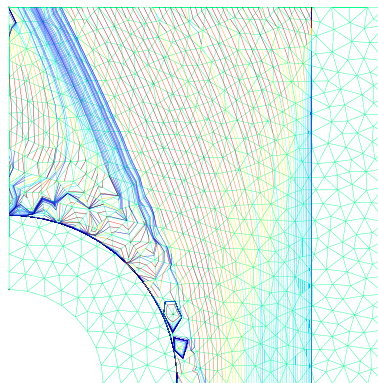

Figure 10. Evolution of the front location (1st to 119th time steps).

4. CONCLUSION

In this work a partially delaminated plate model based on [1] has been presented. The new feature of this model compared to [1] is that it accounts for several delamination fronts growing at the same time and eventually interacting. The equations and results exposed in this paper are for several fronts evolving in the same interface but the case of several fronts localized in different interfaces is also being studied. After restraining ourselves in this paper to the simpler case of an isotropic membrane,

orthotropic materials and plate behavior including out-of-plane displacements and bending will be considered and implemented.

In both cases the approach used is the same. Starting from a partially delaminated plate model where the fronts are represented by a level set field so that it can intersect the elements at arbitrary locations, the displacement field is solved for a given location of the fronts. In order to allow for weak discontinuities in the displacement field at fronts location, a strong discontinuity is inserted using duplicate partially active elements whereas a gap closure technique based on Lagrange multipliers is needed to constrain the jumps that may appear. Crack growth is handled with an explicit energy-based relation in which the configurational force is computed as the jump in Eshelby tensor over the interface that constitutes the front. The front velocity deduced from this explicit crack growth law is then used to update the level set field and hence the front location.

This model has been used to simulate several delamination sequences. It allows for a smooth progression of the fronts through the elements, which permits to use larger elements than with cohesive models. Time steps can also be larger and the number of systems solved per time step is limited (one solve of the global system for displacements prediction plus one solve of a smaller system for crack growth prediction) which add to the gain in efficiency due to the possible increase in element size. This model has also proved its ability to account for the growth of several delamination fronts and their interaction together or with the domain boundaries. Phenomena such as the merging of two fronts have been successfully simulated even if there is still some numerical issues that should be addressed. For now on, we will focus on comparison with experiments or cohesive models.

ACKNOWLEDGEMENTS

This work was supported by a grant from SAFRAN Composites. The support is gratefully acknowledged.

REFERENCES

- [1] F.P. van der Meer, N. Moës, L.J. Sluys, A level set model for delamination - Modeling crack growth without cohesive zone or stress singularity, *Engineering Fracture Mechanics*, **79**, 2012, pp. 191-212.
- [2] F.P. van der Meer, L.J. Sluys, N. Moës, Toward efficient and robust computation of energy release rate and mode mix for delamination, *Composites: Part A*, **43**, 2012, pp. 1101-1112.
- [3] N. Moës, J. Dolbow, T. Belytschko, A finite element method for crack growth without remeshing, *International Journal of Numerical Methods in Engineering*, **46**, 1999, 131-150.
- [4] A. Hansbo, P. Hansbo, A finite element method for the simulation of strong and weak discontinuities in solid mechanics, *Computer Methods in Applied Mechanics and Engineering*, **193**, 2004, pp. 3523-3540.
- [5] E. Béchet, N. Moës, B. Wohlmuth, A stable Lagrange multiplier space for stiff interface conditions within the extended finite element method, *International Journal of Numerical Methods in Engineering*, **78**, 2008, pp. 931-954.
- [6] Z. Zou, S.R. Reid, S. Li, P.D. Soden, Mode separation of energy release rate for delamination in composite laminates using sublaminates, *International Journal of Solids and Structures*, **38**, 2001, 2597-2613.
- [7] J.A. Sethian, *Level set methods and fast marching methods*, second edition, Cambridge University Press, 1999.
- [8] S. Osher, R. Fedkiw, *Level set methods and dynamic implicit surfaces*, Springer Verlag, 2003.