



**HAL**  
open science

# Impact of the management strategy on the sizing of a collaborative system: photovoltaic plant -electric vehicle fleet, under uncertainty

Roman Le Goff Latimier, B Multon, Hamid Ben Ahmed

## ► To cite this version:

Roman Le Goff Latimier, B Multon, Hamid Ben Ahmed. Impact of the management strategy on the sizing of a collaborative system: photovoltaic plant -electric vehicle fleet, under uncertainty. *COMPEL: The International Journal for Computation and Mathematics in Electrical and Electronic Engineering*, 2015, 34 (6), pp. 1807-1824. 10.1108/COMPEL-11-2014-0323 . hal-01226610

**HAL Id: hal-01226610**

**<https://hal.science/hal-01226610>**

Submitted on 9 Nov 2015

**HAL** is a multi-disciplinary open access archive for the deposit and dissemination of scientific research documents, whether they are published or not. The documents may come from teaching and research institutions in France or abroad, or from public or private research centers.

L'archive ouverte pluridisciplinaire **HAL**, est destinée au dépôt et à la diffusion de documents scientifiques de niveau recherche, publiés ou non, émanant des établissements d'enseignement et de recherche français ou étrangers, des laboratoires publics ou privés.

# Impact of the management strategy on the sizing of a collaborative system: photovoltaic plant - electric vehicle fleet, under uncertainty

R. Le Goff Latimier<sup>1,\*</sup>, B. Multon<sup>1</sup>, and H. Ben Ahmed<sup>1</sup>

<sup>1</sup>SATIE Laboratory, ENS Rennes, Rennes, France

\*roman.legoff-latimier@ens-rennes.fr

## ABSTRACT

**PURPOSE** - To foster the grid integration of both electric vehicles (EV) and renewable generators, this paper investigates the possible synergies between these players so as to jointly improve the production predictability while ensuring a green mobility. It is here achieved by the mean of a grid commitment over the overall power produced by a collaborative system which here gathers a PV plant with an EV fleet. The scope of the present contribution is to investigate the conditions to make the most of such an association, mainly regarding to the management strategies and optimal sizing, taking into account forecast errors on PV production.

**METHODOLOGY** - To evaluate the collaboration added value, several concerns are aggregated into a primary energy criterion: the commitment compliance, the power spillage, the vehicle charging, the user mobility and the battery aging. Variations of these costs are computed over a range of EV fleet size. Moreover, the influence of the charging strategy is specifically investigated throughout the comparison of three managements: a simple rule of thumb, a perfect knowledge deterministic case and a charging strategy computed by stochastic dynamic programming. The latter is based on an original modeling of the production forecast error. This methodology is carried out to assess the collaboration added value for two operators points of view: a virtual power plant (VPP) and a balance responsible party (BRP).

**FINDINGS** - From the perspective of a BRP, the added value of PV-EV collaboration for the energy system has been evidenced in any situation even when the charging strategy is very simple. On the other hand, for the case of a VPP operator, the coupling between the optimal sizing and and the management strategy is highlighted.

**ORIGINALITY** - A co-optimization of the sizing and the management of a PV-EV collaborative system is introduced and the influence of the management strategy on the collaboration added value has been investigated. This gave rise to the presentation and implementation of an original modeling tool of the PV production forecast error. Finally, to widen the scope of application, two different business models have been tackled and compared.

**Keywords** - electric vehicle, photovoltaic, collaborative system, optimal energy management, production commitment, stochastic dynamic programming, co-optimization

## 1 Introduction

Growing concerns around renewable electricity production compel us to look beyond its advantages in terms of environmental performance. We will here focus our attention on photovoltaic (PV) devices but similar investigations can be carried out on others energy sources such as wind or ocean waves. The photovoltaic (PV) electricity production presents a high variability and relatively low predictability. Thus the spread of PV plants cannot but be limited as it brings about some additional stress on distribution and transport networks, while increasing the need for spinning reserves. Then heavily increasing the penetration rate would require an important strengthening of the grid if no precautionary measure was introduced. Various proposals are currently being put forward to cope with this poor predictability. For instance, the call for tenders<sup>1</sup> which is in force for PV plants above 250kW on the French island territories with no interconnection requires that the photovoltaic operator commits himself in advance on its production profile. This

---

**Acknowledgments** - The authors are grateful to the Langa Solar company which provided production measurements over a 2.64MW PV plant in Corsica (France).

**To cite this work** - Le Goff Latimier, R., Multon, B., & Ben Ahmed, H. (2015). Impact of the management strategy on the sizing of a collaborative system: Photovoltaic plant–electric vehicle fleet, under uncertainty. *COMPEL: The International Journal for Computation and Mathematics in Electrical and Electronic Engineering*, 34(6), 1807-1824.

profile should moreover respect a trapezoidal shape with a period of constant production during mid-day. To fulfill such constraints while the production is uncertain, the addition of a storage device which would be coupled to the PV power plant is required.<sup>2</sup> Studies like those of Ru et al.<sup>3</sup> suggest some methods to design a storage capacity associated with PV plants in the context of exchanges with the electrical network. In wind-diesel systems, Masmoudi et al.<sup>4</sup> also focused the interest of adding an ultracapacitor storage device to enhance the integration of fluctuating power sources.

Concomitantly, the development of electric mobility through full electric vehicles (EV) or plug in hybrids (PHEV) fosters the electricity generation. Indeed, these vehicles represent an increase of the total electricity demand. Drovtar et al.<sup>5</sup> describe the impact that the emergence of these new consumers could have on a grid, using the Estonian example, just as Turker et al.<sup>6</sup> do on the French one. It is concluded that in order to integrate a significant share of the vehicle fleet, it is necessary to push forward pricing rules so as to make consumption match production.<sup>7</sup> Up to now, this mostly means night vehicle charging, but may shortly concern intermittent production.

However, concurrently to these constraints, electric vehicles do have the potential to bring new services to energy systems. Indeed, they represent a storage capacity which is connected to the electrical grid most of the time. Opportunities associated to this scattered storage were highlighted by Kempton and Tomic.<sup>8</sup> First of all, even if the stored energy is limited in comparison with some others grid players, interconnection power and fast response of electric vehicle batteries can enable them to play a part within spinning reserves.<sup>9</sup> But Kempton and Tomic had already considered a fruitful collaboration of electric vehicles with renewable energy sources. Indeed, to achieve an environmentally relevant conversion from well to wheel, the electricity generation for mobility should use sustainable primary energy sources. Concurrently, vehicles batteries can be used as scattered storage devices, to mitigate production fluctuations from any renewable power plant. A first step toward such collaboration could be a Vehicle to Home collaboration<sup>10</sup> where a PV roof unit is jointly managed with a single vehicle battery. Widening the scope, Traube et al.<sup>11</sup> investigate the possibility of using vehicles batteries to compensate some fast variations of PV production during cloudy days so as to only inject slow power slopes into the grid. Such compensation will result in a high frequency variation of the charging power that might hasten batteries ageing. Guillou et al.<sup>12</sup> focus the collaboration of a PV plant and electric vehicles fleet, but to maximize the self-consumption of the solar production. This minimization of power exchanges with the grid could be seen as a zero commitment. Of course, such battery charging management could be set for both full electric vehicles and plug-in hybrids.<sup>13</sup>

Therefore it appears that the natural synergies of EV and renewable power plants can be used in several different contexts, under different management strategies and sizings. This study is then dedicated to investigate the added value of such a collaboration, under various contexts. So as to operate these fruitful synergies between EV fleet and renewable power plants, this paper firstly presents in Section 2 a context for the direct collaboration of photovoltaic producer and electric vehicle users. We here focus on the improvement of the production predictability by the mean of a day ahead power commitment. Within this context, different problems must be solved to achieve the operational management of the system. A breakdown of these problems and of their interactions will be described. Afterwards, Section 3 will depict several concerns related to this context such as grid commitment gap, production spillage, battery ageing, battery charging and mobility costs. These utility functions will here be aggregated into a primary energy criterion, which has been preferred to economic criterion because of their great heterogeneity. This will permit to investigate the performance of a range of system sizing in terms of PV rated power against number of vehicles. Optimal sizings will be computed with a specific attention to the influence of the management strategy carrying out a co-optimization. Finally, results of collaboration added value will be discussed for two specific cases. The first one describes a virtual power plant (VPP) operator. The second one is related to the broader perspective of a Balance Responsible Party which aims at providing the demand at the lowest price.

## 2 Description of the Investigated System

### 2.1 A Collaborative System

Some contexts have already been proposed to frame a partnership between electric vehicle fleets and renewable sources in order to foster their grid integration,<sup>10,14</sup> The framework which is here proposed has first been introduced in<sup>15</sup> and relies on a joint management of the vehicle fleet charging and the electricity plant. The goal is to build an operator who could be considered from a grid manager point of view as a single actor, to some extent similar to a virtual power plant,<sup>16</sup> but with a distributed storage capacity. Figure 1 presents the main players involved in this system.

In this framework, the photovoltaic plant is subjected to a constraint of day-ahead production commitment. The commitment profile is computed on the basis of the available forecast for the PV production  $\hat{P}_{pv}$  and mobility needs  $\hat{P}_{ev}$ . It suffers some penalties according to the gap between the commitment profile and the profile which is actually achieved  $P_{grid}$ . Therefore, it gets associated with some EV or PHEV owners who entrust it the control of the battery charging power  $P_{ev}$ . Vehicles are overall consumers but we here also consider that the power flow can occasionally inverse. The

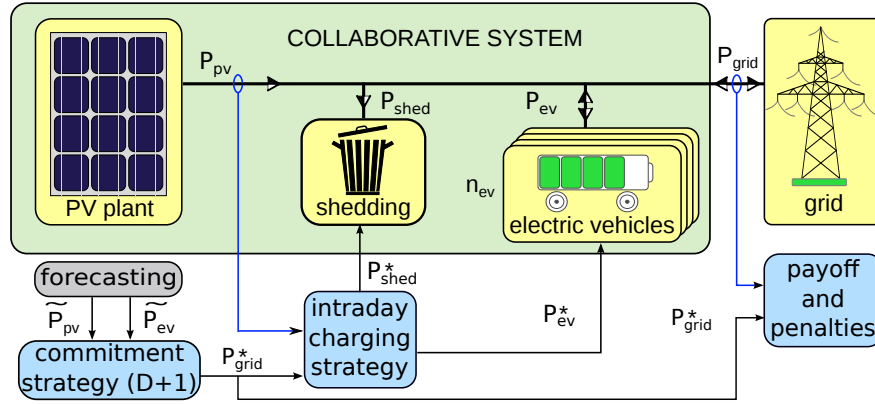

**Figure 1.** Outline of the collaborative system players and main players

commitment constraint does not any more only affect the PV power profile  $P_{pv}$ , but is shifted to the power injected into the grid, which is ruled by:

$$P_{grid} = P_{pv} - P_{shed} - P_{ev} \quad (1)$$

The possibility to shed some of the instant maximum PV power is here taken into account with  $P_{shed}$ . The issue is then to properly decide in real time according to the observations which are the optimal vehicle power and shed power. Such an association between a power plant and vehicles which stand as a mobile storage capacity is afterwards called collaborative system.

It may be noticed that the question of physical interconnection of vehicles and power plant is not into the scope of this study. That means vehicles can either be in the direct neighborhood of the PV plant or scattered over a large area but connected through the grid and collaborating with a distant plant. Although these two situations are physically very different, the management rules are in both cases similar. That is why the theoretical study that is here described does not exclude some remote collaboration, using the electrical network to gather the spread vehicles into a huge and virtual storage capacity. This second possibility does imply a complex infrastructure of communication and measurement, as well as a suitable regulatory framework and the absence of grid constraints. Each of these conditions represents an entire topic by itself and we only focus here on management investigations.

## 2.2 Breaking Down of the System Management into Sub-problems

The operational management of such a collaborative system is a complex task which requires to sequentially solve several different problems. This section will introduce those issues and highlight the way they are interweaved, as illustrated in figure 2.

The real time issue of a collaborative system is to decide at each time step the suitable charging power for each vehicle of a fleet  $P_{ev}^*$  and power shedding  $P_{shed}^*$ . This is based on real time measurement such as vehicles state of energy

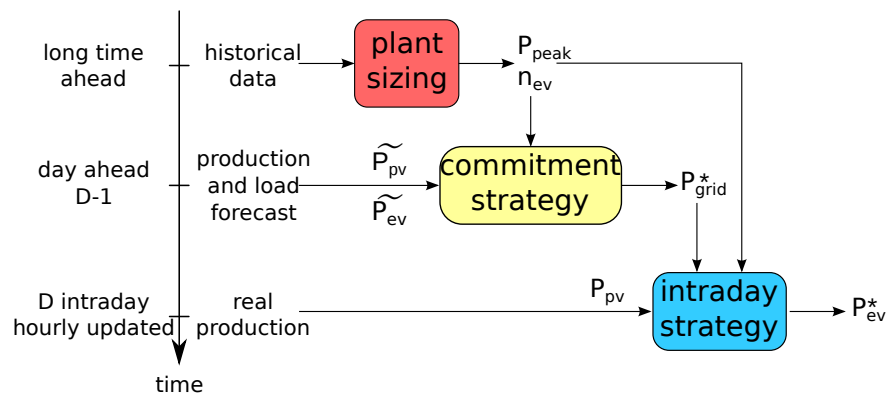

**Figure 2.** Schematic of sub-problems occurring along the collaborative system management

$E_{ev}$  or instantaneous PV maximal production. The best affordable compromise between commitment gap and vehicles mobility should then be found. A closely related question is tackled by Sortomme et al<sup>17</sup> who develops an optimal charging strategy for a vehicle aggregator bidding into energy markets, under deterministic vehicles behavior. However, this strategy cannot but depend on upstream decided parameters as here the day ahead commitment profile.

The grid commitment profile computation is handled one day ahead, on the basis of available forecasts for the PV production  $\widetilde{P}_{pv}$  and the charging demand  $\widetilde{P}_{ev}$ . Some information about the forecast precision can be here taken into account<sup>18, 19</sup>. At least, it necessarily relies on the number of involved vehicles, including batteries features, and rated power of PV plant, thus on the sizing of the collaborative system.

This sizing of the collaborative system in terms of PV rated power and EV fleet size is the very first decision which is made in the collaborative system life and it impacts every downstream decision. However, it shall only be done thanks to historical data and to the best of the achievable system modeling. Beyond the presentation of a collaborative system, the scope of the here presented work is therefore to investigate its optimal sizing dependence on the modeling precision.<sup>20</sup> Indeed, the design of a system from scratch requires investigating many sizing points. Because of the computational cost, each sub-issue cannot be handled at the best of its complexity. We will then focus on the impact of the real time charging strategy on the optimal system sizing. As highlighted by Heassig et al.<sup>21</sup> the performance of the management strategy can have a huge impact on the optimal sizing of a system.

### 3 System Modeling and Costs Functions

As aforementioned in Section 2, we here investigate the variations of the collaboration added value. The objective is to make the most of the collaboration in order to ensure electric mobility and to improve the production predictability. It would then result in a reduction of the need for spinning reserves whose marginal energy price is far above renewable power plants. In order to assess the performance of the collaborative system, its modeling and associated cost functions are described in this section. The selected point of view is to aggregate this performance into an equivalent primary energy criterion. All cost function are then expressed as an energy than would be consumed to provide it. This criterion has been selected because of the great heterogeneity of the existing economic models. It will be deduced thanks to battery and PV panel embodied energy or through European electricity mix efficiency  $\eta_{EU}$ . This supposes that the photovoltaic production share into the grid is still marginal and does not shift the global electricity generation efficiency.

#### 3.1 Vehicles Modeling

Most of the vehicles are used for a daily journey. This implies a decoupling between a day and the following. It is therefore not relevant to draw charging strategies farther than the coming evening when the vehicle is likely to be unavailable for the collaborative system. This model thus only considers optimization throughout a day. In this study, the vehicles behavior is supposed to be deterministic. Thereafter, vehicles are assumed to be available for the collaboration between  $t_1 = 9\text{am}$  and  $t_2 = 6\text{pm}$ . While this assumption may seem very restrictive, it roughly fits the macroscopic behavior of many fleets obeying working hours.<sup>18</sup> As each vehicle can have a different battery capacity and this fleet can gather full EV and PHEV, we will only consider the equivalent total capacity  $E_{ev}^{\#}$ . A maximum charging power  $P_{ev}^{\#}$  is also set, which depends on  $E_{ev}^{\#}$  assuming that a capacity increase is due to a larger fleet and thus more numerous charging points. An arbitrary value of  $E_{ev}^{\#}/P_{ev}^{\#} = 4\text{h}$  is picked, considering that fast charging would enhance battery aging, as described below. The initial state of energy is set to  $E_{ev}(t_1) = 40\%E_{ev}^{\#}$ . This initial situation is a very significant parameter for the upcoming charging management, although it is out of the scope of this study.

At least three antagonist objectives can be drawn for the vehicle charging.

- The charging cost  $C_{charg}$ : charging a battery obviously costs the consumed energy. The chosen point of view is to evaluate the corresponding primary energy, through the European energy mix efficiency. Thus

$$C_{charg} = \frac{E_{ev}(t_2) - E_{ev}(t_1)}{\eta_{EU}} \quad (2)$$

with European energy mix efficiency  $\eta_{EU} = 0.3\text{kWh}_e/\text{kWh}_p$  ie  $0.3\text{kWh}$  of electricity per non renewable primary  $\text{kWh}$ .

- The battery aging  $C_{age}$ : each solicitation of the battery causes an elementary damage. These damages are then summed until a end of life criterion is reached. The scope is here limited to lithium-ion batteries whose aging has two contributions: calendar and cycling. Calendar aging dependence over state of energy is not here considered. For optimization purpose, it is dropped out as it only represents a constant value. Cycling aging is assessed according to half cycles of charge or discharge. The elementary damage is  $d_i = \alpha \cdot \Delta SoE^\beta$  where  $\Delta SoE$  is the

amplitude of a half cycle and  $\alpha = 2.4 \cdot 10^{-4}$ ,  $\beta = 1.8$ .<sup>22</sup> Cycle identification is carried out by a Rainflow algorithm. If the charging provokes a damage  $d_i$ , the aging criterion is:

$$C_{age} = d_i \cdot E_{emb}^{bat} \cdot E_{ev}^{\ddagger} \quad (3)$$

where  $E_{emb}^{bat}$  is the specific embodied energy considered as  $550 kWh_p/kWh_{bat}$ .

- The unsatisfied mobility  $C_{mob}$ : in case the battery is not fully charged by the leaving time  $t_2$ , a hybrid plug in vehicle would increase its fossil fuel consumption to maintain mobility service. Thus

$$C_{mob} = \frac{\eta_{therm}}{\eta_{elec}} \cdot (E_{ev}^{\ddagger} - E_{ev}(t_2)) \quad (4)$$

where  $\eta_{therm} = 1.5 km/kWh_p$  is the consumption of a thermal engine and  $\eta_{elec} = 5 km/kWh_p$  is the electric drive yield. Although this objective function is mainly designed for PHEV, it will be thereafter used for the whole fleet.

### 3.2 Grid Commitment Compliance

The grid commitment obligation is supposed to foster the integration of renewable power plants thanks to a enhanced predictability, even if variability remains. It is a step toward their inclusion into grid planning and unit commitment. However, if this commitment is not fulfilled, it increases grid operation costs. The objective functions that we here consider are then as follows.

- The grid commitment mismatch  $C_{mis}$ : if the collaborative system does not inject the power it was supposed, another plant has to increase its production, with European energy mix efficiency  $\eta_{EU} = 0.3 kWh_e/kWh_p$  ie  $0.3 kWh$  of electricity per non renewable primary  $kWh$ .

$$C_{mis} = \frac{\Delta T}{\eta_{EU}} \sum_t P_{grid}^*(t) - P_{grid}(t) \quad (5)$$

with  $\Delta T$  the 15 minute time step.

- The PV power spillage  $C_{shed}$ : in case the PV maximum production is momentarily higher than the grid commitment, the system manager has the possibility to shed some of this PV maximum power. To evaluate the cost associated with this loss of producible power, we use a life cycle analysis. A given amount of energy has been invested to produce the PV panel with an expected production over the product life – which depends on the local solar potential. Shedding some of the production is therefore a waste of this embodied energy:

$$C_{shed} = \frac{E_{emb}^{PV}}{\eta_{EV} \cdot E_{life}^{PV}} \cdot \Delta T \cdot \sum_t P_{shed}(t) \quad (6)$$

where  $E_{emb}^{PV} = 7.5 MWh/kW_{pv}$  the panel embodied energy and  $E_{life}^{PV} = 30 MWh/kW_{pv}$  the solar potential production for a 20 year life and a solar irradiation of  $1500 kWh/kW_{pv}/year$  in Corsica (France).

### 3.3 Commitment Computation

The system manager has to compute his day-ahead grid commitment, on the basis of the available forecast for the PV production  $\widetilde{P}_{pv}$  and mobility needs  $\widetilde{P}_{ev}$ . As the vehicle are here supposed deterministic,  $\widetilde{P}_{ev}$  is set to a constant charging power during vehicle presence hours:

$$\widetilde{P}_{ev} = \frac{E_{ev}^{\ddagger} - E_{ev}(t_1)}{t_2 - t_1} \quad (7)$$

As highlighted in [15], the quality of the meteorological forecast - from which the production is deduced - is an important parameter of the collaboration profitability. For replication purpose, we here only consider a persistence forecast: the today measured production becomes the forecast for tomorrow.

The grid commitment profile is then computed as:

$$P_{grid}^* = \widetilde{P}_{pv} - \widetilde{P}_{ev} \quad (8)$$



### 3.4 Definition of the Charging Optimization Problem

According to these antagonist cost functions, the goal is then to find the best compromise while operating the system. The following optimization problem is thus defined, under the assumption of a deterministic behavior of the vehicle fleet:

$$\min_{P_{ev}, P_{shed}} \sum_{t=t_1}^{t_2} C_{mis}(\Delta P_{grid}) + C_{shed}(P_{shed}) + C_{age}(d_i) + C_{charg}(E_{ev}(t_2)) + C_{mob}(E_{ev}(t_2)) \quad (9)$$

submitted to the constraints  $\forall t \in [t_1, t_2]$ :

$$\begin{aligned} E_{ev} &\in [E_{ev}^b, E_{ev}^{\#}] \\ P_{ev} &\in [P_{ev}^b, P_{ev}^{\#}] \\ P_{shed} &\in [0, P_{pv}] \\ E_{ev}(t_1) &= E_{ev}^0 \\ E_{ev}(t + \Delta T) &= E_{ev}(t) + \Delta T \cdot P_{ev}(t) \end{aligned}$$

The deterministic framework enables to simplify the management of scattered vehicles with different presence hours and state of energy. Thanks to this assumption, a unique equivalent battery is instead considered. However, mitigating the commitment gap is driven by the production forecast error which is a stochastic phenomenon. The performances of the proposed resolution of this problem will then depend on the assumed knowledge about the forecast error and the prevision of its modeling.

## 4 Compared Strategies

Within the context described beforehand, the aforementioned optimization problem has to be solved for a range of sizing points. As a consequence the performance of the collaborative system cannot but depend on the resolution method which draws a tradeoff between the involved cost functions. However as the collaboration aims at mitigating the forecast error and as the latter is a stochastic process, any resolution method for the real time management problem relies on a modeling of this production forecast error. For the purpose of carrying out a co-optimization of the optimal sizing and of the management strategy, this section will present three different resolutions methods for the real time management problem, based on various forecast error modelings. These modelings will assume different levels of knowledge about the forecast error. Their performances will be compared with a reference situation.

### Reference Situation

The chosen reference situation is the case without any collaboration. Vehicles are thus charged at a constant power through the electricity mix efficiency and PV plant can only shed some of its maximal production to match its commitment profile. This situation is illustrated on the upper left corner of figure3 during a six day sample. First panel shows real PV production and its forecast. Second panel shows the constant vehicle charging power and the shed power. Then third panel provides resulting grid power as well as grid commitment.

### Rule of Thumb

In order to evaluate a guaranteed minimum performance of the collaborative system, a first empirical charging strategy is computed. This strategy should be as rough as possible and thus consists in the perfect compensation of the grid commitment gap, bounded by the charging limits of the vehicles and by ensuring a fully charged battery by the departure hour. This basic charging strategy is here considered to assess a lower bound of the collaboration profitability. It requires no knowledge at all about the forecast error. Upper right corner of figure3 shows the energy stored into the EV fleet which is considered as a single equivalent battery. The fleet charging power and shed production are also displayed. It results in a fully charged battery by the departure time as indicated on the top graph. The stored energy is set to zero when the vehicles are not available. The two following graphs illustrate that the gap between commitment and achieved profile is perfectly compensated as long as it is compatible with the fully charged battery.

### Deterministic Optimal Resolution

So as to compute an upper bound of the collaboration profitability, we also consider the case of a deterministic resolution. It represents a charging strategy assuming a perfect forecast of the coming production, so as to match the grid commitment decided the day before on the basis on an imperfect forecast. Although it is an unrealistic case, it is the asymptote that efficient strategies could work towards. Thus this linear programming problem is solved using the Interior Point algorithm, similarly to works carried out by Yatchev et al<sup>23</sup> and Dupre et al.<sup>10</sup> Bottom right corner of

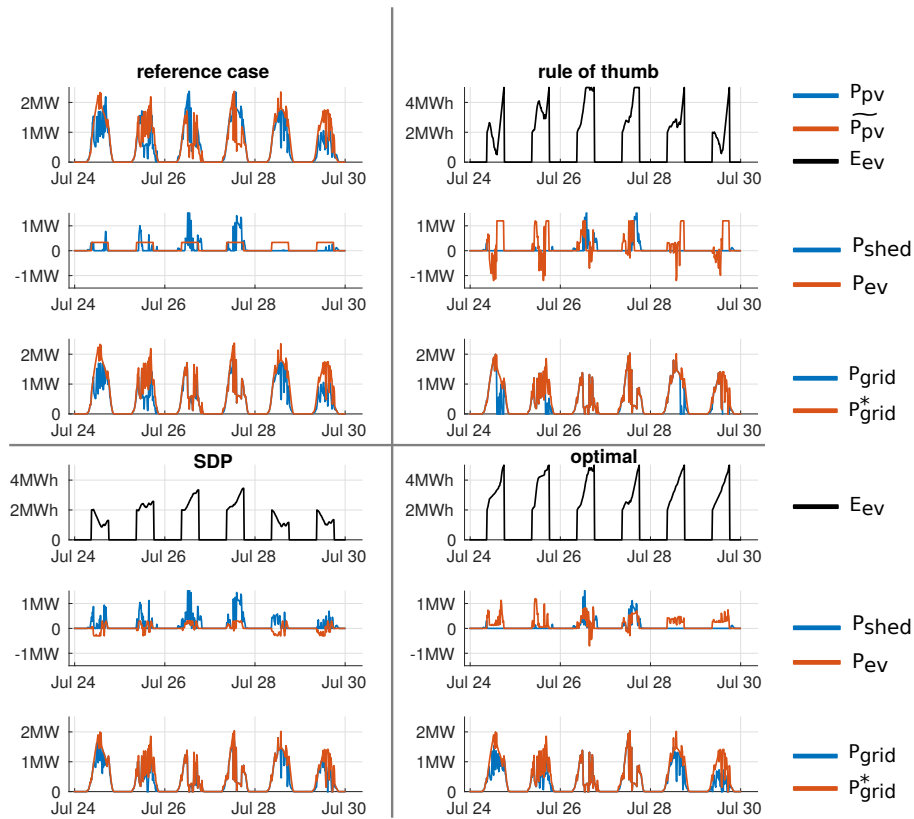

**Figure 3.** Six day sample of the PV production  $P_{pv}$  and its forecast  $\widetilde{P}_{pv}$  - upper left panel. The charging power  $P_{ev}$  and the shed power  $P_{shed}$  in the reference situation without collaboration are displayed below. The third graph shows the resulting power injected to the grid  $P_{grid}$  and the grid commitment  $P_{grid}^*$ . The upper right panel displays the same situation when it is operated by the rule of thumb. Top graph illustrates the stored energy  $E_{ev}$  in the EV fleet which is set to zero when vehicles are not available. Lower left panel represents the same variables under the Stochastic Dynamic Programming management. Lower right panel is the case of a perfect knowledge of the forecast error and thus of a deterministic optimization.

figure3 exhibits this perfect forecast case. The charged battery is not anymore guaranteed at the departure time as some tradeoffs can be done with other cost functions. However as mobility represent a high cost, batteries are almost fully charged.

### Stochastic Dynamic Programming and Forecast Error Modeling

The two previous management strategies have presented upper and lower bound situations of a perfect knowledge of the future forecast error and of a total lack of knowledge. In between the two previous solutions this last strategy relies on a stochastic modeling of this forecast error. This is the best decision that can be made within an uncertain context. We here focus on the modeling of the forecast error of the PV production rather than on its forecast itself. This choice is driven by the consideration that real PV operators would use in any case a forecast of their production that would be done by a specialized meteorologist service. In addition, in the chosen context the commitment profile is itself computed on the basis of the production forecast. EV fleet is then introduced as a flexibility device so as to mitigate the commitment gap that is to say to compensate the forecast error  $\Delta P_{pv} = P_{pv} - \widetilde{P}_{pv}$  which then appears as the most relevant variable.

As vehicle batteries are here involved, they bring in an inertia that calls for taking into account the most likely evolution of the forecast error over the next time steps and ideally until the optimization horizon, which is midnight. A dynamic modeling of the forecast error which takes into account the correlation between consecutive time steps would therefore be requisite.<sup>24</sup> Indeed, the temporal structure of the forecast error can have a huge impact on the storage management and performances. However in spite of its stochastic behavior, the solar irradiance is driven by a daily seasonality and by meteorological processes. The chosen probabilistic modeling for the forecast error  $\mathbb{P}(\Delta P_{pv})$  should then consider this combination of known typical behaviors and random process. That is why a specific tool has been developed to handle the forecast error variations.



It first consists in the identification of typical trajectories of the forecast error over a day, as illustrated figure4. These daily trajectories enable to manage the EV fleet charging with an hint of the likely long term behavior of the forecast error. Then a modeling of the variability and time structure around these main trajectories is carried out. The main advantage of this method is to provide simultaneously an indicator about the evolution of the forecast error from now until the evening considered as the horizon, and a more precise guess over the coming time steps.

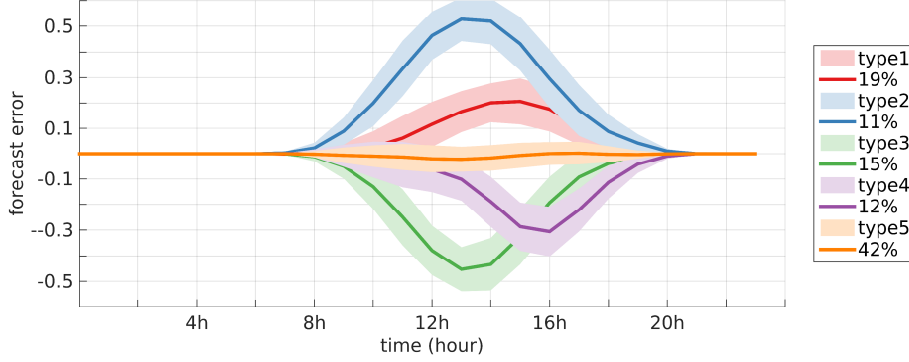

**Figure 4.** Modeling of the daily forecast error by a cross approach of typical trajectories and deviation variability for a persistence forecast in Corsica (France). The error is normalized by the PV rated power. Relative weights of each cluster is indicated.

- First a wavelet decomposition is done for each daily pattern of the forecast error.
- A clustering of these wavelet coefficients is carried out using the *kmeans* algorithm. The number of clusters is here set to five. This results in trajectory sets that are homogeneous amongst themselves.
- Finally, within each cluster, the deviation from the main pattern is fitted as an autoregressive model.

To fit this model, we here used a two year dataset of the production of a 2.64 MW PV plant located in Corsica island, from May 2012 to September 2014. To make further use of this methodology easier, we here generated the production forecast using persistence rather than using a meteorological forecast. The production of today is therefore considered as the forecast for tomorrow. Figure4 represents the five main PV forecast error trajectories that have been obtained. Colored areas are proportional to the inner variability. Relative weight of each cluster is also indicated. Typical trajectories are divided into a good prevision case, a heavily under estimated forecast, a heavily over estimated forecast and some intermediate situations. It could be noticed that moderated mis-estimation scenario have a temporal shift in comparison to the others. Besides the share of each cluster leads to a balanced overall forecast as there is no bias. Over and under estimation are of similar likelihood.

In a real operating situation, constraints of real time and large fleet would make an in-line stochastic optimization very challenging to implement.<sup>17</sup> Consequently, the real time charging strategy is here handled thanks to stochastic dynamic programming – SDP<sup>2526</sup> – which is based on the previously described probabilistic modeling of the forecast error  $\mathbb{P}(\Delta P_{pv})$ . On the basis of this modeling, stochastic dynamic programming method enables to off line compute a strategy which describes the best control  $P_{ev}^*$  and  $P_{shed}^*$  for each possible state of the system. In the case of a collaborative system, the state vector  $X$  is composed of the battery stored energy  $E_{ev}$  and the production forecast error  $\Delta P_{pv}$  which has to be mitigated. An optimal strategy thus contains the value of the optimal control for the command vector – here the vehicle charging power and the shed power – for each value of the state vector. As the problem can only be addressed during the EV fleet presence hours, only this interval is here considered for  $E_{ev}^*$ . The Bellman equation is implemented as follows:

$$\text{final cost at the horizon } V(t = t_2, X) = C_{mob}(SoE_{ev}) + C_{charg}(SoE_{ev}) \quad (10)$$

$$\forall t \in [t_1, t_2 - \Delta T], \forall X := (E_{ev}, \Delta P_{pv}),$$

$$V(t, X) = \min_{P_{ev}, P_{shed}} C_{mis}(\Delta P_{grid}) + C_{shed}(P_{shed}) + C_{age}(d_i) + \mathbb{P}(\Delta P_{pv}(t + \Delta T)|X) \cdot V(t + \Delta T, f_{dyn}(X, P_{ev})) \quad (11)$$

Figure 5 presents two cross views of the optimal strategy for  $P_{ev}^*$  computed by SDP for 11 am, depending on the forecast error  $\Delta P_{pv}$  – y-axis – and on the state of energy  $SoE$  – x-axis – for two different trajectory classes, illustrated on figure 4. The type 2 under-estimated the PV production. The optimal charging strategy then consists in widening the charging area thus to absorb more often some power into the battery. On the contrary, for type 3 where the production has been over estimated, discharging is fostered.

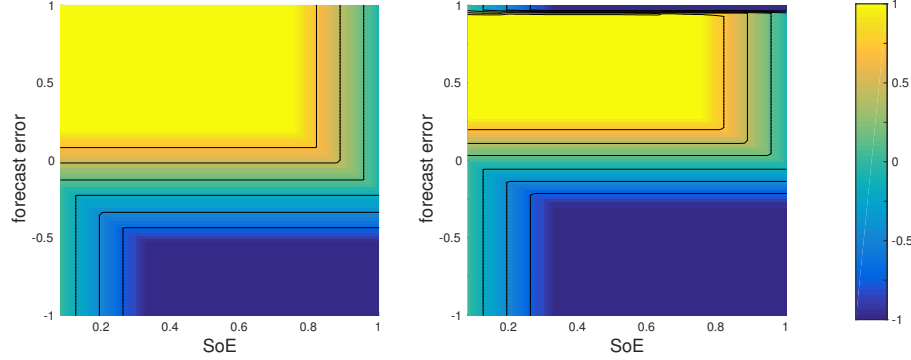

**Figure 5.** Cross section views of the normalized optimal charging strategy for vehicles  $P_{ev}^*$  computed by stochastic dynamic programming, at 11 am for type 2 trajectory (left panel) and type 3 trajectory (right panel). The optimal charging power is represented against the state of energy  $SoE = E_{ev}/E_{ev}^{\#}$  and the forecast error normalized by the PV rated power  $\Delta P_{pv}/P_{pv}^{rated}$ .

## 5 Sizing Results

### 5.1 Costs Evolution with Sizing

Within the previously described cost functions and resolution methods, the real time management problem is solved at each time step over a three year dataset for various sizing points. This section presents the variations of the collaboration added value against the ratio PV peak power over fleet size. Rough results firstly present the evolution of each utility function according to the three management strategies. Then two case study are described and the optimal sizing is discussed in each case.

Figure 6 illustrates the variations of the different utility functions for this reference situation and for the three management strategies. They are normalized by the reference cost of  $60 kWh_p$  associated to the daily charging of a single  $20 kWh$  vehicle with the European energy mix efficiency  $\eta_{EU} = 0.3 kWh/kWh_p$ . The size of the EV fleet is expressed as a total capacity and is also normalized by the peak power of the PV plant. It is therefore homogeneous to the equivalent time of rated production that the PV plant would need to refill the fleet. These normalization should foster the genericity of presented results. It appears that the main contribution to the system cost is the energy needed for the charging. In the reference situation, aging cost increases with the size of the battery as each battery always suffers the same damage, but they are more and more numerous. As there is no collaboration with the PV plant, costs associated to the grid commitment gap and shedding power are constant.

The cost distribution in the case of a rule of thumb collaboration is very close to the previous as it is a very inefficient and undifferentiated strategy. Nevertheless, a slight reduction of the total cost can be noticed as it will be further highlighted infra. It already appears that even such a simple strategy makes the collaboration profitable. Indeed, the forecast error is mitigated in this management strategy as long as it is compatible with a fully charged vehicle at the departure time. Most advanced strategies come along with some total costs reduction, by introducing compromises between mobility cost and the other utility function. These more advanced strategies do not fully refill vehicles batteries in order to reduce aging cost and grid commitment gap cost. This choice can be noticed by the significant increase of  $C_{mob}$  in the deterministic case. The grid commitment gap being the most costly function, it is reduced in the first instance even if it brings an augmentation of the costs coming from battery ageing and mobility.

### 5.2 Case Studies: Balance Responsible Party and Virtual Power Plant Operator

In order to assess the added value of a collaboration between renewable power plants and electric vehicle fleets, this last section will investigate two specific cases. The first one could be considered as the point of view of a system operator that has to provide required electricity at the lowest possible cost. This system operator could for instance be a Balance Responsible Party. Then the second situation is closer to a perspective of a Virtual Power Plant. A PV production is

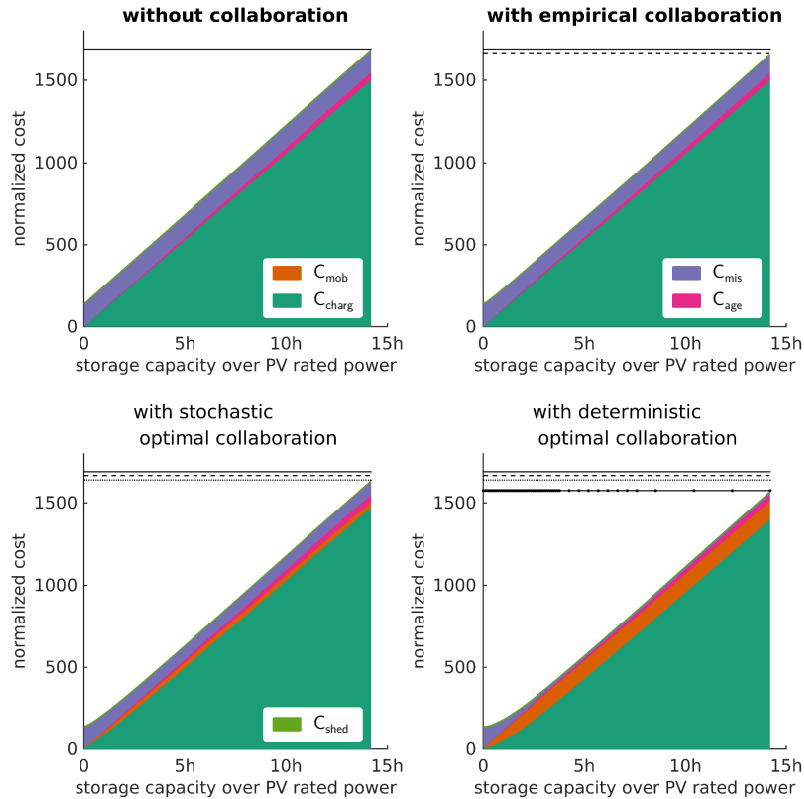

**Figure 6.** Variations of the different cost functions with vehicle fleet sizing for different charging strategies. Fleet size – x-axis - is normalized by PV rated power. Cost - y-axis - normalized by a reference cost of  $60kWh_p$  representing the primary energy consumed by the daily charging of a  $20kWh$  vehicle, with the European energy mix efficiency  $\eta_{EU} = 0.3kWh/kWh_p$ .

sold on an electricity market and its commitment gap has to be mitigated as well as possible thanks to the EV fleet charging power. For each one of these cases, a specific combination of the aforementioned utility functions is considered. The aim is to assess the added value of the PV-EV collaboration, according to the previously described management strategies. The link between the potential synergy profitability and the level of knowledge which is assumed about the production forecast error should be specifically born in mind.

### **Balance Responsible Party Point of View**

The first one consists in taking into account a global benefit for the energy system, as an energy system operator would do to provide electricity at the lowest cost. It aims at questioning how far collaboration can be useful when introducing more and more electric mobility and renewable sources into an energy system. All the cost functions that were previously described are thus taken into account to compute an overall cost. The collaboration added value is then defined by the difference between the total cost without any collaboration - charging, mobility, aging, commitment gap and shedding - and the total cost when the collaboration is available. Left panel of the figure7 presents this added value according to the three charging strategies. Costs are here again normalized by the cost associated to the charging of a single vehicle. The fleet size is expressed as a time needed for the PV plant to refill, in the same way as in figure6.

It thus appears that the collaboration brings a positive added value in any management strategy and for any sizing. Indeed, even a very rough management strategy which suppose no knowledge at all about the production forecast error can improve the integration of renewable power plants in to the grid and besides ensure a sustainable mobility. Naturally if the forecast error is better modeled this added value is enhanced. Moreover it is continuously increasing which means that whatever the number of vehicles involved in an area, using them to collaborate with renewable power plants is useful. Nevertheless, when the EV fleet is growing, a point is reached when there is enough vehicles to compensate for

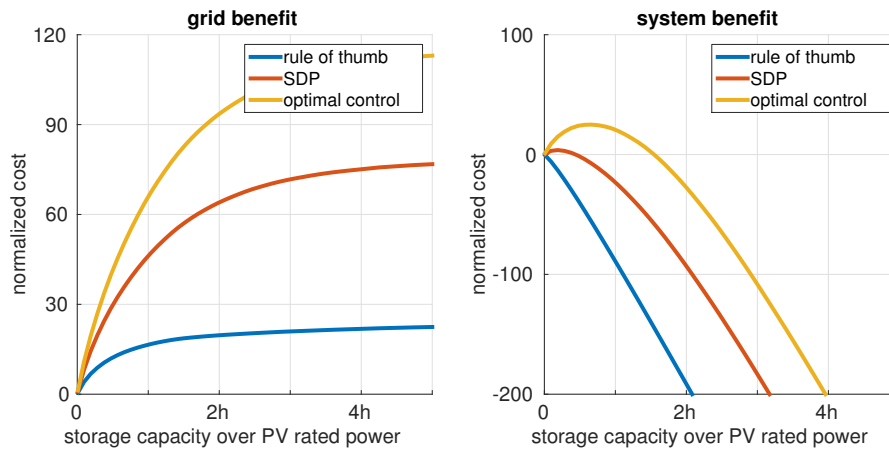

**Figure 7.** Added value of the collaboration for the global energy system (right panel) and from a virtual power plant perspective (left panel). Fleet size – x-axis - is normalized by PV rated power. Cost - y-axis - normalized by a reference cost of  $60kWh_p$  representing the primary energy consumed by the daily charging of a  $20kWh$  vehicle, with the European energy mix efficiency  $\eta_{EU} = 0.3kWh/kWh_p$ .

the forecast error and there is no more interest to add some more vehicles. In this case study this point is around an equivalent battery storage equal to five times the PV rated power. The integration of renewable is already achieved as well as possible and the upcoming vehicles will have to be charged without bringing any improvement. Of course, this could be avoided by adding new renewable power plants.

#### **Virtual Power Plant Operator Point of View**

The second perspective that is here investigated attempts to describe the situation of a Virtual Power Plant operator who sells a PV production on an electricity market and mitigates its commitment gap thanks to the EV fleet charging power. Usually, such operators gather an intermittent production unit and an energy storage device such as pumped hydro. Here the latter is substituted by the vehicle fleet. The goal is then to use it as well as possible to match the grid commitment. Vehicles are then useful by reducing the commitment gap penalties. However, they have to be charged by the way. Their charging cost then becomes a burden. The EV fleet size should therefore only be increased as long as the added flexibility is more profitable than the charging cost. The system benefit is then the difference between the savings vehicles carry out – commitment gap and shedding reduction compared to the non collaborative case – and the charging expense. Right panel of figure 7 illustrates this case.

As the charging costs increase almost linearly with the fleet size, all management strategies are driven by the same slope when the fleet is very large. In these situations, the EV fleet has already done everything possible to mitigate the forecast error and there is no more interest to add some more vehicles into the VPP. On the contrary, vehicles become a burden that has to be charged. On the other hand, where EV fleets are smaller, the impact of the management strategy is crucial. Indeed, the upper bound of the collaboration added value is represented by the perfect knowledge optimal control. This control enables to have a profitable collaboration if the fleet storage capacity is around  $500kWh$  per  $MW_p$  of photovoltaic plant. For the considered  $2.64MW_p$  PV plant, this result leads to a  $1.3MWh$  fleet capacity. Considering a  $25kWh$  average vehicle battery, a 50 vehicle fleet should be associated to the PV plant. However, on the other side if no knowledge of the forecast error is supposed, then the collaboration cannot bring enough benefits to compensate for the EV charging costs. It is then always unprofitable for a VPP operator to get associated with some EV. Finally, it should be noticed that in intermediate situations – which are the most realistic – the optimal sizing of a collaborative system is strongly driven by the performance of the stochastic modeling of the forecast error. It can be noticed that the modeling that has been described and implemented here enables to achieve a slightly positive still relatively low added value for the collaboration in this demanding context. The coupling between the forecast modeling quality and the optimal sizing is therefore a key factor for the relevant sizing of collaborative system.

## **6 Conclusion**

So as to both foster the integration of intermittent renewable power plants – here photovoltaic - into the grid and to ensure electric mobility, a collaborative system has been here proposed which aims at increasing PV production predictability while charging a fleet of hybrid plug in or full electric vehicles. This is done through a production commitment on the

overall power flow. The vehicles charging power is managed so as to mitigate the PV production forecast errors and to reduce the grid commitment gap. The issue of the proper sizing of such a system is then crucial to make the most of the collaboration as illustrated by variations of overall performances. The scope of this study has been therefore to assess this proper sizing with two points of view: an energy system operator and a virtual power plant operator. A specific attention has been paid to the influence of the forecast error modeling and of the management strategies that can be constructed.

First some utility functions assessing the primary energy consumption, including embodied energy, have been proposed to handle the numerous aspects of the collaboration: battery aging, charging energy, mobility loss, commitment gap and power shedding. Then three different levels of knowledge about the production forecast error has been introduced accompanied by associated management strategies. The first one supposes no particular knowledge about the forecast error and is associated to a rule of thumb. The second one supposes that the forecast error can be perfectly predicted and the management can be optimally solved as a deterministic optimization problem. Then the third one introduces an original modeling for the forecast error. It is based on a cross approach of typical daily pattern and a modeling of the variability and time structure around these main trajectories. This versatile method has here been carried out with a persistence forecast to foster further checking but can be transposed to any other. The associated management strategy is a stochastic dynamic programming which computed the optimal decision according to this stochastic modeling. Finally two case studies are investigated: the case of an energy system operator whose goal is to minimize the cost of electricity and the case of a Virtual Power Plant operator.

It has been evidenced that the collaboration of EV fleets with renewable power plants always has a positive impact on an energy system efficiency. Indeed, even if no particular knowledge is supposed about the forecast error, synergies can be used to improve the predictability of renewable while providing a sustainable mobility. It becomes more and more fruitful as the forecast error is better known. On the other hand, if the collaboration is only considered in a Virtual Power Plant context where the EV fleet is used to avoid some commitment gap penalties, the management strategy becomes a win-or-lose factor. Indeed, the number of vehicles has to be limited otherwise their charging cost burdens the environmental profitability. Moreover, if the management strategy is not smart enough, no positive added value can be achieved. In particular, the impact of the management strategy on the optimal sizing has been highlighted.

The field of collaboration between renewable power plants and electric vehicle fleets maintains numerous open paths for further developments. In particular, the vehicles behavior is here considered as deterministic while the collaborative system actually holds a twofold stochasticity, from both production and storage availability. The interest of a specifically photovoltaic powered mobility could be compared to the generally speaking electric mobility that has been used here. A broader interest on various renewable power plants such as wind or hydro could also be investigated rather than focusing on a single one. Additionally, the impact of the here proposed primary energy criterion on the optimal sizing could be further investigated.

## References

1. French Energy Regulatory Board, C. R. E. Specification of the call for tenders about the construction and operating of solar electricity plants with a capacity above 250kw (in french). Tech. Rep., <http://www.cre.fr/documents/appels-d-offres/> (2011).
2. Le Goff Latimier, R., Multon, B., AHMED, H. B. & Acquitter, M. Co-optimisation de l'engagement de production et de la capacité de stockage associée à une ferme photovoltaïque, prenant en compte le vieillissement de la batterie. (battery aging aware co-optimization of the production commitment and of the storage capacity associated with a photovoltaic plant). In *Symposium de Génie Électrique* (hal-01065174, 2014).
3. Ru, Y., Kleissl, J. & Martinez, S. Storage size determination for grid-connected photovoltaic systems. *Sustainable Energy, IEEE Transactions on* **4**, 68–81 (2013).
4. Masmoudi, A., Abdou Tankari, M., Camara, B., Dakyo, B. & Nichita, C. Ultracapacitor integration for short-term energy management in a hybrid system. *COMPEL-The international journal for computation and mathematics in electrical and electronic engineering* **31**, 294–312 (2011).
5. Drovtar, I., Rosin, A., Landsberg, M. & Kilter, J. Large scale electric vehicle integration and its impact on the estonian power system. In *PowerTech (POWERTECH), 2013 IEEE Grenoble*, 1–6 (IEEE, 2013).
6. Turker, H., Bacha, S. & Chatroux, D. Impact of plug-in hybrid electric vehicles (phevs) on the french electric grid. In *Innovative Smart Grid Technologies Conference Europe (ISGT Europe), 2010 IEEE PES*, 1–8 (IEEE, 2010).
7. Rautiainen, A. *et al.* Statistical charging load modeling of phevs in electricity distribution networks using national travel survey data. *Smart Grid, IEEE Transactions on* **3**, 1650–1659 (2012).

8. Kempton, W. & Tomić, J. Vehicle-to-grid power implementation: From stabilizing the grid to supporting large-scale renewable energy. *Journal of Power Sources* **144**, 280–294 (2005).
9. Han, S., Han, S. & Sezaki, K. Development of an optimal vehicle-to-grid aggregator for frequency regulation. *Smart Grid, IEEE Transactions on* **1**, 65–72 (2010).
10. Dupré, L. *et al.* Optimal household energy management using v2h flexibilities. *COMPEL: The International Journal for Computation and Mathematics in Electrical and Electronic Engineering* **33**, 777–792 (2014).
11. Traube, J. *et al.* Mitigation of solar irradiance intermittency in photovoltaic power systems with integrated electric-vehicle charging functionality. *Power Electronics, IEEE Transactions on* **28**, 3058–3067 (2013).
12. Guillou, H., Cung, V.-D., Ha, D. L., Jacomino, M. & Merten, J. Energy management strategies for optimal charging of electric vehicles with photovoltaic production. In *Proceedings of the 26th European photovoltaic solar energy conference and exhibition*, 3885–3889 (2011).
13. Nurre, S. G., Bent, R., Pan, F. & Sharkey, T. C. Managing operations of plug-in hybrid electric vehicle (phev) exchange stations for use with a smart grid. *Energy Policy* **67**, 364–377 (2014).
14. Guille, C. & Gross, G. A conceptual framework for the vehicle-to-grid (v2g) implementation. *Energy policy* **37**, 4379–4390 (2009).
15. Le Goff Latimier, R., Kovaltchouk, T., Ben Ahmed, H. & Multon, B. Preliminary sizing of a collaborative system: Photovoltaic power plant and electric vehicle fleet. In *Ecological Vehicles and Renewable Energies (EVER), 2014 Ninth International Conference on*, 1–9 (IEEE, 2014).
16. Mashhour, E. & Moghaddas-Tafreshi, S. M. Bidding strategy of virtual power plant for participating in energy and spinning reserve markets—part i: Problem formulation. *Power Systems, IEEE Transactions on* **26**, 949–956 (2011).
17. Sortomme, E., El-Sharkawi, M. *et al.* Optimal charging strategies for unidirectional vehicle-to-grid. *Smart Grid, IEEE Transactions on* **2**, 131–138 (2011).
18. Gonzalez Vaya, M. & Andersson, G. Integrating renewable energy forecast uncertainty in smart-charging approaches for plug-in electric vehicles. In *PowerTech (POWERTECH), 2013 IEEE Grenoble*, 1–6 (IEEE, 2013).
19. Peralta, J., Pérez-Ruiz, J. & De la Torre, S. Unit commitment with load uncertainty by joint chance-constrained programming. In *PowerTech (POWERTECH), 2013 IEEE Grenoble*, 1–6 (IEEE, 2013).
20. Fathy, H. K., Reyer, J., Papalambros, P. Y., Ulsov, A. *et al.* On the coupling between the plant and controller optimization problems. In *American Control Conference, 2001. Proceedings of the 2001*, vol. 3, 1864–1869 (IEEE, 2001).
21. Haessig, P., Multon, B., Ahmed, H. B. & Lascaud, S. Quelle importance du choix de la loi de gestion pour dimensionner un système de stockage d'énergie? (about the impact of the control policy on the sizing of an energy storage system). In *Symposium de Génie Électrique (hal-01065158)*, 2014).
22. Lippert, M., Jeuffrain, C., Lascaud, S. & Rioual, P. Making the sun reliable with li-ion energy storage: solar pv energy management for large pv power plants on isolated islands. In *Proceedings of the 25th European Photovoltaic Solar Energy Conference, Valenaia, Spain* (2010).
23. Yatchev, I. *et al.* Problem formulation and analysis for optimal energy management in multisources systems: W effect. *COMPEL-The international journal for computation and mathematics in electrical and electronic engineering* **31**, 904–919 (2012).
24. Haessig, P., Multon, B., Ahmed, H. B., Lascaud, S. & Bondon, P. Energy storage sizing for wind power: impact of the autocorrelation of day-ahead forecast errors. *Wind Energy* **18**, 43–57 (2015).
25. Bertsekas, D. P., Bertsekas, D. P., Bertsekas, D. P. & Bertsekas, D. P. *Dynamic programming and optimal control*, vol. 1 (Athena Scientific Belmont, MA, 1995).
26. Haessig, P., Kovaltchouk, T., Multon, B., Ahmed, H. B. & Lascaud, S. Computing an optimal control policy for an energy storage. In *proceedings of the 6th European Conference on Python in Science, Euroscipy, Brussels, Belgium* (2014).