



HAL
open science

An LPV Fault Tolerant control for semi-active suspension -scheduled by fault estimation

Manh Quan Nguyen, Olivier Sename, Luc Dugard

► **To cite this version:**

Manh Quan Nguyen, Olivier Sename, Luc Dugard. An LPV Fault Tolerant control for semi-active suspension -scheduled by fault estimation. SAFEPROCESS 2015 - 9th IFAC Symposium on Fault Detection, Supervision and Safety for Technical Processes, Sep 2015, Paris, France. pp.42 - 47, 10.1016/j.ifacol.2015.09.502 . hal-01226558

HAL Id: hal-01226558

<https://hal.science/hal-01226558>

Submitted on 9 Nov 2015

HAL is a multi-disciplinary open access archive for the deposit and dissemination of scientific research documents, whether they are published or not. The documents may come from teaching and research institutions in France or abroad, or from public or private research centers.

L'archive ouverte pluridisciplinaire **HAL**, est destinée au dépôt et à la diffusion de documents scientifiques de niveau recherche, publiés ou non, émanant des établissements d'enseignement et de recherche français ou étrangers, des laboratoires publics ou privés.

An LPV Fault Tolerant control for semi-active suspension -scheduled by fault estimation [★]

M.Q. Nguyen, O. Sename, L. Dugard

Univ. Grenoble Alpes, GIPSA-lab, F-38000 Grenoble, France

CNRS, GIPSA-lab, F-38000 Grenoble, France.

*E-mail: {manh-quan.nguyen, olivier.sename,
luc.dugard}@gipsa-lab.grenoble-inp.fr*

Abstract: In this paper, a novel fault tolerant control is proposed to accommodate damper faults (oil leakages) in a semi-active suspension system based on a quarter-car vehicle model. The fault accommodation is based on the Linear Parameter Varying (LPV) control strategy and involved in 2 steps. At first, a fast time-varying fault is estimated by using the fast adaptive fault estimation (FAFE) algorithm and based on an unknown input adaptive observer. Thanks to information about the estimated fault, the dissipativity domain of the semi-active suspension is adapted according to the fault. Then a single LPV fault tolerant controller is developed to manage the system performances. The controller solution, derived in the LPV/ H_∞ framework, is based on the LMI solution for polytopic systems. Some simulation results are presented that show the effectiveness of this approach.

Keywords: semi-active suspension, fast fault estimation, LPV/ H_∞ control, fault tolerant control

1. INTRODUCTION

Automotive vehicles are extremely complex systems composed of many interrelated subsystems that, in particular enhance the overall driving comfort, stability and safety (see Kiencke and Nielsen (2000), Gillespie (1992)).

Among all sub-systems impacting on the vertical vehicle dynamics, the suspension systems play a key role since they ensure the link between the wheels and the chassis (see Fischer and Isermann (2004)). A well designed suspension system may considerably improve not only the passenger comfort but also the car road holding. Recently, the semi-active suspensions have been more and more widely used in automobile industry since they achieve the main performance objectives while they are smaller in weight and volume, cheaper in price, more robust and less energy consuming. Several control design problems for semi-active suspension systems have then been tackled with many approaches during the last decades. In the works of Savaresi et al. (2010), Poussot-Vassal et al. (2012), the authors presented several control strategies for semi-active suspensions (based on the Skyhook, Groundhook, ADD). Moreover, to cope with the dissipativity constraints of semi-active dampers, some control approaches using the LPV techniques have been presented. In Do et al. (2010, 2012), the nonlinearities of the semi-active suspension are taken into account and written in LPV form using the saturation of the control input. This method has been extended in (Sename et al. (2013)) in case of damper faults but using 3 varying parameters which could be conservative. In (Poussot-Vassal et al. (2008)), a kind of LPV gain scheduling anti-windup strategy has been proposed to handle such a constraint. This approach will be extended here in the case of some damper malfunctions.

About the fault tolerant control (FTC), in general there are 2 main groups of FTC: passive (off-line designed) using the robust control with respect to possible system faults and active (online control reconfiguration mechanism) using a FDI module and accommodation techniques. In more detail, a FDI strategy can be model-based or data-based and is used to detect, isolate as well as estimate the faults. During the last decades, FDI modules, based on the analytical redundancy for fault estimation (e.g in Zhang and Jiang (2008)), have been received a lot of attention by many researchers.

Fault estimation is a key step in designing a fault tolerant control. In the literature, there exist many different approaches to estimate a fault which can be either actuator or sensor malfunction. Let us mention the classical methods, based on the parity space theory (see in Gertler (1997)) to generate the residues and approximate the fault or the bank of observers approach (see Varrier (2013)) as well as by sliding mode observers (Edwards et al. (2000)). Recently, a new approach (see in Shi and Patton (2014)) considered the fault element as a state of the augmented system and designed an extended observer to estimate at the same time the state and the fault of system. However, it is limited to constant faults $\dot{f}(t) = 0$. Then, Zhang et al. (2008) presented a method allowing to evaluate the time-varying fault by using a fast adaptive fault estimation (FAFE) methodology based on an adaptive observer. But therein, the authors solved the problem with a regular LTI system without considering the disturbances. Next, Rodrigues et al. (2014) proposed an adaptive polytopic observer for time-varying fault estimation in spite of the disturbances for a class of descriptor LPV systems.

The main purpose of this paper is to propose an active FTC for a semi-active suspended quarter-car vehicle which suffers from oil leakage. The paper contributions are twofold:

- First, the fault estimation is based on the FAFE algorithm allowing to determine the magnitude of the fault. This approach

[★] This work was supported by the French national project INOVE / ANR 2010 BLAN 0308.

is used for the first time to estimate the actuator fault in a semi-active suspension system while taking into consideration the unknown input road disturbance.

o Then an LPV fault scheduled controller is developed to ensure the damper dissipativity property and enhance passengers comfort and road holding (in normal and faulty conditions). This controller is an extension of the one in Poussot-Vassal et al. (2008) where, using the obtained fault information, the anti-windup kind strategy is adapted according to the estimated fault in order to guarantee the semi-activeness of the damper.

The paper is organized as follows: the next section describes about the problem statement. Section 3 presents a method to estimate the fault on damper. Section 4 is devoted to the design of a fault tolerant LPV semi-active suspension control. Some the results of the proposed method are given in section 5. Finally, some conclusions are drawn in the section 6.

2. PROBLEM STATEMENT

In this work, a simple quarter vehicle, depicted in Fig.1 is taken into account: This picture presents a single corner of a vehicle.

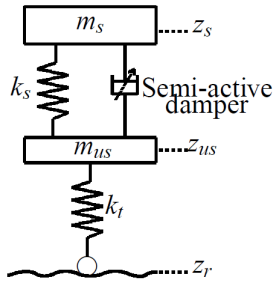

Fig. 1. Quarter-car vehicle model

In this model, the quarter vehicle body is represented by the sprung mass (m_s), the wheel and tire are represented by the unsprung mass (m_{us}). They are connected by a spring with the stiffness coefficient k_s and a semi-active damper. The tire is modeled by a spring with the constant stiffness coefficient k_t . As seen in the figure, z_s (respectively z_{us}) is the vertical displacement around the equilibrium point of m_s (respectively m_{us}) and z_r stands for the variation of the road profile. It is assumed that the wheel-road contact is ensured.

The dynamical equations of a quarter vehicle model are given by:

$$\begin{cases} m_s \ddot{z}_s = -F_{spring} - F_{sa} \\ m_{us} \ddot{z}_{us} = F_{spring} + F_{sa} - F_{tire} \end{cases} \quad (1)$$

where $F_{spring} = k_s(z_s - z_{us})$ is the dynamical spring force, $F_{tire} = k_t(z_{us} - z_r)$ is the dynamical tire force. Let us denote $z_{def} = z_s - z_{us}$ the damper deflection and $\dot{z}_{def} = \dot{z}_s - \dot{z}_{us}$ the damper deflection speed. The semi-active damper force is expressed by a linear model as follows:

$$F_{sa} = c \cdot \dot{z}_{def} = c_0 \dot{z}_{def} + u \quad (2)$$

with $c_{min} \leq c \leq c_{max}$ and $c_0 = \frac{(c_{min} + c_{max})}{2}$.

Concerning the semi-active suspension control, the main challenge is to take into account the dissipativity of the damper and the saturation in the synthesis step. If this dissipativity constraint is not considered, it is necessary to "saturate" the control input without any performance and stability guarantees, which is referred to as the clipped strategy in (Savaresi

et al. (2010)). In (Poussot-Vassal et al. (2008)), the considered semi-active damper is simply modeled as a static map of the deflection speed/Force, i.e a lower bound and upper bound of the achievable forces as shown on Fig.2. This static model is thus a saturation function of the deflection speed, denoted as the dissipative domain $\mathcal{D}(\dot{z}_{def})$. Moreover, a smart parameter is introduced allowing to take the real abilities of the damper into account. This scheduling parameter is indeed defined as a function of the difference " ε " between the computed damper force F_d (given by the controller) and the achievable one F_d^\perp , that was used to satisfy the dissipative damper constraints. Therefore, the scheduling parameter depends on $\mathcal{D}(\dot{z}_{def})$.

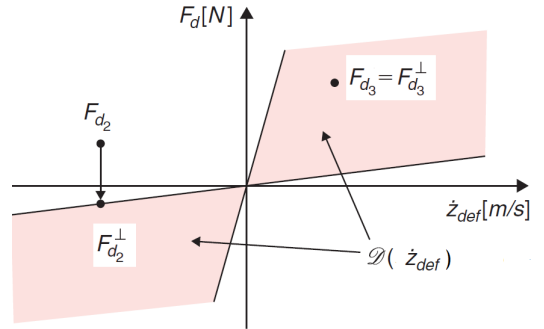

Fig. 2. Dissipative domain \mathcal{D} graphical illustration

As shown in Poussot-Vassal et al. (2008), this method gives very good results nominal condition i.e without faults. However, if the damper is subject to faults e.g. oil leakages, the method becomes no longer appropriated. Indeed, for a faulty semi-active suspension, the available damping force (low and high level) is lower than a healthy damper and consequently the deflection motion increases. It means that the dissipative domain will change in the presence of fault. Therefore, this domain depends on both the deflection speed and the fault, and so-called $\mathcal{D}_f(\dot{z}_{def}, f)$ as in Fig.3 with f stands for a fault to the damper.

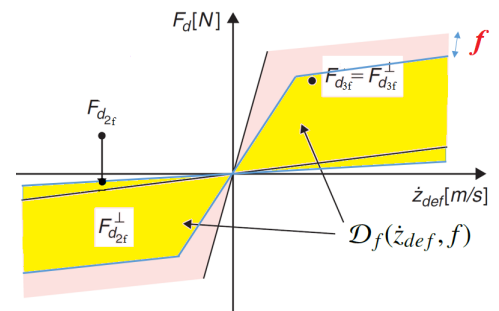

Fig. 3. Dissipative domain \mathcal{D}_f in presence of fault

As a consequence, if the saturation constraint is not adapted, then the dissipativity condition is not be guaranteed. Indeed, the required force could be outside of the range of the "real" faulty force (even if valid inside of the range of the healthy force). In this case, the control performances are not ensured if some fault information is not included into the control design. To deal with this problem, in this work, a LPV fault tolerant control is proposed to include the dissipativity constraints of the semi-active suspension in case of malfunction in order to achieve good performances.

Min γ subjects to (7) and

$$\begin{bmatrix} \gamma I & E^T Q - UC \\ (E^T Q - UC)^T & \gamma I \end{bmatrix} > 0 \quad (11)$$

Solving this optimization problem, we obtain the values of observer matrices N, L, G, T_2 and the estimation of the fault actuator.

4. FAULT TOLERANT LPV SEMI-ACTIVE SUSPENSION CONTROL

In this section, an LPV fault scheduled state feedback control is proposed to ensure the damper dissipativity and keep good dynamic performances of the faulty semi-active suspension system. Of course, some gracefull performance degradations are allowed.

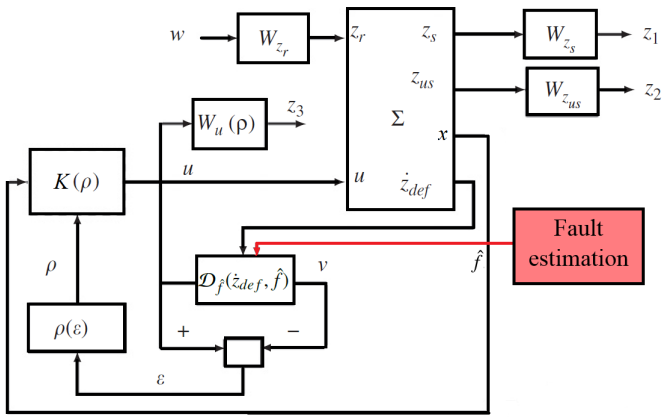

Fig. 4. General block diagram

The overall control structure is presented in Fig (4). In this work, the LPV static state feedback controller K receives the state variables x as an input and computes the damping forces u to be added to the nominal damping forces $c_0 z_{def}$ in order to improve the vehicle performances. This controller is scheduled by the parameter ρ that constraints the control signal or not, in such a way that the required forces F_d remain semi-active and adapted to damper ability. The fault estimation algorithm, proposed in the last section, allows to estimate the fault in damper. This estimated fault is used to modify the dissipativity domain $\mathcal{D}_f(z_{def}, \hat{f})$ of the semi-active suspension allowing to schedule parameter ρ . Some weighting functions are then taken into account in the controller synthesis to improve the performances of the vehicle:

- W_{z_r} is used to shapes the road disturbances effects z_r
- $W_{z_s} = k_{z_s} \frac{s^2 + 2\xi_{11}\Omega_1 s + \Omega_1^2}{s^2 + 2\xi_{12}\Omega_1 s + \Omega_1^2}$ relates to the comfort performances
- $W_{z_{us}} = k_{z_{us}} \frac{s^2 + 2\xi_{21}\Omega_2 s + \Omega_2^2}{s^2 + 2\xi_{22}\Omega_2 s + \Omega_2^2}$ relates to the road-holding performances
- $W_u(\rho) = \rho$ is used to penalize (more or less) the control input signal amplification according to the ρ signal. More specifically, it is used to guarantee the semi-activeness (see next subsection).

Remark: The weighting functions $W_{z_s}, W_{z_{us}}$ are chosen thanks to the genetic algorithm as in Do et al. (2011).

4.1 Scheduling parameter

The method proposed in the previous work of Poussot-Vassal et al. (2008) for a quarter car in order to fulfill the dissipativity constraint, aims at increasing or decreasing the gain of the weighting filter W_u on the damper control signals, according to a given scheduling strategy. Indeed, if the required force computed by the controller is active, a scheduling parameter allows the controller to enhance or not the performance specifications, so that the required force remains dissipative. This method is extended here in case of a faulty damper. Let us now define the clipping function for the faulty case:

Definition of Fault-scheduled clipping function:

Due to the controlled damper limitations (i.e. the effective force provided by the damper F_d should lie in the dissipative domain), the following Fault-scheduled clipping function $\mathcal{D}_f(F_d, z_{def}, \hat{f})$ is defined (see also illustration in Fig. 3) as:

$$\mathcal{D}_f(F_d, z_{def}, \hat{f}) \mapsto F_d = \begin{cases} F_d & \text{if } F_d \in \mathcal{D}_{\hat{f}} \\ F_d^\perp & \text{if } F_d \notin \mathcal{D}_{\hat{f}} \end{cases} \quad (12)$$

where F_d is the required force (given by the controller) and F_d^\perp is the orthogonal projection of F_d on $\mathcal{D}_{\hat{f}}$.

This definition will inspire the form of the considered scheduling parameter used in the LPV control.

In more detail, the ρ parameter is tuned as following:

- when ρ is low, $W_u(\rho)$ is small and it does not penalize the control signal u .
- when ρ is high, $W_u(\rho)$ is large and it attenuates the control signal u to remain in semi-active domain.

For that purpose the following scheduling strategy $\rho(\varepsilon)$ is introduced:

$$\rho(\varepsilon) := \begin{cases} \underline{\rho} & \text{if } \varepsilon < \mu \\ \underline{\rho} + \frac{\bar{\rho} - \underline{\rho}}{\mu}(\varepsilon - \mu) & \text{if } \mu \leq \varepsilon \leq 2\mu \\ \bar{\rho} & \text{if } \varepsilon > 2\mu \end{cases} \quad (13)$$

$$\varepsilon = \|F_d - F_d^\perp\|_2 \quad (14)$$

where ε is the distance between the required force and the force projected on the adapted dissipative domain $\mathcal{D}_{\hat{f}}$ (according to the function of $\mathcal{D}_f(F_d, z_{def}, \hat{f})$). μ is a design parameter that modifies the dead-zone of the $\rho(\varepsilon)$ function (μ is chosen sufficiently low e.g $\mu = 0.1$).

Remark:

- By this definition, $\rho(\varepsilon)$ belongs to $[\underline{\rho}, \bar{\rho}]$ which is essential in the LPV framework ($\underline{\rho} = 0.01, \bar{\rho} = 1$).
- $\varepsilon \neq 0 (\Leftrightarrow F_d \neq F_d^\perp)$ means that the required force is outside the allowed range. Conversely, $\varepsilon = 0 (\Leftrightarrow F_d = F_d^\perp)$ means that the force required by the controller is reachable for the considered semi-active actuator.

This varying parameter has been used to schedule the designed static state-feedback vehicle controller.

4.2 H_∞ /LPV control design for FTC

It is worth noting that, while the model car is a LTI system, the generalized plant (which consists of the suspension model and weighting functions) is a LPV one because of parameter dependent weighting function $W_u(\rho)$. Then the following parameter

dependent suspension generalized plant ($\Sigma_v(\rho)$) is expressed in:

$$\Sigma(\rho) : \begin{cases} \dot{\xi} = \mathcal{A}(\rho)\xi + \mathcal{B}_1(\rho)\tilde{w} + \mathcal{B}_2 u \\ \tilde{z} = \mathcal{C}_1(\rho)\xi + \mathcal{D}_{11}(\rho)\tilde{w} + \mathcal{D}_{12} u \\ y = \mathcal{C}\xi \end{cases} \quad (15)$$

where $\xi = [\chi_{quarter} \ \chi_{wf}]^T$, $\chi_{quarter}$, χ_{wf} are the quarter model and weighting function states respectively.

$\tilde{z} = [z_1 \ z_2 \ z_3]^T$ are the controlled outputs,

$\tilde{w} = [z_r]$: the disturbance input signal,

$y = [z_{def} \ \dot{z}_{def}]$: output signals.

$u = u^{H_\infty}$: the suspension control signal derived from the H_∞/LPV framework,

ρ : the varying parameters, $\rho \in [0.01 \ 1]$.

The generalized plant (15) depends on the varying parameter (ρ), so $\Sigma_v(\rho)$ can be expressed as a polytopic system composed by $N = 2$ vertices ω_i , $i=1, 2$:

$$\Sigma_v(\rho) = \frac{|\rho - \bar{\rho}|}{\bar{\rho} - \underline{\rho}} \Sigma_v(\underline{\rho}) + \frac{|\rho - \underline{\rho}|}{\bar{\rho} - \underline{\rho}} \Sigma_v(\bar{\rho}) \quad (16)$$

where $\Sigma_v^i(\rho)$ defines the system at i^{th} vertice;

Now, let denote K is the state feedback controller of the generalized plant $\Sigma_v(\rho)$ such that the control input: $u^{H_\infty} = K.x$. Then, thanks to the Bounded Real Lemma (BRL), finding such a controller leads to solve the optimization following (see in Scherer et al. (1997)):

Min γ such that:

$$\begin{bmatrix} (\mathcal{A} + \mathcal{B}_2 K)\mathcal{P} + \mathcal{P}(\mathcal{A} + \mathcal{B}_2 K)^T & \mathcal{B}_1 & \mathcal{P}(\mathcal{C}_1 + \mathcal{D}_{12} K)^T \\ * & -I & \mathcal{D}_{11}^T \\ * & * & -\gamma^2 I \end{bmatrix} < 0 \quad (17)$$

where \mathcal{P} is a symmetric positive definite matrix. The condition (17) is a Bilinear Matrix Inequality (BMI), by denoting $Q = K\mathcal{P}$, one obtains the following LMI:

$$\begin{bmatrix} (\mathcal{A}\mathcal{P} + \mathcal{B}_2 Q) + (\mathcal{A}\mathcal{P} + \mathcal{B}_2 Q)^T & \mathcal{B}_1 & (\mathcal{C}_1\mathcal{P} + \mathcal{D}_{12} Q)^T \\ * & -I & \mathcal{D}_{11}^T \\ * & * & -\gamma^2 I \end{bmatrix} < 0 \quad (18)$$

Solving this problem, one receives the state feedback controller $K = Q\mathcal{P}^{-1}$.

It is important to note that the suspension controller is designed using H_∞/LPV framework for the polytopic system. Then the LPV-FTC controller is a convex combination of the controllers computed at each vertex, so the control input can be expressed as:

$$u^{H_\infty} = \left(\frac{|\rho - \bar{\rho}|}{\bar{\rho} - \underline{\rho}} K(\underline{\rho}) + \frac{|\rho - \underline{\rho}|}{\bar{\rho} - \underline{\rho}} K(\bar{\rho}) \right) x \quad (19)$$

Since the LMI problem is solved at each vertex of the polytope formed by the limit values of the varying parameter, the stability will be guaranteed for all trajectories of the varying parameter.

5. SIMULATION RESULTS

To validate the proposed LPV-FTC, simulations are performed on a non linear Renault Mégane Coupé (RMC) model from the test car available in MIPS Laboratory (Mulhouse, France) (see in Zin (2005)). The model parameters are given in the following table:

Parameter	m_s [kg]	m_{us} [kg]	k_s [N/m]	k_i [N/m]	c [Nm/s]
Value	315	37.5	29500	210000	{700,5000}

Table 1. Parameter values of the Renault Mégane Coupé quarter car model

The following scenario is used to test the performance of the proposed LPV/ H_∞ fault tolerant control:

- The vehicle runs at 30km/h in a straight line on a dry road ($\mu = 1$ stands for the adherence to the road).
- The vehicle has a faulty semi-active damper because of an oil leakage, 50% of reduction of the nominal damping force ($\alpha = 0.5$), occurs at $t=0$.
- a 3cm bump on the wheel from $t = 1$ to 1.5s.

First, the actuator failure has been estimated using the procedure presented in section 3. Fig.5 shows the estimation of oil leakage degree $\hat{\alpha} = \frac{F_{sa} - \hat{f}}{F_{sa}}$ which represents a lost force of 50% with respect to the nominal damper force.

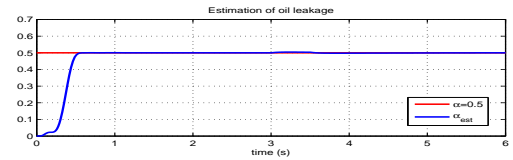

Fig. 5. Estimation of oil leakage

Here the given simulation results aim at proving that the fault-scheduled LPV strategy to handle a damper failure, are improving the performances of the previous LPV semi-active control strategy in Poussot-Vassal et al. (2008).

The result will show a comparison between a classic semi-active LPV controller without fault tolerance features, denoted as "LPV nominal without FTC" in blue, and the proposed LPV-FTC in red. Figure 6 shows that in case of faulty damper, the

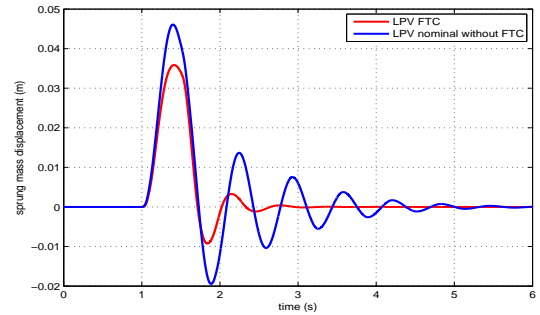

Fig. 6. Sprung mass motion

LPV-FTC allows to mitigate the sprung mass displacement with respect to the LPV nominal without FTC. Indeed, when the vehicle occurs a bump, the suspension force is required to reduce this motion. Because of a reduction of the nominal damping force, the LPV without FTC cannot compensate the fault. On the other hand, by a FTC strategy, it allows to reconfigure the damper force and attenuates the motion. The comfort of the passengers is then increased in contrast to the not adapted case.

The unsprung mass displacement and the suspension displacement are plotted in Figure 7, 8. The LPV-FTC allows to reduce the unsprung mass motion as well as the relative deflection with

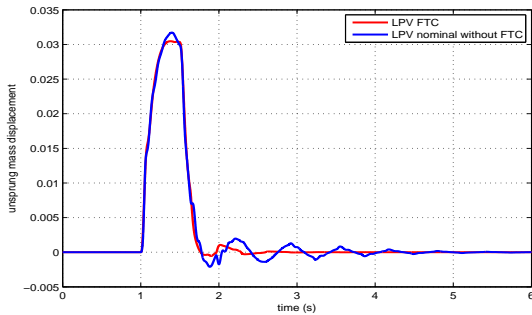

Fig. 7. Unsprung mass motion

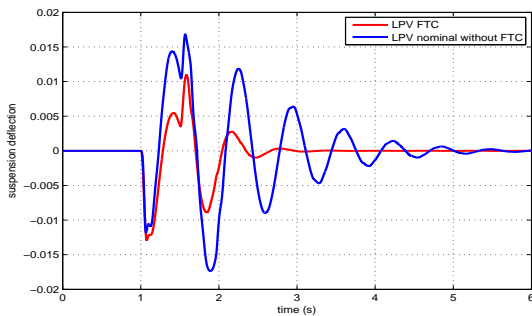

Fig. 8. Suspension deflection

respect to the LPV nominal without FTC. It demonstrates that the road holding is improved by the proposed method.

6. CONCLUSION

The paper has presented a new LPV/H_∞ fault tolerant control for a faulty semi-active suspension system. When there exist a fault in damper such as oil leakages, the fast adaptive fault estimation algorithm is used to estimate the damper fault. Then using the obtained fault information, the LPV FTC is designed to ensure the damper dissipativity constraint. This FTC strategy allows to online reconfigure provided suspension force according to fault situation, in order to achieve the designed performance objectives in both comfort and road holding. Moreover, the Fault Tolerant Control has been designed in the LPV/H_∞ framework allowing to simplify the implementation procedure. The next step of this work will be the implementation of this strategy on a test benchmark, available at Gipsa-lab Grenoble, developed in collaboration with a high-tech start-up "SOBEN". It consists of a vehicle equipped with four controllable Electro-Rheological dampers, and of 4 DC motors generating separately different road profiles on each wheel. First experimental results on the test-bed are presented in Sename et al. (2014).

REFERENCES

- Do, A.L., Sename, O., and Dugard, L. (2010). An LPV control approach for semi-active suspension control with actuator constraints. In *Proceedings of the IEEE American Control Conference (ACC)*, 4653 – 4658. Baltimore, Maryland, USA.
- Do, A.L., Sename, O., and Dugard, L. (2012). LPV modelling and control of semi-active dampers in automotive systems. In J. Mohammadpour and C. Scherer (eds.), *Control of Linear Parameter Varying Systems with Applications*, chapter 15. Springer.
- Do, A.L., Sename, O., Dugard, L., Boussaad, S., et al. (2011). Multi-objective optimization by genetic algorithms in h/lpv control of semi-active suspension. In *Proceedings of the 18th IFAC World Congress*.
- Edwards, C., Spurgeon, S.K., and Patton, R.J. (2000). Sliding mode observers for fault detection and isolation. *Automatica*, 36(4), 541–553.
- Fischer, D. and Isermann, R. (2004). Mechatronic semi-active and active vehicle suspensions. *Control Engineering Practice*, 12(11), 1353–1367.
- Gertler, J. (1997). Fault detection and isolation using parity relations. *Control engineering practice*, 5(5), 653–661.
- Gillespie, T.D. (1992). *Fundamentals of vehicle dynamics*.
- Kiencke, U. and Nielsen, L. (2000). Automotive control systems: for engine, driveline, and vehicle. *Measurement Science and Technology*, 11(12), 1828.
- Poussot-Vassal, C., Sename, O., Dugard, L., Gaspar, P., Szabo, Z., and Bokor, J. (2008). A new semi-active suspension control strategy through lpv technique. *Control Engineering Practice*, 16(12), 1519–1534.
- Poussot-Vassal, C., Spelta, C., Sename, O., Savaresi, S.M., and Dugard, L. (2012). Survey and performance evaluation on some automotive semi-active suspension control methods: A comparative study on a single-corner model. *Annual Reviews in Control*, 36(1), 148–160.
- Rodrigues, M., Hamdi, H., Theilliol, D., Mechmeche, C., and BenHadj Braiek, N. (2014). Actuator fault estimation based adaptive polytopic observer for a class of lpv descriptor systems. *International Journal of Robust and Nonlinear Control*.
- Savaresi, S.M., Poussot-Vassal, C., Spelta, C., Sename, O., and Dugard, L. (2010). *Semi-active suspension control design for vehicles*. Elsevier.
- Scherer, C., Gahinet, P., and Chilali, M. (1997). Multiobjective output-feedback control via lmi optimization. *Automatic Control, IEEE Transactions on*, 42(7), 896–911.
- Sename, O., Tudon-Martinez, J.C., and Fergani, S. (2013). Lpv methods for fault-tolerant vehicle dynamic control. In *Control and Fault-Tolerant Systems (SysTol), 2013 Conference on*, 116–130.
- Sename, O., Basset, M., Talon, B., D'Andrea-Novell, B., Koenig, D., and Martinez, J. (2014). The inove anr 2010 blan 0308 project: Integrated approach for observation and control of vehicle dynamics. In *ECC*, 2340–2345. Strabourg, France.
- Shi, F. and Patton, R. (2014). Active fault tolerant control of lpv descriptor systems based on extended state observers. In *American Control Conference (ACC), 2014*, 4458–4463. IEEE.
- Varrier, S. (2013). *Détection de situations critiques et commande robuste tolérante aux défauts pour l'automobile*. Ph.D. thesis, Institut National Polytechnique de Grenoble-INPG.
- Zhang, K., Jiang, B., Cocquempot, V., et al. (2008). Adaptive observer-based fast fault estimation. *International Journal of Control Automation and Systems*, 6(3), 320.
- Zhang, Y. and Jiang, J. (2008). Bibliographical review on reconfigurable fault-tolerant control systems. *Annual Reviews in Control*, 32(2), 229 – 252.
- Zin, A. (2005). *Robust automotive suspension control toward global chassis control*. PhD thesis (in french), INPG, Laboratoire d'Automatique de Grenoble (new GIPSA-lab), Grenoble, France.