



# ANALYSIS AND MODELING OF PASSIVE DEVICE DEGRADATION FOR THE LONG-TERM ELECTROMAGNETIC EMISSION PREDICTION OF A DC-DC CONVERTER

A. Boyer, H. Huang, S. Ben Dhia

CNRS, LAAS, 7 avenue du colonel Roche, F-31400 Toulouse, France

Univ. de Toulouse, INSA, LAAS, F-31400 Toulouse, France



# Outline

- **Context – Long-term EMC**
- **Device under test and experimental set-up**
- **Experimental results and analysis**
- **Long-term EME modeling**
- **Statistical dispersion between devices**
- **Electromagnetic reliability prediction**
- **Conclusion**

# Context – Long-term EMC

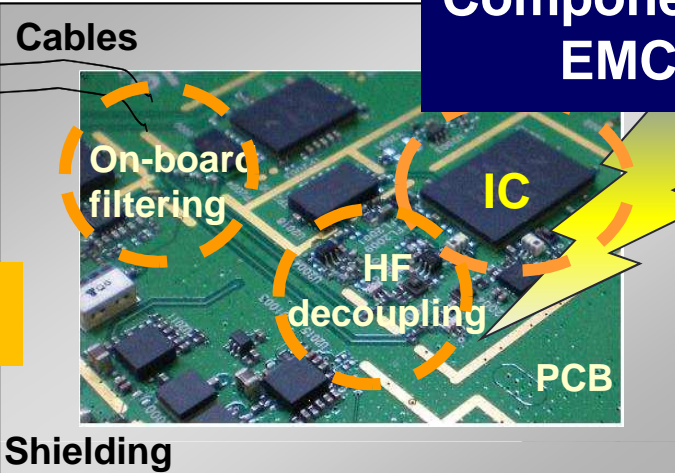
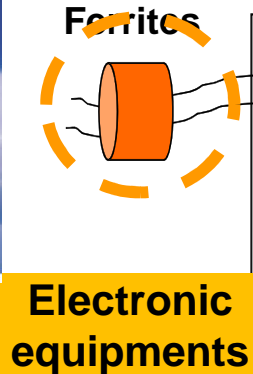

**Impact of Components aging on EMC levels ?**

*Harsh conditions (electric stresses, high temperature, vibration...)*

**EMC Tests Compliance ?**

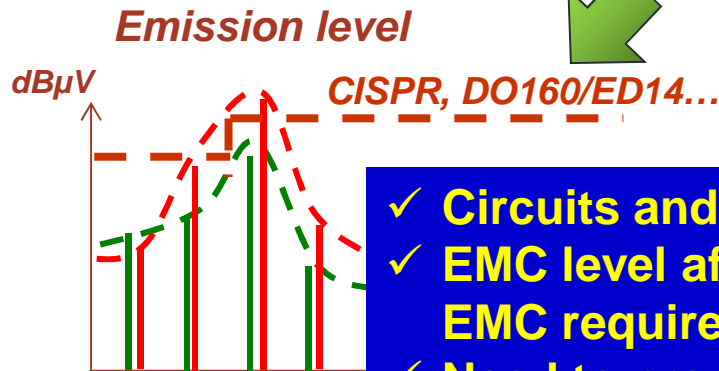
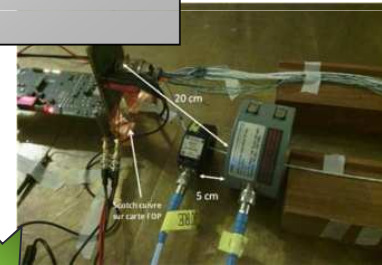

- ✓ Circuits and systems still operational
- ✓ EMC level affected → Sufficient EMC margins ?
- ✓ EMC requirements not met during lifetime ?
- ✓ Need to predict EMC of ICs after several years of operating life

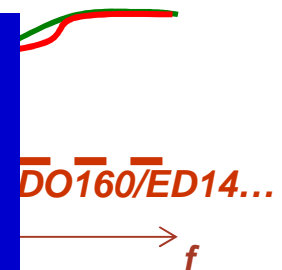

# Device under test and experimental set-up

- DC-DC step-down converter
  - ✓ Switching frequency = 240 kHz
  - ✓ Conducted emission measurement: current clamp, 150  $\Omega$  probe
  - ✓ Radiated emission measurement: TEM cell
  - ✓ Thermal accelerated aging: 150°C / 200 hours in operating mode
  - ✓ Re-characterization of the emission levels during the stress period

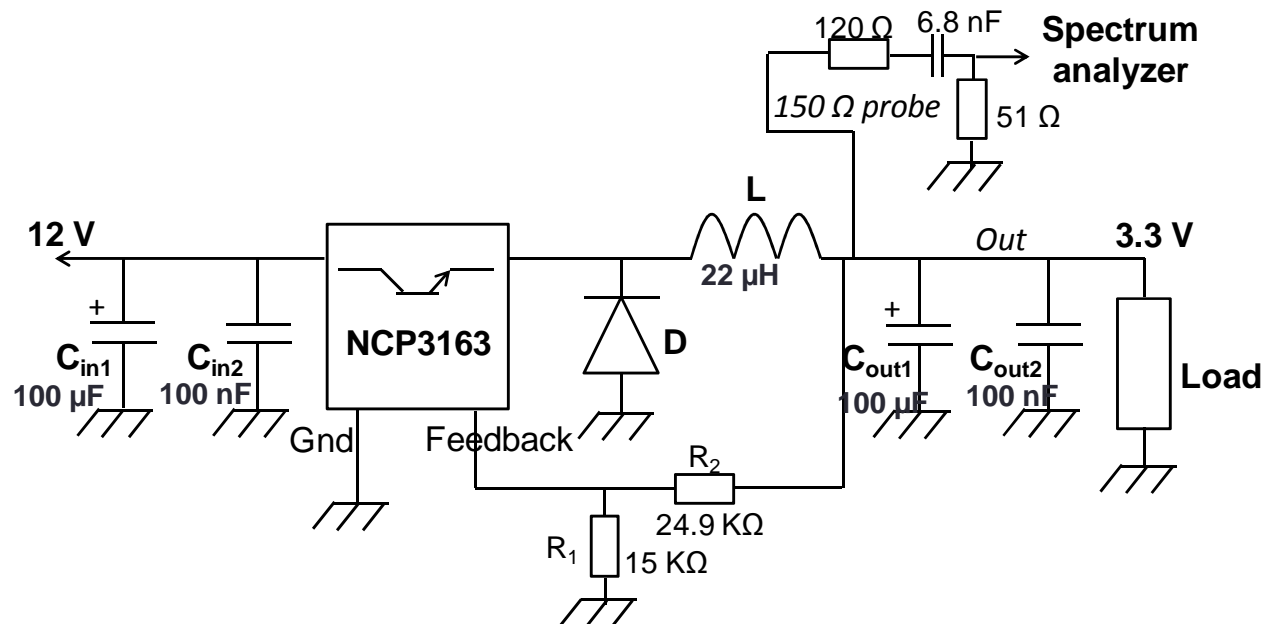

# Experimental results and analysis

- Wideband increase of electromagnetic emission after aging:
  - ✓ In conducted and radiated modes
  - ✓ Dependence to temperature and aging time
  - ✓ Drift produced by component degradation

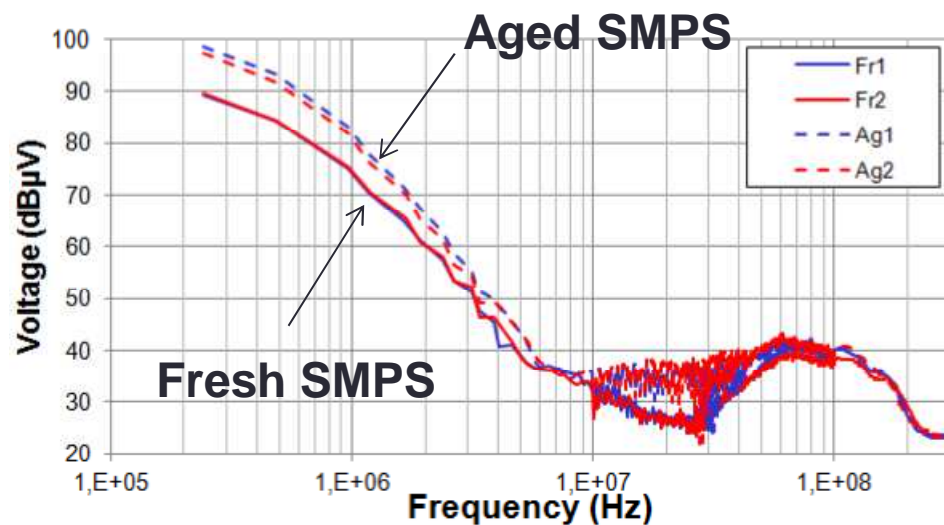

Conducted emission  
(150 ohms probe)

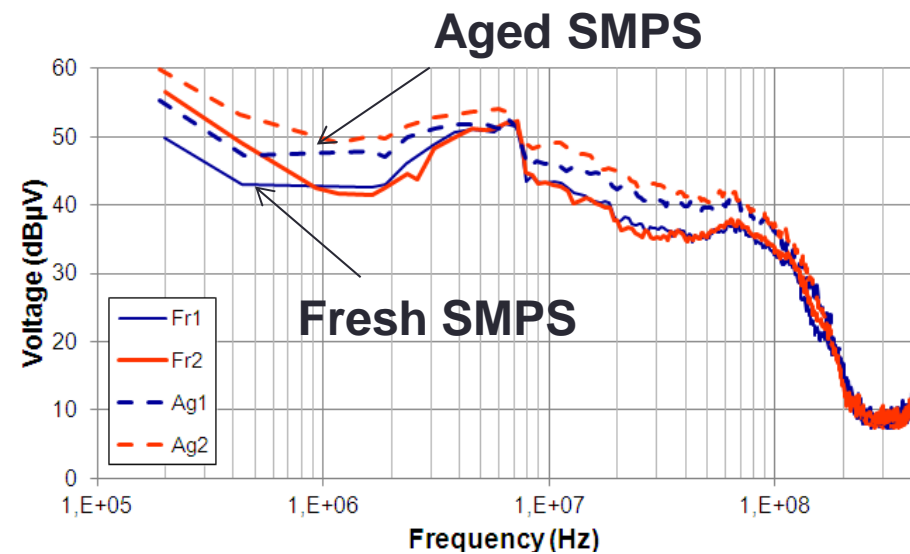

Radiated emission  
(TEM cell)

# Experimental results and analysis

- Identification of degraded components after thermal stress:
  - ✓ Monolithic converter unaltered
  - ✓ Passive devices degraded

Electrolytic aluminum capacitor	+++
Electrolytic tantalum capacitor	+
Iron powder inductor	+++
Ceramic capacitor	+
Thick film resistor	=
Schottky diode	=

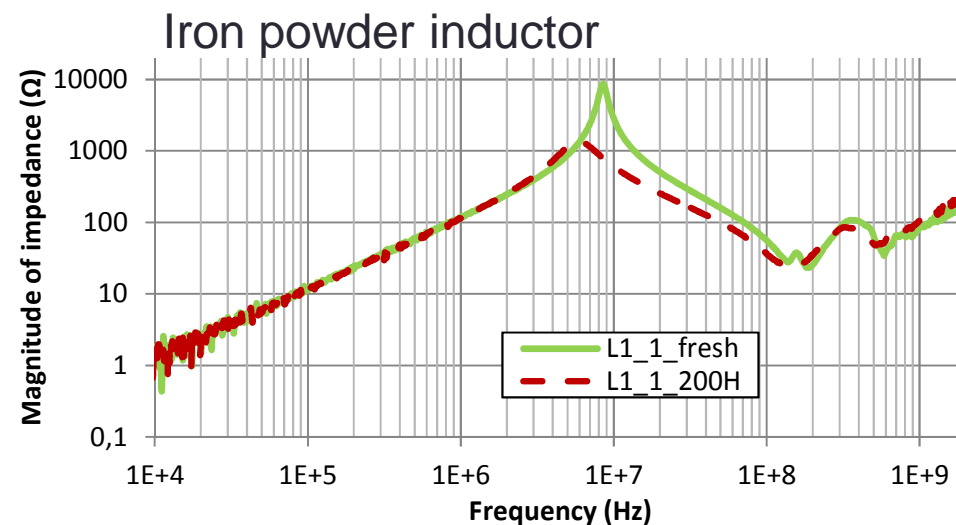
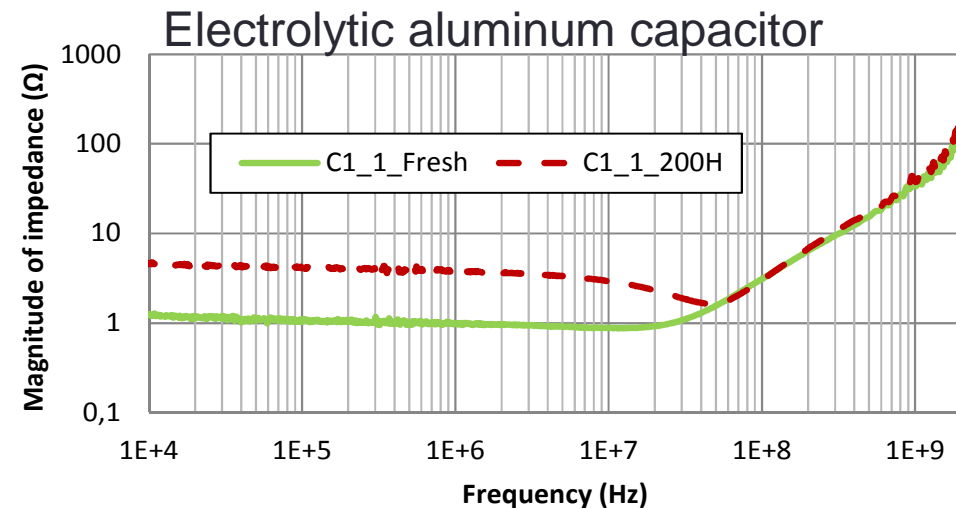

# Long-term EME modeling

- Simulation flow:

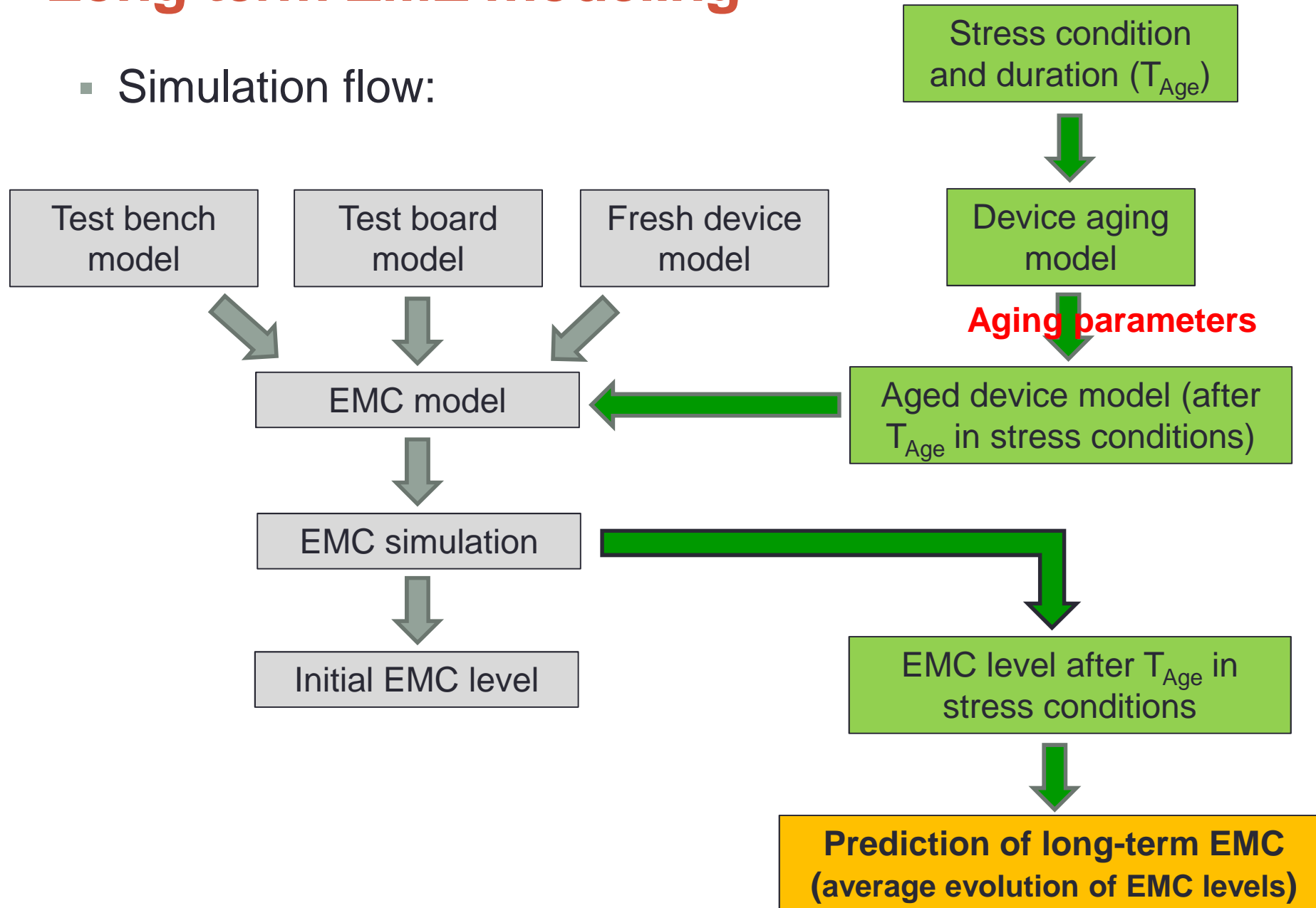

# Long-term EME modeling - Degradation models of passive devices

- Aging impact on electrolytic capacitors
- Model Panasonic EEEHBA101UAP

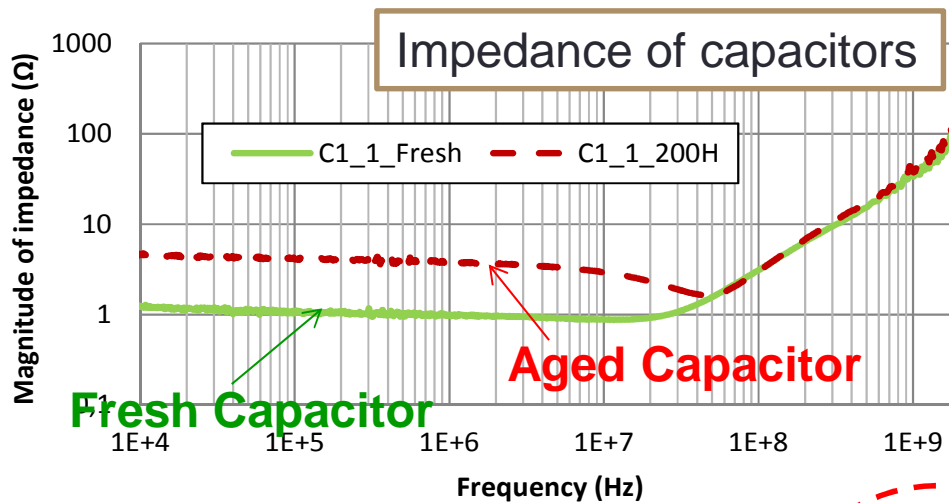

**Thermal overstress**

↓

**The decrease of the volume of electrolyte**

↓

**$C_0 \downarrow$  and  $ESR \uparrow$**

$C_0$ : Terminal Capacitance (F)  
 $Lesl$ : Inductance of ESL (H)  
 $Resl$ : Resistance of ESL ( $\Omega$ )  
 ESR: Equivalent series resistance ( $\Omega$ )

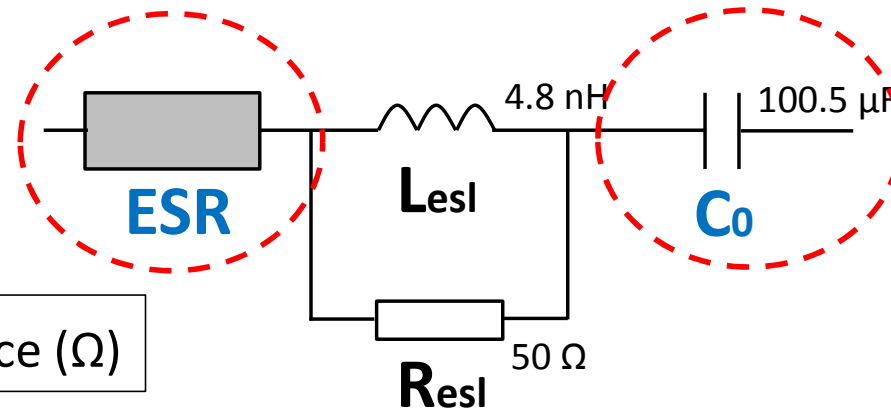

**Modeling of aluminum capacitor**



# Long-term EME modeling - Degradation models of passive devices

- Aging impact on iron powder inductors
- Model Vishay IHLP4040DZ11

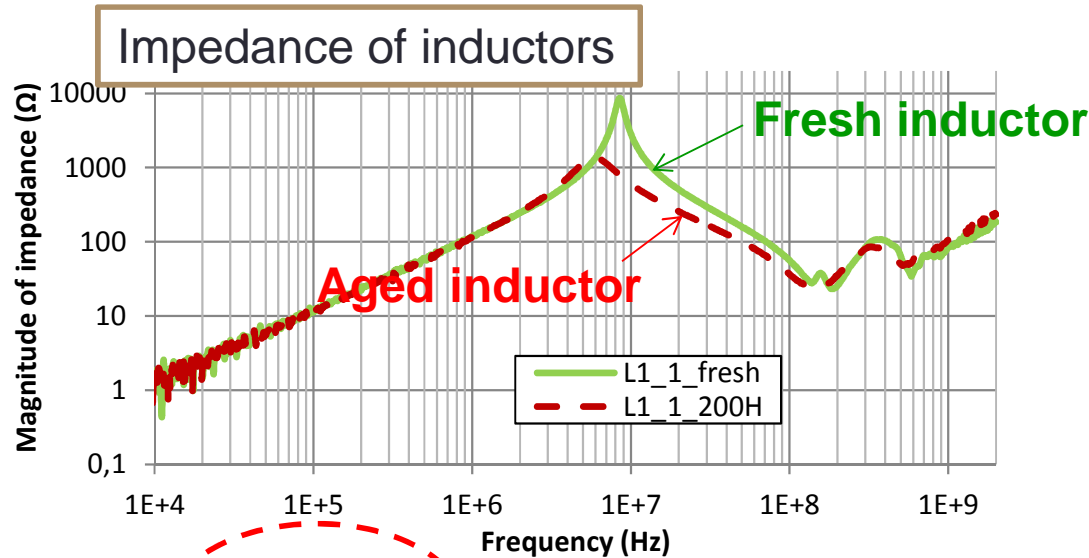

**Thermal overstress**  
 ↓  
**The increase of core loss**  
 ↓  
 **$R_p \downarrow$  and  $C_p \uparrow$**

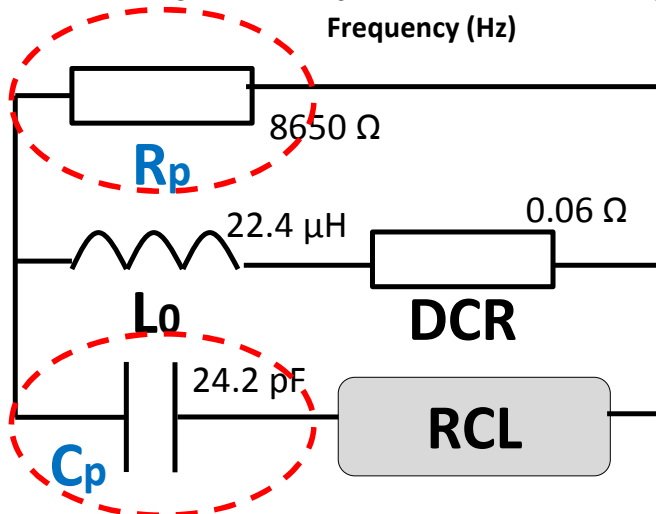

$L_o$ : Terminal inductance (H)  
 DCR: DC resistance (Ω)  
 $C_p$ : Parallel capacitance (F)  
 $R_p$ : Parallel resistance (Ω)  
 RLC: Combination of resistances, inductances and capacitances

**Modeling of powder iron inductor**

# Long-term EME modeling - Degradation models of passive devices

- Empirical degradation models of aluminum capacitors for thermal stress based on experimental data
- The aging model is formed by 2 empirical parameters ( $k_1; k_2$ ) dependent on stress conditions:

$$ESR(t) = \frac{ESR(0)}{1 - k_1 t}$$

$$C_0(t) = \frac{C_0(0)}{1 + k_2 t}$$

- Model Panasonic EEEHBA101UAP:

Biased device	$k_1$ ( $\times 10^{-3}$ )	3.49 +/- 0.18
	$K_2$ ( $\times 10^{-4}$ )	8.60 +/- 0.58
Unbiased device	$K_1$ ( $\times 10^{-3}$ )	1.87 +/- 0.03
	$K_2$ ( $\times 10^{-4}$ )	0.95 +/- 0.02

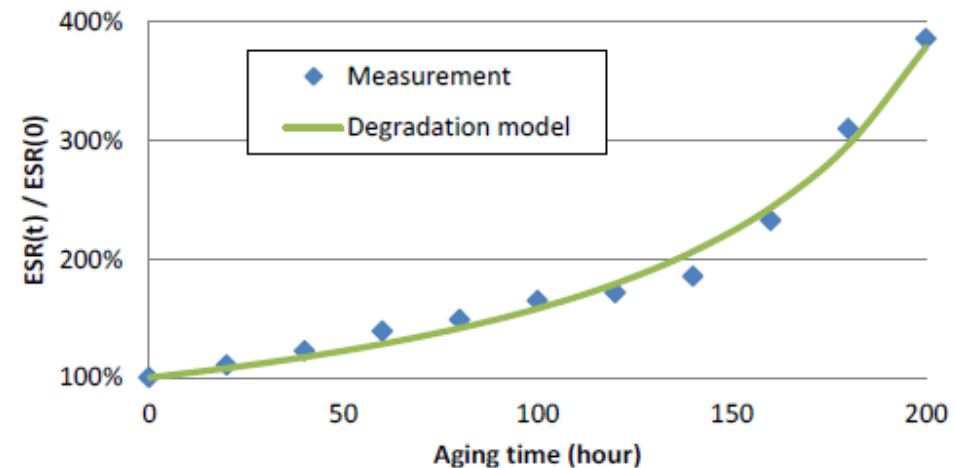
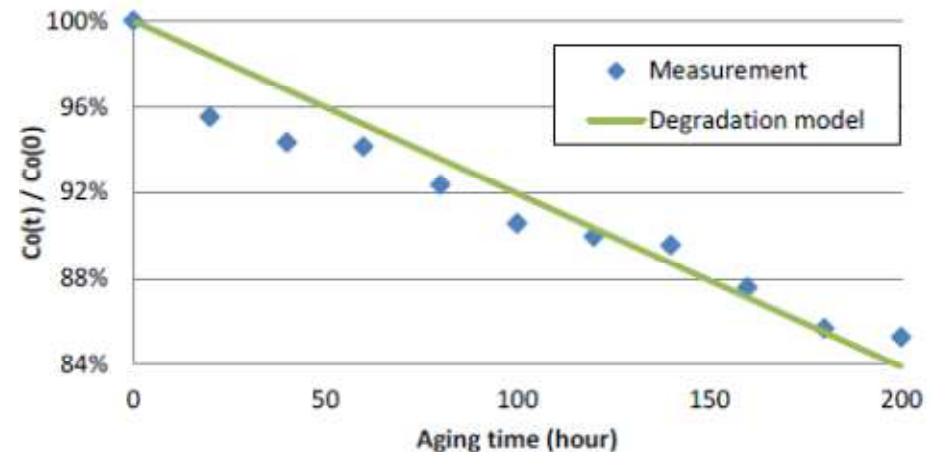

# Long-term EME modeling - Degradation models of passive devices

- Empirical degradation models of iron powder inductors for thermal stress based on experimental data
- The aging model is formed by 2 empirical parameters ( $k_3; k_4$ ) dependent on stress conditions:

$$R_P(t) = \frac{R_P(0)}{1 + k_3 t} \quad C_P(t) = C_P(0)(1 + k_4 t)$$

- Model Vishay IHLP4040DZ11 :

Biased device	$k_3$	0.07 +/- 0.04
	$K_4 (x10^{-3})$	5.27 +/- 1.71
Unbiased device	$K_3$	0.02 +/- 0.00
	$K_4 (x10^{-3})$	2.01 +/- 0.35

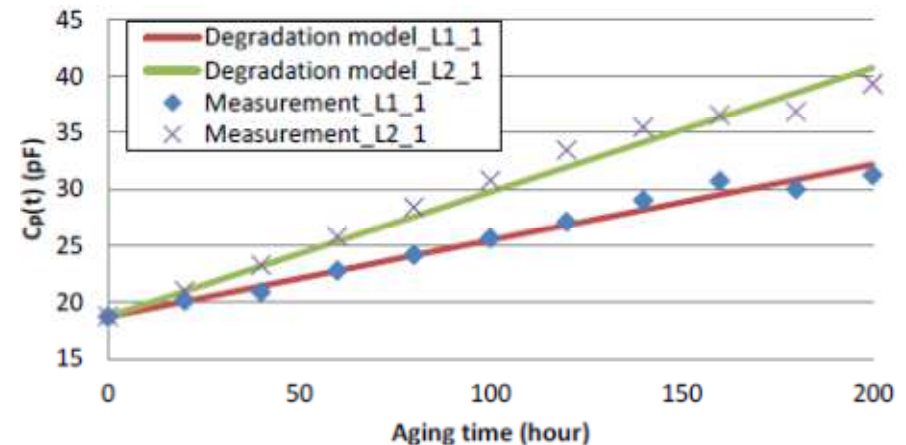
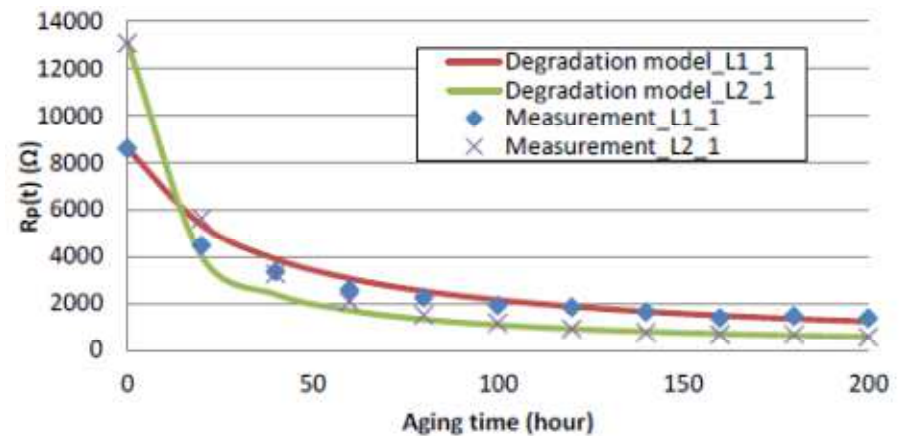

# Long-term EME modeling – Modeling of the conducted emission

- Equivalent model of conducted emission

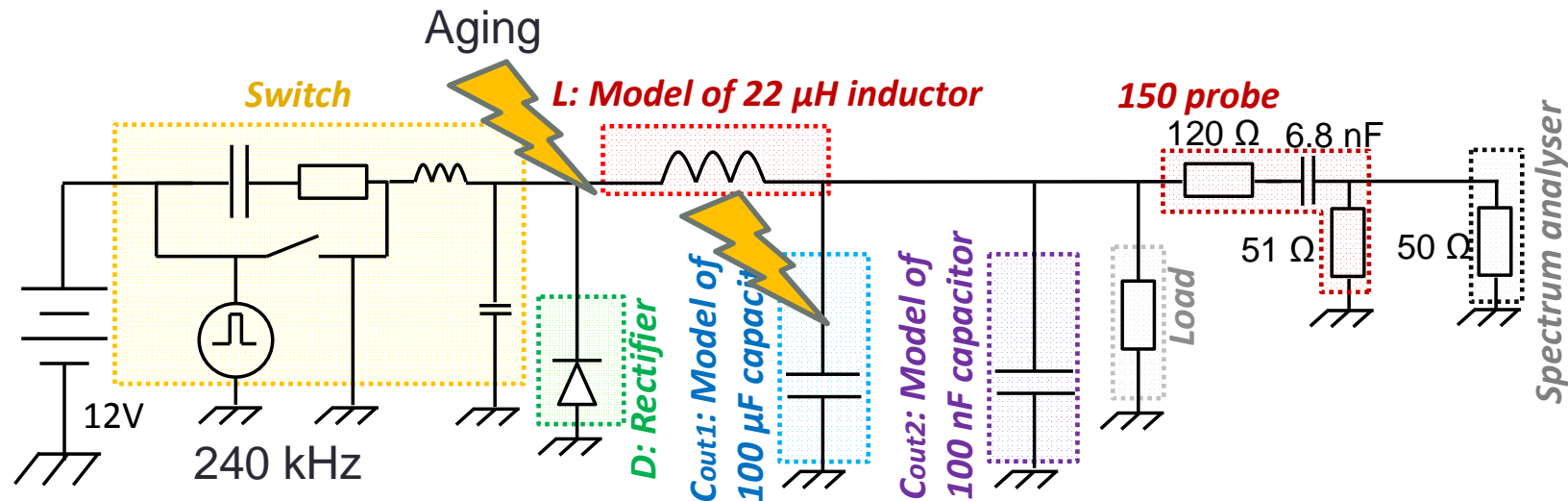

Transient simulation & FFT



Emission level in frequency domain

# Long-term EME modeling – Modeling of the conducted emission

- Detailed emission model and passive degradation model

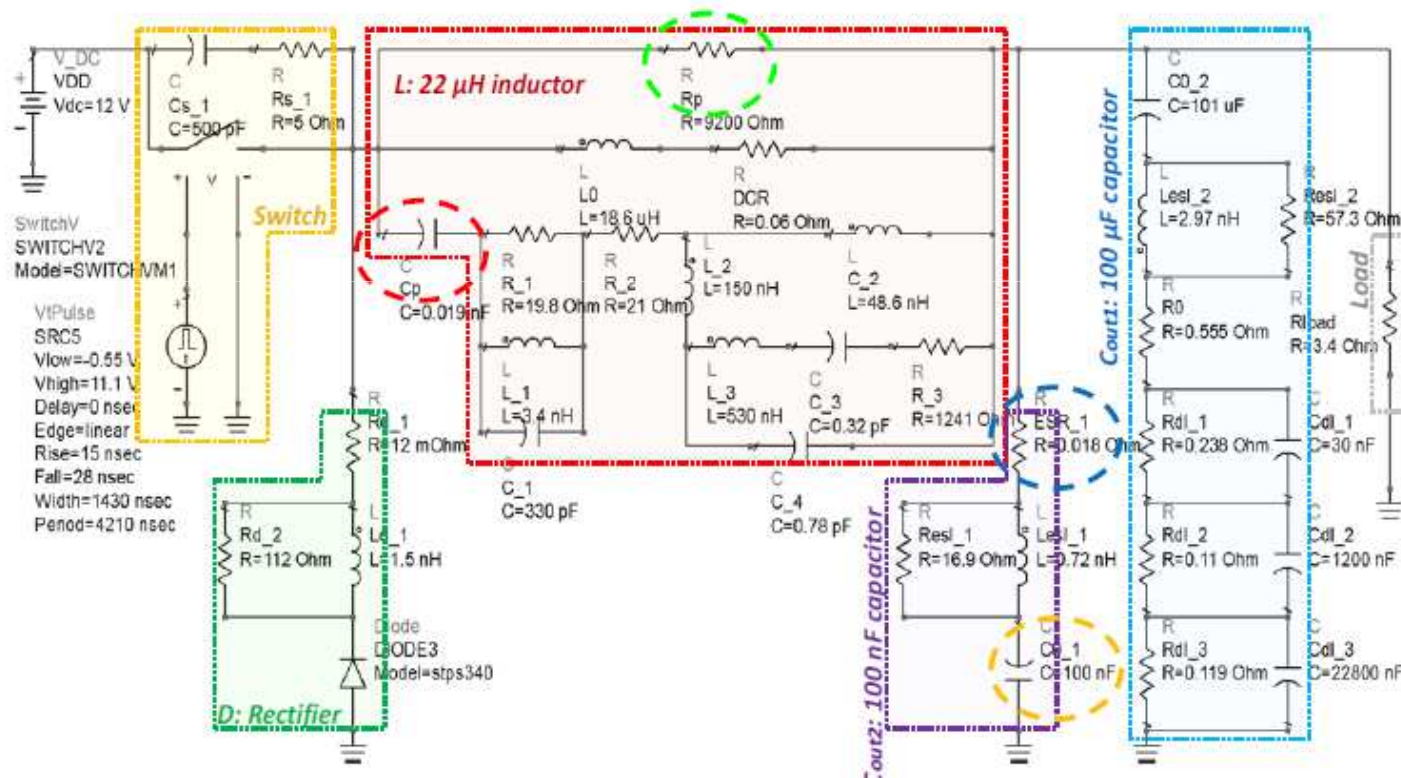

$$R_p(t) = \frac{R_p(0)}{(1 + k_3 t)}$$

$$C_p(t) = C_p(0) \cdot (1 + k_4 t)$$

$$ESR(t) = \frac{ESR(0)}{(1 - k_1 t)}$$

$$C_0(t) = \frac{C_0(0)}{(1 + k_2 t)}$$

# Long-term EME modeling – Simulation of the evolution of conducted emission

- Simulation results:

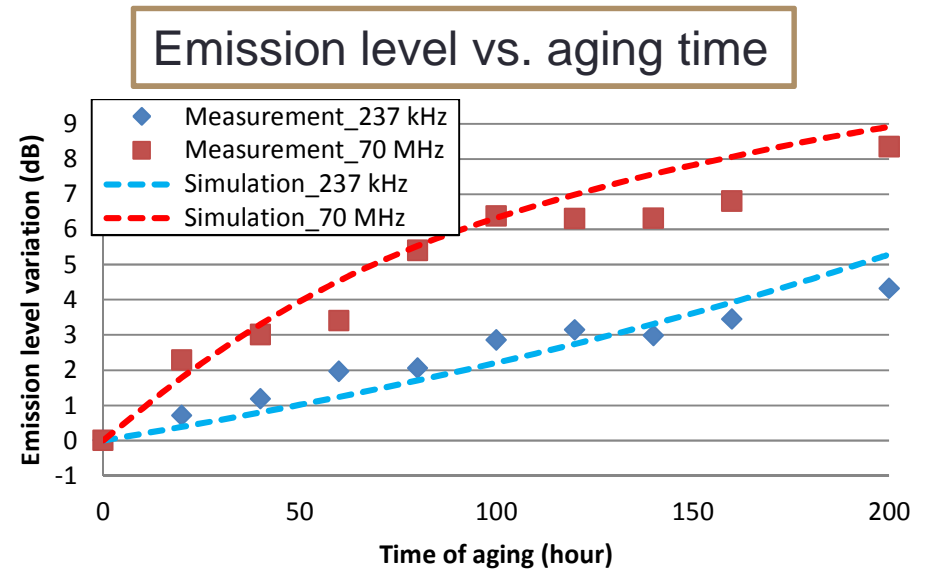
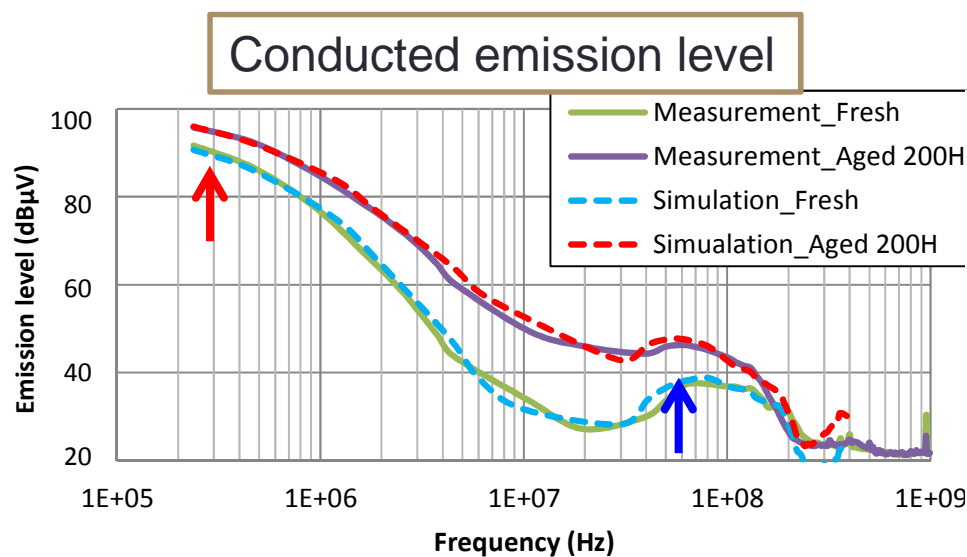

- The simulation results of the conducted emission envelop fit well with the measurement.
- The gradual evolution of the conducted emission level with time is also well modeled.



# Statistical dispersion between devices

## Before aging

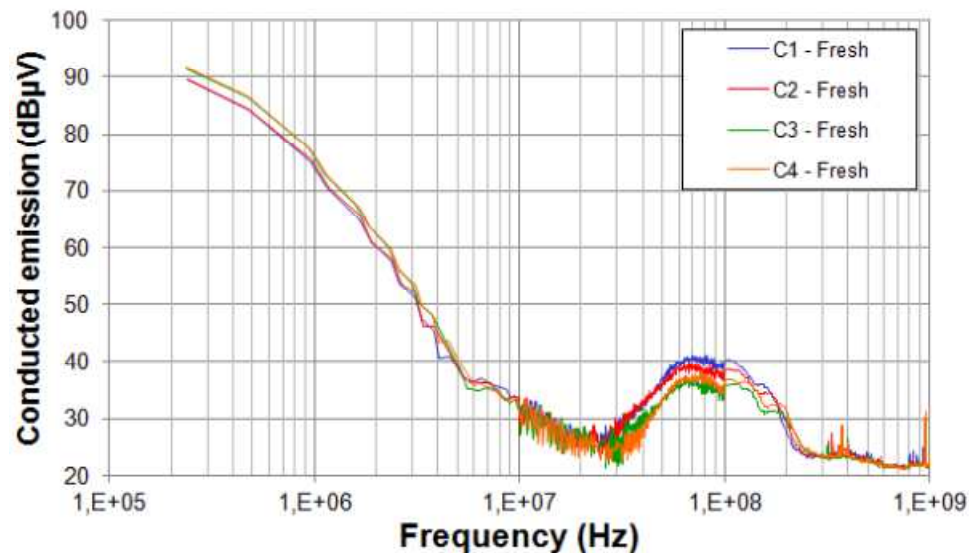

## After 200 hours thermal stress

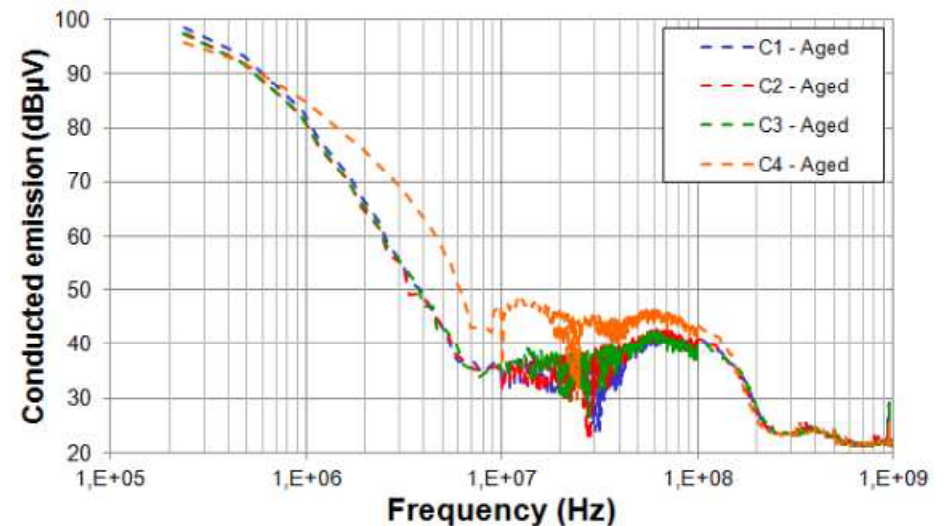

- Statistical dispersions between components leads to dispersion between emission levels
- Statistical dispersion tends to increase after aging
- Statistical dispersion of components needs to be included in long-term EMC simulation to evaluate the risk of EMC non-compliance

# Electromagnetic reliability (EMR) concept

EMR reliability  $R_{emc}(t)$  : The probability that a product is EMC compliant for a given time period under specified conditions.

EMC failure probability  $F_{emc}(t)$  : The probability that a product is no more EMC compliant after a given time period under specified conditions.

Example: Risk of non-compliance to an emission limit

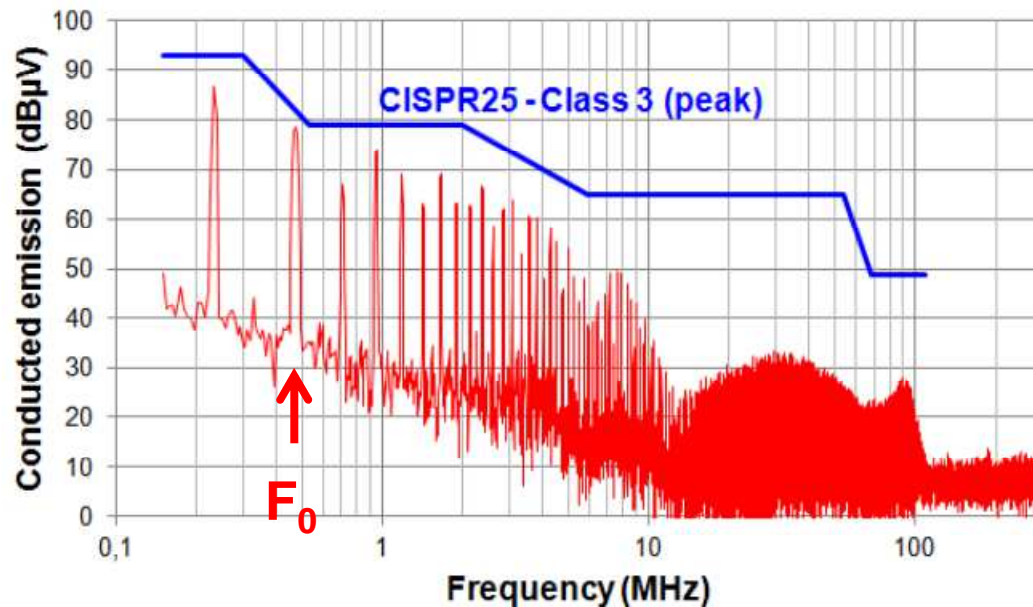

- ✓ The distribution of emission level is known
- ✓ The evolution of emission level during lifetime is known
- ✓ The emission level at frequency  $F_0$  is considered



# Electromagnetic reliability concept

Probability distribution function (PDF) of EME level

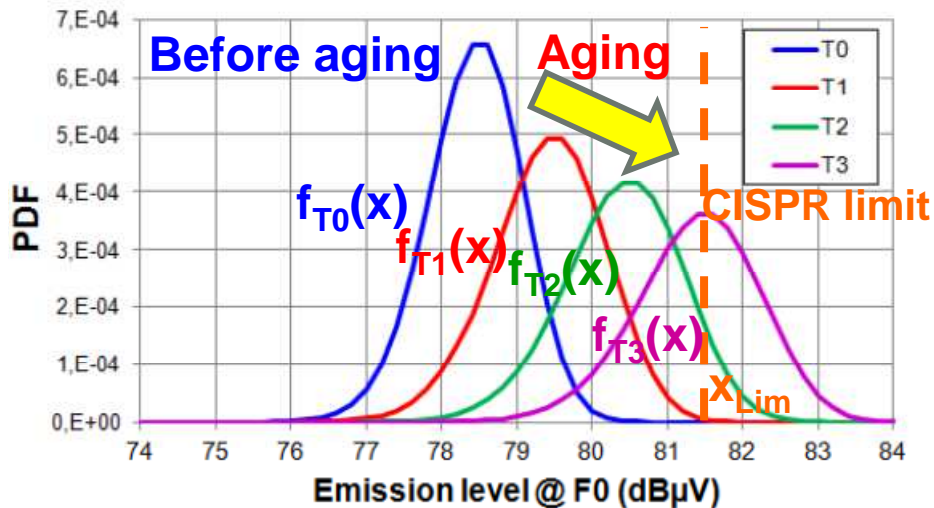

EM Reliability and failure functions

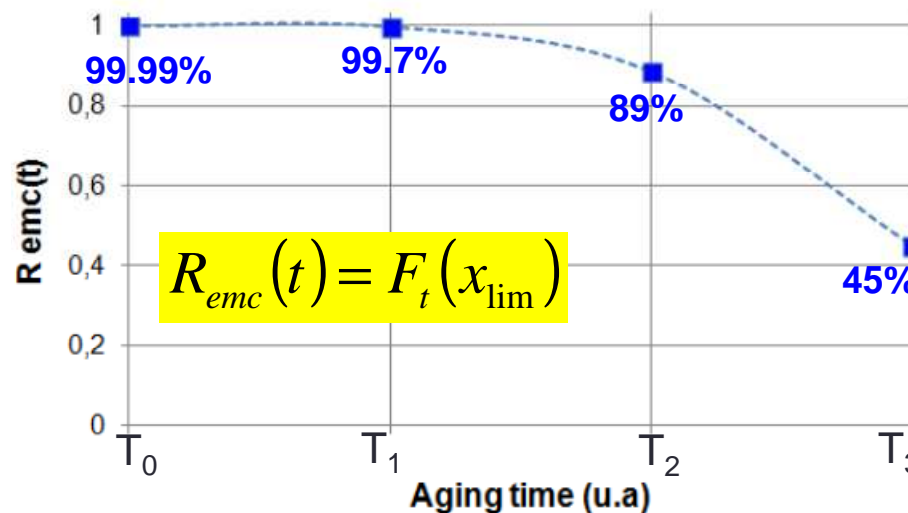

Cumulative distribution function (CDF) of EME level

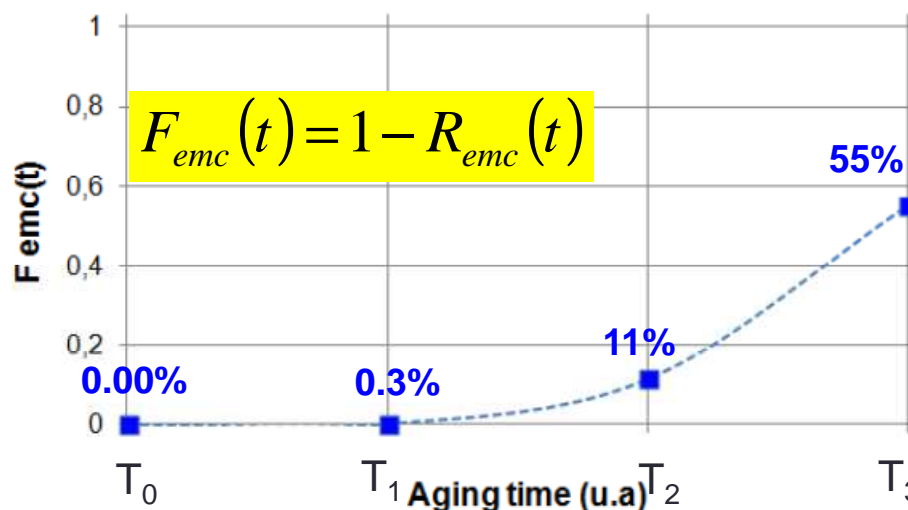
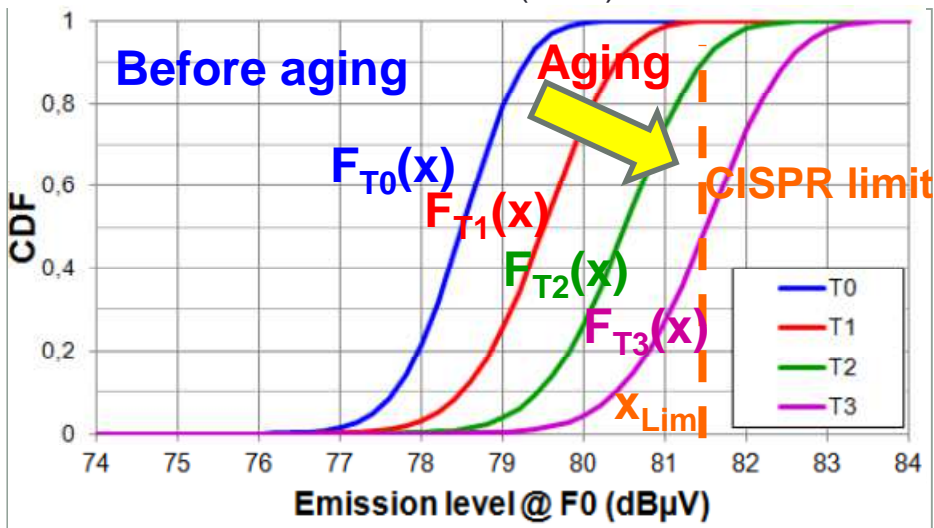

# Electromagnetic reliability prediction

- EMR simulation flow:

## Monte-Carlo simulation

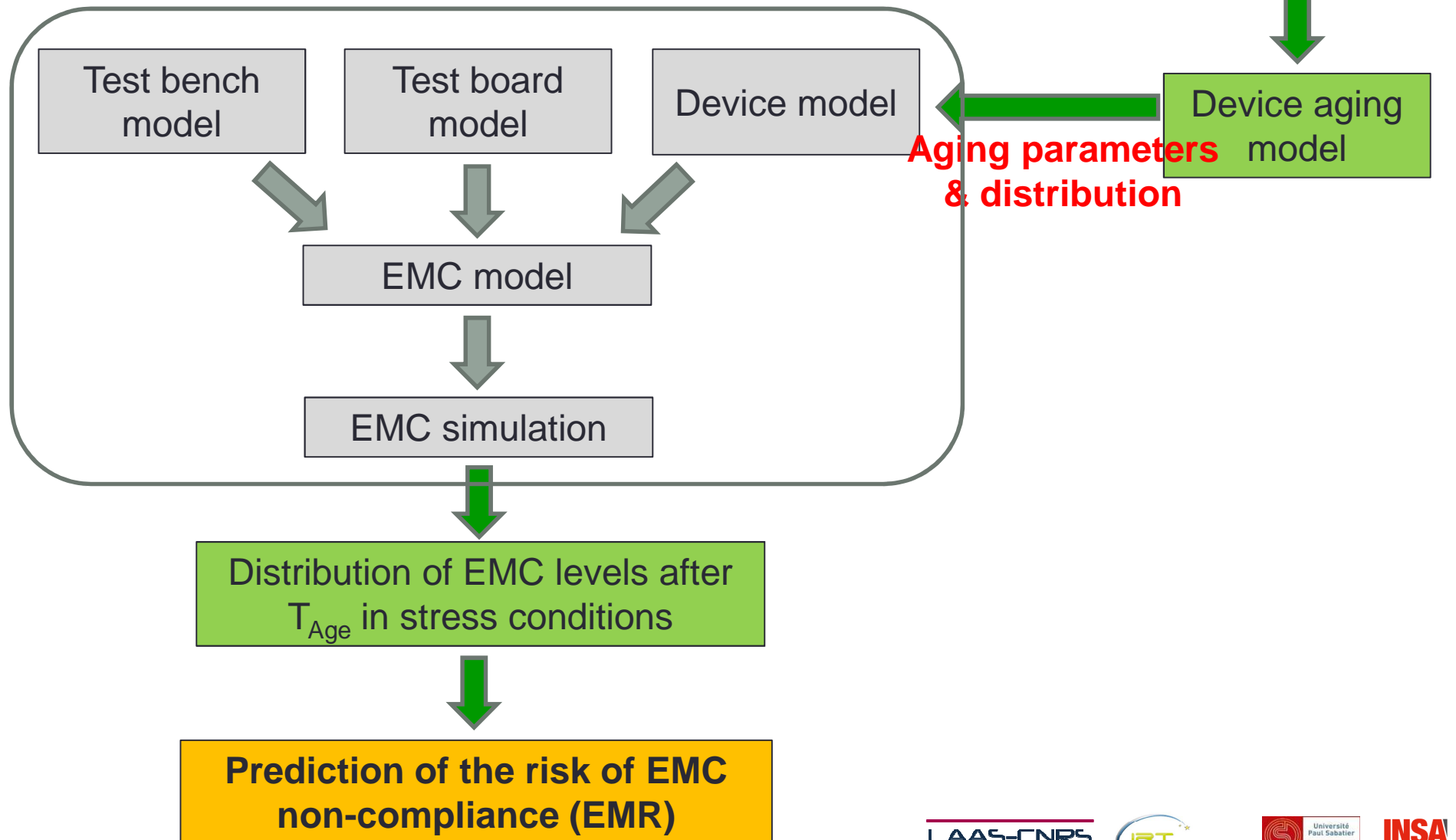

# Electromagnetic reliability prediction

- Experimental extraction of the dispersion of initial parameters of passive devices (Gaussian distribution assumption)

Device	Iron powder inductor			Aluminum capacitor		
Parameter	$L_0$ ( $\mu\text{H}$ )	$C_p$ (pF)	$R_p$ (k $\Omega$ )	$R_0$ ( $\Omega$ )	$C_0$ ( $\mu\text{F}$ )	ESL (nH)
Mean value	21.84	17.2	14.5	1.01	100.02	2.98
Std deviation	1.32	0.93	1	0.03	0.52	0.14

- Experimental extraction of the dispersion of aging parameters of passive devices (Gaussian distribution assumption)

Device	Iron powder inductor		Aluminum capacitor	
Parameter	$k_3$	$k_4$	$k_1$	$k_2$
Mean value	0.227	0.015	$3.45 \times 10^{-3}$	$8.6 \times 10^{-4}$
Std deviation	0.144	0.011	$1.9 \times 10^{-4}$	$5.82 \times 10^{-5}$

# Electromagnetic reliability prediction

- Results of Monte-Carlo simulation (5000 samples)
- Example: distribution of EME level at 237 kHz before aging /after 200 h thermal stress

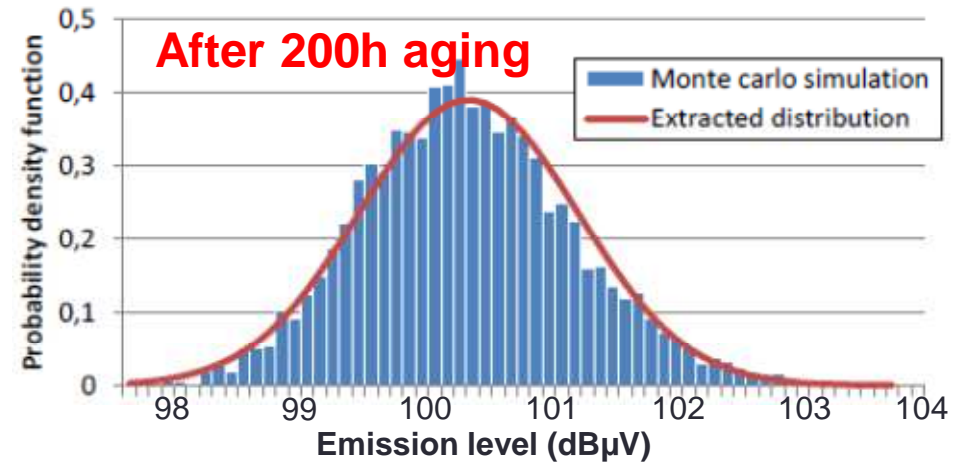
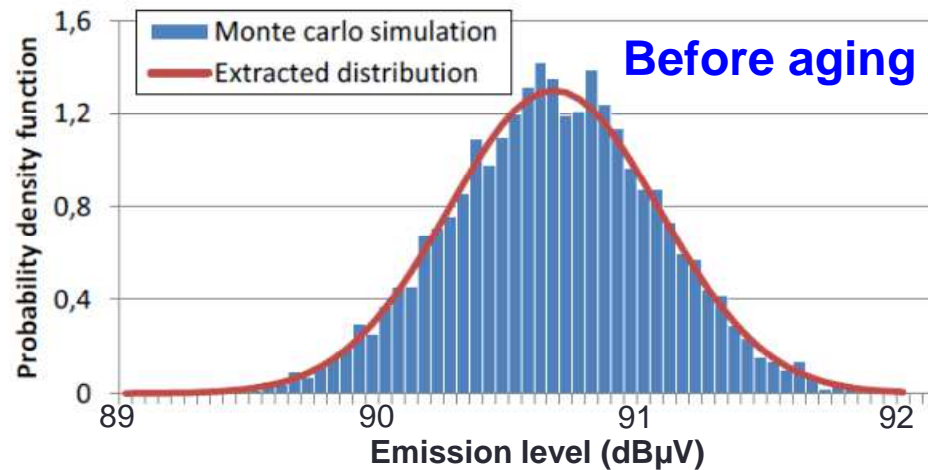

- Extraction of the distribution of the emission level and its evolution with stress time (log-normal distribution)

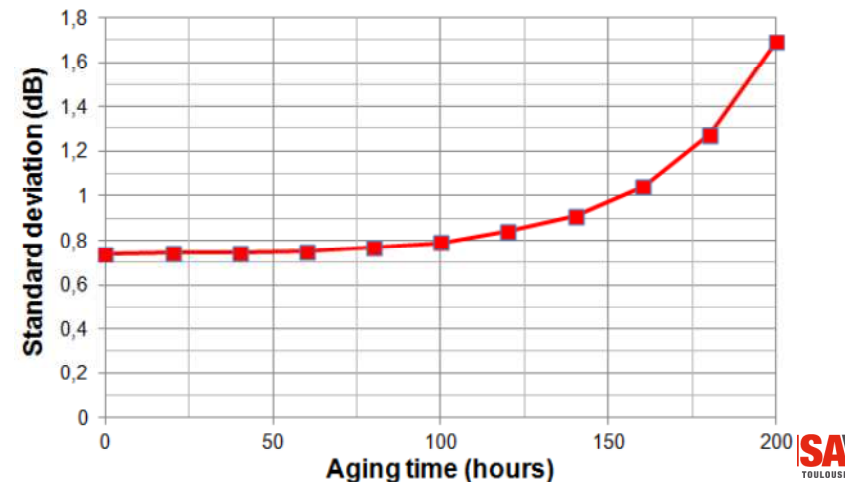
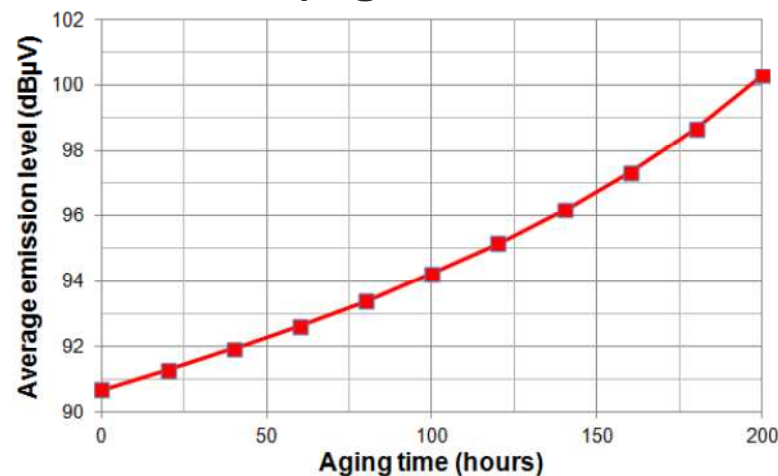

# Electromagnetic reliability prediction

- Evolution of the EMR of the DC-DC converter during accelerated life-time test:

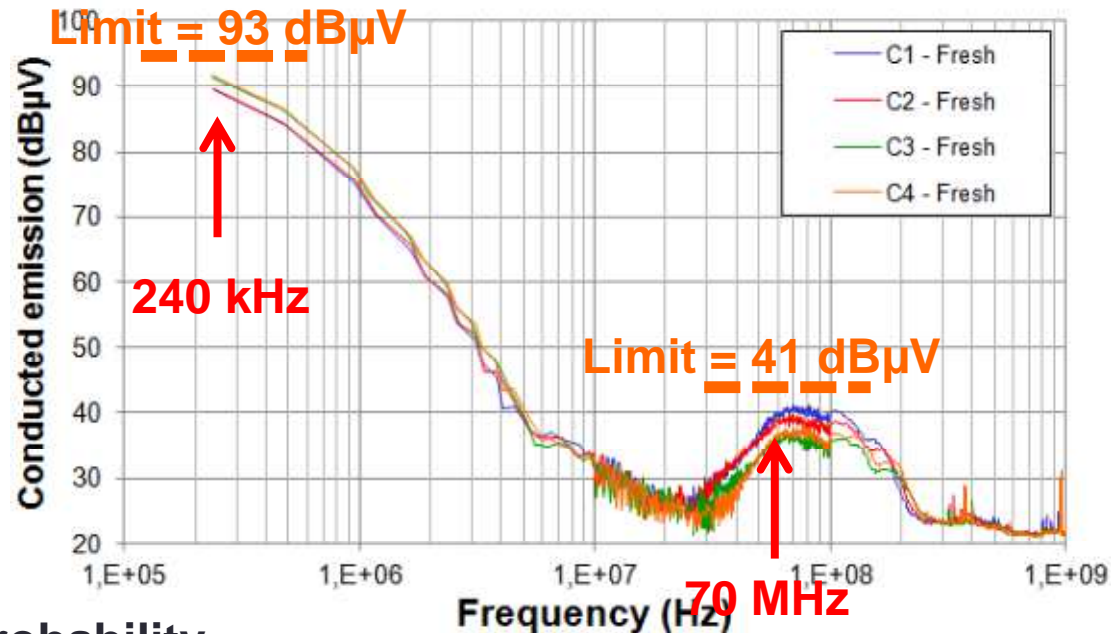

EMC failure probability

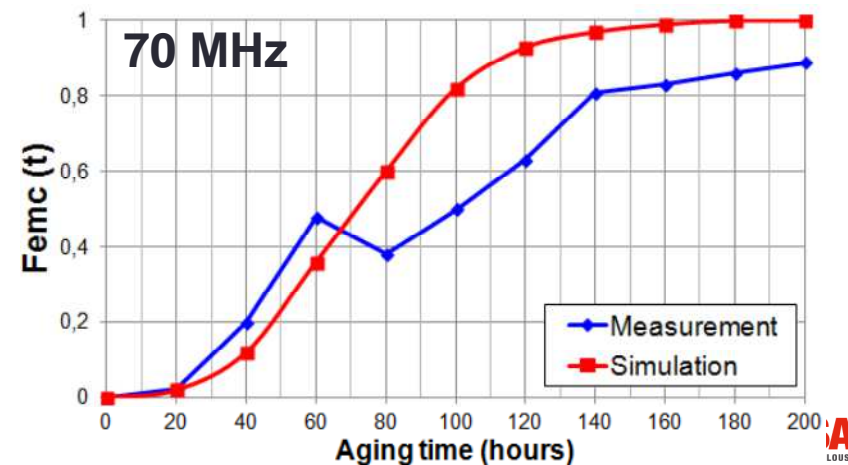
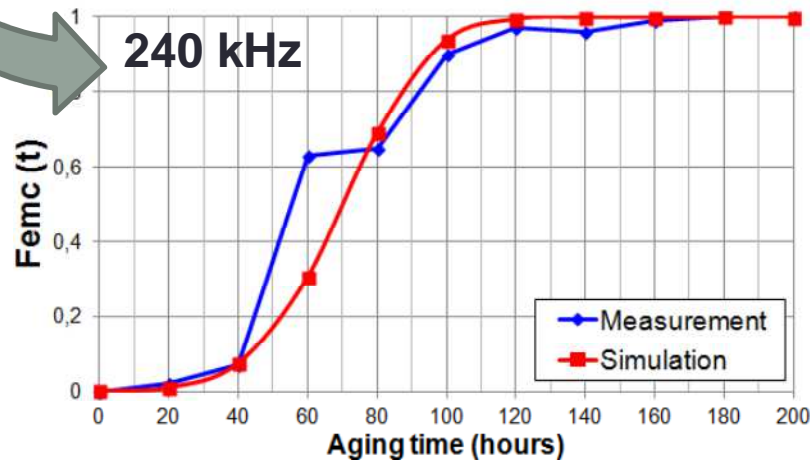

# Conclusion

- Aging may have a significant influence on EMC levels
- Thermal aging may degrade passive devices and increase EME produced by a DC-DC converter
- A simulation flow to predict the long-term evolution of EMC levels of a DC-DC converter, based on empirical model of passive devices aging
- Estimation of the EMR based on statistical analysis
- Improvement of degradation model extraction method is required

**Thank you for your attention**