



**HAL**  
open science

## High repetition rate Yb:CaF<sub>2</sub> multipass amplifiers operating in the 100 mJ range

Dimitrios N. Papadopoulos, Florence Friebel, Alain Pellegrina, Marc Hanna,  
Patrice Camy, Jean-Louis Doualan, Richard Moncorgé, Patrick Georges,  
Frédéric Druon

► **To cite this version:**

Dimitrios N. Papadopoulos, Florence Friebel, Alain Pellegrina, Marc Hanna, Patrice Camy, et al..  
High repetition rate Yb:CaF<sub>2</sub> multipass amplifiers operating in the 100 mJ range. *IEEE Journal of  
Selected Topics in Quantum Electronics*, 2014, 21 (1), pp.3100211 10.1109/JSTQE.2014.2344039 .  
hal-01222057

**HAL Id: hal-01222057**

**<https://hal.science/hal-01222057>**

Submitted on 29 Oct 2015

**HAL** is a multi-disciplinary open access archive for the deposit and dissemination of scientific research documents, whether they are published or not. The documents may come from teaching and research institutions in France or abroad, or from public or private research centers.

L'archive ouverte pluridisciplinaire **HAL**, est destinée au dépôt et à la diffusion de documents scientifiques de niveau recherche, publiés ou non, émanant des établissements d'enseignement et de recherche français ou étrangers, des laboratoires publics ou privés.

# High repetition rate Yb:CaF<sub>2</sub> multipass amplifiers operating in the 100 mJ range

Dimitrios N. Papadopoulos, Florence Friebe, Alain Pellegrina, Marc Hanna, Patrice Camy, Jean-Louis Doualan, Richard Moncorgé, Patrick Georges and Frédéric Druon

**Abstract**— We present the research advances on the development of 50-200 mJ energy range diode-pumped Yb:CaF<sub>2</sub>-based multipass amplifiers operating at relatively high repetition rates. These laser amplifiers are based on diverse innovative geometries. All these innovations aim to design compact, stable and reliable amplifiers adapted to our application that consists in pumping ultrashort-pulse OPCPA (optical parametric chirped pulse amplifier) systems in the frame of the Apollon 10 PW laser project. The targeted repetition rate is in the range of 20-100 Hz with energies of few tens of mJ for the first stages up to 1 J for the final stage. An analysis of the specificities of Yb:CaF<sub>2</sub> is done to explain the different options we chose to fulfil these specifications. The critical points and limitations of the multipass Yb:CaF<sub>2</sub>-based amplifiers are subsequently discussed. To overcome the encountered problems, different issues are investigated such as crystal optimisation, laser head geometry, thermo-optical dynamics or coherent combining techniques. Experimental results for different multipass configurations are demonstrated and discussed.

**Index Terms**—Solid State lasers, Ultrafast lasers, Optical amplifiers, Power lasers, Ytterbium lasers.

## I. INTRODUCTION

DIODE-PUMPED SOLID STATE LASERS integrating Dytterbium-doped materials are, for almost two decades now, in the central preoccupations of the laser research community. This is particularly true for ultrafast technology. Among the ytterbium-doped materials, Yb:CaF<sub>2</sub> –which was re-discovered [1-3] ten years ago for laser applications [4-6]– has almost instantaneously attracted the attention of the laser community [4-16]. Indeed, this crystal has the main advantage of being very well-known (when undoped) with a well mastered crystal growth, even for large dimensions. Moreover, when Yb-doped, fluorite (CaF<sub>2</sub> or calcium fluoride), also

demonstrates interesting spectroscopic and thermal properties, in particular for the development of high-energy-class diode-pumped solid-state lasers (HEC DPSSL) producing short pulses [8,16-18]. Yb:CaF<sub>2</sub> is now seen as a very serious candidate for energetic diode-pumped laser chains; and several large scale facilities considered Yb:CaF<sub>2</sub> in their development of the next generation of PW-class laser. In the frame of the Apollon 10 PW project, the Yb:CaF<sub>2</sub> is studied with the purpose of developing pump sources for sub-10 fs OPCPA (optical parametric chirped pulse amplifiers). The goal is to develop novel amplifiers demonstrating 50-1000 mJ with repetition rates above 20 Hz, ideally up to 100 Hz. In this paper, we present original research on this thematic. Through a discussion on the crystal advantages and drawbacks, we justify our choices on laser head geometries and the different multipass configurations. This work takes into account the average-power and energy issues. From this point of view, thermal and damage threshold problems are discussed to establish the limitations of our systems. Precise measurements of thermal lens are detailed and integrated in the multipass geometry development. Different experiments are presented and an innovative technique based on passive coherent combining is demonstrated to overcome the damage problems.

## II. CRYSTAL PROPERTIES

Ytterbium-doped fluorites combine atypical spectral and thermal properties for an Yb-doped material due to the association of a simple crystalline structure and the clustering of the doping atoms, which explains its interest for DPSSL [7-40].

### A. Advantages

As every Yb-doped fluoride [41], Yb:CaF<sub>2</sub> exhibits a very broad and smooth emission band, which is exceptional for a well-structured cubic crystal. This is explained by the different valences between the dopant (Yb<sup>3+</sup>) and the substituted alkaline cations (Ca<sup>2+</sup>), which induces the creation of clusters during the doping process [42-45]. This clustering occurs already at the lowest doping levels but it really becomes preponderant for Yb-doping above 0.5-at. %. The organization of the Yb<sup>3+</sup> ions in these clusters leads to several kinds of luminescent and laser active centers but due to the proximity of the energy levels of these clusters and the coupling to the local phonon modes, the spectroscopy of the Yb<sup>3+</sup> ions resembles that of a glass leading to broad and relatively

Manuscript received April 1, 2014.

Florence Friebe, Marc Hanna, Patrick Georges and Frédéric Druon are with the Laboratoire Charles Fabry de l'Institut d'Optique, UMR 8501 CNRS, Université Paris Sud, 91127 Palaiseau, France (email: Frederic.druon@institutoptique.fr).

Dimitrios N. Papadopoulos and Alain Pellegrina are with the Laboratoire d'Utilisation des Lasers Intenses, Ecole Polytechnique, CNRS, CEA, UPMC, Route de Saclay, 91128 Palaiseau, France.

Patrice Camy, Jean-Louis Doualan, Richard Moncorgé, are with the Centre de Recherche sur les Ions, les Matériaux et la Photonique, CNRS, CEA, ENSI Caen, Université de Caen, France

smooth absorption and emission spectra. This is clearly an advantage for the production of ultrashort pulses; but also in chirped pulse amplification (CPA) systems where the spectral gain narrowing is also synonymous of shortening the chirped-pulse duration and consequently increasing the risks of damage.

A second advantage is related to the simple well-structured lattice of this crystal which allows to obtain interesting thermal properties due to its good capacity to propagate phonons [46-49]. This is particularly attractive for the development of high average power systems where efficient heat extraction is a key issue.

The third advantage concerns the long lifetime of Yb:CaF<sub>2</sub>, that is among the longest ones for an Yb-doped material with 2.4 ms. This last property makes Yb:CaF<sub>2</sub> very advantageous for diode-pumped high energy systems since it facilitates the storage of the energy even in low brightness pumping schemes.

### B. Drawbacks

The first difficulty that appears within the development of the high energy amplifiers based on Yb:CaF<sub>2</sub> is the relatively-high saturation fluence. With a saturation fluence of 80 J/cm<sup>2</sup> [8] the energy extraction from the Yb:CaF<sub>2</sub> is problematic and requires a large number of passes in a very low loss scheme.

The second drawback of Yb:CaF<sub>2</sub> is technological and still under investigation. It concerns the polishing issues. First, despite the isotropic optical nature of CaF<sub>2</sub>, the orientation of the polished facets is not trivial. For crystallographic considerations, the [111] orientation has to be selected to optimize the polishing quality. Moreover, the polishing quality also depends on the doping level. Indeed, at low doping (typically below 3 %), the polishing is relatively well mastered and leads to suitable surfaces with correct laser damage thresholds (LDT) for uncoated and coated configurations. For higher doping levels, this is not the case [40]; and this point clearly impacts the LDT and the accessibility to high fluences. The solution consisting in a tradeoff on the doping level: either favoring the gain (higher doping) or favoring the extraction efficiency (being able to work at high laser fluence). This tradeoff clearly depends on the system specifications.

Third, even if the thermal properties are relatively good for an Yb-doped material, some issues still have to be considered for high power applications. Since the fluorite is a soft material [50] (compared to oxides for example) the specificities of the laser crystal mounting and efficient interfacing with heat sinks are very critical in order to avoid excessive stresses. Indeed, it is demonstrated that stresses in fluorite induce birefringence effects [51] due to elastic anisotropy. This birefringence can induce deleterious losses in a polarized sensitive amplification process (as in Brewster oriented crystals). To minimize these losses, a first solution is the selection of the propagation vector along the [111] orientation of the crystal and the second is the optimization of the contacting: good heat transfer coefficient [52] with minimized strains. Moreover, these depolarization effects

appear to be even more consequent under cryogenic operation where strains could also appear due to differential dilatation between the crystal and its mount. Operating at low temperature is then technologically much more challenging than expected and very restricting. Adding the fact that the advantages in terms of thermal improvement are not so obvious for Yb-doped fluorite –compared to the case of Yb:YAG for example– since the thermal conductivity of Yb:CaF<sub>2</sub> does not evolved positively versus temperature decrease [12,16,24, 46-48], the cryogenic choice can be counterbalanced. A compromise in temperature has then to be found and operating slightly below room temperature may represent a complexity/improvement good tradeoff for the system.

### III. MULTIPASS AMPLIFIER GEOMETRY OPTIONS

As explained before, it is necessary to design amplifiers which allow very large number of passes to be able to counteract the low gain of Yb:CaF<sub>2</sub>. The solution presented in this article to overcome this problem consists in realizing low-loss geometrical multipass amplifiers with relay imaging between the passes. The principle is given in fig. 1. The unit cell simply consists in a finely adjusted 4-f scheme. All focusing optics are very low losses mirrors and the multipass is realized by angular multiplexing using folding mirrors and/or roof prisms. In our conditions, around 9-12 passes can generally be easily realized without significant losses using standard 2-inch circular mirrors.

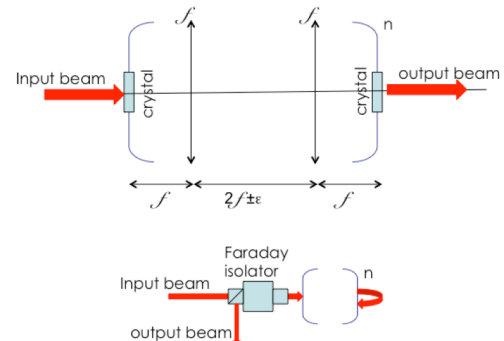

Fig. 1. Reimaging multipass amplifier principle with thermal lens compensation (top) and recycling principle (bottom).

To further increase the number of passes recycling techniques (fig. 1, 2) are used while double-laser head configurations (where two independent Yb:CaF<sub>2</sub> crystals are implemented in the same cavity, sharing the total thermal load) are examined towards high power configurations. Finally the implementation of typical multipass amplifiers in a Sagnac-like interferometer is investigated as an elegant way to increase the extractable energy from the amplifier and overcome LDT related limitations. The schematic representation of this idea is shown in figure 2, where the input and the output of a typical multipass amplifier are coupled resulting in a perfectly symmetric counter-propagating configuration with a single coherently combined output beam.

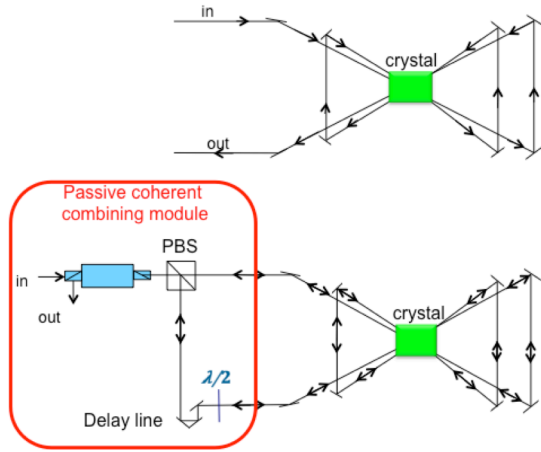

Fig. 2. Implementation of the passive coherent combining in a geometrical multipass amplifier based on a Sagnac interferometer. The use of a PBS (polarizer beam splitter) and a half-wave plate allows the use of a polarization-sensitive amplifier. The delay line has the role of avoiding temporal overlap of the two counter-propagating beams in the crystal.

For the first setups, the study focuses on the energy extraction while the thermal issues are put in a second place. In this point of view, the operating repetition rate is limited at 20 Hz. The crystal is used at Brewster angle in order to avoid, in a preliminary approach, the influence of the coatings. In this case, the crystal used is a 2.5%-doped 5-mm long Yb:CaF<sub>2</sub>.

In the case of the 100-Hz operation, an additional effort has to be made in order to address the thermal issues and to reduce the thermal loads. First, the pump can be distributed on two crystals absorbing a partial amount of the pump each. Second, the pump duty-cycle can be optimized to have a good tradeoff between thermal loads and stored energy. Third, there is a strong interest in using the crystals in an “active mirror” configuration: the crystals are HR-AR coated and the HR surface is contacted to a copper heat-sink to facilitate the heat extraction. The active mirror configuration allows a longitudinal heat transfer and is favorable for low thickness crystals. Taking into account these considerations, 2-mm-thick, 15-mm diameter crystals with a doping of 2.2 % are used for our experiments at 100 Hz. They are cut to have the optical polished plans equal to [111]. The crystal geometry choice is done to fulfill various requirements: mainly good LDT and absorption around 33%.

The thermal lens compensation is also crucial in our systems. Since we need to work close to the damage threshold, the beam size evolution has to be controlled. Generally this is possible over a wide range of operation conditions by the precise adjustment of the amplifier imaging configuration (given by the displacement  $\epsilon$  in fig. 1). In this study, special care has been given on the measurement of the thermal lens (see part VI) and its compensation. Different apparatuses are implemented in our experimental setups to allow for the safe operation of our amplifiers even when challenging the LDT limitations of our optics.

#### IV. NUMERICAL SIMULATION

In order to optimize the operating points of our amplifiers, numerical simulations are initially performed using the Frantz-

Nodvik model [53]. The effort is to obtain operation below the LDT but with sufficient energy extraction keeping the number of roundtrips on a reasonable level, typically in the range of 20. In all the simulations, the particular nature of the quasi-3-level character of Yb:CaF<sub>2</sub> –when pumped at 980 nm– is taken into account as well as the dynamical evolution of the gain under the various pump pulse duration and saturation level conditions.

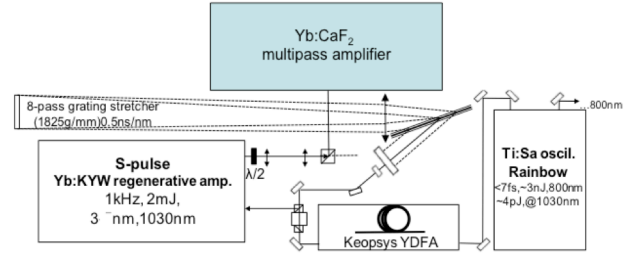

Fig. 3. Experimental setup for the generation of the input beam for the multipass amplifiers.

As input beam we consider hereafter the real input beam of our setup. The OPCPA-pump line of the Apollon 10PW project, is described in figure 3. The signal is generated by a leak at 1030 nm of an ultra-broad band Ti:Sa oscillator (Rainbow, Femtolasers) in order to have an optical synchronization between the signal and the pump in the OPCPA stage. The pulses from the oscillator are centered at 1030 nm with a bandwidth of  $>30$  nm. After amplification in an ytterbium doped fiber amplifier (YDFA) to increase their energy from 10 pJ to 4 nJ, the pulses are stretched in a grating stretcher with a ratio of 500 ps/nm. The stretched pulses are finally amplified in an Yb:KYW-based regenerative amplifier (Amplitude Systemes) delivering pulses with an energy of 2 mJ centered at 1030 nm with 3-nm FWHM bandwidth and repetition rate up to 1 kHz.

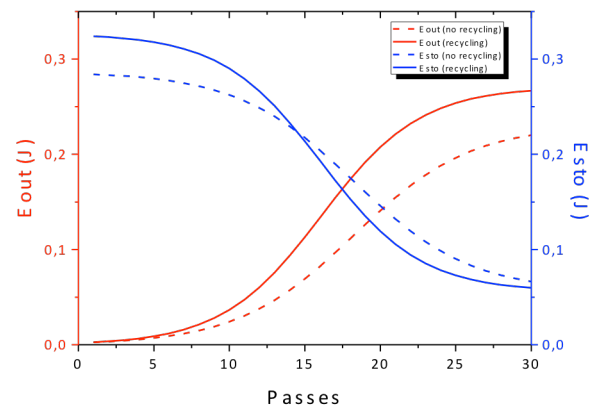

Fig. 4. Numerical simulations for a 2.5 % 5-mm-long Brewster-angle-cut crystal pumped with 1.2 J on a 1.5 mm diameter without (dashed lines) or with (solid lines) pump recycling.

The first simulations are performed for the 2.5%-doped 5-mm-long Brewster-oriented crystal. The pump is a fiber coupled diode (400  $\mu\text{m}$  core diameter) emitting up to 400 W peak power at 980 nm with an adjustable pulse duration up to 3 ms. The Brewster-angle of the crystal is taken into account

for the laser and the pump including the geometrical overlap and Fresnel losses for the unpolarized pump light (losses that in our case are around 6 %). The roundtrip overall losses for the signal have been taken equal to 2%. The input laser beam from the Yb:KYW regenerative amplifier is set to a diameter of 1.5 mm, leading to a 1.5 mm by 2.6 mm ellipse on the crystal surface and to a 1.5 mm by 2.1 mm ellipse profile inside the crystal. For this geometry and assuming a LDT limit for the uncoated crystal of 20 J/cm<sup>2</sup> (peak fluence), the maximum anticipated output energy is limited at ~300 mJ. The pump peak intensity is around 15 kW/cm<sup>2</sup> and the pump fluence around 15-50 J/cm<sup>2</sup> depending on the pump pulse duration.

We first consider the case of a single-pass of the pump beam. For 3 ms pulse duration the calculated absorbed pump power is 62% of the incident, the stored energy is 285 mJ and the corresponding small-signal single-pass gain is around 1.17. As shown in figure 4 (dashed lines), to sufficiently extract the stored energy would require >30 passes (roundtrips) which becomes impractical. When recycling of the pump is considered, the absorption rises to 78%, the stored energy is 325 mJ and the corresponding gain reaches a more comfortable value of 1.2. In figure 4 (solid lines) we can see that in this case we could reach more than 200 mJ for 20 passes remaining safely below the LDT limit. In such a configuration (for 25-26 passes) the energy extraction efficiency could theoretically reach 80% and the overall optical to optical efficiency >21%.

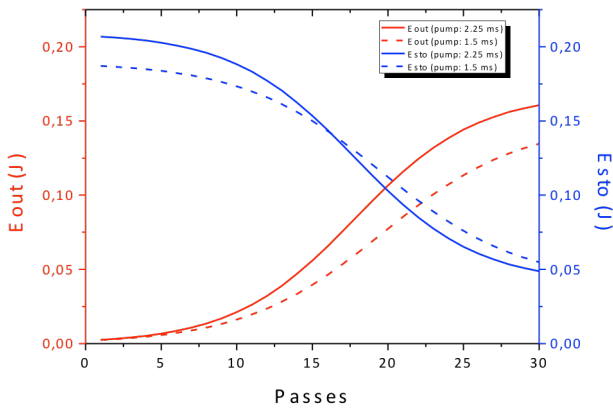

Fig. 5. Numerical simulations for two 2.2%-doped, 2-mm-long active-mirror crystals pumped with 0,9-J 2.25-ms pumping (solid lines) and 0,6-J, 1,5-ms pumping (dashed lines) both for a 1.5 mm diameter 2-mJ input signal beam.

The double head geometry has also been numerically simulated. For this configuration we consider the combination of two Yb:CaF<sub>2</sub> active mirrors in the same multipass cavity. For comparison we assume the use of exactly the same pump diode. This time however the pumping of the two crystals is sequential with the unabsorbed pump light from the first crystal imaged to the second one. The active mirror configuration results in pump recycling of the pump in both crystals. The input laser beam diameter is set again at 1.5 mm with 2 mJ energy. In this case (for the necessarily AR/HR coated crystals) we assume a LDT of 10 J/cm<sup>2</sup> (peak fluence),

limiting therefore the maximum anticipated output energy at ~100 mJ.

As already mentioned, the main goal of this amplification configuration is the power scaling. The choice of the crystals thickness is therefore principally made so that a balanced thermal load is obtained in the two crystals, globally optimizing their heat extraction capacity without any special care to maximize the overall stored energy. The principal goal is to reach an LTD limited operation with a reasonable number of passes in the amplifier and the minimum thermal load *i.e.* minimum pump pulse duration. Under this prism, we examine two pump pulse durations of 2.25 ms and 1.5 ms. In figure 5 we plot the stored and extracted energy evolution with the increasing number of passes in the amplifier for each case.

For 2.25 ms pulse duration the calculated absorbed pump power is ~65% of the incident, the stored energy is 207 mJ and the corresponding small-signal single-pass gain is around 1.35. As shown in figure 5 (solid lines), we already reach the LTD for 19-20 passes extracting about 48% of the stored energy and with an overall optical to optical efficiency of ~11%. For 1.5 ms pulse duration the calculated absorbed pump power is 70%, the stored energy is 188 mJ and the small-signal gain is around 1.32. As shown in figure 5 (dashed lines), we now reach the LTD for 22-23 passes extracting about 54% of the stored energy and with an overall optical to optical efficiency of ~17%.

## V. FIRST GENERATION AMPLIFIER

The first experimental set up was realized using a single 2.5%-doped 5-mm long Yb:CaF<sub>2</sub> crystal oriented at Brewster-angle. The setup of the multipass amplifier is described in figure 6.

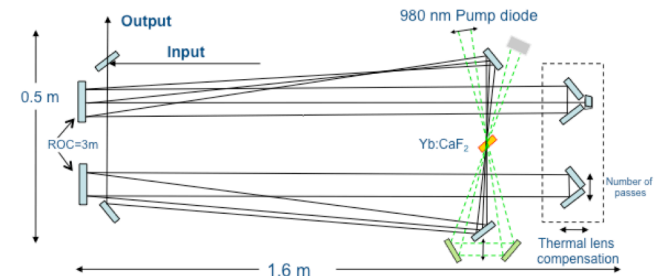

Fig. 6. Experimental setup using a 2.5% 5-mm-long Brewster-oriented crystal pumped with 1.2 J on a 1.5 mm diameter.

The laser input is up to 2 mJ with a beam diameter (at 1/e<sup>2</sup>) of 1.5 mm. The pump source is a fiber-coupled 400 W peak power diode emitting at 980 nm. The pump energy is 1.2 J per pulse. The pump beam is imaged to have a 1.5 mm diameter at the crystal position and is recycled, as shown in figure 6, to increase the absorption from ~60 % to 75 %.

Since the pump is not polarized, the Fresnel reflection losses are taken into account to calculate the absorption. Despite the fact, that the repetition rate is relatively low (between 10 and 30 Hz) the thermal issues have to be adequately addressed. The crystal is mounted in a copper mount that is Peltier-cooled down to 14 °C. The induced negative thermal lens is compensated with the help of two roof



mirrors that allow the quick adjustment of the cavity imaging and therefore the operation at nearly any pump power level in the repetition rate range studied.

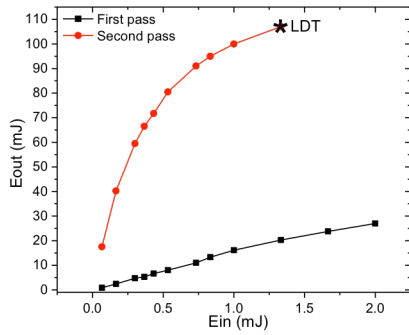

Fig. 7. Experimental output energy versus input energy for 9 passes and 18 passes. LDT represents the laser damage threshold limit where the surface of our sample is damaged.

The amplifier cavity allows the realization of a large number of passes. Under perfect thermal lens compensation (or no pump at all)  $>16$  roundtrips could be obtained without important diffraction losses or beam deformation. This task however becomes much more complicated under the presence of even some uncompensated thermal lens. We therefore decided to first align the cavity at only 9 roundtrips and then re-inject the output beam after correction of each divergence with the use of a single lens. Before recycling (9 passes), 27 mJ are obtained for 2 mJ input (black line at fig. 7). In this low number of passes, the amplifier is still far from the saturation with a net gain of about 14. This value conforms to the one evaluated by our code which predicts 28 mJ. After recycling (18 passes), the saturation starts to appear (fig. 7). According to our simulation for 1 mJ at the input of this amplifier we should already obtain 125 mJ while we only measure  $\sim 100$  mJ. This indication of saturation means that a part of the stored energy cannot be extracted. This is due to an imperfect overlap between the signal and the pump along all the crystal length which is obviously not perfectly treated in our initial calculations. However, the calculated values approach the experimental ones better with a correction of 7-8% for the part of the stored energy that is not geometrically overlapped with the signal. Moreover, the experimental maximum extractable energy was limited by the crystal surface damage for an injection of only 1.3 mJ. At this level we obtained few minutes stable operation up to 106 mJ before the crystal is eventually permanently damaged. Re-polishing and installation of the crystal resulted always in the same behavior and LDT limited operation. The real LDT in our setup is therefore only  $7 \text{ J/cm}^2$  instead of the assumed  $20 \text{ J/cm}^2$ . At maximum energy the gain is measured at 80 and the optical to optical efficiency around 9 %.

## VI. ON THE REPETITION RATE INCREASE

In order to increase the repetition rate a new setup, more adapted to higher power is realized. The pump absorption is divided on two independent crystals set in an active mirror configuration (fig. 8).

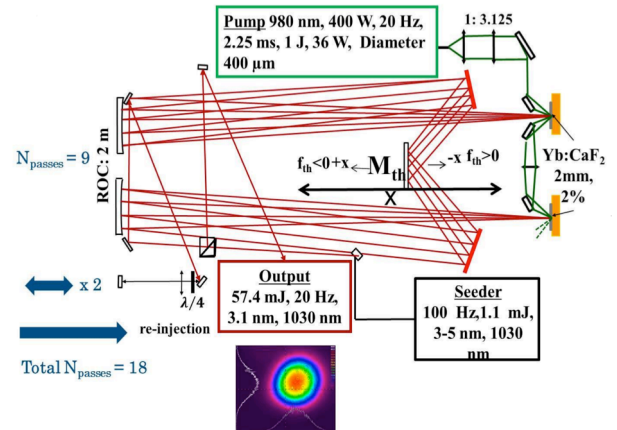

Fig. 8. Experimental setup of the re-imaging multipass amplifier with two Yb:CaF<sub>2</sub> active-mirrors.

In order to estimate the thermal lens in this new configuration, measurements [54-56] are done independently on the laser head. These measurements are performed at 20 Hz and 100 Hz and we have also included a dynamical study in the millisecond scale to investigate the influence of the QCW pumping. These results are presented in figure 9. One can clearly see that the thermal lens values vary around a mean value. The amplitude of the modulation is 8% peak-to-peak at 100 Hz and 80% peak to peak at 20 Hz. The exact thermal-lens value to correct corresponds to the end of the pumping (2.25 ms in the present case) where the stored energy is maximum. In general, this value does not correspond neither to the mean value neither to the maximum dioptric power of the lens. Indeed the maximum dioptric power is delayed in this 3-level-scheme laser as we can see in figure 9.

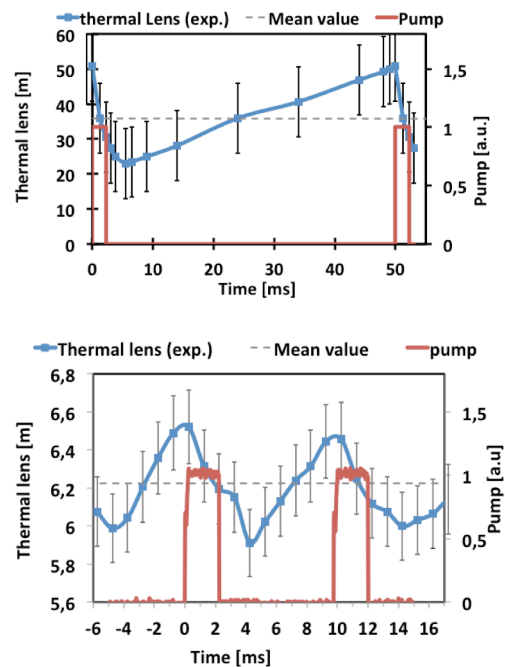

Fig. 9. Experimental measurements of the thermal lens at 20 Hz (top- and 100 Hz (bottom).

It is then interesting to measure precisely the thermal lens in order to control the beam propagation in the multipass amplifier. Another noticeable point concerns the sign of the thermal lens. It is positive despite the negative thermo-optic coefficient of the fluorite. The strong effect of the overall mechanical distortion clearly appears, which implies a strong influence of the global design. There is a mixing of thermal lens (negative lens), and thermal disc deformation (positive lens). This is due to the crystal geometry where the temperature evolution follows a transversal and longitudinal heat distribution over time. The equivalent thermo optic coefficient [56,57] –that also includes the geometrical influence such as mechanical arrangement– gives a positive value of  $\chi=2 \cdot 10^{-6} \text{ K}^{-1}$  instead of  $\chi=-17.8 \cdot 10^{-6} \text{ K}^{-1}$  for the later case of the Brewster crystal.

The exact values of thermal lens are considered in the multipass amplifier design. The cavity can be adjusted so that a nearly constant beam diameter is achieved for all passes for any position in the beam path. To better illustrate the necessity of a careful cavity adjustment against the thermal lens, we simulate in figure 10 the beam propagation (9 roundtrips are shown) inside a cavity similar to that shown in figure 8 assuming a thermal lens of  $f_{th}=10 \text{ m}$  for both crystals.

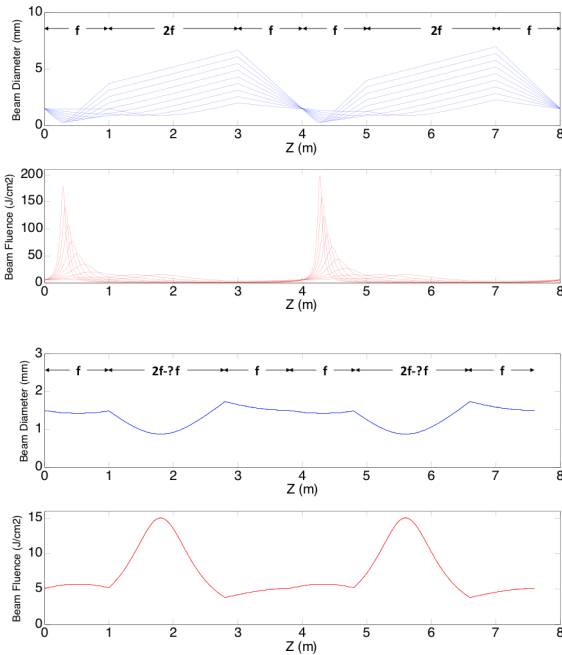

Fig. 10. Beam propagation simulation. Beam diameter evolution (blue curve) and intracavity fluence for 100 mJ pulses (red curve) without (upper part) and with (lower part) thermal lens compensation. In the second case all the curves are almost perfectly overlapped.

In fig. 10 (top) the imaging is adjusted at a perfect  $f$ - $2f$ - $f$  configuration. While the beam size on the crystals is maintained it greatly varies everywhere else. This variation could result either in large beam size on the optics and hard clipping of the beam or on very tightly focused points reaching 100s of  $\text{J}/\text{cm}^2$ . Both effects are highly unwanted and put in risk the operation of the amplifier. In fig. 10 (bottom) we have simply adjusted the position of mirror  $M_{th}$  (see fig. 8) and reduced the  $2f$  distance by about 10% ( $2f-e=1800 \text{ mm}$  for

$f=1000\text{mm}$  in this example). All passes are now almost perfectly overlapped everywhere in the cavity restricting the peak fluence below  $15 \text{ J}/\text{cm}^2$ .

In this configuration, we first performed an experiment at 20 Hz. For an input beam of 1.1 mJ we obtain 57.4 mJ in a 9+9 pass configuration, which means a total gain of 52 and a gain per pass of 1.245. Our simulation code predicts output energy of 60 mJ, very close to the experimental one. In the case of the active mirror configuration we can use the advantage of operating the amplifier with circular polarization and use, instead of an optical isolator a simple polarizer and a quarter-wave-plate to double the number of passes (fig. 1, fig. 8). The pointing stability is measured to be better than  $20 \mu\text{rad}$  (rms), demonstrating the advantage of the reimaging multipass configuration. As shown in figure 8, the beam profile is excellent and the measured  $M^2$  factor is 1.1.

At 100 Hz, the fluorescence becomes a critical issue. Indeed, a strong amount of non-extracted energy is dispersed into fluorescence. In our setup this fluorescence hits the mounts in close vicinity of the active medium. This creates, at high repetition rate, air turbulences and fluctuations in the laser beam. In order to avoid stability issues, the setup is modified, changing the optics positions and reducing the pumping duty cycle (1.5 ms pump) to decrease the deleterious heat dissipation on mounts.

In this modified setup 39 mJ pulse energy has been obtained at 100 Hz (our simulation predicts 40 mJ) with beam pointing stability close to the 20 Hz regime and an excellent beam profile similar to the 20 Hz regime. As shown in figure 11, the beam profile and the energy stability are excellent also at 100 Hz (<1% rms).

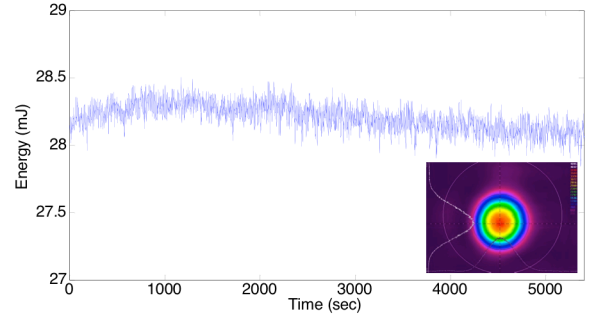

Fig. 11. Beam profile and stability of the double head multipass amplifier operating at 100 Hz. The input energy of the amplifier is adjusted for security reasons to fix the output at 28 mJ and the measurement is performed over 1  $\frac{1}{2}$  hours.

Such high repetition rate multipass amplifiers can be seen then as a compact, robust and simple module to boost commercial Yb-doped mJ laser chains sustaining a broad spectrum (compatible with sub-ps pulses) while keeping a good quality and stable laser beam.

## VII. BEYOND THE ENERGY LIMITATIONS

The laser damage threshold observed in part V clearly represents an important problem in the case of high saturation-fluence Yb-doped materials such as Yb:CaF<sub>2</sub>. Actually, the low gain forces to operate with high fluences closed to the

LDT to be able to extract efficiently the stored energy. Here we present for the first time to our best knowledge the application of the coherent beam combining technique to a Yb-doped bulk CPA broadband amplifier [58-63]. The presented technique has the advantage of being passive and easy to implement on any multipass geometry.

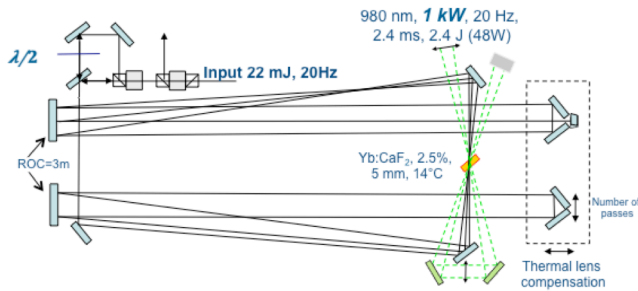

Fig. 12. Experimental setup of the amplifier using coherent combining.

The amplification cavity is almost identical to the one used in section V, where we have only modified the management of the input/output beam. In normal operation in such a cavity the input and the output beams are separated by a small lateral displacement. To perform the coherent combination both the input and the output ports of the initial amplifier are used inversely as output/input ports as well, as explained in fig. 2b.

The input beam is first directed through an optical isolator and then through a Faraday rotator and a PBS (oriented parallel to the output polarizer of the isolator). This way the input beam (linearly polarized at 45°) is split in two equal energy pulse replicas. A half wave plate is inserted in one arm to adjust the polarization for all circulating beams in the p-plane, imposed by the Brewster-oriented crystal. In order to separate in time the two counter-propagating pulses in the Sagnac interferometer and to avoid their temporal coincidence in the crystal, a delay line is inserted in one arm. In fig. 12 this delay is simply presented as a plane mirror pair (top left part) while in reality we had to install a 4f imaging configuration to add a sufficiently long delay (9 ns) preserving the symmetry between the two arms of the amplification scheme. In our CPA system, the pedestal-to-pedestal duration of the stretched input pulses is about 4-ns and therefore no overlap is possible. However, pulses with even twice the bandwidth (duration) could be still managed. The main benefit of using a Sagnac interferometer is that the counter-propagating beams automatically “see” the same optical path length in a practically static configuration. This is true since the total roundtrip time in the cavity is of the order of microsecond which corresponds in a characteristic frequency in the MHz range where no mechanical or thermal fluctuations can occur. The optical phases (linear and nonlinear) accumulated are exactly the same for the two paths and therefore the beams are automatically coherently combined. Due to the polarization rotation done by the half-wave-plate the coherently combined output polarization is the same as the input. Thus the output beam is reflected by the output polarizer of the optical isolator (indicated by the arrow in figure 12) while the uncombined part is rejected by the input polarizer of the isolator.

For our demonstration, the input beam is now provided by

a Yb:KYW booster amplifier [64] generating pulses at 20 Hz with 22 mJ of energy. To access output energies in the range of 200 mJ (even under the unfavorable conditions of imperfect pump/signal overlap) the pump peak-power has been increased to 1 kW. The diode used delivers 2.4-ms, 2.4-J pulses on a QCW regime at 20 Hz.

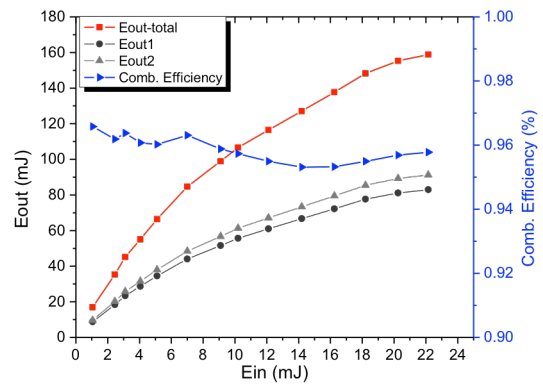

Fig. 13. Performance of the coherent combining of a high energy multipass amplifier. A total energy of 160 mJ is obtained at maximum with 96% of efficiency in the beam combining process.

The energy versus the injection energy is plotted in figure 13. At maximum input energy (22 mJ) each pulse in each arm of the Sagnac interferometer is amplified from 11 mJ to 80-90 mJ. After recombination, 160 mJ are obtained in the single output beam. The energy at the uncombined output port is only 6.4 mJ which leads to a combination efficiency of 96%. The optical-to-optical efficiency is 6.5%. No depolarization losses have been observed during amplification. Nevertheless, the amplifier still suffers from early saturation (compared to our simulation) as a result of non-optimized pump signal overlap. An improvement of this aspect (use of high LDT dichroics for the pump signal multiplexing) could theoretically allow its energy scaling around 220 mJ before damaging of the crystal. In this case, the efficiency reaches the 11%.

The beam profiles are represented in figure 14. The two counter-propagating beams have been measured independently (blocking each time the other arm) and shown on the left side of the figure. Both beams are high quality. Still, however, their distribution is not exactly the same which is in fact the main reason for the 4% rejected in the uncombined port. In the right side we present the total beam profile as a function of the energy. The combined beam represents an average of the two beams with then an overall good quality as well.

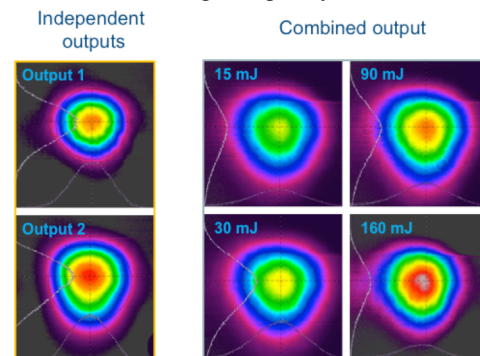

Fig. 14. Beam profiles of the two counter-propagating beams measured independently (left). Beam profiles of the beam after combining for different output energy (right).



The stability of this very long (>130 m) interferometer is measured. The energy variation is less than 1% rms over few minutes operation, and the beam pointing stability less than 50  $\mu$ rad. This validates the lack of sensibility of this passive coherent combining technique that can demonstrate a great potential for any kind of energy-limited systems. Over long periods of operation the system presents some drift tendency necessitating the regular optimization of the cavity. However, this is not related to the coherent combining process but on the mechanical design since the same drifts are observed with only one arm. We strongly believe that the optimization of the optomechanical design would result in a highly reliable device.

### VIII. FEW WORDS ON THE SPECTRUM

The last question we address concerns the spectral impact of the amplification process. In our setup the input beam is coming from a Yb:KYW amplifier (fig. 3) and the bandwidth is typically 3 nm. Gain narrowing is clearly not a problem for our multipass amplifiers and the output spectrum is generally expected to be the same as the input one as shown in figure 15 for the case of the amplifier presented in section VII. The output pulses have almost identical spectrum centered at 1030 nm with a bandwidth of  $\sim$ 3.1 nm. Previous works indicate [18, 24, 26] that the typical value for which the spectral issue begins to be important in Yb:CaF<sub>2</sub> amplifiers is typically 10 nm, explaining the absence of effect in our case.

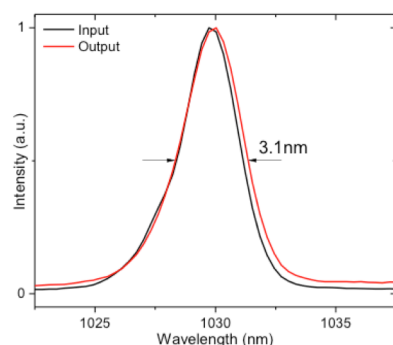

Fig. 15. Spectra before and after amplification demonstrating the absence of gain narrowing (corresponding FLT of <500 fs).

In our setup, where the goal is not to compress the pulse to its FTL duration, the main advantage of this spectrum preservation concerns the absence of duration shortening of the stretched pulses during amplification. This good control of the stretched pulse duration allows a better management of the peak power and consequently of the laser damage threshold. Another interesting possibility of this gain-narrowing free operation in the range of few nanometers, is the possibility to tailor the temporal pulse shape of the amplified pulses in the nanosecond regime privileging specific temporal pulse shape which could be used to optimize nonlinear conversion process such as SHG and OPCPA.

The spectrum of the amplified pulses leads to Fourier-transform pulse of <500 fs. The typical pulse duration measured by autocorrelation is 560 fs for our multipass amplifiers. This leads to a time-bandwidth product of 0.5.

### IX. CONCLUSION

In this paper, multipass amplifiers based on Yb:CaF<sub>2</sub> technology are presented. These amplifiers operate in the 20-100 Hz repetition-rate range, for energies of few tens of mJ. At 20 Hz we obtained up to 160 mJ using the coherent combining technique. And to reach higher repetition rates active mirror configuration has been experimented demonstrating up to 57 mJ at 20 Hz and 39 mJ at 100 Hz. This work represents the highest energies ever obtained for multi-tens-Hz Yb:CaF<sub>2</sub> laser systems. To realize these amplifiers several original studies are discussed concerning the geometries adapted to average power and/or energy. Energy extraction avoiding the damaging of the crystals is numerically and experimentally demonstrated. An original study of the dynamics issues imposed by the QCW pumping at the millisecond scale is also presented. The coherent combining for a multipass amplifier based on Yb-doped crystal is also shown for the first time, to our best knowledge, demonstrating the advantage of this technique for high energy amplifiers. The goal of this work is to realize innovative Yb-doped based lasers for pumping high-energy OPCPA systems in the frame of the Apollon 10 PW project. In a more general point of view, the work on high repetition rate Yb:CaF<sub>2</sub> multipass amplifiers operating in the 100 mJ range can be seen also as a first step and a preliminary study for the joule-range DPSSL femtosecond systems operating at high repetition rate.

### ACKNOWLEDGMENT

This work has been partially supported by the French National Research Agency (ANR 2010 BLAN 0421 02) through the Femtocryble program and by the ILE 07-CPER 017-01 contract.

### REFERENCES

- [1] W.J. Humphreys, "On the Presence of Yttrium and Ytterbium in Fluor-Spar", *Astrophysical Journal*, **20**, 266-273 (1904)
- [2] P. P. Sorokin and M. J. Stevenson "Stimulated infrared emission from trivalent uranium", *Phys. Rev. Lett.* **12** (5) 557-559 (1960),
- [3] S.E. Hatch, W.F. Parsons and R.J. Weagley, "Hot-pressed polycrystalline CaF<sub>2</sub>:Dy<sup>2+</sup> laser" *Appl. Phys. Lett.* **5**, 153 (1964)
- [4] V. Petit, J. L. Doualan, P. Camy, V. Menard, and R. Moncorgé, "CW and tunable laser operation of Yb<sup>3+</sup> doped CaF<sub>2</sub>," *Appl. Phys. B* **78**, 681-684 (2004).
- [5] A. Lucca, M. Jacquemet, F. Druon, F. Balembois, P. Georges, P. Camy, J.L. Doualan and R. Moncorgé, "High power tunable diode-pumped Yb<sup>3+</sup>:CaF<sub>2</sub> laser," *Opt. Lett.* **29** 1879-1881 (2004)
- [6] A. Lucca, G. Debourg, M. Jacquemet, F. Druon, F. Balembois, P. Georges P. Camy, J.L. Doualan and R. Moncorgé, "High-power diode-pumped Yb<sup>3+</sup>:CaF<sub>2</sub> femtosecond laser," *Opt. Lett.* **29**, 2767-2769 (2004)
- [7] F. Druon, F. Balembois and P. Georges, "New laser crystals for the generation of ultrashort pulses", Article invité, *Compte Rendu de l'Académie des Sciences, Recent advances in crystal optics*, C.R. Physique **8** 153-164 (2007)
- [8] M. Siebold, S. Bock, U. Schramm, B. Xu, J. L. Doualan, P. Camy, and R. Moncorgé, "Yb:CaF<sub>2</sub> — a new old laser crystal," *Appl. Phys. B* **97**(2), 327-338 (2009).
- [9] T. Toepfer, J. Neukum, J. Hein, and M. Siebold "Very-large-scale DPSS lasers are coming", *Laser Focus World* **46**(10), 64-67 (2010)
- [10] R. Moncorgé, P. Camy, J. L. Doualan, A. Braud, J. Margerie, L. P. Ramirez, A. Jullien, S. Ricaud, F. Druon, D. N. Papadopoulos, P. Georges, "Pure and Yb<sup>3+</sup> doped fluorites (Ca, Sr, Ba)F<sub>2</sub>: A renewal for the future high intensity laser chains" *Journal of Luminescence*, 2013, 133, pp. 276-28 (2013)

- [11] J.L. Doualan, P. Camy, A. Benayad, V. Ménard, R. Moncorgé, J. Boudeile, F. Druon, F. Balembos and P. Georges, "Yb<sup>3+</sup>-Doped (Ca,Sr,Ba)F<sub>2</sub> for High Power Laser Applications," *Laser Physics* **20**(2), 533-536 (2010).
- [12] F. Druon, S. Ricaud, D. N. Papadopoulos, A. Pellegrina, P. Camy, J. L. Doualan, R. Moncorgé, A. Courjaud, E. Mottay, and P. Georges, "On Yb:CaF<sub>2</sub> and Yb:SrF<sub>2</sub>: review of spectroscopic and thermal properties and their impact on femtosecond and high power laser performance [Invited]," *Opt. Mater. Express* **1**, 489-502 (2011)
- [13] F. Druon, F. Balembos, P. Georges "New Materials for Short-Pulse Amplifiers" Invited paper in IEEE PHOTONICS JOURNAL Volume: 3 Issue: 2 Pages: 268-273 (2011)
- [14] T. T. Basiev, M. E. Doroshenko, P. P. Fedorov, V. A. Konyushkin, S. V. Kuznetsov, V. V. Osiko, and M. Sh. Akchurin, "Efficient laser based on CaF<sub>2</sub>-SrF<sub>2</sub>-YbF<sub>3</sub> nanoceramics," *Opt. Lett.* **33**, 521523 (2008).
- [15] P. Aubry, A. Bensalah, P. Gredin, G. Patriarche, D. Vivien, and M. Mortier, "Synthesis and optical characterizations of Yb-doped CaF<sub>2</sub> ceramics," *Opt. Mater.*, **31**, 750-753 (2009)
- [16] A. Pugžlys, G. Andriukaitis, D. Sidorov, A. Irshad, A. Baltuška, W. J. Lai, P.B. Phua, L. Su, J. Xu, H. Li, R. Li, S. Ališauskas, A. Marcinkevicius, M. E. Fermann, L. Giniunas and R. Danielius "Spectroscopy and lasing of cryogenically cooled Yb,Na:CaF<sub>2</sub>," *Appl. Phys. B*. **97**(2), 339-350 (2009)
- [17] M. Siebold, J. Hein, M. Hornung, S. Podleska, M.C. Kaluza, S. Bock, and R. Sauerbrey, "Diode-pumped lasers for ultra-high peak power," *Appl. Phys. B* **90**, 431-437 (2008).
- [18] M. Siebold, M. Hornung, R. Boedefeld, S. Podleska, S. Klingebiel, C. Wandt, F. Krausz, S. Karsch, R. Uecker, A. Jochmann, J. Hein and M. C. Kaluza, "Terawatt diode-pumped Yb:CaF<sub>2</sub> laser," *Opt. Lett.* **33**, 2770-2772 (2008)
- [19] J.-C. Chanteloup, D. Albach, A. Lucianetti, K. Ertel, S. Banerjee, P. D. Mason, C. Hernandez-Gomez, J. L. Collier, J. Hein, M. Wolf, J. Körner, B. J. Le Garrec "Multi kJ level Laser Concepts for HiPER Facility", *Journal of Physics: Conference Series* **244** (2010) 012010
- [20] Alexander Kessler, Marco Hornung, Sebastian Keppler, Frank Schorcht, Marco Hellwing, Hartmut Liebetrau, Jörg Körner, Alexander Sävert, Matthias Siebold, Matthias Schnepp, Joachim Hein, and Malte Kaluza, « 16.6 J chirped femtosecond laser pulses from a diode pumped Yb:CaF<sub>2</sub> amplifier », *Opt. Lett.* (2014)
- [21] M. Siebold, J. Hein, M. C. Kaluza, and R. Uecker, "High-peak-power tunable laser operation of Yb:SrF<sub>2</sub>," *Opt. Lett.* **32**, 1818-1020 (2007).
- [22] M. Siebold, M. Hornung, S. Bock, J. Hein, M.C. Kaluza, J. Wemans and R. Uecker "Broad-band regenerative laser amplification in ytterbium-doped calcium fluoride (Yb:CaF<sub>2</sub>) " *Appl. Phys. B* **89**(4), 543-547 (2007)
- [23] F. Friebe, F. Druon, J. Boudeile, D. N. Papadopoulos, M. Hanna, P. Georges, P. Camy, J. L. Doualan, A. Benayad, R. Moncorgé, C. Cassagne, and G. Boudebs, "Diode-pumped 99 fs Yb:CaF<sub>2</sub> oscillator," *Opt. Lett.* **34**, 1474-1476 (2009)
- [24] A. Pugžlys, G. Andriukaitis, A. Baltuška, L. Su, J. Xu, H. Li, R. Li, W. J. Lai, P. B. Phua, A. Marcinkevicius, M. E. Fermann, L. Giniūnas, R. Danielius, and S. Ališauskas, "Multi-mJ, 200-fs, cw-pumped, cryogenically cooled, Yb,Na:CaF<sub>2</sub> amplifier," *Opt. Lett.* **34**, 2075-2077 (2009)
- [25] F. Druon, D. N. Papadopoulos, J. Boudeile, M. Hanna, P. Georges, A. Benayad, P. Camy, J. L. Doualan, V. Ménard, and R. Moncorgé, "Mode-locked operation of a diode-pumped femtosecond Yb:SrF<sub>2</sub> laser," *Opt. Lett.* **34**, 2354-2356 (2009)
- [26] S. Ricaud, F. Druon, D. N. Papadopoulos, P. Camy, J.L. Doualan, R. Moncorgé, M. Delaigue, Y. Zaouter, A. Courjaud, P. Georges, and E. Mottay, "Short-pulse and high-repetition-rate diode-pumped Yb:CaF<sub>2</sub> regenerative amplifier," *Opt. Lett.* **35**, 2415-2417 (2010)
- [27] S. Ricaud, D. N. Papadopoulos, P. Camy, J. L. Doualan, R. Moncorgé, A. Courjaud, E. Mottay, P. Georges, and F. Druon, "Highly efficient, high-power, broadly tunable, cryogenically cooled and diode-pumped Yb:CaF<sub>2</sub>," *Opt. Lett.* **35**, 3757-3759 (2010)
- [28] D. Kartashov, G. Andriukaitis, D. Lorenc, A. Pugžlys, A. Baltuska, L. Giniunas, R. Danielius, and J. Limpert, "Pulse Compression of 6mJ, 200-fs Pulses From a cw-Diode-Pumped Single-Stage Yb:CaF<sub>2</sub> MOPA in Hollow-Core Fiber," in *Advances in Optical Materials*, OSA Technical Digest (CD) (Optical Society of America, 2011), paper HWA5
- [29] S. Ricaud, D. N. Papadopoulos, A. Pellegrina, F. Balembos, P. Georges, A. Courjaud, P. Camy, J. L. Doualan, R. Moncorgé, and F. Druon, "High-power diode-pumped cryogenically cooled Yb:CaF<sub>2</sub> laser with extremely low quantum defect," *Opt. Lett.* **36**, 1602-1604 (2011)
- [30] Andréas Lyberis, Adam J. Stevenson, Akiko Suganuma, Sandrine Ricaud, Frédéric Druon, Frédéric Herbst, Daniel Vivien, Patrick Gredin, Michel Mortier " Effect of Yb<sup>3+</sup> concentration on optical properties of Yb:CaF<sub>2</sub> transparent ceramics," *Optical Material Volume*, **6**, 965-968 (2012)
- [31] G. Andriukaitis, D. Kartashov, D. Lorenc, A. Pugžlys, A. Baltuška, L. Giniūnas, R. Danielius, J. Limpert, T. Clausnitzer, E.-B. Kley, A. Voronin, and A. Zheltikov, "Hollow-fiber compression of 6 mJ pulses from a continuous-wave diode-pumped single-stage Yb,Na:CaF<sub>2</sub> chirped pulse amplifier," *Opt. Lett.* **36**, 1914-1916 (2011)
- [32] G. Andriukaitis, S. Alisaukas, A. Pugžlys, A. Baltuska, L. Tan, H. J. Lim, P. B. Phua, K. Balskus, and A. Michailovas, "Broadband 6 μm OPA Driven by Yb:CaF<sub>2</sub> DPSSL System," in *Conference on Lasers and Electro-Optics 2012*, OSA Technical Digest (online) (Optical Society of America, 2012), paper CF3B.6.
- [33] G. Andriukaitis, T. Balciunas, L. Zhu, T. Flöry, A. Verhoef, A. Fernandez, A. Pugžlys, A. Baltuska, M. Grishin, and A. Michailovas, "Suppression of Population-Lifetime-Determined Energy Instability in a Femtosecond kHz Yb CPA," in *Conference on Lasers and Electro-Optics 2012*, OSA Technical Digest (online) (Optical Society of America, 2012), paper CM1D.5.
- [34] S. Ricaud, P. Georges, P. Camy, J.-L. Doualan, R. Moncorgé, A. Courjaud, E. Mottay, F. Druon, "Diode-pumped regenerative Yb:SrF<sub>2</sub> amplifier", *Applied Physics B*, Vol. 106, Iss. 4, p. 823 (2012).
- [35] Jörg Körner, Joachim Hein, Hartmut Liebetrau, Reinhard Seifert, Diethard Klöpffel, Martin Kahle, Markus Loeser, Mathias Siebold, Ulrich Schramm, and Malte C. Kaluza, "Efficient burst mode amplifier for ultra-short pulses based on cryogenically cooled Yb<sup>3+</sup>:CaF<sub>2</sub>," *Opt. Express* **21**, 29006-29012 (2013)
- [36] P. Sevillano, G. Machinet, R. Dubrasquet, P. Camy, J.L. Doualan, R. Moncorgé, P. Georges, F.P. Druon, D. Descamps, and E. Cormier, "Sub-50 fs, Kerr-lens Mode-locked Yb:CaF<sub>2</sub> Laser Oscillator Delivering up to 2.7 W," OSA Advanced Solid State Lasers Conference, oral paper AF3A.6 (2013).
- [37] G. Machinet, P. Sevillano, F. Guichard, R. Dubrasquet, P. Camy, J.-L. Doualan, R. Moncorgé, P. Georges, F. Druon, D. Descamps, and E. Cormier, "High-brightness fiber laser-pumped 68 fs–2.3 W Kerr-lens mode-locked Yb:CaF<sub>2</sub> oscillator," *Opt. Lett.* **38**, 4008-4010 (2013).
- [38] G. Machinet, G. Andriukaitis, P. Sévillano, J. Lhermite, D. Descamps, A. Pugžlys, A. Baltuška, and E. Cormier, "High-gain amplification in Yb:CaF<sub>2</sub> crystals pumped by a high-brightness Yb-doped 976 nm fiber laser" *Appl. Phys. B* **111**, 495 (2013).
- [39] João, C.P.; Wemans, J.; Figueira, G. Numerical Simulation of High-Energy, Ytterbium-Doped Amplifier Tunability. *Appl. Sci.* **2013**, *3*, 288-298.
- [40] Katrin Sarah Wentsch, Birgit Weichelt, Stefan Günster, Frederic Druon, Patrick Georges, Marwan Abdou Ahmed, and Thomas Graf, "Yb:CaF<sub>2</sub> thin-disk laser," *Opt. Express* **22**, 1524-1532 (2014)
- [41] P. Camy, J. L. Doualan, A. Benayad, M. von Edlinger, V. Ménard, and R. Moncorgé, "Comparative spectroscopic and laser properties of Yb<sup>3+</sup>-doped CaF<sub>2</sub>, SrF<sub>2</sub> and BaF<sub>2</sub> single crystals," *Appl. Phys. B* **89**, 539-542 (2007)
- [42] C. R. A. Catlow, A. V. Chadwick, G. N. Greaves, and L. M. Moroney, "Direct observations of the dopant environment in fluorites using EXAFS," *Nature* **312**, 601-604 (1984).
- [43] M.L. Falin, K.I. Gerasimov, V.A. Latypov, A.M. Leushin, H. Bill and D. Lovy, "EPR and optical spectroscopy of Yb<sup>3+</sup> ions in CaF<sub>2</sub>: an analysis of the structure of tetragonal centers" *J. Lumin.* **269**, 102-103 (2003)
- [44] M. Ito, C. Goutaudier, Y. Guyot, K. Lebbou, T. Fukuda and G. Boulon, « Crystal growth, Yb spectroscopy, concentration quenching analysis and potentiality of laser emission in Ca<sub>1-x</sub>Yb<sub>x</sub>F<sub>2+x</sub> » *J. Phys. Cond. Mat.* **16**, 1501-1521 (2004)
- [45] V. Petit, P. Camy, J.-L. Doualan, X. Portier and R. Moncorgé "Spectroscopy of Yb<sup>3+</sup>:CaF<sub>2</sub>: From isolated centers to clusters" *Phys. Rev. B* **78** (8), 085131 (2008)
- [46] P. Popov, K. V. Dukel'skii, I. A. Mironov, A.N. Smirnov, P.L. Smolyanskii, P.P. Fedorov, V. Osiko, T. Basiev "Thermal Conductivity of CaF<sub>2</sub> Optical Ceramic" *Doklady Physics* vol. 412, 2, 185-187 (2007)
- [47] J. Boudeile, J. Didierjean, P. Camy, J. L. Doualan, A. Benayad, V. Ménard, R. Moncorgé, F. Druon, F. Balembos, and P. Georges, "Thermal behaviour of ytterbium-doped fluorite crystals under high power pumping," *Opt. Express* **16**, 10098-10109 (2008)

- [48] P. Popov, P. Fedorov, S. Kuznetsov, V. Konyushkin, V. Osiko and T. Basiev "thermal conductivity of single crystals of Ca<sub>1-x</sub>Yb<sub>x</sub>F<sub>2+x</sub> solid solution" *Doklady Physics* vol. 53, 4, 198-200 (2008)
- [49] Joerg Koerner, Christian Vorholt, Hartmut Liebetrau, Martin Kahle, Diethard Kloepfel, Reinhard Seifert, Joachim Hein, and Malte C. Kaluza, "Measurement of temperature-dependent absorption and emission spectra of Yb:YAG, Yb:LuAG, and Yb:CaF<sub>2</sub> between 20 °C and 200 °C and predictions on their influence on laser performance," *J. Opt. Soc. Am. B* 29, 2493-2502 (2012)
- [50] J. L. Ladison, J. J. Price, J.D. Helfinstine and W. R. Rosch, "Hardness, elastic modulus, and fracture toughness bulk properties in Corning calcium fluoride" *Proc. SPIE* 5754, 1329 (2005)
- [51] Ilya Snetkov, Anton Vyatkin, Oleg Palashov, and Efim Khazanov, "Drastic reduction of thermally induced depolarization in CaF<sub>2</sub> crystals with [111] orientation," *Opt. Express* 20, 13357-13367 (2012)
- [52] S. Chénais, S. Forget, F. Druon, F. Balembois and P. Georges, "Direct and absolute temperature mapping and heat transfer measurements in diode-end-pumped Yb:YAG," *Applied Physics B: Lasers and Optics* Volume 79, 221 - 224 (2004).
- [53] L M Frantz, J S Nodvik, "Theory of pulse propagation in a laser amplifier" *J Appl Phys.* 34, 2346 (1963)
- [54] S. Chénais, F. Balembois, F. Druon, G. Lucas-Leclin and P. Georges, "Thermal Lensing in Diode-Pumped Ytterbium Lasers - Part I: Theoretical analysis and wavefront measurements" *IEEE J. Quantum Electronics* Vol. 40 No 9 September, 1217-1234, 2004
- [55] S. Chénais, F. Balembois, F. Druon, G. Lucas-Leclin and P. Georges, "Thermal Lensing in Diode-Pumped Ytterbium Lasers - Part II: evaluation of quantum efficiencies and thermo-optic coefficients." *IEEE J. Quantum Electronics* Vol. 40 No 9 September, 1235-1243, 2004
- [56] S. Chénais, F. Druon, S. Forget, F. Balembois and P. Georges, "On thermal effects in solid-state lasers: the case of ytterbium-doped materials", invited paper in *Progress in Quantum Electronics* 30 89-153 (2006)
- [57] P. A. Loiko, K. V. Yumashev, V. N. Matrosov, and N. V. Kuleshov, "Dispersion and anisotropy of thermo-optic coefficients in tetragonal GdVO<sub>4</sub> and YVO<sub>4</sub> laser host crystals," *Applied Optics* 52, 698 (2013).
- [58] S. Roither, A. J. Verhoef, O. D. Mücke, G. A. Reider, A. Pugžlys, and A. Baltuška, "Sagnac interferometric multipass loop amplifier," *Opt. Express* 20, 25121-25129 (2012)
- [59] M. Hanna, L. Daniault, D.N. Papadopoulos, Y. Zaouter, F. Druon, P. Georges in "Coherent Laser Beam Combining" Wiley, A Brignon editor 277 (2013)
- [60] Louis Daniault, Marc Hanna, Dimitris N. Papadopoulos, Yoann Zaouter, Eric Mottay, Frédéric Druon, and Patrick Georges, "Passive coherent beam combining of two femtosecond fiber chirped-pulse amplifiers," *Opt. Lett.* 36, 4023-4025 (2011)
- [61] Y. Zaouter, L. Daniault, M. Hanna, D. N. Papadopoulos, F. Morin, C. Hönninger, F. Druon, E. Mottay, and P. Georges, "Passive coherent combination of two ultrafast rod type fiber chirped pulse amplifiers," *Opt. Lett.* 37, 1460-1462 (2012)
- [62] L. Daniault, M. Hanna, D. N. Papadopoulos, Y. Zaouter, E. Mottay, F. Druon, and P. Georges, "High peak-power stretcher-free femtosecond fiber amplifier using passive spatio-temporal coherent combining," *Opt. Express* 20, 21627-21634 (2012)
- [63] Florent Guichard, Yoann Zaouter, Marc Hanna, Franck Morin, Clemens Hönninger, Eric Mottay, Frédéric Druon, and Patrick Georges, "Energy scaling of a nonlinear compression setup using passive coherent combining," *Opt. Lett.* 38, 4437-4440 (2013)
- [64] D. N. Papadopoulos, A. Pellegrina, L. P. Ramirez, P. Georges, and F. Druon, "Broadband high-energy diode-pumped Yb:KYW multipass amplifier," *Opt. Lett.* 36, 3816-3818 (2011).



**Dimitrios N. Papadopoulos** was born in Athens, Greece, on October 29, 1975. He received his diploma in electrical and computer engineering in 1998, the Master's degree in physics, and the Ph.D. degree in laser physics in 2005 from the National Technical University of Athens (NTUA), Athens. From 2007 to 2009, he worked as a Postdoctoral Researcher at the Laboratoire Charles Fabry de l'Institut d'Optique, Palaiseau, France on ultrafast laser oscillators and high-power femtosecond fiber amplifiers. Since 2009, he works as research

engineer for the Apollon 10P project (LULI/Ecole Polytechnique, Palaiseau, France). His current research interests include the generation of few cycle pulses, OPCA techniques, high energy diode pumped systems and Ti:Sapphire amplifiers.



**Florence Friebe** was born in Brig, Valais Switzerland.

She studied "Photonic" course at the Hochschule Emden-Leer in Germany until 2008 and continued to Master course "Engineering Physics" with a focus on Optics at the Carl von Ossietzky Universität until 2011. Since she is PhD student in the Laser group at Laboratoire Charles Fabry, Institut d'Optique in France.



**Marc Hanna** was born in Beirut, Lebanon, in 1974. He received the engineering degree from the Institut National des Télécommunications, Evry, France, in 1996, and the Ph.D. degree in electrical engineering from the Université de Franche Comté, Besançon, France, in 2000.

From 2001 to 2006, he was a research scientist in the Optics Department, Franche-Comté Electronique, Mécanique, Thermique et Optique—Sciences et Technologies (FEMTO-ST), Besançon, where he focused on ultrafast optics applied to telecommunications. He is currently with the Laboratoire Charles Fabry de l'Institut d'Optique, Centre National de la Recherche Scientifique (CNRS), Université Paris Sud, Palaiseau, France. His research interests include ultrafast and nonlinear optics, fiber lasers and amplifiers, and coherent addition of ultrafast optical fields.



**Patrick Georges** was born in Metz, France, on September 13,

1962. He received the engineer degree from the Ecole Supérieure d'Optique, Palaiseau, France, in 1985, and the Ph.D. degree from the Institut d'Optique, Orsay, France, in 1989, for work on colliding pulses mode-locked dye lasers at different wavelengths and pulse compression.

He is currently a Senior Scientist at the Centre National de la Recherche Scientifique (CNRS), where he leads the Lasers Group, Laboratoire Charles Fabry at the Institut d'Optique, Palaiseau. His current research interests include diode-pumped solid-state lasers, new laser materials, picosecond and femtosecond lasers, high brightness laser diodes, fiber amplifier systems and optically pumped vertical surface emitting lasers. He is also engaged in the Apollon 10 PW laser facility project and responsible of the Front-end.

Dr. Georges is a Fellow Member of the Optical Society and has served as Program Chair for the Cleo Europe 2013 conference.



**Frédéric P. H. J. Druon** was born in Aubervilliers, France, in 1972. He received in 1996, the engineer degree from the Electrical Engineering School (Supélec), Gif-sur-Yvette, France, and conjointly the Diploma of Etude Supérieure in Optics and Photonics, Orsay France. In 2000, he received the Ph.D. degree from the Université Paris Sud, Orsay, France for work, at the Laboratoire Charles Fabry of the Institut d'Optique, on ultracompact and efficient picosecond UV sources based on microchip lasers and on femtosecond diode-pumped laser systems.

He studied optics and photonics at the University of Paris XI. In 1997, he made his military service as a Research Visitor at the Center for Ultrafast Optical Science (CUOS), Ann Arbor, MI, where he worked on wave-front analysis and correction of terawatt laser chains. He was a Postdoctoral Researcher for one year and worked on mode-locking processes involving fast saturable absorbers. In 2001, he joined the Laboratoire Charles Fabry de l'Institut d'Optique, Centre National de la Recherche Scientifique (CNRS), Université Paris Sud, Palaiseau, France. His current research interests consist in innovative ultrafast laser development. He received the "Fabry - De Gramont" Prize in 2005 and the "Jean Jerphagnon" Prize in 2011 for his research.

