



HAL
open science

Surfaces with pulleys and Khovanov homology

Benjamin Audoux

► **To cite this version:**

Benjamin Audoux. Surfaces with pulleys and Khovanov homology. *Journal of Knot Theory and Its Ramifications*, 2011, 20 (7), pp.1021-1040. 10.1142/S0218216511009091 . hal-01217084

HAL Id: hal-01217084

<https://hal.science/hal-01217084>

Submitted on 20 Oct 2015

HAL is a multi-disciplinary open access archive for the deposit and dissemination of scientific research documents, whether they are published or not. The documents may come from teaching and research institutions in France or abroad, or from public or private research centers.

L'archive ouverte pluridisciplinaire **HAL**, est destinée au dépôt et à la diffusion de documents scientifiques de niveau recherche, publiés ou non, émanant des établissements d'enseignement et de recherche français ou étrangers, des laboratoires publics ou privés.

SURFACES WITH PULLEYS AND KHOVANOV HOMOLOGY

BENJAMIN AUDOUX

ABSTRACT. In this paper, we define surfaces with pulleys which are unions of 1 and 2–dimensional manifolds, glued together on a finite number of points of their interiors. Then, by seeing them as cobordisms, we give a refinement of Bar-Natan geometrical construction of Khovanov homology which can be applied to different notions of refined links as links in I –bundle or braid-like links.

A decade ago, M. Khovanov defined a bigraded homology categorifying the Jones polynomial for links in S^3 [Kho00]. The construction is based on the combinatorics of the different resolutions of a link diagram D , *i.e.* the possible choices for smoothing every crossing (see Fig. 1), and more precisely on how the connected components, called *circles*, of these resolutions behave when changing the smoothing of a crossing.

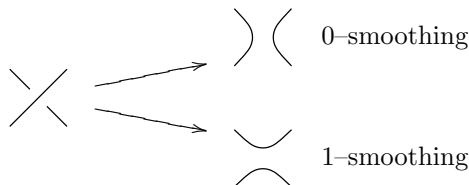

Figure 1: Smoothing for a crossing

Several refinements have been then developed, leading to triply graded homological invariants for links in I –bundle [APS04], braid-like links [AF05] or star-like links [Aud09]. In particular, the first two includes closed braids invariant. In all these examples, the main ingredient of the refinement is the splitting of the set of circles into two subsets, one of d –circles and one of h –circles.

In 2003, Bar-Natan gave a pictorial construction of Khovanov homology [BN05] which belongs to the realm of chain complexes over cobordisms. Bar-Natan construction can be adapted to the case of links in a I –bundle Y (resp. braid and star-like links) by marking h –circles (see [CS09]). Actually, one can even label the circles with their values in $H_1(Y, \mathbb{Z}/2\mathbb{Z})$ (resp. $\mathbb{Z}/2\mathbb{Z}$, 0 standing for d and 1 for h) and asking that for any cobordism, the sum over the labels of the boundary components vanishes. However, since we are dealing with abstract surfaces, this description is not very striking as it does not figure why a non zero labelled circle should not be capped off.

In this short note, we set a general background which fits the three cases mentioned above and we give a pictorial construction from which we can recover the corresponding refined Khovanov homologies.

For a given link diagram D , we define the set

$$Res_D = \bigcup_{\substack{r \text{ resolution} \\ \text{of } D}} \{\text{circles of } r\}$$

where, in general, the union is not disjoint, in the sense that a same circle appears whatever the smoothing of a crossing which is not adjacent to this circle is. If D lives on an orientable surface,

Date: November 24, 2009.

the switch of a crossing resolution splits one circle in two or merges two in one. Three different circles are then involved. We say that a map $\phi: Res_D \rightarrow \{d, h\}$ is a *refining map* if, among these three circles, there can not be exactly one sent to h . In other words, if one of them is sent to d by ϕ_D , then the other two have the same image through ϕ_D .

A *refined link diagram* is a pair (D, ϕ_D) where D is a link diagram on an orientable surface and $\phi_D: Res_D \rightarrow \{d, h\}$ is a refining map.

Now, suppose (D_1, ϕ_{D_1}) and (D_2, ϕ_{D_2}) are two refined link diagrams such that D_1 and D_2 are identical outside a disk where they differ by a Reidemeister move. Then there are several natural maps defined between some subsets of Res_{D_1} and Res_{D_2} . We say that (D_1, ϕ_{D_1}) and (D_2, ϕ_{D_2}) are connected by a refined Reidemeister moves if ϕ_{D_1} and ϕ_{D_2} factorize through these maps and if the *special circles* as shown in Fig. 2 are sent to d .

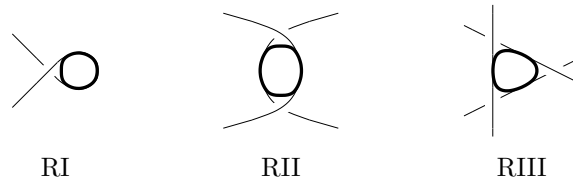

Figure 2: Special circles : for every Reidemeister, the special circle is shown in bold.

For instance, one can consider the diagrams on a surface Σ together the map which send a circle to d if it is null-homotopic and to h otherwise. It is straightforward to check that it is a refining map and that two diagrams are linked by refined Reidemeister moves if and only if they represent the same link in $\Sigma \times [0, 1]$. The maps sending a circle to its type as defined in [AF05] and [Aud09] are also refining maps and they lead, respectively to the notion of braid and star-like links.

In section 1, we define *surfaces with pulleys* which are, broadly speaking and up to some relations, 1 and 2-dimensional pieces glued together on a finite number of points of their interiors. Such connecting points, called *pulleys*, are labelled by elements of $\mathbb{Z}/3\mathbb{Z}$. Since they have boundary, they can be considered as some multi-dimensional cobordisms. Then, we define the category \mathcal{P} of chain complexes over surfaces with pulleys. We also define a map from a refined version of Bar-Natan category Kob to \mathcal{P} . This allows, in section 2, to import Bar-Natan construction to \mathcal{P} , defining refined Khovanov homology.

Theorem 1. *The refined Khovanov homology is invariant under refined Reidemeister moves.*

Finally, the note ends with several functors which send this geometrical construction to the algebraic world of modules.

Acknowledgement: The author would like to thank Michael Eisermann and Christine Lescop for interesting discussion and remarks. He is also grateful to Mucyo Karemera for his help in finding the functor F_0 .

1. CATEGORY OF SURFACES WITH PULLEYS

1.1. Surfaces with pulleys. Surfaces with pulleys are abstract surfaces composed of 1 and 2-dimensional pieces that can be connected thanks to $\mathbb{Z}/3\mathbb{Z}$ -labelled pulleys. The 2-dimensional pieces are called *surfaces* and the 1-dimensional ones *ropes*. In Fig. 1.1, we give a generating set of elementary surfaces. Any two surfaces can be composed vertically by disjoint union. Moreover, if the right boundary of a surface corresponds to the left boundary of another surface, then they can be composed horizontally by gluing them along this common boundary (see Fig. 1.1).

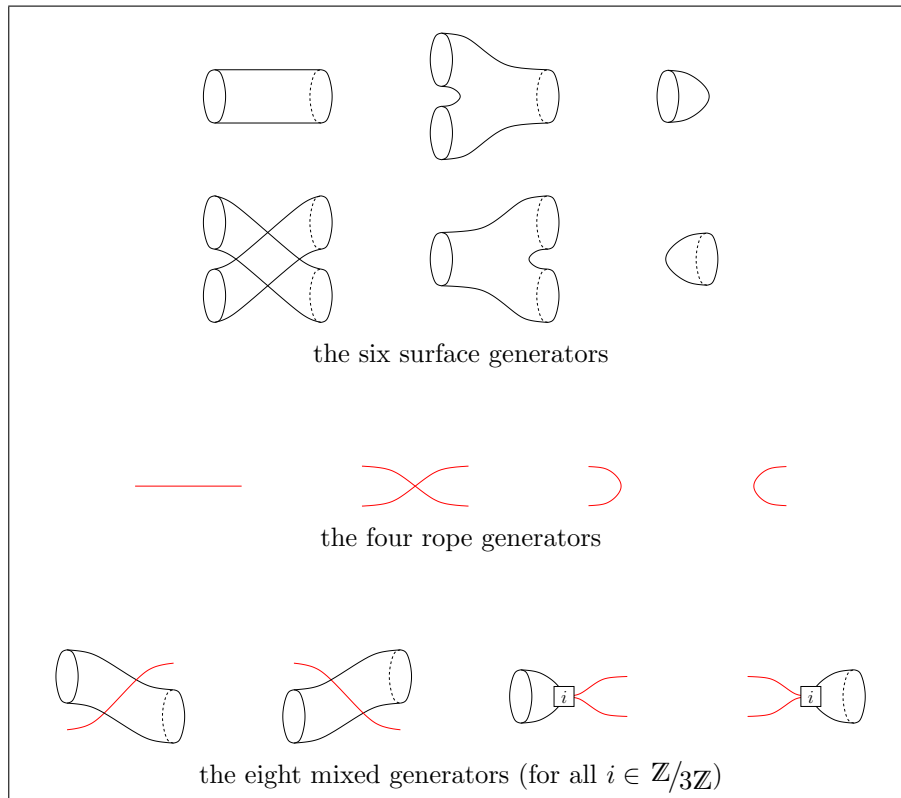

Figure 3: Generators for surfaces with pulleys

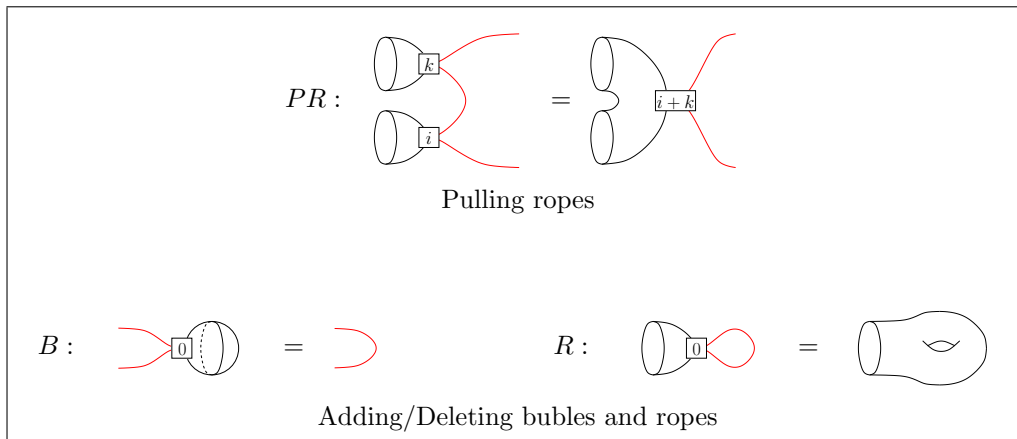

Figure 4: Special relations on surfaces with pulleys

Besides the natural relations on surfaces and ropes (see Appendix A), we quotient by some mixed relations which are given in Fig. 1.1.

The following proposition is a direct application of relations PR and R .

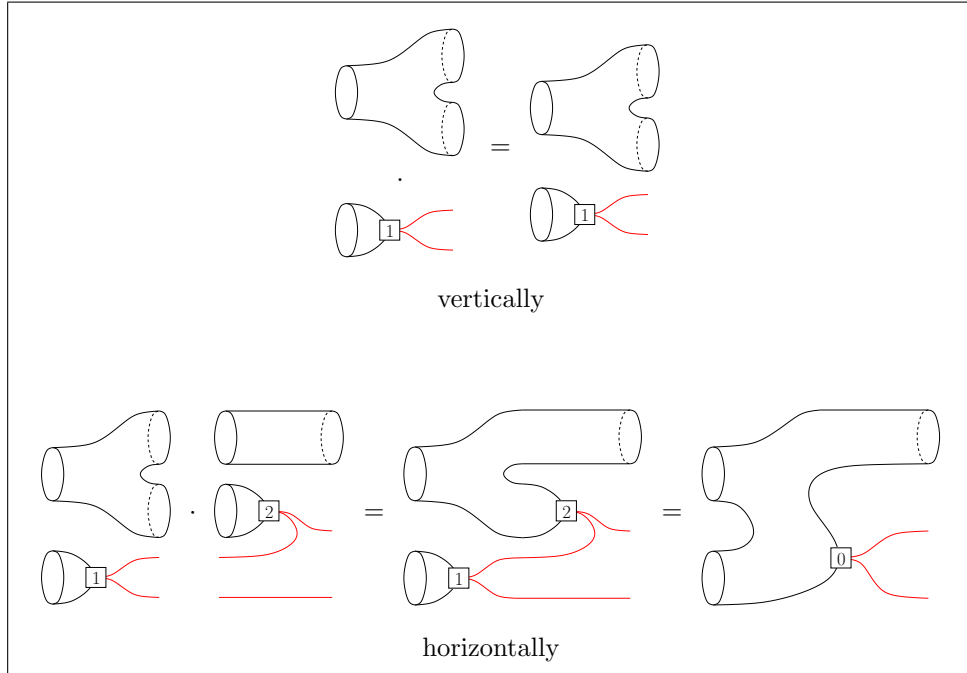

Figure 5: Composition of surfaces

Proposition 1.1. *As surfaces with pulleys, we have for every $i, k \in \mathbb{Z}/3\mathbb{Z}$ such that $i + k = 0$*

$$\begin{array}{c} \text{pulley } i \end{array} \text{ --- } \begin{array}{c} \text{pulley } k \end{array} = \begin{array}{c} \text{surface with hole} \end{array} .$$

1.2. Definition of the category. We follow the definition and notation of Bar-Natan in [BN05].

First, we define the category of surfaces with pulleys that we denote $\tilde{\mathcal{P}}$. Its objects are disjoint unions of dots and circles. A morphism from O_1 to O_2 is a surface with pulleys Σ whose left boundary is O_1 and right boundary O_2 .

The composition of morphisms correspond to horizontal composition of surfaces with pulleys.

Now, we define \mathcal{P}_{ab} which is a pre-additive category set up from $\tilde{\mathcal{P}}$. Its objects are the same but its morphisms are formal linear combinations (possibly empty) of morphisms of $\tilde{\mathcal{P}}$ up to the relations S , $2P$ and $4T$ given in Fig. 1.2.

Notation 1.2. We denote by \mathcal{P} the category defined as $\text{Kom}_{/h}(\text{Mat}(\mathcal{P}_{ab}))$ with coefficients with coefficients in a ring A .

We can note that the relation T is equivalent to the following relation

$$T' : \text{circle} = 2 .$$

Moreover, as soon as surface with pulley does contain any 1-dimensional piece, applying $4T$ to the

pattern  proves that the relation T is implied by others relations.

Proposition 1.3. *If 2 is invertible in A , then any connected surface with at least two pulleys vanishes in \mathcal{P}_{ab} and thus in \mathcal{P} .*

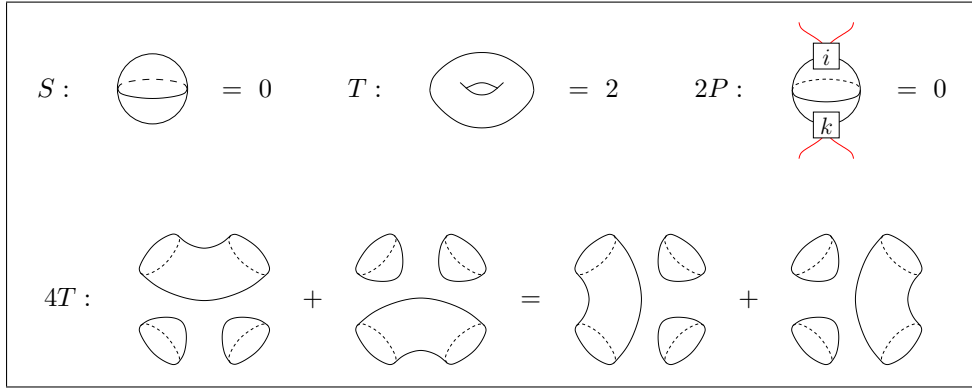
Figure 6: Relations in \mathcal{P}_{ab}

Proof. If 2 is invertible in A , then the $4T$ relation is equivalent to the neck cutting relation (see [BN05]) and thus we have

$$\begin{array}{c}
 \text{Diagram 1} \\
 \text{Diagram 2} \\
 \text{Diagram 3} \\
 \text{Diagram 4} \\
 \text{Diagram 5}
 \end{array}
 = \frac{1}{2}
 \begin{array}{c}
 \text{Diagram 6} \\
 \text{Diagram 7}
 \end{array}
 + \frac{1}{2}
 \begin{array}{c}
 \text{Diagram 8} \\
 \text{Diagram 9}
 \end{array}
 = \frac{1}{2}
 \begin{array}{c}
 \text{Diagram 10} \\
 \text{Diagram 11}
 \end{array}
 = 0.$$

□

Corollary 1.4. *Let S be a connected surface of genus g with k pulleys on it. Then, if 2 is invertible in A and if $g + k \geq 2$, then S vanishes in \mathcal{P} .*

1.3. A functor from refined Kob_r to \mathcal{P} . We consider Kob_r a refined version of the category Kob , defined as the latter but over the category Cob_r whose objects are circles labelled by d or h and morphisms are cobordisms which have no or more than two boundary components labelled by h .

Now, we define the map \mathcal{F} from the category Kob_r to \mathcal{P} as follows.

For an elementary object O of Kob_r , that is an object of Cob_r , $\mathcal{F}(O)$ is obtained by forgetting d labels and replacing h -labelled circles by dots.

Now, let C be a connected cobordism between O_1 and O_2 . We define the type of C as

$$(k_1, k_2) = (\#\{h\text{-labelled components of } O_1\}, \#\{h\text{-labelled components of } O_2\}).$$

If $k_1 + k_2 = 0$ then $\mathcal{F}(C)$ is the natural embedding of C into \mathcal{P} . If $k_1 + k_2 = 2$ then $\mathcal{F}(C)$ is obtained by capping off the two h -circles and adding a pulley on C labelled by $k_2 - k_1$ (see Fig. 7). Otherwise $\mathcal{F}(C) = 0$.

Then \mathcal{F} is extended to unconnected morphisms by vertical composition and to chain complexes by linearity.

Proposition 1.5. *If 2 is invertible in A , then \mathcal{F} is a functor, i.e. for two horizontally composable morphisms C_1 and C_2 , we have*

$$(1) \quad \mathcal{F}(C_1 \cdot C_2) = \mathcal{F}(C_1) \cdot \mathcal{F}(C_2).$$

First we prove two lemmata where 2 is assumed to be invertible in A .

Lemma 1.6. *If C_1 or C_2 is a disjoint union of a connected cobordism of type $(0,0)$ with some cylinders, then the equation (1) holds.*

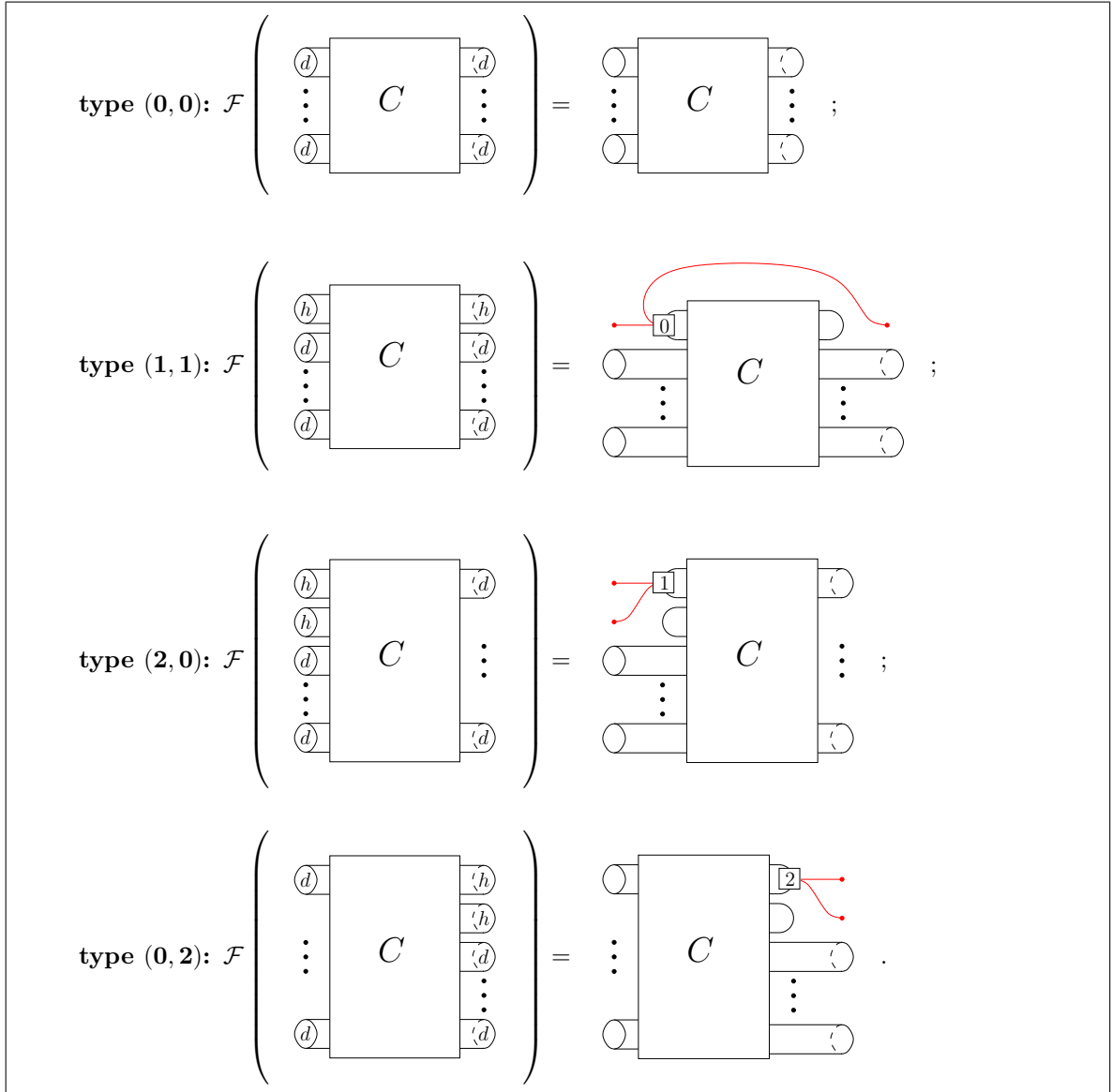
Figure 7: the functor \mathcal{F}

Proof. Both ends of a cylinder have necessarily the same image through ϕ and composing with a cylinder whose boundary components are sent to h corresponds to adding a bubble which can be removed thanks to the relation B .

Now, we assume that C_2 is the disjoint union of D , a connected cobordism of type $(0,0)$, with some cylinders. The only annoying case which may happen is that D is connecting several cobordism of type (k_1, k_2) with $k_1 + k_2 = 2$. But then, in one hand, $\mathcal{F}(C_1 \cdot C_2)$ vanishes because of its type and, in the other hand, $\mathcal{F}(C_1) \cdot \mathcal{F}(C_2)$ vanishes because of Cor. 1.4, since a connected surface have at least two pulleys on it. \square

Lemma 1.7. *If a cobordism C can be factorized through the disjoint union of a h -pants, that is*

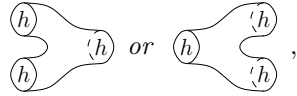

and some cylinders, then $\mathcal{F}(C) = 0$.

If C is a punctured sphere, then the converse is also true.

Proof. Without loss of generality, we can assume that C factorizes from the left. If it factorizes through a h -pants of type $(2, 1)$ then the connected component of the right summand connected to the h -pants has at least one boundary component sent to h and thus is of type (k_1, k_2) with $k_1 + k_2 \geq 2$. But then, C is of type $(1 + k_1, k_2)$ and $\mathcal{F}(C) = 0$.

Now, suppose the h -pants is of type $(1, 2)$. Then, there are two cases :

it connects two connected components of the right summand: for the same reason than above, the two connected components are of type (k_1^1, k_2^1) and (k_1^2, k_2^2) with $(k_1^1 + k_2^1), (k_1^2 + k_2^2) \geq 2$ and then C is of type $(k_1^1 + k_1^2 - 1, k_2^1 + k_2^2)$ and $\mathcal{F}(C) = 0$;

it is twice connected to a connected component of the right summand: we assume, *ad absurdum*, that $\mathcal{F}(C) \neq 0$ but then it is a surface of genus at least one and, because of the third boundary component of the h -pants, it has at least one pulley. Then it vanishes because of Cor. 1.4.

In the case of a punctured sphere, the converse is clear. \square

Proof of Prop. 1.5. It is sufficient to prove the proposition for C_1 and C_2 two composable cobordisms such that the product $C_1 \cdot C_2$ is connected. The product can be decomposed as in Figure 8 where the S_i^j are punctured spheres and Σ is a disjoint union of cylinder which permutes the in and out entries. According to Lemma 1.6, $\mathcal{F}(C_1) \cdot \mathcal{F}(C_2) = \mathcal{F}(S_1) \cdot \mathcal{F}(D) \cdot \mathcal{F}(S_2)$.

We prove by induction on $n_1 + n_2$ that if $\mathcal{F}(S_i^j) = 0$ for some $i \in \{1, 2\}$ and some $j \in \llbracket 1, n_i \rrbracket$ then $\mathcal{F}(C_1 \cdot C_2) = 0$. Without loss of generality, we may assume that $i = j = 1$.

If $n_1 + n_2 \leq 2$: $\mathcal{F}(S_1^1) = 0$, thus, according to Lemma 1.7, S_1^1 factorizes through a h -pants. If it factorizes from the left, then so does $C_1 \cdot C_2$ and $\mathcal{F}(C_1 \cdot C_2) = 0$. If it factorizes from the right, then the h -pants is of type $(1, 2)$. Let (k_1, k_2) be the type of the left summand of the factorization. Since $n_2 \leq 2 - n_1 \leq 1$ the two right boundary components are connected to S_2^1 , imposing that $C_1 \cdot C_2$ is of genus at least 1. Now, if $k_1 > 0$, then assuming that $\mathcal{F}(C_1 \cdot C_2) \neq 0$ means that $\mathcal{F}(C_1 \cdot C_2)$ contains a surface of genus greater than one with at least one pulley on it. Since Cor. 1.4, it vanishes.

If $k_1 = 0$, then $k_2 \geq 2$, and S_1^1 has a third connection with S_2^1 . Then the genus of $C_1 \cdot C_2$ is at least 2 and, once again, $\mathcal{F}(C_1 \cdot C_2)$ vanishes because of Cor. 1.4.

If $n_1 + n_2 > 2$: We follow the same discussion as above but then, there is one new possible case: S_1^1 may factorize from the right with a h -pants which connects S_2^i and S_2^j with distincts $i, j \in \llbracket 1, n_2 \rrbracket$. But then, the h -pants may be move from S_1 to S_2 without changing $C_1 \cdot C_2$ nor $\mathcal{F}(S_1) \cdot \mathcal{F}(D) \cdot \mathcal{F}(S_2)$ since in both cases, one of the summand vanishes. Moreover, the number of punctured sphere is reduced by one and one of them factorizes through a h -pants. We can thus apply the recursive hypothesis.

Now, we can assume that \mathcal{F} does not vanish on the punctured sphere and hence that, for all $i \in \{1, 2\}$ and $j \in \llbracket 1, n_i \rrbracket$, $\mathcal{F}(S_i^j)$ is of one of the following forms:

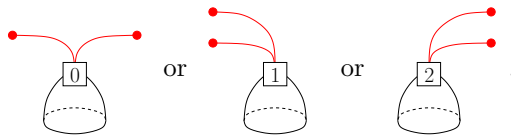

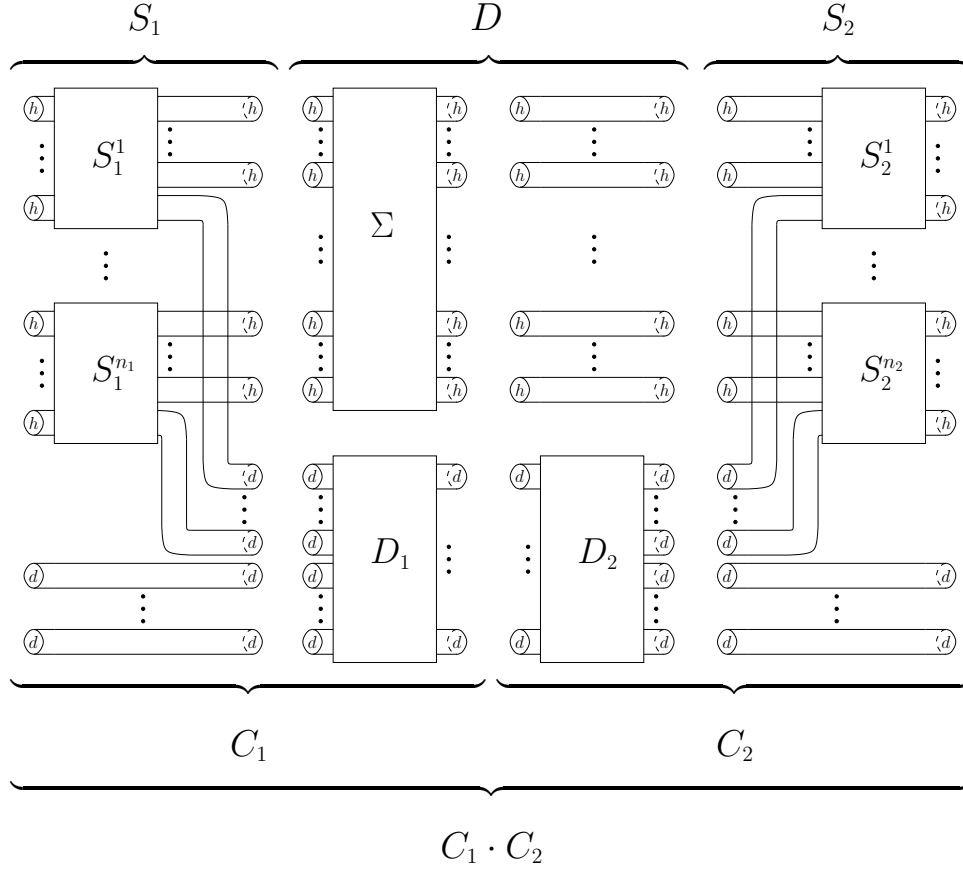

Figure 8: Cobordisms decomposition

Then, we can successively shrink all the cylinders from the upper part of $\mathcal{F}(D)$ using the relations PR and R . We obtain a surface of genus g and with $\frac{k_1+k_2}{2}$ pulleys on it where g and (k_1, k_2) are respectively the genus and the type of $C_1 \cdot C_2$. Finally both $\mathcal{F}(C_1 \cdot C_2)$ and $\mathcal{F}(S_1) \cdot \mathcal{F}(D) \cdot \mathcal{F}(S_2)$ vanish if $g + \frac{k_1+k_2}{2} \geq 2$. Otherwise, it is easily checked that the label of the possible pulley is the same in both cases. \square

Remark 1.8. If 2 is not assumed to be invertible in A , then \mathcal{F} is not anymore a functor since Prop. 1.3 and its corollary do not hold. However, the relation (1) is still valid on some simple cases which are enough for our purpose.

2. REFINED KHOVANOV HOMOLOGY

2.1. Refined geometrical Khovanov homology. Let (D, ϕ_D) be a refined diagram. Then the map ϕ_D sends naturally Bar-Natan chain complex $[[D]] \in \text{Kob}$ to a chain complex $[[D]]_{\phi_D} \in \text{Kob}_r$. We define refined Khovanov homology as $\mathcal{F}([[D]]_{\phi_D})$.

Theorem 1. *The refined Khovanov homology is invariant under refined Reidemeister moves.*

Proof. If 2 is invertible in A , then it follows from Bar-Natan results and Prop. 1.5.

If not, then one can, fastidiously but straightforwardly, check case by case that the relation (1) holds whenever we need it to transport Bar-Natan proofs into the refined realm. \square

2.2. Refined algebraic Khovanov homology. In this last section, we transport the geometrical construction given above into the algebraic world. To this end, we define some functors from \mathcal{P}_{ab} to the category $A\text{-Mod}$ of A -modules. But first, we give some notations.

Notation 2.1. Let D and H be the free A -modules generated by, respectively, v_+ and v_- , and h_+ and h_- . Moreover, we denote $h_+ + h_- \in H$ by h_0 .

Let $m: D \otimes D \rightarrow D$, $\Delta: D \rightarrow D \otimes D$, $\varepsilon: A \rightarrow D$ and $\eta: D \rightarrow A$ be the maps defined by

$$\begin{aligned} m: \begin{cases} v_+ \otimes v_+ \mapsto 0 \\ v_\pm \otimes v_\mp \mapsto v_+ \\ v_- \otimes v_- \mapsto v_- \end{cases} & \quad \Delta: \begin{cases} v_+ \mapsto v_+ \otimes v_+ \\ v_- \mapsto v_+ \otimes v_- + v_- \otimes v_+ \end{cases} \\ \varepsilon: \{ 1 \mapsto v_- \} & \quad \eta: \begin{cases} v_+ \mapsto 1 \\ v_- \mapsto 0 \end{cases} \end{aligned}$$

and $\rho_1: D \rightarrow H \otimes H$, $\lambda_1: H \otimes H \rightarrow D$, $\rho_2: D \rightarrow H \otimes H$, $\lambda_2: H \otimes H \rightarrow D$ defined by

$$\rho_1: \begin{cases} v_+ \mapsto 0 \\ v_- \mapsto h_+ \otimes h_- + h_- \otimes h_+ \end{cases} \quad \rho_2: \begin{cases} v_+ \mapsto 0 \\ v_- \mapsto h_0 \otimes h_0 + h_- \otimes h_- \end{cases}$$

$$\lambda_1: \begin{cases} h_\pm \otimes h_\pm \mapsto 0 \\ h_\pm \otimes h_\mp \mapsto v_+ \end{cases} \quad \lambda_2: \begin{cases} h_+ \otimes h_+ \mapsto 2v_+ \\ h_\pm \otimes h_\mp \mapsto -v_+ \\ h_- \otimes h_- \mapsto v_+ \end{cases} .$$

It is easily seen that a functor $F: \mathcal{P}_{ab} \rightarrow A\text{-Mod}$ is totally determined by its values on right and left pants, capping off and 0-pulleys, and on left 1 and 2-pulleys.

Then for all $i, j \in \{1, 2\}$, we define F_{ij} by $F_{ij}(\text{circle}) = D$, $F_{ij}(\text{dot}) = H$ and

$$\begin{aligned} F_{ij} \left(\text{circle with dot} \right) &= \varepsilon & F_{ij} \left(\text{circle with dot} \right) &= \eta \\ F_{ij} \left(\text{right pants} \right) &= m & F_{ij} \left(\text{left pants} \right) &= \Delta \\ F_{ij} \left(\text{circle with dot and red lines} \right) &= \rho_i & F_{ij} \left(\text{circle with dot and red lines} \right) &= \lambda_i \\ F_{ij} \left(\text{circle with dot and red lines} \right) &= \rho_j & F_{ij} \left(\text{circle with dot and red lines} \right) &= \rho_j \end{aligned}$$

Checking that these functors are well defined, *i.e.* that they satisfy all relations, is left to the reader. Moreover, in the context of links in I -bundle, of braid-like or of star-like links, the functor F_{11} send the refined geometrical Khovanov homologies to the usual refinements.

To conclude, we give a last functor F_0 which sends pulleys with distinct labels to distinct maps. However, it requires that A is of characteristic 2.

$$\begin{array}{ll}
 F_0 \left(\text{pulley with 1 hole} \right) = \varepsilon & F_0 \left(\text{pulley with 1 hole and 2 red lines} \right) = \begin{cases} v_+ \mapsto 0 \\ v_- \mapsto h_+ \otimes h_+ + h_0 \otimes h_0 \end{cases} \\
 F_0 \left(\text{pulley with 2 holes} \right) = \eta & F_0 \left(\text{pulley with 2 holes and 2 red lines} \right) = \begin{cases} h_+ \otimes h_+ \mapsto v_+ \\ h_{\pm} \otimes h_{\mp} \mapsto v_+ \\ h_- \otimes h_- \mapsto 0 \end{cases} \\
 F_0 \left(\text{pulley with 3 holes} \right) = m & F_0 \left(\text{pulley with 3 holes and 2 red lines} \right) = \begin{cases} v_+ \mapsto 0 \\ v_- \mapsto h_+ \otimes h_+ + h_- \otimes h_- \end{cases} \\
 F_0 \left(\text{pulley with 4 holes} \right) = \Delta & F_0 \left(\text{pulley with 4 holes and 2 red lines} \right) = \begin{cases} v_+ \mapsto 0 \\ v_- \mapsto h_0 \otimes h_0 + h_- \otimes h_- \end{cases} .
 \end{array}$$

APPENDIX A. RELATIONS ON SURFACES AND ROPES

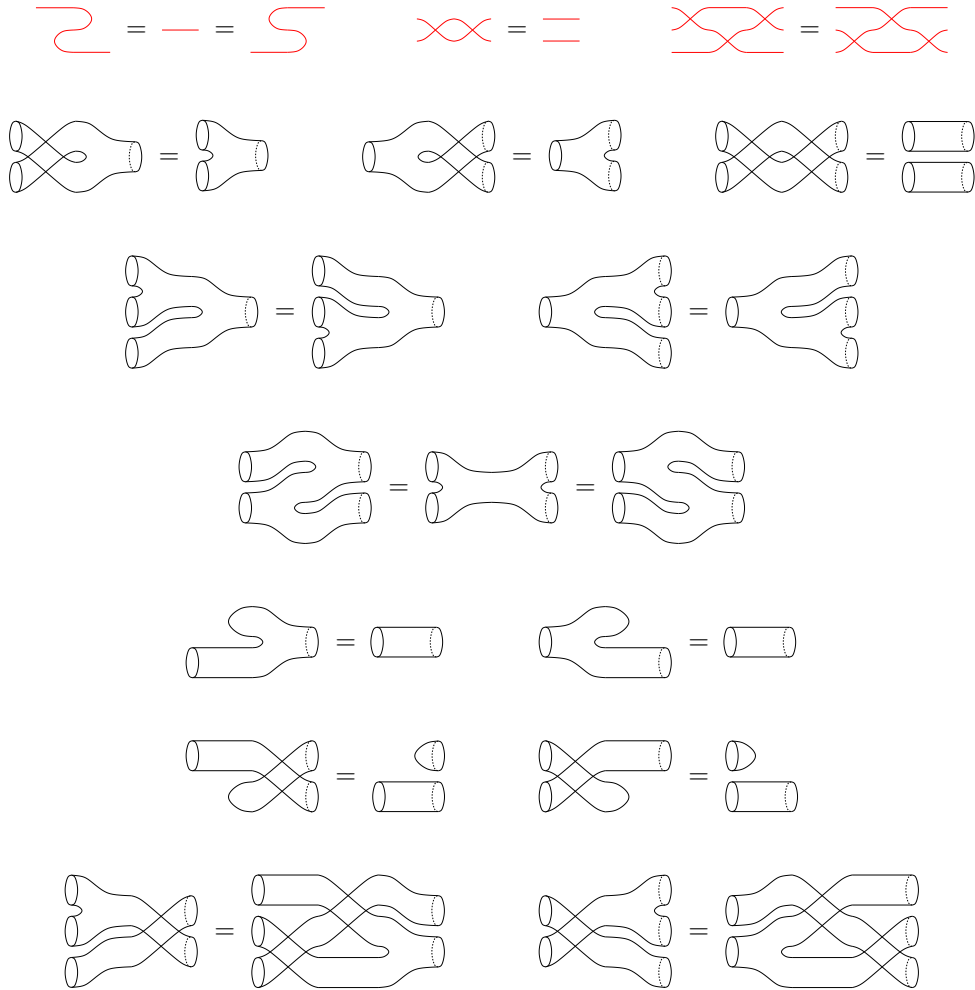

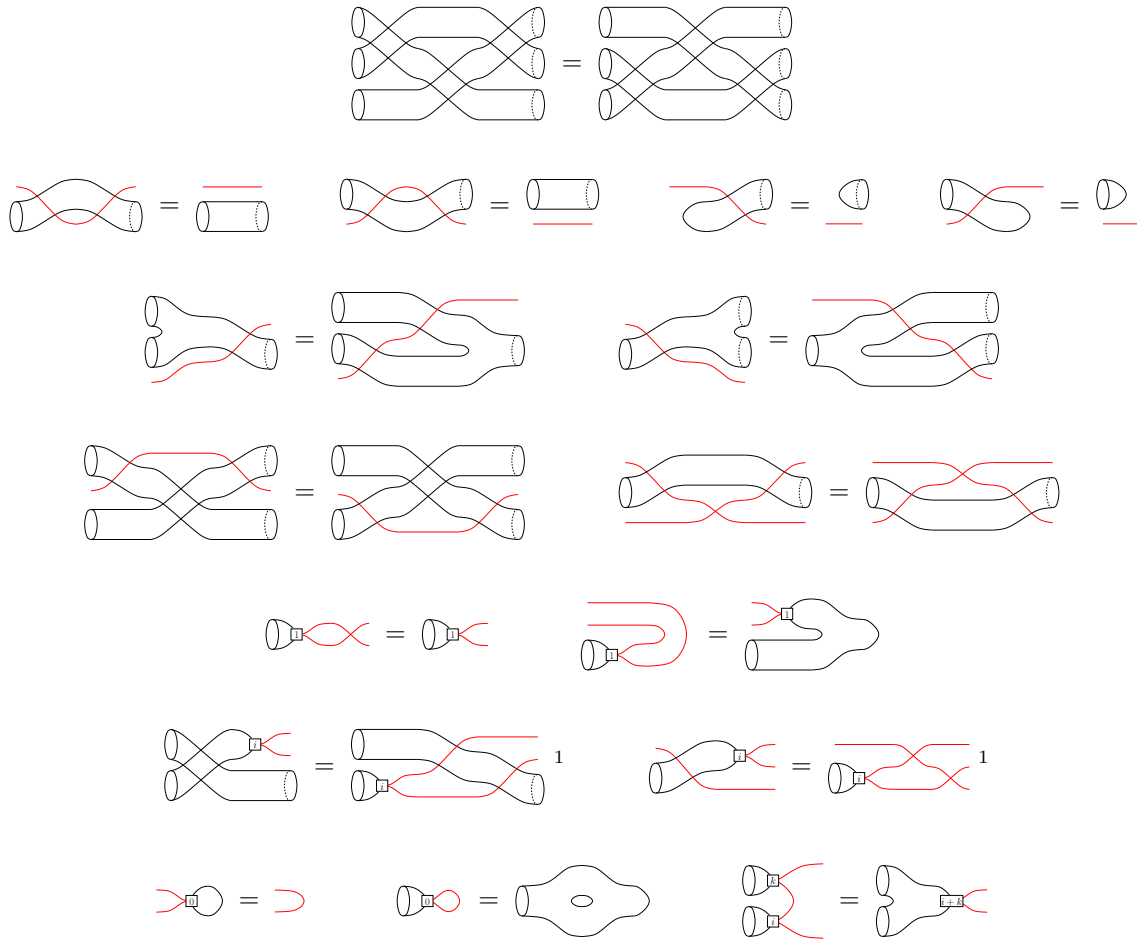

REFERENCES

[AF05] Benjamin Audoux and Thomas Fiedler, *A Jones polynomial for braid-like isotopies of oriented links and its categorification*, *Algebr. Geom. Topol.* **5** (2005), 1535–1553.
 [APS04] Marta M. Asaeda, Józef H. Przytycki, and Adam S. Sikora, *Categorification of the Kauffman bracket skein module of I-bundles over surfaces*, *Algebr. Geom. Topol.* **4** (2004), 1177–1210.
 [Aud09] Benjamin Audoux, *Khovanov homology and star-like isotopies*, *Topology Appl.* **156** (2009), no. 6, 1054–1070.
 [BN05] Dror Bar-Natan, *Khovanov’s homology for tangles and cobordisms*, *Geom. Topol.* **9** (2005), 1443–1499.
 [CS09] J. Scott Carter and Masahico Saito, *Frobenius modules and essential surface cobordisms*, *arXiv:math.GT/0905.4475*, 2009.
 [Kho00] Mikhail Khovanov, *A categorification of the Jones polynomial*, *Duke Math. J.* **101** (2000), no. 3, 359–426.

SECTION DE MATHÉMATIQUES, UNIGE, RUE DU LIÈVRE 2-4, 1211 GENÈVE 4, SWITZERLAND
 E-mail address: benjamin.audoux@unige.ch

¹for $i = 0$ and $i = 1$