



**HAL**  
open science

## Shape optimization method for crashworthiness design based on Equivalent Static Loads concept

Laurent Genest, Louis Jézéquel, Frédéric Gillot, Frédéric Mercier

### ► To cite this version:

Laurent Genest, Louis Jézéquel, Frédéric Gillot, Frédéric Mercier. Shape optimization method for crashworthiness design based on Equivalent Static Loads concept. 11th World Congress on Structural and Multidisciplinary Optimization, ISSMO, Jun 2015, Sydney, Australia. hal-01207247

**HAL Id: hal-01207247**

**<https://hal.science/hal-01207247>**

Submitted on 30 Sep 2015

**HAL** is a multi-disciplinary open access archive for the deposit and dissemination of scientific research documents, whether they are published or not. The documents may come from teaching and research institutions in France or abroad, or from public or private research centers.

L'archive ouverte pluridisciplinaire **HAL**, est destinée au dépôt et à la diffusion de documents scientifiques de niveau recherche, publiés ou non, émanant des établissements d'enseignement et de recherche français ou étrangers, des laboratoires publics ou privés.

## Shape optimization method for crashworthiness design based on Equivalent Static Loads concept

Laurent Genest<sup>1,2</sup>, Louis Jézéquel<sup>1</sup>, Frédéric Gillot<sup>1</sup>, Frédéric Mercier<sup>2</sup>

<sup>1</sup> LTDS, École Centrale de Lyon, Ecully, France,

louis.jezequel@ec-lyon.fr, frederic.gillot@ec-lyon.fr

<sup>2</sup> CAE Models and Methods Department, Renault S.A.S., Guyancourt, France,

laurent.genest@renault.com, frederic.mercier@renault.com

### 1. Abstract

Shape optimization of parameterized thin shell structures is increasingly considered by automotive industry in order to face nonlinear dynamics problems like crashworthiness. Since the number of shape parameters is important, traditional multidisciplinary optimization methods such as metamodeling techniques become less efficient due to expensive calculation times. A way to get around the problem is to switch to gradient methods which are less sensitive to the number of parameters. However, shape sensitivities are often hard and costly to calculate for highly nonlinear problems.

Inspired by the Equivalent Static Loads Method, we defined linear static problems on which we perform a shape sensitivity analysis. After linking sensitivity maps with CAD parameters, gradients are used as descent directions for the nonlinear objective function. We applied successfully the method to two test cases: minimization of a nodal displacement and maximization of the absorbed energy. Because the calculation of this descent direction is inexpensive, this new optimization method allows performing crashworthiness optimization studies with a large number of parameters.

**2. Keywords:** Shape optimization, Crashworthiness, Equivalent Static Loads, Approximated gradient.

### 3. Introduction

Depending on the optimization variables that describe the shape of the domain to be optimized, shape optimization can be classified in three categories : topology, shape and parametric optimizations [3]. Automotive industry has a growing interest on parametric shape optimization since it directly takes into account the manufacturing process. Indeed, knowing more severe specifications and a will of mass reduction, this industry is enlarging the optimization design space to shape parameters.

Crashworthiness is one of the most dimensioning specifications of the body in white and is still problematic. Even if it is possible to calculate a descent direction with finite difference [5], this method has not been used due to the numerical noise, the high nonlinearity and the heavy calculation time (e.g. crashworthiness time calculation for a full vehicle: around 10h/16 processors) of this rapid dynamics problem. Instead, car designers used metamodeling techniques which have been successfully applied to optimization problems with thickness and materials parameters and also with a few number of shape parameters [6, 2].

However, the optimization cost of those methods dramatically increase with the number of shape parameters. A way to get around this issue is to switch to gradient methods where the number of parameters has a reduced effect on the optimization cost.

Recently, a new optimization algorithm for nonlinear problems, the *Equivalent Static Loads Method*, has been proposed by Park [7]. Inspired by this method, we have defined linear static problems equivalent to the rapid dynamic problem on which we calculate shape sensitivity. This gradient is then used as descent direction for the nonlinear problem. This method and its applications to two crashworthiness specifications are explained in following parts.

### 4. Calculation of the descent direction

In order to test our descent directions, we have applied the method to mono-objective crashworthiness problems. The rapid dynamic problem could be written as follow :

#### Optimization problem in rapid dynamic

Find the  $n$  shape parameters  $P = \{P_i\}$ ,  $i = 1..n$

To minimize  $J_{NL}(P)$ , the nonlinear objective function

Subject to constraints on the variation of the shape parameters  $P_i^{min} \leq P_i \leq P_i^{max}$ ,  $i = 1..n$

Where  $X_{NL}$  is the solution of the rapid dynamic equation (1).

$$M(P)\ddot{X}_{NL}(t,P) + K_T[X_{NL}(t,P),P]\Delta X_{NL}(t,P) = F_{NL}(t,P), \quad t = t_1..t_f \quad (1)$$

With  $M$  the mass matrix,  $K_T$  the tangent stiffness matrix,  $F_{NL}$  the external loading vector and  $X_{NL}$  the displacement vector.

#### 4.1. Equivalent Static Loads concept

Park proposed the Equivalent Static Loads Method (ESLM) and successfully applied it to several nonlinear problems [7, 8]. As illustrated in Figure 1, ESLM consists in the creation of  $f$  linear static problems equivalent to the nonlinear problem at a time  $t_s$  and this for each time step  $s = 1..f$ . The optimization is performed on the *Design Domain* (linear static problems) and the result is used to update the *Analysis Domain* (nonlinear problem). A new nonlinear analysis is performed and new equivalent static problems are created. This process is repeated until convergence.

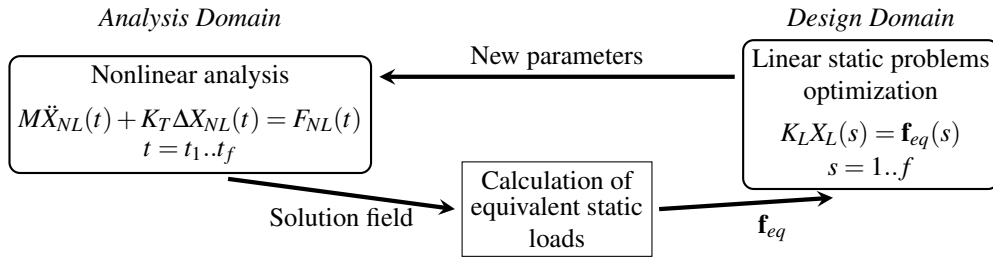

Figure 1: Optimization process of the Equivalent Static Loads Method

Linear static equations are defined in equation (2).

$$K_L(P)X_L(s,P) = \mathbf{f}_{eq}(s), \quad s = 1..f \quad (2)$$

where  $K_L$  is the static linear stiffness matrix of the initial (non-deformed) domain,  $X_L$  the linear displacement vector solution of the equation and  $\mathbf{f}_{eq}(s)$  is the equivalent static load chosen to preserve the field at step time  $t_s$  we want to optimize in the linear static problem.

For example, if we want to optimize the displacement of a node, we have to preserve the non-linear displacement  $X_{NL}(t_s)$  solution of (1) at  $t_s$ . Writing  $\mathbf{f}_{eq}(s) = K_L X_{NL}(t_s)$ , we preserve the nonlinear displacement field:  $X_L(s) = X_{NL}(t_s)$ .

#### 4.2. Presentation of the method

Inspired by the Equivalent Static Loads Method, we propose to use the shape sensitivity calculated on equivalent linear static problems as a descent direction for the rapid dynamic problem. We studied two crashworthiness specifications. The first one is to minimize a nodal displacement. Then, we defined a static linear problem that preserve the displacement field. In the second study, we had to maximize the absorbed energy of a part of the domain. In this case, we had to preserve both strain and stress fields in a linear static problem.

Methods of calculation of the two descent directions are explained in this part. Shape sensitivities are first calculated on the nodes position of the CAE\* model. The link between this sensitivity mapping and CAD† parameters is explained in the next section.

##### 4.2.1. Descent direction calculation for the optimization of a nodal displacement

The objective function that we want to minimize is  $J_{NL}(P) = u_{NL}(t_a, P)$  where  $u_{NL}(t_a, P)$  is a nodal displacement at  $t_a$  fixed. Since the objective function is a displacement function, we need to preserve  $X_{NL}$  in the equivalent linear static equation (3).

$$K_L(P)X_L(P) = \mathbf{f}_{eq} \quad (3)$$

with  $K_L$  the linear stiffness matrix of the initial non-deformed domain and  $\mathbf{f}_{eq} = K_L X_{NL}(t_a)$ .

The shape sensitivity is issued from the linear model, that means that we approximate  $d_P J_{NL}$  by  $d_P J_L$ . Because  $\partial_P J_L = 0$ , the descent direction used for the nonlinear objective function is  $d_P J_L = \partial_Q J_L \cdot \partial_P Q$  where  $Q$  is the nodes

\*Computer Aided Engineering

†Computer Aided Design

position of the CAE model. We have seen that, under quasi-static and quasi-proportionnal loadings (reversibility) hypotheses [4], we have  $\langle d_P J_{NL}, d_P J_L \rangle \geq 0$  and then  $-d_P J_L$  is well a descent direction of the rapid dynamic problem.

Since the explicit algorithm used to solve equation (1) is stable, quasi-static hypohese is validated. The following conditions are needed to validate the second hypohese:

- the initial state is the non-deformed and non-hardened state,
- the material law is a Prandtl-Reuss law,
- the hardening law is a power function,
- principal directions of stress tensor are quasi-constants,
- and elastic strains are negligible.

#### 4.2.2. Descent direction calculation for the optimization of the absorbed energy

Another important crashworthiness specification is to ensure a good behavior of the crash scenario. Engineers have to control the energy absorbed by a component of the car. The nonlinear objective function is defined in equation (4).

$$J_{NL}(P) = \int_{\Omega(P)} \int_{t_1}^{t_f} \langle \sigma_{NL}(\mathbf{x}, t) \rangle \{ \dot{\varepsilon}_{NL}(\mathbf{x}, t) \} dt dV \quad (4)$$

where  $\sigma_{NL}$  is the stress field and  $\dot{\varepsilon}_{NL}(\mathbf{x}, t) \approx \frac{1}{\Delta\tau} (\varepsilon_{NL}(\mathbf{x}, t) - \varepsilon_{NL}(\mathbf{x}, t - \Delta\tau))$  with  $\varepsilon_{NL}$  the strain field.

Doing a temporal discretization and writing  $\Delta\tau = t_s - t_{s-1}$ , we rewrite equation (4) to (5).

$$J_{NL}(P) = \sum_{s=1}^f \int_{\Omega(P)} \langle \sigma_{NL}(\mathbf{x}, t_s) \rangle \{ \varepsilon_{NL}(\mathbf{x}, t_s) \} - \{ \varepsilon_{NL}(\mathbf{x}, t_{s-1}) \} dV \quad (5)$$

With this kind of objective function, we need to preserve both stress and strain fields within the same linear static problem. To do so, we have to use the secant stiffness matrix  $K_S(P, t_s)$  which is calculated by assembling the element secant stiffness matrices:  $K_S(P, t_s) = \sum_{e=1}^{nb.elem.} [T^e(P)]^T [K_S^e(P, t_s)]_{loc} [T^e(P)]$  where  $[T^e(P)]$  is the change of basis matrix and  $[K_S^e(P, t_s)]_{loc}$  is calculated with the secant modulus of elasticity visible in Figure 2.

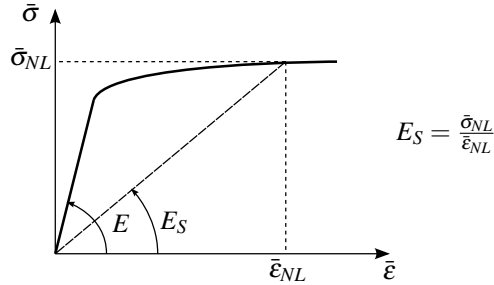

Figure 2: Definition of the secant modulus of elasticity  $E_S$

By using the secant stiffness matrix, we can define linear static problems for each time step which preserve  $\sigma_{NL}(\mathbf{x}, t_{s_1})$  and  $\varepsilon_{NL}(\mathbf{x}, t_{s_2})$  in the same equation (6). The equivalent static load is calculated to preserve the strain field.

$$K_S(P, s_1, s_2) X_L(P) = \mathbf{f}_{eq}^e \quad (6)$$

The equivalent linear objective function is then  $J_L(P) = \sum_{s=1}^f \tilde{J}_L(P, s, s) - \tilde{J}_L(P, s, s-1)$ , where  $\tilde{J}_L(P, s_1, s_2)$ , calculated with equation (6), is defined in equation (7).

$$\tilde{J}_L(P) = \int_{\Omega(P)} \langle \sigma_L(\mathbf{x}, s_1) \rangle \{ \varepsilon_L(\mathbf{x}, s_2) \} dV \quad (7)$$

Since  $\tilde{J}_L$  is a compliance-like criteria, it is quite easy to assess a shape derivative. The descent direction used for the nonlinear problem is then defined in equation (8).

$$\partial_P J_L(P) = \sum_{s=1}^f \partial_P \tilde{J}_L(P, s, s) - \partial_P \tilde{J}_L(P, s, s-1) \quad (8)$$

### 4.3. Test algorithm

In order to test the descent directions calculated previously, we have used the algorithm illustrated in figure 3. By using an adaptative step-length, the test algorithm is closed to a line-search algorithm.

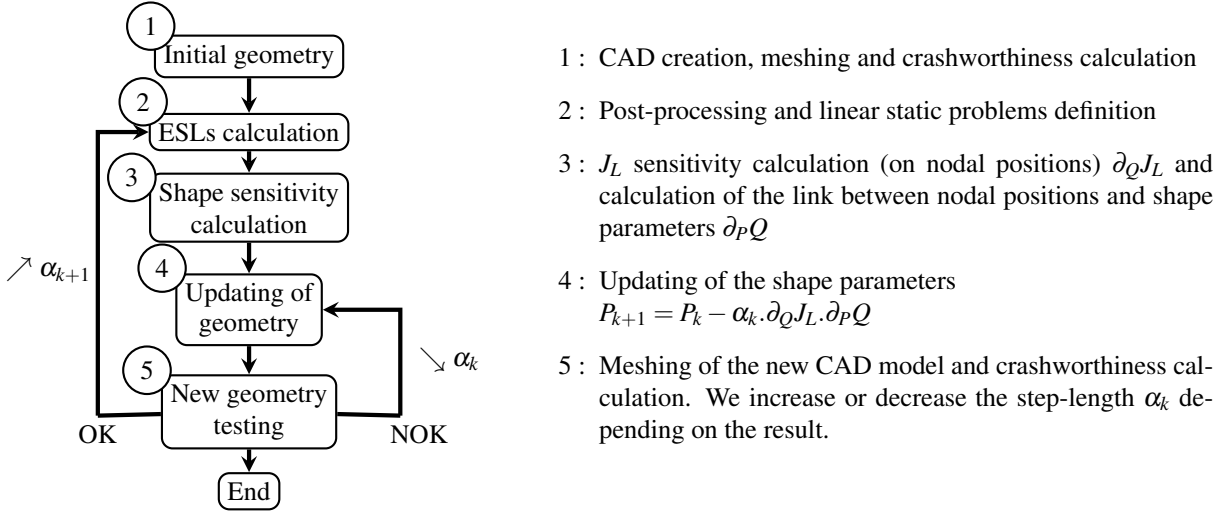

Figure 3: Algorithm used for testing the descent direction

Previously, we said that the shape sensitivity is calculated on the nodes position. We still have to link the sensitivity mapping to CAD parameters. In our case, we know the mathematical definition of the geometry : it is a B-spline surface  $S$  headed by its control points  $P$ . Because we know the mathematical definition of the parametric surface, we can easily link the nodal position of a node  $q$  and the position of the control point  $p_{\alpha\beta}$ .

$$\partial_{p_{\alpha\beta}} q = \frac{\partial S(\mathbf{u}_q, \mathbf{v}_q)}{\partial p_{\alpha\beta}} = b_{\alpha,l}(\mathbf{u}_q) b_{\beta,m}(\mathbf{v}_q) \quad (9)$$

where  $S$  is the B-spline surface of orders  $(l, m)$ ,  $b_{\cdot,a}$  the B-spline function of order  $a$  and  $(\mathbf{u}_q, \mathbf{v}_q)$  the parametric coordinates of the node  $q$  obtained by minimizing the distance  $D(S, q)$  between the node and the surface by a Newton-Raphson method.

## 5. Applications

We have used our method on two industrial cases : the minimization of a crash-box crushing that is a nodal displacement minimization problem and the maximisation of the PEA<sup>‡</sup> that is an absorbed energy problem.

### 5.1. Minimization of a crash-box crushing

In this test case, we want to minimize the crushing of the 150mm length crash-box in steel defined in figure 4-a. This beam has a thickness of 1.5mm and is launched through a rigid wall with an initial velocity of  $16\text{km}\cdot\text{h}^{-1}$  (pushing mass : 450kg). The geometry is defined with 3 sketches heading 16 control points illustrated in figure 4-b. Due to symetries, we defined 3 shape parameters on each sketch (9 shape parameters for the problem).

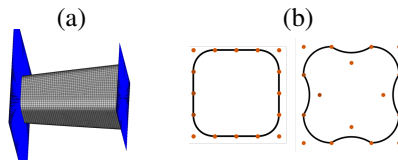

Figure 4: "Crash-box" test case (a) and its sketches (b)

Figure 5 represents the results of the optimization. The line-search of the first iteration, figure 5-a, shows that the problem is noisy and nonlinear. We have done several optimization studies in order to see the effect of the

<sup>‡</sup>Progressive Energy Absorbed

repeatability and of the mesh length. These results are visible in figure 5-b and show that a good CAE model quality is needed. We can also see in figure 5-c the crushing of the initial model and of the optimized one. The result which seems like a castle could be explained by the fact that the geometry is the one that have the greater second moment of area.

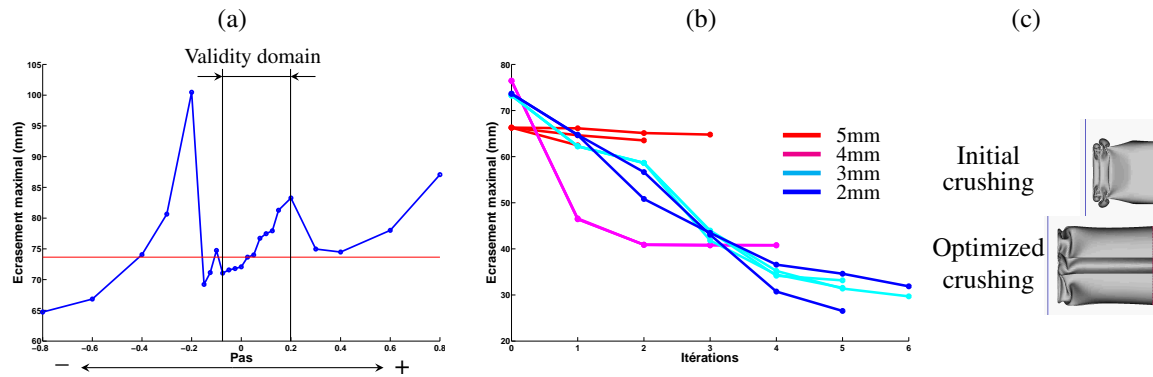

Figure 5: Results : line-search used for the first iteration (a), Effect of repeatability and mesh length on optimization process (b) (mesh length : 2-5mm), Initial and optimized models crushing (c)

## 5.2. Maximization of the Progressive Energy Absorbed of a front side member

Traditionnaly, the strategy chosen by engineers to absorb kinetic energy is a progressive crush of the front side member. Chase proposed a criterion called Progressive Energy Absorbed (PEA) in order to ensure a good behavior of the crushing process [1]. We choosed to maximize this objective function for our second test case. The S-beam visible in figure 6-a is defined with 120 CAD parameters and is launched onto a rigid wall with an initial velocity of  $30\text{km.h}^{-1}$  (pushing mass : 450kg, thickness : 1.5mm). We also defined 6 zones in order to calculate the PEA with equation (10).

$$PEA = \sum_{N=1}^5 (EA_N(U_N) - EA_N(U_{N-1})) - EA_6 \quad (10)$$

Where  $EA_N(U_N)$  is the energy absorbed by zone N when the beam has crushed of  $U_N$ ,  $EA_6$  is the total energy absorbed by zone 6 and values of  $U_N$  can be seen in figure 6-b.

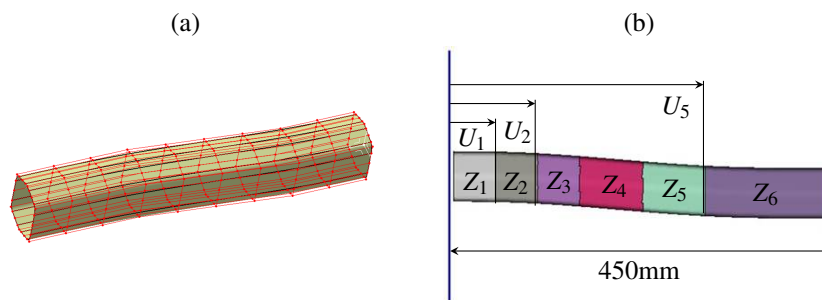

Figure 6: "S-Beam" test case, its control net (a) and zones for the PEA calculation (b)

Results are in figure 7. The initial geometry has a bad behavior: buckling. By maximizing the PEA, the rear part is reinforced and in 6 iterations, the front side member is crushing progressively.

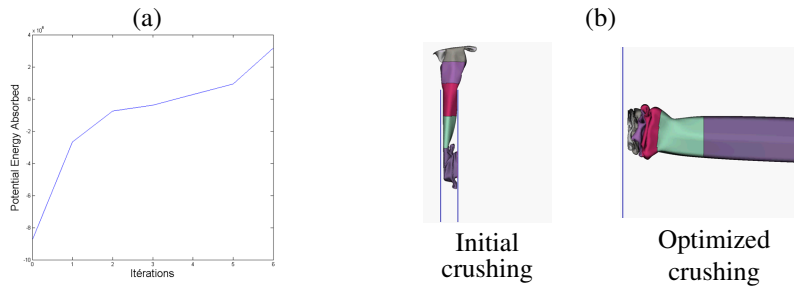

Figure 7: Results : PEA function of iterations (a),  
Initial and optimized models crushing (b)

## 6. Conclusions

We have proposed a method that use linear static problems in order to calculate a descent direction for a nonlinear crashworthiness problem. Since the calculation of the shape sensitivity is really fast compared to the crashworthiness calculation, this descent direction can be used for crashworthiness problems with a high number of parameters without having a too expensive optimization cost. We still have to calculate a descent direction for other crashworthiness problems like pulses or the Occupant Load Criterion and use them for multi-objectives optimization problems.

## 7. Acknowledgements

We thank Marc Albertelli (Renault) for fruitfull discussion on the Equivalent Static Loads approach.

## 8. References

- [1] N. Chase, R. Averill and R. Sidhu, Design optimization of progressively crushing rails, *SAE Technical Paper*, 2009-01-0353, 2009.
- [2] F. Duddeck, Multidisciplinary optimization of car bodies, *Structural and Multidisciplinary Optimization*, 35, 375-389, 2008.
- [3] P. Froment, F. Gillot, Y. Tourbier and L. Jézéquel, CAD-based large scale shape optimization method with intensive simulations, *10th World Congress on Structural and Multidisciplinary Optimization*, Orlando, Florida, USA, 2013.
- [4] J. Lemaitre and J.-L. Chaboche, *Mechanics of Solid Materials*, Cambridge University Press, 1990.
- [5] P.O. Marklund and L. Nilsson, Optimization of a car body component subjected to side impact, *Structural and Multidisciplinary Optimization*, 21, 383-392, 2001.
- [6] F. Mercier, M. Guillon and S. Maillot, Deployment of optimization studies using Alternova : design of a hood inner panel for pedestrian safety performance, *Ingénieurs de l'Automobile*, 29-46, 2012.
- [7] G.-J. Park, Technical overview of the equivalent static loads method for non-linear static response structural optimization, *Structural and Multidisciplinary Optimization*, 43, 319-337, 2011.
- [8] S.-I. Yi, J.-Y. Lee and G.-J. Park, Crashworthiness design optimization using equivalent static loads, *Proceedings of the Institution of Mechanical Engineers, Part D : Journal of Automobile Engineering*, 226, 2012.