



HAL
open science

Crossovers get a boost in [i]Brassica[/i] allotriploid and allotetraploid hybrids

Martine Leflon, Laurie Grandont, Frederique Eber, Virginie Huteau, Olivier Coriton, Liudmila Chelysheva, Eric Jenczewski, Anne-Marie Chèvre

► **To cite this version:**

Martine Leflon, Laurie Grandont, Frederique Eber, Virginie Huteau, Olivier Coriton, et al.. Crossovers get a boost in [i]Brassica[/i] allotriploid and allotetraploid hybrids. *The Plant cell*, 2010, 22 (7), pp.2253-2264. 10.1105/tpc.110.075986 . hal-01203949

HAL Id: hal-01203949

<https://hal.science/hal-01203949>

Submitted on 31 May 2020

HAL is a multi-disciplinary open access archive for the deposit and dissemination of scientific research documents, whether they are published or not. The documents may come from teaching and research institutions in France or abroad, or from public or private research centers.

L'archive ouverte pluridisciplinaire **HAL**, est destinée au dépôt et à la diffusion de documents scientifiques de niveau recherche, publiés ou non, émanant des établissements d'enseignement et de recherche français ou étrangers, des laboratoires publics ou privés.

Crossovers Get a Boost in *Brassica* Allotriploid and Allotetraploid Hybrids
Martine Leflon, Laurie Grandont, Frédérique Eber, Virginie Huteau, Olivier Coriton, Liudmila
Chelysheva, Eric Jenczewski and Anne-Marie Chèvre
Plant Cell 2010;22;2253-2264; originally published online July 9, 2010;
DOI 10.1105/tpc.110.075986

This information is current as of October 3, 2013

Supplemental Data	http://www.plantcell.org/content/suppl/2010/06/24/tpc.110.075986.DC1.html
References	This article cites 50 articles, 9 of which can be accessed free at: http://www.plantcell.org/content/22/7/2253.full.html#ref-list-1
Permissions	https://www.copyright.com/ccc/openurl.do?sid=pd_hw1532298X&issn=1532298X&WT.mc_id=pd_hw1532298X
eTOCs	Sign up for eTOCs at: http://www.plantcell.org/cgi/alerts/ctmain
CiteTrack Alerts	Sign up for CiteTrack Alerts at: http://www.plantcell.org/cgi/alerts/ctmain
Subscription Information	Subscription Information for <i>The Plant Cell</i> and <i>Plant Physiology</i> is available at: http://www.aspb.org/publications/subscriptions.cfm

Crossovers Get a Boost in *Brassica* Allotriploid and Allotetraploid Hybrids ^W

Martine Leflon,^{a,1,2} Laurie Grandont,^{b,1} Frédérique Eber,^a Virginie Huteau,^a Olivier Coriton,^a Liudmila Chelysheva,^b Eric Jenczewski,^b and Anne-Marie Chèvre^{a,3}

^a Institut National de la Recherche Agronomique, Unité Mixte de Recherche 118, Amélioration des Plantes et Biotechnologies Végétales, BP 35327, F-35653 Le Rheu cedex, France

^b Institut Jean-Pierre Bourgin, Unité Mixte de Recherche 1318 Institut National de la Recherche Agronomique–AgroParisTech, Bâtiment 7, Institut National de la Recherche Agronomique Centre de Versailles-Grignon, 78026 Versailles cedex, France

Meiotic crossovers are necessary to generate balanced gametes and to increase genetic diversity. Even if crossover number is usually constrained, recent results suggest that manipulating karyotype composition could be a new way to increase crossover frequency in plants. In this study, we explored this hypothesis by analyzing the extent of crossover variation in a set of related diploid AA, allotriploid AAC, and allotetraploid AAC *Brassica* hybrids. We first used cytogenetic methods to describe the meiotic behavior of the different hybrids. We then combined a cytogenetic estimation of class I crossovers in the entire genome by immunolocalization of a key protein, MutL Homolog1, which forms distinct foci on meiotic chromosomes, with genetic analyses to specifically compare crossover rates between one pair of chromosomes in the different hybrids. Our results showed that the number of crossovers in the allotriploid AAC hybrid was higher than in the diploid AA hybrid. Accordingly, the allotetraploid AAC hybrid showed an intermediate behavior. We demonstrated that this increase was related to hybrid karyotype composition (diploid versus allotriploid versus allotetraploid) and that interference was maintained in the AAC hybrids. These results could provide another efficient way to manipulate recombination in traditional breeding and genetic studies.

INTRODUCTION

Meiosis and recombination are essential to the life cycles of all sexual eukaryotes. Meiosis is a two-round cell division during which chromosome number is halved (from diploid to haploid) and gametes are generated. In most organisms, accurate separation of maternal and paternal chromosomes during the first division requires that they first be connected to one another by crossovers. Crossovers are one of the products of meiotic double-strand break repair, which occurs during prophase I. This connection is established by the exchange of homologous chromatid arms (manifested as cytological features called chiasmata) plus cohesion between sister chromatids, which are both essential for proper attachment of bipolar homologs to the meiosis I spindle (Whitby, 2005). In addition, crossovers produce new combinations of chromosomes/alleles at different genetic loci, thereby boosting genome variability.

The number and distribution of crossovers during meiosis are subject to very stringent controls (Mézard et al., 2007). Typically, every chromosome undergoes at least one obligate crossover to ensure proper segregation at metaphase I (Jones, 1984). The total number and relative position of crossovers on each chromosome are then limited by a phenomenon called interference (i.e., a crossover in one region reduces the probability that a second crossover occurs simultaneously in an adjacent region, so that the distance between crossovers is larger than would be expected if they occurred independently; Muller, 1916; Jones, 1984). Formation of interfering crossovers (class I crossovers) is catalyzed by a set of specific meiotic proteins called ZMM (for Zip1, Zip2, Zip3, Zip4, Mer3, and Msh4/Msh5; Lynn et al., 2007) and depends on MutL Homolog1 (MLH1; Lhuissier et al., 2007). Not all crossovers are affected by interference; a second class of noninterfering crossovers is catalyzed by other proteins, such as Methyl methanesulfonate and UV Sensitive 81 (MUS81), that are responsible for 15 to 30% of all crossovers (see Mézard et al., 2007, for review). The net result of crossover control is at least one (obligate) crossover per chromosome and a tendency for multiple crossovers (more than two) to be rare.

The possibility of increasing crossover frequency has attracted considerable interest because of the obvious practical applications in traditional breeding and genetic studies. Boosting crossovers would effectively speed up the combining of valuable traits from different parents in new elite varieties (Wijnker and de Jong, 2008), accelerate the removal of linkage drag during the introgression of valuable genes from exotic germplasms (Able and

¹ These authors contributed equally to this work.

² Current address: Centre Technique Interprofessionnel des Oléagineux Métropolitains, Direction scientifique, Avenue Lucien Brétignières, Campus de Grignon, F-78850 Thiverval Grignon, France.

³ Address correspondence to chevre@rennes.inra.fr.

The author responsible for distribution of materials integral to the findings presented in this article in accordance with the policy described in the Instructions for Authors (www.plantcell.org) is: Anne-Marie Chèvre (chevre@rennes.inra.fr).

^WThe online version of this article contains Web-only data.
www.plantcell.org/cgi/doi/10.1105/tpc.110.075986

Langridge, 2006; Martinez-Perez and Moore, 2008), and facilitate the construction of highly recombinogenic lines and thus help improve genetic maps and positional cloning techniques. Recently, Carlton et al. (2006) showed that the presence of a single pair of univalents during meiosis of *Caenorhabditis elegans* induces a compensatory increase in crossovers on the recombining chromosomes involved in bivalents of the same nuclei. This observation is in agreement with at least two studies in plants (Parker, 1975; Tease and Jones, 1975). It suggests that chromosomes that carry early recombination intermediates but ultimately fail to form a crossover may cause “the nucleus to linger in a recombination active state,” in which a higher number of crossovers can be completed on the chromosomes that were correctly synapsed (Martinez-Perez and Moore, 2008). Thus, an important direction that studies should take is to analyze the effect of univalents on the frequency of meiotic recombination among the remaining chromosomes. Interspecific hybrids, in which the number of chromosomes that fail to form crossovers can be finely tuned, provide a good way to address this question.

In this study, we analyzed the extent of crossover variation in different closely related *Brassica* hybrids: a diploid hybrid that undergoes regular meiosis without univalents; a newly formed allotetraploid hybrid that, in theory, can form a few univalents and multivalents; and a digenomic allotriploid hybrid in which systematic univalents are expected. We characterized the meiotic behavior of the diploid, allotriploid, and allotetraploid hybrids produced from the same *Brassica rapa* genotypes by using different cytogenetic methods (classical techniques and BAC-FISH [for fluorescent in situ hybridization] analyses). We then compared crossover rates between pairs of homologous chromosomes in these hybrids using two independent and complementary methods: the number of class I crossovers in the entire genome was counted using a cytogenetic approach, and genetic distances were used to infer the number of crossovers between one pair of A chromosomes (class I and II). We showed that crossover rates were significantly higher in the allotetraploid hybrid than in the diploid hybrid and were highest in the allotriploid hybrid. Our results also indicated that crossovers remained affected by interference at meiosis of the allotriploid hybrids, in spite of the high frequency of multiple crossovers per chromatid observed in this hybrid. These results are important because they provide another way to manipulate (some of) the mechanisms determining the rate of crossovers and/or to use them in plant breeding programs.

RESULTS

Meiotic Behavior in Hybrids

As a first step to analyze the extent of crossover variation in relation to karyotype composition in *Brassica* hybrids, we investigated meiotic behavior at prophase I of diploid (A_rA_r), allotetraploid ($A_rA_rC_oC_o$), and allotriploid ($A_rA_rC_o$) hybrids produced from the same *B. rapa* genotypes (Figure 1). We examined meiotic stages by DNA staining of pollen mother cells (PMCs) undergoing meiosis, and we also used BAC-FISH to specifically identify chromosomes from the A and C genomes (see Supplemental Figures 1 and 2 online).

Meiosis of the diploid hybrid (A_rA_r) appeared normal and very regular (see Supplemental Figure 1 online). At diakinesis, 10 bivalent structures were always observed, where chromosomes were maintained together by sister chromatid cohesion and chiasmata. Although bivalent configurations could be classified into several categories, the majority (four to five on average) were ring bivalents, with their two arms bound by chiasmata (see Supplemental Figures 1D and 1E online). Assuming that most other configurations resulted from a single chiasma, we estimated that there were 1.2 to 1.7 crossovers on average on every bivalent.

In the allotetraploid $A_rA_rC_oC_o$ hybrid, the early stages of prophase I could not be distinguished from those in the diploid hybrid. We only observed a few cells with multiple alignments at pachytene (see Supplemental Figure 1G online) and chiasmatic multivalents at diakinesis (see Supplemental Figure 1H online) and metaphase I (Table 1). Approximately 70% of the PMCs displayed 19 bivalents, as expected (Table 1). The BAC-FISH analyses confirmed that bivalents were mostly formed between pairs of A and pairs of C chromosomes (see Supplemental Table 1 and Supplemental Figures 2A and 2B online), in spite of some occasional recombination between homeologous chromosomes (see Supplemental Figures 2C and 2D online). One notable feature of meiosis in the allotetraploid $A_rA_rC_oC_o$ hybrid was the presence of one to three bivalents per PMC that had an atypical compact appearance (see Supplemental Figures 1H and 1I online), as if they were more intimately linked than in the diploid hybrid.

Meiosis of the $A_rA_rC_o$ allotriploid hybrid was obviously disrupted during prophase I. As expected from the uneven number of chromosomes in this hybrid (29), some chromosomes remained as univalents at pachytene (see Supplemental Figure 1J online). At diakinesis, it was sometimes difficult to distinguish bivalents from univalents because the bivalent-like entities displayed a very unusual compact appearance (see Supplemental Figures 1K and 1L online). In particular, we only rarely identified ring bivalents with one terminal chiasma recognizable in each arm at diakinesis. At metaphase I, ~70% of the cells examined in the $A_rA_rC_o$ hybrid displayed 9 univalents and 10 bivalents (Table 1). The BAC-FISH analyses showed that bivalents were mostly formed by A chromosomes but not exclusively: illegitimate recombination occasionally occurred between A and C chromosomes or even between two C chromosomes (see Supplemental Table 1 and Supplemental Figures 2E and 2F online).

Although it was not possible to reliably estimate chiasma frequencies in the allotetraploid and the allotriploid hybrids, all our observations suggested that bivalents were bound by more crossovers in the allotetraploid and allotriploid hybrids than in the diploid hybrid. Cytogenetic and genetic analyses were thus performed to quantify the difference in crossover rates among the different hybrids.

Estimation of Crossover Rates in the Diploid, Allotriploid, and Allotetraploid Hybrids

Crossover rates were estimated in two independent and complementary ways, by cytologically counting the number of crossovers and by examination of genetic distances. First, we used an

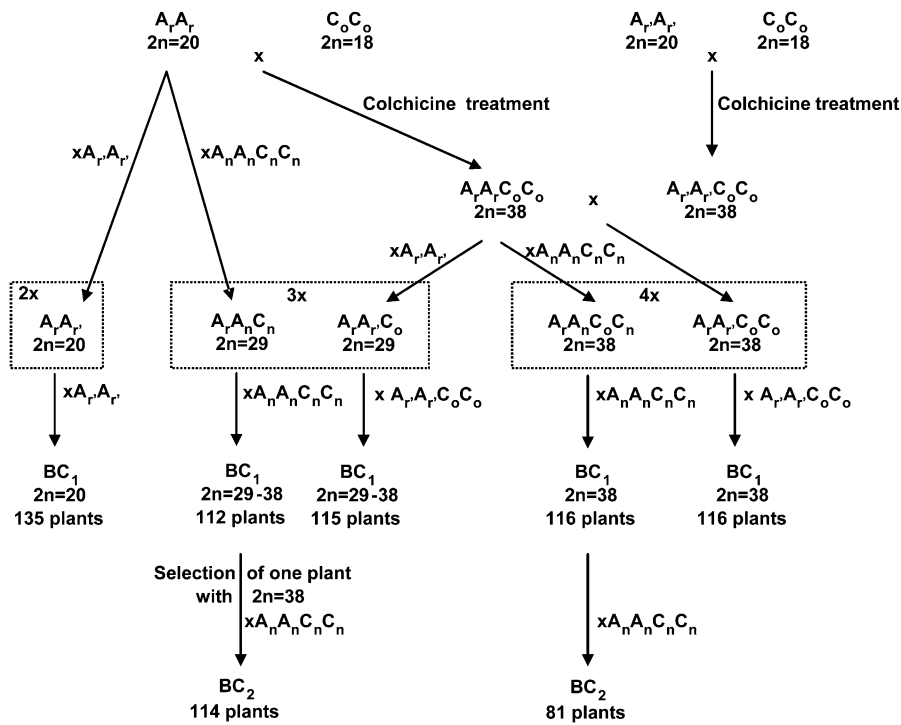

Figure 1. Schematic Detailing the Production of Hybrids and Segregating Backcross Populations.

$A_r A_r$ and $A_r A_r$ represent the C1.3 and Z1 *B. rapa* plants, respectively, $C_o C_o$ designates the *B. oleracea* cultivars (RC and HDEM), and $A_r A_n C_n C_n$ stands for the *B. napus* cv Darmor. The genomic structure of F1 hybrids is shown in dotted boxes (2x, 3x, or 4x for diploid, allotriploid, or allotetraploid, respectively).

anti-*Arabidopsis thaliana* MLH1 antibody to determine interfering crossover frequencies. MLH1 is one of the eukaryotic homologs of *Escherichia coli* MutL, which is essential for wild-type levels of crossing over in budding yeast, mammals, and plants (Lhuissier et al., 2007, and refs. therein). In *Arabidopsis*, immunolocalization of MLH1 antibodies in diakinesis PMCs reveals distinct foci on chromatin, which correspond to positions of interfering (class I) crossovers (Chelysheva et al., 2010). In order to compare the numbers of MLH1 foci in all hybrids, in which not only bivalents but also an additional number of multivalents were observed (Table 1), we chose to relate the number of MLH1 foci to the number of “recombining chromosomes”; this number was esti-

mated in every PMC by dividing the total number of MLH1 foci by the number of chromosomes involved in recombination events (i.e., that showed at least one MLH1 focus).

The diploid hybrid $A_r A_r$ showed on average 16.5 MLH1 foci per nucleus (1.65 crossovers per bivalent), which is in close agreement with our chiasma estimation from 4',6-diamidino-2-phenylindole (DAPI) observations. As only bivalents were observed at diakinesis of the diploid hybrid, the mean number of MLH1 foci per recombining chromosome was 0.83 (Figures 2A–2C, Table 2). In the allotetraploid hybrid ($A_r A_r C_o C_o$), we counted an average of 37.6 MLH1 foci per PMC, which corresponded to 1.0 foci per recombining chromosome (Figures 2D–2F, Table 2). This

Table 1. Average Meiotic Behavior at Metaphase I of AAC and AACC Hybrids

Hybrids ^a	No. of Chromosomes	No. of PMCs	Average No. of ^b			
			I	II	III	IV
$A_r A_r C_o C_o$	38	41	0.19 (0–2)	18.56 (17–19)	0.00	0.17 (0–1)
$A_r A_n C_o C_n$	38	21	0.24 (0–2)	18.33 (17–19)	0.05 (0–1)	0.24 (0–1)
$A_r A_r C_o$	29	62	8.79 (5–11)	10.00 (7–11)	0.05 (0–1)	0.02 (0–1)
$A_r A_n C_n$	29	23	8.62 (6–11)	10.05 (9–11)	0.09 (0–1)	0.00

Values in parentheses indicate the range of variation.

^aHybrids produced using the two *B. rapa* genotypes ($A_r A_r C_o C_o$ and $A_r A_r C_o$) are distinguished from those derived using *B. napus* cv Darmor ($A_r A_n C_o C_n$ and $A_r A_n C_n$).

^bI stands for univalents, II for bivalents, III for trivalents, and IV for quadrivalents.

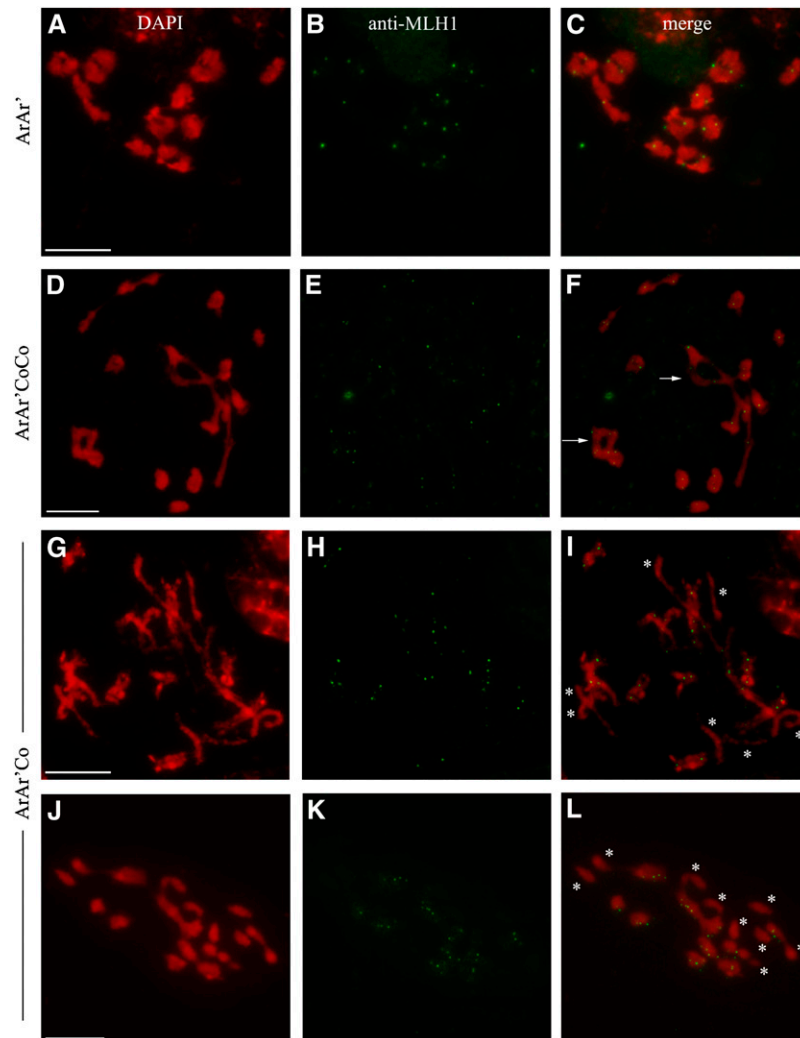

Figure 2. MLH1 Immunolocalization in PMCs of the A_rA_r Diploid (**[A]–[C]**), $A_rA_rC_oC_o$ Allotetraploid (**[D]–[F]**), and $A_rA_rC_o$ Allotriploid (**[G]–[L]**) Hybrids.

Chromosomes at diakinesis stage were stained with DAPI (red) and the *Arabidopsis* MLH1 antibody (green). **(C)**, **(F)**, **(I)**, and **(L)** were generated by merging DAPI and anti-MLH1. Arrows indicate multivalents, and asterisks show univalents. Bars = 10 μ m.

difference was statistically significant from that in the diploid hybrid (one-way analysis of variance; $P = 0.0082$), representing a 1.2-fold increase in the class I crossover rate. In the allotriploid hybrid, 6 to 10 chromosomes without MLH1 foci (Figures 2I–2L, asterisks) were systematically observed in the PMCs, which corresponded to univalents. An average of 29.3 MLH1 foci per nucleus was scored in the allotriploid hybrid ($A_rA_rC_o$), which corresponded to 1.40 foci per recombining chromosome (Figures 2G–2L, Table 2). This was a 1.7-fold increase (one-way analysis of variance; $P < 0.0001$) in the class I crossover rate compared with the diploid and hybrids and a 1.4-fold increase compared with the allotetraploids. Interestingly, in every nucleus of the allotriploid hybrids, at least five bivalents showed more than two foci, and three to four bivalents repeatedly showed four MLH1 foci (Figures 2I, early diakinesis, and 2L, late diakinesis), whereas in the diploid hybrid, bivalents showed only one or two foci. Together, these findings indicated a genome-wide increase

in class I crossover rate in the allotetraploid hybrid and an even bigger increase in the allotriploid hybrid compared with the diploid hybrid.

For the second estimation of crossover rates, we compared genetic map lengths to account for the two classes of crossovers. Comparisons of genetic map lengths were performed using three backcross (BC) progeny that were genotyped with 18 to 19 polymorphic markers positioned along linkage group A7. These comparisons were justified and reliable because we used identical A genotypes and markers to construct the linkage maps.

Map distances were much higher in the progeny of the allotetraploid hybrid ($A_rA_rC_oC_o$) compared with that of the diploid hybrid (A_rA_r). The same molecular markers collectively expanded the total length of linkage group A7 from 52 centimorgan (cM; in the progeny of the diploid hybrid A_rA_r) to 96 cM (in the progeny of the allotetraploid hybrid $A_rA_rC_oC_o$; Figure 3). The

Table 2. Average Number of MLH1 Foci at Diakinesis of the A_rA_r , $A_rA_rC_oC_o$, and $A_rA_rC_o$ Hybrids

Hybrids	No. of PMC	Average No. of MLH1 Foci	Average No. of MLH1 Foci per Recombining Chromosome ^a
A_rA_r	8	16.5 (14–19)	0.83 (0.70–0.95)
$A_rA_rC_oC_o$	22	37.6 (29–46)	1.00 (0.76–1.21)
$A_rA_rC_o$	45	29.3 (23–36)	1.40 (1.09–1.89)

Values in parentheses indicate the range of variation.

^aFor each PMC, the average number of MLH1 foci per recombining chromosome was estimated by dividing the total number of MLH1 foci by the number of chromosomes showing at least one MLH1 focus.

proportion of crossovers in $A_rA_rC_oC_o$ was on average 1.9 fold higher than in A_rA_r , with significant differences for three of the seven intervals where the χ^2 test was feasible, depending on the number of plants in each class. At the scale of the linkage group, considered as a combination of intervals with or without crossovers, the difference between the two hybrids was highly significant (χ^2 test, $df = 10$, $P = 5.5e-5$).

Map distances were even larger in the progeny of the allotriploid hybrid ($A_rA_rC_o$), in which the A7 linkage group was 224 cM long (Figure 3). In addition, two molecular markers (E36M73.403 and E44M66.277), located at the very end of A7, remained unlinked in the $A_rA_rC_o$ hybrid progeny. The proportion of crossovers in the $A_rA_rC_o$ hybrid, calculated for every interval between adjacent markers on A7, was on average 6.1-fold higher than in the A_rA_r hybrid (with significant differences observed for the 12 intervals for which a χ^2 test was feasible) and 3.1-fold higher than in $A_rA_rC_oC_o$ (with significant differences for 9 of the 13 intervals for which a χ^2 test was feasible). At the scale of the linkage group, considered as a combination of intervals with or without crossovers, the differences were highly significant between the $A_rA_rC_o$ and A_rA_r hybrids (χ^2 test, $df = 13$, $P = 4.6e-58$) or between the $A_rA_rC_o$ and $A_rA_rC_oC_o$ (χ^2 test, $df = 12$, $P = 2.6e-27$).

It is obvious from our results that genetic map length expansions were higher than chiasma count increases. These discrepancies were not due to experimental error in classifying marker data (Lincoln and Lander, 1992). As misclassifications usually result from markers that appear recombined with both flanking markers, we removed all singletons from the data set, even if some were double checked. The genetic maps obtained for the allotetraploid and allotriploid hybrids with corrected data points still remained inflated compared with chiasma counts. Likewise, genetic map inflation was not related to marker type; removing AFLP markers did not change the extent of the increase between the different maps. Therefore, we are confident that our genetic data are sound.

Our combined cytogenetic and genetic analyses thus demonstrated that crossovers get a boost in the allotetraploid and allotriploid hybrids produced from the *B. rapa* genotypes (Figure 1). We then examined whether map distance expansions still occurred when the A and C genomes are from different genotypes.

For this, we first reanalyzed some of the data presented by Nicolas et al. (2009) and compared crossover rates between allotriploid ($A_rA_nC_n$) and allotetraploid ($A_rA_nC_oC_n$) interspecific

hybrids produced by crossing either *B. rapa* C1.3 or synthetic *Brassica napus* RCC to natural *B. napus* cv Darmor. At metaphase I, the meiotic configurations of these hybrids were very similar to the allotriploid and allotetraploid hybrids previously described (Table 1). The genetic sizes of the A7 linkage group, based on 12 markers, varied from 54 cM in the BC1 progeny of the allotetraploid hybrid to 239 cM in the BC1 progeny of the corresponding allotriploid hybrid. Although no corresponding diploid control was available, this result confirmed that crossovers get a boost in the allotriploid hybrid compared with the allotetraploid hybrid, irrespective of the origin of the A and C genomes.

Finally, we investigated whether karyotype composition (allotriploid versus allotetraploid) was the major cause of map distance expansion by analyzing genetic distances in two BC₂ progeny. These were produced from two BC1 plants with the same genomic structure ($2n = 38$) but derived from the progeny of either an allotriploid or an allotetraploid hybrid with the *B. napus* cv Darmor as parent (Figure 1). The genetic sizes of the A7 linkage group were 75.4 cM (using only 10 markers) and 86 cM (using 12 markers) in the two BC₂ progeny (see Supplemental Figure 3 online). At the linkage group scale as well as at the interval scale, crossover rates were similar in the two BC2 progeny. At the interval scale, crossover rates in the two BC2 progeny were similar and appeared slightly higher than in the allotetraploid BC1 progeny for two of the three intervals where the χ^2 test was feasible (χ^2 test, $df = 2$, $P = 0.032$ and $P = 0.037$) and lower than in the allotriploid BC1 progeny for the four intervals for which a test was feasible (Figure 4).

These findings confirmed that crossover rates increased as a result of karyotype composition (allotriploid versus allotetraploid). One manifestation of this increase was the occurrence of multiple crossovers per bivalent (Figure 2). Genetic data indicated that the mean number of exchange points per chromatid was 3.0 in the $A_rA_rC_o$ hybrid compared with 0.5 in the A_rA_r hybrid and 0.9 in the $A_rA_rC_oC_o$ hybrid (see Supplemental Figure 4 online). Likewise, the mean number of exchange points per chromatid in the other genetic background was 1.7 (ranging from 0 to 3) in the $A_rA_nC_n$ hybrid compared with 0.5 (ranging from 0 to 2) in the $A_rA_nC_oC_n$ hybrid. This increase in the number of crossovers per chromatid led us to investigate whether these multiple crossovers were still affected by interference.

Analysis of Crossover Interference in the Progeny of $A_rA_rC_o$ and $A_rA_nC_n$ Hybrids

The distance between adjacent crossovers, expressed as the percentage of crossovers observed in this interval over the whole population, was calculated for every chromatid showing at least two crossovers. This analysis could only be performed using the progeny of the allotriploid hybrids, because the number of multiple crossovers in the populations derived from diploid and allotetraploid hybrids was too low for statistical analyses. We calculated 230 and 88 distances in the progeny of $A_rA_rC_o$ and $A_rA_nC_n$, respectively. The distributions of these observed genetic distances between adjacent crossovers were significantly different ($\alpha = 5\%$) from the distributions expected if the position of one crossover was independent of the location of the other one

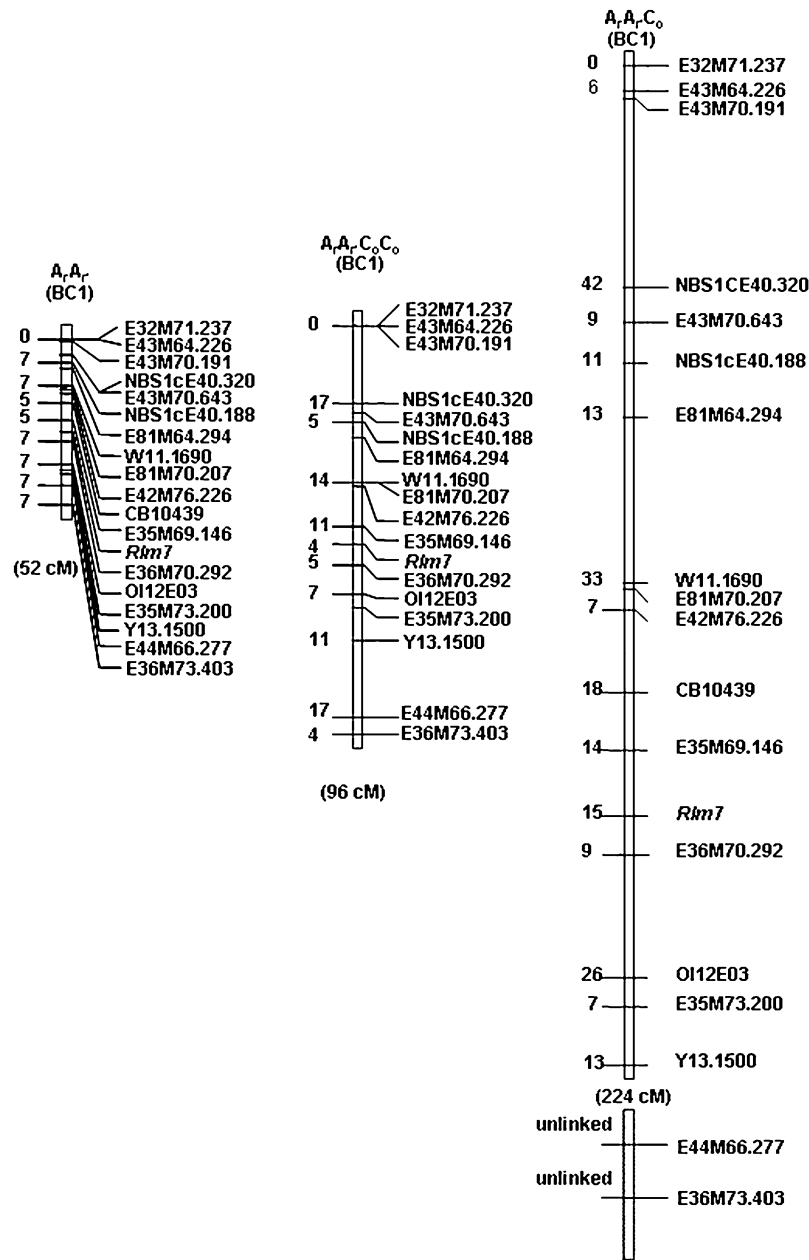

Figure 3. Maps of the A7 Linkage Group in Progeny of the Diploid (A_rA_r), Allotriploid ($A_rA_rC_o$), and Allotetraploid ($A_rA_rC_oC_o$) Hybrids. Genetic distances, indicated on the left of the linkage group, are expressed in cM and represent the distance between the marker and the annotated marker immediately above.

(s) (Figure 5). In particular, the shortest distances (from 0 to 25 cM) were observed at frequencies 4.3- to 5.2-fold lower than expected in the progeny of $A_rA_nC_n$ and $A_rA_rC_o$, respectively. Likewise, on the 22 intervals of the linkage group that were shorter than 40 cM and carried at least three markers, only 18 and 12 double crossover events were observed in $A_rA_rC_o$ and $A_rA_nC_n$, respectively, whereas 44 and 26 events were expected, respectively, if there was no interference. These two analyses led to the same conclusion: that multiple crossovers were not

located independently from one another. Therefore, interference was still affecting crossover distribution even if multiple crossovers occurred very frequently.

DISCUSSION

Variations in the number of crossovers depend on environmental (e.g., temperature; Francis et al., 2007), developmental (Francis et al., 2007), sex-specific (Drouaud et al., 2007), genetic (Robbins

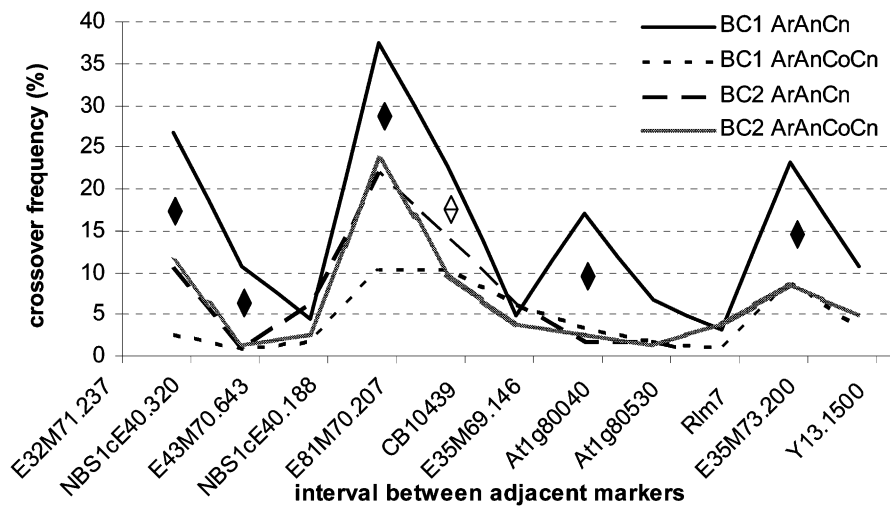

Figure 4. Crossover Rates in Allotriploid and Allotetraploid Hybrids and BC1 Progeny along the A7 Linkage Group.

Black diamonds indicate that the crossover frequency (as measured by the proportion of plants showing recombination for each interval) estimated in the BC1 progeny of $A_rA_nC_n$ differed from that estimated using any of the other three progeny. White diamonds indicate that crossover frequencies in the BC1 progeny of $A_rA_nC_n$ are significantly different from both BC1 and BC2 progeny of $A_rA_nC_nC_n$ but not significantly different from the BC2 progeny of $A_rA_nC_n$. See Figure 1 for BC1 progeny lineage. A False Discovery Rate correction was applied to account for pairwise multiple comparisons.

et al., 1995; Sanchez-Moran et al., 2002; Esch et al., 2007), or genomic (Dvorak et al., 1998; Barth et al., 2001; Dooner, 2002) cues. It was recently shown that when some chromosomes in a nucleus fail to form crossovers, this may lead to a compensatory increase in crossovers on other recombining chromosomes (Carlton et al., 2006). Based on this result, which echoed older work on *Crepis capillaris* and in *Hypochoeris radicata* (Parker, 1975; Tease and Jones, 1975), new ways can be envisaged to manipulate recombination in plants. In this study, we explored this prospect by analyzing meiotic recombination in allotriploid and allotetraploid *Brassica* hybrids.

Our cytogenetic and genetic data demonstrate in two independent ways that crossover rate increases from the diploid to the allotetraploid hybrids and from the allotetraploid to the allotriploid hybrids. This increase is not sex-specific, as it was detected in both male (cytogenetic survey) and female (genetic survey) meiosis. Considering that genetic map length expansions (Figure 3) were higher than chiasma count increases (Table 2), it could be hypothesized that crossovers get a higher boost during female as compared with male meiosis. This hypothesis remains tentative, and several alternative explanations could be proposed.

First, using MLH1 immunolocalization, we observed only interfering (class I) crossovers, whereas with genetic analyses, we observed the results of both interfering and noninterfering crossovers. It is possible, therefore, that the number of noninterfering crossovers got a boost in the allotetraploid and allotriploid hybrids, which would increase the genetic maps without increasing the number of MLH1 foci. This hypothesis is difficult to test, because it is not possible to specifically label noninterfering crossovers; for example, although antibodies were successfully raised against *Arabidopsis* MUS81 (upon which noninterfering crossovers depend), the number of MUS81 foci seems to exceed the number of noninterfering crossovers expected in *Arabidopsis*

(Higgins et al., 2008). In addition, the occurrence of residual crossovers in the yeast and *Arabidopsis msh4 mus81* double mutants suggests that a third recombination pathway exists (activated in a double mutant background at least), which has not yet been characterized (Whitby, 2005; Higgins et al., 2008). However, if noninterfering crossovers were responsible, we would have observed many bivalents with chiasmata not labeled with MLH1, which we did not. Likewise, our genetic analyses showed that interference was still constraining crossover distribution during meiosis in allotriploid *Brassica* hybrids, although we do not have sufficient statistical power to determine if the interference level varied between the hybrids.

Second, the ability to form an increased number of crossovers could be different between bivalents. Cytogenetic observations showed that MLH1 foci were not homogeneously distributed between bivalents at meiosis in the allotriploid hybrid. In each nucleus, some bivalents appeared linked by four crossovers, whereas other bivalents showed no more than two crossovers (Figure 2). Thus, the bivalent corresponding to linkage group A7 could be one of the highly recombinant chromosome pairs. In that case, the genetic distances on A7 should be compared with the highest numbers of MLH1 foci observed on a chromosome pair. Unfortunately, it was not possible to test this hypothesis by BAC-FISH labeling A7 specifically at meiosis because of the whole genome triplication that occurred after the *Arabidopsis*-*Brassicaceae* split (Lysak et al., 2005). It must also be emphasized that the nonhomogeneous distribution of crossovers between bivalents could also be explained, at least in part, by the occurrence of CC and AC bivalents (see Supplemental Table 1 online) that were formed between divergent chromosomes and therefore should display fewer MLH1 foci.

Finally, increased map length expansion could reflect gametic selection, which usually favors balanced gametes. It is usually

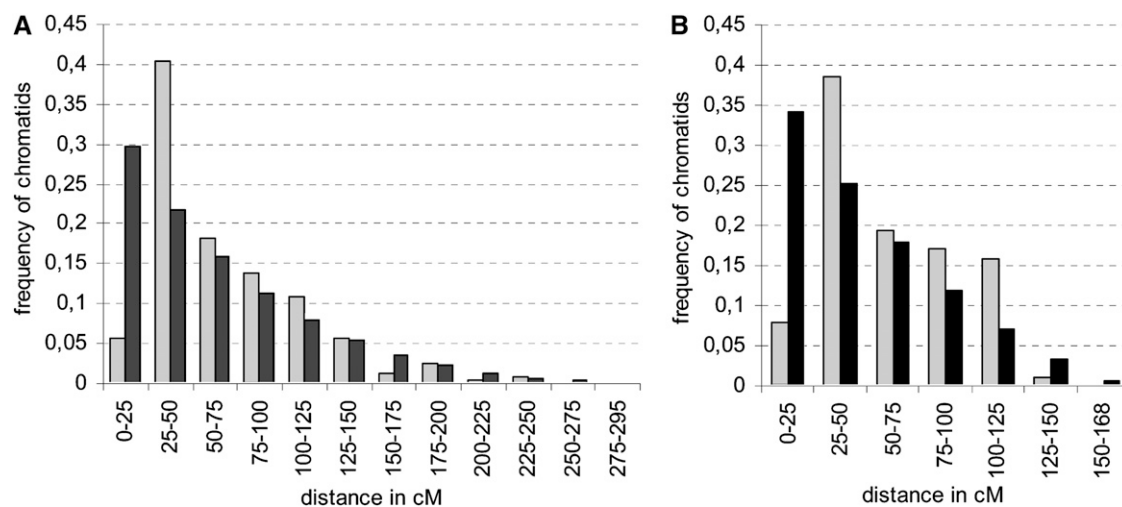

Figure 5. Distribution of the Distances between Adjacent Crossovers Expressed in cM.

The histograms in black represent the theoretical distribution, which assumes that the positions of multiple (more than one) crossovers are independent from one another. The histogram in gray represents the observed distribution in the BC1 progeny of $A_rA_rC_o$ (A) or $A_rA_nC_n$ (B) hybrids.

assumed that recombinant gametes are selected when pairing failure occurs, because this would increase the chance of producing balanced gametes. This would result in an increase in the overall frequency of recombinant progeny relative to the crossover rate (Canady et al., 2006). “Pairing failure” is limited in the allotriploid and allotetraploid hybrids (Table 1), which certainly reduces the role of gametic selection in our material.

Thus, although we cannot conclude which of these (or combination of) factors explained the variation in amplitude, the crossover rate clearly increases in the allotetraploid and allotriploid hybrids (Figure 2, Table 2; see Supplemental Figure 1 online), irrespective of the origin of the A and C genomes. We effectively observed that a similar increase in crossover rates occurred between allotriploid and allotetraploid hybrids produced with *B. napus* cv Darmor (Nicolas et al., 2009), indicating that the A_r , A_n , C_o , and C_n genomes did not significantly alter this outcome. This does not mean that genotypic variation cannot introduce additional variation in the number of crossovers that can be formed; comparing the genetic length of A7 estimated in the BC1 progeny of the $A_rA_rC_oC_o$ (75.4 cM) and $A_rA_nC_oC_n$ (50 cM) allotetraploid hybrids using the same nine markers indicated that there were significantly fewer crossovers when *B. napus* cv Darmor is used as parent. It rather indicates that, using the same haploid complements from the same two genotypes, varying karyotype composition (allotriploid versus allotetraploid) was a reliable cause of crossover rate increase. This is consistent with other published observations. For example, different allotriploid *Lolium* hybrids showed more chiasmata per cell than the corresponding diploid hybrids (Gymer and Whittington, 1975; Jenkins, 1985a, 1985b, 1986). Likewise, a comparison of genetic maps between diploid and allotetraploid *Gossypium* (Brubaker et al., 1999; Desai et al., 2006) and *Brassica* (Suwabe et al., 2008) species showed larger genetic lengths in the allotetraploid than in their diploid counterparts (however, for *Brassica*, see Ferreira et al., 1994; Teutonico and Osborn, 1994; Parkin et al., 1995). A

few counterexamples were also reported. White and Jenkins (1988) and Jenkins and White (1988) observed that chiasma frequency was higher in *Scilla autumnalis* allotetraploid hybrids than in the corresponding allotriploid hybrid. Thus, variations in crossover rate according to karyotype structure may be lineage-dependent.

As yet, we do not know the genetic/genomic basis for the increase in crossovers in allotetraploid and allotriploid hybrids; however, some potential causes seem improbable. It is very unlikely that recombination between *Brassica* homeologous chromosomes would have resulted in a net increase in recombinant chromosomes, as proposed in allotriploid interspecific *Festuca* × *Lolium* hybrids (Thomas et al., 1988; Zwierzykowski et al., 1999). Although the frequent trivalents observed at meiosis in the *Festuca* × *Lolium* hybrids effectively led to chromosomes with additional interstitial break points in the progeny (Zwierzykowski et al., 1999), the situation is clearly different in our study. Homeologous recombination rarely occurred between A and C chromosomes in the allotetraploid and allotriploid *Brassica* hybrids we analyzed (Table 1; see Supplemental Table 1 and Supplemental Figure 2 online).

As an alternative, it is tempting to link the higher number of crossovers observed in the allotriploid hybrid to the occurrence of chromosomes that remain as univalents (Table 1; Leflon et al., 2006). This interpretation is consistent with previous reports (Parker, 1975; Tease and Jones, 1975; Carlton et al., 2006) in which chromosome-specific desynaptic “mutants” showed a compensatory increase in crossover frequency among unaffected bivalents. In all these studies, the magnitude of the compensatory effect was generally small and roughly correlated to the relative proportion of chromosomes that remained as univalents. Most commonly, affected meiocytes contained just one pair of univalents at meiosis, and the compensating increase in chiasma frequencies on the remaining two to three bivalents approximated 25 to 30%. In our study, the increase in crossover

frequency was greater, which was probably associated with the fact that a larger number of chromosomes remained unpaired during meiosis in the allotriploid hybrids.

The situation is less straightforward for the allotetraploid hybrid, in which the presence of only a few univalents does not satisfactorily explain the observed increase in crossover frequency. In this hybrid, our results suggest that the change in ploidy is associated with an increase in recombination. This hypothesis is consistent with the previous reports mentioned above (Brubaker et al., 1999; Desai et al., 2006; Suwabe et al., 2008), suggesting that this could be a general trend. If this is true, then ploidy-related crossover increases would have profound implications in both the fields of evolutionary science and agricultural research, because polyploidy represents a hallmark in plant evolution (Soltis et al., 2009; Wood et al., 2009).

In *C. elegans*, Carlton et al. (2006) showed that increased crossover rates were associated with delayed meiotic progression, presumably due to the presence of unrepaired double-strand breaks. These authors observed that this delay resulted in the Rad51 recombinase persisting for longer than usual on chromosomes and proposed that this may allow supernumerary crossovers to form. Likewise, Wang et al. (2010) recently reported that in a rice (*Oryza sativa*) mutant for the central element protein ZEP1 of the synaptonemal complex, MER3, a component of the interfering crossover pathway, persisted for longer and crossover frequency increased. Therefore, these findings suggest that future studies should be directed toward investigating the control of meiotic progression (Martinez-Perez and Moore, 2008) as well as meiotic protein dynamics. This would especially be of interest in crop plants, where the appearance/disappearance of meiotic proteins could alter the recombination pattern across the genome. We expect that such analyses will soon be possible in diploid, allotetraploid, and allotriploid *Brassica* hybrids, through the development and use of antibodies against meiotic proteins.

METHODS

Plant Materials

The strategy we used to produce hybrids and segregating backcross populations is detailed in Figure 1.

One single plant, C1.3 (A_rA_r , $2n = 20$), was selected within the *Brassica rapa* Chicon variety (an old nonhomogeneous French forage variety) and crossed as the female to a *B. rapa* doubled haploid line (A_rA_r), called Z1 (kindly provided by Agriculture and Agri-Food Canada). The resulting A_rA_r F1 hybrid was then backcrossed as female to Z1, and a progeny of 135 plants was generated.

The same two *B. rapa* plants were crossed, as males, with two *Brassica oleracea* double haploid lines, RC and HDEM (provided by M. Manzanares-Dauleux, Institut National de la Recherche Agronomique Le Rheu). The resulting F1 interspecific A_rC_o and A_rC_o hybrids were colchicine doubled to produce two resynthesized *Brassica napus* plants named RCC ($RC \times C1.3$; $A_rA_rC_oC_o$) and EMZ ($HDEM \times Z1$; $A_rA_rC_oC_o$), respectively. The RCC-resynthesized *B. napus* was then crossed as female to Z1 to produce the $A_rA_rC_o$ hybrid; this allotriploid hybrid, which carried exactly the same pairs of A chromosomes as the former A_rA_r diploid hybrid, was crossed as female to EMZ, and a backcross progeny of 115 plants was produced. The RCC-resynthesized *B. napus* ($A_rA_rC_oC_o$) was crossed as female to EMZ ($A_rA_rC_oC_o$) in order to analyze crossover rates

in allotetraploid hybrids: one single F1 hybrid ($A_rA_rC_oC_o$) was backcrossed as female to EMZ to produce a progeny containing 116 plants.

Two other progeny of 112 and 116 plants, deriving from crosses between Darmor, a winter *B. napus* cultivar ($A_rA_nC_nC_n$), and C1.3 (the hybrid was named $A_rA_nC_n$ in this paper) and between RCC and Darmor (the hybrid was named $A_rA_nC_oC_n$ in this paper), respectively, were also used in this study. This plant material is presented in detail by Nicolas et al. (2009).

Two second-generation backcross progeny were produced by crossing as female one plant from the progeny of the $A_rA_nC_n$ hybrid and one plant from the progeny of the $A_rA_nC_oC_n$ hybrid to Darmor (Figure 1). These two plants were selected from the first-generation backcross progeny, because they contained 38 chromosomes and all the alleles from A_r on one of the analyzed linkage groups (A7).

Meiotic Observation of Backcross Parents

Antibodies

The anti-*Arabidopsis thaliana* MLH1 polyclonal antibody was described by Chelysheva et al. (2010), and the purified serum was used at a dilution of 1:15.

DAPI Observations and MLH1 Immunolocalization

Anthers containing PMCs at prophase I were fixed in 1:3 (v/v) acetic acid: ethanol and stored at -20°C . Then anthers were incubated in 1% acetocarmine for 5 min, and those that were at the correct meiotic stage were squashed in 45% acetic acid. The slides were mounted in DAPI (2 $\mu\text{g}/\text{mL}$) in Vectashield antifade mounting medium. Fluorescence immunolocalization of MLH1 was performed on squashes according to the method described by Chelysheva et al. (2010). All observations were made using a Leica (<http://www.leica.com>) DMRXA2 microscope; photographs were taken using a CoolSNAP HQ (Roper; <http://www.roperscientific.com>) camera driven by Open-LAB 4.0.4 software. All images were further processed with OpenLAB 4.0.4 or Adobe Photoshop 7.0 (<http://www.adobe.com>).

Meiotic Behavior

For metaphase I analyses, samples of young floral buds were fixed in Carnoy's solution (alcohol:chloroform:acetic acid, 6:3:1 [v/v]) for 24 h at room temperature and stored until use in 50% ethanol at 4°C . Anthers were then squashed and stained with 1% acetocarmine to analyze the meiotic behavior or squashed in 50% acetic acid for BAC-FISH experiments.

BAC-FISH

Two BAC clones, *B. oleracea* BAC 14O06 (Howell et al., 2002) and *B. napus* BAC 54B2 (provided by B. Chalhouh, Unité de Recherches en Génomique Végétale), were labeled by random priming with Alexa 488-5-dUTP and biotin-14-dUTP (Invitrogen, Life Technologies), respectively. The BAC clone 54B2 hybridizes to three A-genome chromosomes in *B. napus*, and the BAC clone 14O06 allows all C-genome chromosomes to be specifically distinguished in *B. napus* (Leflon et al., 2006; Nicolas et al., 2007).

Chromosomal preparations were incubated in RNase A (100 ng/ μL) and pepsin (0.05%) in 10 mmol of HCl, fixed with paraformaldehyde (1%), dehydrated in an ethanol series (70, 90, and 100%), and air-dried. The hybridization mixture consisted of 50% deionized formamide, 10% dextran sulfate, $2 \times \text{SSC}$ ($1 \times \text{SSC}$ is 0.15 M NaCl and 0.015 M sodium citrate), 1% SDS, and labeled probes (100 ng per slide). Chromosome preparations and predenatured (92°C for 6 min) probes were denatured at

82°C for 30 s. In situ hybridization was performed overnight in a moist chamber at 37°C. After hybridization, slides were washed for 5 min in 50% formamide in 2× SSC at 42°C, followed by several washes in 4× SSC–Tween. For indirect detection of BAC 54B2 DNA with biotin, we visualized the probe using avidin–Texas red (Vector Laboratories). The chromosomes were mounted and counterstained in Vectashield (Vector Laboratories) containing 2.5 µg/mL DAPI. Fluorescence images were captured using a CoolSnap HQ camera (Photometrics) on an Axioplan 2 microscope (Zeiss) and analyzed using MetaVue (Universal Imaging).

Molecular Analyses

Genomic DNA was extracted from young leaves according to the method of Doyle and Doyle (1990). The DNA concentration was adjusted to 10, 50, and 1 ng/µL for random amplification of polymorphic DNA (RAPD), amplified fragment length polymorphism (AFLP), and single sequence repeat assays or specific markers, respectively. Molecular markers were selected from published maps (Foisset et al., 1996; Piquemal et al., 2005; Leflon et al., 2007) for their position on linkage group A7. Two RAPD markers (W11 and Y13; Foisset et al., 1996), two single sequence repeat markers (OI12E03 and CB10439; Piquemal et al., 2005), two specific markers developed from *Arabidopsis* sequences (At1g80040 and At1g80530; Leflon et al., 2007), one SSAP (for sequence-specific amplification polymorphism) marker with two genotyped fragments (NBS1cE40; Leflon et al., 2007), and 11 AFLP markers (prefixed with E; Leflon et al., 2007) were used in the analysis. In figures, RAPD, SSAP, and AFLP markers are suffixed by the size of the amplified fragment. PCR and electrophoresis were performed using the same protocols as described by Leflon et al. (2007).

Construction of Genetic Linkage Maps and Statistical Analyses

Segregation of molecular markers in the BC1 and BC2 progeny was analyzed using χ^2 tests. Segregating markers were scored for each plant, and linkage analysis was performed with MAPMAKER/EXP version 3.0 (Lincoln et al., 1992). Linkage groups were established with a threshold Logarithm of Odds score of 4.0 and a maximum recombination frequency of 0.4. The Kosambi function was used to evaluate the genetic distances in cM between linked markers.

The heterogeneity of crossover rates among populations was assessed for every interval between adjacent markers using χ^2 tests.

To analyze crossover interference, the theoretical distribution of genetic lengths between adjacent crossovers on a chromatid was determined by assuming that the positions of crossovers on the linkage group are independently, uniformly distributed random variables, as proposed by Drouaud et al. (2006). The distribution probability function of distances between two adjacent crossovers depends on the number of crossovers on the chromatid:

$$P(r) = n \cdot \frac{(L-r)^{n-1}}{L^n}$$

where r is the distance between two adjacent crossovers, evaluated in percentage of recombination, L is the genetic length of the chromatid, and n is the number of crossovers. For example, when two crossovers are formed, the probability of finding a distance of 0 to 1/4 L between them is

$$\int_0^{1/4L} 2 \cdot \frac{(L-r)}{L^2} dr = 7/16$$

The theoretical distribution of genetic lengths between adjacent crossovers was calculated according to the observed frequency of chromatids with two, three, or more exchange points. The theoretical distribution of genetic lengths between adjacent crossovers, if there was no interference, was compared with the observed distribution using χ^2 tests.

Supplemental Data

The following materials are available in the online version of this article.

Supplemental Figure 1. Representative Examples of Meiosis I in PMCs of the Diploid, Allotetraploid, and Allotriploid Hybrids.

Supplemental Figure 2. BAC-FISH Analyses of PMCs in Metaphase I in the $A_rA_rC_oC_o$ and $A_rA_rC_o$ Hybrids.

Supplemental Figure 3. Maps of the A7 Linkage Group in BC2 Progeny of the Allotriploid ($A_rA_nC_n$) and Allotetraploid ($A_rA_nC_oC_n$) Hybrids.

Supplemental Figure 4. Number of Exchange Points per Chromatid Transmitted from the Hybrids to Their Progeny.

Supplemental Table 1. Comparison of Meiotic Configurations Observed at Metaphase I between the Allotriploid and Allotetraploid Hybrids.

ACKNOWLEDGMENTS

We thank J.C. Letanneur (Institut National de la Recherche Agronomique [INRA] Rennes) for plant material production, S. Delaunay (INRA Rennes) for molecular analyses, Biogenouest for technical assistance, and C. Mezard, M. Grelon, R. Mercier, and J. Drouaud (INRA Versailles) for their help in data interpretation and critical review of the manuscript. This work was carried out with the financial support of the Agence Nationale de la Recherche, the French National Research Agency, under the Programme Biodiversité project ANR-05-BDIV-015, Effet de la Polyploidie sur la Biodiversité et l'Évolution du Génome des Plantes, and under the program BLANC07-3_188863, project Unraveling Crossover Pathways with *Arabidopsis thaliana* and Crop Relatives.

Received April 21, 2010; revised June 8, 2010; accepted June 18, 2010; published July 9, 2010.

REFERENCES

- Able, J.A., and Langridge, P. (2006). Wild sex in the grasses. *Trends Plant Sci.* **11**: 261–263.
- Barth, S., Melchinger, A.E., Devezi-Savula, B., and Lubberstedt, T. (2001). Influence of genetic background and heterozygosity on meiotic recombination in *Arabidopsis thaliana*. *Genome* **44**: 971–978.
- Brubaker, C.L., Paterson, A.H., and Wendel, J.F. (1999). Comparative genetic mapping of allotetraploid cotton and its diploid progenitors. *Genome* **42**: 184–203.
- Canady, M.A., Ji, Y., and Chetelat, R.T. (2006). Homeologous recombination in *Solanum lycopersicoides* introgression lines of cultivated tomato. *Genetics* **174**: 1775–1788.
- Carlton, P.M., Farruggio, A.P., and Dernburg, A.F. (2006). A link between meiotic prophase progression and crossover control. *PLoS Genet.* **2**: 119–128.
- Chelysheva, L., Grandont, L., Vrielynck, N., Le Guin, S., Mercier, R., and Grelon, M. (2010). An easy protocol for studying chromatin and recombination protein dynamics during *Arabidopsis thaliana* meiosis: Immunodetection of cohesins, histones and MLH1. *Cytogenet. Genome Res.* (in press).
- Desai, A., Chee, P.W., Rong, J., May, O., and Paterson, A.H. (2006). Chromosome structural changes in diploid and tetraploid A genomes of *Gossypium*. *Genome* **49**: 336–345.
- Dooner, H.K. (2002). Extensive interallelic polymorphisms drive meiotic recombination into a crossover pathway. *Plant Cell* **14**: 1173–1183.

- Doyle, J.J., and Doyle, J.L. (1990). Isolation of plant DNA from fresh tissue. *Focus* **12**: 13–15.
- Drouaud, J., Camilleri, C., Bourguignon, P.Y., Canaguier, A., Berard, A., Vezon, D., Giancola, S., Brunel, D., Colot, V., Prum, B., Quesneville, H., and Mezard, C. (2006). Variation in crossing-over rates across chromosome 4 of *Arabidopsis thaliana* reveals the presence of meiotic recombination “hot spots.” *Genome Res.* **16**: 106–114.
- Drouaud, J., Mercier, R., Chelysheva, L., Bérard, A., Falque, M., Martin, O., Ziani, V., Brunel, D., and Mezard, C. (2007). Sex-specific crossover distributions and variations in interference level along *Arabidopsis thaliana* chromosome 4. *PLoS Genet.* **3**: 1096–1107.
- Dvorak, J., Luo, M.C., and Yang, Z.L. (1998). Restriction fragment length polymorphism and divergence in the genomic regions of high and low recombination in self-fertilizing and cross-fertilizing *Aegilops* species. *Genetics* **148**: 423–434.
- Esch, E., Szymaniak, J.S., Yates, H., Pawlowski, W.P., and Buckler, E.S. (2007). Using crossover breakpoints in recombinant inbred lines to identify quantitative trait loci controlling the global recombination frequency. *Genetics* **177**: 1851–1858.
- Ferreira, M.E., Williams, P.H., and Osborn, T.C. (1994). RFLP mapping of *Brassica napus* using doubled haploid lines. *Theor. Appl. Genet.* **89**: 615–621.
- Foisset, N., Delourme, R., Barret, P., Hubert, N., Landry, B.S., and Renard, M. (1996). Molecular-mapping analysis in *Brassica napus* using isozyme, RAPD and RFLP markers on a doubled haploid progeny. *Theor. Appl. Genet.* **93**: 1017–1025.
- Francis, K.E., Lam, S.Y., Harrison, B.D., Bey, A.L., Berchowitz, L.E., and Copenhaver, G.P. (2007). Pollen tetrad-based visual assay for meiotic recombination in *Arabidopsis*. *Proc. Natl. Acad. Sci. USA* **104**: 3913–3918.
- Gymer, P.T., and Whittington, W.J. (1975). Hybrids between *Lolium perenne* and *Festuca pratensis*. III. Meiosis and fertility. *New Phytol.* **74**: 295–306.
- Higgins, J.D., Buckling, E.F., Franklin, C.F.H., and Jones, G.H. (2008). Expression and functional analysis of AtMUS81 in *Arabidopsis* meiosis reveals a role in the second pathway of crossing-over. *Plant J.* **54**: 152–162.
- Howell, E.C., Barker, G.C., Jones, G.H., Kearsey, M.J., King, G.J., Kop, E.P., Ryder, C.D., Teakle, G.R., Vicente, J.G., and Armstrong, S.J. (2002). Integration of the cytogenetic and genetic linkage maps of *Brassica oleracea*. *Genetics* **161**: 1225–1234.
- Jenkins, G. (1985a). Synaptonemal complex formation in hybrids of *Lolium temulentum* × *Lolium perenne* (L.). I. High chiasma frequency diploid. *Chromosoma* **92**: 81–88.
- Jenkins, G. (1985b). Synaptonemal complex formation in hybrids of *Lolium temulentum* × *Lolium perenne* (L.). II. Triploid. *Chromosoma* **92**: 387–390.
- Jenkins, G. (1986). Synaptonemal complex formation in hybrids of *Lolium temulentum* × *Lolium perenne* (L.). III. Tetraploid. *Chromosoma* **93**: 413–419.
- Jenkins, G., and White, J. (1988). Elimination of multivalents during meiotic prophase in *Scilla autumnalis*. II. Tetraploid. *Genome* **30**: 940–946.
- Jones, G.H. (1984). The control of chiasma distribution. *Symp. Soc. Exp. Biol.* **38**: 293–320.
- Leflon, M., Brun, H., Eber, F., Delourme, R., Lucas, M., Vallée, P., Ermel, M., Balesdent, M., and Chèvre, A.M. (2007). Detection, introgression and localization of genes conferring specific resistance to *Leptosphaeria maculans* from *Brassica rapa* into *B. napus*. *Theor. Appl. Genet.* **115**: 897–906.
- Leflon, M., Eber, F., Letanneur, J.C., Chelysheva, L., Coriton, O., Huteau, V., Ryder, C.D., Barker, G., Jenczewski, E., and Chèvre, A.M. (2006). Pairing and recombination at meiosis of *Brassica rapa* (AA) × *Brassica napus* (AACC) hybrids. *Theor. Appl. Genet.* **113**: 1467–1480.
- Lhuissier, F.G.P., Offenber, H.H., Wittich, P.E., Vischer, N.O.E., and Heyting, C. (2007). The mismatch repair protein MLH1 marks a subset of strongly interfering crossovers in tomato. *Plant Cell* **19**: 862–876.
- Lincoln, S.E., Daly, M.J., and Lander, E.S. (1992). Constructing Genetic Linkage Maps with MAPMAKER/EXP 3.0: A Tutorial and Reference Manual. Technical Report 3rd ed. (Cambridge, MA: Whitehead Institute).
- Lincoln, S.E., and Lander, E.S. (1992). Systematic detection of errors in genetic linkage data. *Genomics* **14**: 604–610.
- Lynn, A., Soucek, R., and Börner, G.V. (2007). ZMM proteins during meiosis: Crossover artists at work. *Chromosome Res* **15**: 591–605.
- Lysak, M.A., Koch, M.A., Pecinka, A., and Schubert, I. (2005). Chromosome triplication found across the tribe Brassiceae. *Genome Res.* **15**: 516–525.
- Martinez-Perez, E., and Moore, G. (2008). To check or not to check? The application of meiotic studies to plant breeding. *Curr. Opin. Plant Biol.* **11**: 222–227.
- Mézard, C., Vignard, J., Drouaud, J., and Mercier, R. (2007). The road to crossovers: Plants have their say. *Trends Genet.* **23**: 91–99.
- Muller, H.J. (1916). The mechanisms of crossing over. *Am. Nat.* **50**: 193–221.
- Nicolas, S.D., Leflon, M., Monod, H., Eber, F., Coriton, O., Huteau, V., Chèvre, A.M., and Jenczewski, E. (2009). Genetic regulation of meiotic crossovers between related genomes in *Brassica napus* haploids and hybrids. *Plant Cell* **21**: 373–385.
- Nicolas, S.D., Le Mignon, G., Eber, F., Coriton, O., Monod, H., Clouet, V., Huteau, V., Lostanlen, A., Delourme, R., Chalhou, B., Ryder, C.D., Chèvre, A.M., et al. (2007). Homeologous recombination plays a major role in chromosome rearrangements that occur during meiosis of *Brassica napus* haploids. *Genetics* **175**: 487–503.
- Parker, J.S. (1975). Chromosome-specific control of chiasma formation. *Chromosoma* **49**: 391–406.
- Parkin, I.A.P., Sharpe, A.G., Keith, D.J., and Lydiate, D.J. (1995). Identification of the A and C genomes of amphidiploid *Brassica napus* (oilseed rape). *Genome* **38**: 1122–1131.
- Piquemal, J., Cinquin, E., Couton, F., Rondeau, C., Seignoret, E., Doucet, I., Perret, D., Villeger, M.J., Vincourt, P., and Blanchard, P. (2005). Construction of an oilseed rape (*Brassica napus* L.) genetic map with SSR markers. *Theor. Appl. Genet.* **111**: 1514–1523.
- Robbins, T.P., Gerats, A.G.M., Fiske, H., and Jorgensen, R.A. (1995). Suppression of recombination in wide hybrids of petunia hybrids as revealed by genetic mapping of marker transgenes. *Theor. Appl. Genet.* **90**: 957–968.
- Sanchez-Moran, E., Armstrong, S.J., Santos, J.L., Franklin, F.C.H., and Jones, G.H. (2002). Variation in chiasma frequency among eight accessions of *Arabidopsis thaliana*. *Genetics* **162**: 1415–1422.
- Soltis, D.E., Albert, V.A., Leebens-Mack, J., Bell, C.D., Paterson, A.H., Zheng, C., Sankoff, D., dePamphilis, C.W., Wall, P.K., and Soltis, P.S. (2009). Polyploidy and angiosperm diversification. *Am. J. Bot.* **96**: 336–348.
- Suwabe, K., Morgan, C., and Bancroft, I. (2008). Integration of *Brassica* A genome genetic linkage map between *Brassica napus* and *B. rapa*. *Genome* **51**: 169–176.
- Tease, C., and Jones, G.H. (1975). Chromosome-specific control of chiasma formation in *Crepis capillaris*. *Chromosoma* **57**: 33–49.
- Teutonico, R.A., and Osborn, T.C. (1994). Mapping of RFLP and qualitative trait loci in *Brassica rapa* and comparison to the linkage

- maps of *Brassica napus*, *Brassica oleracea*, and *Arabidopsis thaliana*. *Theor. Appl. Genet.* **89**: 885–894.
- Thomas, H., Morgan, W.G., and Humphreys, M.W.** (1988). The use of triploid hybrids for introgression in *Lolium* species. *Theor. Appl. Genet.* **76**: 299–304.
- Wang, M., Wang, K., Tang, D., Wei, C., Li, M., Shen, Y., Chi, Z., Gu, M. and Cheng, Z.** (2010). The central element protein ZEP1 of the synaptonemal complex regulates the number of crossovers during meiosis in rice. *Plant Cell* **22**: 417–430.
- Whitby, M.C.** (2005). Making crossovers during meiosis. *Biochem. Soc. Trans.* **33**: 1451–1455.
- White, J., and Jenkins, G.** (1988). Elimination of multivalents during meiotic prophase in *Scilla autumnalis*. I. Diploid and triploid. *Genome* **30**: 930–939.
- Wijnker, E., and de Jong, H.** (2008). Managing meiotic recombination in plant breeding. *Trends Plant Sci.* **13**: 640–646.
- Wood, T.E., Takebayashi, N., Barker, M.S., Mayrose, I., Greenspoon, P.B., and Rieseberg, L.H.** (2009). The frequency of polyploid speciation in vascular plants. *Proc. Natl. Acad. Sci. USA* **106**: 13875–13879.
- Zwierzykowski, Z., Lukaszewski, A.J., Naganowska, B., and Lesniewska, A.** (1999). The pattern of homoeologous recombination in triploid hybrids of *Lolium multiflorum* with *Festuca pratensis*. *Genome* **42**: 720–726.

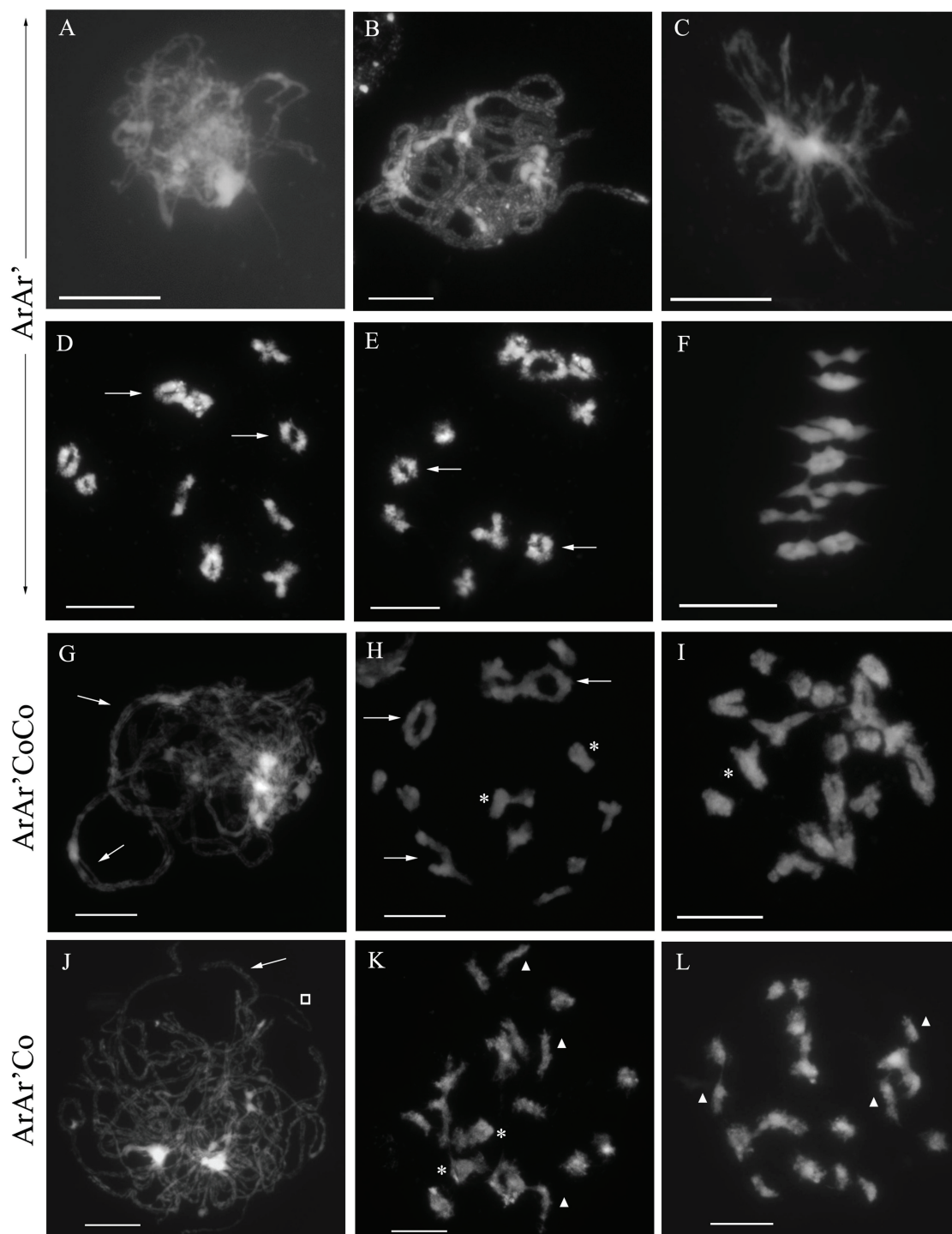

Supplemental Figure 1: Representative examples of Meiosis I in pollen mother cells of the diploid, allotetraploid and allotriploid hybrids.

DAPI staining of the diploid hybrid ArAr', (A-F) the allotetraploid hybrid ArAr'Co (G-I) and the allotriploid hybrid ArAr'CoCo (J-L) pollen mother cells during meiosis.

Meiotic behaviour of the diploid hybrid: (A) zygotene, showing local synapsis initiation (arrows), (B) pachytene, showing complete synapsis (C) diplotene, (D, E) diakinesis with ten bivalents (six and five ring bivalents, respectively; arrows), (F) metaphase with ten bivalents (4 bivalents are held by one chiasma and the remaining six are held by two chiasmata). Meiotic behaviour of the allotetraploid hybrid: (G) pachytene-like stage; arrows indicate multiple alignments; (H) spread and (I) squashed diakinesis; arrows show multivalents and asterisks show bivalents with an abnormal shape. Meiotic behaviour of the allotriploid hybrid: (J) pachytene-like stage, arrows point to synapsed chromosomes and squares indicate unsynapsed chromosomes; (K, L) early and late squashed diakinesis, asterisks show some bivalents with intimately linked chromosomes and triangles indicate some stretched univalents. Bar, 10 μ m.

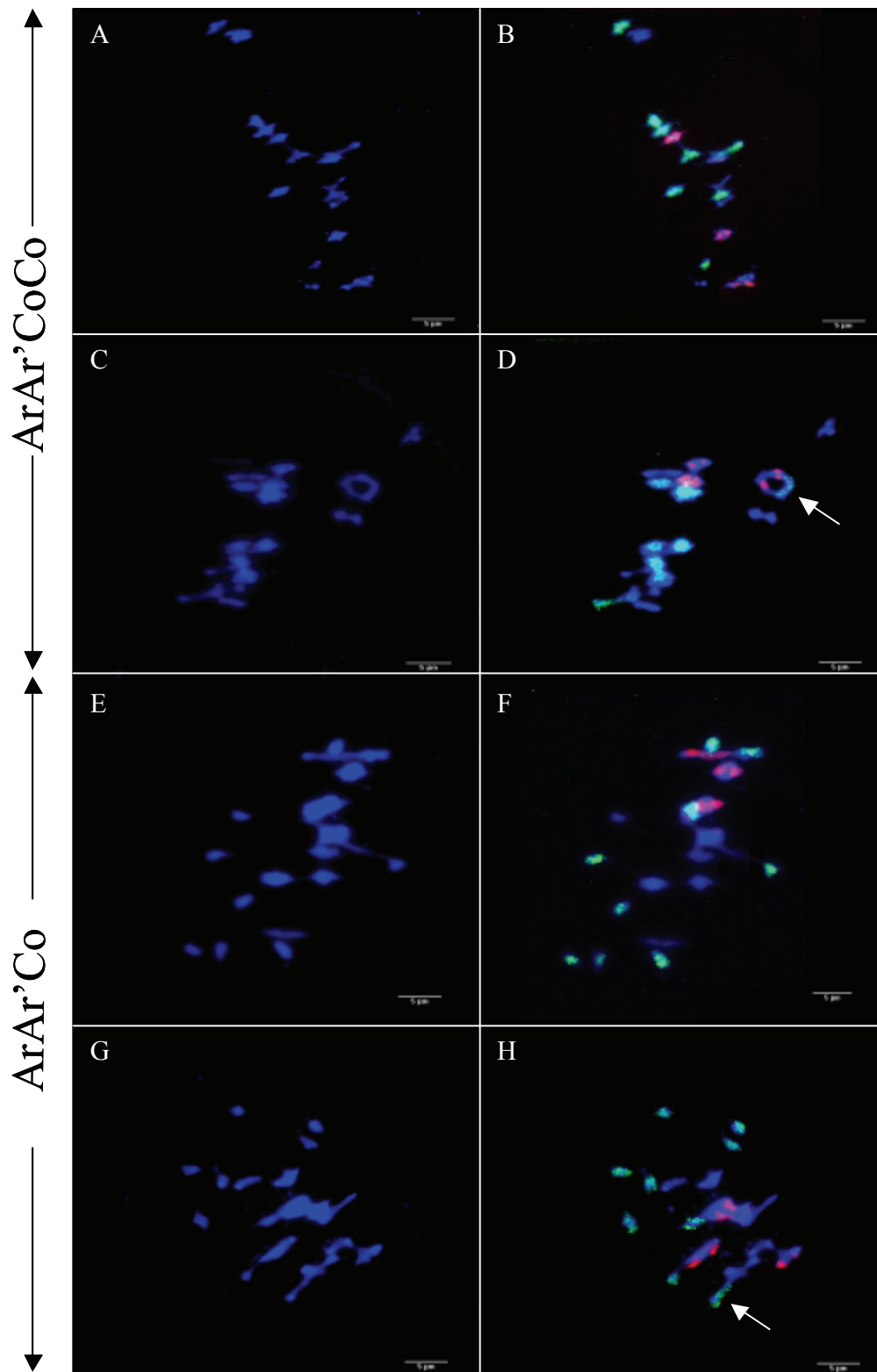

Supplemental Figure 2: ‘BAC-FISH analyses of pollen mother cells (PMC) in metaphase I in the ArAr’CoCo and ArAr’Co hybrids.

Chromosomes were stained with DAPI (blue) and FISH was carried out using two BACs that identify three pairs of A chromosomes (red) and all the C chromosomes (green).

Genome origin (A vs. C) of the chromosomes involved in MI structures of the ArAr’CoCo hybrid: (A, B) are representative for the PMCs with ten AA bivalents and nine CC bivalents as expected; (C, D) show a cell with nine AA bivalents, eight CC bivalents and one AACC quadrivalent (arrow).

Genome origin (A vs. C) of the chromosomes involved in MI structures in the ArAr’Co hybrid: (E, F) are representative of the most observed configuration with ten AA bivalents and nine C univalents, (G, H) show a PMC with eight C univalents, one A univalent, nine AA bivalents and one AC bivalent (arrow).

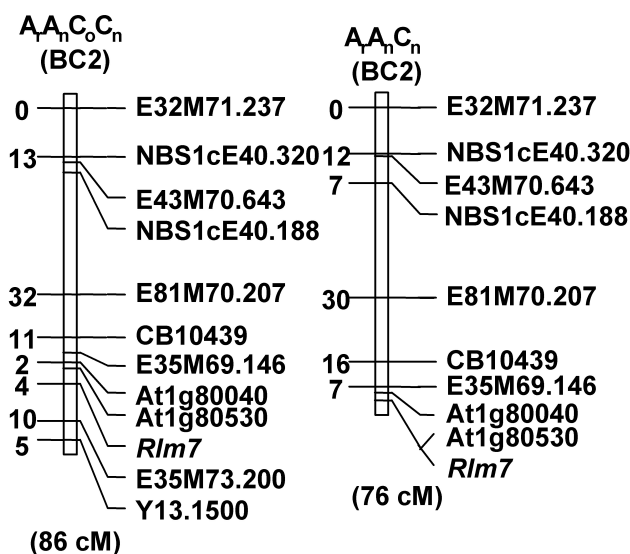

Supplemental Figure 3: Maps of the A7 linkage group in BC2 progenies of the allotriploid (ArAnCn) and allotetraploid (ArAnCoCn) hybrids.

Genetic distances are expressed in cM, and BC2 progenies were produced from two 2n=38 BC1 offspring from among the progenies of the ArAnCn and ArAnCoCn hybrids, respectively.

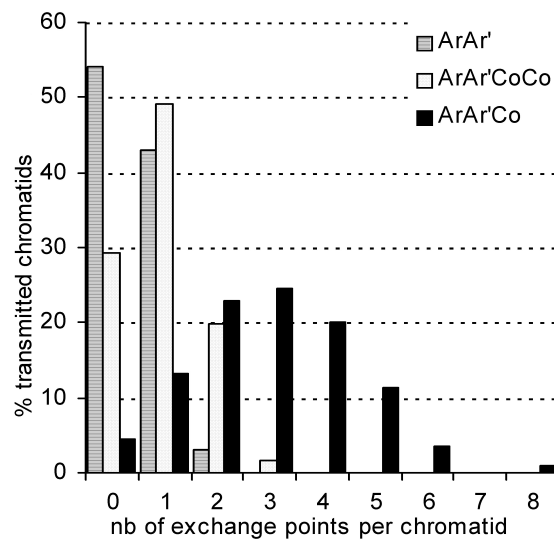

Supplemental Figure 4. Number of exchange points per chromatid transmitted from the hybrids to their progenies.

SUPPLEMENTAL TABLE

Supplemental Table 1. Comparison of meiotic configurations observed at metaphase I between the allotriploid and allotetraploid hybrids

Hybrids	# PMCs	I ^A	I ^C	II ^{AA}	II ^{CC}	II ^{AC}	III ^{AAC}	IV ^{AACC}
A _r A _r C _o C _o	20	0.3 [0-2]	0	9.6 [8-10]	8.85 [8-9]	0.1 [0-2]	0	0.15 [0-2]
A _r A _r C _o	22	0.32 [0-2]	8.09 [6-9]	9.54 [8-10]	0.18 [0-1]	0.5 [0-2]	0.05 [0-1]	0

I^A and I^C indicate univalents belonging to the A and C genomes, respectively; II^{AA} and II^{CC} indicate bivalents formed between a pair of A or a pair of C chromosomes, respectively; II^{AC} indicates bivalents formed between A and C chromosomes ; III^{AAC} indicates trivalents formed between a pair of A chromosomes and one C chromosome ; IV^{AACC} indicates quadrivalents formed between A and C chromosome
 [] indicates the range of variation.