



**HAL**  
open science

## Modelling work organisation to accompany changes in livestock farms.

Sophie Madelrieux, Benoit Dedieu, Laurent Dobremez

► **To cite this version:**

Sophie Madelrieux, Benoit Dedieu, Laurent Dobremez. Modelling work organisation to accompany changes in livestock farms.. Farming systems design 2007: an International Symposium on Methodologies on Integrated Analysis on Farm Production Systems, Sep 2007, Catania, Italy. hal-01195199

**HAL Id: hal-01195199**

**<https://hal.science/hal-01195199v1>**

Submitted on 3 Jun 2020

**HAL** is a multi-disciplinary open access archive for the deposit and dissemination of scientific research documents, whether they are published or not. The documents may come from teaching and research institutions in France or abroad, or from public or private research centers.

L'archive ouverte pluridisciplinaire **HAL**, est destinée au dépôt et à la diffusion de documents scientifiques de niveau recherche, publiés ou non, émanant des établissements d'enseignement et de recherche français ou étrangers, des laboratoires publics ou privés.



# Farming Systems Design 2007

An International Symposium on Methodologies on Integrated Analysis on Farm Production Systems

## Field-farm scale design and improvement

September 10-12, 2007 – Catania, Sicily, Italy

*sponsored by*



 LA GOLIARDICA PAVESE

The correct citation of articles in this book is:

*authors, 2007 title.* On: Farming Systems Design 2007, Int. Symposium on Methodologies on Integrated Analysis on Farm Production Systems, M. Donatelli, J. Hatfield, A. Rizzoli Eds., Catania (Italy), 10-12 September 2007, book 2 – Field-farm scale design and improvement, pag. ??-??

---

**Sponsors of the Symposium:**

The University of Catania  
The Società Italiana di Agronomia

**Under the auspices of:**

C.R.A. - Agriculture Research Council Rome, Italy

**Organizing Committee:**

Salvatore Cosentino  
Marcello Donatelli  
Jerry Hatfield  
Hans Langeveld  
Andrea Rizzoli

**Graphics:**

Patricia Scullion

**Book composition:**

Claudia Maestrini

---

© 2007 La Goliardica Pavese s.r.l.  
Viale Golgi, 2 - 27100 Pavia  
Tel. 0382529570 - 0382525709 - Fax 0382423140  
www. lagoliardicapavese.it  
e-mail: [info@lagoliardicapavese.it](mailto:info@lagoliardicapavese.it)

All copy-rights reserved.

No part of this volume can be reproduced by any mean without the written permission of the Publisher.

ISBN 978- 88-7830-474-1

Printed on August 2007 by *Global Print*, Gorgonzola (MI), Italy

## Foreword

The Farming Systems Design Workshop is the result of a joint effort among the American Society of Agronomy (ASA), the European Society of Agronomy (ESA), and the International Environmental Modeling and Software Society (IEMSS). This meeting is a result of the joint efforts between ASA and ESA to promote more interaction between the agronomic societies and we are fortunate to have the interest of IEMSS as a partner in this effort on Methodologies for Integrated Analysis of Farm Production Systems in this inaugural effort. We are deeply appreciative of the offer from the University of Catania, Faculty of Agriculture, and the [Società Italiana di Agronomia](#) to provide the venue for this meeting.

There is a growing interest in agricultural systems that serve multiple purposes, in the context of driving factors such as climate change, liberalization, environmental concerns, and changing agricultural institutions. Farming systems are continuously being pressured to innovate and change to meet a variety of ecosystem services. The drivers strongly affect agricultural and environmental policies, as these must support the sustainability of agricultural systems and their contribution to sustainable development in general. This places a demand on research approaches that enable analysis of current farming systems, exploration and design of alternative ones as well as new co-learning and dissemination strategies. These research approaches must provide capabilities for assessing the economic, environmental and social aspects of farming system's evolution in different spatial and temporal contexts. Today, a variety of quantitative and qualitative methods exist, but there is a lack of integration in evaluating issues which range from strictly technical to social, and to landscape related attributes. Our for this symposium are to: 1) Provide an opportunity to integrate knowledge across disciplines targeted at farming system analysis, design and innovation; 2) Compare approaches being used/developed in different research groups; and 3) Identify the available operational tools and the future research needs.

We hope to integrate across

biophysical and social domains using quantitative and qualitative approaches from the developed and developing world because we believe there are valuable lessons to be gained from many different perspectives.

Farm-regional scale design and improvement, involves considerations operating at whole farm scale, such as trade-offs between economic, environmental and social aspects of farm operation; interactions with policy, community, landscape, and markets; action research and participatory methods; adapting to climate change; crop-livestock integration. Field-Farm scale design and improvement involves issues operating at field scale, such as optimising production systems, novel systems, production system sustainability and externalities, tools, participatory research. These will be discussed through plenary, oral, and poster sessions covering each of the topics shown in the program.

This effort would not be possible without the dedication and enthusiasm provided by the Scientific Committee. We are indebted to the following individuals for their service on the Scientific Committee.

- John Antle, Montana State University Bozeman, USA
- James Ascough, ARS Fort Collins, USA
- Salvatore Cosentino, University of Catania, Italy
- Olaf Christen, University of Halle-Wittenberg, Germany
- Marcello Donatelli, CRA-ISCI, Italy
- Carlo Giupponi, University of Milan, Italy
- Jonathan (Jon) Hanson, USDA-ARS-NGPRL, USA
- Graeme Hammer, University of Brisbane, Australia
- Jerry Hatfield, USDA-ARS-NSTL, USA
- Thomas Heckelei, Bonn University, Germany
- Brian Keating, CSIRO, Queensland, Australia
- Hans Langeveld, Wageningen University, The Netherlands

- Keith Matthews, Macaulay Institute, Scotland
- Andrea Rizzoli, IDSIA-USI/SUPSI, Switzerland
- Claudio Stockle, Washington State University, USA
- Martin van Ittersum, Wageningen University, The Netherlands
- Jacques Wery, UMR System (Agro.M-Cirad-Inra), France

Most of all we express our appreciation to the participants in this symposium and your willingness to share your information for this meeting. We look forward to the fruitful interactions during and following this meeting as we begin to share your thoughts and ideas on how to improve farming systems.

Jerry L. Hatfield  
ASA

Marcello Donatelli  
ESA

Andrea E. Rizzoli  
IEMSS

# Key notes

## **CRITICAL REFLECTION ON MODELLING SUPPORT IN LAND-USE DECISION-MAKING**

P. Carberry<sup>1</sup>, W. Rossing<sup>2</sup>, B. Sterk<sup>3</sup>, M. Howden<sup>1</sup>

<sup>1</sup> CSIRO Agricultural Sustainability Initiative, Australia, [peter.carberry@csiro.au](mailto:peter.carberry@csiro.au); [mark.howden@csiro.au](mailto:mark.howden@csiro.au)

<sup>2</sup> Biological Farming Systems, Wageningen Uni and Research, The Netherlands, [walter.rossing@wur.nl](mailto:walter.rossing@wur.nl)

<sup>3</sup> Plant Production Systems, Wageningen Uni and Research, The Netherlands, [barbara.sterk@wur.nl](mailto:barbara.sterk@wur.nl)

### **Introduction**

Over the past 30 years, there has been a consistent rationale to justify much of the research undertaken in the field of agricultural systems analysis. Such rationale proposes that decision-makers, whether farmers, policy-makers, or other stakeholders, struggle with the complexity and uncertainty inherent in agricultural systems and would welcome access to technologies which lessen this burden. Consequently, it is argued that the management of land, whether at the field, farm or regional scale, can benefit from science knowledge and models. However, the adoption by farmer and policy clients of Decision Support Systems (DSS) derived from science models has been a disappointment to many developers and a number of assumptions underpinning this rationale have been challenged and solutions proposed (van Ittersum et al., 1998; McCown et al., 2002; Parker et al., 2002; Walker, 2002; Rossing et al., 2007).

A brief foray into the literature reveals that the nexus between science and policy is a field of significant study and that the troubled relationship between science-based decision support and political decision-making in agricultural land use is more often the typical situation than not at the broader science-policy interface (Hoppe, 2005). The objective of this paper is to try to discern possible intervention approaches using systems models into the agricultural policy domain.

### **Different science intervention models for POR**

A number of approaches can be identified as having been employed by researchers in agricultural land use studies in engaging in policy-oriented research using their systems modelling tools. Based on the work of Hoppe (2001) we have represented these approaches as five diagrammatic models based around the interface between two spheres representing the science sphere occupied by researchers and the policy domains staffed by analysts and advisers (Figure 1). Type A symbolizes the likely traditional status quo in agriculture land use studies whereby science operates within its own sphere, aimed at creating knowledge and tools, whilst policy operates in a separate sphere with analysts (many science trained) generating policy advice for political decision-makers. The link between the two is via the large arrow, signifying that analysts go looking for knowledge and tools from the science sphere on a needs basis and bring what they want back into their sphere for use.

The history of development of agricultural decision support systems has largely operated with scientists designing and developing DSS tools for expected use by decision makers, either at the farm or policy scale. Type B represents a common, though maybe extreme view of DSS tools developed in the science sphere and passed over to decision-makers (dotted arrow) with expectations of uptake. Relative to the investment in tool and methodology development, little effort is usually placed in fostering such adoption or evaluating impacts. Types A and B are modes of operation that largely maintain divergence between the science and policy spheres and much of the past efforts in agricultural systems analysis can be readily categorised to fall within such schema. However, governments and research funders are increasingly demanding more cost-effective outcomes from shrinking public-good funding for research. We can identify three additional models whereby science intervention in the policy sphere has been attempted using systems analysis tools in land management studies.

We all know of prominent scientists who have become embroiled within the political sphere. They have not simply engaged with politicians, they have worked to become part of the political establishment and in doing so have been able to have science heard in political debates. Type C

can achieve significant impacts from efforts emanating from the science sphere but it will remain the path for a select, talented and motivated few amongst us scientists.

Most countries have agencies with mandates to sit between the science and policy spheres (Type D) and this unambiguous mandate to support policy largely distinguishes them from science organisations. They are generally staffed by science graduates who act as analysts, although many of their scientists are active in the disciplinary science activities of knowledge generation and publication despite reward structures often being unrelated to such pursuits. Type D creates two new interfaces: between the science policy agencies and both the science sphere and the policy sphere. At the latter boundary the reality is that, for researchers in most science-policy agencies, their project agenda and funding is set by those in the political sphere. Alternatively, the interface between the science-policy agency and the science sphere offers mutual opportunity for researchers in both organisational types. Lastly, we scientists can engage with advocacy groups who are aligned with our research interests (Type E).

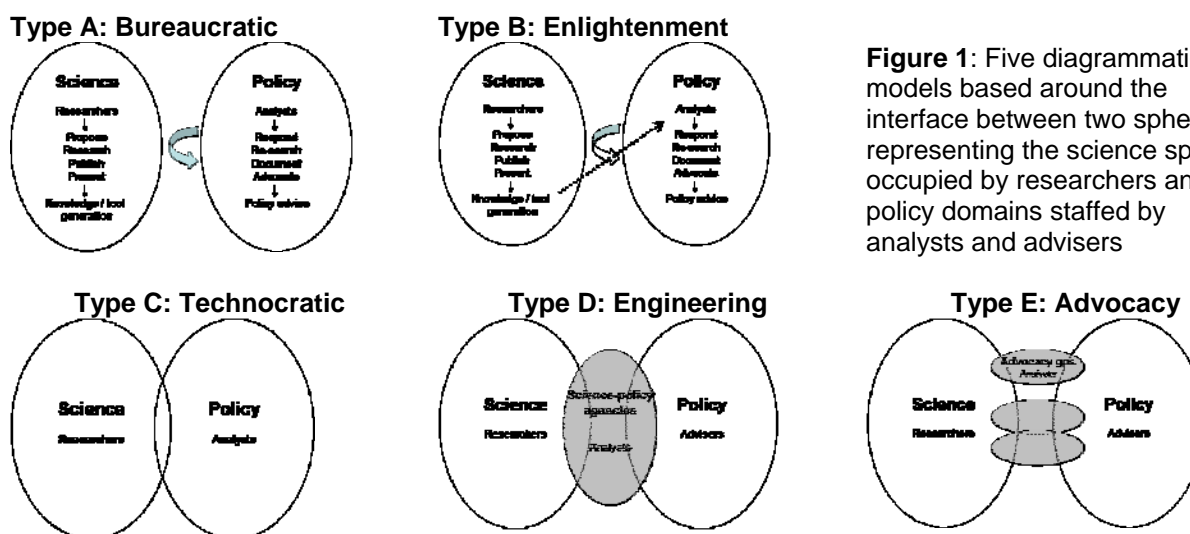

**Figure 1:** Five diagrammatic models based around the interface between two spheres representing the science sphere occupied by researchers and the policy domains staffed by analysts and advisers

## Conclusions

This paper proposes to help by being more explicit about the alternative interfaces between the science and policy domains. While the traditional bureaucratic arrangement continues and may justify much of the research undertaken within the science sphere, it is arguable that the claims of policy support emanating from such work will continue unchallenged. Taking a participative learning approach is clearly difficult, but we believe there are opportunities at the different interfaces with the policy domain. A key learning is that there are differing roles for scientists within the nexus between science and policy. Organisations with aspirations to fulfil policy needs have to recognise and reward these different roles. For our part, scientists need to see where we and our models fit within the possible interfaces between the science and policy domains. Purposeful intervention in land-use decision-making at a range of scales remains our challenge.

## References

- R. Hoppe, Rethinking the science-policy nexus: from knowledge utilization and science technology studies to types of boundary arrangements, 2005. *Poiesis & Praxis* 3:199-215.
- R. McCown et al., (Eds.), *Learnings from 25 Years of Agricultural DSS: Case Histories of Efforts to Harness Simulation Models for Farm Work*, 2002. *Agric Syst.* 74: 1-220.
- P. Parker et al., *Progress in integrated assessment and modelling*, 2002. *Environmental Modelling and Software* 17: 209–217.
- W. Rossing et al., *Integrative modelling approaches for analysis of impact of multifunctional agriculture: A review for France, Germany and The Netherlands*, 2007. *Agriculture, Ecosystems and Environment* 120:41–57.
- M. van Ittersum et al., *Exploratory land use studies and their role in strategic policy making*, 1998. *Agricultural Systems* 58:309-330.
- D. Walker, *Decision support, learning and rural resource management*, 2002. *Agricultural Systems* 73:113–127.



## Designing crop management systems by simulation

J.E Bergez<sup>1</sup>, O. Crespo<sup>3</sup>, F. Garcia<sup>3</sup>, C. Gary<sup>4</sup>, MH Jeuffroy<sup>2</sup>, E. Justes<sup>1</sup>, C. Loyce<sup>2</sup>, W. Sadok<sup>2</sup>  
<sup>1</sup> INRA, UMR AGIR, Toulouse, France, {jbergez, justes}@toulouse.inra.fr  
<sup>2</sup> INRA, UMR Agronomie, Grignon, France {jeuffroy, loyce, Walid.Sadok}@grignon.inra.fr  
<sup>3</sup> INRA, UR BIA, Toulouse, France {olivier.crespo, fgarcia}@toulouse.inra.fr  
<sup>4</sup> INRA, UMR System, Montpellier, France, gary@supagro.inra.fr

### Introduction

The fast change of agricultural context (global change, market globalisation, environmental concerns) implies a constant development of new ways of production in order to guarantee sustainable agriculture. Experimentations and prototyping are useful tools for investigating new cropping systems but they are too slow to give on-time answers to such fast evolution. Modelling and simulating is then an interesting way to propose new agricultural management systems that tackles current social, political and environmental concerns. In the 1980s, large efforts were made to develop biophysical models (Sinclair and Seligman, 1996). Due to the failure of transferring such models or their simulation results to farmers or extension advisors, some researchers extensively studied farmer's management practices (McCown et al., 2002). They thoroughly analyzed decision-making process from on-farm observations. This led to the concept of *cropping systems* (Sebillotte, 1990) and to *decision making modelling* based on *decision rules* (Aubry et al., 1998). In the last decades, *biodecisional models* were developed. They link the biophysical and decisional approaches (Bergez and Garcia, 2003). Using such models may help in developing new and innovative crop management systems. This paper presents different methodological works using simulation models to design crop management systems.

### Designing crop management systems with simulation

**A four-step loop:** Designing crop management systems may follow a four-step iterative process

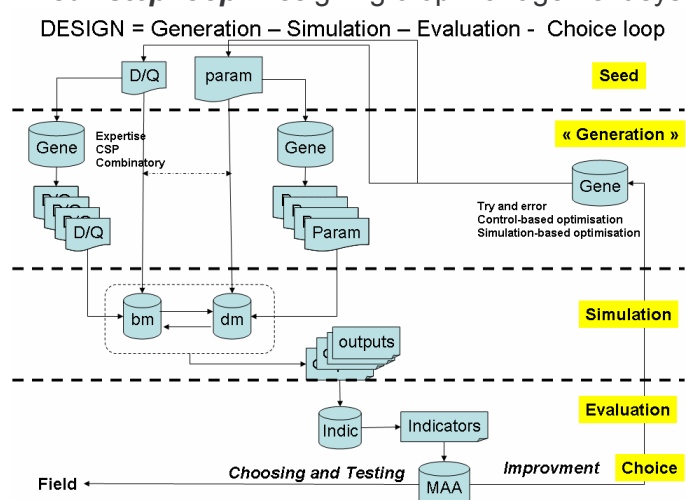

(Figure 1):

1. From a seed, generation of one or a set of candidate crop management plans.
  2. Simulation of these management plans in soil/climate contexts
  3. Evaluation of the simulated management plans
  4. Choice of some “interesting” crop management options and/or improvement through a new generation process that loops to step 1
- The loop will stop when no better crop management options may be found. The model used may be a biophysical model

**Figure 1: The four-step loop that aims at designing crop management systems**

using look-up table or a biodecisional model using a proper developed decision model. Accordingly, different

methodologies may be used to carry out this so-called GSEC loop.

**Generation:** There are two ways in developing the set of management plans that will be simulated: starting from a seed and improving it step-by-step or creating a huge bunch of management practices (either on date/quantity or rules) and simulating them. In both cases some methods may be used to create or improve the set of management practices that will be tested. A biophysical model generally requires only dates and quantities as inputs management data. Such kind of data was required by Matthews (2002) to qualify the *management options* of its virtual experiments. To generate this kind of data, boundaries have to be given to these dates and quantities in order to provide realistic management. Different methods may be used such as simple “hand-written” combinatorial processes (Ghaffari et al., 2001), agronomical filter and combinatorial processes (Dogliotti et al., 2003) or constraint satisfaction programming (Loyce et al., 2003). On the opposite, if one uses a biodecisional model, rules have to be specified. In this case, either thresholds to rules may be given or completely new rules may be provided (Bergez et al., 2006). The former approach belongs to the field of the simulation-based optimization. Several methods are available to optimize

thresholds of rules: branch and bound optimization, systematic optimization, gradient-based optimization, genetic algorithm... The latter approach belongs to the field of control-based optimization and is more a field of artificial intelligence research. Methods such as approximate dynamic programming, reinforcement learning of decision rules may be used.

**Simulation:** There is no specificity in the simulation step. Multi-simulation can be performed for any set of management plans that have been generated. However it is important to design proper experimental plan for virtual experiment.

**Evaluation:** Evaluating a simulated management means affecting it some indicator values. Indicators are chosen to help selecting managements plans that will be kept for a new iteration of the general loop. There are several points to keep in mind (Girardin et al., 1998): 1) Defining some proper indicators is a difficult task when the different dimensions of the sustainability (social, economic and environment) are to be considered; 2) Indicators have to be calculated from the simulation outputs; 3) Calculating the indicator needs to answer several questions such as: How accounting for the climate variability? Should we use a single average value? Do we take into account variance or quantiles of the results distribution?

**Choice:** The choice step consists in selecting one or several simulated management plans, qualified by indicator values. Ranking, sorting, choosing are typical questions of multi-criteria decision analysis (Schärlig, 1995). The main problem in choosing on multi attributes is that the notion of optimal is no more valid. Some crop management plan may lead to good results for some attributes and less good results for some other attributes. Most of works on this are based on multi-criteria decision aid (or making) methods (MCDA or MCDM). This is a crucial methodological issue, particularly to automatise the designing loop. Unfortunately, for crop management systems, only few works on this exist (Sadok et al., 2008).

### Conclusions

Using simulation to design crop management is an alternative way of designing crop management than experimentation and prototyping. Current research issues deal with uncertainty and multi-criteria analysis. Another important point is that there is still a large gap of knowledge concerning biotic interaction and modelling. If one wants to design crop management plans, pest management has to be accounted for. Specific frameworks should be developed to help in running the GSEC loop. This is the case of the French RECORD platform that has been designed as a modelling and simulation software platform where researchers can build, assemble and couple their own pieces of model to pre-existing ones, and can simulate the resulting models (see poster in this symposium). Once some management plans have been designed, they still have to be tested and adapted to real farm as modelling is a "*simplification of the reality*". Using simulation model is just a step. Involving social sciences scientists is necessary to "bridge the gap" between the simulation results and the on-field application.

### References

- Aubry C. et al. 1998. Modelling decision-making processes for annual crop management. *Agric. Syst.*, 56, 45-65.
- Bergez J.E., Garcia, F., 2003. Conception par simulation de stratégies de conduite de culture. *Colloque Automatique et Agronomie*, 22-24 Janvier 2003, Montpellier (FR): 99-109.
- Bergez J.E. et al., 2006. Representing and optimizing management decisions with crop models. In D. Wallach et al. (eds), *Working with dynamic crop models: Evaluating, analyzing, parameterizing and using them*, Elsevier. pp 175-210.
- Dogliotti S. et al., 2003. A tool for systematically generating crop rotations. *Eur. J. Agron.*, 19: 239-250.
- Ghaffari A. et al., 2001. Simulating winter wheat yields under temperate conditions: exploring different management scenarios. *Eur. J. Agron.*, 15, 231-240.
- Girardin P. et al., 1999. Indicators: tools to evaluate the environmental impacts of farming systems. *J. Sustain. Agric.*, 13, 5-21
- Loyce C. et al., 2002. Management planning for winter wheat with multiple objectives (1): the BETHA system. *Agric. Syst.*, 72: 9-31.
- Matthews R., 2002. Crop management. In: Matthews, R., and Stephens, W., (eds) *Crop-soil simulation models: applications in developing countries*. CABI editions, pp 29-53
- McCown R.L. et al. 2002. Probing the enigma of the Decision Support System for farmers: learning from experience and from theory. *Agric. Syst.*, 74, 1-10.
- Schärlig A., 1985. *Décider sur plusieurs critères, Panorama de l'aide à la décision multicritère*, Presses polytechniques et universitaires romandes, Lausanne.
- Sadok W. et al., 2008. Ex ante assessment of the sustainability of alternative cropping systems: guidelines for identifying relevant multi-criteria decision aid methods. *Agric. Sust. Dev.*
- Sébillotte M., 1990. *Système de culture, un concept opératoire pour les agronomes*. In : *Les systèmes de culture*. L. Combe and D. Picard eds, INRA, Paris. 165-196.
- Sinclair T.R., Seligman N.G., 1996. Crop modeling: from infancy to maturity. *Agron. J.*, 88, 698-704.

## INTEGRATED ASSESSMENT OF FARMING SYSTEMS

Martin van Ittersum, Frank Ewert and Ken Giller

Plant Production Systems group, Wageningen University, The Netherlands, martin.vanittersum@wur.nl

### Introduction

Farming systems around the globe differ enormously – driven by the natural, economic, social and political conditions within which they operate. As a result they show a broad range of resource endowments, available technologies, designs and performance. Common features of all farming systems are that they manage natural and economic resources and conditions that vary in time, with limited production alternatives while facing relatively low profit. They have to adapt to either unstable or unstructured policy environments or to policy environments that aim at enhancing the economic, environmental and social sustainability of farm systems and, more importantly, the contribution of farming systems to sustainable development at large. They must adapt and innovate within this changing context. Both the variation in farming systems and the common characteristics of farms lead to uncertainties about the effectiveness of decisions, from a farmer's and from a policy perspective. The assumption underlying our contribution is that *ex-ante* integrated assessment of farming systems can reduce these uncertainties.

Integrated assessment and modelling has been defined as an interdisciplinary research approach enhancing the management of complex environmental systems (Parker et al., 2002). Integrated assessment is a notion stemming from the climate change, environmental pollution and water management domains and it has been used relatively little in the context of agricultural and farming systems. Agricultural science has a history in applying systems analysis. Although the concept of integrated assessment has been used rarely, many studies of agricultural systems hold an integrated perspective and could serve integrated assessments.

We introduce some key requirements for integrated assessment of farming systems aimed at reducing the uncertainty about the effectiveness of innovation decisions and policy proposals, and illustrate approaches taken through recent examples.

### Methodological requirements for integrated assessment

Integrated assessment of farming systems may have at least two categories of aims and associated users. First, to contribute to the design and innovation of farming systems, with farmers, applied researchers and stakeholders working with farmers as major users. Second, integrated assessments may target assessment of alternative policy options, with policy experts, policy researchers and stakeholders being the major users. We suggest the categories have some overall methodological requirements for research supporting integrated assessment. First, the methods must treat the economic, environmental and social dimensions of sustainable development in a balanced way. Many of the quantitative methods currently used are biased towards either the economic or environmental aspects and largely miss out the social issues. Second, methods must have the capability to analyse across multiple scales. At farming systems level decisions are endogenous, whereas farming systems are composed of activities at field or animal herd level for which decisions are exogenous. Prices are exogenous at individual farming system level, but endogenous at market level. Further, farming systems shape the agricultural landscape jointly with other land uses. As a result of this, research methods for integrated assessment of farming systems require multi-scale capabilities. Thirdly, model-based research for integrated research must be performed at the proper level of detail for the questions at stake. Too much detail bears the risk of compromising on modeling the most important processes whereas overspecification and too much complexity of the models results in data demands that cannot be met. Too little detail implies that relevant indicators may not be assessable with the required reliability. This requirement relates to the fourth issue: usability and usefulness of the research tools. To meet this requirement the tools should be targeted at well-specified questions, have credibility, transparency and be well-embedded in innovation or policy processes. Finally, since questions at stake usually change rapidly over time - both for innovation and policy development - re-use and flexibility of the tools is important to justify the research investment.

### **Examples of integrated assessment methods and applications**

Examples will be elaborated in our presentation to illustrate the methodological requirements introduced in the previous section. A first example assesses rice-based systems in Ilocos Norte, in the Philippines at three hierarchical levels, i.e. farm, municipal and regional levels (Laporte et al., 2007). The aim of the developed methodology was to explore and assess alternative agricultural land use options and technologies. The analysis was targeted primarily at stakeholders at these hierarchical levels to raise their level of understanding as to options for innovation, and associated policies that might stimulate such innovation. The second example aimed at innovation of vegetable farming systems in Uruguay. Alternative vegetable farming systems, with or without integration of livestock, are assessed in terms of their economic and environmental performance and tested as to their social acceptability through an interactive process with farmers (Dogliotti et al., 2005; Sterk et al., 2007). In a third example a model-based system is developed to assist understanding of smallholder farming systems in Africa, focusing on heterogeneity within such farms and between farming households as well as their functioning in time (Giller et al., 2006). This is used to identify key entry points for improving performance of the farms, and to explore policy conditions that enable or constrain innovation by farmers. The fourth example assesses alternative policy proposals in the European Union, for the broad range of farm types that differ in size, intensity, land use and specialization. For this purpose an integrated framework (SEAMLESS-IF; Van Ittersum et al., 2007) is being developed that allows the assessment of agricultural systems at field-farm-regional and market level. The framework includes both field level simulation models, bio-economic farm models, a market model and a procedure to link from the micro level to the macro level, i.e. to simulate farm-market interactions.

### **Reflections and challenges**

To conclude we discuss the main challenges for the development of quantitative methods for integrated assessment of farming systems, within the context of several sessions of this Farming System Design symposium. We suggest that joint consideration and analysis of economic, environmental and social issues is achieved with increasing insight. Economic and environmental issues are assessed in a more balanced way (though a lack of consistent micro-macro linkages still hinder developments). We argue that social indicators could be assessed to some extent through post-analysis interpretation of model results with users and stakeholders, and the use of primary data sources. This would allow estimation of social indicators related to acceptability of innovations and policies, institutional compatibility, education and gender. A major challenge for multi-scale capabilities is the scaling of information from field to farm and from farm to higher levels of organization. General principles and methods are hard to identify as best methods often depend on the question and conditions at stake. Linking micro (farm) and macro (market) analysis is currently addressed with econometric procedures using statistical representation, but remains to be validated. The last three issues: integrated assessment with proper degree of detail; usefulness and usability; and re-use and flexibility are interrelated. Issues of availability of consistent data, software requirements and transparency are key. Model-based analyses are powerful learning tools in interactions with stakeholders, in theory, but proper and iterative embedding of research efforts in integrated assessment processes is equally important. This highlights a challenge for the interface between science and society in which we as researchers have an ambition to play a role.

### **References**

- Dogliotti, S. et al., Influence of farm resource endowment on possibilities for sustainable development: a case study for vegetable farms in South Uruguay, 2005. *Journal of Environmental Management* 78, 305-315
- Giller, K.E et al., Resource use dynamics and interactions in the tropics: Scaling up in space and time, 2006. *Agricultural Systems* 88, 8-27.
- Laporte, A.G. et al., Multi-scale analysis of agricultural development: A modelling approach for Ilocos Norte, Philippines, 2007. *Agricultural Systems* 94, 862-873
- Parker, P. et al., Progress in integrated assessment and modeling, 2002. *Environmental Modelling & Software* 17, 209-217.
- Sterk, B. et al., Computer models in action – Learning by doing in an Uruguayan on-farm research project, 2007. Submitted.
- Van Ittersum, M. et al., Integrated assessment of agricultural systems – A component-based framework for the European Union (SEAMLESS), 2007. Accepted for publication in *Agricultural Systems*.

## INTEGRATED ASSESSMENT OF AGRICULTURAL SYSTEMS: A CHALLENGE OF SYSTEM AND MODEL COMPLEXITY

J.J Stoorvogel<sup>1</sup>, J. Antle<sup>2</sup>

<sup>1</sup> Landscape Centre, Wageningen University, The Netherlands, jetse.stoorvogel@wur.nl

<sup>2</sup> Dep. of Ag. Econ. and Econ., Montana State University, USA, jantle@montana.edu

### Introduction

There is an increasing demand for the integrated assessment of complex agricultural systems. Integrated modeling approaches are a common tool to deal with this type of analysis. However, despite the fact that simulation models are simplifications of reality, we see that these models become increasingly complicated. Additional processes are included to make the models generic and to describe properly the observed variation in these agricultural systems. The complexity of these models coincides with an increase in data requirements. As a result of the almost unrealistic data requirements, many applications are unable to collect the input data. Several approaches are being used to deal with the data requirements. Many studies use default model values for data that were not available and/or difficult to measure. In other studies transfer functions are used to estimate e.g., complex hydrological properties on the basis of soil texture and organic matter contents. In the case of significant spatial variation, studies use a limited number of representative locations (e.g. representative weather stations, representative soil profiles, or farm types). The question that remains is whether we should search for simplifications or whether we should look for more simple models that are capable to run the key processes using mostly available data? In this study, we looked at the Tradeoff Analysis Model and its application to the potato-pasture-wheat system in the Peruvian Andes (Antle et al., 2007). Crop growth simulation models, econometric simulation models, and mechanistic erosion models are integrated through the Tradeoff Analysis Modeling system (Stoorvogel et al., 2004) to properly describe this complex system. The advantage of the integrated modeling approach is that we can evaluate a wide range of alternative scenarios ranging from climate change, terrace adoption, to economic policies. The key question that remains is whether we need such a complex modeling system if we are interested in a specific policy or research question. To illustrate this we will look at the specific issue on the adoption of terraces.

### Methodology

The study focuses on the semi-arid La Encañada watershed in the Cajamarca region in northern Peru. The 10km<sup>2</sup> watershed ranges between 2,950 to 4,000 meters above sea level and is located between 7°00' and 7°07' southern latitude and between 78°15' and 78°22' western longitude. Average annual rainfall is low ranging between 430 mm/year in the valleys up to 550 mm/year in the higher parts of the watershed. The data used in this analysis were collected through farm surveys conducted in 1997-1999 for a random stratified sample of 40 farm households in five communities in the watershed. The data show that crop yields are low and parcel size is small, as is typical of this type of semi-subsistence agriculture. The analysis reported here is based on the lower-hillside region where cropland is the principal land use. In the last decades a large number of fields were terraced to reduce soil erosion and maintain soil fertility. The Tradeoff Analysis Model simulates land allocation and management decisions of a population of farmers in a site-specific manner. First, the expected productivity for potato and pasture for the various fields is simulated using calibrated crop growth simulation models from the DSSAT suite of models (Jones et al., 2003). Subsequently, production functions for input demand and output supply are estimated for the three main cropping systems: potato, wheat, and pasture. The expected productivity for the different crops is an important driving factor in these production functions. The production functions can now be used in an econometric simulation model to simulate management decisions under various scenarios. Land allocation is determined on the basis of profit maximization. After simulating land use for the population of agricultural fields, farms can be evaluated in terms of soil erosion by simulating soil erosion for the various fields with the WEPP model (Flanagan and Nearing, 1995). Various elements of the modeling approach are evaluated in this study. Firstly, a simple statistical relationships to assess crop production was assessed rather than crop growth

simulation models with their high data requirements. Secondly, a simple minimum data approach was developed in which the econometric simulation model was simplified to a model that calculates the opportunity cost related to the switch in farming practices. The modeling approaches are applied to evaluate the adoption of terraces under different prices of terracing.

## Results

The results show that the inherent productivities calculated by the crop growth simulation models are strongly correlated to a few environmental properties representing the local weather and soil conditions. This correlation indicates that for specific questions we can use the environmental characteristics rather than the inherent productivities as input for the econometric simulation model. However, the statistical relationships are not useful if we deal with changes in agricultural management or climate change. We obtain similar results if we simplify the econometric simulation model to study the adoption of terraces. A relatively simple analysis of the opportunity cost to switch practice presents similar results as the rather complex econometric simulation model. We can describe the processes being modeled in terms of their spatial and model complexity. Spatial complexity refers to the spatial heterogeneity and dependence observed in biophysical conditions (e.g., topography, soils, and climate) as well as in economic and related human dimensions (e.g., prices and market institutions). Model complexity refers to features of model processes such as nonlinearity, dynamics, feedbacks, and spatial dependence. The various combinations of spatial and model complexity require a specific model design. This is illustrated with the Peruvian case study but also in an earlier study dealing with payments for environmental services (Antle and Stoorvogel, 2006).

## Conclusions

If we deal with very specific research questions, the complex potato-pasture system in the Peruvian Andes can be described by a relatively simple model. However, a more generic but also more complex model becomes important if we broaden the research questions. There is a general demand for simpler methods that provide adequate approximations. Alternative, minimum data approaches based on relatively simple empirical approximations to the relevant spatial distributions may be a new innovative way to deal with these problems. While further research will be needed to assess the adequacy of this type of simpler modeling approaches in different ecological and economic settings, the results suggest that this type of approach may often suffice and in fact be the only one feasible to support policy decision making, given time and other resource constraints.

## References

- J.M.Antle et al., Assessing the Economic Impacts of Agricultural C Sequestration: Terraces and Agroforestry in the Peruvian Andes, 2007. *Agric., Ecosyst. Environ.* 122: 435-445
- J.M.Antle, J.J. Stoorvogel, Predicting the supply of ecosystem services from agriculture, 2006. *Amer. J. Agr. Econ.* 88: 1174–1180
- D.C. Flanagan, M.A. Nearing, USDA-Water Erosion Prediction Project (WEPP). WEPP users summary, 1995. NSERL Report No. 10. USDA-ARS National Soil Erosion Research Laboratory, West Lafayette, Indiana
- J.W.Jones et al., The DSSAT cropping system model, 2003. *Europ. J. Agron.* 18: 235-265
- J.J.Stoorvogel et al., The Tradeoff Analysis Model: Integrated Bio-Physical and Economic Modeling of Agricultural Production Systems, 2004. *Agric. Syst.* 80:43-66

## MODELLING FOR INNOVATION IN DESIGN AND CONSTRUCTION OF CROP PRODUCTION SYSTEMS

G. L. Hammer<sup>1</sup>, D. Jordan<sup>2</sup>

<sup>1</sup> APSRU, School of Land, Crop and Food Sciences, The University of Queensland, Brisbane, Qld., Australia, [g.hammer@uq.edu.au](mailto:g.hammer@uq.edu.au)

<sup>2</sup> Queensland Dept. Primary Industries & Fisheries, Warwick, Qld., Australia, [David.R.Jordan@dpi.qld.gov.au](mailto:David.R.Jordan@dpi.qld.gov.au)

The role of models in innovation has become widely recognised in many fields (Schrage, 2000). Schrage notes that innovative prototypes create innovative teams and treating prototypes as conversation pieces caters for the complex human interplay required in innovation. This is his notion of serious play. Hence, model prototyping and simulating are important, but not sufficient, factors underlying innovation. Focusing on participation of key players, and realising the central roles of dialogue and co-learning, are equally important factors in the innovation process.

These general concepts have now been largely accepted and adopted in various approaches leading to the development of improved cropping practices with farmers (e.g. Hammer, 2000; Keating and McCown, 2001; McCown, 2001; Meinke et al., 2001; Carberry et al., 2002; Nelson et al., 2002). Scientists can bring potential innovation to farming systems practice, but this must be explored within the context of the real farming system. Simulation-based discussion provides an effective means to achieve this.

But farmers and their advisers are not the only relevant players in using models as tools for production system innovation. Hammer et al. (2002) set out a case for the use of models in understanding genetic regulation and aiding crop improvement. Physiological dissection and modelling of traits provides an avenue by which crop modelling could contribute to enhancing integration of molecular genetic technologies in crop improvement (Yin et al., 2004; Hammer et al., 2005; White, 2006). Models are seen as a bridge between the explosion in capacity and knowledge in molecular biology and genetics, and its application to plant improvement. Hammer et al. (2006) and Yin and Struik (2007) have recently reviewed the potential for models to help navigate this complexity and a symposium was devoted to this topic at the most recent International Crop Science Congress (see Cooper and Hammer, 2005). There has been a focus on ways to quantitatively link model coefficients with underlying genomic regions (e.g. White and Hoogenboom, 1996; Tardieu, 2003; Messina et al., 2006). It is then possible to incorporate such gene-to-phenotype models within breeding system simulators to compare breeding strategies (Cooper et al., 2002; Chapman et al., 2003; Hammer et al., 2005). Attempts to date have reinforced the need to address the inherent level of detail and quality of crop models for this task (Hammer et al., 2002; White, 2006). It is becoming clear that enhanced rigour in process representation, so that interactions and feedbacks are captured correctly, is required for effective gene-to-phenotype modelling. It is also clear that participatory research and co-learning with plant breeders, molecular biologists and other players in this field is a key aspect of using models for innovation in crop improvement programs (Hammer and Jordan, 2007). Again, the models and simulations become the discussion piece in seeking innovation.

To date innovations associated with the use of models in crop management or crop improvement have been incremental. They have been targeted at either management-by-environment (M\*E) or genotype-by-environment (G\*E) interactions. While useful changes have resulted in agronomic practice (e.g. Meinke et al., 2001; Carberry et al., 2002) and breeding efficiency (e.g. Campos et al., 2004; Loeffler et al., 2005), progress has been evolutionary.

In this paper we explore possibilities for revolutionary change in cropping systems by using models to help design and construct novel and innovative production systems. We consider that new possibilities for simultaneous consideration of genotype-by-management-by-environment (G\*M\*E) interactions provide the impetus. It was over a decade ago that Cooper and Hammer (1996) outlined the concept of fusing the agronomic (M\*E) and plant breeding (G\*E) perspectives of crop improvement into a single G\*M\*E (or G\*E\*M) approach. They outlined the concept of crop improvement as a search strategy on a complex adaptation or fitness landscape. The landscape consists of the phenotypic consequences of G and M combinations in target E. The phenotypic consequences of only a very small fraction of all possible G\*M\*E combinations can be evaluated

experimentally. Hence, most of the fitness landscape remains hidden to its explorer. However, technical developments in molecular genetics, computing, crop physiology and modelling now allow us to glimpse much more of the adaptation landscape in seeking ways forward. Here we set out thinking and initial steps in this regard for an on-going case study for the sorghum industry in NE Australia, where modelling is being used to aid industry planning and to help design and construct novel production systems for environments where water limitation is a dominating factor.

## References

- Campos, H., et al., 2004. Improving drought tolerance in maize: a view from industry. *Field Crops Res.*, 90:19-34.
- Carberry, P.S., et al., 2002. The FARMSCAPE approach to decision support: Farmers,' Advisers,' Researchers' Monitoring, Simulation, Communication, And Performance Evaluation. *Agric. Sys.*, 74: 179-220.
- Chapman, S.C., et al., 2003. Evaluating plant breeding strategies by simulating gene action and dryland environment effects. *Agron. J.*, 95: 99-113.
- Cooper, M. and Hammer, G.L., 1996. Synthesis of strategies for crop improvement, in M. Cooper and G.L. Hammer (eds.), *Plant Adaptation and Crop Improvement*. CAB International. pp. 591-623.
- Cooper, M., and Hammer, G.L., 2005. Complex traits and plant breeding: can we understand the complexities of gene-to-phenotype relationships and use such knowledge to enhance plant breeding outcomes? *Aust. J. Agric. Res.*, 56: 869-872.
- Cooper, M., et al., 2002. The GP problem: Quantifying gene-to-phenotype relationships. *In Silico Biol.*, 2: 151-164. <http://www.bioinfo.de/journals.html>.
- Hammer, G.L., 2000. Applying seasonal climate forecasts in agricultural and natural ecosystems – a synthesis. in G.L. Hammer et al. (eds.), *Applications of Seasonal Climate Forecasting in Agricultural and Natural Ecosystems – The Australian Experience*. Kluwer Academic, The Netherlands. pp. 453-462.
- Hammer, G.L. and Jordan, D.R., 2007. An integrated systems approach to crop improvement. In, J.H.J. Spiertz et al. (eds.) *Scale and Complexity in Plant Systems Research: Gene-Plant-Crop Relations*. Springer, Dordrecht, The Netherlands. pp. 45-61.
- Hammer, G., et al., 2005. Trait physiology and crop modelling as a framework to link phenotypic complexity to underlying genetic systems. *Aust. J. Agric. Res.*, 56: 947-960.
- Hammer, G., et al., 2006. Models for navigating biological complexity in breeding improved crop plants. *Trends Plant Sci.*, 11: 587-593.
- Hammer, G.L., et al., 2002. Future contributions of crop modelling – from heuristics and supporting decision-making to understanding genetic regulation and aiding crop improvement. *Eur. J. Agron.*, 18: 15-31.
- Keating, B.A. and McCown, R.L., 2001. Advances in farming systems analyses and intervention. *Agric. Sys.*, 70:555-579.
- Löffler, C., et al., 2005. Classification of maize environments using crop simulation and geographic information systems. *Crop Sci.*, 45: 1708-1716.
- McCown, R.L., 2001. Learning to bridge the gap between science-based decision support and the practice of farming: Evolution in paradigms of model-based research and intervention from design to dialogue. *Aust. J. Agric. Res.*, 52:549-571.
- Meinke, H., et al., 2001. Increasing profits and reducing risks in crop production using participative systems simulation approaches. *Agric. Sys.*, 70:493-513.
- Messina, C.D., et al., 2006. A gene-based model to simulate soybean development and yield response to environment. *Crop Sci.*, 46: 456-466.
- Nelson, R.A., et al., 2002. Infusing the use of seasonal climate forecasting into crop management practice in North East Australia using discussion support software. *Agric. Sys.*, 74:393-414.
- Schrage, M., 2000. *Serious play: how the world's best companies simulate to innovate*. Harvard Business School Press. Boston, Massachusetts. 244pp.
- Tardieu, F., 2003. Virtual plants: modelling as a tool for the genomics of tolerance to water deficit. *Trends Plant Sci.* 8, 9-14.
- White, J.W., 2006. From genome to wheat: Emerging opportunities for modelling wheat growth and development. *Eur. J. Agron.*, 25:79-88.
- White, J.W. and Hoogenboom, G., 1996. Simulating effects of genes for physiological traits in a process-oriented crop model. *Agron. J.*, 88:416-422.
- Yin, X. and Struik, P.C., 2007. Crop systems biology: an approach to connect functional genomics with crop modelling. In, J.H.J. Spiertz et al. (eds.) *Scale and Complexity in Plant Systems Research: Gene-Plant-Crop Relations*. Springer, Dordrecht, The Netherlands. pp. 63-73.
- Yin, X., et al., 2004. Role of crop physiology in predicting gene-to-phenotype relationships. *Trends Plant Sci.* 9, 426-432.



**Session 2.1:  
Novel production systems and systems for  
marginal areas**

**Session Convenors:  
Salvatore Cosentino, Carlos Diaz-Ambrona and  
Hans Langeveld**

## How to obtain a representative sample of economic studies in the areas with strong mobility? Case of the Senegalese Sahel (Ferlo)

A. Wane<sup>1</sup>, I. Touré<sup>2</sup>, B. Toutain<sup>3</sup>, V. Ancey<sup>4</sup>, A. T. Diop<sup>5</sup>, A. Ickowicz<sup>6</sup>

<sup>1</sup> Economist - URP Pastoralism – Cirad-PPZS, Dakar, Senegal, [awane@cirad.fr](mailto:awane@cirad.fr)

<sup>2</sup> Geographer - URP Pastoralism – Cirad-PPZS, Dakar, Senegal, [ibra.toure@cirad.fr](mailto:ibra.toure@cirad.fr)

<sup>3</sup> Pastoralist - URP Pastoralism – Cirad-PPZS, Montpellier, France, [Bernard.toutain@cirad.fr](mailto:Bernard.toutain@cirad.fr)

<sup>4</sup> Socio-economist - URP Pastoralism – Cirad-PPZS, Dakar, Senegal, [ppzsdkr@orange.sn](mailto:ppzsdkr@orange.sn)

<sup>5</sup> Veterinary-Pastoralist - URP Pastoralism – ISRA-PPZS, Dakar, Senegal, [amtadiop@orange.sn](mailto:amtadiop@orange.sn)

<sup>6</sup> Veterinary-Pastoralist - URP Pastoralism – Cirad-PPZS - Montpellier, France, [aickowicz@cirad.fr](mailto:aickowicz@cirad.fr)

### Introduction

The weakness of the Senegalese mechanisms to collect economical data and the dominance of informal exchanges explain the present gaps in the statistics concerning the primary economic sector, and subsequently the livestock sector. The pastoral extensive livestock production system, localized in the Sahelian region, the Ferlo, is concerned. This complex system constitutes apparently more or less organized networks and market chains justifying statistical economical analyses to understand their dynamic (Hatfield and Davies, 2006). These analyses, however, are constrained by methodological difficulties caused by the mobility of the population and the extent of area (Ferlo covers 67610 km<sup>2</sup>, the third of the Senegalese territory). *In this context, how to obtain a representative sample for economic analysis of the most important livestock production area in Senegal?* The aim of this contribution is the formalization of a data collection methodology adapted to the study of pastoral mobile populations. The results of the application in Ferlo provide primary data about pastoral activities, a basis for economic analysis and their relevance are discussed.

### Methodology

We propose an approach at two sampling levels for countries lacking in reliable statistical data.

**Frame 1: sampling process in Ferlo**

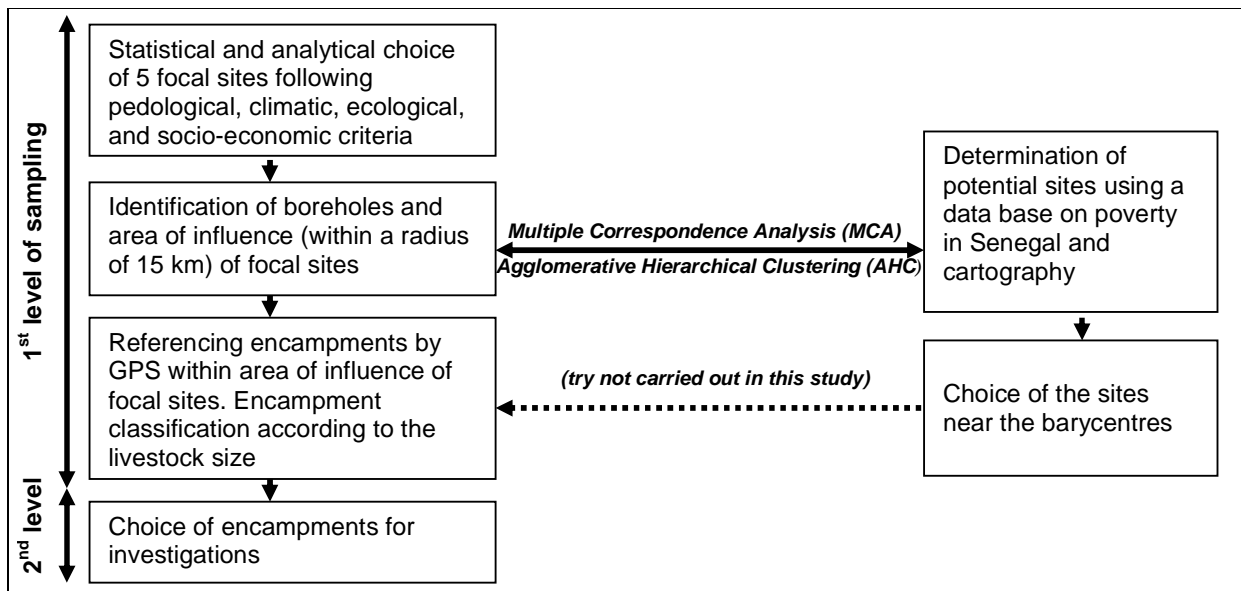

We call focal sites delimited areas where ecological factors, populations and activities present a certain unity. At this stage is applied a data analysis using Multiple Correspondence Analysis (MCA) and Agglomerative Hierarchical Clustering (AHC). These focal sites were our first places of investigation according to the time, the human resources and the money available. The other sites not selected are kept to test the relevance of the site selection and could be used for a scaling up of the study. The tools used for statistical analysis was Xlstat Pro 7.5 and for the geographical approach and cartography the software Map Info 7.0. The investigation units are the encampments. The pastoral family is formed by a whole of households. They are units of management and production, agglomerated in the basis of extensive family relationships in houses

which represent units of residence and accumulation. In a broadly scale, the socio-economics' units which are houses are gathered together in large whole called encampments.

**Results**

The main result deals with the uniform spatial distribution the seasonal encampments within the areas around a pastoral borehole with a 15 km radius, and a similar area around the site named Mbame, which has only pastoral wells (figure 1).

The sampling size was set beforehand according to standard statistical rules in the absence of complete characterization of the sites. At the confidence interval of 95%, the 3% (5%) error margin, the proportion of 50% on an initial population of 740 encampments, the size of the theoretical sampling must be 438 (253) encampments. This (these) sampling(s) was (were) proportionately distributed between the focal sites according to the densities of referenced encampments.

A reprocessing, reclassifying and cross-checking work has been done to keep only questionnaires with completes informations. Finally, we obtain a sample of 276 encampments. This remains within standard statistical norms with an error margin of 4.68% and a confidence interval of 95%. Many results have been obtained. Some of them are briefly presented here.

**Distribution of trading income** (figure 2)

- Gini index (Ferlo): 52.8%
  - Gini index (rural): 31.7% in 1995; 29.9% in 2002 (Direction of Statistics Forecast and the World Bank)
  - Average income is below the standard deviation: this shows the inequalities for income between pastoralists
  - 37% of the poorest encampments earn only 10% of the pastoral trading income;
  - Within-sites inequalities represent 21% of total inequality
  - Between-sites gross inequalities constitute 79% of total inequality.
- (Wane, Ancey and Touré, 2007)

Figure 1: spatial distribution of the investigated encampments

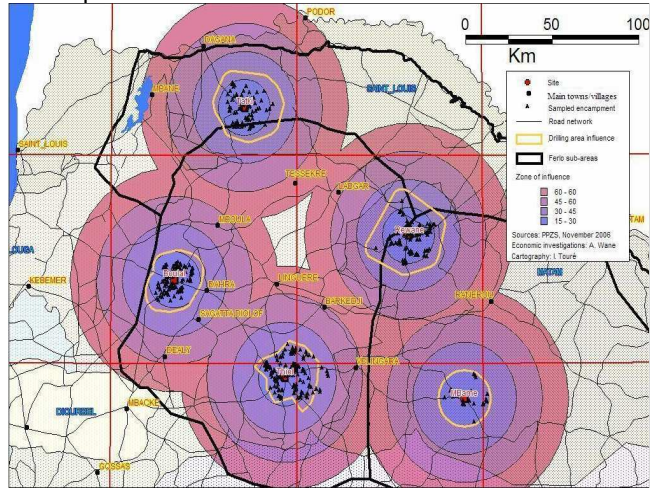
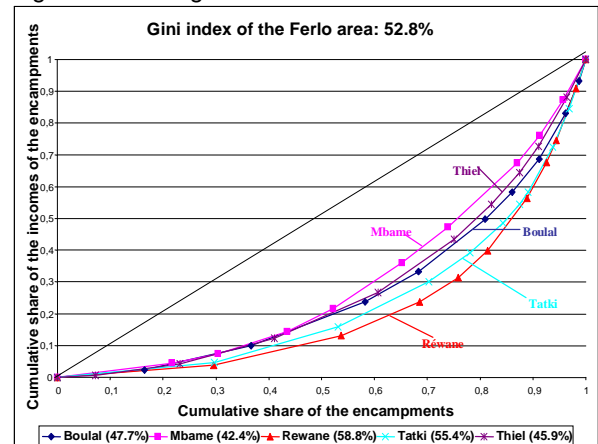

Figure 2: Investigated areas – Concentration curves



**Conclusion**

We showed that it is possible to use statistical and analytical tools to better understand the pastoralism which is an adaptation to marginal environments, characterized by mobility, climatic uncertainty and scarce resources. This orientation will contribute to demonstrate the usefulness of economic evaluation as a decision making tool and an economic argument to obtain appropriate policies for pastoral systems which concerns the Sahelian area, and more globally the arid lands.

**References**

Hatfield R., Davies J., Global Review of the Economics of Pastoralism, 2006, Report prepared for the WISP project (World Initiative for Sustainable Pastoralism) with contributions from A. Wane, C. Kerven, C. Dutilly-Diane, J. P. Biber, J. L. Merega, M. O. Odhiambo, R. Behnke and S. Gura, IUCN: Nairobi, 47 p.  
 Wane A. *et al.*, Assets of the Market, Assets of the Rural World - Spatial Distribution of Trading Incomes in Ferlo (Senegalese Sahel) Pastoral Populations, 2007, submitted to *Natural Resources Forum*, May, 15 p.

## INTERVENTION OF INTEGRATED HOME GARDEN MODEL FOR FOOD SECURITY, NUTRITION AND POVERTY ALLEVIATION

M. Akkas Ali<sup>1</sup>, M. Robiul Alam<sup>2</sup>, M.S.H. Molla<sup>2</sup> and M. A. Momin<sup>3</sup>

Senior Scientific Officer <sup>1</sup>, Scientific Officer <sup>2</sup>, Principal Scientific Officer <sup>3</sup>

On-Farm Research Division, Bangladesh Agricultural Research Institute, Panba 6600, Bangladesh.

Presenter and Corresponding author: M. Akkas Ali ([makkas62@yahoo.com](mailto:makkas62@yahoo.com))

### Introduction

Insecure food, malnutrition, unemployment and poverty are the common feature of a developing country like Bangladesh. More than 30,000 children are suffering from blindness each year (BARC 1990) and majorities of its population are lack in required amount of vitamins (81%), protein (60%) and minerals (Mahmud, 1985). About 17.5 millions of homesteads are there in the country which can help producing sufficient vegetables and fruits for the concerned families. These homesteads are the most effective production units for supplying food, fuel, timber and other farming activities. Farmers practices different patterns of vegetable and fruit in the vicinity of house hold but almost all are unplanned, poor yielded and non-scientific. Thus, it was felt that a complete model is needed for homestead production. A model was tried with 9 possible production units to avoid the shortfalls stated above with the following objectives i) Maximum utilization of homestead spaces and time round the year with fruit and vegetables, ii) Ensure food security round the year and build up family consumption habit with nutritional quality, iii) Create employment opportunity for family members, cash generation and develop women members for decision making and gender equity.

### Materials and methods

The study was carried out at Farming Systems Research and Development (FSRD) site, Bangladesh Agricultural Research Institute, Pabna during 2001-05. Fifteen female-participated farm families- five from each of marginal, small and medium farm category were involved in the test model. Nine cropping patterns were used for 9 production niches (viz. open land, fence, trellis, non-fruit tree, partial shady area, roofs of cottage, marshy land, home boundary and backyard) and selection of crop varieties were finalized with the active participation of the cooperators in accordance with their preference and resources in decision-making process. There was a flexibility of plot and/or space sizes of each production niche to avoid complexity of the study. Recommended crop production technologies were used for the study. Inputs and operational cost bore by the participant cooperators except some critical inputs. A register was kept in each trained farm family for data collection, which was checked and finalized by the FSRD staff on weekly basis. The collected data were checked, processed and analyzed for interpretation.

### Results and Discussion

#### *Production of vegetable*

The production of vegetables increased remarkably in the intervention of integrated model (Table 1). Average production was 746 kg family<sup>-1</sup> during 2001-05, which was above 4 times compared to previous (178 kg) model (Islam et al., 1996). Highest production was obtained from creeper group of whom bottle gourd, white gourd and sweet gourd were the major contributors. The total production from newly included spaces was 2.38 times higher than the open space. The increase in crop yields was due to better management with improved skill in production practices.

#### *Production of fruits*

The fruit yield from existing trees was 810 kg family<sup>-1</sup> year<sup>-1</sup> where main contribution was from mango. Mango yield was increased by about 3.37 times due to better pest and agronomic management. But there is still wide scope to improve yield with jujube, jackfruit litchi and guava. The new fruit trees introduced in the model are expected to increase production remarkably.

#### *Food security and family nutrition*

Adequate amount of nutritious fruits and vegetables were supplied round the year averaging 710 g day<sup>-1</sup>person<sup>-1</sup> (Table 1). The average consumption of fruits was 920 g day<sup>-1</sup> family<sup>-1</sup>, much higher than daily requirement and 3.3 times higher (280 g) than non-project areas (Akhtar et al., 2000). The average production per day of both vegetables and fruits were 2.04 and 2.22 kg which all together, was 2.84 times higher than the need for family consumption and 5 times higher than the national average (396 g) family<sup>-1</sup> (Rashid, 1999). As production of food items lead to its added consumption and also increase distribution (22%) to relatives and sale (35%) to the buyers (Table

1). The percent consumption of vegetables and fruits were 45 and 42% of production only. The supply of nutrients from fruits and vegetables of the tested model surplus the need for most of the wanting essential nutrients like Vitamin A, C, calcium and iron-previously deficient in the diet. An Ample amount of Vitamin B1, B2, protein and energy were also obtained from the supplied food of the model (Table 2).

Table 1. Av. yield of vegetable, fruits, gross return, disposal pattern and cash income of integrated model.

Crops	Yield family <sup>-1</sup> (kg)	Return family <sup>-1</sup> (kg)	Disposal of the produce family <sup>-1</sup> (kg)			Cash income (Tk.)
			Consumption	Distribution	Sale	
Vegetables	746	2,832	337 (45%)	105 (15%)	304 (41%)	1,143
Mean family <sup>-1</sup> day <sup>-1</sup>	2.04	8	0.92	0.29	0.83	3.13
Fruits	810	8,664	334 (42%)	238 (29%)	238 (29%)	1,979
Mean family <sup>-1</sup> day <sup>-1</sup>	2.22	24	0.92	0.80	0.65	5.42
Grand total (Veg. + Fruits)	1,556	11,496	671(43%)	343(22%)	542(35%)	3,122
G. Mean family <sup>-1</sup> day <sup>-1</sup>	4.26 (710 g)	31.5	1.84	0.94	1.48	8.55
Total cost for the model(Tk.)	-	350	-	-	-	-
Benefit cost ratio	-	32.85	-	-	-	-

Table 2. Average yield of vegetables, fruits and nutrient contents of integrated model.

Crops	Yield (kg)	Content of nutrients							
		Carotene (µgm)	Vit.C (µgm)	Vit.B-1 (µgm)	Vit.B-2 (µgm)	Calcium (µgm)	Iron (µgm)	Energy (kcal)	Protein (gm)
Vegetables	746	14,959	320,298	1306	655	1409,927	113,322	767,412	16,861
Mean family <sup>-1</sup> day <sup>-1</sup>	2.04	41	878	4	2	3,863	310	2,102	46
Fruits	810	29,597	187,588	404.9	318	82,117	21,864	397,511	6,164
Mean family <sup>-1</sup> day <sup>-1</sup>	2.22	81	514	1.11	0.87	225	60	1,089	16.89
Total from both resources	4,026	122	1,392	5.11	2.87	4,088	370	3,191	6.89
Daily needs family <sup>-1</sup> *	1.5	10	260	7.0	6.3	3,000	145	14,100	284
% of requirement supplied	284	1,220	535	73	46	136	255	23	22

\*Estimated from data provided by Haque (1985) for 6 members family

#### *Income generation and poverty reduction*

The average gross return was obtained Tk. 11496 per family from the model with a very little cash investment (Tk. 350 year<sup>-1</sup>, 1 US\$ = Taka 68). The average BCR on cash cost basis was over 32.85. This cash is generating round the year enabling the poor cooperators to meet up immediate family needs like purchase of edible oil, lighting fuel (kerosene), pulse, salt and spices despite borrow money with high interest from land lord. Opportunity created for employment of underused women and children labors in the homestead activities. Sufficient amount of nutrients supplying from the food of the model, which is helped in crossing poverty level (23% energy, Table 2).

#### *Empowerment of women and gender equity*

The women members were actively participated in the program and involved in majority of the gardening activities, earned 24% of family income, and participated in different group activities, trainings and field days. Even 40% women alone made decision in different activities (data not shown). This empowerment enabled women in attaining gender equity and increase prestige in the family as well as in the society.

### **Conclusions**

The vegetable production model of Pabna is a holistic and intensive system produced highest nutrients and vegetable compared to any such model tested for far in the country. It is based on traditional and natural systems, which is easily transferable in most of the under developed countries. Only change of crop species and varieties may be required to fit in the model.

### **References**

- Akhtar et al., Existing homestead production and utilization systems. Annual report 2000. OFRD, BARI, ARS, Pabna. Pp. 7-18.
- BARC, Farming Systems Agribusiness Newsletter. 1990. Vol.1 (2). Bangladesh Agril. Res. Council, Dhaka.
- Islam et al., Homestead vegetable production. A means of household food security and nutrition for marginal farmers in northwest Bangladesh. 1996. Symposium proceedings. 14<sup>th</sup> International Symposium on Sustainable Farming Systems, 11-16 Nov., 1996, Colombo, Srilanka, pp. Twi/81-89.
- Mahmud, S.A., Introductory: Cultivation and nutritional identity of fruits and vegetables. 1985. Dept. of Agricultural Extension, Khamarbari, Dhaka.
- Rashid, M.M., Shobji bijyan. Second edition. 1999. Rashid Publishing House. 98, DOHS, Dhaka. pp.43-51.

## A FARM BASED MODEL TO TEST THE SUITABILITY OF NEW COTTON CROPPING SYSTEMS WITH FARMERS IN MALI

B. S. Traoré<sup>1</sup>, B. Rapidel<sup>2</sup>, K. Louhichi<sup>3</sup>, B. Barbier<sup>2</sup>, H. Belhouchette<sup>4</sup>

<sup>1</sup>Institut d'Economie Rurale (IER), [bouba.traore@ier.ml](mailto:bouba.traore@ier.ml) ;

<sup>2</sup> Centre International de Recherche Agronomique pour le Développement, [bruno.rapidel@cirad.fr](mailto:bruno.rapidel@cirad.fr) et [bruno.barbier@cirad.fr](mailto:bruno.barbier@cirad.fr), <sup>3</sup>Centre International de Hautes Etudes Agronomique Méditerranéenne [louhichi@iamm.fr](mailto:louhichi@iamm.fr); <sup>4</sup>INRA-Agro M. UMR SYSTEM; [Belhouch@ensam.inra.fr](mailto:Belhouch@ensam.inra.fr)

### Introduction

Mali's cotton production was doubled and nears record levels in the last decade attributed to the increased planted area, as well as favourable weather and few pest problems. However, this record wasn't followed by an improvement of cotton productivity (i.e. yield's level) which practically stagnated since several years (IER/CMDT/OHVN, 1998). To enhance cotton's yield, agronomic researchers have proposed new cropping techniques more efficient and suited to a wide range of socioeconomic and biophysical conditions. The new techniques are usually designed at the plot level within research stations and sometimes in farmers' plots. Their adoption by farmers has been slow. To facilitate their adoption by the farmers, it appears necessary to establish a dialogue between the agronomic research and the farmers. To assist this dialogue a farm model, developed within the EU FP6 SEAMLESS project, was used. Named FSSIM (i.e. Farm System Simulator), this model consists of a non-linear programming model calibrated at the farm level. It was applied to representative farms, in order to (i) identify farms' bottlenecks, (ii) test the suitability of new cropping patterns at the farming system level, (iii) define new areas for joint research on new cropping techniques, and (iv) improve the quality of the technical exchanges with farmers.

### Methodology

The used method in this study was based on the farm model "FSSIM" developed within the EU FP6 SEAMLESS project. The principal specifications of this farm model are: (i) a static model with a limited number of variants depending on the farm types and conditions to be simulated. Nevertheless, for incorporating some temporal effects, agricultural activities are defined as "crop rotations" and "dressed animal" instead of individual crops and animals; (ii) a risk programming model with a basic specification relating to the Mean-Standard deviation method in which expected utility is defined under two arguments: expected income and risk; and (iii) a positive model in the sense that its empirical applications exploit the observed behaviour of economic agents and where the main objective is to reproduce the observed production situation as precisely as possible (Louhichi et al, 2006).

The application of FSSIM model has required the following steps: (i) classifying the farms in homogeneous groups in order to cover the diversity of farming systems; (ii) defining the group of researchers and farmers to be involved in the discussion as well as their corresponding roles; and (iii) selecting the principal cotton cropping techniques to test and their implementation in FSSIM model.

### Results

The model was applied to the three identified farm types, however, for several reasons we have decided to show in this paper the results of only one farm type called "large farm". The main characteristics of this farm type are an extensive agro-sylvo-pastoral system based on cotton crop grown on biennial and triennial rotations and a farm size around the 12 ha. Graph 1 illustrates the calibration degree of the FSSIM model in the selected farm type. It shows a relative correct approach of the real decision-making process of farmers, for both the bio-technical management and the economic results. Indeed, the percent deviation between the observed and the simulated area of the principal crops such as cotton, sorghum, millet and mani doesn't exceed 2 percent. The only difference was represented by the substitution of groundnut by maize which is over-estimated. However, it is necessary to recall that only the current cropping techniques were taken into account in the calibration

phase. Farmers and researchers have approved the results of the calibration phase and have judged positively the model quality.

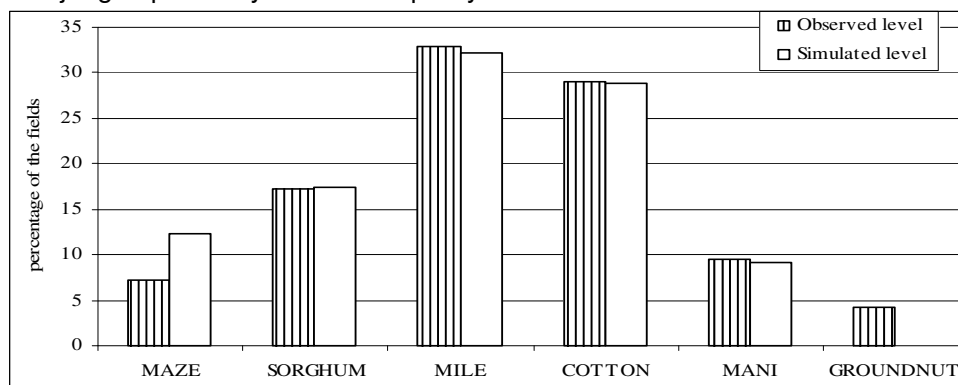

Fig. 1. Comparison between the observed and simulated crop patterns

After model calibration and validation, we started simulation by including the new cotton techniques as alternative techniques that can be selected by the model. The results of this simulated scenario are shown in the following Table. These results are compared to those of the calibration phase (called “reference run”) in order to detect their technical and economic results.

Table 1. Comparison between reference and simulated scenarios

		Reference run	Scenario (% deviation to reference run)
<b>Farm income FCFA</b>		1517351	+ 2
<b>Crop pattern</b>	Cotton – with old techniques	3.44	- 34
	Cotton – with new techniques	0	+ 66
	Maize	1.47	- 10
	Mile	3.83	+ 40
	Mani	1.08	+ 7
	Sorghum	2.07	+11

As shown in Table 1, the adoption of new cotton cropping techniques induces better performances in economic term due to the high profitability of these techniques. In term of cropping pattern, the introduction of new techniques leads to a small increase of cotton area as well as a replacement of old techniques by the new one. However and as expected, the model chooses to adopt partially the new cotton cropping techniques as farmer hasn't enough financial and labour capacities to apply these techniques to all the crops. Although these results show significant tendencies, they must be interpreted with caution according to the assumptions retained and to the choices made by the model.

**Conclusion**

Even if the generated results from FSSIM seem exaggerate the positive impact of these new techniques and couldn't reflect the plausible situation, this test case shows the relevance and the adaptability of this kind of tool to assist the dialogue between researchers and farmers while developing new technology as well as to accompany farmers and decision makers in their considerations on the future control of farms in a dubious environment.

**References**

IER/CMDT/OHVN, 1998. Mémoire de réunion de concertation sur la baisse de rendement de la variété NTA 88-6 au cours de la campagne 97/98.(N'Tarla,Mali, Institut d'Economie Rurale):34 P  
 Louhichi et al. A first version of FSSIM for the arable farming sector to be used within Prototype 1 of SEAMLESS-IF, 2006. SEAMLESS report n° 5, www.seamless-ip.org

## **POTENTIAL ROLE OF MEDICINAL AND AROMATIC PLANTS FOR THE SUSTAINABLE DEVELOPMENT OF MEDITERRANEAN MARGINAL LANDS.**

A. Carrubba, C. Catalano

Dep. for Land and Environmental Agronomy, Univ. Palermo, Italy, [acarr@unipa.it](mailto:acarr@unipa.it) )

### **Marginality and the Mediterranean lands**

According to the definition of “marginality” offered by CGIAR in 1999, “marginal lands” are all those “having limitations which in aggregate are severe for sustained application of a given use”. Due to their special configuration, marginal lands cannot be cultivated like the other territories, simply because their resources cannot sustain the weight of an ordinarily managed agriculture, and with an inappropriate management they are at risks of irreversible degradation. It is necessary therefore to find some agroecosystem able to guarantee the optimisation of the use of resources and their correct maintenance in time, under the assumption of the maximum economy of off-farms inputs. Due to a number of reasons, many Mediterranean lands, including a number of areas in the inner part of Sicily, cope with severe conditions of socio-economical marginality, sometime leading to the interruption of any agricultural activity and to the abandonment of the territory.

### **The potentialities of MAPs**

Medicinal and aromatic plants (MAPs) are a huge category of crops largely cultivated all over the world both for fresh consumption and with the purpose to give raw matter to many industrial sectors. Their cultivation has been considered for a long time just as a secondary agricultural practice, and their inclusion among the so-called “niche” crops has gained the result that in most cases they are by default excluded from the number of species to be cultivated in order to obtain some income. Nevertheless, many recent studies have been performed all over the world with the purpose to include “alternative” or “not common” crops in a large number of cropping systems. As a result, also the cultivation of MAPs nowadays may take different aspects according to the environmental and socio-economical features of the interested areas, with all the possible gradations from the intensive and highly efficient farming systems in the most developed areas to the extensive and scarcely efficient ones in developing countries. Once defined the most significant traits of the area under study, even inside Mediterranean marginal lands it shall be possible to find a productive strategy in which MAPs will find a proper fitting.

### **MAPs and environmental constraints**

Pedo-climatical limiting factors generating the marginality condition are, for example, extreme levels of temperature and/or moisture, pedological anomalies about soil depth, pH level, texture, salinity, toxic substances, orography. The available literature offers many examples of MAPs finding suitable cropping conditions even under such special environmental conditions: high resistance to drought conditions (Thyme, Oregano, Milk Thistle), to extreme pH soil conditions (Chamomile > 9.2; Erica spp. < 4.0) or to very high soil salinity levels (Chamomile, Liquorice); a few of them (Vetyver, Rosemary, Thyme) have been successfully tried in order to consolidate soils at a risk of erosion.

### **MAPs and economical diversification**

Economical diversification takes two different aspects: crop diversification and enhancement of multifunctional role of agriculture. Crops diversification is seen as the integration of new species, varieties and genepods inside the existing agricultural systems, and in such sense it is encouraged as a useful way to promote biodiversity (COM, 2006). In a context in which the small and medium concerns are mostly represented by family farms, and very often the production rests on one cash crop with a secure even if low market income, crop diversification, could reduce the risks linked to agricultural practice, and it seems to be one of the most concrete and quickest ways practicable by farmers in order to enhance their income level.

### **MAPs and multifunctional agriculture**

This aspect involves the new role which is today assigned to agriculture, that is also the satisfaction of different needs, not only coming from the agricultural community, but also from the



whole society. According to its new “multifunctional role”, besides ensuring food and fibre production, agriculture should also contribute to the environmental safeguard, to the supply of recreational services, to the creation of alternative opportunities for income and employment for the farmers, and so on. MAPs fit very well in this, and represent a good opportunity for agro-touristic concerns, helping in attracting people from the cities by means of the development of herbs-based commercial items (handicraft, oils, extracts, honey) besides representing a further source of aesthetic land valorization.

### **MAPs and biodiversity**

The widespread belief that only under “natural” conditions MAPs find their optimum quality features has driven in many cases to their uncontrolled collection from the wild, and as a result many of them are nowadays at a risk of extinction. The field cropping of such spontaneous species could play an important role in safeguarding biodiversity.

### **MAPs and integrated development**

Inside the intervention lines feasible for the sustainable exploitation of marginal lands, a great attention is paid to the integration of economic development, social development and environmental protection as “interdependent and mutually reinforcing pillars of sustainable development” (UN-CSD, 2007). One of the main goals is to promote all those economical activities that fit in unitary production pathways, besides the production of raw matter also including the first transformation and, whenever possible packaging and marketing processes. Most MAPs fit very well in such line, having a strong aptitude to be transformed by means of low-cost in-farm equipments, that could help farmers in increasing their income level by retaining in farm the added value due to the transformation process.

### **MAPs and organic agriculture**

The growing diffusion in Mediterranean environments of the organic production technique offers to MAPs new possibilities, being such crops mostly suitable to cultivation with a reduced use of energetic and technological inputs (Demarco et al., 1999). When their “naturalness” features are enhanced by means of the organic labelling, MAPs have the possibility to meet the requests of more careful and exigent consumers, disposed to pay more for a “natural” and “healthy” product.

### **MAPs and agroforestry**

The new trends in agroforestry claim that the introduction of MAPs inside the agroforestry system is a useful way to increase biodiversity and gain a significant increase in income (Huang et al., 2002). In such sense, they could be grown together with trees (that should however remain the main crop) generating highly positive interactions. As a matter of fact, in many areas of the world non-wood forest products, including MAPs, are the main income generating activity from the forests and several rural communities depend on these products for their living.

### **Conclusions**

Our survey shows that MAPs cultivation could be implemented in a productive way throughout many Mediterranean marginal lands and could help in solving some of the major land-use problems.

### **References**

- M.F Demarco et al., Good agricultural practices for the organic production of medicinal plants, 1999. *Acta Horticulturæ*, 502, 21-27.
- FAO-CGIAR, Reducing Poverty through Cutting-edge Science. CGIAR Research Priorities for Marginal Lands, 1999. International Centers Week, October 25 – 29, Washington D.C.
- COM (Commission of the European Communities), Halting the loss of biodiversity by 2010 and beyond – Communication from the Commission, 216 final, Brussels, 22.5.2006.
- UN-CSD (United Nations Commission on Sustainable Development), Report on the fifteenth session Economic and Social Council - Official Records, 2007 - Supplement No. 9- E/2007/29 - E/CN.17/2007/15
- W. Huang et al., Agroforestry for biodiversity conservation of nature reserves: functional group identification and analysis, 2002. *Agroforestry systems*, 55, 65-72.

## **INFLUENCE OF MYCORRHIZAL INOCULUM ON TOMATO (*LYCOPERSICON ESCULENTUM* MILL.) PLANTLETS GROWTH UNDER SALINITY STRESS CONDITIONS**

Valeria Cavallaro<sup>1</sup>, Antonio Carlo Barbera<sup>2</sup>, Vincenzo Castiglione<sup>3</sup>, Cristina Patanè<sup>1</sup>, Isabella Di Silvestro<sup>3</sup>

1 CNR-ISAFOM, Zona Industriale, Blocco Palma I, Str.le V. Lancia, 95121 Catania (Italy).

Tel. +39095292873. E-mail: v.cavallaro@isafom.cnr.it

2 DACPA, Università degli Studi di Catania, via Valdisavoia 5, 95123 Catania (Italy). Tel. +39095234465

3 Agroindustry Advanced Technologies (AAT) S.p.A., Zona Industriale, Blocco Palma I, Str.le V. Lancia, 95121 Catania (Italy). Tel. +39095540349

### **Introduction**

In the Mediterranean regions, protected horticultural crops as well as those in open field, have to cope with increasing salinization of irrigation water. This is mainly due to low precipitation and over-exploitation of available water resources (e.g., ground water). In some cases, the use of saline waters is tied to the induction of particularly appreciated quality characteristics of greenhouse productions (see Sicilian tomato productions). However high salinity of the irrigation water has detrimental effects on soil fertility and may reduce seedling establishment in the nurseries and crop growth (Al-Karaki, 2000a). Tomato (*Lycopersicon esculentum* L.) is considered a major vegetable crop in many parts of the world and it is mostly grown with irrigation. Tomato plantlets are commonly produced in nurseries. Sterilization of growth medium in which seedlings are produced usually eliminates beneficial symbiotic microorganisms such as arbuscular mycorrhizal (AM) fungi in addition to killing soil-borne pathogens. AM fungi symbiosis however, not only enhances plant mineral nutrition, but also can benefit plants by stimulating growth regulating substances, increasing photosynthesis, improving osmotic adjustment under drought stress, increasing resistance to pests and tolerance to environmental stresses (e.g., drought, salinity), and improving soil properties (Copeman et al., 1996). For these reasons a research was carried out to evaluate the effects of mycorrhizal inoculation on plantlet growth of three different tomato genotypes, when irrigated with saline water under greenhouse conditions and Mediterranean climate.

### **Methodology**

The experiment was carried out in pots (1620 cm<sup>3</sup> each) filled with a soil commercial mixture in a cold greenhouse located by the Agroindustries Advanced Technologies (A.A.T.) company in the Catania plane (Italy, 10 m a.s.l.).

Mycorrhizal inoculation was done at the transplant, adding the biofertiliser with michorrhizas (*Glomus intraradices* Schenck & Smith) to the soil near the roots (Aegis argilla – Italpollina). Irrigations with saline waters began fifteen days after transplant. In order to evaluate the effects of mychorrhizal infection on tomato plantlet growth, in a completely randomised experimental design with three replicates (five plants per replicate) the effects of the following factors were evaluated:

1) mycorrhizal inoculation (no inoculation and inoculation with *Glomus intraradices*); 2) tomato genotypes (three very different genotypes: Cuore di bue, local population Costoluto type and Ben Hur F1); 3) irrigation water potentials (0 and -1 MPa).

The salinity stress was obtained adding NaCl to irrigation water. The water potential of -1.0 MPa was obtained by subsequent adjustments of NaCl concentration in the solution and its measurement by an automatic cryoscopic osmometer (mod. 'Osmomat 030 Gonotec"). At 40 days after transplant, three measurements of chlorophyll content were detected on three apical leaves for plant by the portable apparatus 'SPAD 502' (Minolta Camera, Osaka, Japan).

At 72 days after transplant, height, fresh and dry weight of shoots and root apparatus were determined. Mycorrhizal infection in roots was analysed by the fixation with tripanblue (Phillips and Hayman, 1970).

## Results

Total dry matter per plant (shoot + root dry weight) and plant height (figs. 1 and 2) significantly reduced as water potential decreased from 0 (3.7 g and 50.5 cm respectively)

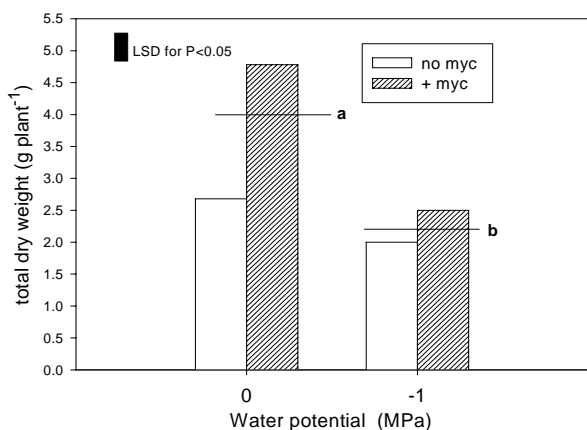

Figure 1 Influence of mycorrhizal inoculum on total dry weight in relation to water potentials. Different letters indicate significant differences at  $P<0.05$  level.

against 0.41 g in non AM plants) dry matter per plant. In the same cultivar leaf area of mycorrhized plants was four-fold greater than that of non AM plantlets ( $50.6 \text{ cm}^2 \text{ plant}^{-1}$ ) and SPAD determination showed a 7 units increase in chlorophyll content.

All inoculated plants showed roots infected by arbuscular mycorrhizas when examined by microscope.

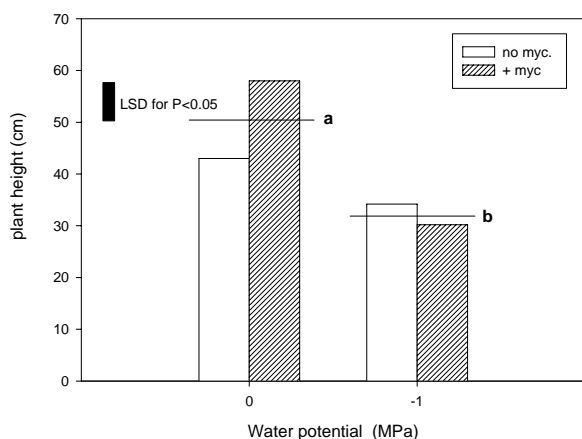

Figure 2 Influence of mycorrhizal inoculum on plant height in relation to water potentials. Different letters indicate significant differences at  $P<0.05$  level.

## References

- Al-Karaki G.N., Growth, water use efficiency, and mineral acquisition by tomato cultivars grown under salt stress, 2000. *J. Plant Nutr.*, Volume: 23, pp. 1-8
- Copeman R.H., Martin C.A., Stutz J.C., Tomato growth in response to salinity and mycorrhizal fungi from saline and nonsaline soils, 1996. *Hortscience*, Volume: 31, pp. 341-344
- Phillips J, Hayman D. Improved procedures for clearing roots and staining parasitic and vesicular-arbuscular mycorrhizal fungi for rapid assessment of infection, 1970. *Trans Br Mycol Soc.*, 55:158-161.

## SIMPLE OIL PALM MODEL FOR FARM ALLOCATION IN HONDURAS

C. G. H. Díaz-Ambrona<sup>1</sup>, L. A. Norales<sup>2</sup>, J. Martínez-Valderrama<sup>3</sup>

<sup>1</sup> Dep. de Producción Vegetal: Fitotecnia, Universidad Politécnica de Madrid, E-28040 Madrid, Spain, [carlosgregorio.hernandez@upm.es](mailto:carlosgregorio.hernandez@upm.es)

<sup>2</sup> Carrera de Ciencia y Producción Agropecuaria, Escuela Agrícola Panamericana, Ap 93 Tegucigalpa, Honduras, [lnorales@est.zamorano.edu](mailto:lnorales@est.zamorano.edu)

<sup>3</sup> CSIC, Estación Experimental de Zonas Áridas, E-04001 Almería, Spain, [jaimonides@eeza.csic.es](mailto:jaimonides@eeza.csic.es)

### Introduction

The oil palm (*Elaeis guineensis* Jacq) as biodiesel source is an expanding crop in subtropical areas. Oil palm grows in high rainfall zones within 20 degrees of the Equator. The European Union and the People's Republic of China are the main palm oil importers, with more than five million tons each one, 38% of the market share. Honduras (Central America) produces 0.13 Mt of vegetable oil (8% of the total oil of Latin America). Honduras's government has started up the "Megaproject of planting 200 thousand hectares of oil palm for biodiesel". In Honduras Oil palm grows on 90,000 ha and it wants to add 200,000 hectares in 2009.

The oil palm is the most yield oil crop. One hectare of oil palm produces the same oil than 10 of soy bean, 11 of groundnut, 7 of rapeseed or sunflower (Fairhurst and Mutert, 1999). Also the estimated energy efficiency is high. The energy efficiency of this crop is 1:9.5, higher than other crops as soybean with 1: 2.15 or rapeseed 1:3.0.

Palms are cultivated in regular plantation with 140-170 palms per hectare. Farm structure in Honduras (Table 1) shows that 94% of the farmers work on the 46% of the land. The main constraint of the palm plantation is the hand harvest of the bunch. Smaller farm gets higher yield due to its intensive use of hand work.

**Table 1. Oil palm farm structure in Honduras in 2003.**

Farm class ha	Number of farms		Surface area (ha)		Production		Yield t ha <sup>-1</sup>
	Number	%	Total	Harvest	t	%	
≤ 5	513	38.98	3,786	1,409	24,052	2.00	17.1
5 – 50	720	54.71	38,198	27,953	532,655	44.23	19.7
50 – 500	75	5.70	16,221	14,124	239,628	19.90	17.0
> 500	8	0.61	38,024	25,153	407,951	33.87	16.2
Total	<b>1316</b>		<b>96,229</b>	<b>68,639</b>	<b>1204,286</b>		17.5

Different oil palm models are described (Henson 2000; Henson and Dolmat, 2003), and more complex as the palm oil module in WaNuLCAS (van Noordwijk et al., 2004). All these models are adequate but complex for input implementation in our conditions of few inputs availability. Where to locate the plantations and its productivity are questions to consider. The objective of this work is to explore the potential of growing oil palm in the north coast of Honduras.

### Methodology

We made a simplified simulation model of oil palm crop written with the software Vensim® DSS. The model simulates daily growth of a palm plantation and grass. The driven variables are solar radiation, temperatures and soil water availability. The model is divided in five submodels that correspond with the main components of the systems: oil palm, grass, livestock, climate, and soil. The submodel climate contributes with the daily data: temperature, solar radiation and precipitation, and calculates the reference evapotranspiration with a simplification of the Priestley-Taylor equation. The submodel soil reads soil data to calculate the soil water balance as cascade model. The model computes daily oil palm biomass production and partitioning.

Calibration was made with data from literature. Validation was made with data of commercial plantation of Honduras (observed fresh fruit bunch ranges from 11.6 to 19.7 t ha<sup>-1</sup>), because there

are not experimental data. The oil palm model was applied for different soils. Sandy soil (Sand1.1: 75% sand, 1.1 m deep); loam soil (50% sand, 10% clay, and deep of 1.3 m Loam1.3, 1.1 m Loam1.1, and 0.9 m Loam0.9), and clay soil (Clay1.1: 50% clay, 1.1 m deep) and weather from La Masica (15°38'N, 87°06'W, 18 masl) (Annual precipitation of 2,938 mm and mean temperature of 26°C). Soil texture, depth, and water table affect bunch dry matter yield. We calculated the energy input following farm operation included the hand works (Table 2).

**Table 2. Farm operations in Honduras oil palm plantation.**

Stage	Year	Farm operations
Plantation	1	Clearing, Land preparation, Subsoil, Plow Harrow, Fertilization, Plantation, Replacement fertilization, Weed control, Disease control.
Juvenile	2-3	Plantation, Replacement fertilization, Weed control, Disease control.
Productive	4-5	Replacement fertilization, Weed control, Disease control, Pruning, Harvest.
Full productive	6-25	Replacement fertilization, Weed control, Disease control, Pruning, Harvest.

## Results

Significantly better was loam soil with 12.8 fresh fruit bunch t ha<sup>-1</sup> (Standard deviation, SD 0.54), sandy or clay soils yield drop to 10.4 t ha<sup>-1</sup> (SD 0.55) (Figure 1). Also soil depth has a direct effect. Yield was 14.4 t ha<sup>-1</sup> (SD 0.87) in the deeper soil (plus 20 cm). Average annual energy input was 25,532 MJ ha<sup>-1</sup> year<sup>-1</sup>, considering the annualized yield for 25 year cycle and average oil yield of 20%. The energy output was 84,576 to 116,327 MJ ha<sup>-1</sup> year<sup>-1</sup>. Energy efficiency (output/input) on farm was from 3.3 to 4.6 depending on soil type, lower than reported (Fairhurst and Mutert, 1999).

Considering that new plantation allocation will be 10% on current agricultural land and 90% on forest soil, simulated all average yield was 12.4 t ha<sup>-1</sup>. The simulated oil potential of 200,000 ha was 371,240 t (equivalent to 20% of current petroleum demand of Honduras).

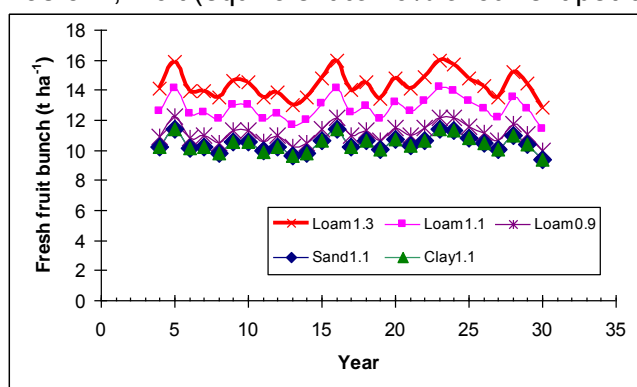

**Figure 1. Simulated oil palm yield (fresh fruit bunch) for different soils and weather station of La Masica, Atlántida (Honduras).**

## Conclusions

This exploratory model showed a fresh fruit bunch yield variability of  $\pm 4$  t ha<sup>-1</sup> related with soil types. Initially oil palm plantation replaces other crops, as banana or cotton, from good soils, after that plantation will set on forest soils

with smaller productive capacity. Extension of this crop out of current cultivated land must be studied in relation with social and environmental issues.

## Acknowledgements

This research was funded by the Universidad Politécnica de Madrid Programme on Development Cooperation Action, contract C40.05.02.

## References

- T.H. Fairhurst, E.M. Mutert, Introduction to Oil Palm Production, 1999. Better Crops International 13 (1), 3-6.
- I.E. Henson, Modelling the effects of haze on oil palm productivity and yield, 2000. J. Oil Palm Research 12 (1), 123-134.
- I.E. Henson, M.T. Dolmat, Physiological analysis of an oil palm density trial on a peat soil, 2003. J. Oil Palm Research 15(2), 1-27.
- M. van Noordwijk, et al. WaNuLCAS version 3.1, Background on a model of water nutrient and light capture in agroforestry systems, 2004. ICRAF, Bogor, Indonesia.

## LIFE CYCLE ASSESSMENT (LCA) OF THREE PERENNIAL CROPS FOR ENERGY IN SOUTHERN ITALY

G.M. D'Agosta<sup>1</sup>, S.L. Cosentino<sup>1</sup>, M. Mantineo<sup>1</sup>, C. Patanè<sup>2</sup>

<sup>1</sup>Sezione Scienze Agronomiche (DACPA), Università degli Studi di Catania, ITALY, [gdagosta@unict.it](mailto:gdagosta@unict.it)

<sup>2</sup>CNR (ISAFOM), Unità Organizzativa di Supporto di Catania, Italy [c.patane@isafom.cnr.it](mailto:c.patane@isafom.cnr.it)

### Introduction

Life Cycle Assessment (LCA), was developed to satisfy the necessity of the producers and consumers to make the best choice in the framework of processes and products which are not dangerous for the environment, taking into account all relevant impacts occurring during the entire production system. This methodology is an innovative tool useful to quantify the emissions of polluting substances from agricultural systems to the environment. The LCA application to the crops for energy is very interesting because allow to evaluate their role in the reduction of CO<sub>2</sub> in the atmosphere both for the organic carbon synthesis and for the fossil fuels saved.

### Methodology

Within the Italian Ministry of Agriculture programme of research TISEN "Sustainable innovative techniques of production and transformation of the energetic and no food crops", carried out between 2002-2005, the LCA was applied at the farm gate, in order to study the environmental effects of the cultivation of three perennial biomass crops (*Arundo donax* L., *Miscanthus x giganteus* Deu et Greef. e *Cynara cardunculus* L.) under two different irrigation treatments (75% and 25% restoration of ETc) and two nitrogen fertilization levels (100 and 50 kg ha<sup>-1</sup>). During the last year 2005-2006 none inputs was supplied. All the environmental impacts are related to the cultivation of one hectare, which is the functional unit for this analysis. Inventory data are aggregated to effect scores using the relative equivalence factors (Reinhardt, 2000), according to the ISO norm (ISO 14042). The following impact categories were studied: "use of energy resources", "global warming", "ozone depletion", "acidification of the atmosphere", "water eutrophication", "summer smog" and "human toxicity". The values obtained by characterization LCA step are normalized, dividing the result of each impact category of the system under investigation by the correspondent total emission rates for environmental effects in Italian territory per person, according to Reinhardt (2000). Net CO<sub>2</sub> sequestered by crops was calculated as percentage difference between CO<sub>2</sub> synthesized by crop and CO<sub>2</sub> emitted in the atmosphere with the crop management.

### Results

The comparison among impact categories cannot be considered at this stage, because each category should be weighted according to the impact on the environment (Brentrup et al., 2001). All data refer to the emission of inhabitants emitting pollutants. In all studied crops great variability is shown among values of the impact categories related to the three-year (treatments applied) and the last year (no input); in fact, in terms of energy resource in the three-year 126,2, 125,1 and 103.3 in the average of studied treatments were recorded, respectively for *Arundo*, *Miscanthus* and *Cynara*, against to 15.2, 15.3 and 5.8 in the same crops obtained in the last year.

Tab. 1 – Normalized impact values in *Arundo* e *Miscanthus* crops

Impact categories	<i>Arundo donax</i>					<i>Miscanthus x giganteus</i>				
	First three years average				4 <sup>th</sup> year	First three years average				4 <sup>th</sup> year
	I <sub>75</sub>	I <sub>25</sub>	N <sub>100</sub>	N <sub>50</sub>	no input	I <sub>75</sub>	I <sub>25</sub>	N <sub>100</sub>	N <sub>50</sub>	no input
Energy resources use	156.6	96.8	141.6	110.8	15.2	154.3	95.9	140.3	109.9	15.3
Global warming	-4262	-3066	-3872	-3456	-4845	-2499	-1735	-2087	-2147	-4169
Ozone depletion	684.1	612.3	991.2	305.2	4.9	802.3	703.2	995.2	510.3	4.9
Atm. acidification	223.9	191.8	286.9	128.8	13.2	254	224.3	285.7	192.5	13.2
Water eutrophic.	459.5	526.8	664.3	321.9	-580.1	613.9	623.2	741.7	495.4	-459.4
Summer smog	54.8	28.6	43.8	39.6	6.5	54.2	28.4	43.4	39.2	6.6
Human tox. vs. air	52.3	28.2	43.1	37.4	5.7	52.1	28.1	42.8	37.5	6.0

Tab. 2 - Normalized impact values in *Cynara* crop

Impact categories	<i>Cynara cardunculus</i>				
	First two year average				4 <sup>th</sup> year
	I <sub>75</sub>	I <sub>25</sub>	N <sub>100</sub>	N <sub>50</sub>	no input
Energy resources use	115.1	91.5	118.5	88.1	5.8
Global warming	-3538	-2750	-3064	3225	-946
Ozone depletion	788.5	521.8	808.3	502.0	1.9
Atm. acidification	236.1	236.1	282.7	189.5	5.2
Water eutrophic.	534.9	455.3	589.3	400.9	-17.9
Summer smog	35.4	25.3	32.5	28.1	2.4
Human toss. vs. air	35.6	25.7	33.1	28.1	2.2

Global warming depends on yields, being lower in *Arundo* compared to *Miscanthus* and *Cynara*; negative values indicate the CO<sub>2</sub> balance results favourable for the environment. Ozone depletion, atmosphere

acidification and water eutrophication are strictly linked to fertilizers application, and so they resulted low in no input treatment in all studied crops.

Summer smog and human toxicity vs. air, in the average, resulted equal to 37.8 and 37.0, respectively (tab. 1 and 2).

Tab. 3 – Net CO<sub>2</sub> sequestered by crops (%)

Net CO <sub>2</sub> sequestered by crops (%)	2 <sup>nd</sup> and 3 <sup>rd</sup> years average				Fourth year				
	I <sub>75</sub>	N <sub>100</sub>	I <sub>75</sub>	N <sub>50</sub>	I <sub>25</sub>	N <sub>100</sub>	I <sub>25</sub>	N <sub>50</sub>	no input
	<i>Arundo donax</i>	96.0		97.1		96.2		97.4	
<i>Miscanthus x giganteus</i>	93.1		95.2		92.7		95.5		99.7
<i>Cynara cardunculus</i>	93.8		96.1		94.2		93.5		99.4

In table 3 the percentage of net CO<sub>2</sub> sequestered by crops is shown: low differences are recorded within studied treatments and within crops: in the

second and third years the percentage was higher in *Arundo* (96.7%), followed by *Cynara* (95.0%) and *Miscanthus* (94.1%). In the fourth year, 99.6% of net CO<sub>2</sub> sequestered by crops in the average. In table 4 percentage of agricultural phase in the respect to biofuel chain are indicated: the lowest values are obtained in low input treatment for each crop. As far as water and fertilizer treatments are concerned, in *Miscanthus* higher values than the other crops were obtained. In particular, its crop management affected energy resource use (52.7%), ozone depletion (52.3%), global warming (49.7%) and water eutrophication (48.5%).

Tab. 4 - Percentage of agricultural phase respect to biofuel chain (%)

Impact categories	<i>Arundo</i>		<i>Miscanthus</i>		<i>Cynara</i>	
	treatment (average)	no input	treatment (average)	no input	treatment (average)	no input
Energy resources use	43.7	5.2	52.7	6.7	35.9	9.1
Global warming	38.6	2.7	49.7	3.4	33.0	5.4
Ozone depletion	37.5	0.3	52.3	0.4	36.6	0.6
Atm. acidification	17.5	0.6	30.5	0.8	15.1	1.3
Water eutrophic.	32.2		48.5		29.0	
Summer smog	11.4	0.8	20.0	1.1	5.6	1.7
Human toss. vs. air	3.4	0.2	7.4	0.3	1.6	0.4

## Conclusions

Under no input condition, crop management may lead environmental benefits. Irrigation and fertilization strongly affected the environmental impacts. In general, more than 90% of CO<sub>2</sub> sequestered by crops is available for further uses (heat, electricity, bio-ethanol).

## References

- Brentrup F. et al. 2001 Application of the Life Cycle Assessment methodology to agricultural production: an example of sugar beet production with different forms of nitrogen fertilizers. *European J. of Agronomy*, 14: 221-233.
- Cosentino S. et al. 2005. Confronto tra impatti ambientali di biocombustibili fossili per mezzo della "Life Cycle Assessment" (LCA). *Agroindustria*, 4, 1: 109-128.
- Reinhardt G. et al. 2000 Final Report. Bioenergy for Europe: which ones fit best? – A comparative analysis for the community. Heidelberg. pp.178.

## MODELLING THE AGRO-ENERGY FARM

Francesco Danuso<sup>1</sup>, Franco Rosa<sup>2</sup>, Loris Serafino<sup>1</sup>, Federico Vidoni<sup>2</sup>

<sup>1</sup> Dipartimento di Scienze agrarie e Ambientali (DISA) – Univ. of Udine. Email: francesco.danuso@uniud.it

<sup>2</sup> Dipartimento di Economia Agro-industriale (DIEA) – Univ. of Udine. Email: franco.rosa@uniud.it

### Introduction

The increasing oil price due to the shortening oil reserves, the political turmoil in the oil producing countries and the relatively low prices of farm commodities have spurred the search for new agri-business opportunities offered by the ethanol, biodiesel and biogas productions. Nevertheless, the bio-energy production efficiency at farm level is still questionable, depending on the commodity used, agronomic practices, climate variability and other unpredictable events. Some researchers assess that the energy balance is still negative (Pimentel and Patzek, 2005); other studies (Hill et al., 2005), suggest that the energy produced with the oil and co-products by using energy saving techniques is significantly superior to the energy spent. In this framework, in order to improve the managing and planning skills of agro-energy farms, a modeling approach seems to be mandatory. Hence, for these purposes, a farm dynamic simulation model (X-Farm) to manage sustainable farming systems, taking in specific account the production of energy, has been developed. The model simulates the whole “agro-energy farm”, that uses fossil and sun energy to produce and sell the renewable energy exceeding the energy used for farming activities.

### Methodology

X-Farm has been implemented with SEMoLa (version 5.6; Danuso, 2003) a simulation framework allowing for the management of multiple objects (e.g., the different fields of the farm) by the concept of “group”. Farm processes and activities are described using the concepts of state, rate, parameter and event. Activities (crop production, livestock production, energy production, etc.) are characterized by starting and ending events, temporal window, priority in accessing resources, prerequisites. The X-Farm model is formed by eleven interconnected modules (fig. 1) grouped into five blocks: *production*, *resources*, *accounting* and *management*. The time simulation step is daily. Main farm productions are represented by crop yields and livestock productions. Sunflower seeds production is the beginning step of the oil chain, while the animal residuals (sludge, slurries, manure) represent a step of the livestock chain to produce biogas. All these processes involve the use of resources in terms of capital (land, buildings, machinery, livestock), labour and managerial skills for the farm organization. For each tractor and machine of the farm, fuel consumption, energy use and labor requirement are computed in the *Machinery* module whereas workforce characteristic are specified in the *Labour* module.

The *Crops* module simulates the crop biomass growth and yield under different conditions, depending on climate, soil characteristics, manure applications, machinery utilization and other management choices. In the *Oil* module, the entire oil production chain is developed as it follows: 1) mechanical extraction with seed crushing; 2) chemical oil extraction with solvent and a co-product as a cake containing protein and residual oil.

The *Livestock* module simulates a livestock enterprise, using the cake obtained after oil extraction to feed the cattle and producing milk and calves. It considers cows in different conditions, in terms of age, weight, number of pregnancy and lactation stages. The milk production of every cow is obtained from the specific

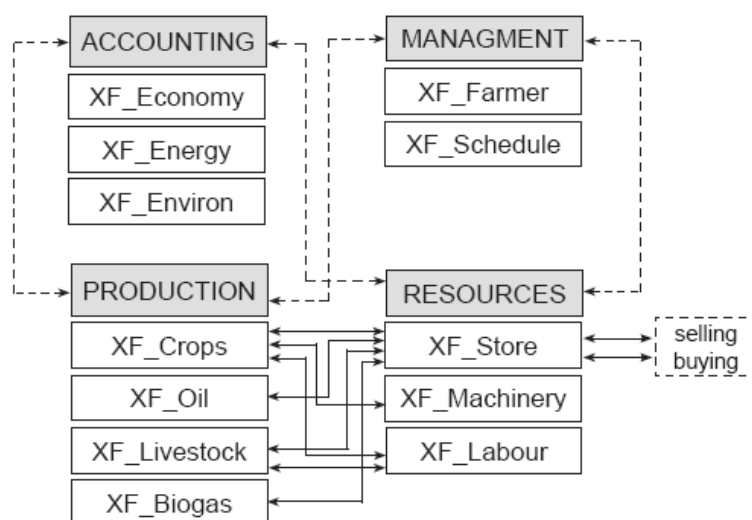

Figure 1. The modules of X-Farm and their interrelations



lactation curve. The co-products, represented by liquid, solid wastes and manure, are recycled in the biogas production.

The *Biogas* module considers liquid and solid wastes from dairy activity, recycled in bioreactor to produce: a) heat, partially exploited in the farm; b) electricity sold to the electrical network manager; c) a residual material (organic compost) spread as fertilizer in the farm fields or sold to other farms, after specific treatments.

Primary production, processing, transport, storage, delivery or recycling in farm are considered in terms of costs, energy and environmental impact.

The *Environment* module accounts for the direct and indirect inputs and outputs between farm and the environment. To compare the environmental performance of the different farm activities, an equivalent function for each of them is defined and normalized for LCA analysis (Kim and Dale, 2005). For the total energy produced in the farm, a LCA analysis of alternative sources of energy produced in the farm is performed. Potential environmental impact categories are: natural resource use, non renewable energy, global warming, acidification, eutrophication. Information to perform LCA is obtained from literature data, commodity and fuel prices, farm energy and agrichemical inputs, production plant efficiencies, co-product production and greenhouse gas (GHG) emissions and crop/livestock simulation.

The *Energy* module computes the energy production from oil and biogas and calculates the net energy balance of the processes. The module estimates the direct and indirect farm energy used for crops and milk production, farm machinery consumption and farm machinery building, fertilizers and pesticides production, facilities and technology for seeds and animal waste transformation.

The *Economic* module calculates the costs of resources (including variable and fixed costs) and revenues for specific farm activities (crop, livestock, oil and biogas production) and for the whole farm. The profit and economic performance indexes are calculated to give evidence of the contribution of specific activity to the global performance. All economic information are presented in output files to support decisions for the management of investments in the farm and analyses of the results reached in each activity.

## Results and conclusions

X-Farm may be seen as a powerful and flexible tool to accumulate knowledge and help farmers in planning decisions for agro-energy farms. Nevertheless, it needs further improvements to reach a level of detail adequate to the obtaining of realistic energetic-economic-ecological balances.

Further applications of X-farm include: i) sensitivity analysis to predict changes in economic and energetic balances according to different scenarios, actor's objectives and preferences, and public intervention; ii) the generation of information for feeding a DSS to improve the farm performance; iii) the suggestion about the most appropriate technical and economic solution to solve managerial problems, in order to optimize the farm performance, under some level of acceptable risk assessed "a priori" (stochastic farm planning approach).

X-Farm will provide a research and operational tool for the evaluation of short and long-term evolving scenarios, with relation to the farm management decisions, based on yields, economics and environmental impacts. Other applications could be the optimization of the use of resources and the reduction of the negative impacts on the environment.

## Acknowledgements

The development of the first version of X-Farm has been carried out in the framework of the MIUR PRIN 2005 project "Ottimizzazione degli scenari agro-ambientali per colture da energia".

## References

- Danuso F., SEMoLa: uno strumento per la modellazione degli agroecosistemi, 2003. Atti XXXV Convegno SIA, Napoli, 16-19/9/2003, 283-284.
- Hill J. et al., Environmental, economic, and energetic costs and benefits of biodiesel and ethanol biofuels, 2006. PNAS-Proc. National Academy of Sciences - USA, vol. 103, 30, 11206-11210.
- Kim S., B.E. Dale, Life cycle assessment of integrated biorefinery-cropping system: all biomass is local, 2005, in Outlaw J., K.J. Collins, J.A. Duffield, "Agriculture as a Producer and Consumer of Energy", CABI Publishing Co., Cambridge MA, p. 319.
- Pimentel D., Patzek T.W., Ethanol Production Using Corn, Switchgrass, and Wood; Biodiesel Production Using Soybean and Sunflower, 2005. Natural Resources Research, Vol. 14, No. 1, March 2005

## EVALUATING BIOFUEL PRODUCTION IN CROPPING SYSTEMS: OLD WORLD, NEW WORLD, AND THE DEVELOPING WORLD

John Dixon<sup>1</sup>, Hans Langeveld<sup>2</sup>

<sup>1</sup> CIMMYT – Impact Targeting and Assessment Unit, International Maize and Wheat Improvement Center, Mexico, [j.dixon@cgiar.org](mailto:j.dixon@cgiar.org)

<sup>2</sup> Plant Research International, Wageningen University and Research Centre, Netherlands, [hans.langeveld@wur.nl](mailto:hans.langeveld@wur.nl)

### Introduction

An unprecedented boom has driven global investment in biofuels from less than \$ 10 billion during 2003 to more than \$ 70 billion during 2006. The rapid expansion has fueled concerns over the sustainability of biofuel production in many different cropping systems, as well as the potential threats to poor consumers of the increases in food crop prices. This paper examines changes in cropping systems in response to the new opportunities of biofuels in different parts of the world.

### Methodology

Following the literature review, evidence was assembled on the comparative advantage of various feedstocks, the recent shifts in land use and the way that household livelihood portfolios determine the impact of biofuels production.

### Results

While Brazilian sugarcane-for-bioethanol expanded gradually over 20 years to the current production of more than 200 million tons (and is projected to expand to approximately 500 million tons in 2015), in the US the booming investment in bioethanol production, supported by substantial subsidies, has driven up maize prices and maize use for bioethanol during the past two years. The increased profit from maize use for bioethanol has led a record expansion of maize area, substituting especially soybeans, cotton and wheat. Contrary to some claims, Hill et al (2006) estimate positive net energetic efficiency for the production of bioethanol from maize or sugarcane, and biodiesel from soybeans – and biofuels in all three cases produce less GHGs than petroleum-based fuels. OECD-FAO (2007) estimates that maize use for bioethanol will expand from about 5 million tons three years ago to about 110 million tons in 2015. In Europe OECD-FAO projects a growth of maize based bioethanol, albeit on a fraction of the scale of USA and Brazil, but a larger demand for oilseeds, both locally produced and imported, for biodiesel.

Because of significant cross-price elasticities between maize, wheat and other food and feed crops, wheat, sorghum and cassava prices have been pushed up to record levels on global markets. Many developing countries purchase food grains on the international market, including a large number of African countries, India and China. As a result of the food price increases, according to a preliminary (unpublished) assessment of IFPRI and CIMMYT, malnutrition will increase in Africa and other developing countries.

In Africa and Asia bioethanol production volumes are small relative to Brazil or USA. However, it is widely assumed that the policy goals of diversification of energy sources and reduction of energy import bills is likely to lead to continued substantial bioethanol production subsidies in India and China. In both countries the choice of feedstock has promoted a vigorous food vs fuel debate, which has led China to ban the construction of

further maize based bioethanol plants and India to place emphasis on feedstocks from non-food crops, e.g., sweet sorghum and sugarcane. However, the increased profitability of these alternate feedstocks will inevitably lead to substitution of these crops for maize, wheat and other traditional food crops. In the case of sugarcane, the demand for already-scarce water in India will be intensified.

There are not only economic, nutritional and global warming considerations: in addition, second generation bioethanol will come on stream in the near future (US DOE 2006) and this will increase the demand for cellulose including crop residues. Since cereal stover and straw has a great, but not yet well quantified, value when retained on the surface or incorporated into the soil, second generation bioethanol production might be an even greater environmental threat, to natural resources, than first generation.

### **Conclusions**

The above preliminary assessment suggests the need for a multi-disciplinary multi-sectoral assessment of biofuels production strategies. It is clear that benefits and costs differ between cropping systems in different regions of the world. In order to implement such assessments in a systematic and comparable fashion, a sound set of globally applicable sustainability indicators are needed which could be used to assess biofuel production in different cropping systems of the world.

### **References**

- Hill, J, et al. Environmental, economic, and energetic costs and benefits of biodiesel and ethanol biofuels, 2006. PNAS, 103(30): 11206-11210.
- OECD-FAO. *Agricultural Outlook 2007-2016*. 2007. OECD and FAO, Paris and Rome.
- US DOE. Breaking the Biological Barriers to Cellulosic Bioethanol: A joint Research Agenda, 2006. DOE/SC-0095, US Department of Energy Office of Science and Office of Energy Efficiency and Renewable Energy ([www.doe-genomestolife.org/biofuels/](http://www.doe-genomestolife.org/biofuels/))

## FABA BEAN IN ROTATION WITH DURUM WHEAT: A LONG TERM SIMULATION CASE-STUDY

P. Garofalo<sup>1</sup>, E. Di Paolo<sup>2</sup>, M. Rinaldi<sup>1</sup>

<sup>1</sup>C.R.A.–Istituto Sperimentale Agronomico, Bari, Italy, pasquale.garofalo@entecra.it;  
michele.rinaldi@entecra.it

<sup>2</sup>Centro per la Sperimentazione e Divulgazione delle Tecniche Irrigue, Vasto, Italy, dipaolo@cotir.it

### Introduction

The capability of legume crops to fix the atmospheric nitrogen and reducing chemical supply can be exploited in sustainable agriculture to reduce mineral fertilisation and improve soil fertility (Senaratne and Hardarson: 1988). The wheat continuous cropping, in fact, can produce negative effects on chemical soil properties such as a decline of organic matter and macro-nutrients content and, consequently, can be necessary to increase mineral fertilisation level to obtain satisfactory grain yield. Aim of this work is to simulate durum wheat (*Triticum durum* Desf.) in continuous cropping and in 2-year and in 3-year rotation with faba bean (*Vicia faba var minor* L.), to evaluate the cropping systems response on a long-term basis.

### Methodology

The CropSyst simulation model (Stockle et al., 2003), previously calibrated and validated (Donatelli et al., 1997; Di Paolo et al., 2007) was used in a seasonal analysis (54 years of daily weather data), to compare wheat cropped as “continuous crop” (CC) and in sequence with faba bean in 2-year (R2) and 3-year (R3\_F1 and R3\_F2, indicate the wheat after faba bean and after wheat, respectively) rotations. For the 2-y and 3-y rotations the simulation runs were performed starting with the different crops (all the phases of the rotation for every year).

Durum wheat was fertilised with 100 kg of nitrogen ha<sup>-1</sup>, splitted in two applications. No nitrogen application was simulated for faba bean. Crop residues were removed in the case of wheat and soil incorporated for faba bean. Weather data, soil characteristics and typical crop management for both crops in Capitanata plain (Southern Italy) were used in simulation input files. Nitrogen balance components and soil moisture at sowing were examined.

### Results

A positive effect of faba bean on the following wheat crop was simulated by the model. The grain yield of R2 and R3\_F1 were higher than CC and R3\_F2 yield of about 6%. The temporal behaviour of the yield increment respect to the CC is displayed in Fig. 1. The reasons of this benefit lie in the more shallow root of faba bean (1.2 vs 1.5 m), in the greater water use efficiency in faba than in wheat (10.5 vs 4.0 KPa kg m<sup>-3</sup>); this allows to simulate a soil moisture at wheat sowing time larger after faba bean crop (+ 4%, on average).

The nitrogen balance resulted always larger in the rotation with the leguminous crop (Fig. 2). The N-fixation of faba bean was simulated of about 95-100 kg of N ha<sup>-1</sup> y<sup>-1</sup>. In addition, the nitrogen mineralization from residue of faba bean was simulated to be greater in R2 showing a positive effect on the

Table 1 – Wheat output, average, st. dev. and coef. of var. deriving by 54 years of CropSyst simulation; CC = wheat continuous cropping; R2 = wheat in 2-year rotation; R3\_F1 and R3\_F2 indicate wheat in 3-year rotation, after faba bean and after wheat, respectively.

	CC	R2	R3_F1	R3_F2
Biomass (kg ha <sup>-1</sup> )	5732	6053	6044	5781
St. dev. (kg ha <sup>-1</sup> )	2296	2214	2214	2306
CV (%)	40	37	37	40
Grain yield (kg ha <sup>-1</sup> )	2147	2283	2280	2169
St. dev. (kg ha <sup>-1</sup> )	954	927	927	959
CV (%)	44	41	41	44
N uptake (kg ha <sup>-1</sup> )	163.6	178.1	178.2	171.9
St. dev. (kg ha <sup>-1</sup> )	47.6	50.2	50.2	53.3
CV (%)	29	28	28	31
N leaching (kg ha <sup>-1</sup> )	3.2	4.9	7.5	7.2
St. dev. (kg ha <sup>-1</sup> )	13.1	16.4	26.4	27.7
CV (%)	416	336	354	383

organic matter in the soil (161 in R2 vs 92 kg of N ha<sup>-1</sup> y<sup>-1</sup> in CC). Finally, the larger uptake (biomass and N grain content greater in faba bean than in wheat) and the soil incorporation of crop residues led to a N-balance more favourable than in the cropping system of CC. In fact, in the figure 2 we observe throughout the simulation period an initial decrease and a stabilization after 25 years on average of about 80 and 40 kg of N ha<sup>-1</sup> y<sup>-1</sup> for R2 and CC, respectively.

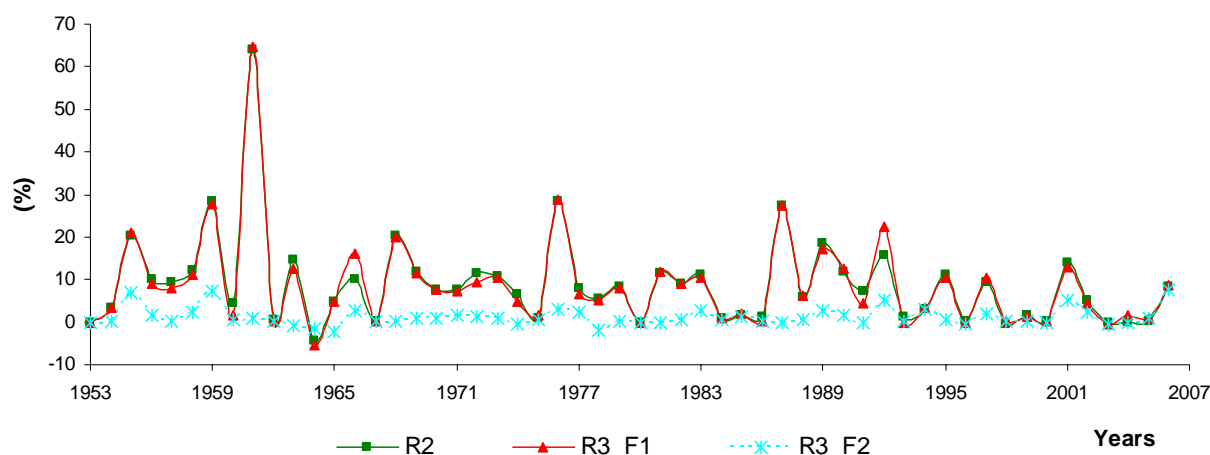

Figure 1 – Wheat yield increment respect to wheat continuous crop in the 54 years of simulation. For legend see Table 1.

### Conclusions

Positive effects of interruption of wheat CC farming system were simulated by CropSyst, a greater and more stable grain yield, a more positive nitrogen balance. This confirms the advantages from an environmental point of view to alternate legume and cereal crops on a long term basis.

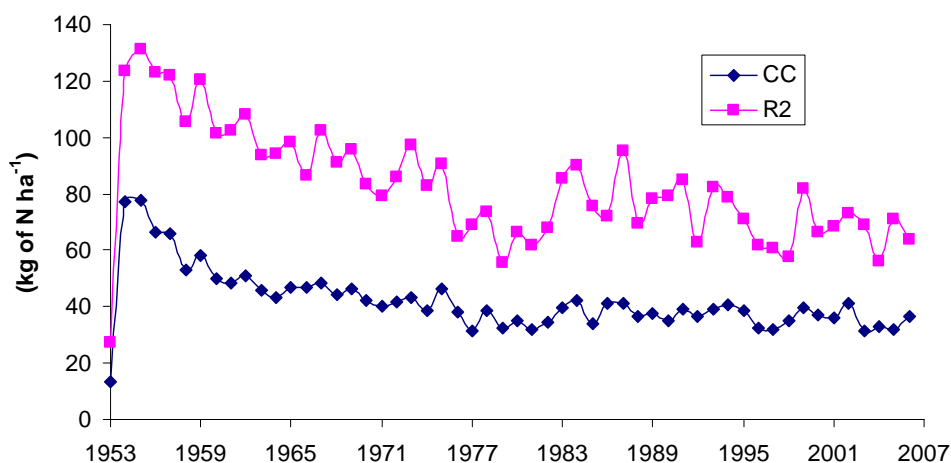

Figure 2 – Yearly N-balance in the CC and in wheat in rotation with faba bean.

### Acknowledgements

Funded by Italian Ministry of Agriculture and Forestry Policies (AQUATER Project, 209/7303/05).

### References

- C. Stockle et al., CropSyst, a cropping systems simulation model, 2003. Eur. J. Agronomy, 18, 3-4, 289-307.
- R. Senaratne and G. Hardarson, Estimation of residual N effect of faba bean and pea on two succeeding cereals using <sup>15</sup>N methodology, 1988. Plant Soil, 110, 81-89.
- M. Donatelli et al., Evaluation of CropSyst for cropping systems at two locations of northern and southern Italy, 1997. Eur. J. Agronomy, 6, 35-45.
- E. Di Paolo, Il favino (*Vicia faba* var. minor L.) per uso zootecnico sottoposto a regimi irrigui. calibrazione e validazione del modello CropSyst, 2007. Atti XXXVII Convegno SIA, Catania, 13-14 settembre.

## SYSTEM ANALYSIS FOR SUSTAINABLE PRODUCTIVITY OF RICE BASED UTERA CROPPING SYSTEM IN CHHATTISGARH PLAINS

G.K. Shrivastava, A.K. Verma and R. Lakpale  
Department of Agronomy, Indira Gandhi Agricultural University, Raipur (CG) 492 006 INDIA  
E-Mail: rlakpale@rediffmail.com

### Introduction

In Chhattisgarh state of India, rice is the major crop in *kharif* (rainy) season having 36 lakh ha area and about 20 per cent of its area is under *relay or utera* cultivation. In *utera* (relay) system, *Lathyrus* is prominent crop having 6 lakh ha area. *Utera* cultivation of *Lathyrus* has its own advantage as it is easy to cultivate without much efforts, but it is very difficult to boost up its productivity under this system. Farmers' are more inclined towards *Lathyrus* in *rabi* (winter season) *utera* because of its fodder and consider grain yield as bonus. This crop is considered drought resistant and performs better under moisture stress conditions. The main important reasons of the low productivity of *Lathyrus* in *utera* system are inadequate plant stand, lack of suitable varieties, losses due to insects pests particularly thrips and pod borer, losses due to weeds, moisture stress and no use of fertilizers. Lack of water coupled with poor socio-economic conditions of the farmers lead to poor productivity of *Lathyrus* under *utera* system. The technology generated by researchers for boosting up its productivity is not adequately reaching to the farmers due to one or more reasons. To overcome these situations various extension efforts have been made so far but their impact could not be visible in this region. Considering above facts, OFTs (On Farm Trials) were conducted in two districts –Rajanandgaon and Mahasamund.

### Methodology

The OFTs were conducted in Mahasamund and Rajnandgaon districts of Chhattisgarh state during 2001-02 and 2002-03. Five villages were randomly selected from each of the selected district. The villages were Mohandi, Tendulotha, Ghunchapali, Sonaputti and Kotanpali from Mahasamund district and Bakal, Kopedih, Tumdibod, Kohka and Nathunavagaon from Rajnandgaon district. In each selected village of Mahasamund district total of 6 experiments were conducted on 12 farmers field (2 farmers in each experiments) in the year 2001-02. The same set was repeated in the year 2002-03. In this way, a total of 60 farmers were considered for OFT in Mahasamund district and 20 and 40 farmers were incorporated for OFT in Rajnandgaon district during 2001-02 and 2002-03, respectively. Therefore, a total of 120 OFTs were conducted on relative performance of different *utera* crops in rice based *utera* cropping system, sowing technique, nutrient management, performance of *utera* crop in relation to stubble height of preceding rice, productivity and economic viability of improved rice based *utera* cropping system.

### Results

The trends of cultivation of rice varieties before and after OFTs shows that Mahamaya, HMT, MTU-1010 and IR-64 (improved dwarf bred) varieties were gaining more area, while Gurmatiya and Safri (traditional bred) were losing their area significantly. Also Bambleshwari and MTU-1001 varieties were introduced among the respondents during OFTs period. This indicates that high yielding dwarf rice varieties were gaining popularity over traditional varieties (Table 1).

### Impact of OFTs on productivity of crops

The findings shows that during OFTs the rice yield was increased by more than 58 per cent and maximum 142.9 per cent increase was recorded in *Lathyrus* followed by 108.33 per cent in lentil and 46.2 and 43.8 per cent in chickpea and linseed, respectively. It indicates that due to

implementation of OFTs the average yield of rice as well as *utera* crops were increased significantly (Table 2).

**Table 1:** Impact of on-farm research on area of rice varieties

Name of rice varieties	Area (ha)		Change (%)	Rank
	Before OFT	After OFT		
- Swarna	68.3	59.4	- 13.03	
- MTU-1001	-	28.6	-	
- IR-64	18.5	20.0	+ 8.11	
- Mahamaya	12.4	36.2	+ 191.94	I
- IR-36	21.2	20.1	- 5.19	
- Safri	49.6	6.5	- 86.89	
- Gurmatiya	32.1	1.2	- 96.26	
- Bambleshwari	-	4.6	-	
- MTU-1010	6.0	12.0	+ 100.00	III
- HMT	12.2	24.9	+ 104.09	II
- Others	11.3	10.0	- 11.50	
<b>Total</b>	<b>220.3</b>	<b>223.5</b>		

**Table 2:** Impact of OFT on productivity of major crops

S.No.	Crops	Productivity (q/ha)		Change (%)
		Before OFT	After OFT	
1.	Rice	18.7	29.6	58.29
2.	<i>Lathyrus</i>	2.1	5.1	142.86
3.	Chickpea	2.6	3.8	46.15
4.	Lentil	1.2	2.5	108.33
5.	Linseed	1.6	2.3	43.75

## Conclusions

The findings shows that during OFTs the rice yield was increased by more than 58 per cent and maximum 142.9 per cent increase was recorded in *Lathyrus* followed by 108.33 per cent in lentil and 46.2 and 43.8 per cent in chickpea and linseed, respectively. The system analysis for the rice-*utera* cropping system indicates that due to implementation of OFTs the average yield of rice as well as *utera* crops were increased significantly due to (i) Introduction of new varieties of rice and *utera* crops, (ii) Increase in production of rice and *utera* crops and (iii) For profitable rice-*utera* system, crop management initiating from rice to *utera* crops is important.

## FARMING SYSTEMS RESEARCH ON CROP DIVERSIFICATION, TILLAGE, AND MANAGEMENT EFFECTS ON YIELD, PESTS, AND ENVIRONMENTAL QUALITY IN A SEMI-ARID ENVIRONMENT

A. Lenssen<sup>1</sup>, U. Sainju<sup>2</sup>, T. Caesar-TonThat<sup>3</sup>, B. Allen<sup>4</sup>, R. Lartey<sup>5</sup>

<sup>1</sup> USDA, ARS, Agricultural Systems Research Unit, Sidney, MT, 59270 USA, [andy.lenssen@ars.usda.gov](mailto:andy.lenssen@ars.usda.gov)

<sup>2</sup> USDA, ARS, ASRU, Sidney, MT, 59270 USA, [upendra.sainju@ars.usda.gov](mailto:upendra.sainju@ars.usda.gov)

<sup>3</sup> USDA, ARS, ASRU, Sidney, MT, 59270 USA, [thecan.caesar@ars.usda.gov](mailto:thecan.caesar@ars.usda.gov)

<sup>4</sup> USDA, ARS, ASRU, Sidney, MT, 59270 USA, [brett.allen@ars.usda.gov](mailto:brett.allen@ars.usda.gov)

<sup>5</sup> USDA, ARS, ASRU, Sidney, MT, 59270 USA, [robert.lartey@ars.usda.gov](mailto:robert.lartey@ars.usda.gov)

### Introduction

Available water, depleted soil quality, and weed competition are important constraints to crop production in the northern Great Plains. The traditional rotation in the region has been spring wheat with summer fallow, which is used to accrue additional soil moisture for the subsequent wheat crop. Tillage during fallow periods controls weeds, which otherwise would use substantial amounts of water and inorganic nitrogen, decreasing the efficiency of fallow and increasing soil erosion. Chemical fallow and zero tillage systems improve soil water status for subsequent crops (Lenssen et al., 2007a), allowing for increased cropping intensity and improved nutrient cycling (Lenssen et al., 2007b) and soil quality (Sainju et al., 2006). However, zero tillage systems can result in greater weed problems. Multi-tactic, cultural management systems, including use of higher seeding rates, banded fertilizer applications, variation in planting dates, and greater crop stubble retention, can improve management of weeds (Anderson, 2005). The objectives of the trial are to compare influences of rotation, tillage, and management system on crop yield, yield components and quality, water and nitrogen use and use efficiencies, soil quality, microbial diversity, carbon sequestration, and weed dynamics.

### Methodology

A long-term dryland field trial was initiated in 2004 comparing four crop rotations in four tillage and management systems. The experimental design is a randomized complete block in a split-plot arrangement. Tillage system is the whole-plot factor, and includes zero-tillage and conventional preplant tillage by a single pass with a field cultivator. Subplots are a complete factorial of management system and rotation components. Rotations are continuous spring wheat (SW), SW-pea, SW-barley for hay-pea, and SW-barley for hay-corn-pea, with each component present every year. Management systems are conventional and ecological practices, and these practices vary by crop. Conventional management practices include standard seeding rate, broadcast nitrogen fertilizer for cereals, and short stubble heights at harvest. Ecological management practices include increased seeding rate, banded nitrogen fertilizer for cereals, delayed planting date for SW, and taller stubble height. Fertilization and pest control practices are typical for the region, except that barley hay does not receive any herbicide application until after harvest. The design allows for comparing influences of rotation, tillage, and management on crop yield and quality, water and nitrogen use, soil quality, microbial diversity, carbon sequestration, and pest dynamics. Long-term average annual precipitation is 320 mm, with about 80% occurring from April through September. The field site is in an area mapped as Williams loam (fine-loamy, mixed, Typic Argiborolls), located near Sidney, Montana, USA (latitude 47°46'N; longitude 104°16'W; altitude 690 m).

### Results

After three years, the main effects of rotation and management system are significant for grain yields of spring wheat and pea (Table 1). Spring wheat yield increased when produced in a two-year rotation with pea, but additional yield was not gained by less frequent planting than every other year. Pea yield was greater following barley hay or corn than spring wheat. Hay production of barley was



greater under zero- than conventional tillage, but for other crops, tillage system had less influence on productivity than management system or rotation. Ecological management reduced weed biomass at harvest (Table 2). Wild oat (*Avena fatua*), green foxtail (*Setaria viridis*), kochia (*Kochia scoparia*), and Russian thistle (*Salsola iberica*) were the principal weed species present at harvest. Regression analyses of yield by weed biomass at harvest resulted in highly significant and negative relationships for wheat and pea, indicating that weed competition had a large impact on grain yield.

Table 1. Mean grain yields from spring wheat, pea and corn, and forage yield from barley in two management and tillage systems, and four crop rotations, 2005-2006.

Parameter	Spring wheat	Pea	Barley hay	Corn
	kg ha <sup>-1</sup>			
Tillage system				
Conventional tillage	3078	2412	5276 b	3357
Zero tillage	2968	2237	6335 a	3854
Management system				
Conventional	3412 a †	2162 b	5149 b	3643
Ecological	2634 b	2489 a	6462 a	3568
Rotation				
Continuous SW	2434 b	-	-	-
SW-pea	3167 a	1979 b	-	-
SW-barley hay-pea	3335 a	2473 a	6133	-
SW-barley hay-corn-pea	3154 a	2522 a	5478	3606

† Means within columns and parameters followed by different letters differ at P=0.05.

Table 2. Mean weed biomass at harvest from four crops in two management and tillage systems, and four crop rotations, 2005-2006.

Parameter	Spring wheat	Pea	Barley hay	Corn
	Weed biomass, kg ha <sup>-1</sup>			
Tillage system				
Conventional tillage	240	498		12
Zero tillage	274	733		10
Management system				
Conventional	416 a †	729	767	16
Ecological	98 b	502	397	5
Rotation				
Continuous SW	547 a	-	-	-
SW-pea	209 b	966 a	-	-
SW-barley hay-pea	59 b	354 b	367	-
SW-barley hay-corn-pea	213 b	527 b	796	11

† Means within columns and parameters followed by different letters differ at P=0.05.

## Conclusions

Early results from this long-term study indicate that ecological management and diversified rotations improve spring wheat and pea yield, in part through increasing crop competitiveness with weeds. However, additional research years across a range of environmental conditions are required for confirmation.

## References

- Anderson, R., A multi-tactic approach to manage weed population dynamics in crop rotations. 2005. *Agron. J.* 97, 1579-1583.
- Lenssen, A., et al., Cropping sequence and tillage system influences annual crop production and water use in semiarid Montana, USA, 2007a. *Field Crops Res.* 100, 32-43.
- Lenssen, A., et al., Diversified cropping systems in semiarid Montana: nitrogen use during drought, 2007b. *Soil Tillage Res.* 94, 362-375.
- Sainju, U, et al., Carbon sequestration in dryland soils and plant residue as influenced by crop rotation and

## **Which energy vectors for requirements in mechanical energy? Bio-fuels or photovoltaic energy? Territory and social consequences.**

M. Benoit<sup>1</sup>, W. Schäfer<sup>2</sup>

<sup>1</sup> U.Eco.Elevage, INRA Theix, 63122 Saint Genès-Champanelle, France benoit@clermont.inra.fr

<sup>2</sup> Animal Production research, MTT Agrifood Research Finland, Vakolantie 55 FI-03400 Vihti, Finland, winfried.schafer@mtt.fi

### **Introduction**

Current debates focus mainly on the development of renewable energies like the “green fuels”, based on agriculture products. The energy vector used is the biomass generated by photosynthesis. Its poor efficiency (less than 1%) requires a considerable proportion of agricultural area to aim at 5.75% bio fuel in 2010 in Europe. Production of feedstocks for industry and food for the world population (soon 7 milliards inhabitants) compete for land with energy crop production. Consequently, there is the need to transform solar energy into mechanical energy for our vehicles along the most efficient and land saving pathway. The shortest energy chain is photovoltaic electricity (PV) produced with solar panels and directly used by vehicle. In contrast to production, processing, and conversion of biomass into fuel, PV causes no additional direct energy input. Moreover, the conversion efficiency of rising generation of PV panels reaches 13% and more. Our objective is to evaluate the level of energy production of one area unit in respect of bio-fuel, photovoltaic electricity, and hydrogen generated by PV powered electrolysis.

### **Methodology**

Insolation powers nearly all renewable energy sources. We limit our study to three pathways of solar energy utilisation: (i) production of biomass via photosynthesis, (ii) production of electric power via photovoltaic solar panel, and (iii) production of fuel by photochemical and photo electrochemical processes. As an example of each pathway, we compare three types of fuel for vehicles: ethanol from wheat as fuel for a modified gasoline engine, direct current (DC) produced by a photovoltaic solar panel powering a DC-motor via accumulators, and hydrogen, produced by photovoltaic solar panel and electrolysis powering a modified gasoline engine. We calculate the energy efficiency taking into consideration the energy input for production and conversion of fuel, the energy content of the fuel and the energy output after conversion into mechanical energy. The efficiency is compared by the distance per ha of a car using each kind of fuel, considering standard energy consumption (gasoline, electricity, hydrogen).

### **Results**

Ethanol fuel produced from 1 ha wheat carries a distance of 21 600 km. We assume a yield of 9 tons seed per ha or 142 GJ/ha. We estimate the primary energy input of cultivation, processing, and conversion into ethanol at 49% (ADEME 2006, Elsayed et al. 2003). Assuming 22% efficiency of the thermal gasoline engine, the supplied mechanical energy is of  $142 \cdot 0.51 \cdot 0.22 = 16.0$  GJ/ha.

Direct current produced from 1 ha solar panels carries a distance of 2.780.000 km. The present solar panels produce up to 130 Wp/m<sup>2</sup>. We estimate the annual production at 135 kWh/m<sup>2</sup> and year at optimal orientation of 33° and 1100 h annual insolation. A minimum distance of 1.8 m between the panels precludes shadow, but limits the feasible panel area to 0.55 m<sup>2</sup>/m<sup>2</sup> ground. Consequently the energy yield is  $135 \cdot 0.55 = 74$  kWh/m<sup>2</sup> or 2.677 GJ/ha and year. We suppose that manufacture of the panel cost 6.5 % of the produced energy. Assuming 73 % efficiency of the electric motor, the supplied mechanical energy is  $2.677 \cdot 0.935 \cdot 0.73 = 1.827$  GJ/ha.

Hydrogen fuel produced by PV power carries 365.000 km/ha. We suppose that the efficiency of hydrogen generation by the electrolysis of water is 50 %. So, the net energy of hydrogen is  $2.677 \cdot 0.935 \cdot 0.5 = 1.251$  GJ/ha. We assume that 70% of the energy (876 GJ/ha) is available after compression and storage and that the thermal efficiency of the engine is nearly 40 % (67% higher than gasoline engine). Thus, the supplied mechanical energy is  $876 \cdot 0.40 = 350$  GJ/ha.

The table 1 shows that electric power is more than 100 times efficient in terms of produced mechanical energy or kilometres per ha than ethanol. The results correlate with the overall

efficiency of the energy chain (from solar energy to mechanical energy). While PV reaches 4.9%, hydrogen attains 0.9 % and ethanol 0.04 % only. These values correspond to 43.5 toe/ha for PV, 8.3 toe/ha for hydrogen and 0.38 toe for ethanol respectively.

If we consider oil from rapeseed instead of ethanol from wheat, we can analyse that i) the energy balance is better (only 0.33 MJ of non renewable energy for 1 MJ delivered energy), ii) the yield per ha is lower (1370 litres of oil for 3.3 t grain instead of 2550 litres of ethanol for 9 t grain), iii) the energetic content is higher (37.2 MJ/kg instead of 26.8) (ADEME 2002 and 2006). Finally, the renewable energy produced is not better with 34.1 GJ/ha vs 34.8 for ethanol.

Table 1: Comparison of mechanic energy available and kilometres possible between ethanol, PV electricity, and hydrogen from PV electricity dies, from one hectare (base one: ethanol)

Per ha	Ethanol	Electricity	Hydrogen
Mechanic energy	1	115	22
Kilometre vehic.	1	129	17

## Conclusion

This study may appear very theoretically hence the presented technologies are subject of continuous development. However, the aim is to show the gap between bio fuel from energy crops and PV fuel. Such large differences of efficiencies show clearly where to set priorities for the long term research. Research on solar-technical processes to produce thermo chemical fuels (Abu-Hamed et al. 2007) or liquid carbon hydrates from methane, carbon dioxide and water powered by solar energy without diversion into photosynthesis (Gattrell et al. 2007, Centi & Perathoner 2006) offers much a greater potential than research on energy crop production.

Setting the priority for one or the other of these two pathways may have a strong impact either on economics or on environmental issues, or even on food resources and social aspects. For example, production of PV energy needs only 1 % of the area provided for energy crops and the saved 99 % of the area compensate more than the lower yield of organic farming area in terms of food quantity per ha. Organic farming plus PV energy production reduce not only energy consumption for food production but also reduce environmental pollution.

Another advantage of PV energy is that it can be produced not only on the poorest arable lands but also on the roofs of the buildings, whether they are agricultural, industrial, or urban. Installation of solar panels in mountain areas improves the efficiency of PV because of lower temperature and reduces competition for better lands.

Presently, the energy of one hour insolation reaching the earth would be enough to cover the annual energy consumption of the world. One challenge for research is to use solar energy as directly as possible with the minimum of transformations. Therefore, the direct technical use of sun energy allows i) to satisfy the food needs of the humanity, ii) to reduce inputs with strong negative impacts on the environment and on human health, iii) to reserve a part of arable land for the production of non alimentary agricultural products (fibres, drugs, feedstocks).

The agricultural sector in Europe consumes more energy than it produces. The major part of biomass produced for feedstocks and food remains energetically unused. Organic waste is the right source for biofuel production hence it requires only energy for conversion and storage. We suppose that the progress based on research and development will not impugn these conclusions.

## References

- Abu-Hamed T. et al 2007: The use of boron for thermochemical storage and distribution of solar energy. *Solar Energy* 81 (2007) 93–101.
- ADEME 2006, Energy and GHG balances of biofuels and conventional fuels. Convergences and divergences of main studies, Study realized for ADEME by ECOBILAN, 18p.
- ADEME 2002, Bilans énergétiques et gaz à effet de serre des filières de production de biocarburants en France. Note de synthèse (décembre 2002). ADEME-DIREM-PRICE WATERHOUSECOOPERS, 19p.
- Centi G., Perathoner S. 2006: Converting CO<sub>2</sub> to fuel: A dream or a challenge? The 232nd ACS National Meeting, San Francisco, CA, September 10-14, 2006,
- Elsayed M. et al 2003. Carbon and energy balances for a range of biofuels options. Project report number B/B6/00784/REP, Department of Trade and Industry Sustainable Energy Programme URN, 03/836, Resources Research Unit, Sheffield Hallam University, Un.Kingdom. Final Report for the Energy Technology Support Unit. Report No. 21/3, 27 S. <http://www.dti.gov.uk/files/file14925.pdf?pubpdfdownload=03%2F836>
- Gattrell M. et al 2007. Electrochemical reduction of CO<sub>2</sub> to hydrocarbons to store renewable electrical energy and upgrade biogas. *Energy Conversion and Management* 48:1255–1265.

## Energy balances in mixed crop-sheep farming system: adaptations for its improvement and main factors of variation.

M. Benoit<sup>1</sup>, G. Laignel<sup>1</sup>

<sup>1</sup> Unité Économie de l'Élevage, INRA Theix, 63122 Saint Genès-Champanelle, France benoit@clermont.inra.fr

### Introduction

Breeding systems are currently evaluated not just in terms of technico-economic performance but equally in term of environmental impact, including energy balance. The energy balance factor is based on the capacity of the farm to produce the maximum energy in the form of agricultural products with a minimum recourse to non-renewable energies. This approach is driven by dwindling fossil energy resources which are subsequently increasingly expensive, together with climate change concerns. The energy efficiency of mixed-farming sheep breeding systems is primarily related to feed purchases for the flock, nitrogen fertilization, and fuel (Boisdon 2006, Solagro 2005). We studied a sheep farming system highly representative of a French plain area to evaluate the potential for improvements in energy efficiency (EE) and their economic impacts *via* three successive adaptations: achieving total feed self sufficiency, a total substitution of the nitrogen fertilization by legumes, and the production of agro-fuel (rapeseed) covering 30 or 100% of the farm's needs. We then evaluated the impact of 5 other factors in relation to flock management strategies and/or farm structure. These scenarios are studied by running simulations with modelling tools that can be used as powerful prospective tools (Dalgaard et al. 2001).

### Methodology

The standard farm studied is based on a total agricultural area of 130 ha, where 29 ha are devoted to cash crops and 9 to feed crops for a 610-ewe flock in which 40% of the lambings take place at the end of autumn and the remainder in spring. Concentrate consumption reaches 137 kg per ewe, with 55% being purchased. Farm operations and performances are modelled using a simulation tool (OSTRAL) that can also calculate energy balance when run alongside PLANET software (Bochu, 2002).

Initially, the adaptations studied do not deal with flock management strategies, keeping the same (i) numerical productivity (139%) (ii) type of lambs, which was essentially lambs fattened in the sheep fold, (iii) size of the farm, forage and crop areas, stocking rate. Three successive system adaptations were studied on this basis: (i) we replaced cash crops (wheat, sunflowers) by crops for animals (triticale and protein-rich plant mixtures) in order to obtain a total food self sufficiency (Food.SS); (ii), a rotation with 2 years of red clover followed by 4 years of crops was introduced in order to obtain total nitrogen self-sufficiency (Nitr.SS), with systematic integration of meadows with leguminous plants in the fodder area (Triboï et al. 2004); (iii) the production of agro-fuel is considered at two different levels of production, i.e. 30% (Fuel30%) and 100% (Fuel100%) of farm needs, with rapeseed oil cakes being used by the flock in place of cereals and protein-rich plants.

In a second step, we studied the impact of 5 other factors that modify flock management and/or the structure of the farm: numerical productivity of the flock, weight of the lambs, numbers of ewes, structure of the farm (size and distance of the plots), and proportion of the cash crop in the total farm area.

### Results

**Step 1: impacts of the 3 successive and cumulative adaptations** (Flock management and structure of the farm kept).

The EE is presented at 2 levels: the global EE (EEg) and the EE of the sheep unit only (EEsh).

Initially (Basis, figure 1), the EEsh was 0.42. Total food self-sufficiency (Food.SS) leads to a 10% increase in EEsh (to 0.46).

Figure 1: Evolution of Energetic Efficiencies (EEg and EEsh) and energy consumption per kg carcass.

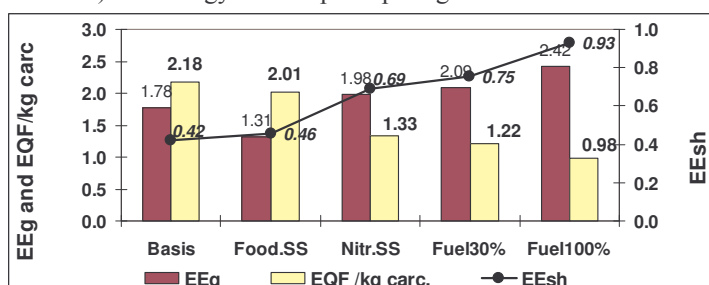
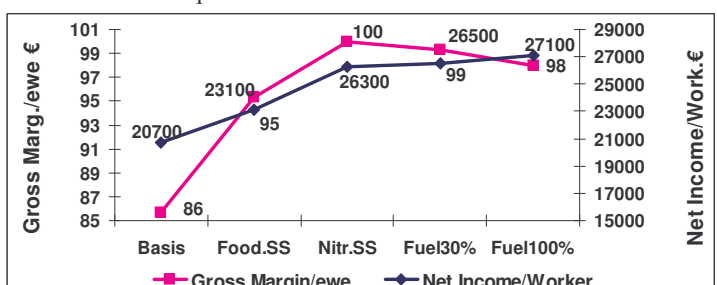

Figure 2: Impact of adaptations on gross margin per ewe and net income per worker.



There is a much greater improvement when legumes replaced the nitrogen fertilizers, with EEsh reaching 0.69, and producing 30% to 100% of the necessary fuel on-farm makes it possible to reach 0.75 and 0.93, respectively. In parallel, necessary non-renewable energy expressed in EQuivalent liters of Fuel (EQF) decreases from 2.18 to 0.98 per kilo of carcass, with a significant drop (nearly 0.7 EQF/kg) when no nitrogen fertilizer is purchased. It should be underlined that the EEg of the farm drops between Basis and Food.SS because the improvement of the food self-sufficiency of the flock results in a negative trade-off for area of the cash crops, which have a much higher energy efficiency (5 to 9). In the economic context selected (wheat costing 10 €/T, rapeseed 20 €/T, sheep meat 5.27 €/kg carcass, and fuel 0.55 €/liter), improvement in EE fits with better economic results (figure 2). Gross margin per ewe and the net income per worker are initially improved by better food self-sufficiency (+10%) and by nitrogen self-sufficiency (+5% and +14%, respectively). Fuel self-sufficiency in this same economic context generates only a small increase in income.

**Step 2: other factors of the variability** (Flock management or structure of the farm modified).

The level of *numerical productivity* (NP = number of lambs alive per ewe and per year) has a very positive impact on EEsh which switches from 0.29 to 0.48 when NP increases from 0.80 to 1.70.

There is a similar pattern in response to an increase in *weight of the lambs*: EEsh increases from 0.38 to 0.44 as lamb weight increases from 15.3 kg/head to 20.3. Indeed, in suckling systems, the majority of economic and energy cost is generated by breeding the ewes, in particular the production of fodder with all the fertilizers and machinery entailed. Also, a higher average weight of the lambs or a higher NP makes it possible to 'dilute' these basic energetic costs.

As the average *distance of the plots* of the farm increases, it requires more energy to move the related machinery. Thus, when the average distance passes from 592 meters (compact farm structure) to 11,800 meters, EEsh only decreases from 0.42 to 0.37. This phenomenon explains why there is little economy of scale to be gained from an energy point of view (indirect energy related to the equipment for example) when *the size of the flock strongly increases*, because the dimension of the farm increases too. Thus, a switch from 175 to 1,200 ewes, results in EEsh increasing from 0.40 to only 0.42. In breeding systems based on greater grass use and less mechanization, the increase of EEsh would be much more evident. For a very high flock size (> 1200 for the studied system), the use of major equipment, such as automated feed distribution machinery, can strongly penalize EEsh which subsequently drops to 0.39 at 2,000 ewes.

It is well known that *the proportion of cash crops* in the total farm area has a major impact on EEg. In the scenario studied, raising the cash crop area from 0% to 76% of the agricultural area (0 to 337 ha), but with the same flock, led to very important increase in EEg, from 0.41 to 4.7. At the same time, EEsh increased slightly, from 0.41 to 0.43 as a larger proportion of the indirect energy linked to the machinery is reassigned to cash-crop production.

## Conclusion

A great improvement in EE is obtained by phasing out nitrogen fertilization (SOLAGRO 2005), with the introduction into the rotation of legumes which are advantageously used by the flocks. In suckling systems, an increase in animal productivity in terms of NP or carcass weight also correlates to an improvement in EE. It is possible that the increase in the size of the farms do not lead to an improvement in EE since it implies greater mechanization of the work involved, which depends on higher farm labour productivity. The level of EE that will be reached will be higher as more animal feed is sourced directly from the farm, in particular fodder, and especially by pasture feeding. Other EE improvement strategies could be studied, in particular changes in flock management involving a better use of fodder and thus an improvement in fodder self-sufficiency.

## References

- Bochu JL. 2002. Méthode d'analyse pour l'analyse énergétique de l'exploitation agricole et l'évaluation des émissions de gaz à effet de serre. SOLAGRO, 10p [http://www.solagro.org/site/im\\_user/014planeteooc02.pdf](http://www.solagro.org/site/im_user/014planeteooc02.pdf)
- Boisdon I., Benoit M. 2006. Compared energy efficiency of dairy cow and meat sheep farms, in organic and in conventional farming. Organic Farming and European Rural Development. Congress Odense Denmark, 30-31 August 2006. Proceedings 442-443.
- Dalgaard T., Halberg N., Porter JR., 2001. A model for fossil energy use in Danish agriculture used to compare organic and conventional farming. Agriculture Ecosystems & Environment, 87, 1, 51-65.
- SOLAGRO, 2005. Maîtrise de l'énergie et autonomie énergétique des exploitations agricoles françaises : état des lieux et perspectives d'actions pour les pouvoirs publics. Synthèse d'étude. Réf. MPA 05.B1.05.01. 15p. [http://www.solagro.org/site/im\\_user/014633\\_minagri\\_synthv2.pdf](http://www.solagro.org/site/im_user/014633_minagri_synthv2.pdf)
- Triboï E., Triboï-Blondel AM. 2004. Cropping system using lucerne as nitrogen source. VIII ESA Congress: European agriculture in a global context. LVL Copenhagen, Denmark, 11-15 July 2004, Proceedings, 683- 684.

## ENERGY BALANCE OF THREE PERENNIAL CROPS FOR ENERGY IN SOUTHERN ITALY\*

M. Mantineo<sup>1</sup>, G. D'Agosta<sup>1</sup>, V. Copani<sup>1</sup>, C. Patanè<sup>2</sup>

<sup>1</sup> DACPA – Sezione Agronomiche, Università di Catania, Italy, [md.mantineo@unict.it](mailto:md.mantineo@unict.it)  
<sup>2</sup> CNR-ISAFOM, Unità Organizzativa di Supporto di Catania, Italy [c.patane@isafom.cnr.it](mailto:c.patane@isafom.cnr.it)

### Introduction

The “Biomass Action Plan” (2005) of the European Union indicates the possibility of producing second generation bioethanol from cellulose and hemicellulose. Perennial lingo-cellulosic crops as giant reed (*Arundo donax* L.), *Miscanthus* spp. and cardoon (*Cynara cardunculus* L. var. *altilis* D.C.) may represent a good source of these compounds, being high productive and having a high energetic content. However, according to their destination, the energetic indices of these crops, should be investigated. On this basis a field experiment was carried out in order to evaluate the energy yield of these species in relation to the amount of energy used for irrigation and nitrogen application.

### Methodology

The field experiment was carried out in the fourth-year 2002-2006 in the South of Italy (450 m a.s.l., 37°23' N Lat, 14°21' E Long) on a Typic Xerorthents soil (Fierotti, 1998). Three different species (a local clone of *Arundo donax* L., *Miscanthus x giganteus* Greef et Deu. and *Cynara cardunculus* L. var. *altilis* D.C. cv. “Cardo gigante inerme”) with two different irrigation treatments (75% and 25% of ET<sub>c</sub> restoration) and two nitrogen fertilization levels (100 (N<sub>100</sub>) and 50 (N<sub>50</sub>) kg ha<sup>-1</sup>) were studied in a split plot experimental design with three replicates. *Arundo* and *Miscanthus*, as warm season crops, were irrigated throughout the summer season, whilst *Cynara*, as winter crop, was irrigated during summertime in the first year and in September in the second and third year. *Arundo* and *Miscanthus* were propagated by part of plants (stems and rhizomes, respectively) whilst *Cynara* by seeds. In the 4<sup>th</sup> year of experiment (2005-2006), in order to study the crop yield and energetic response to no-inputs, both fertilization and additional irrigation were not applied.

In all years, *Arundo donax* and *Miscanthus* were harvested on February and *Cynara* on August. The method of Combes (1998) was adopted to determine the input of energy associated with the manufacture of production means in terms of primary energy input. The energy outputs were calculated by means of energetic equivalents as proposed by Odum (1988).

Data were statistically analysed by ANOVA separately for each year and crop.

### Results

The yield of *Arundo* and *Miscanthus* increased with year attaining 38.8 and 27.0 t ha<sup>-1</sup> in the 3<sup>rd</sup> year, while yield of *Cynara* decreased from 24.7 t ha<sup>-1</sup> of the 2<sup>nd</sup> year to 18.1 t ha<sup>-1</sup> of the 3<sup>rd</sup> year (Fig. 1).

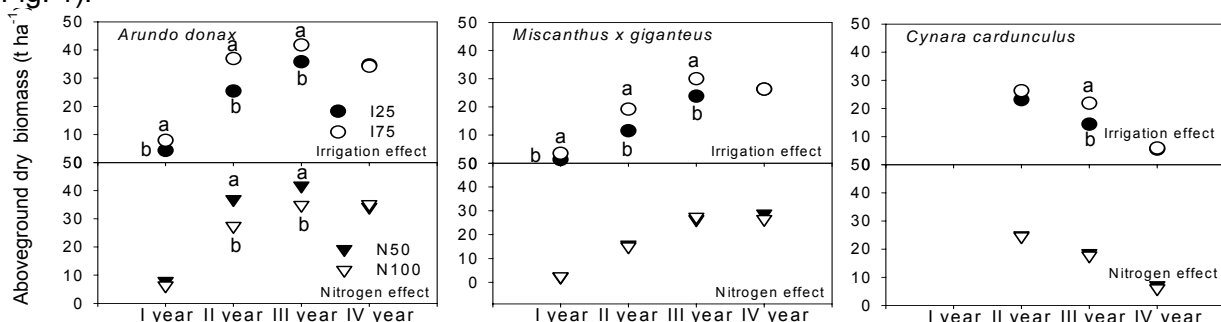

Fig. 1 - Mean effect of irrigation and nitrogen on aboveground biomass at harvest in the studied crops. Different letters beside each symbol indicate significantly different values at  $P \leq 0.05$  by SNK.

In the first three years dry biomass greatly varied with the irrigation levels in all crops, while no difference was recorded in relation to the nitrogen fertilization levels, except for *Arundo* where in

\* The reported research was supported by the Italian Ministry of Agriculture (MiPAF) programme of research TISEN "Sustainable innovative techniques of production and transformation of the energetic and no food crops".

the 2<sup>nd</sup> and 3<sup>rd</sup> year both irrigation and nitrogen exerted a significant effect upon dry biomass (Tab. 1). The reduction of the amount of water supplied (from 75 to 25% of Etc restoration) determined a yield decrease by 30.4 % in *Miscanthus* (17.6 t ha<sup>-1</sup> vs. 12.2 t ha<sup>-1</sup>), 24.4 % in *Arundo* (from 28.9 to 21.8 t ha<sup>-1</sup>) and 20.3% in *Cynara* (from 24 t ha<sup>-1</sup> to 18.7 t ha<sup>-1</sup>), on average of the three years. In the 4<sup>th</sup> year under no-input conditions, *Arundo* and *Miscanthus* maintained their productivity level because of exceptional rainfall occurred during summertime (300 mm). *Cynara* produced only 6.1 t ha<sup>-1</sup>, being in the decreasing phase of growth (Gherbin et al., 2001).

Table 1 – Net energy yield in studied crops (GJ ha<sup>-1</sup>) from the first to the third year. Values followed by the same letter do not differ at P ≤ 0.05 by SNK.

Treat.	<i>Arundo donax</i>				<i>Miscanthus x giganteus</i>				<i>Cynara cardunculus</i>		
	I year	II year	III year	Average	I year	II year	III year	Average	II year	III year	Average
I <sub>25</sub>	31.8 b	384.5b	556.4a	324.2	-16.5 b	161.8 b	367.5 b	170.9	345.8 a	321.4 b	283.6
I <sub>75</sub>	68.4 a	547.9a	633.9a	416.7	-2.4 a	265.7 a	446.0 a	236.4	379.8 a	338.6 a	359.2
N <sub>50</sub>	54.3 a	405.1b	549.5b	336.3	-9.7 a	221.2 a	399.1 a	203.5	366.4 a	287.9 a	327.2
N <sub>100</sub>	45.9 a	527.3a	640.8a	359.1	-9.2 a	206.3 a	414.4 a	203.8	359.2 a	272.1 a	315.7
<b>Average</b>	<b>50.1</b>	<b>466.2</b>	<b>595.1</b>	<b>370.5</b>	<b>-9.4</b>	<b>213.8</b>	<b>406.7</b>	<b>203.7</b>	<b>362.8</b>	<b>280.0</b>	<b>321.4</b>

In the average of the 2<sup>nd</sup> and 3<sup>rd</sup> years, the highest net energy yield was recorded in *Arundo* (530.6 GJ ha<sup>-1</sup>), compared to *Miscanthus* (340.3 GJ ha<sup>-1</sup>) and *Cynara* (321.4 GJ ha<sup>-1</sup>) (Tab. 1). The amount of energy introduced in the system with the increase of irrigation and nitrogen input was generally lower than that produced with the yield increase. This is generally true with irrigation in all crops, whereas low irrigation level reduced significantly the net energy yield by 22 % in *Arundo* and *Cynara* and 28% in *Miscanthus*. As far as nitrogen application is concerned, significant difference was recorded only in *Arundo* in the second and third years between N<sub>50</sub> (405.1 and 549.5 GJ ha<sup>-1</sup>, respectively) and N<sub>100</sub> (527.3 and 640.8 GJ ha<sup>-1</sup>, respectively) treatments. The 4<sup>th</sup> year *Arundo* and *Cynara* exhibited the highest (552.4 GJ ha<sup>-1</sup>) and the lowest (92.84 GJ ha<sup>-1</sup>) net energy yield, respectively (Tab. 3).

Table 2 – Energy ratio in the studied crops from the first to the third year. Values followed by the same letter do not differ at P ≤ 0.05 by SNK.

Treat.	<i>Arundo donax</i>				<i>Miscanthus x giganteus</i>				<i>Cynara cardunculus</i>		
	I year	II year	III year	Average	I year	II year	III year	Average	II year	III year	Average
I <sub>25</sub>	1.9 a	17.6 a	24.8 a	14.7	0.6 b	8.1 a	16.8 a	8.5	11.8 a	15.5 b	13.6
I <sub>75</sub>	2.2 a	13.4 b	15.1 b	10.2	1.0 a	7.1 a	10.9 b	6.3	8.8 b	23.2 a	16.0
N <sub>50</sub>	2.1 a	14.2 a	19.1 a	11.8	0.7 a	8.1 a	14.2 a	7.7	10.8 a	21.4 a	16.1
N <sub>100</sub>	1.9 a	16.8 a	20.8 a	13.2	0.8 a	7.0 a	13.5 a	7.1	9.9 a	17.2 a	13.5
<b>Average</b>	<b>2.0</b>	<b>15.5</b>	<b>19.9</b>	<b>12.5</b>	<b>0.8</b>	<b>7.6</b>	<b>13.9</b>	<b>7.4</b>	<b>10.3</b>	<b>19.3</b>	<b>14.8</b>

Energy ratio (output/ input) was the highest in the second and third year in *Arundo* (15.5 and 19.9 respectively) and in *Cynara* (10.3 and 19.3 respectively), while was the lowest in *Miscanthus* (7.6 and 13.9 in the second and third year, respectively). In the fourth year without any input (Tab. 3) *Arundo* exhibited the highest energy ratio (73.7) followed by *Miscanthus* (58.1) and *Cynara* (13.2).

Table 3 – Net energy yield (b) (GJ ha<sup>-1</sup>) and energy ratio (c) in the fourth year

Previous treatments	<i>Arundo donax</i>		<i>Miscanthus x Giganteus</i>		<i>Cynara cardunculus</i>	
	(b)	(c)	(b)	(c)	(b)	(c)
I <sub>25</sub> N <sub>50</sub>	538.8	71.9	421.8	56.6	81.8	11.8
I <sub>25</sub> N <sub>100</sub>	543.5	72.5	423.9	59.6	90.5	12.9
I <sub>75</sub> N <sub>50</sub>	559.7	74.6	466.1	59.4	107.8	15.2
I <sub>75</sub> N <sub>100</sub>	567.8	75.7	425.1	56.9	91.3	13.0
<b>Average</b>	<b>552.4</b>	<b>73.7</b>	<b>434.2</b>	<b>58.1</b>	<b>92.8</b>	<b>13.2</b>

## Conclusions

The studied crops showed high yield and energetic levels. *Arundo* performed better than the other two crops in terms of yield, net energy yield and energy ratio, and may represent a promising crop being endemic and adapted to the Mediterranean environment. *Cynara* moreover may be also used to the semi-arid environment conditions, being a winter-autumn crop.

## References

- Biomass Action Plan of the European Union, 2005.  
 A. Combes, Elaboration d'un Referentiel pour le Calcul des Bilans Energetic en Agriculture, 1998. Agence de l'Environnement et de la Maîtrise de l'Energie.  
 E. P Odum, Basi di ecologia, 1988. Piccin Ed., Padova,  
 G. Fierotti Carta dei Suoli della Sicilia, 1988. Regione Siciliana Assessorato Territorio e Ambiente, Palermo.  
 P. Gherbin et al., 2001. Five year evaluation on Cardoon (*Cynara cardunculus* L. var. *altilis*) biomass production in a Mediterranean environment. Italian J. of Agronomy, 5 (1-2): 11-19.

## COMPARISON AMONG PERENNIAL LIGNOCELLULOSIC SPECIES FOR ENERGY PRODUCTION AND EFFICIENCY IN CENTRAL ITALY

N. Nassi<sup>1</sup>, L. Ceccarini<sup>1</sup>, E. Bonari<sup>2</sup>, L. G. Angelini<sup>1</sup>

<sup>1</sup> Dep. of Agronomy, Pisa University, Italy, angelini@agr.unipi.it

<sup>2</sup> Scuola Sup. S. Anna, Pisa, Italy, bonari@sssup.it

### Introduction

Demand for bioenergy is increasing as concerns about climate change lead to implementation of policy measures that favour renewable energy sources over their fossil-fuel-based competitors. Perennial energy crops as giant reed (*Arundo donax* L.), miscanthus (*Miscanthus x giganteus*) and cardoon (*Cynara cardunculus* L.) may represent a good source of biomass for solid bio-fuel production under new CAP conditions. Besides, these perennial species show some positive characteristics which include: adaptation to different climatic conditions, high yield, low nutrient and water requirement, few problems with cultivation, harvesting and risk from pests, long life cycle with increment in soil carbon content and biodiversity (Angelini et al., 2005 a, b; Lewandowski et al., 2003; Fernández et al., 2006). The aim of this study was to carry out a long-term experiment of three perennial bioenergy crops in order to compare their potentialities as energy crops and their energy balance under the climatic condition of Central Italy.

### Methodology

Three experimental fields were planted in 1992 with giant reed (local ecotype), miscanthus and cardoon (var. *altilis* DC. cultivar Gigante di Romagna) at Pisa countryside, Italy (43°40'N, 10°19'E) from the 1<sup>st</sup> to the 12<sup>th</sup> year of crop cycle. The soil was a typical Xerofluvent, representative of the lower Arno River plain and it was characterized by a superficial water table. The three species were compared in a randomised block experimental design with four replications. Planting was carried out on March using rhizomes for giant reed and miscanthus and using three-four true leaves plants for cardoon. The plant density was 20,000 plants ha<sup>-1</sup>. Soil tillage was conducted in the autumn before, and consisted of medium-depth ploughing (30-40 cm). Seedbed preparation was carried out in the spring, immediately before planting, by a pass with a double-disking harrow and a pass with a field cultivator. Plant fertiliser was distributed at a rate of 100 kg ha<sup>-1</sup> of N-P-K before planting in the first year and before the start of vegetative re-growth in the following years of cultivation. Plots were kept weed-free by hoeing. No crop diseases were detected during the experimental period. Following each growing season, harvests were carried out in Autumn (beginning of October). Fresh and dry weight, plant height, stem diameter and stem density were determined. After sampling, all biomass was milled and calorific value was determined using a Leco AC 300 calorimeter according to the ASTM D2015 standard method. The energy balance was assessed considering the energy costs of production inputs and the energy output obtained by the transformation of the final product. Energy analysis of biomass was made according to the method described by Angelini et al. (2005a). The efficiency of crop energy production was evaluated as net energy yield (calculated as the difference between energy output and energy input per hectare) and as energy production efficiency (as ratio between energy output and energy input per hectare).

### Results

Above ground dry yield of giant reed, miscanthus and cardoon, determined from the establishment year to the 12<sup>th</sup> year of growth is reported in Figure 1. These perennial species showed a good adaptation to the pedo-climatic conditions of the Arno river plain characterized by deep and fertile soils and mild winter temperatures. In this environment giant reed was characterized by higher dry yield than miscanthus and cardoon (37 t ha<sup>-1</sup> vs 27 and 18 t ha<sup>-1</sup>). For each species the crop yield was very poor in the first establishment year. Thereafter the biomass yield increased rapidly from the young to the mature stand. Each species displayed similar production trends characterized by three yielding phases: an increasing phase from the 1<sup>st</sup> to the 2<sup>nd</sup> year of growth, a maturity phase from the 2<sup>rd</sup> to the 7<sup>th</sup> and a decreasing phase from the 8<sup>th</sup> to the 12<sup>th</sup> year of growth. From 1<sup>st</sup> to 2<sup>nd</sup> year-old-crop giant reed and cardoon biomass dry yield increased +79% (from 10 to 48 t ha<sup>-1</sup>



year<sup>-1</sup>) and + 74% (from 7 to 27 t ha<sup>-1</sup> year<sup>-1</sup>), while the increment was + 43% (from 29 to 51 t ha<sup>-1</sup> year<sup>-1</sup>) in miscanthus. In the maturity stage (year 2-7) differences in yield production levels have been observed among the three species, with 46 t ha<sup>-1</sup> in giant reed and -30% and -66% dry yield in miscanthus and cardoon respectively. From year 8-12 a decreasing production trend was observed in each crop, however differences in the yield level have been recorded (28 t ha<sup>-1</sup> year<sup>-1</sup> in giant reed and -18% and - 57% in miscanthus and cardoon respectively). All the three perennial crops were characterized by a favorable energy balance along the overall lifecycle (Table 1). During the field trial the total energy input was the same for the three species because identical management practices were applied. Soil tillage and planting were the main energy input in the crop establishment, while fertilisation and harvest represented the unique energy input from the 2<sup>nd</sup> year onward. For this reason the total energy input changed from 15.3 GJ ha<sup>-1</sup> in the establishing year to 11 GJ ha<sup>-1</sup> in the following years. The energy output showed different values for each crop

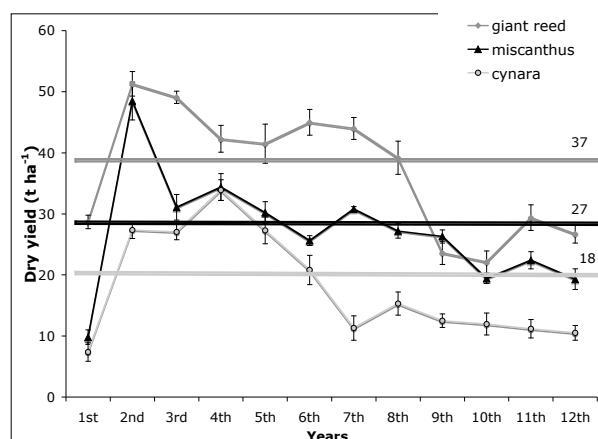

Figure 1. Above-ground dry yield of giant reed, miscanthus and cardoon from the crop establishment to the 12<sup>th</sup> year of growth in comparison, for each species, with the mean value

and giant reed energy output was higher than miscanthus and cardoon. Moreover, the two rhizomatous species are characterized by an energy efficiency and energy balance more favourable than cardoon (Table 1). The net energy yield of the overall lifecycle was 605 and 446 GJ ha<sup>-1</sup> for giant reed and miscanthus respectively against 258 GJ ha<sup>-1</sup> of cardoon.

### Conclusion

Giant reed and miscanthus confirmed their better production performances than cardoon in term of biomass yield and net energy yield. However, cardoon crop efficiency could be increased testing other genetic sources under different management practices. The possibility to cultivate different biomass crops in the same land area allow to expand feedstock supplies minimising their negative impact on soil fertility and biodiversity. In order to improve the biomass

resources in Europe, biomass systems should not be based on a singles feedstock type but on regional capability and specification. According this approach the present research has assessed a long term availability of complementary crops maximizing the yield on land area within sustainable agro-biomass systems.

Table 1. Global energy balance for giant reed, miscanthus and cardoon from the crop establishment to the 12<sup>th</sup> year of growth.

	Input (GJ ha <sup>-1</sup> )	Output <sup>(2)</sup> (GJ ha <sup>-1</sup> )			Energy efficiency			Net energy yield (GJ ha <sup>-1</sup> )		
		G <sup>(1)</sup>	M <sup>(1)</sup>	C <sup>(1)</sup>	G <sup>(1)</sup>	M <sup>(1)</sup>	C <sup>(1)</sup>	G <sup>(1)</sup>	M <sup>(1)</sup>	C <sup>(1)</sup>
Year 1	15.3	479	166	109	31	11	7	464	150	94
From 2 <sup>nd</sup> to 7 <sup>th</sup>	11	760	565	367	69	51	33	749	554	356
From 8 <sup>th</sup> to 12 <sup>th</sup>	11	408	387	183	43	35	17	460	376	172
<b>Mean</b>		<b>590</b>	<b>457</b>	<b>269</b>	<b>55</b>	<b>41</b>	<b>24</b>	<b>605</b>	<b>446</b>	<b>258</b>

<sup>(1)</sup> G=Giant reed, M=Miscanthus, C= Cardoon; <sup>(2)</sup> Calculated as product of dry yield and calorific value 16.7, 16.9 and 14.9 MJ kg<sup>-1</sup> for giant reed, miscanthus and cardoon respectively.

### References

- G. L. Angelini et al., Biomass yield and energy balance of giant reed (*Arundo donax* L.) cropped in central Italy as related to different management practices, 2005a. European Journal of Agronomy 22(4), 375-389
- G.L. Angelini et al., Long term evaluation of biomass production of giant reed (*Arundo donax* L.) to different fertilisation input, plant density and harvest time in a Mediterranean environment, 2005b In: Proceeding of 14<sup>th</sup> European Biomass Conference and Exhibition, Paris, October 17-21, 2005, p. 141-144
- I. Lewandowski et al., 2003. The development and current status of perennial rhizomatous grasses as energy crops in the US and Europe. Biomass & Bioenergy 25, 335-361
- J. Fernández et al., Industrial application of *Cynara cardunculus* L. for energy and other uses, 2006. Industrial Crops and Products 24, 222-229

## SUSTAINABLE CROP AND LIVESTOCK PRODUCTION SYSTEMS IN THE WESTERN HIGH PLAINS, USA

J. B. Norton

Dep. of Renewable Resources, University of Wyoming, USA, jnorton4@uwyo.edu

### Introduction

With profits threatened by rising costs of fuel, fertilizer, and other inputs, many producers of the Western High Plains are asking how to increase yields, cut costs, or increase value. Reduced-input or organic farming approaches can achieve these goals, but transition to either means learning new techniques, investing money, and taking risks. Most agricultural research in the wheat- and beef-producing region in the northern part of the Western High Plains (Figure 1) is narrowly disciplinary and responds to short-term needs within a conventional, production agriculture framework. Basic shifts in economic and ecological drivers of agriculture systems are creating a need for systems research that can address short-term questions within a framework that assesses long-term economic, social, and biological impacts of alternative production approaches.

Growth of biofuel production is expected to increase crop prices and intensify production. Prices for wheat and other non-biofuel crops will increase as producers switch to corn and wheat replaces corn for livestock feeding (Elobeid et al., 2006). At the same time, incentives for carbon sequestration may promote practices that store soil organic matter (Lewandowski et al., 2004), and demand for value-added products, especially certified organic foods, continues to encourage transition to alternative practices (Dimitri and Oberholtzer, 2006). Farming systems that address these trends will become increasingly prevalent in the Western High Plains. Producers need sound, region-specific information on transition to alternative systems.

Farming systems are at the intersection of economics, the social sciences, and biology (Spedding, 1996). Meaningful research in integrated systems must be broadly collaborative, long-term, and driven by the problems and questions of producers (Ikerd, 1993; Mueller et al., 2002). This paper describes the Farming Systems Project at the University of Wyoming James C. Hageman Sustainable Agriculture Research and Extension Center (SAREC).

### Methodology

A team of Wyoming producers, researchers, and extension educators assembled in early 2007 to investigate implications of transition to alternative approaches. The long-term objective is to track agronomic, environmental, and economic differences among conventional, reduced-input, and organic approaches. The team includes faculty researchers in cropping systems, agricultural economics, soil science, hydrology, entomology, plant pathology, animal science, and weed science, and progressive farmers practicing all three approaches. During meetings in winter and spring, the team planned systems research that integrates multiple short- and long-term objectives via side-by-side conventional, reduced-input, and organic crop-forage-livestock operations. The goal is to develop and analyze farming systems specific to the northern part of the Western High Plains Ecoregion (US Environmental Protection Agency, 2007) in a scientifically sound framework.

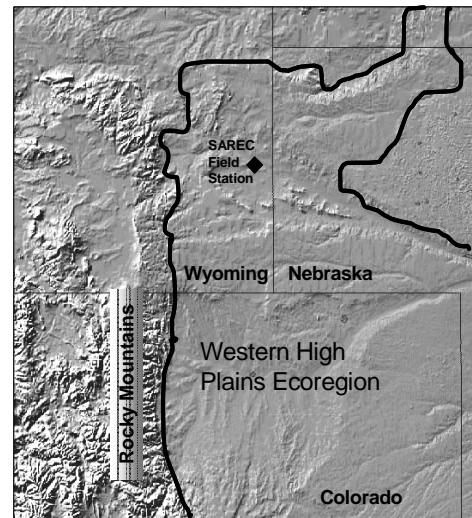
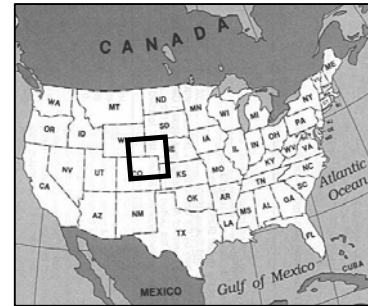

Figure 1: Location of study area.

High elevations in this region (1200 to 1500 meters above sea level) cause cool temperatures and short growing seasons. The average frost-free period is about 125 days and average annual precipitation is 300 to 400 mm. Over 75 percent of precipitation comes during the growing season from thunderstorms that can be extremely heavy. Strong winds in winter and spring dry out soils and can damage crops. Soils are typically deep loams with native soil organic matter content of about one percent, but 60 percent has been lost from farmlands due to cultivation over the last 100 years (Aguilar et al., 1988). The majority of agricultural production is dryland winter wheat-fallow rotation systems. Beef cattle production is important near native rangelands. Irrigation is generally limited to flood plains of tributaries to the Platte River and is used mostly for winter livestock feed.

The SAREC farm was established in 2001 for discovery, dissemination, and dialogue of integrated agricultural systems. The farm is in Goshen County, Wyoming, on 1570 ha, with 154 ha irrigated croplands, 617 ha unirrigated croplands, and 775 ha native rangelands. Facilities include a beef herd with feeding facilities, laboratory and dormitory facilities, and equipment for field experiments.

The Farming Systems Project will occupy 170 ha for assessing conventional, reduced-input, and organic approaches toward integrated dryland crop, irrigated crop, and livestock production. Each of the three approaches will occupy six ha of range, dry crop, and irrigated land randomly located in three replication clusters. Half of each six-ha plot will be long-term baseline operation, with annual crops, perennial forages, and pasture under the conventional, reduced-input, or organic approach. The other half of each plot is for shorter-term evaluation of variations to base systems.

### Results

The project provides a framework for multidisciplinary problem-solving among producers, educators, and researchers. Involving producers ensures short-term changes in knowledge, skills, and attitudes and medium-term incorporation of that knowledge into on-farm decisions.

Team building has fostered cross-discipline collaboration on a proposal to the US Dep. of Agriculture Western Region Sustainable Agriculture Research and Education Program. New channels of communication are yielding improved understandings. For instance, research team producers interested in organic production say they need information on how to economically survive the three-year transition period while building soil organic matter to improve yields without synthetic fertilizer. This issue is not currently being addressed for the Western High Plains region.

### Conclusions

The high, cold, and dry climate makes farming precarious in the Western High Plains of the United States. Conventional farms with low yields depend on large scale to sustain profits in wheat-fallow, irrigated crops, and range livestock systems. Producers want to increase value and reduce costs, but transition to organic, or reduced-input systems involves uncertainties about short- and long-term sustainability. The Farming Systems Project was initiated for long-term evaluation of strategies for transition and operation of sustainable farming systems.

### References

- R. Aguilar et al., Effects of cultivation of soils in northern Great Plains rangeland, 1988. *Soil Sci. Soc. Am. J.* 52,1081-1085.
- C. Dimitri and L. Oberholtzer, EU and U.S. organic markets face strong demand under different policies, 2006. *Amber Waves* 4, 12-19.
- A. Elobeid et al., The long-run impact of corn-based ethanol on the grain, oilseed, and livestock sectors: A preliminary assessment, 2006. CARD Briefing Paper 06-BP 49. [www.card.iastate.edu](http://www.card.iastate.edu).
- J.E. Ikerd, The need for a system approach to sustainable agriculture, 1993. *Agric., Ecosys., and Env.* 46, 147-160.
- J. Lewandowski et al., Economics of sequestering carbon in the U.S. agricultural sector, 2004. TB-1909, USDA/ERS, April 2004.
- J.P. Mueller et al., Development and implementation of a long-term agricultural systems study: Challenges and opportunities, 2002. *Hort Tech.* 12, 362-368.
- C.R.W. Spedding, *Agriculture and the citizen*, 1996. Chapman Hall, New York.
- US Environmental Protection Agency, US Ecoregions, 2007. <http://www.epa.gov/wed/pages/ecoregions.htm>.

## BIOGAS: PARTICIPATION, GOVERNANCE AND RELATIONAL MARKETING

Iseppi<sup>1</sup> L., Chang Ting Fa<sup>1</sup> M., Sortino A.<sup>1</sup>, Piccinini L.C. <sup>2</sup>, Cudin M.<sup>1</sup>

<sup>1</sup> Dip. di Biologia e Economia Agro-industriale, University of Udine, Italy, [luca.iseppi@uniud.it](mailto:luca.iseppi@uniud.it), [chang@uniud.it](mailto:chang@uniud.it), [antonio.sortino@uniud.it](mailto:antonio.sortino@uniud.it), [cudin@uniud.it](mailto:cudin@uniud.it)

<sup>2</sup> Dip. di Ingegneria Civile, University of Udine, [piccinini@uniud.it](mailto:piccinini@uniud.it)

### Introduction

Intensive breeding by pursuing unconditionally productive objectives causes relevant negative externalities. It is necessary to introduce physical fixed capital (plants for biogas production) and immaterial capital (nets of knowledge/skills). These inputs of capital are necessary to limit in some way the persistent erosion of natural capital and to transform the negative externalities into a resource. This contribution aims in the first part to choose within the Italian context the most remarkable territorial realities of animal biomass production. We then calculate the production barycenters of animal biomasses in order to determine the optimal position of biogas production plants, purification and the re-utilization of waters and their relative induct (e.g. physical capital for the connection to the energetic network). The introduction of such plants in the barycenters and the relative nets of energetic connection on the territory can be considered from the local community as an inadmissible imposition. In the second part, our contribution will deal with the theoretical analysis of the most innovative instruments. This can allow for the implementation of the procedures for the adaptation of the exogenous element (biogas plant) to the “local feeling” through the creation of immaterial capital (social and relational capital).

### Methodology

The ISTAT *dataset* which is used here *is that of* livestock at the level of Italian municipalities. Based on this, the productions of animal biomasses and the relative nitrogen contents have been calculated for the seven types of livestock for every municipality of the statistical universe. The concentration and asymmetry indexes (Del Vecchio) have also been calculated. To allow for the most remarkable territorial realities to emerge (in terms of animal biomass production), we have used a portable innovative model which is based on vertical, horizontal and weighted matrixes and on subsequent *cluster analysis*. Such a model has already been tested on the 8,082 Italian municipalities as for the use of the soil among the principal agricultural productions (Iseppi).

In order to get a fuzzy division of the territory and to locate plants we use Lloyd's algorithm which is based on Voronoi diagrams applied to a centroid system. It is called the Voronoi diagram of a collection of points a partition of the region in polygons, each of which contains one particular point and the part of the region that is nearest to it. The edges of every polygon are half-way between a couple of fixed points.

Lloyd's algorithm (iterative) proceeds for successive approximations. At first, we settle in an arbitrary manner N centres (generally-speaking, they will not be the final solution). The regions of influence are calculated through the Voronoi diagram. At this point, the regions' centroids are calculated. These centroids are now chosen as the new system of the service centres. The regions of influence then are once again calculated and so on. After some iterations the procedure stabilizes and does not any longer introduce meaningful changes (i.e. tends to a limit). This means that we have found a solution to the problem of the optimal location for the services' system.

Unlike other optimization problems there can be more than one solution depending on the first approximating selection. That means that maxima are “local”. It therefore needs to verify which solution is the best one.

The simplest case is that of the rectangular region with two service centres and with a uniformly distributed population. The two (locally) optimal solutions are the following but the right one is better than the left one (Fig. 1):

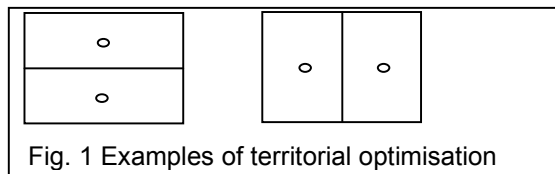

Fig. 1 Examples of territorial optimisation

The theoretical analysis of the innovative tools for the creation of immaterial capital which is essential for biogas plants introduction and social acceptance, concerns: a) the scientific approach deriving from the

models of participative economy for the recognition of the nets of knowledge/skills (Albert); b) the instruments of relational marketing with the purpose of experimentally identifying the dynamics of creation of such nets (Grandinetti). The required methodology which is used for objectivity quantification of the relational nets has been found in the textual qualitative analysis which allows for the creation of some conceptual maps through bayesian nets. Its application within this context is new. This methodology allows us to utilize hardly measurable quantities (Rabino, Scarlatti). The value is in fact constituted not only by physical elements but also by meanings and relationships; hence, the connection with *relational marketing*.

## Results

The concrete utility of our results consists first of all in the creation of support for the choice of landscape public politics with particular reference to animal biogas production. We also aim to create a strong theoretical framework that should find a coherent operational application. The activation of transformation processes of the negative intensive breeding externalities into sustainable resource will be our benchmark.

## Conclusions

In the future, the installation of biogas plants could cause a strong resistance within the local community also in Italy. It is for this reason, together with the necessary determination of the optimal position of the plants themselves, that one needs to implement adaptation procedures so that these exogenous elements may respect the “local feeling.” Using also the techniques supplied by relational marketing, once a confidence atmosphere among actors is established/created, the investment in human capital will produce multiplying effects which will form new human capital (self production, regeneration and development) according to *bottom- to-up* dynamics. In such a way, the individual demand of the global exogenous element which consists in new plants for the production of biogas, remediation of residues and for the purification and the recycling of water, could become representative of a collective demand. The governance could thus be involved in bringing it further ahead.

## References

- Albert M. (2003), *L'Economia Partecipativa*, Datanews Editrice, Roma.  
 Del Vecchio F. (1986), *Statistica per la ricerca sociale*, Cacucci Editore, Bari.  
 Grandinetti R. (1993), *Reti di marketing. Dal marketing delle merci al marketing delle relazioni*, Etas Libri, Milano.  
 Iseppi L. (2007), *L'uso del suolo aziendale agricolo nei comuni italiani*, Udine.  
 Rabino G., Scarlatti F. (2004), *Statistiche testuali, mappe concettuali, reti bayesiane: due applicazioni nell'ambito della valutazione del paesaggio*, VII Convegno nazionale della A.I.V., Milano 25-27 marzo 2004.

## BIOLOGICAL AND PRODUCTIVE RESPONSE TO DIFFERENT WATER REGIMES IN SUNFLOWER (*HELIANTHUS ANNUUS* L.) UNDER MEDITERRANEAN CLIMATE CONDITIONS

O. Sortino<sup>1</sup>, S.A. Raccuia<sup>2</sup>, M.G. Melilli<sup>2</sup>, G. Terranova<sup>1</sup>

<sup>1</sup> DACPA – Scienze Agronomiche, Università degli Studi di Catania, Italy, e mail: o.sortino@unict.it

<sup>2</sup> ISAFOM, U.O.S. Catania, Consiglio Nazionale delle Ricerche, Italy, e mail: s.raccuia@isafom.cnr.it

### Introduction

The interest in many vegetable oils as diesel fuel substitutes is increasing and various oil containing crops are grown for this purpose. Sunflower (*Helianthus Annuus* L.) is an oilseed crop cultivated mainly for the production of alimentary oil. It has also been considered as an important crop for biodiesel production, particularly in southern European countries (Kallivroussis et al., 2002). In the view of obtaining bio-energy to support both sustainability and development, it is necessary to study agronomical techniques able to maximize yields with low input managements. In Mediterranean regions irrigation is the only means of producing both high and stable crop yields. Due to the limited water resources in this region, determination of the crop water requirements is nowadays a needed condition to maintain efficient irrigated agriculture. Deficit irrigation occurrence while maintaining acceptable yield represents a useful trait for sunflower production wherever water is limited.

### Methodology

Aiming at evaluate the biological and productive response to different levels of water regimes an open field experiment was conducted in Pozzallo, South Sicily. The experiment was set as split plot design, using two sunflower varieties ('Euroflor' and 'Isoleic') and four irrigation treatments (0%, 33%, 66% and 100% of ET<sub>m</sub>, referred as T<sub>0</sub>, T<sub>33</sub>, T<sub>66</sub>, and T<sub>100</sub> respectively). The sunflower was sown in May 04, using 6 plants m<sup>2</sup>. During the crop cycle, for each genotype and water regime, weekly from June 25, for a total of 7 sampling, were recorded plant height, total leaves number, leaf area and head diameter. Moreover at harvest, plant dry matter and its partitioning, grain yield (t ha<sup>-1</sup>) were determined. The total water supply were 25 (T<sub>0</sub>), 141 (T<sub>33</sub>) 257 (T<sub>66</sub>) and 373 mm (T<sub>100</sub>). The sum of rains recorded daily by a weather station during all the trial was 36 mm. Harvest index (HI) was calculated as the ratio of seed yield at dry basis to total aboveground dry biomass (Soriano et al., 2004). Water use efficiency (WUE) at seed basis was calculated as the ratio of seed yield (in kg m<sup>-2</sup>) to evapotranspiration (in m<sup>3</sup>) (Flenêt et al., 1996).

### Results

Highly significant mean squares for genotypic differences were found in the combined analysis of variance for plant height, leaves number/plant and head diameter. the irrigation factor affected for 72% the plant height, while the number of leaves and the head diameter resulted affected by the growth stage. The 'genotype' effect resulted always highly significant ( $P \leq 0.001$ ) (Tab. 1), and the two varieties responded differently to changes in irrigation conditions over the growing cycle (Fig. 1).

Table 1 Analyses of variance of plant growth characteristics and partitioning of the treatment mean squares (MS expressed in absolute value – AV – and percent of total) into main effects and interactions.

Traits	Source of variation													
	Growth Stage (S)		Irrigation (I)		Genotype (G)		S*I		S*G		I*G		S*I*G	
	AV	%	AV	%	AV	%	AV	%	AV	%	AV	%	AV	%
Plant height (cm)	1841 ***	20	6619 ***	72	265 ***	2.9	31 ***	0.34	80 ***	0.9	311 ***	3.4	7.0 **	0.08
Leaf number (n./plant)	30 ***	51	15 ***	25	3.8 ***	6.5	0.23 ns	0.39	0.03 ns	0.05	10 ***	16	0.36 **	0.61
Head diameter (cm)	286 ***	58	110 ***	22	55 ***	11	2.00 ***	0.41	34 ***	7.0	4.4 ***	0.89	0.33 ***	0.07

\*\* Significant at 0.01 probability level; \*\*\* Significant at 0.001 probability level; NS not significant

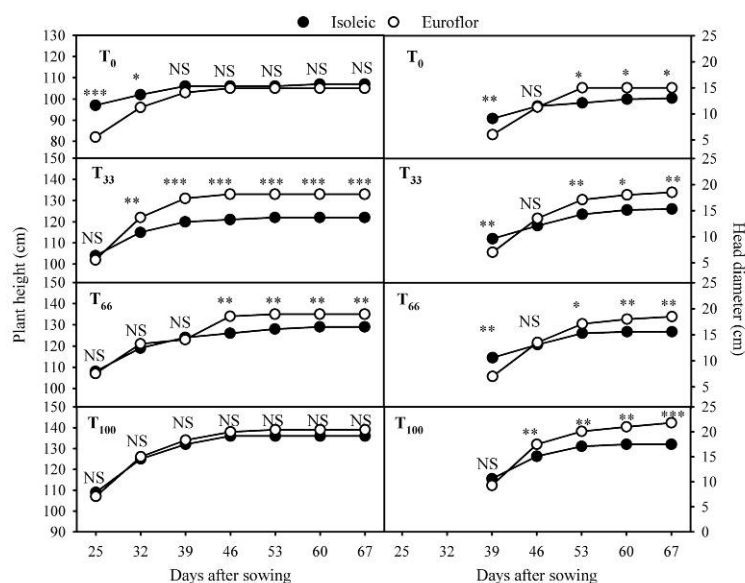

Fig. 1 - Plant height and head diameter (cm), recorded in the two genotypes at different moments of biological cycle. \*\*\* Significant at 0.001 probability level \*\* Significant at 0.01 probability level; \* Significant at 0.05 probability level; NS not significant

Average across genotypes, seed yield at dry basis (9% humidity) was  $4.5 \text{ t ha}^{-1}$  on the well-irrigated treatment. Deficit irrigation reduced seed yield by 57%, 33% and 15%, respectively at  $T_0$ ,  $T_{33}$  and  $T_{66}$ , compared to the control. Deficit irrigation does not seem to induce significant changes ( $P < 0.05$ ) in harvest index (HI) among treatments, and its range of variation of was between 0.31 and 0.33. Water use efficiency (WUE), was on average  $0.14 \text{ kg m}^{-3}$  and according to Goksoy et al. (2004) WUE did not significantly change when irrigation amount increased. The variety 'Euroflor' resulted the most productive on average of the water treatments (Tab. 2).

Table 2 Yields, harvest index (HI) and Water Use Efficiency (WUE) of the two genotypes. In the row means different letters between the genotypes indicate significative differences at  $P \leq 0.05$

ETm	Total biomass ( $\text{t ha}^{-1}$ )			Seed yield ( $\text{t ha}^{-1}$ )			HI			WUE ( $\text{Kg m}^{-3}$ )		
	Isoleic	Euroflor	Mean	Isoleic	Euroflor	Mean	Isoleic	Euroflor	Mean	Isoleic	Euroflor	Mean
$T_0$	6.3	6.0	6.14	1.99	1.90	1.94	0.32	0.31	0.32	0.15	0.13	0.14
$T_{33}$	8.4	10.4	9.38	2.70	3.35	3.02	0.30	0.32	0.31	0.14	0.17	0.15
$T_{66}$	10.9	12.3	11.60	3.66	4.05	3.86	0.34	0.33	0.33	0.13	0.14	0.14
$T_{100}$	12.2	16.0	14.11	3.88	5.17	4.52	0.32	0.32	0.32	0.11	0.14	0.13
Means	9.5 b	11.2 a	10.32	3.1 b	3.6 a	3.3	0.32	0.32	0.32	0.13	0.15	0.14
LSD <sub>0.05</sub>	2.8**	3.3***	2.6***	1.02**	1.08***	0.96***	NS	0.01*	NS	NS	NS	NS

\*\*\* Significant at 0.001 probability level \*\* Significant at 0.01 probability level; \* Significant at 0.05 probability level; NS not significant

## Conclusions

Differences were observed for the biological behaviour. In particular, 'Isoleic' variety gave the highest grain yield increment passing from  $T_0$  to  $T_{33}$ ; the variation from  $T_{33}$  to  $T_{66}$  and from  $T_{66}$  to  $T_{100}$  as well, resulted lower step by step. The "Euroflor" instead gave the highest peak at  $T_{33}$  and then constant increments passing from  $T_{33}$  to  $T_{100}$ . Deficit irrigation did not have a declining effects on HI, averaged for genotypes, is in agreement with Fereres (1984) and Amir and Sinclair (1991) who showed that HI is a constant fraction of the aboveground biomass over a range of water deficits.

## References

- J. Amir, et al., A model of water limitation on spring wheat growth and yield, 1991. *Field Crops Res.* 28, 59-69
- E. Fereres, Variability in adaptive mechanisms to water deficits in annual and perennial crop plants, 1984 *Bull. Soc. Bot. de France. Actualités Botaniques* 131, 17-32
- F. Flenè, et al., Sunflower response to a range of soil water contents, 1996. *Eur. J. Agron.* 5, 161-167
- A.T. Goksoy, et al., Responses of sunflower (*Helianthus annuus* L.) to full and limited irrigation at different growth stages, 2004. *Field Crops Res.* 87, 167-178.
- L. Kallivroussis; et al., The Energy Balance of Sunflower Production for Biodiesel in Greece, 2002. *Biosystems Engineering* 81 (3), 347-354
- M.A. Soriano, et al., Efficiency of water use of early plantings of sunflower, 2004. *Eur. J. Agron.* 21, 465-476

## WEB BASED AND DATABASE DRIVEN BIOMASS PLANNING TOOL

E.N.J. van Ouwerkerk<sup>1</sup>, R.P. Anex<sup>2</sup>, and T.L. Richard<sup>3</sup>

<sup>1</sup> Dept. of Agricultural and Biosystems Engineering, Iowa State University, USA, [evo@isu.edu](mailto:evo@isu.edu)

<sup>2</sup> Dept. of Agricultural and Biosystems Engineering and Mechanical Engineering,  
Iowa State University, USA, [rpanex@isu.edu](mailto:rpanex@isu.edu)

<sup>3</sup> Dept. of Agricultural and Biological Engineering, Penn State University, USA, [trichard@psu.edu](mailto:trichard@psu.edu)

### Introduction

In the US, a portion of gasoline for transportation has been replaced by corn-ethanol. Corn grain, however, is a major product in the food chain, and increased demand has driven up grain prices and thus meat and dairy costs. Currently research is focused on using alternatives, such as crop residues and grasses, as feedstocks for ethanol generation. As farmers are asked to contribute biomass feedstocks to lignocellulosic bio-refineries, they want to know the advantages and disadvantages relative to their current operations. The farmer needs to know the costs associated with those crops, as well as the anticipated yield of his property. Costs of equipment such as single pass corn stover harvesters and associated labor costs are incorporated in I-FARM, a decision-support tool developed by Iowa State University. The web-based and database driven tool includes crop and livestock production, economic and environmental modules, and a user-friendly GIS-feature to identify individual fields. Using aerial images, a user can select a specific field. Utilizing soil and topographic databases, the tool gives estimates for erosion, carbon sequestration, nutrient balances, required labor, energy consumption, costs, government payments, and expected revenues. This paper presents region-based scenarios for corn stover, wheat straw and switch grass harvest on marginal or conservation lands, including farm level and regional socio-economic impacts. The URL of I-FARM is <http://i-farmtools.org>.

### Methodology

In this paper we simulate the potential lignocellulosic biomass production in Iowa regions and its economic and environmental implications at the farm level. Five counties, in four corners and in the center of the state (Figure 1), are selected to get an impression of the regional differences in farming challenges. Table 1 shows the farm and crop land area and specific hill slope class distribution per county and land enrolled in the Conservation Reserve Program (CRP).

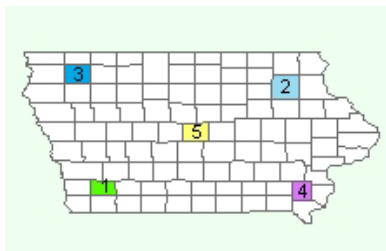

**Figure 1** Five selected Iowa Counties

**Table 1** Iowa land area per region and hill slope distribution

Region	County	Farm land area (ha)	Crop land area (ha)	Farm land area (%) per slope class (%)			Land in CRP (%)
				0-2	2-8	>8	
1	SW Montgomery	98.170	86.270	15,8	54,1	30,1	6,6
2	NE Fayette	167.880	146.560	34,2	47,9	17,9	6,7
3	NW O'Brien	146.650	127.690	67,8	29,9	2,3	1,2
4	SE Henry	101.680	83.250	41,1	41,2	17,7	11,5
5	C Story	145.520	124.560	65,7	30,8	3,5	1,9

Six scenarios of farms in each county are compared. Each farm has three productive fields (total land area 400 ha) plus some less productive land enrolled in CRP. The size of the fields and CRP land is according to the slope class distribution and average CRP percentage in each county.

Scenario 1 is representing a conventional, fully plowed grain farm, growing corn and soybeans.

Scenario 2 is the same as scenario 1, but no-till practices are adapted to reduce soil erosion and increase carbon sequestration.

Scenario 3 is the same as scenario 2, but pigs are produced, although the number of pigs is limited to avoid phosphorus excess in manure applied fields.

Scenario 4 is the same as scenario 2, but here corn residue on fields 1 and 2 is collected and baled for feedstock supply of a lignocellulosic bio-refinery.

Scenario 5 is the same as scenario 4, but an experimental single pass corn and corn stover harvest method is used to avoid soil contamination of the corn stover and to reduce labor requirement in the harvest time window.

Scenario 6 is the same as scenario 4, but the high slope field is larger because the farmer's CRP contract expired and land was brought back into production; his total 'steep hill slope land' is now divided into two equal size fields, where the less steep hill slope is farmed in a two-year crop rotation winter wheat/soybeans and the steep hill slope planted with switch grass, a perennial, to



avoid excessive soil erosion. Fifty percent of the land is rented, 25% is owned and free of mortgage, and 25% is owned with a mortgage. All machines and buildings are purchased on bank loans. The farmer hires temporary workers during harvest. We assume 60% residue removal for all biomass baling options and 95% for experimental single pass harvest. Dry matter losses during on-farm biomass storage are included in the simulations. Biomass sales price: \$ 55.10 per metric dry ton at the farm gate.

**Results**

Thirty simulation runs were executed with I-FARM. Table 2 shows the simulated regionally distributed net farm income per labor hour. Results show that the more sustainable farming practices increase farm income per labor hour in most cases, because of elimination of capital, labor, and energy intensive tillage. For scenarios 2 through 6 no soil erosion losses are expected beyond the tolerable soil loss (T-value) and the Soil Conditioning Index is positive.

Although the total annual income is high, under current market price conditions pig production is not as economic as non-integrated crop production when comparing revenues per worked hour. This is also true for the labor intensive scenario 6, where CRP government payment is lost. Therefore we only compare the potential biomass production for scenarios 4 through 6 (Table 3) and the labor, energy, and nutrient requirements for scenarios 2, 4, and 5 (Table 4).

Average biomasses supply at the farm gate of 3.3 metric dry tons/ha can be reached, using traditional harvest, baling, and storage. An increase of 34% can be accomplished when all available land is used for biomass production. When an experimental single pass corn stover harvest method and better storage methods are adopted an increase in biomass supply of 80% is possible.

With traditional biomass collection 60% more labor is required, which may be unavailable during harvest when labor demand is at its peak. The experimental single pass harvest method (only 25% extra labor) appears likely to both increase harvest speed and dramatically reduce energy requirements.

Removal of nutrients in harvested residues and perennials must be compensated by additional fertilization. Table 4 shows the simulated numbers.

Nitrogen fertilizer application should be increase by 42%

and 67% for 60% corn residue removal (bales) and 95% corn residue removal (single pass), respectively. The extra phosphorus required is smaller. A dramatic increase for potassium is computed, because of the high K-component in foliage residues and perennial grasses. Potassium fertilizer increases are likely to be 143% and 225% for bales and single pass harvest respectively.

**Conclusions**

I-FARM is a free accessible web-based software package that allows users to plan and evaluate biomass harvest opportunities in the Northern and Northeastern United States. Scenario studies executed with I-FARM show that special attention should be paid to erosion control and nutrient loss compensation. Improvement of biomass harvest techniques is required to make biomass intensive farming more viable.

**Table 2** Simulated regionally distributed net farm income per labor hour

Farm scenario	Simulated regionally distributed net farm income (\$ per labor hour)				
	SW	NE	NW	SE	C
1 conventional grain	163	181	121	122	176
2 more sustainable grain	208	198	136	167	219
3 sustainable grain + pigs	123	128	107	108	145
4 sustainable grain + biomass (corn stover, bales)	157	163	114	141	178
5 sust. grain + biomass (stover, single pass harvest)	204	206	150	168	244
6 sust. grain + biomass (stover, straw, switchgrass)	118	136	100	101	156

**Table 3** Simulated regionally distributed potential biomass supply at the farm gate after 6 months of on-farm storage (metric dry tons/ha)

Scenario	SW	NE	NW	SE	C	State avg.
4	2,3	3,1	3,9	2,7	4,5	3,3
5	4,1	5,5	7,0	4,9	8,0	5,9
6	4,7	4,3	4,1	4,1	4,8	4,4

**Table 4** Simulated regionally distributed labor, energy, and nutrient demand

	Scenario	SW	NE	NW	SE	C	State avg.
<b>Labor</b> (h/ha)	2	1,9	1,9	2,1	1,8	2,1	2,0
	4	2,7	2,9	3,5	2,9	3,5	3,1
	5	2,3	2,4	2,7	2,3	2,6	2,4
<b>Energy</b> (diesel, l/ha)	2	34	36	41	35	41	37
	4	38	41	49	40	49	44
	5	76	93	127	93	124	103
<b>N</b> fertilizer (kg/ha)	2	96	113	138	102	157	121
	4	128	158	200	146	230	172
	5	148	185	237	170	272	202
<b>P<sub>2</sub>O<sub>5</sub></b> fertilizer (kg/ha)	2	26	28	27	24	31	27
	4	32	36	37	31	42	36
	5	35	40	43	35	49	40
<b>K<sub>2</sub>O</b> fertilizer (kg/ha)	2	41	40	36	35	41	39
	4	79	92	101	81	116	94
	5	101	122	139	107	159	126

## Session 2.2: Agricultural management in future studies

Session Convenors:  
Mark Howden, Claudio Stockle and Jeffrey White

## AGRICULTURE DEVELOPMENT AND MANAGEMENT BY KNOWLEDGE AND ADVANCED TECHNOLOGY

Ch. Alekperov

Dep. of Plant Sciences, Tel Aviv University, Israel, [chingiza@post.tau.ac.il](mailto:chingiza@post.tau.ac.il)

### Introduction

Development of agriculture production in countries with the low level of education and knowledge make big problems. Our experience shown, that a most of the farmers in the world not have familiarity with hi-tech methods in agriculture. Education of the agriculture experts in Israel from different countries confirm our assumptions, that most farmers and agronomists not familiarity with drip irrigation, fertigation, net house crop production and others resources.

What will do? Make wide ways for the transferring agronomic knowledge and advanced technology to agriculture are managers.

### Methodology

A systems approach has been taken to a review of agricultural education programs and as the essential theme of resultant curricula at different international courses in Israel. The systems thinking and practices which have guided, and been shaped by, the innovations are outlined, and the rationale and framework of the major program are described. The subsequent emphasis has been placed on effective learning for agricultural managers and their technologist advisors. It is argued that problem solving and learning are essentially the same psychological processes and that taking a systems approach to investigating problem situations provides a more useful paradigm for learning about agriculture, discipline-based approaches.

### Agronomic Knowledge Transferring (AKT) Scheme

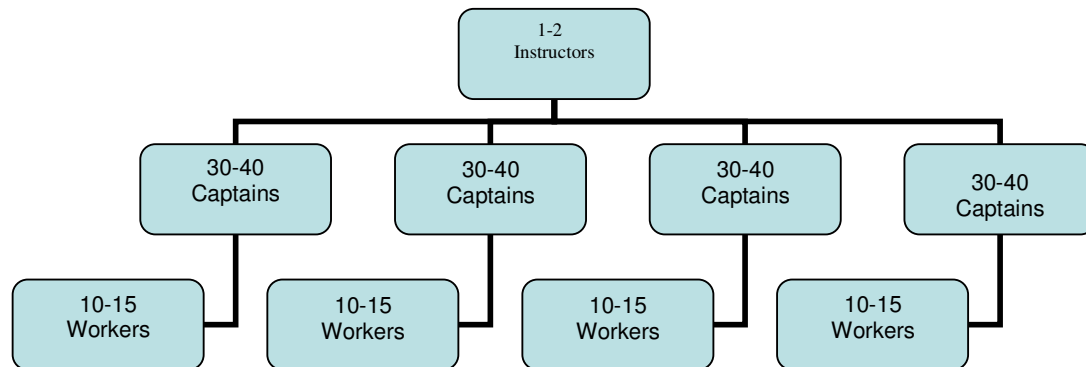

Experiential learning and autonomy in learning are seen as consistent with this and are basic features of the programmes (Bawden, 1984). A conceptual framework for problem solving that incorporates soft and hard systems and scientific reductionist methodologies has been developed. A contingency approach to situation improving is emerging as a less restrictive and more realistic alternative to a normative approach to problem solving (soil, specific crops, irrigation and drip irrigation, fertigation, manure fertilization - compost) (Bationo, 1991).

**Results**

Our experience in West Africa, China and Azerbaijan gave result on short time 1-3 months. In one farm were educated 30-40 captains and farther every one captain teach 10-15 workers (operators). Use this method of ATK can solving problems of hunger in East Africa (Sivakumar , 1988)and other places of the World.

**Conclusions**

Research and observation of references show as introduce ATK to every farmer family in underdeveloped countries; will increased income and prosperity for the all community.

**References**

Bawden, Richard J., R.D. Macadam, R.J. Packham, and I. Valentine. <sup>22</sup>Systems Thinking and Practices in the Education of Agriculturalists. <sup>23</sup>*Agricultural Systems* 13 (1984): 205–225.

Bationo, André, and A.U. Mokwunye. <sup>24</sup>Role of Manures and Crop Residue in Alleviating Soil Fertility Constraints to Crop Production: With Special Reference to the Sahelian and Sudanian Zones of West-Africa. <sup>25</sup>*Fertilizer Research* 29 (1991): 117–25.

Sivakumar, M.V.K. <sup>26</sup>Predicting Rainy Season Potential from the Onset of Rains in Southern Sahelian and Sudanian Climatic Zones of West Africa. <sup>27</sup>*Agricultural and Forest Meteorology* 42 (1988): 295–305.

## USING SIMULATION AND ON-FARM PARTICIPATORY RESEARCH TO DEVELOP AND SCALE OUT TARGETED RECOMMENDATIONS FOR SMALLHOLDER FARMING SYSTEMS IN SOUTHERN AFRICA

<sup>1</sup>A. Whitbread, <sup>2</sup>M. Robertson, <sup>3</sup>P. Wall, <sup>4</sup>K. Ayisi, <sup>5</sup>J.J.O. Odhiambo, <sup>6</sup>J. Hargreaves

<sup>1</sup> CSIRO Sustainable Ecosystems, PMB2 Glen Osmond 5064, Australia, anthony.whitbread@csiro.au

<sup>2</sup> CSIRO Sustainable Ecosystems, Perth, Australia, michael.robertson@csiro.au

<sup>3</sup> CIMMYT, Mazowe Road Harare, Zimbabwe, p.wall@cgiar.org

<sup>4</sup> AGES, Polokwane, South Africa, kayisi@ages-group.com

<sup>5</sup> University of Venda for Science and Technology, Thohoyandou, South Africa, odhiambo@univen.ac.za

<sup>6</sup> CSIRO Sustainable Ecosystems, APSRU Toowoomba, Australia, john.hargreaves@csiro.au

### Introduction

In southern Africa the production of food is hindered by infertile soil, poor agronomy, labour constraints and high climatic variability. Identifying agro-ecosystems and niches within farming systems where interventions can contribute to overall farm productivity is critical to adoption. Two examples are discussed from southern Africa where farmer participatory research and simulation modelling were used to develop recommendations for farmers and policy makers.

### Methodology

The first example, "the risk management project", focussed on experimentation with various legume/fertiliser practices to restore soil fertility in highly resource-constrained smallholder farmer systems in Malawi and Zimbabwe. Practices assessed included; the response of maize to low N-fertiliser application rates; cash crop (soybeans, cowpea) or green manure (mucuna, pigeon pea) legumes in rotation with maize. These various practices were tested with farmers in an extensive on-farm experimental program, and the riskiness of the interventions were explored using simulation modelling. In the second example from Limpopo Province in the northern part of South Africa, the transition of subsistence farmers into commercial farmers is currently a major thrust of government policy. These policies often have unrealistic expectations of the potential agricultural production. The 'emerging farmer project' uses simulation and on-farm experimentation to demonstrate potential production and risk and to identify strategies to improve productivity within the resource bounds of the farmers. In both examples, the farming systems model APSIM (Agricultural Production Systems sIMulator) (Keating et al. 2003) was used to simulate the soil-plant system. Long term, daily weather data was collated from meteorological stations in the regions and soil characterisation information was measured at the sites. Extensive interactions with local farmers were used to determine sensible inputs, management logic and scenarios to simulate for the various technologies being tested.

### Results

*The risk management project:* In a smallholder maize growing area close to Masvingo in Zimbabwe low application rates of fertilizer N to maize have been promoted to resource poor farmers by CIMMYT and ICRISAT. Field trials over several seasons and simulation were used to investigate the consequences of applying N in a range of situations that occur in the field. It was shown that poor weed control caused low nitrogen use efficiencies (NUE) with the best NUE obtained at higher planting densities, on deeper soils and good weed control (Fig 1a).

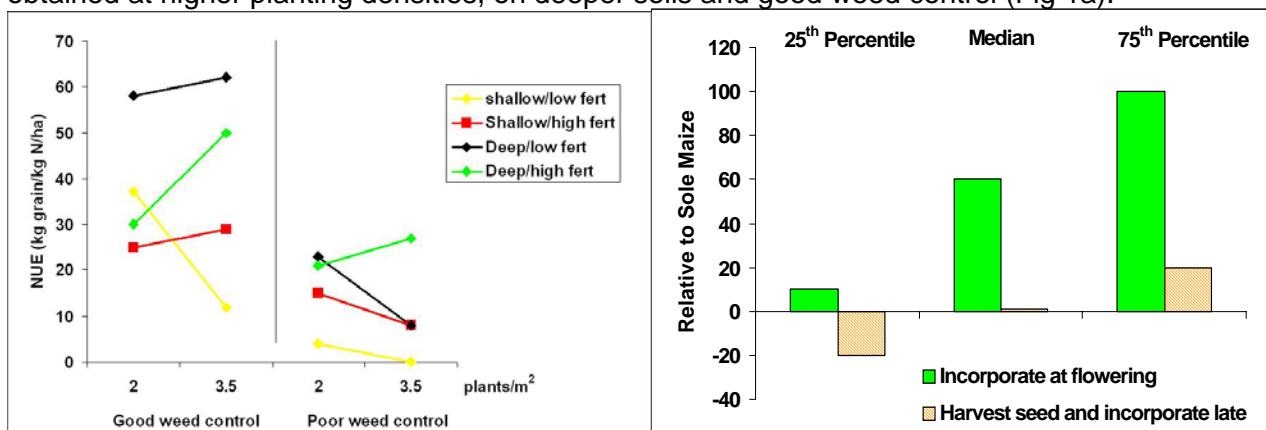

Figure 1a. Simulated nitrogen use efficiency (NUE) of fertilizer N at two densities of maize grown in shallow or deep soils with high and low 56 fertility and poor and good weed control.

Figure 1b. The simulated response of dryland maize grown after a mucuna green manure crop that is incorporated at flowering or after seed set

In a second example from Zimbabwe, *Mucuna pruriens* was evaluated as the most reliable green manure legume and its potential to improve maize growth in subsequent crops was investigated. The simulation analysis showed that significant responses in maize growth to mucuna in the previous season, relative to a maize-on-maize control, occurred only when the mucuna crop was incorporated at flowering (Fig 1b). Farmers found that this was an impractical system and were unlikely to adopt a system that required high labour input to capture the benefits. In the higher rainfall environment of Malawi, green manure systems were found to have a much higher reliability (data not presented).

*Emerging farmers project, Limpopo South Africa:* Government policies pre-1994 resulted in the large scale re-settling of black communities into homelands where the agricultural potential was often low. Low-input subsistence based farming activities developed around these communities and in most cases productivity has been low and declining. There is potential to greatly improve productivity, so simulation is being used to help develop policies and approaches to relevant to supporting resource poor farmers who are attempting to move to some form of commercial production. Two simulation studies are presented and both are the subject of on-going R,D and E.

1. How risky is the dryland production of the traditional staple maize compared with sorghum and cash-crop legumes? In Table 1, maize production at the driest and most infertile sites (Perkesbult and Bohlobela) was very poor with 58 and 28 % of crops failing. There was a large response to N at these sites (assuming no other nutrient limitations). Maize production at the other two sites was more reliable as a consequence of higher growing season rainfall and better soils. The production of cowpea and soybean was much less risky than maize at the two drier sites and this simulation outcome is supported by the majority of farmers at these sites who are now specialising in legume-based cropping systems.

Table 1. Mean (1963-2007) growing season rainfall (GSR) and grain production (kg/ha) of maize (O and 15 kg/ha of fertilizer N applied at sowing), cowpea and soybean using four sites representing a wide continuum of cropping soils and climate in the Limpopo Province.

	Perkesbult	Bohlobela	Mafarana	Dzwerani
GSR (mm)	370	487	583	629
Maize ON	184	399	1264	1312
Maize 15N	867	1101	1651	1616
Cowpea	899	651	301	567
Soybean	782	861	517	675

2. What is the response of maize and sorghum to N fertiliser? The maize responses to fertilizer N application (15, 30, 60 and 90 kg/ha of N) at sowing were also simulated at all sites (data not presented). At N application rates of 15 and 30 kg/ha, NUE ranged between 35 and 47 kg grain/kg N at Perkesbult and Bohlobela demonstrating a very large response to fertilizer N in these sands with virtually no mineral N coming from organic matter. NUE of application rates above 30 kg/ha of N were <26 kg grain/kg N. NUE at Mafarana and Dzwerani ranged from 15 to 30 kg grain/kg N at the lower N rates and from 9 to 20 kg grain/kg N at 60 and 90 kg/ha N. In response to this high rate of efficiency achieved at low rates of N, ICRISAT are promoting and researching this concept in the Province (JP Dimes pers comm).

### Conclusions

In the risk management project, combining on-farm testing of legume/fertiliser practices relevant to resource constrained smallholder farmer systems with simulation analysis resulted in a range of highly relevant extension material being developed and distributed. For the first time, extension material was able to include the element of climatic risk and decision trees were able to help an extension worker target the situations where the technology could be relevant. In Limpopo Province, simulation is helping to develop realistic estimates of crop production potential and provide guidance in the practices, varieties and species that minimize risk.

**Acknowledgements:** ACIAR provided financial assistance for the Risk Management (LWR2/2001/028) and the Emerging Farmer (LPS/2002/081) projects reported in this paper.

### References

B.A. Keating, et al. (2003) An overview of APSIM, a model designed for farming systems simulation. *Europ. J. Agronomy* 18, 267-288

## MANAGEMENT ZONES DELINEATION USING MULTIVARIATE GEOSTATISTICS

A.Castrignanò<sup>1</sup>, G.Cucci<sup>2</sup>, G. Buttafuoco<sup>3</sup>, G. Lacolla<sup>2</sup>, A.Troccoli<sup>4</sup>, S. Colecchia, V. Di Bitello, M.Pisante<sup>5</sup>, F.Basso<sup>6</sup>, G.Cafiero<sup>6</sup>, B.Basso<sup>\*6</sup>

<sup>1</sup> CRA-Istituto Agronomico Sperimentale, via Celso Ulpiani 5, 70125 Bari, ITALY

<sup>2</sup> Dipartimento Scienze delle Produzioni Vegetali, via Amendola 165/A, 70126 Bari (Italy)

<sup>3</sup> CNR-ISAFM, via Cavour 87030 Rende-Cosenza (Italy)

<sup>4</sup> CRA-Istituto Sperimentale per la Cerealicoltura (Foggia)

<sup>5</sup> Dip. Scienze degli Alimenti., University of Teramo, Mosciano S. Angelo (Italy)

<sup>6</sup> Dept. Crop, Forestry and Environmental Sciences, University of Basilicata, Potenza (Italy)

([bruno.basso@unibas.it](mailto:bruno.basso@unibas.it))

### Introduction

Optimum benefits on profitability and environment protection depend on how well land use and agricultural practices are fitted to variable soil conditions. Soil variability is the result of both natural processes and management practices, acting at different spatial and temporal scales, so it is critical to characterize soil with precision, both quantitatively and spatially (Castrignanò et al., 2000). Adequate techniques of data analysis are then necessary to put in evidence important spatial relationships and to identify those factors that control the variability of soil properties. Multivariate geostatistics uses the information coming from relationships among variables in order to subdivide an agricultural field into smaller, more homogeneous units, with respect to soil physical and chemical properties, as required by the application of site-specific techniques and more modern technologies. Some of the several possible factors that govern soil variations are likely to have a short-range action, whereas others operate at longer distances. As a consequence, soil variables are expected to be correlated in a way that is scale-dependent. The main objective of this paper is to study the scale-dependent correlation structure of some soil variables and then delineate the management zones within an agricultural field by the application of an approach that combines classical factor analysis with geostatistics.

### Methodology

The trial has been conducting on a 12-ha durum wheat field in the experimental farm located in Foggia (south-east Italy). The soil samples were taken up to 0.30-m depth at 100 georeferenced locations, so that they were evenly distributed on the field. In this paper the results of the following variables are reported: coarse, fine and very fine sand, silt, and clay proportions, organic matter content, total Nitrogen and Phosphate concentrations. The laboratory analyses were performed according to the standard methods by Italian Soil Science Society.

The multivariate spatial data set was analysed by cokriging and Factor Kriging Analysis ( FKA,) which is a geostatistical method developed by Matheron (1982). The three basic steps in FKA are the following:

- 1) modelling the coregionalization of the set of variables, using the so called Linear Model of Coregionalization (LMC);
- 2) analysing the correlation structure between the variables, by applying Principal Component Analysis (PCA);
- 3) cokriging specific factors at characteristic scales and mapping them.

### Results

All experimental simple and cross variograms were calculated by fitting a linear model of coregionalization including the nugget effect and two spatial structures: one spherical at short range (range=50 m) and the other one exponential at long range ( range=250 m). The application of cokriging allowed for the estimation of the study variables and then the production of the thematic maps of each individual soil parameter. The field could be roughly subdivided into two zones, the southern one characterised by finer texture and higher contents of N and organic matter. On the contrary the spatial distribution of P looked opposite. Moreover, the application of

factor kriging allowed for the identification of: 2 regionalised factors at shorter scale, which attribute scores to physical fertility (higher contents of clay, fig. 1) and chemical fertility (higher contents of organic matter, fig.2), respectively and a third factor at longer range mostly related to coarse sand content. These results are consistent with those obtained by a multivariate geostatistical analysis on the crop and radiometric variables (fig.3) according to which the southern part of the field showed greater LAI and higher yield.

The proposed approach has then led to delineate the field into contiguous zones with different physical and chemical properties to potentially apply site-specific management approach.

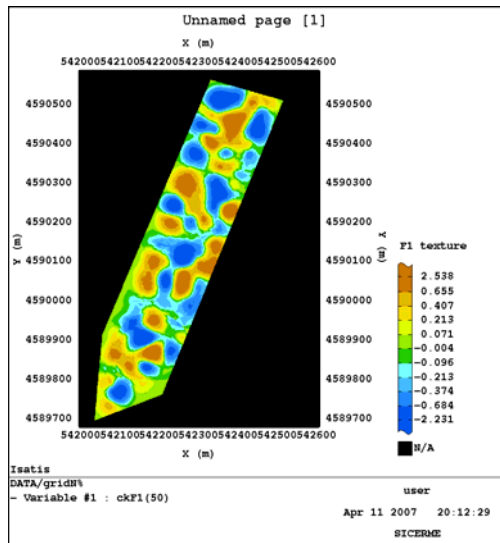

Fig.1 Kriged map of soil texture at short range

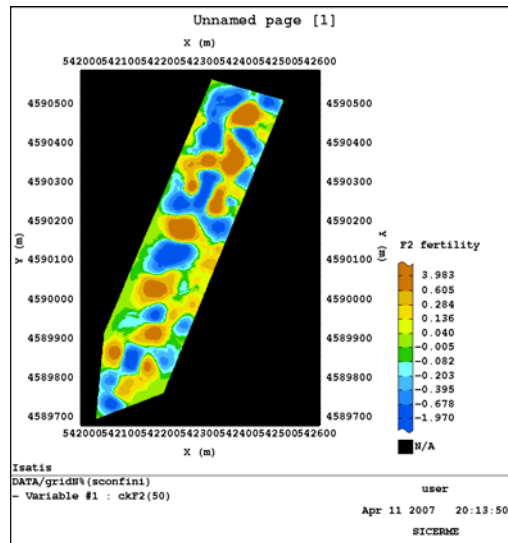

Fig. 2. Kriged map of fertility

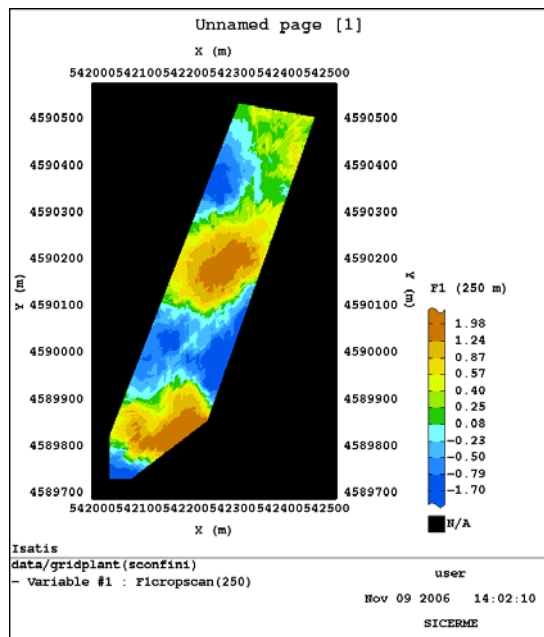

Fig. 3. Kriged map of co-regionalized long range factor

## References

Castrignanò, A., Giugliarini, L., Risaliti, R., Martinelli, N., 2000. Study of spatial relationships among some soil physico-chemical properties of a field in central Italy using multivariate geostatistics, *Geoderma* 97, 39-60.

Matheron, G., 1982. Pour une analyse krigéante des données régionalisées in Report 732. Centre de Geostatistique, Fontainebleau.



## EMPOWERING CROPPING SYSTEMS SIMULATIONS USING A RELATIONAL DATABASE

L. Bechini<sup>1</sup>, C.O. Stöckle<sup>2</sup>

<sup>1</sup> Dep. of Crop Science, University of Milano, Italy, [luca.bechini@unimi.it](mailto:luca.bechini@unimi.it)

<sup>2</sup> Dep. of Biological Systems Engineering, Washington State University, USA, [stockle@wsu.edu](mailto:stockle@wsu.edu)

### Introduction

Relational databases are powerful tools to manage large and complex data structures. In agricultural sciences, they can be used to store and analyze experimental data (van Evert et al., 1999) and are also potentially useful as a support to store inputs (e.g. Caldeira and Pinto, 1998) and outputs of simulation models. However, their integration with simulation models was explored only in limited cases. The objective of this paper is to show the results of the integration of a relational database management system (RDBMS) and CropSystVB, a cropping systems simulation model.

### Methodology

CropSystVB, a simplified version of the standard CropSyst model (Stöckle et al., 2003), is a management-oriented multi-year multi-crop simulation model running on a daily time step and representing most processes occurring in the soil-crop-atmosphere system: crop growth and development, soil water, carbon and nitrogen dynamics. CropSystVB is developed using Visual Basic for Applications (VBA), with Microsoft Excel as a user interface. This programming environment allows complete access to the source code through the VBA Editor provided with Excel. Microsoft Access is a RDBMS installed on most computers as part of the Microsoft Office package. It is relatively easy to use, as it provides an intuitive graphical environment to create tables, queries, forms and reports. VBA is available in Access as well as in all the Office applications. To proceed with the integration, we have: (i) designed a data model; (ii) implemented it in Access; (iii) adapted the Excel-VBA to Access-VBA. The data model is a representation of what data need to be stored in a database, and in which relationships are its components. We designed the data model using the entity-relationship framework (Garcia-Molina et al., 2002). The data model for the Access implementation of CropSystVB was designed to store: (i) data required by the cropping systems model (soil, atmosphere, morpho-physiological characteristics of the crop, management events, rotation); (ii) data required for model application in the farm context (farm cultivation scenarios, fields and their spatial variability, animal breeds); (iii) the outputs of each simulation. The data model was implemented in Access by creating tables, relationships and forms to input data and inspect simulation results. As a last step, we have modified the Excel-VBA code to interact with Access. This means that most of the code was left unchanged (as the language is exactly same); only the parts dealing with data input and output were modified to read inputs and to write outputs from and to Access tables.

### Results

The data model (reported in detail by Bechini and Stöckle, 2007) includes entities describing the farm (farms, fields, farm cultivation scenarios, homogeneous areas), its physical environment (locations, soils, soil layers), the cultivated crops (rotations, crops in rotation, set of crop parameters), their cultivation (management set, irrigation events, fertilization events, tillage events, manure application events), the organic amendments available (manures and organic fertilizers, crop residues), the simulations (simulations, soil layer initial conditions, growing season outputs, annual outputs, daily outputs), and the animals (animal breeds, animal groups, types of animal groups). Examples of the forms are shown in Fig. 1 and Fig. 2.



## DEHESA MODEL: NEW TOOL FOR RECOVERING TRADITIONAL AGROFORESTRY SYSTEMS OF IBERIAN PENINSULA

C. G. H. Díaz-Ambrona<sup>1</sup>, A. Etienne<sup>1</sup>, J. Almoquera<sup>1</sup>, J. Martínez-Valderrama<sup>2</sup>

<sup>1</sup> Dep. de Producción Vegetal: Fitotecnia, Universidad Politécnica de Madrid, E-28040 Madrid, Spain, [carlosgregorio.hernandez@upm.es](mailto:carlosgregorio.hernandez@upm.es)

<sup>2</sup> CSIC, Estación Experimental de Zonas Áridas, E-04001 Almería, Spain, [jaimonides@eeza.csic.es](mailto:jaimonides@eeza.csic.es)

### Introduction

The *dehesa* is open oak parkland. These woodlands with silvo-pastoral use cover about two million hectares in the Iberian Peninsula. Traditionally annual pastures have been grazed by cows, sheep and also goats while acorns enrich Iberian pig diet, turning out a very appreciated and marketable product. Evergreen oak (*Quercus ilex* L.) has other uses as fuelwood collection and folder after tree pruning. Besides flora and fauna of the *dehesa* is exceptionally rich (Schnabel, 1997).

In the last years efforts devoted to quantify the varied outputs of *dehesa* have resulted in different works. Grazing (e.g. Herrero et al., 1998) and forestry models (Gracia, 2005) coexist with methods applied to determine the acorn production in field (Vazquez, 1999).

The objectives of this work were (i) to present a computer simulation model of the *dehesa* system to establish the productivity and the most suitable stocking rate for cattle, sheep, and Iberian pig; and (ii) to explore the key process of the *dehesa* system in an environment with a large variability such as the Mediterranean climate.

### Methodology

Following the structural methodology of System Dynamics and employing VENSIM® DSS software we have implemented a model composed by five interacting blocks (climate, soil, pasture, evergreen oak and livestock). The climate submodel contributes with daily data of temperature, solar radiation and precipitation, to calculate reference evapotranspiration applying a simplification of the Priestley-Taylor equation. The soil submodel calculates the soil water balance as cascade model.

Pasture equations compute daily forage production and demand considering a fixed stocking rate. Evergreen oak submodel allows knowing oak and acorn biomass. Growth processes are restricted by temperature and soil water availability. In the livestock submodel the actual stocking rate maintained with the own resources and the amount of hogs is calculated, which can be compared to the initial stocking rate, an exogenous variable. Model calibration was based on data from literature and has been validated with field data for acorn and pasture production. Relative root mean square error (RRMSE) and coefficient of residual mass (CRM) were calculated.

The model was applied to different tree covers ranging from pasture without tree to 88 mature oak ha<sup>-1</sup> (100% soil shade), on Inceptisol soils. In the exposed simulation livestock farm considered is composed of an average herd of 450 kg breeding females, which produces and sells steers up to 200 kg reared on the farm, and pigs that in fatten period –comprehended between 120 to 160 kg of life weight– are fed with acorns. Rate of conversion of 13,5 kg acorns per kg of life weight has been considered for hogs. Total income was calculated from market prices of 2.2 euros kg<sup>-1</sup> for steers and 2.61 euros kg<sup>-1</sup> for hogs.

### Results

Simulated average annual acorn production in seven location of southwest Spain (Extremadura) was 9.60 kg by tree while observed was 9.73 kg by tree (RRMSE 33%), coefficient of residual

mass (CRM) 0.05. Simulated grass production was  $1311 \text{ kg ha}^{-1}$  and observed was  $1333 \text{ kg ha}^{-1}$  (RRMSE 15% and CRM 0.02).

The model was applied to different open oak parklands of Extremadura. Maximum stocking rate was  $0.70 \text{ cows ha}^{-1}$  and  $0.62 \text{ hogs ha}^{-1}$ . The simulation of different soil types gave a variation coefficient of 20.8% in cows and 8.9% in hogs; meanwhile the simulation of different climate produced a variability of 3.2% and 5.4% respectively. Taken into account soil type distribution in Extremadura and land uses we obtained a potential of 1,658,933 cows and 750,962 hogs. Today stocking rate is  $0.5 \text{ cows ha}^{-1}$ , simulated stocking rate is  $0.65 \text{ cows ha}^{-1}$ . Stocking rate ( $\text{cows ha}^{-1}$ ) has increased steadily from 0.25 in 1986 to 0.5 in 2006, as consequence of European subsidies regulated by CAPs (Pulido, 2002). Although our model shows that even higher stocking rate values are possible it has to be pointed out that soil erosion can be triggered by overgrazing (Schnabel, 2001). In fact southwestern dehesas have been included in Spain risk desertification scenarios (Ministry for the Environment, 2007).

Figure 1 shows how subsidies applied to dehesa systems increase pasture grazing to the detriment of fattening pigs with acorns. After twenty years of subsidies management of land has led to intensification of grazing damaging trees recruiting and therefore thinning out the forest (Plieninger, 2007). The Dehesa model reveals that similar economic results can be achieved turning to high-quality production such as pigs fed with acorns, keeping appropriated tree covers to protect soil from erosion.

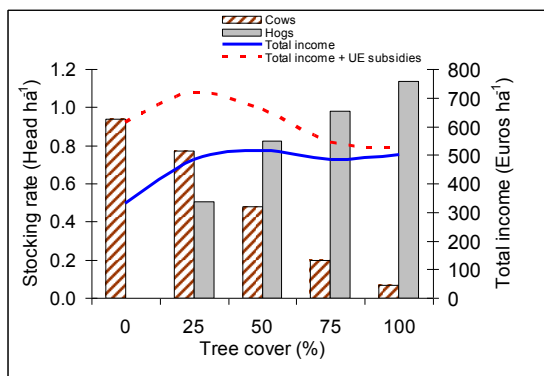

**Figure 1. Simulation of dehesa stocking rate (cows and hogs) and total income for different tree cover.**

## Conclusions

The Dehesa model is a fine procedure to estimate average acorn and pasture production. Its application for experimental simulation of tree cover showed a reduction of cows' stocking rates with both the increased of tree density and hogs potential. The total income per hectare showed a maximum value among

25 to 50% percent of tree cover (22 to 44 mature trees  $\text{ha}^{-1}$ ). In the Extremadura region there is not decoupling of cows' EU-subsidies. Subsidies increase income related to herbivores, and farmers are not investing to maintain a high tree density.

## Acknowledgments

This work was financed by the Spanish "Ministerio de Educación y Ciencia" through the research project AGL2005-03665: *Modelo Teórico Agro-forestal para la Simulación de Sistemas Adehesados*.

## References

- C. Gracia et al., GOTILWA+: Un modelo de crecimiento forestal basado en procesos ecofisiológicos, 2005. Cuadernos de la Sociedad Española de Ciencias Forestales 18, 21-28.
- M. Herrero et al., The plant/animal interface in models of grazing systems, 1998. Agricultural systems modelling and simulation, 495-542.
- Ministry for the Environment, National Program of Action against Desertification, 2007. Working Paper. Secretaría General de Medio Ambiente, Madrid, Spain.
- T. Plieninger, Compatibility of livestock grazing with stand regeneration in Mediterranean holm oak parklands, 2007 Journal for Nature Conservation 15, 1-9.
- F. Pulido, La Producción Animal en la Dehesa Extremeña, 2002. Libro blanco de la agricultura, Ministerio de Agricultura, Pesca y Alimentación, Spain.
- S. Schnabel, Soil erosion and runoff production in a small watershed under silvo-pastoral landuse (dehesas) in Extremadura, Spain, 1997. Geofoma Ediciones. Logroño, Spain.
- Vázquez F.M. et al. Estimación de la producción de bellotas de los encinares de la provincia de Badajoz en 1999, 1999. Solo Cerdo ibérico 14, 67-75.

## A MODELLING FRAMEWORK TO DESIGN INNOVATIVE AGRICULTURAL PRODUCTION SYSTEMS

P.-Y. Le Gal<sup>1</sup>, C.-H. Moulin<sup>2</sup>, M. Navarrete<sup>3</sup>, J. Wery<sup>4</sup>

<sup>1</sup> CIRAD, UMR Innovation, Montpellier, F-34398 France, [pierre-yves.le\\_gal@cirad.fr](mailto:pierre-yves.le_gal@cirad.fr)

<sup>2</sup> SUPAGRO, UMR ERRC, 2 place Viala, 34060 Montpellier Cedex 2, France, [moulinch@supagro.inra.fr](mailto:moulinch@supagro.inra.fr)

<sup>3</sup> INRA, Unité d'Ecodéveloppement, 84914 Avignon Cedex 09, France, [navarret@avignon.inra.fr](mailto:navarret@avignon.inra.fr)

<sup>4</sup> SUPAGRO, UMR System, 2 place Viala, 34060 Montpellier Cedex 2, France, [wery@supagro.inra.fr](mailto:wery@supagro.inra.fr)

### Introduction

Designing innovative agricultural production systems is increasingly based on modelling and user centred methodologies. This process has to involve both a representation of the production system from field to farm scales and the selection of relevant modelling tools integrating the various components of the system. This paper proposes a modelling framework based on three interacting sub-systems, i.e. biophysical, technical and decision ones, illustrated by three cases of modelling integration. Generic evidences are then discussed regarding the use of integrated modelling in a production system design perspective.

### Three main sub-systems

Agricultural production systems involve three main sub-systems that interact at various management levels. The bio-physical sub-system is defined by the interactions between physical and biological components, such as water, soil, climate and pests, and the plant/animal growth and development. The technical sub-system is defined as a combination of techniques applied by farmers to the bio-physical system from field/herd to farm levels, in order to fulfil production objectives, while the decision sub-system is defined as the combination of objectives, rules and indicators designed and carried out by farmers in order to select their technical interventions.

There is a need to develop a generic modelling methodology which could help researchers in designing innovative production systems based on a realistic representation of farm management at various levels. Indeed, choosing the appropriate modelling scale of the technical system raises a key issue, which depends on the problem to solve: at plot or batch level when technical innovation is available at this scale; at farm level when work organisation, crop pattern or livestock system issues are addressed; at farmer group level when coordination processes between farmers and agro-food firms are challenged. The following section gives three examples of partial modelling integration of these three sub-systems.

### Three cases of integrated modelling

#### *Designing innovative Cotton Management Systems in Mali*

Innovative cotton management systems (CMS) were designed based on (i) their production (yield and fiber quality), (ii) their environmental impact and (iii) their adaptation to farmers' and supply chain requirements (Lançon et al., 2007). Focus was given to the representation of the biophysical sub-system and its relationship with the major components of the technical sub-system either already used by the farmers in the area (Rapidel et al., 2006) or potentially available as a breakthrough in water limited production (e.g. combination of new varieties, high plant density and growth regulators). Both production and environmental impacts were calculated from state or flow variables of the biophysical sub-system, while indicators assessing economic performances and consistency with the family needs and objectives were derived from the technical sub-system. Farmers' objectives and decision process were not taken into account in the system under study but were considered as a set of constraints, together with soil and climate conditions.

#### *Planning lettuce cropping cycles at farm scale*

Producing high-quality products and simultaneously reducing the use of chemical products needs change in the multi-field planning of market-gardeners' crops. A rule-based model SaladPlan was built and validated to simulate how lettuce cycles cropped in open field and under shelter are combined year-round at farm scale in response to marketing requirements (Navarrete et al., 2007a). The model simulates how farmers choose (i) areas devoted to these crops, (ii) sub-species to be planted and (iii) planting and harvesting dates at plot level, based on (i)

characteristics of soil, climate and crops and (ii) farmer's strategic objectives and management of farm resources. SaladPlan links the decision system to the technical system to plan lettuce production at plot and farm levels. The relation with biophysical models is uneasy since they focus on techniques such as fertilisation and irrigation linked to environmental factors rather than technical management at farm level. Moreover they are not systematically calibrated for specific contexts. SaladPlan may be used to assess the farmers' leeway while changing lettuce cropping techniques.

#### *Designing innovative dairy farming systems*

Livestock farmers have to plan the adjustment between their herds feed demand and the feed supply they can produce on their own farm or buy outside. A model has been developed in order to support farmers designing innovative strategies of milk and meat production. It takes into account (i) the herd dynamic during the year, (ii) the forage production according to the cropping pattern and the technical systems implemented, and (iii) the feed diets supplied to the herd. The balance between feed demand, supply and diets determines the farm milk and meat productivity and seasonality. The model includes a basic representation of the biophysical system based on both the intake prediction and a potential lactation curve. The decision system is not modelled, but only its technical outputs (e.g. the diets themselves, derived from surveys of expert knowledge). This model has been tested with Moroccan irrigated small scale dairy farms (Le Gal et al., in press) in order to assess the impact of innovative forage cropping pattern (substitution of alfalfa by maize) on farms' milk production and the milk collection dynamic at cooperative level.

#### **Conclusions:**

These three cases highlight some difficulties in integrating the three sub-systems to be modelled in a farming system design perspective. Firstly models' accuracy varies from one level to another according to the focus adopted by the designers in term of input-output variables and validity domain. Field crop specialists would consider farmers' decision systems as a constraint while farm management scientists would use a simplified representation of bio-physical processes, sometimes restricted to local or general references or built by experts. Secondly farmers' decision systems are frequently modelled based on rules such as IF "Indicator = value" THEN Action, where indicators may differ largely from the variables included in the bio-physical models. Moreover the data required to run these models may not be available when modelling given technical and decision sub-systems. Thirdly the degree of simplification/complexity of every modelling component has to be discussed according to the planned model use. Researchers investigating innovative systems *in silico* may refine the processes representation while researchers supporting farmers in a participatory perspective mainly need simplified formalization that farmers are able to understand and validate themselves.

These various difficulties suggest developing a flexible methodology which would better integrate knowledge and modelling between the three sub-systems while adapting its tools to a range of potential users from researchers to farmers' organizations. Such an objective calls for a hybrid modelling methodology, where scientific knowledge based on formalized tools investigates and includes expert knowledge early in the modelling process. This implies to develop modelling platforms and participative approaches to facilitate collective work between both a large range of scientific disciplines and of stakeholders (farmers and advisers). In that process it would be useful to enlarge the production system definition by investigating and modelling supra-farm levels such as mill supply area and watershed in order to take into account the constraints, leeways and impacts of agricultural production systems at these scales.

#### **References**

- J. Lançon et al., An improved methodology for integrated crop management systems. 2007. Agron. Sustain. Dev. 27, 101-110
- P.Y. Le Gal et al., Dispositifs de coordination entre industriel, éleveurs et périmètre irrigué dans un bassin de collecte laitier au Maroc, 2007. Cahiers Agriculture (in press)
- M. Navarrete et al. SaladPlan: a model of decision-making process in lettuce and endive cropping, 2007. Agron. Sustain. Dev (in press)
- B. Rapidel et al., In field development of a conceptual model for crop functioning and management: a case study on Cotton in Southern Mali. 2006. Europ. J. Agronomy 24, 304-315

## E.P.I.C. SIMULATION TO MANAGE IRRIGATED CROPS

G. Piccinni<sup>1</sup>, J. Ko<sup>1</sup>, D. Leskovar<sup>1</sup>, A. Kemanian<sup>2</sup>, T. Gerik<sup>2</sup>

<sup>1</sup> Texas Agricultural Experiment Station - Uvalde, Texas A&M University, USA, [g-piccinni@tamu.edu](mailto:g-piccinni@tamu.edu)

<sup>2</sup> Texas Agricultural Experiment Station - Temple, Texas A&M University, USA.

### Introduction

Use of simulation models is becoming widely accepted as decision support systems for management of crop water use and production practices. E.P.I.C. (Erosion Productivity Impact Calculator) model was developed to determine the relationship between soil erosion and productivity in the USA (Williams et al., 1984). This model includes physiologically-based components to simulate soil erosion, plant growth and related processes. Major components of this model include weather, hydrology, erosion, nutrient cycling, soil temperature, crop growth, tillage, pesticide fate and economics.

The generic crop growth routine in EPIC facilitates the simulation of complex crop rotations and fallow cropping systems, making the model useful for evaluating alternative crop management scenarios. One scenario of interest in semi-arid regions is the determination of crop water use to evaluate plant production under limited water availability.

The EPIC hydrological component includes runoff, percolation lateral subsurface flow, snow melt and evapotranspiration (ET). The model provides five ET equation options from which the user has to make a single choice for a simulation exercise. The ET equations included in the models are: Penman, 1948, Penman-Monteith, 1965, Priestley-Taylor, 1972, Hargreaves-Samani, 1985, and Baier-Robertson, 1965. A very critical step in EPIC for the construction of the water management scenario is to determine the appropriate ET equation option for the environment under study. Therefore, the main objective of this research was to 1) determine the best fitted ET equation to use for a water use simulation in semi-arid climates and 2) evaluate and validate the model as a decision support tool for irrigation management.

### Methodology

A 3 year field study was conducted at the Texas A&M University, Texas Agricultural Experiment Station in Uvalde, Texas, USA (Lat. 29° 13' 03", Long. 99° 45' 26", 283 m elevation) in 2002, 2003 and 2004. Data were obtained from 2 adjacent fields planted with maize, one irrigated with a LEPA (Low Energy Precision Application) center pivot system, and the other irrigated with a LEPA lateral move system covering 1 ha field with an in-ground weighing lysimeter. Plots under the center pivot were arranged in a randomized split-block design with each split replicated 8 times. A 90° wedge of the center pivot field was divided equally into 15° plots each maintained at 100%, 75% or 50% crop evapotranspiration (ETc).

The in-ground lysimeter units used over the 3 year experiment had monolithic soil cores (Marek et al. 2006) of 1.5 m x 2.0 m x 2.5 m depth in a box built using a 9.5 mm thick steel plate. The lysimeter box rested on a Weigh-Tronix scale with a resolution of 100g measured at 5 minutes intervals using a Campbell Scientific (Logan, UT, USA) 23X data logger. The lysimeter field was managed under unstressed water conditions by replenishing the amount of water used (ETc) as measured in the lysimeters. The irrigation of the center pivot field was based on the modified Penman-Monteith calculation using crop coefficients (Kc) developed at the USDA ARS Conservation and Production Research Laboratory in Bushland, TX, USA. The soil type in both fields was "Uvalde clay" (a fine-silty, mixed, hyperthermic aridic calciustolls) with a pH of 8.1.

Fields were planted in mid March every year with maize, variety Pioneer 30G54 (Johnston IA, USA) and regional standard agronomic and fertilization practices were implemented. Simulations of soil moisture, ETc and grain yield were carried on using EPIC. After preliminary test runs we selected Penman – Monteith and Hargreaves – Samani to simulate reference evapotranspiration (ETo). In the pivot field, ETc was calculated using a modified Penman – Monteith (Allen et al., 1998) from meteorological data collected with a standard Campbell Scientific weather station.

**Results and Conclusions**

Table 1. Maize crop water use calculated with different methods: LM, Lysimeter measured; IFC, in-field calculated using the modified Penman-Monteith (P-M); EPIC-H, model set with Hargreaves equation; EPIC-PM, model set with the original P-M equation; Diff. LM, differences from LM.

Year	LM	IFC	EPIC-H	EPIC-PM
	-----mm-----			
2002	457.71	491.24	509.27	511.56
2003	507.49	523.24	502.41	560.07
2004	526.03	477.52	509.52	541.53
3-year mean	497.08	497.33	506.98	537.72
Diff. LM	-----	0.25	9.91	40.64 <sup>†</sup>

Table 1 shows the comparison among lysimeter measured ETc and the other three methods of calculation (in field modified Penman – Monteith, Penman – Monteith and Hargreaves – Samani). No statistical differences were found in total crop water use among lysimeter measured, modified Penman – Monteith and Hargreaves – Samani, while the Penman – Monteith overestimated ETc every crop season.

Figure 1. Lysimeter measured crop evapotranspiration (ETc) vs. two methods of estimating crop ET (in-field calculated and EPIC simulated using Hargreaves-Samani)

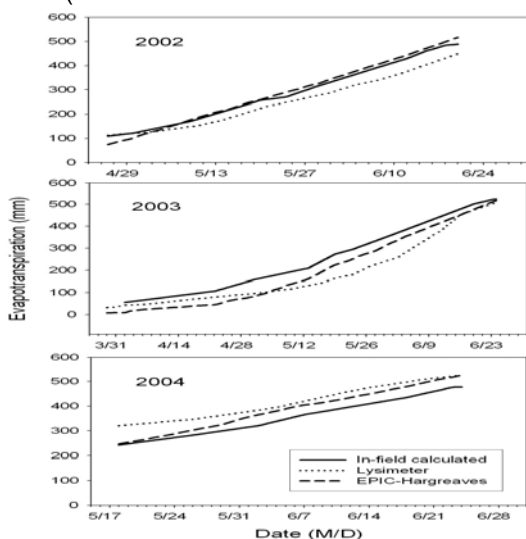

Cumulative ETc during the growing season (Fig. 1) varied year to year among all methods of calculation. This in-season differences are largely due to generic simulation growth parameters or growth stage specific Kc, and are considered to be within acceptable range.

These results are in general agreement with those by de Bruin and Lamblas, 1998, de Bruin and Sticker, 2000 and Irmak et al., 2003. These authors describe the best method for determining ETc is usually the one that uses data generated from the site from where the formula was originally developed. Hargreaves – Samani was developed in Davis, CA, USA, a site closer to ours than the original Penman Monteith site.

Figure 2. Measured vs. simulated grain yields using three years of data (dashed lines are 95% confident interval for the mean of the simulated values).

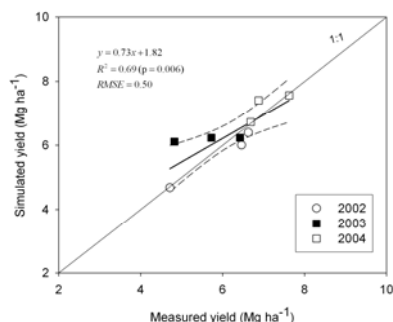

Yield variability among years was simulated fairly accurately by EPIC. For the three years of the study the regression line between simulated versus measured yield was close to 1:1 and within the 95% confidence interval. In the three years measured yield varied between 4.71 and 7.62 Mg ha<sup>-1</sup>, while simulated yields varied between 4.68 and 7.56. This general agreement is also described by Kiniry et al., 2004. From the results of this study and the validation of the model, we can conclude that EPIC can be used as decision support tool for irrigation management of maize in the semi arid regions of Texas.

**References**

Allen et al., Crop Evapotranspiration, 1998. FAO Irrigation and Drainage paper 56.  
 de Bruin et al., Reference evapotranspiration with a modified Makkink equation, 1998. Hydr. Proc. 1052-1062  
 de Bruin et al., Evaporation of grass under non-restricted soil moisture conditions, 2000. Hydr.Sci.J.391-406  
 Irmak et al., Daily grass and alfalfa reference ET estimates in Florida, 2003. J. Irrig. and Drainage 394-400  
 Kiniry et al., Maize yield potential. Simulation modeling...2004. Agric. Systems 82:45-56.  
 Marek et al. Weighing lysimeters for the determination of Kc, 2006. Applied Eng. Agri. 22: 851-856  
 Williams et al., Determining the relation between soil erosion and producti, 1984. Trans. ASAE 27: 129-144



## DESIGN OF COVER CROP MANAGEMENT PLANS SATISFYING PRODUCTIVE AND ENVIRONMENTAL OBJECTIVES

A. Ripoche, J.P. Cinna, F. Celette, C. Gary

UMR System, INRA, Montpellier, France, [aude.ripoche@supagro.inra.fr](mailto:aude.ripoche@supagro.inra.fr)

### Introduction

Cover crops can be introduced in vineyards to various ends. They protect soils against run-off and erosion, improve soil physical properties and reduce the use of herbicides. Yet, they compete with grapevines for soil resources (Celette et al., 2005) and consequently, the vine vegetative development and yield can be limited, and the grape quality affected (Chantelot et al., 2004). Therefore, designing cover crop management plans that would (i) satisfy a set of objectives related to both grapevine production and environment and (ii) produce good results despite the inter-annual variability of climate is a major challenge for vine growers.

Several methods have been developed to optimize crop management planning (Gary, 2004; Loyce and Wery, 2006). They all consider a set of criteria that are used for evaluating and rating various combinations of technical options. In the Betha system, Loyce et al. (2002) adopted a method of multiple criteria analysis that combined the definition of a range of alternative management plans, the calculation for each candidate management plan of indicators associated to the various criteria, and the aggregation of these criteria for rating each candidate management plan. Finally, they considered the inter-annual weather variability to evaluate the robustness of the best management plans. This method has been used here for identifying cover crop management plans in vineyards that would satisfy production and environment criteria in the context of different soil water availabilities, and of the variability of a Mediterranean climate.

### Methodology

The adopted method included four main steps. (1) A range of alternative management plans of cover cropping were defined by exploring all combinations of three variables: the type of grass characterized by its root depth (0.3, 0.6 m), the percentage of covered soil surface (0%, 30%, 50%, 70%), and the time when the growth and water consumption of the grass cover stops (grapevine budbreak, flowering, veraison). These alternative plans were explored for three types of soils with either 80, 140 or 200 mm total transpirable soil water (TTSW). (2) Four evaluation criteria were chosen: vegetative development, yield, product quality and run-off, and the ranges of values that would be desirable (agreement set) or not (discordance set) were defined. (3) A model was designed to simulate the behaviour of the grapevine – cover crop – soil system under the range of explored management plans and climate and soil conditions, and produce indicators related to the four evaluation criteria. This model is basically a water balance model designed for row crops (Lebon et al., 2003) with two specific features: two soil compartments, one explored by the cover crop and the rest available for the grapevine, and runoff calculated in proportion of rain intensity (Celette, 2007). Four indicators were related to criteria of evaluation: the average fraction of transpirable soil water (FTSW) during the vegetative phase of grapevine correlated to vegetative development, the average FTSW from grapevine flowering to veraison correlated to yield, the average FTSW from grapevine veraison to maturity correlated to fruit quality (Pellegrino et al., 2005), and the yearly average percentage of runoff. (4) A multiple criteria analysis was then carried out following the procedure described by Loyce et al. (2002). The model was used to simulate the water balance under all alternative cover cropping management plans and on the various soil types, evaluate for each the four criteria and calculate the overall agreement and discordance with various weights assigned to production and environment criteria. At last, a frequency analysis was carried out over 30 years weather

data (Montpellier, France) to estimate the robustness of the most satisfying management plans for each soil condition.

## Results and discussion

The major outputs of the multiple criteria analysis were the following. For a weighting of criteria giving greater importance to limitation of runoff than to control of production, the best management policies were those maintaining a cover crop over the largest area in the vineyard, and the worst was bare soil. With a different weighting of criteria i.e. when giving greater importance to control of production than to limitation of runoff, the best management plans differed on deep and shallow soils.

These findings confirm and generalize conclusions from the literature drawn from various experiments exploring each a limited range of cover cropping policies (e.g. in Chantelot et al., 2004). Yet, the validity range of the water balance model and the quality of the outputs of the multiple criteria analysis remain to be thoroughly evaluated within a field network.

As formulated in the present research, no management plan was always good throughout the years. The observed yearly (ETP-rain) balance varied from 657 to 463 mm during the 1975-2005 period, which generated strong variations in the water balance of the grapevine – cover crop – soil system. This lack of robustness of the explored management plans can be analysed as a consequence of a poor description of the management plans due to the limited combinations of technical options that were considered. In the real world, strategic or tactical adjustments can be introduced by farmers. On a yearly basis, they may decide to change the characteristics of the cover crop (percentage of covered area, timing of activity...) or of other cultivation techniques such as water or nitrogen management, in relation to the past performances of their cropping system (Hofmann, 2006). On a short term basis, they may adapt the timing of certain operations to the current conditions (e.g. the frequency of mowing or time of destruction of an annual cover crop in relation with drought). We hypothesize that introducing such rules in a decision model coupled to the present biophysical model would likely permit developing more robust cover crop management plans.

## References

- Celette F. et al., Belowground interactions in a vine (*Vitis vinifera* L.) - tall fescue (*Festuca arundinacea* Shreb.) intercropping system: water relations and growth, 2005. *Plant and Soil*, 276, 205-217.
- Celette F., Dynamique des fonctionnements hydrique et azoté dans une vigne enherbée sous le climat méditerranéen, 2007. Thèse de doctorat de Montpellier SupAgro, 180 p.
- Chantelot E. et al., Concurrence pour les ressources hydriques et azotées entre vigne et enherbement en milieu méditerranéen, 2004. In H R Schultz and A Achilles (eds) *Qualitätsmanagement im Obst- und Weinbau - International symposium in Quality management in viticulture and enology*, Stuttgart - Germany, 10-11 May, pp 171-184.
- Gary C., Evaluation, design and control of sustainable horticultural cropping systems, 2004. *Acta Horticulturae*, 648, 45-51.
- Hofmann A., Conception et évaluation multicritère d'itinéraires techniques d'enherbement des parcelles viticoles : construction d'un prototype d'outil, 2006. Mémoire de master Sciences et Technologies du Vivant de l'Institut National Agronomique Paris-Grignon, 43 p.
- Lebon E. et al., Modelling the seasonal dynamics of the soil water balance of vineyards, 2003. *Functional Plant Biology* 30, 699-710.
- Loyce C. et al., Management planning for winter wheat with multiple objectives (1) The BETHA System, 2002. *Agricultural Systems* 72, 9-31.
- Loyce C., Wery J., Les outils de l'agronome pour l'évaluation et la conception de systèmes de culture, 2006. In *L'Agronomie aujourd'hui* T. Doré, M. Le Bail, P. Martin, B. Ney, J. Roger-Estrade (Eds). Quae Editions, Paris, 77-95.
- Pellegrino A. et al., Towards a simple indicator of water stress in grapevine (*Vitis vinifera* L.) based on the differential sensitivities of vegetative growth components, 2005. *Australian Journal of Grape and Wine Research* 11, 306-315.

## C-FARM: A SIMPLE MODEL TO EVALUATE THE CARBON BALANCE OF SOIL PROFILES

Claudio O. Stöckle<sup>1</sup>, Armen R. Kemanian<sup>2</sup>, and David R. Huggins<sup>3</sup>

<sup>1</sup>Department of Biological Systems Engineering, Washington State University, Pullman WA 99164-6120, [stockle@wsu.edu](mailto:stockle@wsu.edu)

<sup>2</sup>Blackland Research and Extension Center, Texas Agricultural Experiment Station, Temple, TX, 76502

<sup>3</sup>USDA Agricultural Research Service, Pullman WA 99164

### Introduction

Growers are increasingly interested in participating in the emerging carbon trading market and managing their cropping systems to maximize soil carbon sequestration. Conditions leading to soil organic carbon (SOC) storage require evaluation, but this cannot be easily accomplished via experimentation or direct observation. The use of computer simulation models has emerged as a valuable approach to address carbon sequestration in agriculture.

### The C-FARM model

The principles for modeling soil carbon and nitrogen cycling (CNC) were formulated during the last decades and compiled in simulation models. A good review of models is given by Shaffer et al (2001). Models vary in the number of soil carbon compartments considered, in the detail with

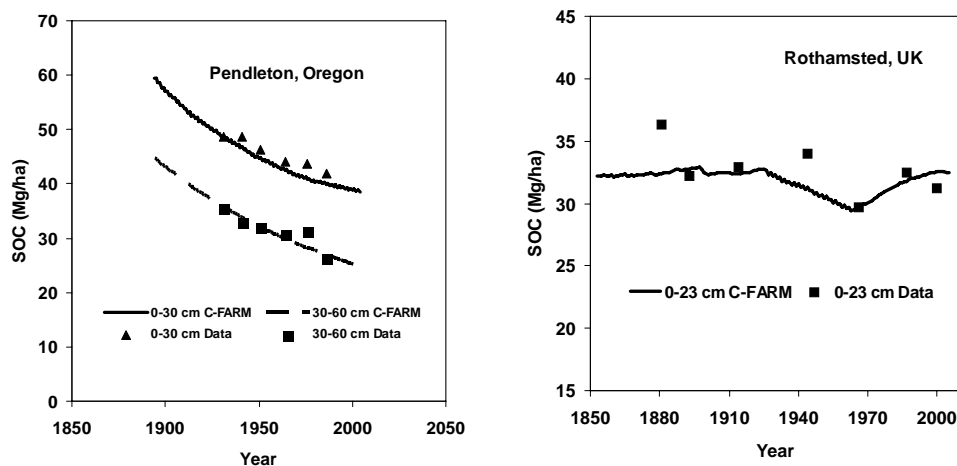

Figure 1. C-FARM simulation of SOC measured in long-term experiments at Pendleton, Oregon, and Rothamsted, United Kingdom.

which residue decomposition is represented, and in the treatment of management operations affecting CNC. Although multi-pool models provide a more detailed representation of the system, it is arguable that they necessarily provide better predictability than single-pool models. The more complex models have the shortcomings of requiring proper initialization of the fraction of soil carbon to be apportioned to each pool and the need to calibrate decomposition and transfer rates among multiple pools. Single-pool models are much simpler to calibrate and do not require initializing multiple-pools. For this reason, we have developed C-FARM as a simplified version of CropSyst (Stöckle *et al*, 2003), and we are starting to use the model with growers and extension personnel in the US Pacific Northwest (PNW). We believe that a tool such as C-FARM can be mastered with minimum training. The single-pool differential equation in C-FARM for each soil layer is  $dC_s/dt = h_x[1 - (C_s/C_{sx})^n]C_i - f_e f_t k_x (C_s/C_{sx})^m C_s$ , where  $C_s$  is soil carbon ( $Mg\ ha^{-1}$ ),  $t$  is time (year),  $C_i$  is carbon inputs ( $Mg\ ha^{-1}$ ),  $h_x$  is the organic carbon inputs humification ( $yr^{-1}$ ), which is a function of soil clay concentration and residue type (aboveground, belowground biomass, or manure),  $C_{sx}$  is the saturation carbon concentration for that layer ( $Mg\ ha^{-1}$ ),  $n$  and  $m$  are empirical constants,  $k_x$  is the apparent maximum soil carbon respiration rate ( $yr^{-1}$ ), and  $f_e$  and  $f_t$  are factors accounting for environmental and tillage effects on soil apparent respiration rate. In C-FARM,  $h_x$  is a function of soil texture and is different for root and aboveground biomass. Local effects of climate and soil type are accounted for through factors affecting the apparent soil decomposition rate  $k$  ( $k_x = 0.055\ yr^{-1}$ ). The factor  $f_e$  combines both soil temperature and moisture effects on  $k$ . Tillage accelerates soil turnover rates and mixes soil layers along with all the state variables (moisture, organic matter, and residues).

## Evaluating carbon sequestration potential

Figure 1 shows the performance of C-FARM estimation of SOC for two long-term experiments, one in Pendleton, Oregon for a winter wheat-summer fallow rotation under conventional tillage (Rasmussen and Smiley, 1997), and the other continuous winter wheat, except for the period 1926-1966 which was fallowed every other year (Jenkinson et al., 1992). As seen in Fig. 1 for Pendleton, the soil top 60 cm has been losing carbon since the inception of agriculture in this low-residue production condition. An accurate assessment of current SOC and residue input is critical to establish the potential for carbon sequestration. This is demonstrated by simulation runs using C-FARM, based on cropping systems information provided by direct seeding growers in the US PNW. The initial SOC corresponds to the lower and the higher value of the SOC range of typical soils in the locations included. Simulated carbon gain or loss is plotted as a function of initial SOC (expressed as percent organic matter) in Fig. 2. These simulation results illustrate that an accurate knowledge of initial SOC is fundamental to properly evaluate the potential carbon sequestration of agricultural systems.

## Conclusions

Our simulation results thus far indicate that the main factors defining the SOC sequestration potential of dryland agricultural systems in the US PNW are initial SOC (low better than high) > residue input to the soil (high better than low) > tillage intensity (low better than high), with the bulk of the potential defined by the first two factors. Growers in the region are becoming interested in using C-FARM to examine options for participating in carbon credit markets.

## References

- D.S. Jenkinson et al., Calculating net primary production and annual input of organic matter to soil from the amount and radiocarbon content of soil organic matter, 1992. *Soil Biol. Biochem.* 24:295-308.
- P.E. Rasmussen and R.W. Smiley, Soil carbon and nitrogen change in long-term agricultural experiments at Pendleton, Oregon, 1997. In *Soil organic matter in temperate agroecosystems*, E.A. Paul et al. eds. CRC Press Inc. pp. 353-360.
- M.J. Shaffer et al. (Eds.), *Modeling carbon and nitrogen dynamics for soil management*, 2001. Lewis Publishers, Boca Raton, 651p.
- C.O. Stöckle et al., CropSyst, a cropping systems simulation model, 2003. *Europ. J. Agronomy* 18:289-307. - 134.

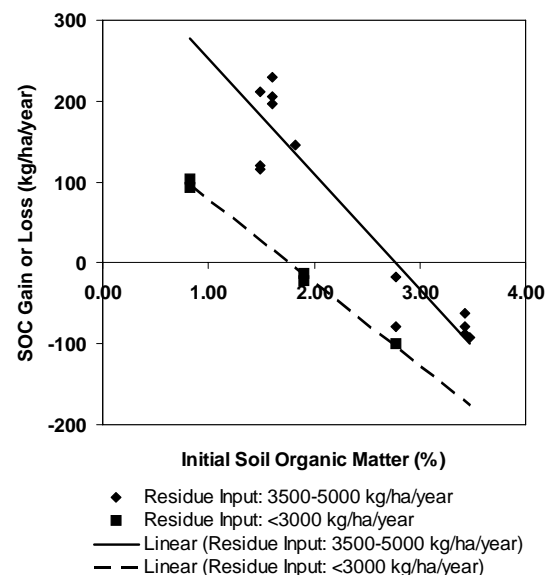

Figure 2. C-FARM simulation of SOC gain or loss as a function of initial SOM for selected sites and cropping systems in the US PNW.

## GRASSLAND MANAGEMENT: IMPACTS ON THE ENVIRONMENT

C. F. E. Topp<sup>1</sup>, R. M. Rees<sup>2</sup>, B. Ball<sup>3</sup>

<sup>1</sup> Land Economy & Environment Group, Research Division, SAC, UK, [Kairsty.Topp@sac.ac.uk](mailto:Kairsty.Topp@sac.ac.uk)

<sup>2</sup> Crop and Soil Systems Group, Research Division, SAC, UK, [Bob.Rees@sac.ac.uk](mailto:Bob.Rees@sac.ac.uk)

<sup>3</sup> Crop and Soil Systems Group, Research Division, SAC, UK, [Bruce.Ball@sac.ac.uk](mailto:Bruce.Ball@sac.ac.uk)

### Introduction

Grasslands dominate much of the European landscape, occupying 22% of the land area in the 25 countries of the EU. Their management therefore influences a range of environmental impacts, particularly since some grasslands receive large inputs of nutrients. This paper explores the environmental consequences of different fertilizer and manuring strategies for a cut grassland by using the DNDC (DenitrificationDecomposition) model at the Bush Estate, near Edinburgh. This model simulates daily fluxes and pool sizes of carbon and nitrogen in agroecosystems. It has been extensively applied around the world and is widely acknowledged as a state-of-the-art model for assessing nutrient fluxes (Li et al., 2006; Saggar et al., 2004).

### Methodology

Measurements of CO<sub>2</sub> and N<sub>2</sub>O emissions have been made at Bush estate between 2002-2004. Applications of 300 kg available N ha<sup>-1</sup> of fertilizer or slurry were applied and three silage cuts were taken each year (Jones et al., 2007). In addition to the fertilized plots, there was a control plot which received no fertilizer N. DNDC was used to model nutrient exchange and turnover. The model's input variables were daily climate, soil properties and management activities. The outputs included soil organic carbon storage, nitrate leaching and greenhouse gases; namely CO<sub>2</sub> and N<sub>2</sub>O. The model was run for six years, with the results presented for the period 2002-2003.

### Results

There was a tendency for the model to under predict CO<sub>2</sub> and N<sub>2</sub>O emissions for the control plots, while the predictions for the ammonium nitrate fertilizer showed the expected trends, Fig 1.

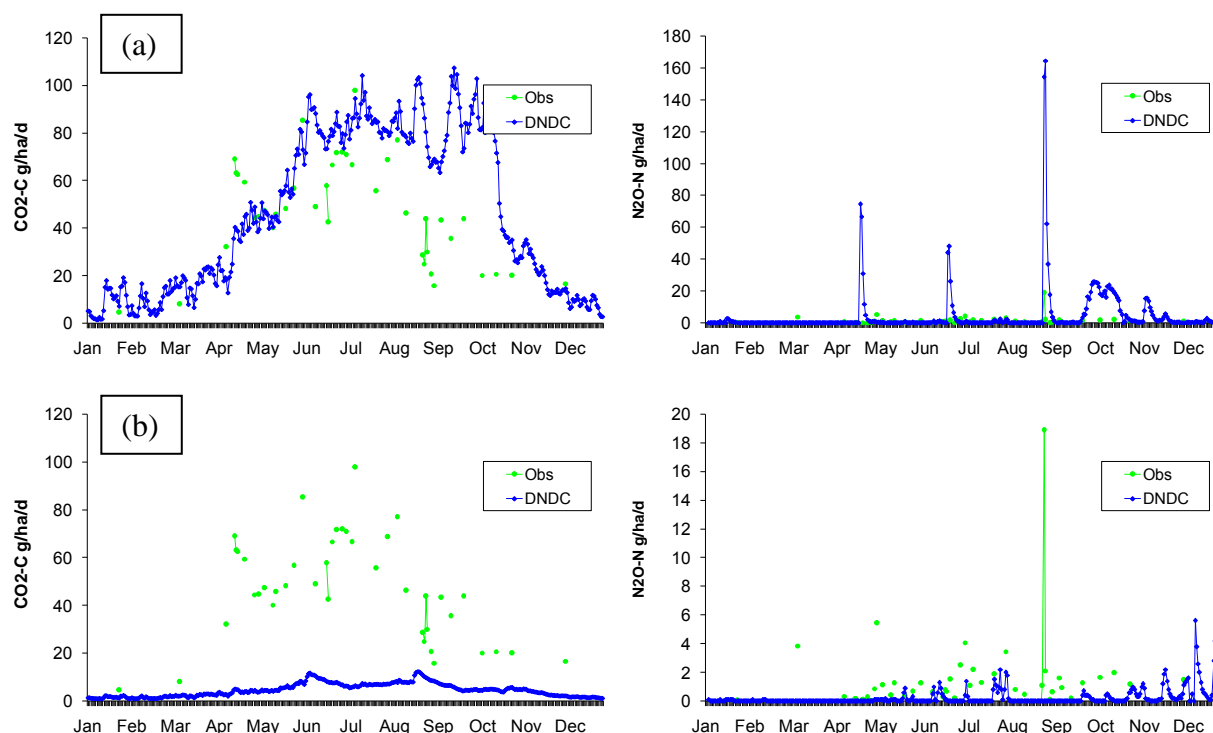

Fig 1. Comparison of CO<sub>2</sub> and N<sub>2</sub>O for 2003 for the ammonium nitrate fertilizer application (a) and the control plots (b).

The results suggested that the addition of manure increased the soil organic carbon compared with the inorganic N and control treatments (Fig 2a). This was consistent with measurements made at the site (Jones et al, 2005). However, the global warming potential (GWP), expressed as CO<sub>2</sub> equivalents, of the plots receiving cattle slurry were larger than the fertilized plots ( $P < 0.05$ ), and the control plot had a slightly negative GWP due to carbon sequestration. As expected applications of cattle slurry resulted in larger NO<sub>3</sub>-N leaching than the plots receiving inorganic N fertilizers partly as a consequence of the larger N input associated with the slurry (Fig 2b). The N<sub>2</sub>O emissions were higher for urea fertilizer than ammonium nitrate fertilizer. As with the GWP potential, the N<sub>2</sub>O emissions were highest for the cattle slurry.

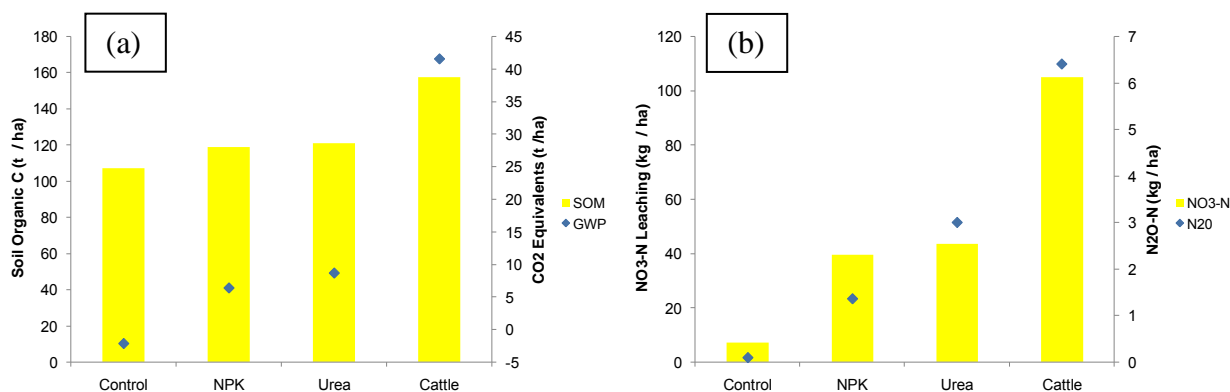

Fig 2. Simulations of annual average nutrient flows in for three different manure / fertilizer strategies at Bush estate, Edinburgh. All fluxes were averaged over the period 2002-2003. (a) The final soil organic carbon content (kg/ha to a depth of 50 cm) and the GWP; (b) Nitrate leaching (below 50 cm) and nitrous oxide emission.

## Conclusions

The high application rates of the cattle slurry resulted in high levels of organic-N within the soil, which was not mineralized as quickly as the model predicted and was thus not taken-up by the crop. This may have resulted in losses of N<sub>2</sub>O being overestimated. In addition, from Fig. 1, it would be expected that the GWP of the plots receiving no fertilizer or manure would be substantially higher than predicted by the model. Nevertheless, the results obtained can be valuable in helping understand the mechanisms underlining the observed management effects and in highlighting interactions and synergies. Although there were some weaknesses in the ability of DNDC to simulate the emissions from the grassland site used in this study, the results reveal that there is value of a systems based modelling approach to the study of environmental impacts. Confidence in such modelling approaches needs to be established through a careful process of validation. Data are being collected from additional sites, a grazing trial and a six-course organic rotation; these will aid in understanding the mechanism, and therefore help improve the modelling process.

## Acknowledgments

Funding was provided by the Scottish Executive and the EU project *Greengrass* (Contract no; *EVK2-CT2001-00105*). The authors would also like to thank John Parker and Robert Ritchie for technical assistance.

## References

- C.S. Li et al., Modeling nitrate leaching with a biogeochemical model modified based on observations in a row-crop field in Iowa, 2006. *Ecological Modelling*, 196, 116-130.
- S. Sagar, et al. Modelling nitrous oxide emissions from dairy-grazed pastures, 2004. *Nutrient Cycling in Agroecosystems*, 68, 243-255.
- S.K. Jones et al. Influence of organic and mineral N fertilizer on N<sub>2</sub>O fluxes from a temperate grassland. *Agriculture, Ecosystems and Environment*, 121, 74-83.
- S.K. Jones et al. Carbon sequestration in a temperate grassland; management and climatic controls, 2005. *Soil Use and Management*. 22, 132-142.

## DECISION SUPPORT TOOL FOR SORGHUM PRODUCTION UNDER VARIABLE RAINFALL IN THE CENTRAL RIFT VALLEY

S. Walker<sup>1</sup>, G. Mamo<sup>2</sup>

<sup>1</sup> Dept of Soil, Crop & Climate Sciences, University of the Free State, Bloemfontein, South Africa, [walkers.sci@ufs.ac.za](mailto:walkers.sci@ufs.ac.za)

<sup>2</sup> Melkassa Agricultural Research Centre, Ethiopian Agricultural Research Organization, Ethiopia, [mamo\\_girma@yahoo.com](mailto:mamo_girma@yahoo.com)

### Introduction

Sorghum is produced in the Central Rift Valley of Ethiopia as one of the staple foods. However, there is a high variability in the amount and timing of the rainfall received across the valley and this increases the risk associated with the tactical decisions around planting and cultivar choice. The uncertainty about the upcoming rainfall season has contributed to the effects of the recurring droughts and crop failure. A rainfall analysis alone does not provide sufficient information to the producers; it needs to be accompanied by the prediction aspect provided by seasonal rainfall forecasts. However, the use of probabilities to communicate the seasonal rainfall has been questioned, with suggestions made that they need to be more user friendly (Wylie, 1996). In contrast to the variability of the rainfall pattern (Haile, 1988) is the fact that the soil parameters at a specific site remain largely constant with time. Thus the physical soil water storage properties such as the drained upper limit, lower limit and plant available water capacity can be measured or characterized from other parameters for a specific site (Ritchie, 1999) and then used in the decision making process. The components that provide management possibilities for change are the sowing date, the cultivar choice, the planting density and the fertilizer application level (Diga, 2005). This then becomes a complex decision making process as there are also a number of cultivars available and a range of planting dates at any one site and a range of soils across the Central Rift Valley. The objective was therefore to develop a simple, but conceptually strong, reflective and potentially innovative 'what if' decision support tool (DST) centered on the use of the available seasonal climate forecasts. Therefore following a detailed rainfall analysis and a risk analysis of grain sorghum production in the valley, the DST called "ABBABOKA" was developed to assist in making decisions in this complex farming system.

### Methodology

The inputs include the current seasonal forecasts from the Ethiopian National Meteorological Services Agency (NMSA) and from the regional center IGAD Climate Prediction and Application Centre (ICPAC) in Nairobi. The March to September long-term monthly rainfall data from 25 weather stations situated in the study area was also used to make a prediction using the sea surface temperatures. Each of these sources provides a prediction in the form of probability of rainfall to be in the following categories: B = below normal; N = near normal or A = above normal for a particular time period. The logic followed in "ABBABOKA" is that if any two of the forecast sources gives an A and the other gives an N prediction then the outlook is considered to be good (i.e. above normal rainfall) and the model gives a signal to go ahead and plant sorghum. If one of the sources gives a B prediction, then the end users are advised to take the current soil water status into consideration before making a decision (Diga, 2005). If the outlook is for below normal rainfall from any two of the three sources then the message is to continue in a fallow cycle (i.e. not to plant). If there are a range of outlooks (i.e. combinations of A and N with one B) from the various sources, then the model makes an estimate of the plant available water before giving a message. If the soil profile has a plant available water of more than half the plant available water capacity then the advice will be to plant sorghum, however if the soil water is less than half the potential capacity then the farmers will

be advised to delay planting and remain in a fallow situation. Thus “ABBABOKA” provides recommendation to the farming community concerning the planting of sorghum for the current season based on the available scientific information and seasonal forecasts. It includes results from the 27 decision options giving the flexibility to choose a variety of a specific length under the various rainfall outlooks provided by the climate service provider sources.

### Results

“ABBABOKA” also provides a map showing the homogeneous rainfall zones of the Central Rift Valley that were developed from the long-term monthly rainfall data of the 25 weather stations. The seasonal crop water requirement satisfaction index (WRSI) is used to monitor the extent to which the water requirements of a given crop have been satisfied through the growing season. As there are at least four different sorghum varieties with a range of lengths of growing season from 90-days, 120-days, 150-days to 180-days, the WRSI needs to be calculated for each of the varieties in each of the homogeneous rainfall zones from each of a range of possible planting dates. The planting dates can be as early as March and April for any of the varieties, and then as the season progresses the number of variety options decreases as the longer season varieties would be unable to complete their growing cycle before the soil water is totally depleted. So only the 90-day and 120-day varieties can be planted during May and June and only the 90-day variety as late as July. As there are a total of 14 possible combinations of varieties and possible planting dates, “ABBABOKA” provides maps of the Central Rift Valley (CRV) to show the areas suitable for planting each of the varieties at each of the possible planting dates. These maps provide useful information for extension officers and other NGO workers so that they can distribute the necessary information concerning variety selection to the farmers in each of the homogeneous rainfall zones. The prediction part gives advice on planting decisions for a given month and a specific zone, such as ‘go ahead and plant a sorghum cultivar of 180-day variety, with 100kg/ha DAP (basal and 50 kg/ha (side dressing) with 33000 plants/ha’ depending on the outcome of the combination of factors.

### Conclusions

This decision support tool “ABBABOKA” is expected to provide a good starting framework for answering many of the practical farm questions for CRV farmers, researchers and extension workers alike. It combines an understanding of the risks associated with rainfall prediction and the performance of the various sorghum varieties at a range of planting dates under the soil conditions in the CRV. It provides a useful tool as the basis for co-learning activities amongst the farmers, extension workers and researchers as it is used to generate “what if” scenarios.

### References

- G.M. Diga, Using seasonal climate outlook to advice on sorghum production in the Central Rift Valley of Ethiopia, 2005. Ph.D. in Agrometeorology, Univ. Free State, South Africa
- T. Haile, Causes and characteristics of drought in Ethiopia, 1988. J. Agric. Sci. 10, 85-97
- J.T. Ritchie et al, Simple model to estimate field-measured soil water limits, 1999. Trans. ASAE 42, 1609-1614
- P.B. Wylie, Drought management on grain farms, 1996. In Proc. 2<sup>nd</sup> Aust. Conf. Agric. Meteorol., Brisbane, p132-136



## ANALYSIS OF FARMERS' CHOICES: A FEW PRINCIPLES, SIMPLE TOOLS AND MANY APPLICATIONS.

C. Leclercq<sup>1</sup>

<sup>1</sup>Dep. of Agronomy, Institut Polytechnique LaSalle Beauvais, France, [christine.leclercq@lasalle-beauvais.fr](mailto:christine.leclercq@lasalle-beauvais.fr)

### Introduction

The analysis of farmers' decisions aims at understanding the logic of their technical choices, their objectives and the farm's constraints or assets in order to adapt the diagnoses and the propositions concerning cropping<sup>1</sup> or farming systems to this context. We suggest learning from a double experience: on one hand, teaching the Global Approach of the Farm to various publics and, on the other hand, the application of its principles in sector-based and in crop management diagnoses on individual and regional levels. We shall make clear the principles used, the finalized methods and tools, several practical examples, some methodological lessons and working perspectives.

### Methodology

#### ***The approach implemented at the level of a farm or a crop management sequence***

The Global Approach of the Farm is based, in particular, on the postulate that "the farmer has reasons for doing what he does"<sup>2</sup>. This principle supplies operational rules for the analysis of the farmer's choices whatever level it is: farm or sub-systems such as crop management sequences.

In order to analyse with the maximum of objectivity the "subjective" decision-making process, the approach that we used contains the following stages: i) identifying all the farmer's choices including the choices of "public relations", ii) explaining them *i.e.* articulating in a logical chain the observed practices and the *determining factors required to explain these choices*: strategies/ objectives/ ends, assets and constraints of the farm, iii) representing all these decision-making processes in a plan. When the analysis of the individual choices aims at modelling the variety of the decision-making processes to represent the regional variability, it is then necessary to construct a typology.

The information about the practices and its determining factors is collected by semi-directive conversation with the farmer and then classified to make sure of its exhaustiveness. For every elementary decision, the choice and its determining factors are set out in a table: the farmer's practices on one hand, their determining factors on the other hand, according to the principle explained previously. We notice that the processes of decision-making modelled in this way are logical chains of a variable number of strategies. Care is taken to distinguish the strategies and the objectives, articulated by the logical conjunction "to" and the farm or land assets and constraints *such as the farmer perceives them* or seems to perceive them. At this stage, it can be useful, to insure a certain *trace ability* of the interpretation, to distinguish elements emanating from the farmer and the glosses added by the investigator. This table is then translated into a plan by bringing together all the choices made to reach the same objective. The analysis of the crop management decisions follows a step of the same type. Choices are classified by step *i.e.* by group of decisions considered highly interdependent even if relative to one or several operations.

#### ***The process of constructing typologies, methods and tools***

Standardized plans are usually used to aggregate farm plans having a comparable logic to establish types and represent the model of every type<sup>3</sup>. Our mode of representation is "free" and allows more

<sup>1</sup> CAPILLON A., Typologie des exploitations agricoles, contribution à l'étude régionale des problèmes techniques, Thèse de doctorat, INA-PG, 1993; Paris.

<sup>2</sup> BONNEVIALE J.R. *et al*, Approche globale de l'exploitation agricole. Comprendre le fonctionnement de l'exploitation agricole : une méthode pour la formation et le développement, 1989. Ed. INRAP, 65-70.

<sup>3</sup> CAPILLON A., MANICHON H., Guide d'étude de l'exploitation agricole à l'usage des agronomes, 1991. Document Chaire d'Agronomie – INA-PG, Paris, deuxième édition.

specific and more precise plans but makes less immediate the comparison of farms. If need be, it is possible to make a standardized plan from the table of choices and determining factors. For the construction of crop management sequences typology, we widely inspired by the method proposed by KOCKMANN and al.(1994)<sup>4</sup>. For every step, we re-state the various "couples" determining factors / strategy (ies) of all the crop management cases analysed, in a double entry table which allows:

- Testing the exclusivity of the relations between determining factors and strategies as a sign of the coherence and exhaustiveness of the logic chain that we reconstruct.
- Showing the variability of the "couple" determining factors / strategy (ies) for the considered link. To establish crop management sequences types, a stage of comparison of the various links is necessary. We bring together the determining factors of all the links and establish families of comparable determining factors. The model of every crop management sequence is reconstituted, by indicating for all links, the type of determining factors, thus allowing the comparison of the various crop management sequences. The logic of all crop management sequences having a comparable model is represented by a plan.

## Results

Let us quote some examples of diagnosis and evaluation of the margins of freedom in order to advice:

- A strategy of mechanization typology among a population of specialized dairy breeders constructed to provide personalized advice for the improvement of the economic performances and the quality of life. Let us notice that we used for it the same method than for crop management sequences.
- A corn crop management typology in western France to compare to the standards of integrated farm management.
- An oleaginous linen crop management typology in Picardy to explain and improve yields.
- A typology of the practices involved in risk of water pollutions by weed-killers in order to limit them.
- A typology of the practices of water management in potato producers' farms in Picardy to identify the possible adaptations to water limitations.

## Conclusions

The identification of constraints and the model are more complete and thus more credible if we consider all the farmer's practices even if we only study a sub-system and even if for some practices the farmer has no choice, *i.e.* no margin of freedom.

Of course, even if implemented with great rigour, the models stemming from the proposed approach, like every model, remain imperfect and partial representations of reality. The main risk on the bias seems to us to lie in the possible difference between the farmer's and the investigator's perceptions of the farm assets and constraints.

However, questioned farmers recognize the logic of their farm in the proposed representations, yet we could generalize the test. Moreover plans are usually very coherent and then the interpretations seem credible because, most of time, many different practices can only be explained by the same reasons. The training of several hundreds of students, future farmers and agronomists has confirmed that this method can be practised on the farm scale in a satisfactory way by people with little experience and limited technical culture. The objectivity of analysis of farmer choices is, at least in the first cases, facilitated by a common exercise or by a critical second reading. For most students, the common analysis of 2 or 3 examples seems to be enough for a quasi-autonomous application.

A working perspective, among others, is to answer the question: is the postulate of coherence still available in group forms of agriculture or farms of industrial type with several decision-makers at several decisions levels ?

---

<sup>4</sup> KOCKMANN F. *et al.* (1996) - Diagnostic régional sur la diversité des itinéraires techniques, 1996. In Colloque DERF-ACTA « Expérimenter sur les conduites de cultures », Paris, 9-26

**Session 2.3:  
Integrating genetics and management in  
improved production systems**

**Session Convenors:  
Graeme Hammer and Carlos Messina**

## OPPORTUNITIES AND IMPEDIMENTS FOR EFFECTIVE USE OF CLIMATE INFORMATION IN AGRICULTURAL SYSTEMS OF THE ARGENTINEAN PAMPAS

Federico E. Bert<sup>1</sup>, Emilio H. Satorre<sup>1</sup> and Guillermo P. Podestá<sup>2</sup>

<sup>1</sup> Dep. of Agronomy, Univ. of Buenos Aires, Argentina, [fbert@agro.uba.ar](mailto:fbert@agro.uba.ar)

<sup>2</sup> Rosenstiel School of Marine and Atmospheric Science, Univ. of Miami, FL, USA

Seasonal climate forecasts and projections of future climate offer the potential to improve decision-making in agriculture. We focus on crop production in the Argentine Pampas, one of the world’s major agricultural regions. Climate of the Pampas shows marked variability at both inter-annual (Podestá et al. 1999; Grimm et al. 2000) and decadal time scales (Castañeda y Barros 1994; Minetti et al. 2004). We explored opportunities and impediments for use of climate information in agricultural production in a participatory assessment with farmers and their technical advisors.

El Niño Southern Oscillation (ENSO) is the most important source of inter-annual climate variability and predictability in the Pampas (Grimm et al. 2000). Further, links between ENSO-related climate variability and agricultural outcomes have been shown in the Pampas, mainly for soybean and maize, the most important crops in the region (Podesta et al. 1999). Trough interaction with farmers and experts in the region we build “decision maps” that identified decisions sensitive to inter-annual climate variability in maize and soybean production, and realistic management options under various scenarios (ENSO phases). Decision-makers perceive potential benefits from adapt crop management (land assignment and crop management decisions) in response forecasts. For instance, expected environmental conditions associated with ENSO phases lead to changes in genotypes selection decisions (Fig. 1). However, we found different management actions (e.g. genotypes used) under the same forecasted environment (a given ENSO phase). Consequently, simulation outcomes showed that adaptive management strategies proposed in response to ENSO information may produce diverging economic outcomes (both positive and negative; Table 1). There are at least 2 possible reasons for the apparent misapplication of climate information: (a) incomplete knowledge of ENSO-related environments (i.e. climate signatures of a given ENSO phase for a particular regional climate) and (b) difficulties in envisioning outcomes of interactions between management actions and the environments.

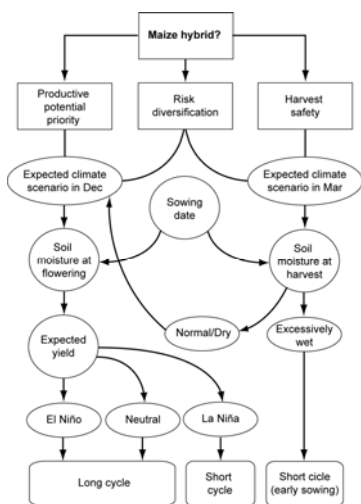

Fig 1. Conceptual diagrammatic representation of climate influences on deciding maize hybrid.

Table 1. Average economic result (USD ha<sup>-1</sup>) for the “climatological management” (i.e. ignoring forecasts) and expected value of an El Niño forecast for three different soybean adaptive strategies (S1, S2 and S3).

Management	Economic Result
Climatological (long MG <sup>*</sup> , normal SD <sup>**</sup> )	366
<i>Adaptive managements</i>	
S1: short MG, early SD	11 <sup>‡</sup>
S2: short MG, no change in SD	2
S3: long MG, early SD	-2 <sup>‡</sup>

<sup>\*</sup> Genotypes Maturity Group; <sup>\*\*</sup> Sowing Date; <sup>‡</sup> Statistical significant differences (p<0.05).

We explored the possible reasons for the misuse of climate information. Decision-makers were presented with detailed information about ENSO impacts on the local climate. Additionally, crop models were used to simulate several management options and climate scenarios, and outcomes

were subsequently presented to farmers in a decision exercise. Farmers were asked to define crop management with the opportunity of taking advantage of the presented information. Access to simulation outcomes let, in some cases, enhance use of forecasts by triggering previously unobserved responses, and by allowing fine-tuning of earlier decisions based on climate forecasts alone (i.e. without complementary information about ENSO impacts or simulation outcomes; Fig 2). Crop models outcomes were useful to improving the use of climate information since allowed decision-makers to quantify management (genotypes, sowing dates) x environment (ENSO phases) interactions.

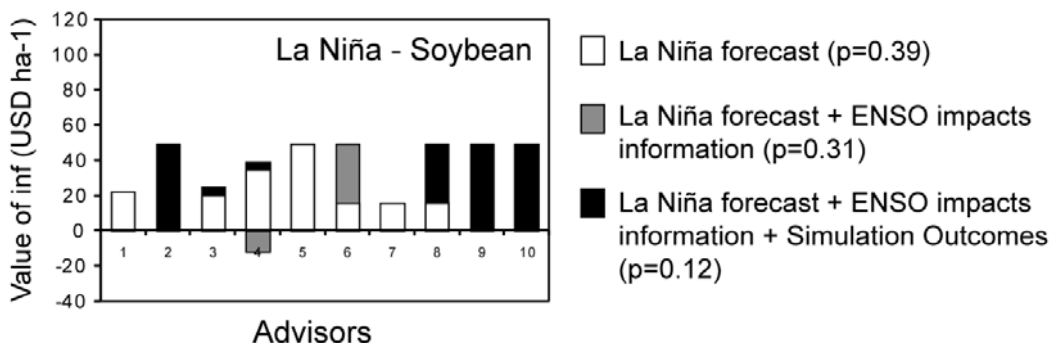

Fig 2. Expected value of using a La Niña forecast and forecast’s complementary information (parts of the decision exercise) in soybean production. *P-values* in the legend indicate differences between the adaptive managements (parts of the decision exercise) and the climatological management.

A marked increase in precipitation since the 1970s, together with new production technologies, led to major changes in agricultural systems in the Pampas. Nevertheless, production systems that have evolved partly in response to increased rainfall may not be viable if climate reverts to a drier epoch. We evaluated a plausible climate scenario: a decrease in precipitation over the next 25 years. We used weather generators to downscaling the regional scenario and crop and decision-making models to determine economic sustainability and optimal management of current production systems under the proposed scenario. Climatically optimal and marginal locations show differential responses: impacts of the decreasing precipitation sequence are much higher in currently marginal areas if precipitations decrease (Fig. 3). In addition to the simple but unrealistic assumption of constant technology, we plan to simulate the interaction of changing climate and technological innovations (e.g., simulation of anticipated biotechnological innovations by modifying parameters of crop models).

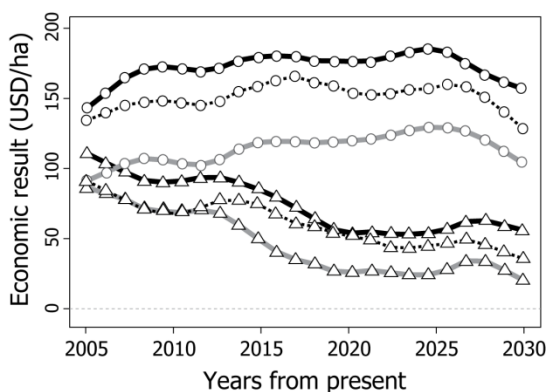

Fig 2. Temporal evolution of economic results (averaged over 100 realizations for each year in the sequence) in Pergamino (circles) and Pilar (triangles). The dark line corresponds to full-cycle soybean, the dashed line indicates the wheat-soybean double crop, and the grey line is for maize. The lines have been smoothed to facilitate visualization of trends.

REFERENCES: **Castañeda and Barros**, Las tendencias de la precipitación en el Cono Sur de América al este de los Andes, 1994. *Meteorológica* 19, 23–32; **Grimm et al.**, Climate variability in southern South America associated with El Niño and La Niña events, 2000. *J Climate* 13, 53–58; **Minetti et al.**, Non-linear trends and low frequency oscillation in annual precipitation over Argentina and Chile, 1931–1999, 2004. *Atmósfera* 16, 119–135; **Podestá et al.**, Associations between grain crop yield in central–eastern Argentina and El Niño southern oscillation, 1999. *J Appl Meteorol* 38, 1488–1498.

## RICE-MAIZE INTENSIFICATION IN ASIA – MERGING SCIENCE KNOWLEDGE FOR MODELING INTEGRATED CROP SYSTEMS

John Dixon<sup>1</sup>, Jagadish Timsina<sup>2</sup>, Achim Dobermann<sup>2</sup>, Roland Buresh<sup>2</sup>

<sup>1</sup>CIMMYT, El Batan, Mexico, [j.dixon@cgiar.org](mailto:j.dixon@cgiar.org)

<sup>2</sup>IRRI, Los Banos, Philippines, [j.timsina@cgiar.org](mailto:j.timsina@cgiar.org), [a.dobermann@cgiar.org](mailto:a.dobermann@cgiar.org), [r.buresh@cgiar.org](mailto:r.buresh@cgiar.org)

### Introduction

In the 1970s and 1980s the approach of designing “new farming systems” enjoyed brief popularity before being replaced by a pragmatic incrementalist approach to farming systems improvement (Collinson, 2000). We argue that the “new farming systems” design might once again have utility -- with the advance of science knowledge, advent of modern crop and farm modeling tools, the increasing complexity and dynamism of mixed farming, and above all the challenge to sustainably meet the demand for food, feed, and fuel on a decreasing resource base -- to identify feasible development options.

The challenge of sustainable intensification is greatest in Asia. With the exceptional growth of demand for livestock feed in Asia (Gulati and Dixon, in press), maize is expanding rapidly in many Asian farming systems. IRRI and CIMMYT scientists are merging their knowledge of maize and rice science, germplasm, and crop management to identify synergies between genetic improvement and management and the potential for sustainable intensification —avoiding the degradation trap into which many farming systems of Asia are falling (IRRI and CIMMYT, 2006).

Typical rice-maize (R-M) systems have been identified for characterization, modeling, and research. For example, in irrigated lowlands across Asia with water shortage or strong market potential for maize, maize is replacing dry season rice in traditional double rice cropping systems. In irrigated lowlands with triple rice cropping such as in the Mekong Delta of Vietnam, maize could be an option to replace the second rice crop. Consideration of this option is driven by water shortages and low yields of the second rice crop and by an outbreak of brown plant hopper in rice. In favorable rainfed lowlands, maize could be added as an additional crop following traditional wet season rice. There is strong potential to include maize in southern Chinese rice-based systems where maize consumption is high and in traditional rice-wheat systems of South Asia where demand for maize is expanding rapidly.

Both notional and computer modeling can play a significant role in envisioning and scoping rice-maize intensification pathways in different farming systems of Asia. Notional models facilitate the conceptualization of rice-maize integration, nutrient cycling, and probable threats to sustainability for subsequent testing with computer modeling and field research trials. This paper considers the potential and modalities for sustainable intensification of rice-maize (R-M) cropping systems in East, Southeast, and South Asia. An example from the Philippines is presented where there is potential to replace rice-fallow (R-F) and R-R systems with R-M and maize-rice (M-R) systems.

### Methodology

ORYZA2000 (Bouman et al., 2001) and Hybrid Maize (Yang et al., 2004) were used to simulate growth and yield of rice and maize, respectively, at locations across tropical, sub-tropical, and warm temperate Asian countries. The yield potentials ( $Y_p$ ) of rice and maize were estimated across 12 planting dates using 20 years of historical weather data. Rice varieties of four growth durations ranging from extra early (80-90 days) to late (125-140 days) were chosen. For maize, four hybrid maturities of 1500, 1600, 1700, and 1800 growing degree days (GDD) were selected. Based on the simulated  $Y_p$  of rice and maize, various combinations of rice varieties and maize hybrids were then examined for each location to identify optimum R-M systems with high potential productivity. The identified systems were further refined to optimally fit with the irrigation, risks of typhoon and soil waterlogging, and socio-economic features of the location. We present an example of  $Y_p$  and optimizations for R-M and M-R systems from Pila, Laguna, Philippines.

## Results

Mean Yp of rice was always higher for the dry season (1 December-1 June planting) than for the wet season (1 July-1 November planting). Mean Yp of four maize hybrids across planting dates ranged from 9.8 to 15.5 t/ha. As with rice, Yp was higher in the dry season (1 November- 1 April planting; 11.3 to 15.5 t/ha) than in the wet season (1 May-1 October planting; 9.8 to 13.5 t/ha).

The Figure below shows some options for optimum planting dates for intermediate duration rice (e.g., IR72) and a maize hybrid with 1600 GDD for R-M and M-R systems that incorporate consideration of optimum water use and risks due to typhoons in rice and waterlogging during crop establishment in maize. For R-M, the “optimum system” (shaded bars) would be planting rice from late May to early June and planting maize from late November to early December, with the total system Yp of 20.1 t/ha. This system would require less irrigation water for rice and would face less risk of typhoons. Analysis of 20 years (1984-2003) of rainfall data revealed that 1 December sown maize would receive rainfall ranging from 71 to 873 mm during the growing season and would require irrigation of about 0 to 100 mm per growing season. For M-R, maize planted from late April to early May and rice planted from late November to early December would be an “optimum system” with the greatest Yp of 20.8 t/ha. This system would require very little irrigation (0-54 mm) for maize due to high rainfall during the growing season (540-1293 mm) and would have less risk of typhoons in rice. Thus, as compared to the currently practiced R-F system (Yp, 7 t/ha) and R-R systems (Yp, 15.7 t/ha), Yp for R-M and M-R systems are much greater.

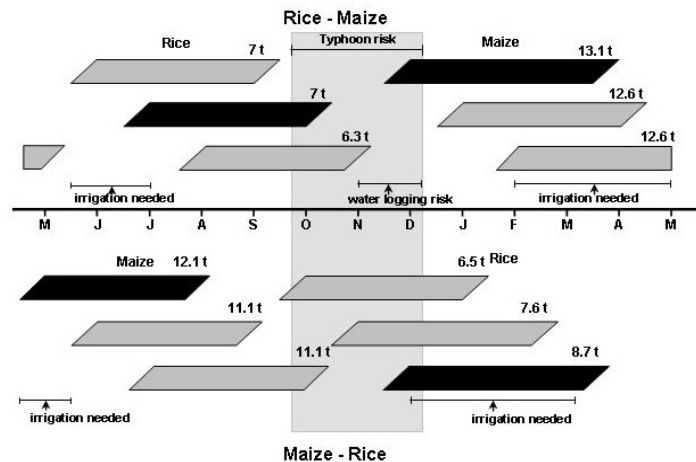

## Conclusions

An example from the Philippines illustrates the potential of models to estimate Yp and optimize R-M and M-R systems for high productivity based on biophysical considerations. Socio-economic considerations and economic analysis will be necessary for further refinement of these highly productive systems for acceptance by local farmers.

## References

- Bouman B. et al., ORYZA2000: modeling lowland rice, 2001. 235 p
- IRRI and CIMMYT, Rice-maize systems for improving the quality of life of Asia's poor, 2006. Unpublished document. IRRI-CIMMYT Alliance program on Intensive Production Systems in Asia
- Collinson M, The History of Farming Systems Research, 2000. FAO, Rome, Italy and CABI, Wallingford, Oxon, UK.
- Gulati A, Dixon J, (eds.) Maize in Asia: Changing Markets and Incentives, in press. Academic Publishers, New Delhi, India.
- Yang et al., Hybrid maize- a maize simulation model that combines two crop modeling approaches, 2004. Field Crops Res. 87, 131-154

## DESIGNING AND CONSTRUCTING IMPROVED CROPS: USING MODELS TO COPE WITH GENOTYPE X ENVIRONMENT X MANAGEMENT INTERACTIONS

C.D. Messina<sup>1</sup>, G.L. Hammer<sup>2</sup>, D. Podlich<sup>1</sup>, Z. Dong<sup>1</sup>, M. Samples<sup>1</sup>, M. Cooper<sup>1</sup>

<sup>1</sup> Pioneer Hi-Bred, a Dupont Business, Johnston, Iowa, USA, [charlie.messina@pioneer.com](mailto:charlie.messina@pioneer.com)

<sup>2</sup> Agricultural Production Systems Research Unit, Univ. of Queensland, Australia, [g.hammer@uq.edu.au](mailto:g.hammer@uq.edu.au)

### Introduction

Crop performance is determined by the genotype of the crop and the nature of the production system. Plant breeding seeks to improve crop performance by searching the genetic space for superior genotypes, while agronomy pursues the same goal by optimizing management for a cohort of elite genotypes developed by plant breeding. Historically, plant breeding and agronomy have co-evolved and both have contributed to improved crop performance. This iterative process, however, explores a reduced set of the vast space defined by the full set of possible genotype (G) and management (M) combinations. In addition, variable environmental (E) conditions interacting with G and M (G\*E\*M) complicate the definition of paths towards genetic gain and limit our ability to make inferences on the effects of management practices. The complexity of the G\*E\*M system and the difficulty of dealing with interactions simultaneously, has forced crop scientists to deal with interactions separately, most frequently as G\*E and M\*E. Advances in crop modeling, gene-to-phenotype (GP) mapping and computer science allow us to now contemplate the questions: Can we explore the G\*E\*M space more effectively? Can we leverage this knowledge and manage this complexity to develop improved crops? This paper examines past trajectories in over 50+ years of plant breeding for corn in the US Corn Belt, and uses a coupled crop system – breeding model to explore the possibility for searching this complex G\*E\*M space more effectively.

### Methodology

This study expanded the GP framework proposed by Hammer et al. (2005) to build a G\*E\*M system representative of past and present corn production in the US Corn Belt. Components of this framework were constructed by modeling adaptive traits based on their physiological determinants, linking genetic variation to those determinants, simulating corn phenotypes for relevant genotypes, managements and environments, classifying production environments, and simulating trait trajectories in genetic space for breeding programs conditioned to E and M.

Corn phenotypes were simulated for a range of plant densities, soil types, soil water content at planting, and 50 years of weather in central Iowa using APSIM-maize (Keating et al., 2003). A Pioneer proprietary module of APSIM-maize was developed to incorporate adaptive traits of interest. The module included concepts that link a) root angle (RA) and water extraction patterns (Hammer, pers. comm.), b) leaf angle (LA) and radiation use efficiency (Wright and Hammer, 1994), and c) carbon allocation to the ear (CA) and within the ear (Carcova and Otegui, 2007), silking dynamics and synchronism in pollination (SP) and kernel set (Echarte et al., 2004; Borrás et al., 2007). The model accounted for the co-regulation of kernel set and kernel size (Gambin et al., 2006). Genetic variation for each adaptive trait—LA, RA, CP, SP and maximum ear size (ME) - was prescribed using an additive genetic model based on 3 genes and 2 alleles per locus for each trait. This first approximation of the genetic architecture of the component traits is motivated by multiple QTL mapping studies. For this example the genetic model defines  $14 \times 10^6$  genotypes and  $16 \times 10^4$  expression states.

Production environments were classified based on water supply and demand patterns (Hammer et al., 2005) for a reference genotype. Using cluster analysis four environment types were identified: severe terminal stress (STS, 18%), mild terminal stress (20%), grain fill stress (25%), and no stress (NS, 37%). For each environment type and management, reciprocal recurrent selection with pedigree selection within two heterotic groups was simulated using QU-GENE (Podlich and Cooper, 1998). Trait trajectories in G space conditioned to E and M emerge from simulating such breeding program. Selection experiments were conducted under a unique environment and management (e.g. STS and 8 pl m<sup>-2</sup>), and for a sample of environments and plant populations.

### Results and Discussion



Figure 1b shows simulated genetic gains for yield for breeding under specific conditions relative to those attained if selection is performed sampling the target population of environments (TPE) using non specific management (8 and 12 pl m<sup>-2</sup>). For NS environments, simulated genetic gain differed little for selection performed in only NS environments or in the entire TPE. In contrast, genetic gains in STS environments were reduced when selection performed in the entire TPE and non specific management. These results suggest that incorporating knowledge on G\*E\*M into breeding can increase genetic gain and hasten crop improvement.

Analysis of field experiments demonstrates G\*E\*M interactions and their role in past genetic improvement. Simulated trait trajectories for selection in NS (Fig. 1a) are consistent with those observed for hybrids selected in North-Central US and Argentina (Echarte et al., 2004). Frequency of +alleles for LA, ME, CA and SP increased in successive cycles of breeding producing erect leaf type hybrids, with increased C allocation to the ear and increased kernel set. Selection in NS environments promoted improvements in resource use and reproductive efficiencies. In contrast, frequency of +alleles for LA decreased, and +alleles for RA increased in successive cycles of breeding when selecting for yield in STS. Conservative and enhanced resource capture dominated the trajectories, particularly during the first cycles (Fig. 1a).

This study demonstrates *in silico* the validity of a method to effectively explore the G\*E\*M state space, and the value of leveraging this knowledge to develop improved crops. The proposed framework for designing and constructing improved crops utilizes prediction of GP trajectories (Fig. 1a)—these become hypotheses for testing within the breeding program. This emerging breeding technology can help the seed industry to manage and adapt germplasm to effectively navigate through the G space producing improved hybrids that meet the needs of changing farming systems and environments.

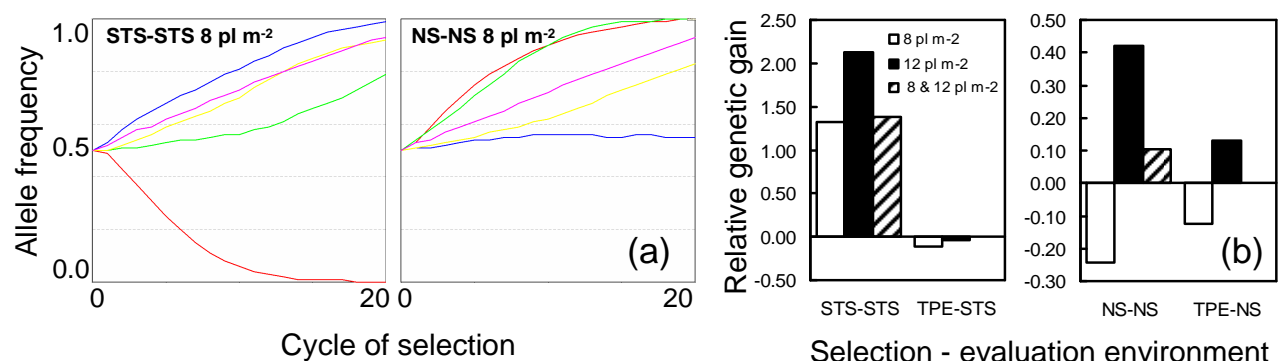

Figure 1 Mean changes in gene frequencies for +alleles associated with RA (--), LA (--), ME (--), CA (--) and SP (--) (a) and relative genetic gains for a set of selection experiments (b). Selection simulated for specific (8 or 12 pl m<sup>-2</sup>) and non-specific management (8 and 12 pl m<sup>-2</sup>) and STS, NS and TPE environments. For each management practice, genetic gains were evaluated in environments STS and NS. TPE-STS denote for selection in TPE environments and evaluation in STS environment type.

## References

- G.L. Hammer et al. Trait physiology and crop modeling as a framework to link phenotypic complexity to underlying genetic systems. 2005. *Aust. J. Agric. Res.* 56, 947-960
- B.A. Keating et al. An overview of APSIM, a model designed for farming systems simulation. 2003. *Eur. J. Agronomy*, 18, 267-288
- L. Echarte et al. Kernel number determination in Argentinian maize hybrids released between 1965 and 1993. 2004. *Crop Sci.*, 44, 1654-1661
- L. Borrás et al. Coupling time to silking with plant growth rate in maize. 2007. *Field Crops Res.* 102, 73-85
- J. Carcova and M.E. Otegui. Ovary growth and maize kernel set. 2007. *Crop Sci.* 47, 1104-1110
- B. Gambin et al. Source-sink relations and kernel weight differences in maize temperate hybrids. 2006. *Field Crops Res.* 95, 316-326
- G.L. Hammer and G.C. Wright. A theoretical analysis of nitrogen and radiation use efficiency in peanut. 1994. *Aust. J. Agric. Res.* 45, 575-579
- Podlich and Cooper. QU-GENE: a simulation platform for quantitative analysis of genetic models. *Bioinformatics* 14, 632-653

## MODELING PHENOLOGY OF SORGHUM BASED ON KNOWN MATURITY (*MA*) LOCI

J. W. White<sup>1</sup>, G. Hoogenboom<sup>2</sup>, M. Ottman<sup>3</sup>

<sup>1</sup> Arid Land Agricultural Res. Center, USDA,-ARS, Maricopa, AZ, USA, [Jeffrey.White@ars.usda.gov](mailto:Jeffrey.White@ars.usda.gov)

<sup>2</sup> Dep. Biological & . Agricultural Engineering, Univ. Georgia, Griffin, GA, USA, [gerrit@uga.edu](mailto:gerrit@uga.edu)

<sup>3</sup> Dep. Plant Sciences, Univ. Arizona, Tucson, AZ, [mottman@ag.arizona.edu](mailto:mottman@ag.arizona.edu)

### Introduction

Commercial sorghum (*Sorghum bicolor*) hybrids vary greatly in time of flowering. This variation affects productivity of both total biomass and grain yield. Cultivar differences in phenology largely result from variation in earliness *per se* (EPS) and photoperiod sensitivity (PPS). Inheritance studies by J.R. Quinby and colleagues (reviewed in Quinby, 1973; Morgan & Finlayson, 2000) identified a series of maturity loci that affect these traits, although it is unclear whether the loci affect both EPS and PPS or only the latter trait. Three loci, *Ma*<sub>1</sub>, *Ma*<sub>2</sub>, and *Ma*<sub>3</sub>, are especially important determinants of variation in phenology among commercial US cultivars.

Quinby (1973) developed near-isogenic lines for these loci, including for the allele *ma*<sub>3</sub><sup>R</sup>, which confers extreme earliness. The lines have been tested over a wide range of environments and planting dates, suggesting the possibility of simulating effects of the loci using approaches similar to those used for gene-based models of common bean (White & Hoogenboom, 1996) and proposed for wheat (White, 2006). Such a modeling approach might clarify the relative importance of EPS and PPS and facilitate testing scenarios of climate risk or global warming where variation in planting date and length of growing season are expected. This paper describes and evaluates initial progress in developing a gene-based sorghum model.

### Methodology

Effects of the *Ma* loci were characterized in terms of cultivar parameters in the CSM-CERES-Sorghum model (version 4.5 beta) using diverse datasets for 10 *Ma* lines developed by Quinby (1973; Table 1). CSM-CERES-Sorghum originated from CERES-Maize but shares many routines with the CSM-CROPGRO models (Jones et al., 2003). The model simulates development by integrating developmental rates over phase-specific durations. Depending on the phase, rates vary with temperature and/or photoperiod. A base temperature of 8°C is assumed. For all pre-anthesis phases, the optimal temperature is assumed to be 50°C. Hourly temperatures are reconstructed from daily values of maximum and minimum temperature. The short-day response assumes that development is slowed when the photoperiod (calculated based on civil twilight) is longer than the critical daylength (assumed 12 h in this study). Sensitivity is represented through the cultivar parameter P1R, the extent to which development prior to panicle initiation is delayed for each hour of photoperiod above the critical daylength. Cultivar parameters P1 and P3 determine the thermal or photothermal time from seedling emergence to end of leaf growth. For this paper, the duration from end of leaf growth to anthesis (P4) was assumed constant.

Data on time of panicle initiation and anthesis were obtained from studies discussed in Quinby (1973) and Morgan & Finlayson (2000). Daily weather data were retrieved from the U.S. NOAA Cooperative network and similar on-line sources. The studies generally reported near-optimal management of water, so for all experiments, no water balance was estimated, eliminating need for soil data.

Three model parameters were estimated, P1, P2R, and P3, using data from seven experiments ranging from Brazil to Wisconsin. P1 and P2R were determined based on time of panicle initiation. P3 was then estimated using time to anthesis and assuming that P4 was a constant 234°d. Goodness of fit was mainly judged from root mean squared errors (RMSE). The process was facilitated using the GenCalc2 program (L.A. Hunt, personal communication), which allows users to specify ranges of parameters to test for a given cultivar, runs the model for corresponding parameter values, and then calculates RMSE and other indicators of agreement.

Gene-based coefficients were estimated by linear regression, coding the *Ma*<sub>1</sub> and *Ma*<sub>2</sub> as 1 or 0 for dominant or recessive loci. For *Ma*<sub>3</sub>, where three alleles are known, *Ma*<sub>3</sub> and *ma*<sub>3</sub> were coded as 1 and *ma*<sub>3</sub><sup>R</sup> as 0, based on inspection of Table 1. The equations for P1 and P2R were:

$$P1 = 72.6 + 108.2 Ma_1\_Ma_2 + 69.5 Ma_3 \quad R^2 = .91^{**}$$

$$P2R = 23.9 + 101.8 Ma_1\_Ma_2 + 54 Ma_3 \quad R^2 = .94^{**}$$

where  $Ma_1\_Ma_2$  indicates an interaction between the two loci and  $Ma_3$  represent the coded values for the three alleles. P3 was assigned a value of 325°C because no gene effects were detected.

Of twelve possible genetic combinations, only four unique combinations of coefficients resulted. These were used to simulate days to anthesis for calibration and evaluation datasets.

## Results

The regressions for P1 and P2R suggested that both PPR and EPS are influenced by the three loci, although alternate explanations merit investigation. One is that photoperiod by temperature interactions are not considered. These may involve the  $Ma_3$  locus. Also, incorrect assumptions concerning the photoperiod response curve may be biasing estimates.

When used to simulate days to anthesis, the gene-based estimates performed similar to the original calibrations. For the evaluation data, the  $r^2$ -value for observed vs simulated days to anthesis was 0.61 for the gene-based coefficients and 0.67 using conventionally estimated coefficients ( $P < .001$ ,  $n = 120$  for simulations with each set of coefficients).

## Conclusions

The results indicate the potential benefit from moving toward gene-based approaches for characterizing cultivar differences in simulation models. Quinby's isogenic lines present a valuable opportunity for improving simulation of sorghum phenology and merit testing for a wider range of environments, including conditions of water and nutrient deficits. Parallel work might be undertaken with lines varying in the *Dw* loci, which affect plant height, including partitioning to stems.

## References

- Jones, J.W., G. Hoogenboom, C.H. Porter, K.J. Boote, W.D. Batchelor, L.A. Hunt, P.W. Wilkens, U. Singh, A.J. Gijssman, and J.T. Ritchie. 2003. The DSSAT Cropping System Model. *Eur. J. Agron.* 18:235-265.
- Morgan, P. W. & S. A. Finlayson. 2000. Physiology and genetics of maturity and height. p 227-259. In *Sorghum: History, Technology, and Production*. C.W. Smith & R. A. Frederiksen (eds.) John Wiley & Sons, New York.
- Quinby, J.R. 1973. The genetic control of flowering and growth in sorghum. *Adv. Agron.* 25:125-162.
- White, J.W., and G. Hoogenboom. 1996. Simulating effects of genes for physiological traits in a process-oriented crop model. *Agron. J.* 88:416-422.
- White, J.W., 2006. From genome to wheat: Emerging opportunities for modelling wheat growth and development. *Eur. J. Agron.* 25:79-88.

**Table 1.** Model parameters for phenology for near-isogenic lines developed by Quinby (1973).

Line	Genotype	Model parameter		
		P1	P2R	P3
100M	$Ma_1 Ma_2 Ma_3$	384	145	253
SM100	$ma_1 Ma_2 Ma_3$	196	64	302
90M	$Ma_1 Ma_2 ma_3$	312	157	304
SM90	$ma_1 Ma_2 ma_3$	114	79	346
80M	$Ma_1 ma_2 Ma_3$	231	100	349
SM80	$ma_1 ma_2 Ma_3$	164	75	366
60M	$Ma_1 ma_2 ma_3$	98	123	322
SM60	$ma_1 ma_2 ma_3$	129	77	384
38M	$ma_1 ma_2 ma_3^R$	49	9	296
44M	$Ma_1 ma_2 ma_3^R$	67	23	369

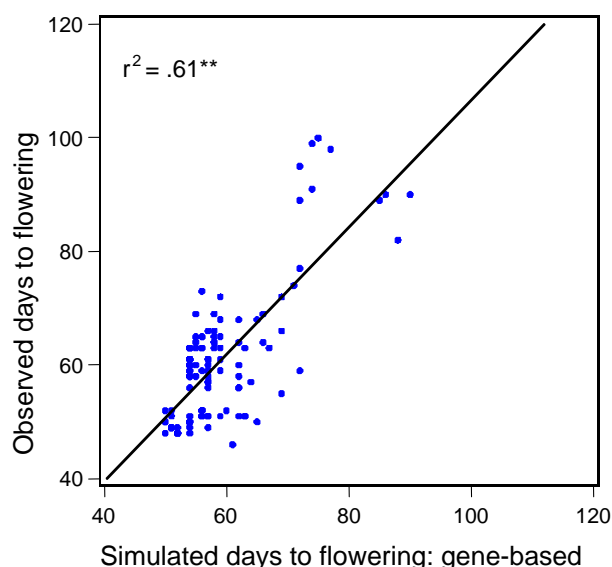

**Figure 1.** Comparison of observed vs simulated flowering using coefficients estimated from genotypes. Observed data are independent of those used in model calibration.

**Session 2.4:  
Production system sustainability and externalities**

**Session Convenors:  
Marcello Donatelli, Matthias Langensiepen and  
Jacques Wery**

## BIO ECONOMIC MODELING: LESSONS LEARNED ON OBSTACLES TOWARDS INTERDISCIPLINARITY

F. Affholder<sup>1</sup>, D. Jourdain<sup>2</sup>, E. Scopel<sup>1</sup>

<sup>1</sup> UMR System (Agro.M / CIRAD / INRA), Montpellier, France, [affholder@cirad.fr](mailto:affholder@cirad.fr), [scopel@cirad.fr](mailto:scopel@cirad.fr)

<sup>2</sup> UMR G-d'EAU (CIRAD/CEMAGREF/IRD) Montpellier, France- [damien.jourdain@cirad.fr](mailto:damien.jourdain@cirad.fr)

### Introduction

Farm decision models are established tools for studies of the impact of agricultural policies, technological innovation or more recently climate change, on production systems (Janssen et van Ittersum, 2007). Studying decision processes belongs clearly to social science, but it is more and more acknowledged that the relevancy of farm models strongly depends on the way they account for the biophysical processes involved in farming. Thus, farm modeling became recognized as a multidisciplinary job, as underlined by the rising, from about a decade, of the term “bioeconomic” to characterize it. This paper summarizes two case-studies involving farm modeling and draws lessons regarding issues linked to multidisciplinary – or more properly – interdisciplinarity.

### Methodology

The first case-study focused on an ex-post analysis of an agricultural revolution that occurred in central Brazil in the 90's. Indeed, many subsistence farms had turned into intensive dairy farms within a decade, their income being increased tenfold or more, whereas a significant number of other farms were left out of this development trend (Bainville et al., 2005). Our multidisciplinary team that studied this revolution considered the following hypothesis for explaining the differences between farm trajectories over time: (i) variations in risk aversion of farmers (ii) variations in market accessibility, (iii) variations in bank credit accessibility and (iv) variations in the biophysical environment of farms.

The second study was an ex-ante analysis of the feasibility of direct seeding mulch based cropping systems (DMC) in farms of a mountainous region of Vietnam. Agronomic trials had shown that return to land was generally higher and return to labor lower under DMC than under conventional management. Moreover, DMC would require changes in the management of farm's labor and cash over seasons.

In both studies we used linear programming technique to model the main types of farms identified in the studied regions. Information about farmers' goals, farm structures, and the technical coefficients of most activities was obtained through farm surveys carried out under the responsibility of farm economists. Field agronomists were in charge of providing technical coefficients specifically for crop activities, using trials in research centres and a network of monitored plots in farmers' fields. Farm models were first validated against real farms by comparing simulated with observed sets of activities, and then were run farm simulations specifically designed for testing the hypothesis at stake in each study. These simulations were in Brazil, sensitivity analysis of farm activities to market and weather variations, and in Vietnam, simulations in which DMCs were added to the list of possible activities.

### Results

The study in Brazil showed that soil constraints such as low water retention capacity could be severe enough to prevent subsistence farms of the region to follow the same pathway as farms on more favorable soils towards intensive and highly specialized dairy farms. Even considering a constant, low risk aversion, an equally favorable access to market and credit in the simulations, simulated farms on unfavorable soils would not choose dairy production based on intensive corn and fodder crops, highly risky on these soils, whereas simulated farms on favorable soils would do so. This was matching actual situations (Affholder et al., 2006).

The study in Vietnam showed that the simulated choice of adopting or rejecting DMC was variable across farm types and environments, and moreover that adoption was in most cases hampered by extra requirements of DMC in labor and cash, as compared to conventional farming. Biomass available in situ for mulch establishment at the start of the rainy season had indeed to be completed with biomass collected in the neighboring environment, for the mulch to effectively

control weeds and erosion. This resulted in extra labor requirements at a peak period for labor. Extra fertilizer amounts were also required under DMC.

The results of the study in Brazil were rather disappointing for social scientists of the team, whereas it was so for agronomists in the Vietnamese case. In the study in Brazil, economists were expecting economic and social constraints to be preeminent over biophysical constraints in determining the dynamics of farming systems in the studied region. Preliminary simulations using rough biophysical data were actually supporting this hypothesis which eventually proved to be erroneous. Indeed the agronomists in the team did not endorse these preliminary results especially since the simulated solution appeared to be highly dependant to changes in agronomic data within their confidence interval. But it took several years of crop modeling for the agronomists to improve the precision, up to a "satisfactory level", of the biophysical data provided to the farm model. We must also admit that we did not define objectively this "satisfactory level". It rather resulted from a compromise between the will of the agronomists to increase the accuracy of their crop models and the will of the farm economists to match the deadlines of the project and be available for something else.

In the study in Vietnam, field agronomists were expecting DMCs to be economically attractive to the well informed, rationale farmers that were idealized in the farm models. As the sensitivity analysis showed that increasing the accuracy of the biophysical data would not change the results of farm simulations, at least some of the agronomists involved in the research suspected the farm models built or even the linear programming method to be inappropriate. Efforts from the rest of the team to re-check the model and discuss the method as thoroughly as possible did not prevent some of the agronomists from rejecting the conclusions of the study and leaving the team.

## Conclusions

First, in such bioeconomic modeling studies of farm strategies, the fact that outputs of crop models serve as inputs to farm models brings asymmetry in the way one discipline, farm economy, relies on the work of the other, field agronomy. Second, change in scale from field to farm implies changes in the hierarchy of processes to account for, but no fully objective procedure is available for doing so. In a team working under the pressure of deadlines, the farm economist is likely to impose his own views on the hierarchy of processes at stake, and to apply pressure on the crop modeler for delivering his outputs: a kind of hierarchal relationship between disciplines that jeopardizes interdisciplinarity and hence the relevance of the overall study.

In order to overcome these difficulties more research is needed, focusing on more objective procedures for shifting from field to farm scale. As for the development of any model, sensitivity analyses are expected to play a key role in identifying the components of the bioeconomic models that have to be improved for a given study. More specifically, the study of error propagation from biophysical models to farm decision models should be the major criteria for refining or not the biophysical model. It is likely, however, that advances in procedures and tools will not suppress all subjectivity from bioeconomic studies. As a consequence, their results should not be used in a prescriptive way but rather as a basis for discussions among stakeholders in order to enhance their common understanding of the studied systems, as proposed for example by Barreteau et al. (2003).

## References

- F. Affholder, Assad ED, Bonnal P *et al.* Risques de stress hydrique dans les Cerrados Brésiliens. Du zonage régional à l'analyse des risques à l'échelle des exploitations familiales. *Cahiers Agricultures* 2006; 15: 433-9.
- S. Bainville, Affholder F, Figuié M, Madeira Neto J. Les transformations de l'agriculture familiale de la commune de Silvânia : une petite révolution agricole dans les Cerrados brésiliens. *Cahiers Agricultures* 2005; 14: 103-10.
- S. Janssen, van Ittersum MK. Assessing farm innovations and responses to policies: A review of bio-economic farm models. *Agricultural Systems* 2007; 94: 622-36

## Nutrient balance and groundwater quality of conventional, integrated and organic farming systems

Polese R.<sup>1</sup>, Lugato E.<sup>2</sup>, Berti A.<sup>3</sup>, Morari F.<sup>4</sup>, Giardini L.<sup>5</sup>

- <sup>1</sup> Dep. of Environmental Agronomy and Crop Science, Univ. Padova, Italy, riccardo.polese@unipd.it  
<sup>2</sup> Dep. of Environmental Agronomy and Crop Science, Univ. Padova, Italy, emanuele.lugato@unipd.it  
<sup>3</sup> Dep. of Environmental Agronomy and Crop Science, Univ. Padova, Italy, antonio.berti@unipd.it  
<sup>4</sup> Dep. of Environmental Agronomy and Crop Science, Univ. Padova, Italy, francesco.morari@unipd.it  
<sup>5</sup> Dep. of Environmental Agronomy and Crop Science, Univ. Padova, Italy, luigi.giardini@unipd.it

### Introduction

In the past decade the public administrations in Northern Italy have encouraged the spread of sustainable farming systems, i.e., those that guarantee high production standards which respect the environment, through agricultural policies and targeted funding programs. Regional applications of the European Community (EC) regulation are part of this plan.

To evaluate the effects of different farming systems on groundwater quality, a field survey was conducted for 3 subsequent years, evaluating the groundwater quality under fields cultivated with the main herbaceous crops of Veneto Region.

### Methodology

Twenty-four fields distributed across Veneto Region (4 Conventional - **CA**, 14 cultivated following the prescription of the Rural Development Plan of Veneto Region for Integrated agriculture - **IA** and 6 Organic - **OA**) were monitored in the years 2004, 2005 and 2006 (Fig. 1). The impact of cropping systems was evaluated in terms of groundwater quality. Groundwater was sampled monthly by mean of a piezometer placed in the centre of the field (ASTM, 1994) (total 469 samples) and analyzed for NO<sub>3</sub>-N and total N, total and PO<sub>4</sub>-P. For each year, crop yields were monitored and both marketable yield and total aerial biomass were analyzed for N and P content, in order to compute macronutrient balances.

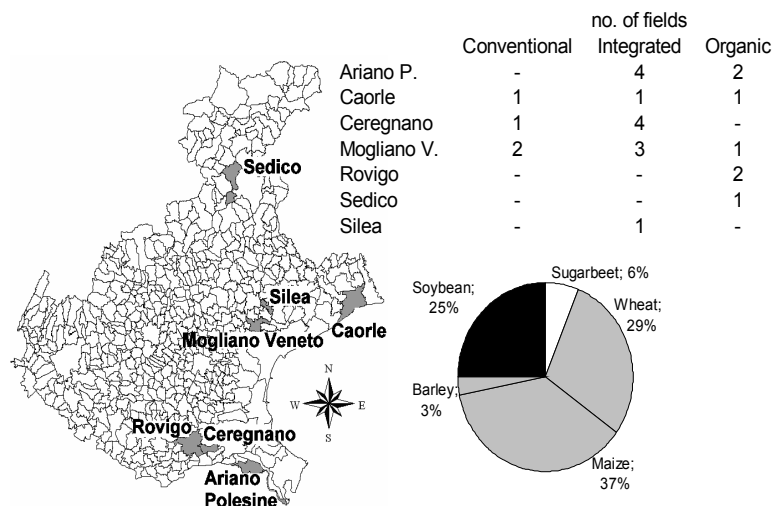

Fig. 1: localisation of the fields, types of agriculture adopted and repartition of the considered crops

### Results

According to fertilisation type and pedoclimatic conditions, the nutrient balance showed a wide variation (Fig. 2). N balances were higher in CA, but were strongly positive also in OA, due to their lower productivity. Also P balance was heavily influenced by the farming systems considered, with OA presenting the lower median values but also a wide variability.

Groundwater quality proved to be highly variable across environments (Fig. 3). On the whole, 24 samples (5.1% of the total) presented a NO<sub>3</sub>-N concentration higher than the drinking water standard (11.3 mg l<sup>-1</sup>). In IA, 17 samples exceeded the thresholds (7.3% of the IA samples), while 5 OA samples from (3.4% of the OA samples) presented high nitrate concentrations. In both cases, the highest values were observed in a couple of locations, presenting low quality groundwaters, independently from the agricultural practices adopted. On the average, the highest nitrate concentrations were nevertheless observed under CA (median value of 1.36 mg l<sup>-1</sup> against 0.92 mg l<sup>-1</sup> for IA and 0.70 mg l<sup>-1</sup> for OA).

Total P concentrations presented a wide variation. For this parameter CA and IA fields showed very similar values, while the OA fields presented higher average values as well as a wider dispersion.

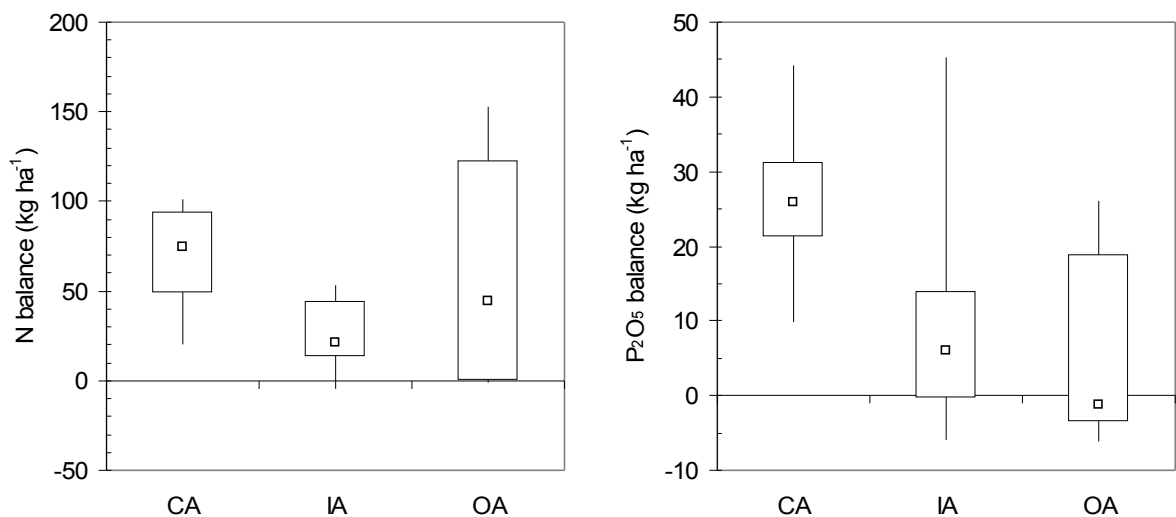

Fig. 2: Average N and P balances

**Conclusions**

Groundwater pollution showed a weak relationship with nutrient balances for both N and P. Nitrate concentration in groundwaters seems to be more affected by local pedo-climatic conditions than from the agricultural load. On the other hand, P concentrations were generally higher under OA fields. This can be related to the N:P ratio of organic fertilisers, which is lower than the absorption ratio of most crops, leading to an accumulation of P in soils when the fertilisation is calibrated considering only the crop N requirements. Particularly for Organic systems a proper phosphorous management strategy seems then necessary to limit the risks of eutrophication of water bodies.

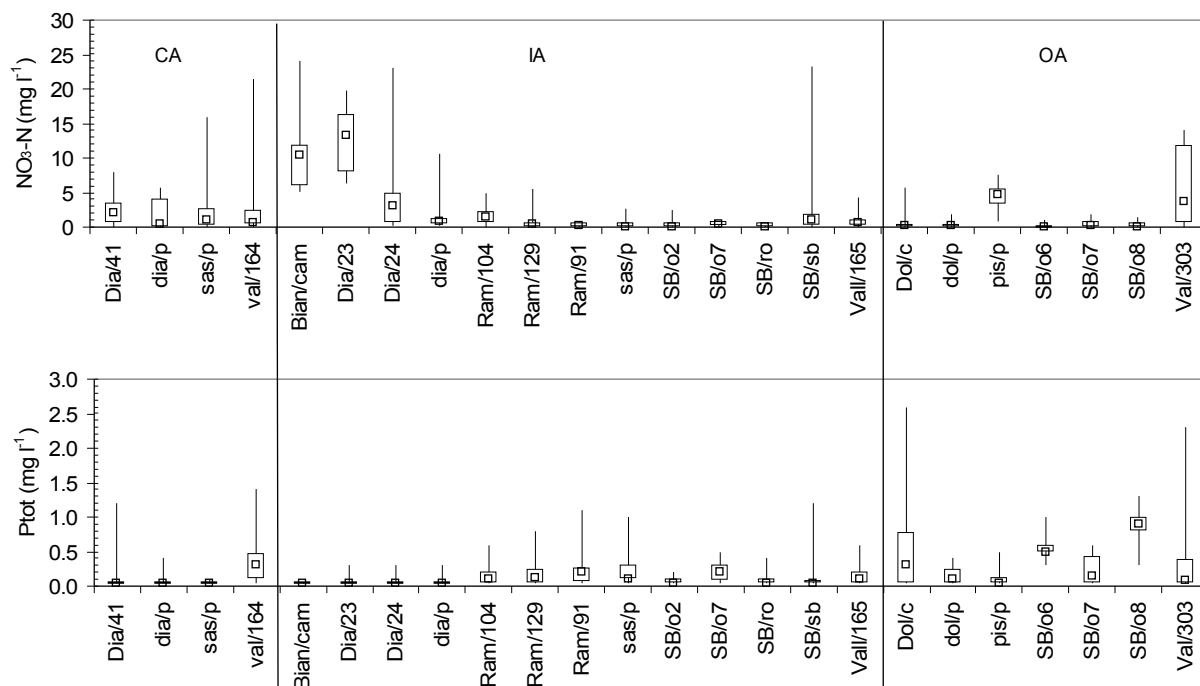

Fig. 3: Observed NO<sub>3</sub>-N and total P concentrations in groundwaters. □ = median value of the sampling period.

**References**

ASTM. Standard Guide for Sampling Groundwater Monitoring Wells, D4448-85a (reapproved 1992). 1994 In: ASTM Standards on Ground Water and Vadose Zone Investigations. ASTM, Philadelphia, PA, pp. 193-206.



## CHANGES IN SOIL FERTILITY IN AN ORGANIC AND A CONVENTIONAL FARMING SYSTEM OVER A LONG-TERM CROP ROTATION

A. Boldrini, G. Gigliotti, F. G. Erriquens, D. Businelli, M. Guiducci

Dep. Agricultural and Environmental Sciences, Univ. Perugia, Italy, [arianna.boldrini@agr.unipg.it](mailto:arianna.boldrini@agr.unipg.it)

### Introduction

Organic farming has expanded rapidly in recent years and is seen as sustainable alternative to intensive agricultural systems (Stockdale et al., 2001). If it is to be truly sustainable, it must maintain sufficient levels of soil fertility for economic crop production in the long-term, whilst also protecting the environment. Nutrient management in organic systems is based on fertility building through atmospheric nitrogen fixation, combined with recycling of nutrients via bulky organic materials, such as farmyard manure and crop residues, with only inputs of permitted fertilizers. However organic systems have been criticized for relying on reserves on soil phosphorus built up by fertilizer additions prior to organic management (Nguyen et al., 1995; Løes and Øgaard, 2001). This research is aimed to evaluate indicators for soil quality changes of an organic and a conventional low input farming system over a long term crop rotation.

### Methodology

An experiment was started in 1998 at Perugia (Italy, 43°N, 165 m a.s.l.) to compare an organic (ORG) and a conventional low input (CONV) farming system in two contiguous fields, both clay loam, pH 7.8 and with same organic matter content (15 g kg<sup>-1</sup>). Both fields were divided in six sectors (A1, A2, B1, B2, C1, C2) to reproduce the steady-state running in a farm of a 6-year rotation and test several food crops contemporaneously. In each system a randomized block design was adopted. The same sequence of cash crops was adopted in both systems (Table 1).

Table 1: Six-year rotations in six field sectors for organic (ORG) and conventional low input (CONV) systems. Green manures (GM) were used in ORG and CONV until 2000, only in ORG afterwards.

Field sectors	Years					
	1999	2000	2001	2002	2003	2004
A1	common bean	spelt	GM1+maize	GM4+soybean	GM1+pepper	wheat
A2	common bean	wheat	GM1+pepper	GM4+maize	GM1+tomato	Wheat
B1	field bean	GM3+pepper	pea	wheat	GM2+maize	GM3+tomato
B2	field bean	GM3+maize	field bean	wheat	pea	GM3+pepper
C1	GM1+pepper	common bean	spelt	GM1+tomato	wheat	field bean
C2	GM1+millet	common bean	wheat	GM1+pepper	wheat	GM1+maize

GM1: field bean; GM2: field bean+rapeseed; GM3: hairy vetch; GM4: barley.

The nutrients supplied was assured by green manure, poultry manure (4-4-3), rock phosphate (P<sub>2</sub>O<sub>5</sub> 17% soluble in formic acid 2% concentrated) and potassium sulfate (50% K<sub>2</sub>O) in the ORG system; in the CONV one by green manure (until 2000) and mineral fertilizers. Above ground biomass accumulation of any crop and its partitioning between marketable yield and biomass incorporated into the soil (crop residues+green manures) were determined at the end of each crop cycle; the soil total organic carbon (TOC g kg<sup>-1</sup>), humification ratio (HR%) that is the ratio: (humic + fulvic acids)/TOC; water extractable organic carbon (WEOC mg kg<sup>-1</sup>); available phosphorus (P) (mg kg<sup>-1</sup>) and phosphodiesterase activity (μmol p-NP g<sup>-1</sup>h<sup>-1</sup>) were determined at the end of the 6-year crop rotation (0-0.20 m soil cores) per each sector. Data were submitted to analysis of variance according to a hierarchical design (crops within systems).

### Results

After 6-year of crop rotation, as an average of the six field sectors and the six years, the results show that both the total biomass produced per year and the incorporated biomass was higher in

ORG system than in CONV one (+13% and +26% respectively) (Table 2). In fact every year in ORG system were cultivated, in addition to the cash crops, green manures before summer cereal and vegetables that increase the total and residual biomass produced. The biomass partitioning, in ORG system shows that the incorporated biomass (crop residual+green manures) represents the 74% of the total produced, while in CONV system the 66%. As a consequence the marketable yield was 12% lower in ORG (Table 2). This is probably due to a lower availability of nutrients during the crop cycle with the use of permitted fertilizers in organic farming and to a higher competition of weeds in ORG system than in CONV (particularly for summer grain legumes) which are difficult to control by mechanical means.

Table 2: Means of total, incorporated biomass and marketable yield for 6 years and six field sectors in organic (ORG) and conventional low input (CONV) farming systems after six-years of crop rotation.

<b>Systems</b>	<b>Total Biomass</b> (t ha <sup>-1</sup> d.m.)	<b>Incorporated Biomass</b> (t ha <sup>-1</sup> d.m.)	<b>Marketable Yield</b> (t ha <sup>-1</sup> d.m.)
ORG	12.9	9.5	3.4
CONV	11.4	7.5	3.9
<i>Pooled SD</i>	<i>1.34</i>	<i>1.21</i>	<i>0.46</i>

The soil quality parameters at the end of 6-years crop rotation (Table 3) show interesting behavior between the two systems. Even if no significant differences were noticed for TOC and HR, a change in the soluble organic matter occurs (21% higher in ORG). This could be due to the higher biomass incorporated in ORG. In fact in the plant tissues is present a high quantity of simple organic molecules that increase the water soluble organic matter content in the soil.

Table 3: Total organic carbon (TOC); humification ratio (HR); water extractable organic carbon (WEOC); available P and phosphodiesterase activity in the 0-0.20 m soil layer for organic (ORG) and conventional low input (CONV) farming systems after six-years of crop rotation.

<b>Systems</b>	<b>TOC</b> (g kg <sup>-1</sup> )	<b>HR</b> (%)	<b>WEOC</b> (mg kg <sup>-1</sup> )	<b>Available P</b> (mg kg <sup>-1</sup> )	<b>Phosphodiesterase Activity</b> (μmol p-NP g <sup>-1</sup> h <sup>-1</sup> )
ORG	11.01	25.44	51.33	18.57	57.94
CONV	10.94	28.29	42.48	23.71	48.75
<i>Pooled SD</i>	<i>0.049</i>	<i>6.001</i>	<i>9.554</i>	<i>3.595</i>	<i>4.190</i>

The available P concentration is generally expected higher in organic systems, on the contrary, in this case, resulted lower in ORG than in CONV (-22% on average). In this research in ORG system the maximum quantity of phosphate was added as Ca triphosphate that, in this soil with a sub-alkaline pH value, tends to transform to very insoluble forms as apatites. The phosphatase activity, instead, was higher in ORG where the final product of reaction (available P) was less concentrated and where the substrate for enzyme activity (organic P) was higher.

## Conclusions

In this research, the organic system, compared with the conventional low input, improved some of soil properties, but it reduced P soil reserves. In our soil, for organic system, in order to maintain an adequate P soil concentration, it is probably necessary to supply the element in organic forms.

Research funded by the FISIR SIMBIO – VEG Project (2005-2008).

## References

- A. K. Løes et al., Long-term changes in extractable soil phosphorus (P) in organic dairy farming systems, 2001. *Plant Soil* 237, 321-332.
- M. L. Nguyen et al., Nutrient budgets and status in three pairs of conventional and alternative mixed cropping farms in Canterbury New Zealand, 1995. *Agric. Ecosyst. Environ.* 52, 149-162.
- E. A. Stockdale et al., Agronomic and environmental implications of organic farming systems, 2001. *Adv. Agron.* 70, 261-325.

## THE ALTERNATIVE CROPPING SYSTEMS STUDY AT SCOTT SASKATCHEWAN, CANADA.

S.A. Brandt<sup>1</sup>, A.G. Thomas<sup>1</sup>, O.O. Olfert<sup>1</sup>, and R.P. Zentner<sup>2</sup>

<sup>1</sup> Agriculture and AgriFood Canada Saskatoon Research Centre, Saskatoon, Canada.

[BrandtS@agr.gc.ca](mailto:BrandtS@agr.gc.ca) ; [THOMASAG@agr.gc.ca](mailto:THOMASAG@agr.gc.ca) ; [OLFERTO@agr.gc.ca](mailto:OLFERTO@agr.gc.ca)

<sup>2</sup> Agriculture and AgriFood Canada Swift Current Research Centre, Swift Current, Canada.

[ZENTNERR@agr.gc.ca](mailto:ZENTNERR@agr.gc.ca)

### Introduction

Most of the grassland ecozone of the Canadian Prairies has been cultivated with only small remnants of native prairie remaining. Climatic limitations favour production of small grain cereals, cool-season oilseeds and pulses, and perennial forages. Economic constraints dictate that most land is used for grain crop production with livestock production on marginal land. Enhancing soil quality and providing economic stability are the basis of cropping systems that minimize tillage and summer fallow (Campbell and Zentner.1993) and grow a diversity of adapted crops (Brandt and Zentner 1995). Environmental concerns over chemical inputs and movement of their residues to non - target areas drive efforts to reduce reliance on such inputs. Such diversified lower input systems are considered necessary to meet challenges to farming systems in future.

Well designed long term agro-ecosystem experiments provide the best tools to reliably predict the impact of agricultural practices on the land resource and the environment (Rasmussen et al 1998). They serve also to guide development of more appropriate alternatives, and provide early indications of potential problems. Long term rotation and fertility studies (Mitchell et al. 1991.) focus on components of cropping systems but very few study whole cropping systems or agro-ecosystems, and none existed in the Canadian prairie region.

This paper describes the rationale behind initiating an ongoing cropping system experiment as well as describing how the study is structured and managed, including management of data. The focus of this long term study was to provide guidelines for the development of sustainable crop production systems on the Canadian Prairies based on principles of sustainable land management (Smyth and Dumanski, 1993).

### Methodology

To advance understanding of whole systems, a multi disciplinary team of scientists with expertise in soils, agronomy, economics, pest management and biodiversity was assembled to design and conduct the study. To ensure that results were broadly applicable and to minimize costs of multiple locations we selected a site with moderate organic matter, on a medium textured soil in an area that typically experienced moderate moisture stress. To understand site variability and baseline values we characterized soil and biotic conditions on the site prior to initiating the study. These measurements were used to measure change over time and as co-variates in some statistical analyses. The experiment was designed to facilitate proper replication, randomization and accommodated all phases of cropping systems studied. Plot sizes were sufficiently large to accommodate field scale equipment, and destructive sampling as needed. This involved applying input treatments to main plots, with cropping diversities applied to sub plots that included all phases of the six year rotations used in the 16 ha study. At the end of each six year cycle, appropriate changes to the study were incorporated based on discussions between collaborating scientists and other advisors. Database design considerations included ensuring that all data is reported in a timely manner, that integrity of the data is not compromised, that the data is readily available to collaborating scientists and that the data can be readily manipulated, analysed and managed.

Since reducing reliance on inputs and diversifying what is grown were being touted as the best strategies to deal with sustainability of agriculture, incorporated them as major factors. It was also

decided that we should evaluate systems that represented the extremes as well as one moderate option with regard to inputs and cropping diversity. From this we developed a matrix of three levels of inputs each applied over three levels of cropping diversity, for a total of 9 primary treatments.

The input systems were defined as HIGH, REDUCED and ORGANIC. In the HIGH system, inputs of tillage, fertilizers and pesticides were used based on conventional recommendations in response to issues as they arose. The REDUCED system attempted to reduce reliance on inputs by minimizing tillage and managing fertility and pests more intensively. The Organic system was based on use of those inputs permitted on a certified organic farm.

The low [LOW] diversity system was 2/3 wheat 1/6 oilseed and 1/2 fallow, while the Diversified Annual Grains [DAG] was based on a diversity of cereal, oilseed and pulse grain crops. The diversified annual and perennial (DAP) rotation used an oilseed-wheat-barley-alfalfa- alfalfa-alfalfa sequence.

## Results

Results to date demonstrate that:

- yield for ORGANIC was 30-40% lower than for HIGH/REDUCED.
- ORGANIC price premiums typically more than offset lower yield.
- Net energy production is greater for HIGH/REDUCED than ORGANIC, but energy output to input ratio is greater for ORGANIC.
- Legume crops replace N in ORGANIC systems, but P removal exceeds replacement and is a major yield limiting factor in ORGANIC systems.
- Biodiversity is enhanced by reduced tillage with REDUCED and to a lesser extent by elimination of pesticides with ORGANIC.

## Conclusions

The design of the experiment has proven effective for the study of the effects of inputs and cropping diversity on sustainability of farming systems.

## References

- Brandt, S.A. and R.P. Zentner. 1995. Crop Production under alternate rotations on a dark brown Chernozemic soil at Scott, Saskatchewan. *Can. J. Plant Sci.* 75:789-794.
- Campbell, C.A., Zentner, R.P. 1993. Soil organic matter as influenced by crop rotations and fertilization. *Soil Sci. Soc. Am. J.* 57(4): 1034-1040.
- Mitchell, C.C., et al., 1991. Overview of long-term agronomic research. *Agron. J.* 83:24-29.
- Rasmussen, P.A., et al., 1998. Long-term agroecosystem experiments: Assessing agricultural sustainability and global change. *Science.* 282: 893-896.
- Smyth, A.J. and Dumanski, J. 1993. World Soil Resources Report #73. FESLM: An International Framework for Evaluating Sustainable Land Management. Land and Water development Division. Food and Agriculture Organization of the United Nations. 76 pp.

## SUSTAINABILITY SOLUTION SPACE USING AGRO-ECOLOGICAL INDICATORS AT FIELD LEVEL

N. Castoldi<sup>1</sup>, L. Bechini<sup>1</sup>, J. Steinberger<sup>2</sup>, C.R. Binder<sup>2</sup>

<sup>1</sup> Dep. of Crop Science, Univ. of Milano, Italy, [nicola.castoldi@unimi.it](mailto:nicola.castoldi@unimi.it)

<sup>2</sup> Dep. of Geography, Univ. of Zurich, Zurich, Switzerland, [cbinder@geo.unizh.ch](mailto:cbinder@geo.unizh.ch)

### Introduction

The objective of this work is to evaluate the economic and environmental sustainability of cropping and farming systems in the Sud Milano Agricultural Park (Italy), applying the Sustainability Solution Space for Decision-Making (SSP; Wiek and Binder, 2005). We base our analysis on the results of 2-year interviews carried out in seven farms of different types (Castoldi and Bechini, 2007). With this methodology, we are evaluating which kinds of cropping systems are inside or outside the sustainability space.

### Methodology

We have selected a sub-set (14) of the 24 indicators calculated at field level (131 fields analyzed) (Castoldi and Bechini, 2007). They describe: i) economic performance (gross income, variable cost [VC]), economic efficiency [EcE], ii) soil management (crop sequence indicator [CSI], soil cover index, soil organic matter indicator [SOM]), iii) nutrient management (N and P balances [NB, PB]), iv) energy use (energy input [EI], output and efficiency), and v) pesticide application (load index for crustaceans [Llc], fish [Llf] and rats).

To consider the interactions and trade-offs among these indicators, we applied the SSP method, where a solution space for sustainability is calculated based on the sustainability ranges of the selected indicators and on their functional relationships. This solution space guides decision-

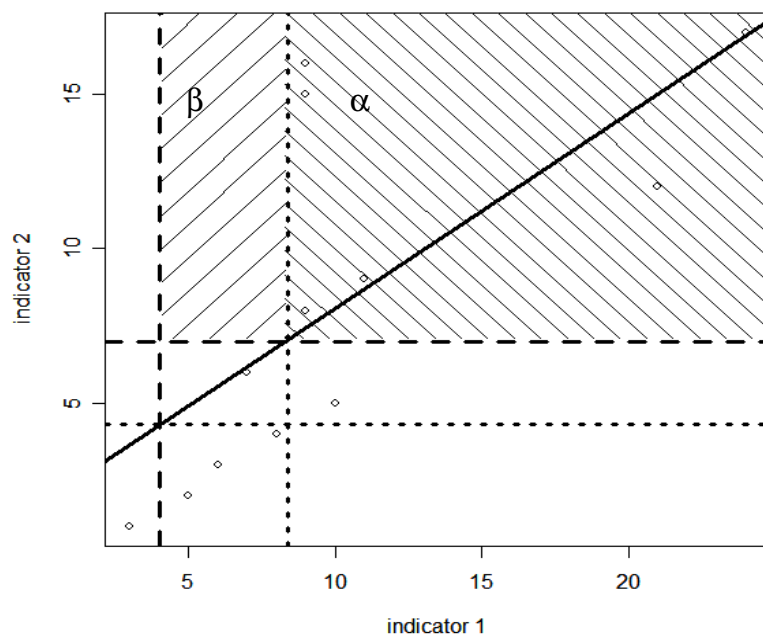

**Fig. 1 – Example of SSP method.**

**Solid line: regression line between indicators; dashed line: initial range (sustainability thresholds); dotted line: intersect range; area  $\alpha + \beta$ : initial sustainability range; area  $\alpha$ : final sustainability range.**

making by providing a realistic set of possible system states. After the selection of crucial system indicators, upper and/or lower bounds for sustainability are then defined for each indicator (dashed line, Fig. 1). The initial sustainability space ( $\alpha + \beta$ , Fig. 1) thus resembles an N-dimensional rectangle. However, the functional relationships between the indicators in fact limit this space. The next step is thus to take into account the functional relationship between the indicators, which could be a linear correlation, as shown in Fig. 2a, or a more complex relationship as in Fig. 2b and 2c.

Based on these relationships (correlations and trade-offs), a sustainability solution space is found ( $\alpha$ , Fig. 1). A linear correlation can serve to determine new sustainability upper or lower bounds, as in Fig. 1, whereas a

more complex relationship will result in a more complex, non-rectangular space. This space can then be used to find optimum system states, taking into account indicator trade-offs and correlations.

We have developed an optimization software that uses the functional relationships between indicators, providing the SSP space. For each indicator, we defined thresholds identifying complete sustainability and unsustainability values. It is not possible to define an intermediate range with partial sustainability, because the actual version of the software is not able to use this information. To study the functional relationships within the cropping systems, we have calculated the linear regression equation between 91 pairs of indicators. For each pair, if the  $R^2$  was bigger than 0.7, the relation between the two indicators was the regression equation (Fig. 2a). If the  $R^2$  was between 0.5 and 0.7, the relationship was not defined with a line but with the area delimited by the parallels of the regression equation. The distance between the parallels was equal to the maximum difference between the regression function and the confidential interval ( $p=99.9999\%$ ; Fig. 2b). In the cases with  $R^2 < 0.5$ , we delimited a squared area defined by the tangent to the ellipse that included 90% of the values (Fig. 2c).

## Results

Only five indicator pairs have a  $R^2 > 0.7$  (Table 1) and four have  $R^2$  from 0.5 to 0.7. The reason is that in general most of the selected indicators are independent from the others. Indeed, they are able to describe different aspects of field sustainability in different compartments. The information provided by different indicators has a small replication of information, because the behavior of each indicator is generally independent from the others.

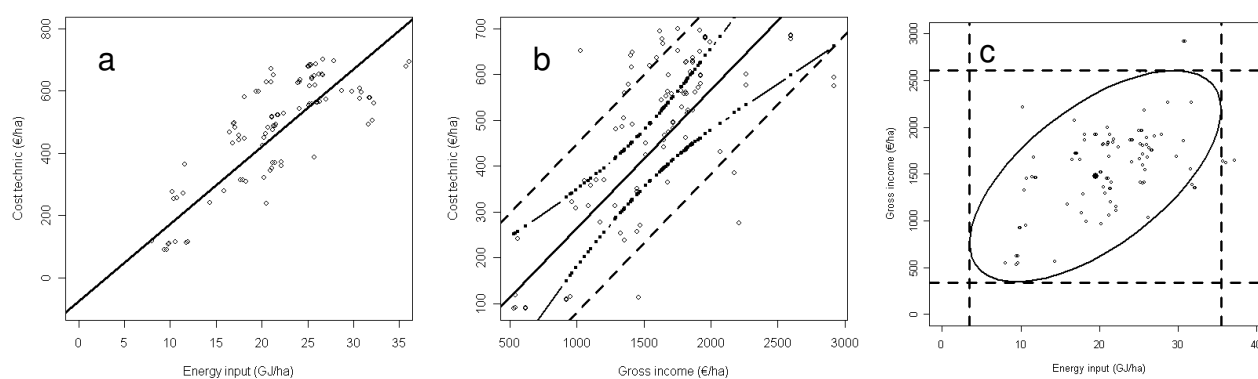

**Fig. 2 – Examples of relationships between indicators, with  $R^2 > 0.7$  (a), from 0.5 to 0.7 (b), and  $< 0.5$  (c). Solid line: regression (a and b), or ellipse that include the 90% of the indicator value pairs (c). Dashed line: empirical probable area between pairs of values. Bullet line: confidential interval.**

**Table 1 – Regression coefficients between pairs of indicators**

Indicator 1	Indicator 2	$R^2$
VC	EI	0.76
VC	CSI	0.78
EcE	SOM	0.75
NB	PB	0.72
Llc	Llf	0.70

## Conclusions

We are currently working on the integration of these relationships with the ranges of sustainability, to identify sustainable combinations of indicators for cropping systems management, i.e. when indicator values are inside the sustainability area ( $\alpha$ , Fig. 1). In addition, it will be possible to understand in which direction it is necessary to drive the farmers' management in order to improve sustainability. This will be done while respecting the functional relationships

described by the realistic range between pairs of indicators.

## References

- N. Castoldi, L. Bechini, Cropping systems sustainability with agro-ecological and economic indicators, 2007. *In*: These proceedings: Farming Syst. Design, Catania, Italy. 10–12 Sept.
- A. Wiek, C.R. Binder, Solution spaces for decision-making. A sustainability assessment tool for city-regions, 2005. *Environ. Impact Assessment Rev.* 25, 589–608.

## SOIL EROSION AND RUNOFF NUTRIENT LOSSES AFFECTED BY DIFFERENT CROPPING SYSTEMS IN SICILY

S. L. Cosentino, M. Mantineo, V. Copani, P. Guarnaccia

Dipartimento di Scienze Agronomiche, Agrochimiche e delle Produzioni Animali. Sezione Scienze Agronomiche, via Valdisavioia 5, 95123 Catania, Italia tel. 095-234480 fax 095-234449 e-mail: [cosentin@unict.it](mailto:cosentin@unict.it)

### Introduction

In Mediterranean environment the high intensity of autumnal rains determines high level of soil erosion losses in agricultural field reducing the soil fertility in the long run. In Sicily region this phenomenon have been emphasised by the crop management and by the orography of the territory. In order to study the influence of different cropping systems to soil erosion a ten years research was carried in a hilly area of the Sicily island using experimental plots equipped to determine surface runoff and soil losses.

### Methodology

Since 1996 in a representative area of the internal hill of Sicily region, mainly devoted to durum wheat, twelve cropping systems with perennial crops (Medicago arborea; alfalfa; Lolium multiflorum; subterranean clover) and annual crop (wheat - faba bean, wheat -set aside; rapeseed - wheat; faba bean - wheat; wheat - fallow; wheat - wheat) with different soil tillage were studied on experimental plot (40 x 8 m) isolated and equipped to collect runoff and soil losses. At each rainfall determining runoff, the total amount of runoff was measured in each container and samples of runoff were collected from each container and oven dried at 105°C in order to determine the amount of sediments.

### Results

Throughout the ten years of the experiments 77 rainfalls causing runoff and soil loss were registered. These rainfalls were mainly distributed between the month of

Tab. 1 - Number of rainfalls, soil loss in all the plots and soil loss per rainfall in the total of plots in the ten years time

Months	Number of rainfalls causing erosion	Amount of soil loss of all plots (t ha <sup>-1</sup> )	Soil loss per each rainfall (t ha <sup>-1</sup> )
August	2	110.9	9,2
September	9	137.1	11,4
October	13	235.5	19,6
November	10	251.9	21,0
December	15	182.8	15,2
January	11	79.3	6,6
February	7	25.0	2,1
March	2	2.0	0,2
April	5	14.2	1,2
May	1	0.2	0,02
June	2	6.9	0,6

September and the month of January with a peak at December (15 rainfalls) followed by October (13), January (11), November (10) and September (9). The amount of soil loss per rainfall increased from August to November mainly because in August and September the soil was still dry after the summer and ready to absorb more water, while in October and November the soil was still bare but already full of

water and then not allowing water to infiltrate. From December onward the crops starts to establish and then a reduction of soil loss per rainfall could be observed. Irrespective of the studied cropping systems, anyway, a significant relation has been found between annual rainfall (from August to June) and the mean soil erosion per year of the studied plots (fig.1). The influence of each cropping system to soil erosion is reported for two period. In the first period (December '96 – September '02) an average of 56.4 t ha<sup>-1</sup> for alla cropping systems has been observed. Perennial crops

like *miscanthus sinensis*, alfalfa or annual crops but with continuous soil cover like *lolium multiflorum* and subterranean clover determined an amount of soil loss equal to 0.46, 7.6, 12.8 and 6.3 t ha<sup>-1</sup> respectively. A system with wheat and fallow (set-aside) produced a soil loss of 107.7 t ha<sup>-1</sup>. The same system, but with soil during fallow not

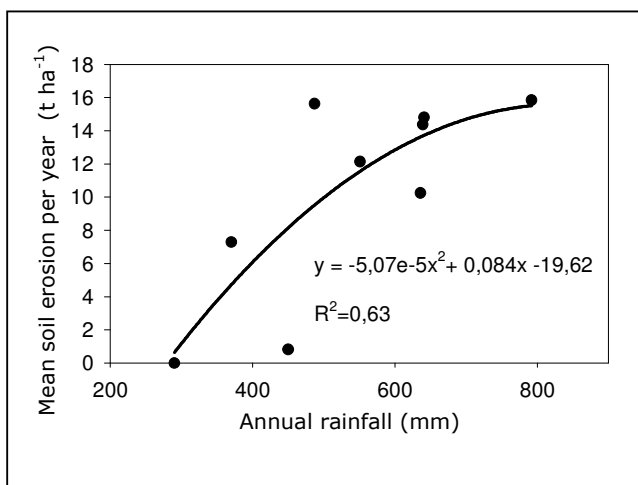

Fig. 1 – Relation between annual rainfall (from August to June) and soil erosion per year in the average of the studied cropping systems.

tilled but with vegetation, allowed to obtain only 18.6 t ha<sup>-1</sup> of soil loss. Among the continuous rotation of annual crops values of soil erosion between 53.9 and 66.7 t ha<sup>-1</sup> were observed, with the exception of plot number 6 and 8 where deep ploughing (40 cm) was carried out twice during the experiments. In the second period (October '02 June '06), a reduced amount of soil loss was observed with the perennial shrub *medicago arborea* (0.99 t ha<sup>-1</sup>), the one with continuous forage crops (4.9 t ha<sup>-1</sup>) and the plot with one year wheat and alfalfa (13.6 t ha<sup>-1</sup>). The plots with annual crop rotation gave soil erosion ranging between 31.4 and 71.0 t ha<sup>-1</sup> according to depth of soil tillage. As far as annual

crop rotation is concerned, promising results were observed in plots where sod seeding was performed in 2004-'05 and 2005-'06, especially in plot no. 9 where only 5.2 t ha<sup>-1</sup> of soil loss were collected. In plot no. 8 problems with rapeseed seed germination in sod seeded soil determined an year of bare soil and then the effect of sod seeding was less evident.

Tab. Soil erosion ( t ha<sup>-1</sup>) in relation to cropping systems in two periods

Plot no.	Cropping systems (December 96 - September 2002)	Soil loss (t ha <sup>-1</sup> )	Cropping systems (October 2002 - June 2006)	Soil loss (t ha <sup>-1</sup> )
1	<i>Miscanthus sinensis</i>	0.5	<i>Medicago arborea</i>	1.0
2	fallow, wheat, wheat, fallow, wheat	107.7	fallow, wheat, wheat, fallow	46.9
3	continuous wheat,	62.2	continuous wheat,	46.8
4	not tilled soil, wheat, wheat, not tilled soil, wheat, wheat	18.6	not tilled soil, wheat, wheat, not tilled	54.8
5	sorghum, sunflower, wheat, vetch-faba bean, wheat, faba bean	66.7	wheat, rapeseed, wheat, faba bean	32.1
6	sweetvetch, wheat, sorghum, wheat, sweetvetch,	124.8	wheat, alfa alfa	13.6
7	faba bean, wheat, mixture of vetch-oat, wheat, faba bean, wheat	55.0	Vetch, wheat, rapeseed, wheat	71.0
8	faba bean, wheat, rapeseed, wheat, faba bean, wheat	160.2	Rapeseed, <i>lolium multiflorum</i> ,	69.9
9	rapeseed, wheat, red clover, sweetvetch, wheat, faba bean	53.9	wheat, faba bean, wheat (sod seeding), rapeseed (sod seeding)	24.7
10	alfa alfa	7.6	alfa alfa, wheat, wheat (sod seeding)	5.2
11	<i>lolium multiflorum</i>	12.8	<i>lolium multiflorum</i> , <i>lolium multiflorum</i> and subterranean clover	4.9
12	Subterranean clover	6.3	Subterranean clover, wheat, faba bean, wheat	31.4
	<b>Average</b>	<b>56.4</b>		<b>33,5</b>

**Conclusion** The cropping systems with perennial crops allowed to keep low the soil loss, while annual crop rotation determined a high amount of soil loss. Sod seeding showed promising results also for annual crop rotations.



## A FARM MODEL PLACING VEGETATION DIVERSITY AT THE CORE OF THE LIVESTOCK PRODUCTION SYSTEM ORGANIZATION

Guillaume Martin<sup>1,2,\*</sup>, Michel Duru<sup>1</sup> and Roger Martin-Clouaire<sup>2</sup>

1 : INRA, UMR AGIR, BP 52627, F-31326 Castanet Tolosan Cedex;

2 : INRA, UBIA, BP 52627, F-31326 Castanet Tolosan Cedex; \* : guillaume.martin@toulouse.inra.fr

### Introduction

In less favoured areas, livestock production involves the management of native vegetation as a resource base (grazing or fodder) for animal production. Quite often a diversity of plant communities is present in a farmland. A challenging issue in such systems concerns the efficient and sustainable use of this diversity. Considerations of herbage growth rate and pattern and feeding value of the different plant communities and nutrient requirements of different animal groups are of primary importance. Thus research is needed on proper exploitation of the resource diversity and on elicitation of suitable production management strategies. This paper presents a farm simulation model called SEDIVER that support an *in silico* experimental investigation of the merits and limits of different management strategies.

### Vegetation patterns linked to vegetation diversity

The concept of functional diversity lays on the definition and the measuring of plant traits (morphological, physiological and phenological) in response to availability of resources and perturbations. Resting on concepts of functional ecology, Cruz et al. (2002) proposed a classification of grass species into four groups A, B, C and D along a leaf dry matter content gradient. In practice, the four groups are characterized among other things by timing differences (in degree days) for phenological stages.

Several studies underlie the strong impact of practices on grassland vegetations composition (e.g. Andrieu et al., 2007). On the other hand, grass functional types imply conditionality (e.g. temporality and intensity) in the utilization of the grassland vegetation and nutrient resources management. Recent work permitted identifying relations between grass functional type, climate, defoliation mode and fertility with plant growth dynamics and feed value evolution (Duru et al., 2007). This biophysical knowledge is of primary importance when evaluating the performance of various practices in the exploitation of the grassland resources.

### Building management strategies considering vegetations diversity

Production management involves making decisions about the organization of sequences of activities through time and the combination of available resources to satisfy pre-defined multi-purpose objectives. For livestock systems, a challenging issue consists in satisfying the seasonal feed requirements of the different herd flocks on short term while preserving the potential of the vegetation with relevant management practices to ensure sustainable performances on long term. Such objectives can be conflicting as objectives at field scale (mainly the objectives related to the vegetation) are not necessarily satisfied when upscaling to consider objectives at farm level (mainly the herd flocks feeding objectives).

For farmers, production management can be described by two main steps:

- a priori configuration and ordering: area allocation to the different production units, i.e. dimensioning of the production workshops (Coléno & Duru, 2005) and of the reserve areas for silage making, hay making or grazing and ordering of interventions;
- dynamic management: checking of the system state appropriateness with conditions for intervention and adjustment of the interventions ordering.

Both steps should be based on considerations for vegetation patterns and state, and animal state within each herd flock. Then, identifying the main characteristics of vegetation diversity, e.g. the main grass functional type, provides useful information at the time of dimensioning, e.g. thanks to the potential production brought by a particular vegetation, about interventions ordering, e.g. in terms of timing and priorities between fields and about possibilities for intervention, e.g. through the available biomass at the time planned for intervention.

Considerations for vegetation diversity when building management strategies should help holding the possibly conflicting objectives at field and farm scales in a sustainable way. A high functional diversity at a field, i.e. a field where different grass functional groups cohabit, flattens growth dynamics and feeding value evolution as the various groups differ by the dates at which biomass peaks are reached (Duru et al., 2007). It allows extending the time period for intervention without undermining the quality and the quantity of the feed resource therefore diminishing the vulnerability of the farm system against climate uncertainty. Moreover, functional diversity at farm scale, i.e. fields presenting different functional composition within a same farm, make labour organisation more flexible thanks to the heterogeneity of swards dynamics in time and space. There are functional complementarities between grass functional types at the farm level. Beta diversity also contributes to better control critical phenological stages (Duru et al., 2007). Capitalizing on animal diversity through differences in flocks requirement is of primary importance as well. Allocating pasture and harvested forage with low qualitative and quantitative feed characteristics to animal flocks with low feed requirements e.g. heifers is a way to value all kinds of vegetations.

Accounting for vegetation diversity in farm management strategies implies specifying timing for interventions with temporal benchmarks linked to dates (in Julian days) or vegetation phenological stages (in degree.day<sup>-1</sup>). As an example, if a field with main grass functional type C has to be lightly grazed at early spring before later cutting events, grazing should occur in the range 800-900 °C.day<sup>-1</sup> whereas it turns to 500 – 600 °C.day<sup>-1</sup> for type A. Vegetation state can induce revision of the considered strategy. Due to uncertainty related e.g. to climatic conditions on a given year, it is sometimes possible to modify the utilization mode of a given sward to produce a feed resource with different characteristics. Such decisions can be taken thanks to indicators around vegetation diversity like the area ratio for which intervention can be delayed without undermining the quality of the feed resource or changing the sward composition.

### **Development of a farm simulation model (SEDIVER)**

For testing farm management strategies considering vegetation diversity, a discrete event simulator for managed grassland systems called SEDIVER is under development (PhD Thesis project: Dec. 06 – Nov. 09). The farming system (Martin-Clouaire and Rellier, 2003) is seen as made up of three interacting subsystems: the decision system, the operating system and the biophysical system. Processes occurring within the system are controlled by events and they modify the system state. Activities composing the production plans specify an operation on a biophysical entity performed at a location by an actor. Activities will be described in terms of the underlying technical operations together with their effects on the biophysical system, their feasibility conditions, and the state-dependent constraints defining their management relevance. In the biophysical system model, the dynamics of the forage resources, herds and individual animal performances are reproduced. This enables to evaluate various criteria involved in the assessment of the proposed strategies.

The model will allow testing of different farm system configurations (area allocation to different utilization mode and different utilization of grasslands types), the response of vegetations under different management strategies and different grassland and animal management strategies. The model will be tested for validation on well-identified farm types. Validation is planned to take place with model outputs presentations to a range of stakeholders working around grassland systems (farm advisors, farmers, etc...).

### **References**

- Andrieu N. et al. 2007. Relationships between diversity of grassland vegetation, field characteristics and land use management practices assessed at farm level. *Agriculture, Ecosystems & Environment* 120, 359-369.
- Coléno F.C., Duru M. 2005. L'apport de la gestion de production aux sciences agronomiques. Le cas des ressources fourragères. *Natures Sciences Sociétés* 13, 247-257.
- Cruz P. et al. 2002. Une nouvelle approche pour caractériser les prairies naturelles et leur valeur d'usage. *Fourrages* 172, 335-354.
- Duru M. et al. 2007. Typologies de prairies riches en espèces en vue d'évaluer leur valeur d'usage : bases agro-écologiques et exemples d'application. Submitted to *Fourrages*.
- Martin-Clouaire R., Rellier J.-P., 2003. A conceptualization of farm management strategies. Proceedings of EFITA-03 conference, 719-726. Debrecen, Hungary.

## EFFECT OF PERIURBAN LOCATION OF MARKET-GARDENING FARMS ON THE SPATIAL ORGANIZATION OF LEAFY VEGETABLE CROP SEQUENCES.

Mawois M.<sup>1</sup>, Aubry C.<sup>2</sup>, Le Bail M.<sup>3</sup>

(1) Montpellier Sup'agro - Institut des régions chaudes, UMR Innovation, France, [marie.mawois@cnearc.fr](mailto:marie.mawois@cnearc.fr)

(2) INRA, UMR SADAPT, France, [caubry@agroparistech.fr](mailto:caubry@agroparistech.fr)

(3) Agroparistech UMR SADAPT, 16 rue Claude Bernard Paris. France, [lebail@inapg.inra.fr](mailto:lebail@inapg.inra.fr)

### Introduction

The paper focus on the decisional variables, decision rules and management units for leafy vegetable crops sequences and cropping plan in manual market gardening farms, in the surroundings of the city of Mahajanga (Northeast of Madagascar). The farmer's decision models are adapted from previous works on strategic planning and day-by-day decisions annual arable crops and lettuce in French farms (Aubry *et al.*, 1998, Navarrete et Le Bail, 2007).

### Methodology

Surveys in twelve farms are in course (2006-2008) with three steps: (i) the farm management (resources allocation to different crops, relationships with the retailers) (ii) the cropping systems (description and decision making process for crop localisation, crop sequences, cultural practices); (iii) the record of the practices really implemented every ten days to compare them with planning.

### Results

Here for one of the farms, we identify the decision rules for crop localisation and sequences of the main leafy vegetable crops: lettuce, Petsai, Anatsonga et Fotsithao<sup>1</sup>. On a field of 500 m<sup>2</sup> in a bottomland, with rice during the rainy season, the farmer maintains between April and December, 28 small-plots with vegetable crops. To order the technical making-process of market gardeners we identify «crops blocks»: for each block of small-plots the farmer follow the same rules for crop sequences management and resources allocation. To do so we estimate the value, according to the farmer, of three decisional variables: (1) the surface area suitable for each crop (2) the optimum period for cultivation and (3) the effective number of cycles during the cultivation season.

The surface area suitable for cultivation depends on the crops requirements compared with

**Figure 1: Identification of surface areas suitable for different vegetable crops:**

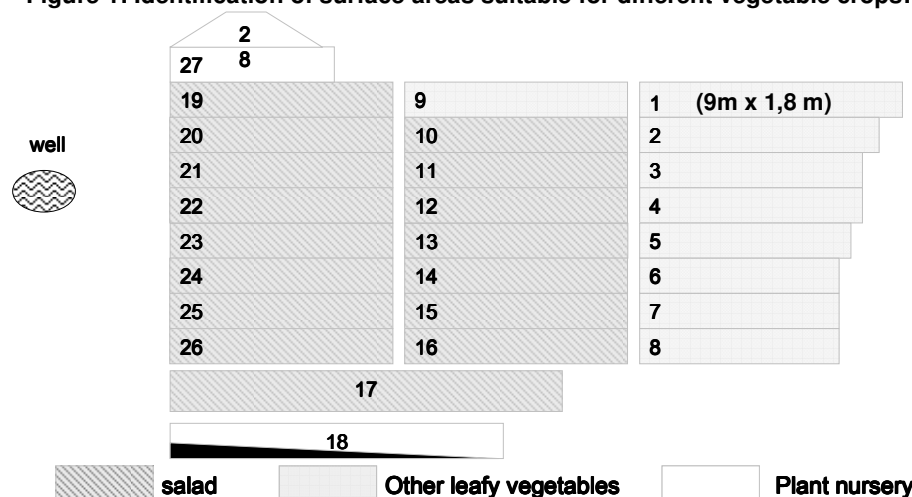

Spatial organisation of the crops depends on water: hydrology of the land, distance to the well and water level in it, irrigation technique (width of the beds depends on watering can)

environmental conditions (fig. 1). The lettuce has here the strongest requirements: the farmer use the more fertile soils (black soils), the wettest in the heart of the dry season, the easiest to till and the nearest to the well (high water demand and manual irrigation). Lettuce will never be grown on the

nine furthest from the well small-plots. For other crops, all small-plots are considered as suitable for cultivation.

<sup>1</sup> Traditional leafy vegetables in Madagascar

The extent of the maximum period for cultivation is from the first planting to the last harvest suitable for the crop, with regards to the climate constraints. For the farmer point of view, high temperatures and important rainfalls must be avoided for lettuce and petsaï. Their cultivation period must be limited between May and November (dry and fresh season). The anatsonga and fotsitaho can be cultivated between April and the end of November but during the winter months (July and August), high winds and low temperatures limit their development. This maximum period for cultivation is nevertheless corrected by the farmer with regards to the water resources and the market prices: he aims at selling most of his lettuce production between June 26<sup>th</sup> (national Independence Day) and August 20<sup>th</sup> (end of tourist season). After this date, the prices are lower and the water become scarce. So the effective cultivation period for lettuce is from May 20<sup>th</sup> (transplanting) and latest harvest around 20<sup>th</sup> of August.

The effective number of cycles for each crop depends on: the cycle length (reduced here by a systematic transplanting), the intercrop period which depends strongly on the retailer (who harvests herself the small plot during 2 to 4 days), the return time and the market conditions for the different leafy vegetable crops for a given cycle.

Finally, for lettuce there is no more than two cycles (fig.2): (i) first cycle on 16 small-plots from May 20<sup>th</sup> to the beginning of July (highest prices) and (ii) second cycle on 5 small-plots nearest from the well from July to August. The developed surface area (DSA: total area for a given crop during the season) for lettuce is 420 m<sup>2</sup>. The farmer cultivates two cycles of Anatsonga and/or Fotsitaho on the most naturally drained small-plots (beginning of dry season) or very close to the well small-plots (end of dry season) (DSA : 310 m<sup>2</sup>). On the remaining small-plots the farmer cultivates several cycles of Petsaï during the dry season (DSA : 2000 m<sup>2</sup>).

## Conclusions

With the analysis of the technical making-process of this farmer we can build three “crops blocks” carrying specific crop sequences (fig 2). The decision making process is mainly activated by three elements: (i) the dynamics of the farm water resources (ii) the prices during the cropping season and (iii) the relationships with the retailers. This model is under test with the other farms. We will improve it by the analysis of the cultural practices decision rules (irrigation, fertilization,...) and the identification of the determinant factors bound to the periurban location of the farms.

Numerous research works, mainly by economists, were led on the global production and supply of market gardens crops in urban and periurban territory. But the agronomic components of farming systems directed by this urban vegetable food demand remains still to study. The original result of this work is to enhance the generality of a framework on decision making of farmers, built earlier in radically different conditions. From a practical point of view, this model could be used as a simulation tool to identify technical difficulties for the farming systems sustainability in this context of growing urbanisation and growing urban demand for food.

Figure 2: The constitution of crop sequences and crop blocks in the farm.

	April	May	June	july	August	Sept	Oct	Nov	Dec
<b>Block 1</b>		An/FT	Petsaï	Petsaï	Petsaï	Petsaï	Petsaï	Petsaï	Petsaï
<b>Block 2</b>			lettuce	lettuce	Petsaï	Petsaï	Petsaï	An/FT	
<b>Block 3</b>	An/FT	lettuce	Petsaï	Petsaï	Petsaï	Petsaï	Petsaï	An/FT	

**Block of small-plots:** 1: the furthest from the well, the first drained and planted, but also the driest at the end of season so the first to be abandoned; 2: the closest to the well, the last drained; 3: Intermediate.

## References

- C. Aubry et al., Modelling decision-making processes for annual crop management, 1998. *Agric. Syst.* 56, 45-65.  
M. Navarette, M. Le Bail. SALADPLAN: a model of decision-making process in lettuce and endive cropping, 2007. *Agron. Sustain. Dev.* 27, 209-221

## ANALYSING CURRENT AGRICULTURAL MANAGEMENT OF PHOMA AND LEEWAY IN RAPESEED

Fargue-Lelièvre A., Moraine M., Coléno F-C.

UMR SAD APT, INRA, F-78850Thiverval-Grignon, France

[agnes.lelievre@agroparistech.fr](mailto:agnes.lelievre@agroparistech.fr), [marc.moraine@agroparistech.fr](mailto:marc.moraine@agroparistech.fr), [francois.coleno@grignon.inra.fr](mailto:francois.coleno@grignon.inra.fr)

### Introduction

Durability of plant resistance to pathogens is an integral part of sustainable agriculture. In rapeseed, the most often used defence against phoma, a major disease, is varietal resistance. But the massive use of one type of specific resistance may rapidly bring an adaptative response of the pathogen to selection pressure.

The main hypotheses are that:

- 1) Sustainable management of pathogens includes necessarily limitation of primary inoculum to diminish selective pressure on the pathogens (Aubertot *et al.*, 2004).
- 2) Management of phoma pressure on the crop must be done at a larger scale than the plot, pathogen dissemination distance being several kilometres (Schneider *et al.*, 2006)
- 3) Today's cropping techniques and varietal management cannot permit the sustainability of varietal resistance but leeways can be found to better this management.

The objectives of this study are to i) identify cropping systems management within the farm focusing on rapeseed; ii) identify the possibilities of adopting agronomic advice to diminish phoma adaptation taking into account the strategies we identified.

### Methodology

This study is based on surveys in 3 French departments exposed to a more or less important phoma pressure on farms cropping a varying proportion of rapeseed. A sample of 32 farms maximizing diversity of managements and production contexts was surveyed. On this sample, data on production means (cropped area, equipment, labour), production objectives, technical choices (including cropping techniques and crop succession) and disease management (including phoma history, management techniques and reaction to potential field contamination) were noted as well as leeways to adapt rapeseed management according to recommendations.

Using the methodology of Girard *et al.* (2001), survey results were synthesized and used as a basis on which experts defined diversity criteria between farms. A notation between 1 (less risky) and 5 (risky) was then attributed for each farm on each diversity criterion

*Diversity criteria kept:*

1. Adaptation of varietal choice for a maximum yield
2. Adaptation of rapeseed management for a better economic profitability
3. Choice of cultivars to maximize field plan use
4. Adaptation of cropping techniques to maximize productivity
5. Maximization of field plan use to increase return time of rapeseed
6. Adaptation of cultivar choice to limit crop accident on rapeseed
7. Adaptation of cropping techniques to limit crop accident on rapeseed
8. Adaptation of cropping techniques to limit the use of environmentally unfriendly products
9. Use of innovative techniques to optimize rapeseed results with an objective of crop sustainability
10. Search and use of information to reason cropping system

Each farm was thus represented by a combination of qualitative descriptors which could be compared between farms. Farm grouping was done using correspondence analysis (disjunctive treatment) followed by an agglomerative hierarchical clustering with XLStat<sup>®</sup>. For each group, a "prototype" could then be described defining farm types to which each farm could be more or less close, one farm belonging to one or several prototypes at a more or less high level.

## Results

6 prototypes were obtained and farms were brought closer to the prototypes they most resembled.

Type A	<i>Simplification of work and system</i>	3 farms
Type B	<i>Simplification because of another main activity</i>	4 farms
Type C	<i>Complex system with a well-defined role for rapeseed</i>	4 farms
Type D	<i>Securing with field plan management</i>	2 farms
Type E	<i>Securing with cropping techniques</i>	4 farms
Type F	<i>Technicity but risky techniques for a high productivity</i>	4 farms
Type G	<i>Technicity and adaptation to high constraints</i>	6 farms
Type H	<i>Technicity for sustainability with limited objectives</i>	5 farms

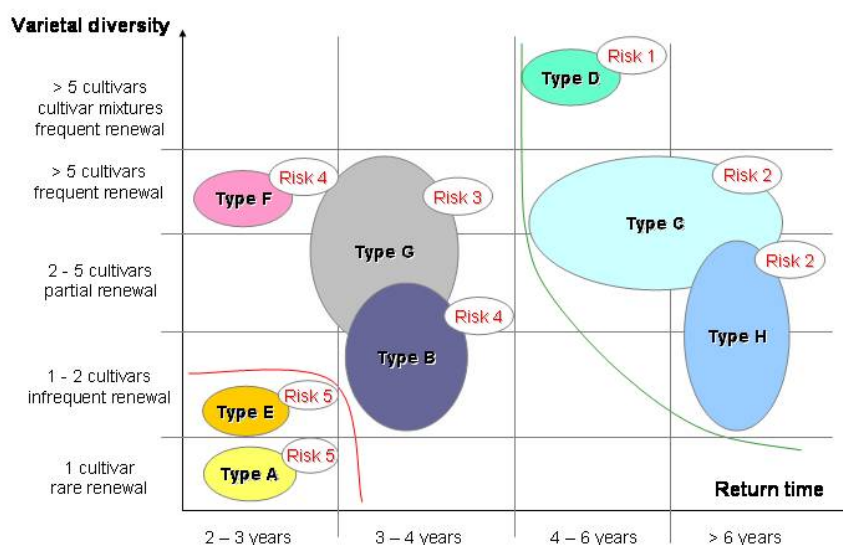

Both return time and varietal diversity appear to have a high influence on resistance breakdown but other criteria are able to compensate: B and G types do not have the same risk level but overlap on the figure. G type is more technical and risk is also managed using techniques like crop residues management... whereas B type farms tend to simplify cropping techniques.

## Conclusion

Prototypes were constructed as a combination of resources, techniques and objectives, the relation to which was measured for surveyed farms. Their workings, constraints and management leeways can now be studied in order to identify risky types and possible improvements for each type.

This study is based on an adaptation of the methodology developed by Girard on sheep farms to rapeseed crop and distinguishes farms based on their strategies without rigid limits. It could as well be used on other crop issues, like other pathogen-crop relations.

These data should be used as entry data in a spatial dynamic model of phoma adaptation to varietal resistance being developed.

## References

- Aubertot J.N. et al. The effects of sowing date and nitrogen availability during vegetative stages on *Leptosphaeria maculans* development on winter oilseed rape. 2004. Crop protection 23, 635-645  
 Girard N. et al. Categorising combinations of farmers' land use practices: an approach based on examples of sheep farms in the south of France. 2001. Agronomie 21, 435-459

# THE SOIL MICROBIAL DIVERSITY AS BIO-INDICATOR FOR SUSTAINABLE PRODUCTION

L.M. Manici, F. Caputo

Agriculture Research Council, CRA-ISCI. Bologna (ITALY) [l.manici@isci.it](mailto:l.manici@isci.it); [f.caputo@isci.it](mailto:f.caputo@isci.it)

## Introduction

Continuous systems (fruit trees, vineyards, vegetables, cereals crops) dominate agriculture in the Mediterranean area. Such system increases the problem of organic matter (OM) decline included by the European Community among the eight main treats of land degradation on Europe. The progressive reduction of microbial biomass is the direct consequence of the OM decline. The consequent loss of biodiversity, and the consequent loss of functioning attributes of soil microbial communities (Visser et al., 1992), is cause of land degradation as of fertility decline of Mediterranean agricultural soils. Soil microbial diversity is one, of the main factor involved in soil suppressiveness toward soil borne pathogens (Mazzola, 2002). A large number of microorganisms (bacteria, fungi and micro-invertebrates) have been investigated for the analysis of soil quality. Fungi represent the highest part of soil microbial biomass (Lin et al., 1999) and their C assimilation efficiency is markedly higher than bacteria (Suberkroop et al., 1996). As microbial diversity is broadly related to land use (Ibekwe et al., 2002), the use of soil fungi as bio-indicators for sustainable land management was investigated.

## Methodology

The study was performed on four pair of arable systems in four Italian growing areas. Two pairs of systems differed for the crop rotation implemented in the last 8 years, but they did not differ for cropping practices. The other two pair of systems were subjected to two differing cropping practices in the last 6 years leading to high and low density of the same crop; they are referred respectively as "high input" (conventional cropping practices) and "low input" (wildlife friendly cropping practices, no chemical fertilizers, no chemical control of weeds etc). The four locations were classified as Mediterranean area, with a temperate sub-continental climate with clay-loam soil texture, In all cases the soil OM content was lower than 1.5%

*Microorganism detection:* The study was performed on bulk soil, in the cultivated layer. Three soil samples (each obtained mixing five sub-samples taken from three sampling area) for each investigated system were considered in this study. DNA was extracted from approx. of 0.5 g of bulk soil using Ultra Clean soil DNA kit (MoBio Laboratories). In the first step, DNA was amplified with the primer specific for fungi ITS1F-ITS4, then it was amplified with primer specific for *Ascomycota* (ITS1F-ITS4A) and for *Basidiomycota* (ITS1F-ITS4B) because saprophytic soil-inhabiting fungi mostly belongs to those *Phyla*. The DNA of fungal strains belonging to those two *Phyla* were inserted as control in all the steps. This part step gave *Ascomycota* as the most represented *Phyla*.

*Biodiversity evaluation:* Filamentous fungi, which are largely represented by *Ascomycetes*, were chosen as indicator. Quantitative and qualitative analysis was carried out by direct count using soil dilution plate methods because it can isolate a representative portion of soil filamentous fungi which were expressed as number of propagules  $g^{-1}$  soil (Manici et al., 2005). The composition of the fungal population was recorded by visual observation under natural light of transparent agar disks including soil suspension. Fungal colonies with different morphologies were transferred to growing media for the identification of representative resulting colonies. That allowed the count of the relative frequency of fungal colonies

*Biodiversity indices.* The biodiversity indices Shannon and Berger-Parker (the reciprocal of the latter) were calculated. The diversity within each pair of systems was compared by the graphical method K dominance (Lambshead et al., 1983) using the BioDiversity Professional Software .

## Results

*Microorganism detection:* The DNA amplification with the primer specific for fungi revealed a fungal DNA amount varying from 5 to 20  $ng \mu l^{-1}$ . The test with specific primers revealed the *Ascomycetes* presence in all soil samples, whereas the *Basidiomycetes* level was too low to be amplified at the same DNA concentration in all cases. For that reason, fungal population belonging to *Ascomycetes* were considered as the target for the study on soil fungi as bio-indicator.

**Biodiversity evaluation:** The number of total fungi varied from 33.000 to 69.000 propagules  $g^{-1}$  soil; three pairs of analyzed system differed significantly for the number of propagules  $g^{-1}$  soil. The number of recorded species in the eight systems varied from 9 to 17. The largest part of fungal species recorded by plate count was represented by the asexual state of *Ascomycetes*, around 10% belonged to *Zygomycetes*, while *Chromista* were recorded only in rotation treatments. The K dominance test, where the lower line has the higher diversity, revealed a not differing biodiversity in the two pairs of systems differing for crop rotation (Fig 1, example b); this finding was confirmed by their biodiversity indexes which were very similar (Tab 2).

Table 2 Biodiversity index of soil fungi population in four pair of soil systems

Pairs of soils	Shannon (log 10)		Bergher Parker (1/d)	
Pair 1. high/low input north	1.14	0.69	6.36	1.87
Pair 2. high/low input south	0.86	0.52	3.14	1.5
Pair 1 Rotation	0.94	0.88	5.0	5.0
Pair 2 Rotation	0.83	0.82	5.0	5.0

“low input” systems, showed the lowest species richness (number of species) and the lowest evenness. An example: *Fusarium solani*, a largely represented species in the cultivated clay soils, was observed in all the four analyzed fields, but his abundance was higher than 50 % of total

population in the “low input” treatments; while it represented one of the eight fungal species showing abundance higher then 5% in each of two systems under “high input” management (Fig. 1 a). These findings suggest that the management practices causing lowest plant population, as the “low input” treatment in this study, can reduce the soil microbial diversity.

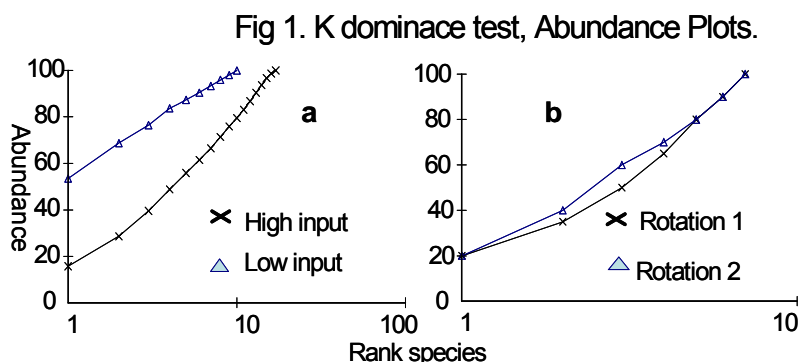

## Conclusions

This study shows that saprophytic fungal population in the cultivated layer were mostly represented by *Ascomycetes*, while *Basidiomycetes* are usually reported to be the most important degrading fungi on undisturbed soils (Takashi et al., 2003). In the Mediterranean environment affected by soil O.M. decline and biodiversity loss, hence characterized by a weak microbial balance, the biodiversity indices most strongly influenced by evenness (e.g. Berger-Parker index), resulted more sensitive in evaluating the effect of cropping practices in reducing biodiversity than those biased toward richness (e.g. Shannon index). The majority of fungal population isolated from cultivated layer was represented by filamentous fungi which are typical leaf litter species, that explains the findings of this study showing that the diversity of soil fungal population was negatively affected in the “low input” farming system causing lowest plant biomass incorporation into the soil. All that suggests the use of soil fungi biodiversity not only for soil health study (soil suppressiveness potential, plant growth promoting effect) but also as an indicator in the evaluation of cropping practices impact for sustainable land management.

## References

- A.M Ibekwe. et al. Microbial diversity along a transect of agronomic zones. 2002 FEMS Microb. Ecol. 39, 183-192.
- Lambshhead et al. Detection of differences among assemblages of marine benthic species based on assessment of dominance and diversity. 1983 J. Nat. Hist. 17 859-874.
- Q. Lin, et al. An evaluation of the substrate-induced respiration method. 1999 Soil Biol. Biochem. 31, 1969-1983.
- L. M Manici. et al. Additional experiences to elucidate the microbial component of soil suppressiveness towards strawberry black root rot complex 2005 Ann. App. Biol. 146, 421-430
- M Mazzola. Mechanisms of natural soil suppressiveness to soilborne diseases. 2002 .A. van Leeuwenhoek 81: 554-567.
- K. Suberkroop et al. Application of fungal and bacteria methodologies to decomposing leaves in stream. 1996 Appl. Environ. Microbiol 62, 1610-1615.
- O Takashi et al. Roles of diverse fungi in larch needle-litter decomposition. 2003. Mycologia, 95, 820-826.
- S Visser, et al. Soil biological criteria as indicator of soil quality: soil microorganisms. 1992 Am. J. of Altern. Agric. 1-2, 33-43.



## **AN INTEGRATED FARM SUSTAINABILITY MONITORING TOOL: METHODOLOGY AND APPLICATION ON FLEMISH DAIRY FARMS**

M.Meul

Flemish Institute for Agricultural and Fisheries Research, Belgium, [marijke.meul@ilvo.vlaanderen.be](mailto:marijke.meul@ilvo.vlaanderen.be)

### **Introduction**

Indicators are logical devices to be used in sustainability monitoring. For agriculture, indicator-based farm monitoring systems already exist and are applied in practice. An overview of those monitoring instruments learns that many of them focus on a rather restricted number of sustainability aspects, in general economic and/or ecological (von Wirén-Lehr, 2001). Furthermore, only few authors explain how and why the considered sustainability aspects and indicators were selected (van der Werf & Petit, 2002). The aim of our study was therefore to develop an indicator-based monitoring system for integrated farm sustainability – considering economic, ecological as well as social aspects – that is based on a supported vision on sustainable agriculture. Since we aspire that the monitoring system will actually be used in practice as a management guiding tool, we paid specific attention to aspects of communication and user-friendliness. In this paper, we describe the applied methodology for developing this monitoring system.

### **Methodology**

The methodology consists of four successive steps:

1. *Translating the major principles of a supported vision on sustainable Flemish agriculture into concrete and relevant themes for individual farms*

Sustainable development processes should be based on a well conceived vision, with concrete and inspiring images of an envisioned future. Nevens et al. (2007) describe a process of vision development on a sustainable (future of) agriculture in Flanders. This process was based on a transdisciplinary dialogue between the multiple stakeholders of Flemish agriculture. We considered the resulting vision as a publicly supported guideline for all actors (including farmers, agricultural industry, consumers and government). It integrates major principles for the ecological, the economic and the social sustainability dimension of agricultural systems. In mutual agreement with stakeholders, we translated those major principles into concrete themes, to make 'sustainability' more tangible at a practical level, to be able to take directed actions and to design relevant indicators.

2. *Designing indicators to monitor progress towards sustainability for each of those themes*

Extended literature is available on the development and use of indicators to measure farm sustainability. Whenever such existing indicators complied with our supported vision, the derived themes and imposed quality criteria (related to their causality, sensitivity, solidness, use of benchmarks and comprehensibility), we integrated them in our monitoring system. When little or no scientific information was available - which was particularly the case for the social themes - we consulted stakeholders (including experts) for selecting or designing relevant indicators, again taking into account the pre-defined quality criteria. For some social aspects of sustainable farming, neither scientific information, nor expert knowledge was available. In these cases, we performed new fundamental research. Before accepting and implementing the indicators into the monitoring system, they were validated by presenting them to a feedback group of experts and stakeholders. This group discussed the indicators' relevance and underlying methodological choices such as indicator design, data use, choice of benchmarks and indicator weights. That way, we also created a support base for the indicators and the monitoring system, since as many stakeholders as possible were involved in their development.

3. *Aggregating the indicators into an integrated farm sustainability monitoring system*

We aggregated the indicators in a graphic system, where all relevant themes are presented individually, instead of combined into a single aggregated index. We further focused on a user friendly and communicative design of the system by (1) providing the ability to add the average indicator scores of a group of comparable farms. This option is particularly useful for farmers who wish to communicate on their farm sustainability in a discussion group; (2) visualising the indicator weights. That way, a farmer can readily distinguish which indicators are considered more or less important when evaluating the sustainability of a specific theme; (3) using a multi-level monitoring system. Level 1 gives an overview of the farm's overall sustainability. Level 2 gives an overview of

the sustainability themes within a specific sustainability dimension (economic, ecological or social). In level 3, the indicator scores for a specific theme are visualised. That way, starting from an overall view of his farm's sustainability, a farmer can zoom in on the underlying themes and indicators into as much detail as desired.

#### 4. *Applying the monitoring system on a practical farm, as a first end-use validation*

We applied the methodology to the dairy sector as an example and we used the monitoring instrument on a specific dairy farm as a case study as a first end-use validation of the system.

## Results

We translated the major principles of sustainable agricultural systems into 10 relevant themes. In total, 60 indicators were developed to monitor progress towards sustainability for each of the themes. The indicator values were translated into scores between 0 and 100, which we aggregated in an adapted radar graph (Figure 1). Within a specific theme, we considered all indicators as equally important and hence the theme's score was calculated as the average of the related indicator scores, except when – based on expert opinions or on literature reviews – there was considerable proof that certain indicators are in fact more important than others when used to evaluate the sustainability of the specific theme. This was specifically the case for the indicators designed to evaluate a farm's (economic) 'productivity' and for 'soil quality'

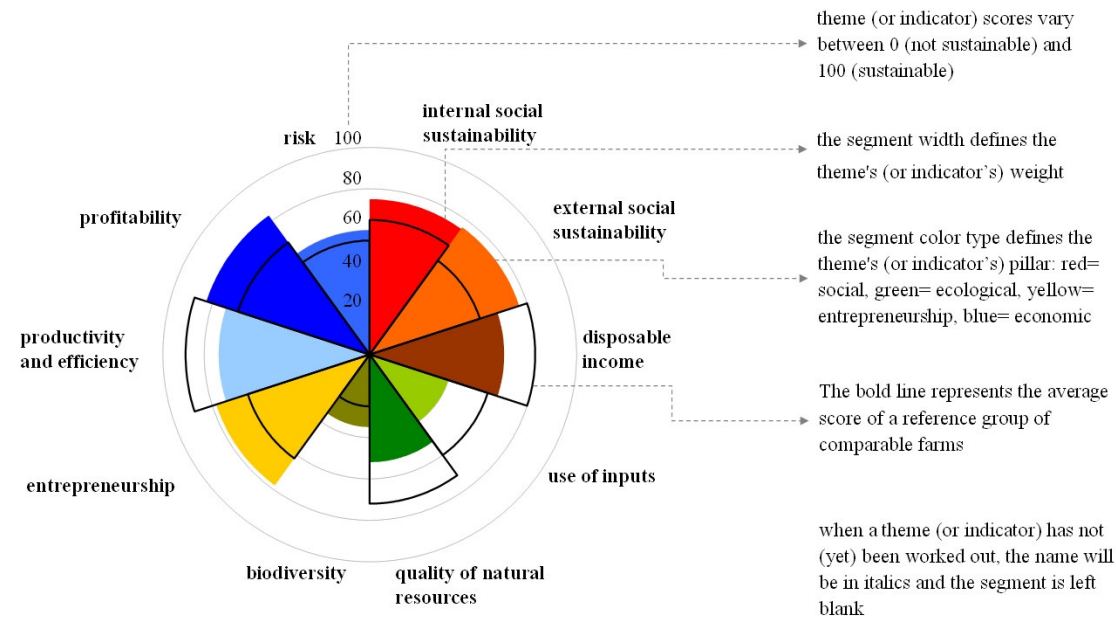

Figure 1. The integrated indicator-based sustainability monitoring instrument at level 1, presented with a legend concerning the reading and interpretation.

## Conclusions

In this study, we developed a user-friendly and strongly communicative instrument to measure progress towards integrated (economic, as well as ecological and social) sustainable dairy farming systems. The sustainability monitor fits within a well founded methodological framework and is based on a set of relevant indicators. In our opinion, the end-use validation of the system is of critical importance to its optimization and continuous improvement. For that reason we encourage its application on as many practical Flemish farms as possible.

## References

- F. Nevens et al., On tomorrow's grounds; development of a vision on Flemish agriculture in 2030, 2007. *Journal of Cleaner Production*, *in press*.
- H.M.G. van der Werf & J. Petit, Evaluation of the environmental impact of agriculture at the farm level: a comparison and analysis of 12 indicator-based methods, 2002. *Agric. Ecosyst. Environ.* 93, 131-145.
- S. von Wirén-Lehr, Sustainability in agriculture – an evaluation of principal goal-oriented concepts to close the gap between theory and practice, 2001. *Agric. Ecosyst. Environ.* 84, 115-129.

## COMPARISON OF SIMULATED AND OBSERVED N-FLOWS ON PIG FARMS IN DENMARK

J.E. Olesen<sup>1</sup>, N.J. Hutchings<sup>2</sup>, B.M. Petersen<sup>3</sup>, I.S. Kristensen<sup>4</sup>, K. Schelde<sup>5</sup>, M. Lægdsmand<sup>6</sup>

<sup>1</sup> Dep. of Agroecology and Environment, University of Aarhus, jorgene.olesen@agrsci.dk, Denmark

<sup>2</sup> Dep. of Agroecology and Environment, University of Aarhus, Nick.Hutchings@agrsci.dk, Denmark

<sup>3</sup> Dep. of Agroecology and Environment, University of Aarhus, BjornM.Petersen@agrsci.dk, Denmark

<sup>4</sup> Dep. of Agroecology and Environment, University of Aarhus, IbS.Kristensen@agrsci.dk, Denmark

<sup>5</sup> Dep. of Agroecology and Environment, University of Aarhus, Kirsten.Schelde@agrsci.dk, Denmark

<sup>6</sup> Dep. of Agroecology and Environment, University of Aarhus, Mette.Laegdsmand@agrsci.dk, Denmark

### Introduction

Animal agricultural production systems are causing considerable diffuse source pollution of nitrogen (N) to the environment. The amount of N lost from such systems is determined by a complex interaction between many factors, such as livestock density, housing systems, agronomic practices, soil characteristics and climatic conditions. The high costs and practical difficulties of measuring diffuse source pollution such as nitrate leaching, ammonia emission and nitrous oxide emissions imply that these losses are very difficult to quantify at the farm level. Farm level model may be used to quantify these interactions. However, there have been few attempts to validate these models at farm scale.

### Methodology

Data on farm management from 6 pig and arable farms in Denmark over the period 1995 to 2002 were collected. This data included measurements of yield and inputs of N in fertiliser and manure to the fields. The observed field operations and the data on soils were used to define inputs for the FASSET dynamic whole farm model (Olesen et al., 2002; Berntsen et al., 2003). The farms varied somewhat in size over the studied period (Table 1). The average N input was, however, fairly stable both between years and between farms. The cereals and oil seed crops dominated on the sandy soils, whereas the crops on the loamy soil also included sugar beet and grass for seed production.

Table 1. Characteristics of 6 pig farms in Denmark used for modelling. N input shows the average total N input (manure, fertiliser, N fixation and deposition) to the fields.

Farm no.	Period	Size (ha)	N input (kg N ha <sup>-1</sup> )	Sandy soil (%)	Cereal area (%)	Oil seed area (%)
1	1995-2002	104-117	210	76	70	17
2	1995-2002	98-106	180	91	57	8
3	1996-2001	30-145	179	52	92	5
4	1997-2002	85-130	169	15	55	2
5	1997-2002	89-158	170	16	56	1
6	1996-2002	124-139	166	20	54	10

### Results

The observed N yields were based on observed yields multiplied by standard N contents. The simulated N yields were generally considerably lower than the observed N yields (Figure 1). It was not possible to estimate farm N surplus, because of some missing yield data. The farm N surplus shown in Table 2 is therefore solely based on the simulations. Given that the simulated N yields were lower than the observed N yields, this leads to higher simulated N surplus compared with the observed ones.

The largest simulated N losses were N leaching followed by ammonia volatilisation (Table 2). N leaching dominated on the sandy soils, whereas the N<sub>2</sub> and N<sub>2</sub>O emissions were higher on the loamy soils. There was also a tendency for negative soil N change on the loamy soils compared with slightly positive ones on the sandy soils.

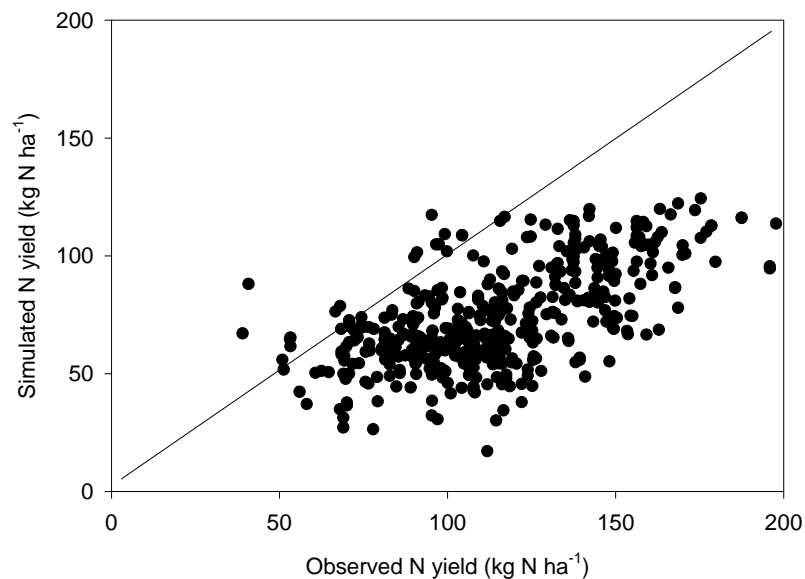

Figure 1. Simulated versus observed N in harvested main products (grain, seed, roots or tubers) ( $\text{kg N ha}^{-1}$ ).

Table 2. Average simulated field N balances and simulated distribution of losses and changes in soil storage ( $\text{kg N ha}^{-1}$ ).

Farm no.	Simulated N surplus	N leaching	$\text{NH}_3$	$\text{N}_2\text{O}$	$\text{N}_2$	Soil N change
1	101.9	46.2	28.4	2.6	5.3	19.4
2	80.1	38.0	17.8	2.6	5.9	15.8
3	57.4	36.2	20.0	2.7	7.0	-8.5
4	42.5	41.7	15.5	3.8	10.7	-29.2
5	64.9	46.4	19.6	3.7	10.1	-14.9
6	47.4	47.3	7.5	3.8	10.7	-21.9

## Discussion

The model captured much of the variation in observed N yields. However, simulated N yields were in general considerably lower than observed ones. There may be several explanations for this. Firstly, a large part of the data on which the model calibration is based is from the 1990's, where yields were lower than currently observed. Secondly, the current restrictions on fertiliser use in Denmark may have resulted in lower N contents in the grains (Olesen et al., 2004), which is not reflected in the observed N surplus, which is based on older values of product N contents.

## References

- Berntsen, J. et al., Evaluating nitrogen taxation scenarios using the dynamic whole farm simulation model FASSET, 2003. *Agric. Syst.* 76, 817-839.
- Olesen, J.E. et al., Comparison of methods for simulating effects of nitrogen on green area index and dry matter growth in winter wheat, 2002. *Field Crops Res.* 74, 131-149.
- Olesen, J.E. et al., Integrated nitrogen input systems in Denmark, 2004. In: Mosier, A.R., Syers, J.K., Freney, J.R. (eds.) *Agriculture and the nitrogen cycle: assessing the impacts of fertilizer use on food production and the environment.* SCOPE 65, Island Press, p. 129-140.

## NITRATE LEACHING IN SUB-SURFACE WATER FROM LOW-INPUT CLAY-HILL CROPPING SYSTEMS

Orsini R.<sup>1</sup>, Toderi M.<sup>1</sup>, De Sanctis G.<sup>1</sup>, Roggero P.P.<sup>2</sup>

<sup>1</sup> Dipartimento di Scienze Ambientali e delle Produzioni Vegetali, Università Politecnica delle Marche, via Brecce Bianche 60131 Ancona. Tel.: +39 (0)712204157, Fax: +39 (0)712204856, e-mail: [r.orsini@univpm.it](mailto:r.orsini@univpm.it)

<sup>2</sup> Dipartimento di Scienze Agronomiche e Genetica Vegetale Agraria, Università degli Studi, Via Enrico De Nicola 07100 Sassari. Tel +39 (0)79 229226, Fax +39 (0)79 229222, e-mail: [poggero@uniss.it](mailto:poggero@uniss.it)

### Introduction

The control of nitrate losses is usually considered as the first step towards a wider control of agricultural water pollution (Verloop et al., 2006). In this context, the aim of the research is to support the development of sustainable cropping productions, by providing new field-based scientific evidence on the bio-physical processes and agronomic practices influencing the dynamic of  $\text{NO}_3^-$  in the specific context of the clay hills of central Italy, where rainfed cropping systems are often based on a 2-yr rotation of durum wheat and sunflower.

### Materials and methods

A field experiment has been set up in 1997 (Orsini et al., 2004) on a 20% slope, characterised by silty-clay soils in the coastal hills of Marche (43,54°N; 13,38°E; mean annual precipitation = 703 mm  $\text{y}^{-1}$ ;  $T_{\text{max}} = 23,4$  °C,  $T_{\text{min}} = 4,3$  °C). The experimental device is made of 10 plots, which are isolated from surface runoff. In each plot, 2 tubular drain pipes were located at 0.9 m depth to intercept drainage water, which was sampled from 500 dm<sup>3</sup> backwater tanks to measure  $\text{NO}_3^-$  concentration. Three different cropping systems, in the context of a durum wheat - sunflower rotation, were compared, according to a randomised complete block design, with two replicates: (i) Organic (O): durum wheat (DW) - fallow period (FP) (i.e. ploughed soil) - sunflower (S), both crops grown in mixture with *Medicago polymorpha* L. and *Trifolium brachycalycinum* Katz. et Morley, fertilised with mature manure (90 kg  $\text{ha}^{-1}$  and 70 kg  $\text{ha}^{-1}$  of N respectively for DW and S) and no chemical weeding;

(ii) Low input (L): same rotation as O, but managed according to the regional agro-environmental prescriptions: 130 and 70 kg  $\text{ha}^{-1}$  of N; 100 and 80 kg  $\text{ha}^{-1}$  of  $\text{P}_2\text{O}_5$ , respectively for DW and S. In the three years, (i) and (ii) cropping systems had a DW-S-DW and S-DW-S crop succession in separate plots.

(iii) Zero input (Z): permanent unfertilised meadow (M), mixture of *Lolium perenne* L., *Festuca arundinacea* Schreb. and *Phalaris aquatica* L., managed with one chop per year.

Nitrate concentrations were converted to log before performing the two-way ANOVA.

The drainage water was classified into three categories, according to nitrate concentration: type I: high (>50 mg  $\text{L}^{-1}$ ); type II: low (between 10 and 50 mg  $\text{L}^{-1}$ ); type III: very low (<10 mg  $\text{L}^{-1}$ ). Only the most relevant drainage events in 2002-05 were reported in this paper.

### Results and discussion

Type I events were recorded in almost all hypodermic downflows that occurred within 30 days since the last N fertilisation in L cropping system and during the autumn-winter period in both L and O cropping systems (table 1). The highest  $\text{NO}_3^-$  concentration in drainage water was achieved in  $\text{L}_{\text{DW-S-DW}}$  cropping system after 3 and 19 days from last N fertilization of S in 2003-04 (225 mg  $\text{L}^{-1}$ ) and in 2004-05 after 26 days from N fertilization of DW (211 mg  $\text{L}^{-1}$ ). Type I hypodermic downflows were also observed in autumn-winter 2002-03 ( $\text{L}_{\text{DW-S-DW}}$  and  $\text{O}_{\text{DW-S-DW}}$ ) immediately after wheat sowing, when the soil was still bare (88 mg  $\text{L}^{-1}$ ). Similar events, with occasional  $\text{NO}_3^-$  concentrations above 50 mg  $\text{L}^{-1}$ , were observed in the other two years. Type II and type III events were observed when the soil was well covered by weeds (FP) or on main crops ( $\text{L}_{\text{S-DW-S}}$  and  $\text{O}_{\text{S-DW-S}}$ ), when downflows occurred long time after N fertilization.

**Table 1** – Hypodermic downflow and nitrate concentration (mg L<sup>-1</sup>) as influenced by the cropping system, time of application of fertilisers and crop type (FP = fallow, DW = durum wheat, S = sunflower, M = meadow).

	Date	Rain <sup>(1)</sup> (mm)	Sunflower-Durum Wheat-Sunflower						Durum wheat-Sunflower- Durum wheat						Meadow				
			Crop	Organic			Low input			Crop	Organic			Low input			Crop	Zero input	
				Drain <sup>(2)</sup>	NO <sub>3</sub> <sup>-</sup>	Days F <sup>(3)</sup>	Drain <sup>(2)</sup>	NO <sub>3</sub> <sup>-</sup>	Days F <sup>(3)</sup>		Drain <sup>(2)</sup>	NO <sub>3</sub> <sup>-</sup>	Days F <sup>(3)</sup>	Drain <sup>(2)</sup>	NO <sub>3</sub> <sup>-</sup>	Days F <sup>(3)</sup>		Drain <sup>(2)</sup>	NO <sub>3</sub> <sup>-</sup>
Farm year 2002-2003	06/12/02	95,4	FP	H	5 c	150	H	3 d	267	DW	H	151 a	79	H	131 b	206	M	H	3 e
	12/12/02	31,4	FP	H	7 b	156	H	5 b	273	DW	H	193 a	85	H	127 a	212	M	H	0 c
	25/12/02	52,8	FP	H	4 b	169	H	0 b	286	DW	H	140 a	98	L	91 a	225	M	H	3 b
	31/12/02	15,0	FP	H	10 b	175	H	0 c	292	DW	H	65 a	104	H	63 a	231	M	H	0 c
	09/01/03	32,2	FP	H	7 c	184	H	0 d	301	DW	H	60 a	113	H	43 b	240	M	H	0 c
	22/01/03	5,6	FP	H	9 b	197	H	0 c	314	DW	H	99 a	126	H	35 a	253	M	H	0 c
	04/03/03	44,8	FP	H	20 a	238	H	5 ab	355	DW	H	11 ab	167	H	29 a	23	M	H	0 b
Farm year 2003-2004	01/12/03	21,4	DW	H	64 a	110	L	40 a	211	FP	H			H			M	H	
	09/12/03	15,8	DW	H	28 a	118	H	39 a	219	FP	H			H			M	H	
	23/02/04	101,0	DW	H	29 a	194	H	12 a	295	FP	H			H			M	H	0 b
	27/02/04	29,8	DW	H	37 b	198	H	9 c	299	FP	H			H	54 a	344	M	H	0 d
	04/03/04	16,8	DW	H	47 b	204	H	16 c	305	FP	H	60 a	177	H	60 a	350	M	H	0 d
	21/04/04	83,2	DW	L	6 d	252	H	8 c	14	S	H	100 b	225	H	225 a	3	M	H	
	07/05/04	62,8	DW				H	3 b	30	S	H	79 a	241	H	225 a	19	M	H	0 b
Farm year 2004-2005	16/11/04	149,0	FP	H	56 ab	68	H		223	FP	H	56 ab	68	H	120 a	212	M	H	0 c
	06/12/04	43,8	FP	H	42 bc	88	H	20 c	243	FP	H	98 a	88	H	81 ab	232	M	H	0 d
	20/12/04	27,0	FP	H	30 b	102	H	14 c	257	DW	H	56 a	102	H	35 b	246	M	H	0 d
	21/01/05	37,4	FP	H	32 a	133	H	17 ab	289	DW	H	53 a	134	H	50 a	278	M	H	0 b
	02/02/05	87,2	FP	H	51 a	146	H	24 c	301	DW	H	50 a	146	H	33 b	290	M	H	0 d
	08/02/05	5,0	FP	H	35 a	152	H	22 a	307	DW	H	36 a	152	H	36 a	296	M	H	0 b
	23/02/05	24,6	FP	H	22 b	167	H	18 c	322	DW	H	22 b	167	H	29 a	311	M	H	0 d
	07/03/05	25,2	FP	H	35 ab	179	H	22 b	334	DW	H	34 ab	179	H	44 a	323	M	H	0 c
	11/04/05	74,4	S	H	65 b	214	H	33 c	369	DW	H	5 d	214	H	211 a	26	M	H	0 e

<sup>(1)</sup>Rains that yielded drainage. <sup>(2)</sup>Drainage was classified into three levels: 0 = zero, L = low (0 - 1 mm) and H = high (> 1 mm). <sup>(3)</sup>Days F = number of days since the last N fertilization or manuring. Means followed by the same letter are not significantly different (P < 0.05).

## Conclusions

The highest nitrate concentration of hypodermic downflow water were attributed to the drainage that occurred without soil cover or within 1 month since the last mineral N fertilization. Low nitrate concentration were observed (**i**) when the soil was highly covered by weeds, (**ii**) during the winter period on wheat after the leaching due to autumn drainages, (**iii**) before top fertilization and (**iv**) in the permanent meadow with zero input. In the arable clay and hilly soils of central Italy, low input or organic cropping systems are not free of pollution during water surplus periods when the soil is bare, particularly in the first drainage events in the autumn.

## References

Orsini R. et al., Nitrate leaching of low-input hill cropping systems. 2004. Book of Proceedings of VIII ESA Congress: European Agriculture in a Global Context, KVL-Copenhagen-Denmark, 11-15 July 2004, 781-782.  
Verloop J. et al. Reducing nitrate leaching to groundwater in an intensive dairy farming system. 2006. Nutrient Cycling in Agroecosystems (2006) 74, 59–74.

## **A SYSTEM ANALYSIS OF SOYBEAN-WHEAT AND SOYBEAN-CHICKPEA CROPPING SYSTEM UNDER ORGANIC, INORGANIC AND INTEGRATED CROP MANAGEMENT SYSTEM**

R. Lakpale, S.S. Tuteja and G.K. Shrivastava

*Department of Agronomy, Indira Gandhi Agricultural University, Raipur (CG) 492 006 INDIA*

*E-Mail: rlakpale@hotmail.com*

### **Introduction**

Now a days greater emphasis is being laid on the cropping system as whole rather than the individual crops in sequence because the response of the succeeding crops in a cropping system are influenced greatly by the preceding crops and the input applied therein. Maintenance of soil fertility is important for obtaining higher and sustainable yield due to large turnover of plant nutrients in the soil-plant system. Considering these facts, the field experiments were conducted during 2004-05 to 2006-07 at Instructional Farm, Indira Gandhi Agricultural University, Raipur (CG) to find out response of inorganic, organic and integrated crop management system on soybean-wheat and soybean-chickpea cropping system and soil nutrient status.

### **Methodology**

The field experiment was conducted during 2004-05 to 2006-07 at Instructional farm, Indira Gandhi Agricultural University, Raipur (CG) to find out response of inorganic, organic and integrated crop management system on soybean-wheat and soybean-chickpea cropping system and soil nutrient status. The treatment comprised of organic management system [(FYM @ 10t /ha + remaining quantity of P<sub>2</sub>O<sub>5</sub> through Rock phosphate, inoculation with *Rhizobium* and PSB, seed treatment with *Trichoderma harzianum* / *viride* + *Pseudomonas fluorescence* @ 5 g/kg seed, weed control through cultural practices and plant protection measures through plant/ microorganism products (bio-agents, bio-pesticides)], inorganic management (Recommended dose of chemical fertilizer, no seed inoculation, seed treatment with recommended fungicides, weed control through recommended herbicides and plant protection measures through recommended pesticides) and Integrated management [(50% organic and 50 % inorganic) (FYM @ 5 t/ha + 50% of RDF, inoculation with *Rhizobium* and PSB, seed treatment with *Trichoderma harzianum* / *viride* + *Pseudomonas fluorescence* @ 5 g/kg seed, weed control through pre-emergence herbicide + 1 hand weeding/ hoeing at 25-30 DAS (days after sowing) and plant protection measures through IPM (integrated pest management) practices)]. The experiment was laid out in strip plot design with four replications.

### **Results**

The results indicated that the seed yield of soybean was found maximum with soybean-chickpea cropping system. Significantly maximum number of branches per plant and pods per plant were recorded with inorganic management. Under soybean-chickpea cropping system significantly higher number of branches and pods were recorded as compared to soybean-wheat cropping system. Seed index and dry matter accumulation per plant recorded significantly maximum and similar with inorganic and integrated management system. Maximum seed index and dry matter were recorded significantly higher under soybean-chickpea cropping system than soybean-wheat system. Inorganic management gave significantly higher seed yield of soybean. System analysis of soybean based cropping system indicated that the soybean-equivalent yield was reported significantly maximum with integrated management system in soybean-chickpea cropping system. The system yield of soybean under soybean-chickpea cropping system was found maximum with integrated management system than the soybean-wheat cropping system. Analysis of soil nutrient status before and after 3 years of completion of experiment revealed that the except organic management system depletion pattern of organic carbon and soil available nitrogen was observed. Whereas, in case of available phosphorus and available K, integrated management system showed higher value than initial status. In general soybean-chickpea cropping system maintain/ build up organic carbon, available N, P and K status of soil (Table 1).

## Conclusions

Among the soybean-wheat and soybean- chickpea cropping system, soybean-chickpea cropping system was found superior in terms of sustainable productivity and in maintaining soil health. Organic management system although build up organic carbon and available nutrient in soil but considering system productivity, build up of available P and K integrated management proved superior.

**Table 1:** Effect of different management practices and cropping system on yield and yield attributes of soybean, productivity of soybean based cropping system and nutrient build up or depletion of soil

Treatments	Branches /plant (No)	Pods /plant	Seed index (g/100 seed)	DMA at harvest (g/plant)	Seed yield (q/ha)	Soybean equivalent yield (q/ha)	System yield (q/ha)	Build up / Depletion of available nutrients (kg/ha)			
								OC (%)	N	P	K
<i>Management x Cropping system</i>											
T1-Wheat	4.4	43.1	11.1	29.4	14.25	16.09	40.69	0.02	(-) 2	(-) 0.8	(-) 7
- Gram	4.8	44.3	11.3	31.5	16.80	16.87	26.50	0.03	5	(-) 0.5	3
T2-Wheat	5.5	64.8	11.4	32.2	14.76	17.87	44.12	(-) 0.03	(-)17	0.0	3
- Gram	6.0	67.9	11.9	34.5	17.85	20.61	29.70	0.00	(-) 2	0.4	5
T3-Wheat	5.1	57.4	11.6	31.0	13.50	18.59	44.04	(-) 0.04	(-)17	1.0	4
-Gram	5.7	64.2	11.8	37.0	16.45	21.13	28.60	(-) 0.01	3	1.1	7
SEm±	0.163	0.895	0.095	0.992	0.143	0.569	0.615	-	-	-	-
CD(0.05)	NS	2.86	NS	NS	NS	1.97	2.13	-	-	-	-
<i>Management</i>											
Organic	4.6	43.7	11.2	30.4	15.53	16.48	33.60	0.03	2	(-) 0.7	(-) 2
Inorganic	5.7	66.4	11.7	33.3	16.30	19.24	36.91	(-) 0.01	(-) 9	0.2	4
Integrated	5.4	60.8	11.7	34.0	14.98	19.86	36.32	(-) 0.02	(-) 7	1.0	6
SEm±	0.066	0.367	0.092	0.626	0.020	0.306	0.316	-	-	-	-
CD(0.05)	0.23	1.27	0.32	2.17	0.069	0.98	1.01	-	-	-	-
<i>Cropping System</i>											
Wheat	5.0	55.1	11.4	30.9	14.17	17.52	42.95	(-) 0.02	(-)12	0.0	0
Gram	5.5	58.8	11.7	34.3	17.03	19.54	28.27	0.01	2	0.3	5
SEm±	0.094	0.517	0.055	0.573	0.083	0.531	0.548	-	-	-	-
CD(0.05)	0.302	1.65	0.176	1.83	0.265	NS	NS	-	-	-	-

Initial (3 year before) soil nutrient status - C- 0.52%, N-227, P<sub>2</sub>O<sub>5</sub>- 17.8 and K<sub>2</sub>O- 327 kg/ha



## DESIGNING SUSTAINABLE CROPPING SYSTEMS: A GENERAL FRAMEWORK

N. Silvestri, G. Bellocchi

Department of Agronomy & Agro-Ecosystem Management, University of Pisa, Italy,  
[nsilve@agr.unipi.it](mailto:nsilve@agr.unipi.it), [g.bellocchi@isci.it](mailto:g.bellocchi@isci.it)

### Introduction

A cropping system (CS) is a combination of crop genotypes (species/cultivars) and agricultural practices, arranged in sequences running on the same fields (rotations) and affected by climatic and soil conditions. Technology available and social constraints (including market and legislative needs) influence also the farmer's choices and represent the contour conditions on whom basis implement the agricultural production processes. Farmers actually rely on their technical knowledge and practical experience, added to legacy in the social patterns of local cultures. CS are not defined with a rigorous evaluation plan when they are the result of extempore farmers' decisions. Application of formal rules may help to make the decisions' phase more transparent, rationalize the production technologies, and promote a self-learning process. A staged framework was developed (and illustrated with counter case-studies), where basic rules are captured into a coherent structure for CS successful managing with the involvement of multiple actors.

### General framework for cropping systems design

The conceptual framework for CS design is summarized in three stages (Tab. 1). Each stage is in reference to a different controlling actor.

Tab. 1. Conceptual framework for cropping systems design.

stage	actors	components		objectives	
		selection	organization	identification	verification
1. prior evaluation (private)	farmer	X	X	X	X
2. posterior evaluation (public)	institutions				X
3. managing the change (social)	involved parties	X	X	X	

The *prior evaluation* (1) is the analytical stage to investigate if: (1.1) the CS has been built based on the biophysical, technological and social restrictions of the cultivation site (components selection); (1.2) the technical choices meet a basic agronomic coherence (components organizations); (1.3) the goals pursued by CS satisfy durable and shareable demands (objectives identification). This is the 'private stage', where the farmer identifies the most efficient management to achieve his defined objectives. In case of unsatisfactory CS performances (income, productivity ...), the problematic issue will be well defined in time and space and a feed-back mechanism (objective verification) will lead the farmer himself (or his technical staff) to modify nature ad organization of CS components, in order to improve the behavior of the systems and achieve the expected outcomes (problem-solving approach).

The *posterior evaluation* (2) triggers off signals indicating the occurrence of undesired phenomena (e.g. environmental pollution) or discrepancies between the projected objectives and those actually occurred (e.g. rural decline). It focuses on problematic issues which may occur beyond the farm boundary and over long periods of time (with boundaries not precisely defined). The performances of all CS included in the piece of territory considered, will affect those contour conditions which are a reference for the farmer. Complex feed-back mechanisms emerge at this stage and difficult to determine (identification and quantification). For objective verification, actions are required to be taken from other actors than the farmer ('institutional stage'), and with larger access to resources and capabilities (consortiums, unions, the public health system, research centres ...). An environmental monitoring is the typical action to be taken at this stage to verify the unsuitability of farmer's choices. It has to be based on a reasoned sampling strategy (choice of variables to be measured, frequency and density of samples), with the purpose of defining spatial and temporal boundaries and gaining easily interpretable figures that express magnitude and rate of processes.

A collective-conducting approach is required for profound improvements in the CS architecture and changes of farmer's choices, likely impossible to be successful if set up by the farmers alone. In this context, wider issues come into light and it becomes necessary to implement the third stage of framework (3) where multiple actors are in the position to give guidance or advices on how *managing the change* ('social stage'). We advocate a participatory approach, through which stakeholders will influence and share control over recursive changing on components selection-organization and objectives identification. The assumption of responsibilities will be facilitated by participate solutions, while ensuring the rearrangement of private and public interests towards conditions of equilibrium more evolved than before.

To help the implementation of the framework, useful tools are: suitable check-lists in the prior evaluation stage, periodic environmental control plans in the posterior evaluation, and the organization of round-tables for changing the management on a local basis.

### Illustrative case-studies (counter examples)

The lacking adoption of the framework rules may bring about a number of problems and anomalies in the CS design, as in the examples of Tab. 2 (taken from Italian CS).

Tab. 2. Illustrative case-studies.

location / CS	problem / issue	framework conflict	measure taken
Pisa (IT), industrial and horticultural crops	rationalizing phosphorus fertilization	no evaluation of soil phosphorus natural availability (1.1)	budget-based fertilization
Lajatico (IT), winter cereals	coupling crop intensification and rotation	lack of agronomic coherence (1.2)	low intensification with complex rotations
Reggio Calabria (IT), legume-wheat rotations	maintaining soil organic matter content	no search of durable and agreed goals (1.3)	adoption of conservative soil tillage techniques
Lucca (IT), maize monoculture	preventing wells contamination by herbicides	wrong environmental monitoring: inexact boundary definition (2)	enlargement of sampled area
Lucca (IT), agriculture in the area of wells recharge	disseminating CS at low environmental impact	no composition of different interests (3)	participate solutions, protecting agriculture, low input CS

<sup>1</sup>Silvestri et al., 2002; <sup>2</sup>Silvestri et al., 1999; <sup>3</sup>Mazzoncini et al., 2000; <sup>4</sup><http://www.comune.lucca.it/life/index.htm>

### Conclusions

Development of sustainable CS is a dynamic process, taking into account a variety of constraints and needs, often contrasting and timely evolving. Adopting a recursively applicable framework for CS evaluation can help the decision-making process in agriculture and the link between farmer's private interests and the most general social interests. The framework illustrated provides a foundation to serve a diversity of goals. If a challenging target to be met by the framework is creation of new options while making easy the evaluation of the performances (inductive process), its effectiveness mainly stands to gain a procedural adoption for farmers, institutions, and society, contributing much in terms of educational usefulness other than in the application to actual cases. The framework may provide basis to simulation-based procedures used within integrated systems (e.g. <http://www.macaulay.ac.uk/LADSS>) and can be also supportive to add force to the social role which supranational institutions (e.g. European Union) assign to the agricultural sector. We have only begun to explore the full potentialities of the above framework. Future studies and applications will contribute further for increasing attention and consideration about the framework, to the accumulation of experience and the refinement of expertise in its implementation.

### References

- M. Mazzoncini et al., Crop management systems to conserve soil fertility after long-term set-aside in southern Italy, 2000. In: R.M. Rees et al., Sustainable management of soil organic matter, CAB Int., 163-172
- N. Silvestri et al. La scelta del sistema colturale negli ambienti collinari dell'Italia centro-occidentale. Nota I. Aspetti produttivi, 1999. Riv. di Agron. 4, 209-219
- N. Silvestri et al., Application of a georeferenced soil database in a protected area of Migliarino San Rossore Massaciuccoli Park, 2002. Proc. 7<sup>th</sup> European Society for Agronomy Congress, Cordoba, Spain, 655-656

## SUMMARY MODELS OF CROP PRODUCTION TO ADDRESS QUESTIONS ON RESOURCE-USE INTERACTIONS AND EFFICIENCIES AT FARM-SCALE

P. Tittone<sup>1,2</sup>, M. Corbeels<sup>2,3</sup>, M.T. van Wijk<sup>1</sup> and K.E. Giller<sup>1</sup>

<sup>1</sup>Plant Production Systems, Plant Science, Wageningen University. [Pablo.Tittone@wur.nl](mailto:Pablo.Tittone@wur.nl)

<sup>2</sup>Tropical Soil Biology and Fertility Institute of the International Centre for Tropical Agriculture (TSBF-CIAT)

<sup>3</sup>UMR SYSTEM, Centre de Coopération Internationale en Recherche Agronomique pour le Développement (CIRAD), France

### Introduction

In smallholder systems of sub-Saharan Africa (SSA) resources for crop production such as land, water, nutrients and labour are often available at sub-optimal levels, and their multiple interactions determine resource use efficiencies, crop productivity and system sustainability. Decisions on resource allocation are often made at farm rather than at plot scale. Use of generic summary models of crop production rather than complex mechanistic, process-based models shows promise in addressing cross-scale questions. Changing the spatio-temporal resolution of a model may lead to new processes becoming important, such as the spatial soil heterogeneity characteristic of these systems. Though simpler models generally have less explanatory power, they often perform as well as, or better than complex models, while the uncertainty caused by both lack of data and imperfect knowledge on some processes is better managed. We propose the use of a dynamic summary model able to capture essential processes and resource interactions that determine crop productivity in the short- and the long-term, while keeping a level of simplicity that allows its parameterisation, use and dissemination in the tropics.

### Methodology

The crop/soil model FIELD (Field-scale resource Interactions, use Efficiencies and Long term soil fertility Development, [www.africanuances.nl](http://www.africanuances.nl)) has been calibrated and tested against long term experimental data for major crops grown in smallholder systems of SSA to simulate resource interaction and their effect on resource capture and conversion efficiencies. The approach combines the use of field data, expert knowledge and, whenever possible in terms of data availability, detailed process-based models to generate functional relationships in the form of response curves or surfaces that can be built within the farm-scale summary model, reducing model calibration-parameterisation efforts. Detailed models can be calibrated against experimental data from locations where intensive research has been conducted, developing functions for an ample range of agroecological conditions to allow interpolation. This is the case when using the model DYNBAL (Tittone et al., 2006) that has been calibrated and tested for Kenya, to simulate potential and water-limited crop growth for a certain location. Here, we illustrate applications of the summary model FIELD in Kenya, while methodological details can be found in Tittone et al., 2007.

### Results

An example of a summary functions generated using DYNBAL is the relationship between planting date and the fraction of seasonal radiation intercepted by a maize crop (FRINT – Fig. 1 A). Functions to correct FRINT by planting date, plant density, crop/cultivar type are built into FIELD, which can then be used to simulate long-term scenarios of crop or soil management. Long-term experiments involving crop and soil management options are scarce in SSA. Fig. 1 B and C illustrate simulated and measured yield variability and changes in soil organic C for a sandy-loam soil in Central Kenya, with 13 years (or 26 seasons: the long and the short rains) of data for maize cultivated with and without annual applications of animal manure. Once the model is parameterised and tested for a certain location/crop, it is used in farm-scale analyses coupled with livestock and household subsystem models. Despite the use of summary functions in FIELD, the sensitivity of the model for explorations within the crop/soil subsystem is still satisfactory. Fig. 1 D-G illustrate a case from western Kenya: the model tested to simulate production of sweet potato was applied to predict yields in six fields where farmers normally grow this crop (often the poorest fields) (Fig. 1 D) and nutrient management options involving use of organic and mineral fertilisers were explored. In most treatment\*field combinations farmers' yields were improved, but crop responses were

dictated mostly by resource (nutrient, water) interactions, while single nutrient availabilities (soil + fertiliser) explained little of the yield variation.

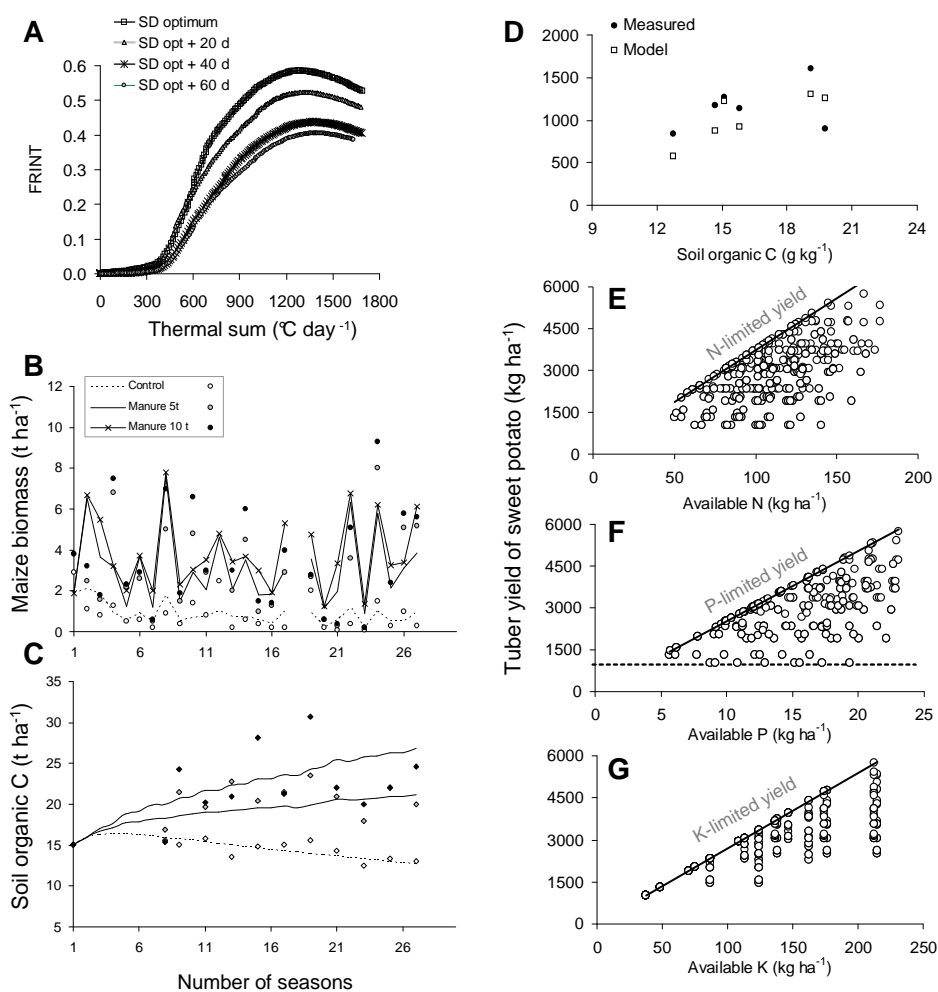

Figure 1: Simulations with the model *FIELD* – see text for explanation

## Conclusions

In data-scarce environments such as SSA, uncertainty in parameter values constrains the performance of detailed process-based models to analyse management options for smallholders. For example, to find out about crop residue management from farmers normally the ‘five-fingers method’ is used: out of these five fingers, how many fingers represent the fraction of residues incorporated to the soil, fed to livestock or used as fuel? Models often have to be parameterised with data collected in this way, subject to ample intrinsic error (i.e. at least 20% in this case). Under such circumstances, little gain in accuracy can be expected from increasing the degree of detail of the processes modelled. Likewise, models requiring a large number of parameters force model users in SSA to make use of a large number of ‘guesstimates’ for parameters that are seldom measured in practice. In analysing questions on system design and resource allocation at farm scale in SSA, simple yet dynamic models of the various subsystems (crop, soil, livestock, manure) may suffice. Such models can also be seen as ‘process-based’, but using a level of detail (and a temporal step) relevant to the scale of the questions raised.

## References

- P. Tittonell et al., Exploring diversity of crop and soil management within smallholder African farms: a dynamic model for simulation of N balances and use efficiencies at field scale. *Agric. Sys.* 91, 71 – 101.  
 P. Tittonell et al., Nutrient use efficiencies and crop responses to N, P and manure applications in Zimbabwean soils: Exploring management strategies across soil fertility gradients, 2007. *Field. Crop Res.* 100, 348-368.

## CEREAL AND FORAGE CROPPING IN THE LOMBARDY PLAIN. YIELD AND EVOLUTION OF SOIL FERTILITY IN THE FIRST 12-YEAR OF TRIAL.

C. Tomasoni, L. Borrelli

CRA-Istituto Sperimentale per le Colture Foraggere, viale Piacenza 29 – Lodi, Italy. agro@iscf.it

### Introduction

In the area of the Po valley, on sandy-loam soils, with high availability of water for irrigation, the annual rotation of Italian ryegrass followed by silage maize as second crop (R1) is the most efficient rotation for a farming system aimed to dairy cattle. In the last few decades, a change of the Italian agriculture systems has been advocated to limit environmental risk, in particular in those zones where the pedo-climatic conditions have allowed a high intensification of the agricultural activity. This work aims at comparing alternative crop rotation systems characterized by better environmental sustainability and assess their effects on soil fertility.

### Methods

Since 1985, the trial is carried out at Lodi (45°19' N, 9°30', 81,5 m asl) and it is structured in 5 cropping systems type: R1 = 1-yr continuous monoculture of Italian ryegrass (*Lolium multiflorum* L.) + silage maize (*Zea mais* L.); R3 = 3-yr rotation of Italian ryegrass + silage maize – silage barley (*Hordeum vulgare* L.) + silage maize – grain maize; R6 = 6-yr rotation of Italian ryegrass + silage maize (3 years) – rotational meadow (*Festuca arundinacea* Schreb. + *Trifolium repens* L.) (3 years); PM = a monoculture of permanent meadow and MM = grain maize grown in continuous monoculture. Each rotation was submitted to two crop management practices (input): A (optimal) and B (70% of A), including levels of nutrients, weed control and soil tillage methods (Onofrii *et al.*, 1993). The trial is irrigated with a volume of water supply of approximately 1000 m<sup>3</sup> ha<sup>-1</sup> per turn with no difference between the two levels of input, and following the common turn for the area with one irrigation every 14 days. The management practices were executed with a normal machine equipment for a farm. The experimental design, on an annual basis, was a strip-split-plot with three replicates and elementary plots of 60 m<sup>2</sup>; all the crops were present at the same time every year, so as to cancel the crop-year interaction within each rotation. The trial environment is representative of the pedo-climatic characteristics in the alluvial Po Valley, with sandy-loam soils of the Hapludalf family with sub-acid reaction, medium provision of N, good of P and insufficient of K. The climate is typical of the Po Region, i.e. sub humid with average annual rainfall of 800 mm and average mean daily temperature of 12.2 °C (Borrelli and Tomasoni, 2005). A statistical analysis was carried out for the production of Milk Feed Units (MFU) and the level of various agronomic parameters after 12 years of test.

### Results

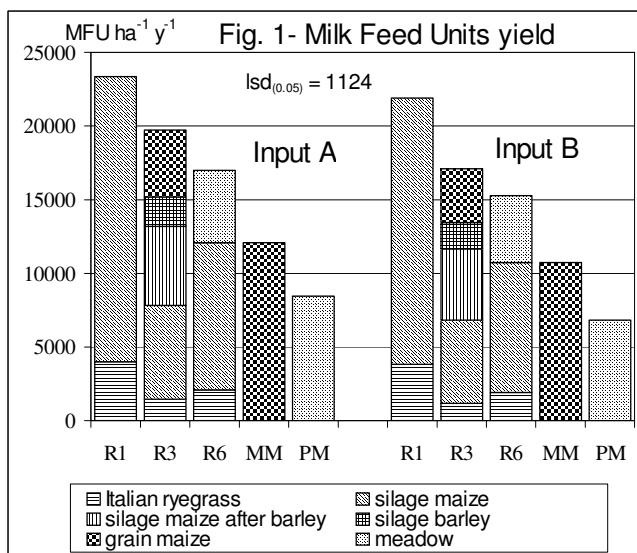

The results of the average annual MFU yield and evolution of the soil fertility (N-P-K-OM) during a 12-yr period (1986-97) are here reported. The annual rotation of Italian ryegrass followed by silage maize as the second crop (R1) confirmed to be the most interesting rotation in terms of MFU with 23,000 MFU yield year<sup>-1</sup> ha<sup>-1</sup> 83% of which deriving from silage maize and the residual 17% from Italian ryegrass. The lowest MFU yield was with PM with 8,500 MFU year<sup>-1</sup> ha<sup>-1</sup>, considering the ordinary input level A. The 6-yr rotation (R6) gave 17,000 MFU year<sup>-1</sup> ha<sup>-1</sup>, 58% of which from silage maize, 12% from Italian ryegrass and 30% from the meadow (Fig. 1). This last rotation is the agronomically best balanced crop system as

it combines a good productivity with the advantages for the environment and an optimal control of weeds (Tomasoni *et al.* 2003). Moreover, it experiences little productive oscillations between years. The productive decrease between the management levels A and B (-11%) was lower than the reduction in input amount (-30%).

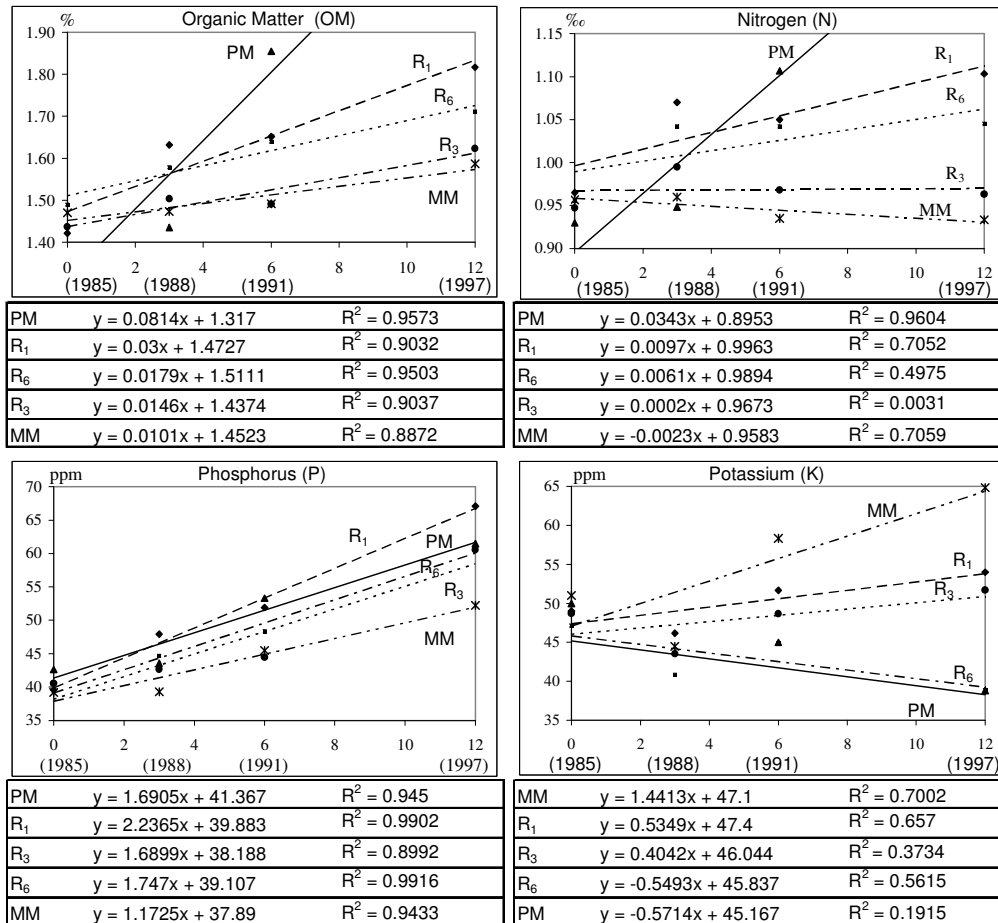

Figure 2. OM, N, P and K variations in the soil after 12 years

The input levels did not result in significant effects for the evolution of soil fertility. Figure 2 shows the trends of the recorded fertility parameters across the two input levels. The variation of nitrogen (N) in the time was positive in all cropping systems, except in the monoculture of grain maize (MM) ( $b = -0.0023$ ,  $R^2 = 0.71$ ). The percent variation of organic matter (OM) was positive in all cropping systems and the greatest increase was in the permanent meadow (PM) ( $b = 0.0814$ ,  $R^2 = 0.96$ ). The highest nitrogen enrichment of the soil in the crop systems was +44% with PM, whereas the largest decrease was with MM (-0.03%). Under the test conditions an appreciable increase of P was registered in all systems, which supports the possibility of a reduction of the phosphorous input. The variation of K was negative in all the rotations that include the meadow, R6 (-17.6%) and PM (-22.3%).

### Conclusions

The results evidenced that the cereal-forage rotation was the best cropping system able to enhance the fertility of soil and better exploit the favorable environmental resources. Rotations of forage crops, even short ones, were able to confer greater yield and maintain a stable soil fertility in comparison to continuous cereal cultivation. Introduction of alternative crop rotations require additional investigations on the effect on animal feeding systems and considerations on farm gross margin.

### References

Borrelli, L., Tomasoni, C., 2005. *Annali ISCF*, vol. IX, 43-49.  
 Onofrii, M., Tomasoni, C., Borrelli, L., 1993. *Riv. Agron.*, 3, 160-172.  
 Tomasoni, C., Borrelli, L., Pecetti, L., 2003. *European Journal of Agronomy*, 19, 439-451.

## PROTOTYPING CONNECTED FARMING SYSTEMS AT A SMALL TERRITORY SCALE

X. Coquil<sup>1</sup>, A. Blouet<sup>2</sup>, J.L. Fiorelli<sup>1</sup>, C.Mignolet<sup>1</sup>, C. Bazard<sup>1</sup>, D. Foissy<sup>1</sup>, J.M. Trommenschlager<sup>1</sup>, M.Benoît<sup>1</sup> and J.M. Meynard<sup>3</sup>

<sup>1</sup> INRA, UR055 SAD Mirecourt, 662 avenue Louis Buffet, F-88500 Mirecourt, [coquil@mirecourt.inra.fr](mailto:coquil@mirecourt.inra.fr)

<sup>2</sup> Université H.Poincaré Le Montet, F-54600 Villers-les-Nancy, [blouet@mirecourt.inra.fr](mailto:blouet@mirecourt.inra.fr)

<sup>3</sup> INRA, Département SAD, bâtiment EGER, F-78850 Thiverval-Grignon, [meynard@grignon.inra.fr](mailto:meynard@grignon.inra.fr)

### Objectives

Sustainability of agriculture invites us to a multi-criteria approach. Considering environmental sustainability of farming systems, many criteria can be taken into account like water and air quality, soil fertility, biodiversity, energy consumption etc, more or less scientifically known. The research team of Mirecourt INRA station prototypes farming systems building a partnership with the nature (agriculture insuring the reproduction of natural resources). We postulate that the partnership will be obtained by prototyping agricultural systems structured by territory properties and self-sufficient at an agricultural territory scale (Mignolet et al., 2004). Self-sufficiency at a local scale will be achieved by (i) the adoption of organic agriculture rules, promoting low-input and uncontrolled low-output flows and (ii) by connecting such farming systems in a local area in order to maintain the integrity of the local resources. In this paper, we present the method used to prototype multi-objectives farming systems and the connected prototypes of farming systems obtained.

### Prototyping multi-objectives systems

Sustainable farming system includes various conflicting aims which have to be solved within the farm system and in its articulation with other systems. Prototyping method follows three iterative steps consisting in (i) designing production systems according to the defined objectives they have to achieve, (ii) evaluating systems by experimentation at the system scale and (iii) modelling biotechnical and operational processes implicated in the experimented systems operation. In Mirecourt INRA station, system designing was done, using a method adapted from Vereijken (1997), by consulting a multi disciplinary group of scientific experts. The main objectives for both prototype were: (i) preserve resources like water and air quality and fossile energy, (ii) be productive (iii) use environmental compounds, like animal and vegetal biodiversity and soil fertility, for agricultural systems purpose. The experts had to disaggregate main objectives in sub-objectives targeted on sub-systems or managed units of the global systems, approaching a more operating level of organisation. Then, they classified these sub-objectives by a determined method of notation. This classification determined (i) the relative importance to give to each objective while determining decision rules used to manage the prototypes and (ii) the weight given to each criterion evaluating the achievement of the objectives in the global evaluation of the prototype. Designed systems are evaluated in an experiment at the system scale. The two connected dairy systems tested since 2004 in Mirecourt experimental station are low-input systems in accordance with the specifications of the organic farming rules: a grazing system (GS) and a mixed crop dairy system (MCDS). In order to design those systems according to the above three objectives, the 240 hectares of the experimental site were considered as a small agricultural territory. Considering the local economic context, farming systems are connected by (i) their design, using optimally the heterogeneity of the natural resources while assuring their sustainability (ii) their functioning, facing the lack of inputs at a single system level by local and equivalent exchanges between the two systems and smoothing the curve of the sales of animal products (milk, calves) at the small region scale. Farming systems are managed following constant decision rules (Sebillotte and Soler, 1990; Reau et al., 1996) and evaluated. Since 2004, experimental evaluation focuses on (i) biotechnical processes implicated in the prototypes and (ii) convenience of the systems and the decision rules used to manage them.

The instrument of agro-ecological evaluation was built considering pedo-climatic properties of the fields, demographic and genetic properties of the cattle, and practices already implemented and foreseen to manage them. It relies on basic measures on the dairy herd (milk production, growing and reproduction performances etc.), and on 76 sampling plots of 900 m<sup>2</sup> in the fields concentrating agronomic and environmental measures (crop yield, vegetal biodiversity, carabidae populations etc.). Evaluation at the sub-system scale by building analytical trials in the systems can be carried out.

Convenience of the systems is evaluated through the convenience of decision rules used to manage them. This relies on regular meetings aiming at decision making on technical aspects between scientists, pilot of the prototypes and technical staff. Debates and arguments are noticed and can be analysed in order to identify an eventual and/or a necessary evolution of the cognitive action model (Sebillotte and Soler, 1990) used to build a decision rule. So we focus on the constance of (i) the objectives, (ii) the criteria used by the pilot and the staff to evaluate the achievement of the objectives and (iii) decision rules applied to achieve the objectives.

Modelling aims at an *ex ante* evaluation of the sustainability of the overall system connected or not to other systems, and of sub-systems or management units. *Ex ante* sustainability assessment can be handled by multi-criteria decision aiding (MCDA) methodologies (Sadock *et al.*, 2007). This kind of model allows virtual experimentation. Virtual experimentation is complementary to classical experimentation (Meynard *et al.*, 2001): (i) designed systems (by groups of experts) can be classified and selected on the base of their sustainability, evaluated *ex ante* using interactive simulations, (ii) systems sustainability can be evaluated rapidly in different contexts. Classical experimentation is necessary to estimate some parameters of the model (depending on local context etc.) and to test the accuracy of the model in predicting the performances of the systems or sub-systems.

Since this year, we are elaborating an indicator-based MCDA model developed within a decision support tool called DEXi (Bohanec, 2007) for *ex ante* evaluation of the sustainability of grazing dairy systems. In this kind of model, system sustainability is decomposed in less complex sub-problems down to the level of input attributes representing the sustainability criteria of the system. Criteria can be expert-based or scientific indicators. Evaluation of the systems sustainability is performed by an overall aggregation that is carried out from bottom to the top of hierarchy according to its structure and defined utility functions (Bohanec, 2007). Utility functions used for each level of aggregation are based on transparent and qualitative decision rules (Sadock *et al.*, 2007).

#### **Discussion/Prospects:**

The prototypes design could have been done using model based methods taking into account expert knowledge by (i) systematic design and *ex ante* evaluation methods like Rotat and Farm Images (Dogliotti *et al.*, 2005), or (ii) interactive simulation, involving a group of experts, using for example an indicator-based MCDA model. But until now, no systematic design and *ex ante* evaluation model or MCDA have been built to evaluate mixed-crop dairy system sustainability. We plan to build an indicator-based MCDA model for *ex ante* evaluation of the sustainability of innovative mixed-crop dairy systems.

Prototypes evaluation is set in an experimental station because it allows a high pressure of measures on a prototype and an analyse of the evolution of the cognitive action model. But, prototyping in commercial farms will be necessary in order to (i) evaluate the prototypes in different socio-economic and pedo-climatic contexts and (ii) evaluate the convenience of decision rules in different cognitive action models. By increasing the field of validity of the prototype, prototyping in commercial farms will also contribute to the improvement of the MCDA model built on the basis of accumulated knowledge.

#### **References**

- M. Bohanec, DEXi: A Program for Multi-Attribute Decision Making, 2007.
- S. Dogliotti *et al.*, A method for exploring sustainable development options at farm scale: a case study for vegetable farms in South Uruguay, 2005. *Agricultural systems* (86), 29-51.
- J.M. Meynard, *et al.*, L'évaluation et la conception de systèmes de culture pour une agriculture durable, 2001. *Acad. Agric. Fr.*, 87 (4) 223-236.
- C. Mignolet *et al.*, Concevoir des systèmes de production économes et autonomes et modéliser leur organisation au sein des territoires, 2004. *Colloque SFER 2004/11/18-19*, 1-14.
- R. Reau *et al.*, Des essais factoriels aux essais « conduite de culture », 1996. *Com. Potentialités. ACTA* 52-62.
- W. Sadock *et al.*, An indicator-based MCDA framework for *ex ante* assessment of the sustainability of cropping systems, 2007. *FSD-Catania Italy*.
- M. Sebillotte *et L.G. Soler*, Les processus de décision des agriculteurs, 1990. *Modélisation systémique et système agricole : décision et organisation*. Brossier *et al.* INRA eds. 93-117.
- P. Vereijken, A methodical way of prototyping integrated and ecological arable farming systems (I/EAFS) in interaction with pilot farms, 1997. *Europ J. Agronomy*. 7, 235-250.



## Greenhouse soil fertility in organic, low-input and conventional management: a case study in Hebei Province of China

Y.L. Xie<sup>1</sup>, R. Mancinelli<sup>2</sup>, J. Li<sup>1</sup>, E. Campiglia<sup>2</sup>

<sup>1</sup> Dept. of Ecology and Ecological Engineering, China Agricultural Univ., Beijing, China, xieyongli@126.com

<sup>2</sup> Dept. of Crop Production, University of Tuscia, Viterbo, Italy, mancinel@unitus.it

### Introduction

In recent years, a decline in soil fertility has been reported in different regions around the world. This basically resulted from less input of organic matter and large use of agro-chemicals. Sustainable soil management simultaneously aims at preventing degradation of soils and water quality, protecting the potential of natural resources and maintaining or enhancing food production (Schjonning et al., 2004). Organic agriculture has been proved to contribute positively to the increase of soil fertility and biodiversity (Rees et al., 2001). As a major actor of soil biodiversity, earthworms play an important role in promoting soil fertility in agroecosystems (Werner & Dindal, 1989). The objective of this study was to examine the effect of contrasting soil managements in greenhouse vegetable crop systems on chemical, physical and biological characteristics of the soil.

### Materials and Methods

This study is part of a long-term experiment carried out in Quzhou County of Hebei Province (PR China), which started in spring 2002 on silt fluvo-aquic soil. It was conducted in three side-by-side greenhouses differently managed: organic (Org), low-input (Low) and conventional (Conv). The Org management was adopted in accordance with the IFOAM Basic Standards using organic fertilizers (66 t ha<sup>-1</sup> year<sup>-1</sup> of manure), with no-use of chemical pesticides. The low-input management was adopted in accordance with the traditional agricultural practices with reduced chemical pesticides and organic fertilizers (33 t ha<sup>-1</sup> year<sup>-1</sup> of manure) plus chemical fertilizers (N = 290 kg ha<sup>-1</sup> year<sup>-1</sup>; P<sub>2</sub>O<sub>5</sub> = 190 kg ha<sup>-1</sup> year<sup>-1</sup>; K<sub>2</sub>O = 220 kg ha<sup>-1</sup> year<sup>-1</sup>). The Conv management consisted of treatments with chemical pesticides and fertilizers (N = 560 kg ha<sup>-1</sup> year<sup>-1</sup>; P<sub>2</sub>O<sub>5</sub> = 330 kg ha<sup>-1</sup> year<sup>-1</sup>; K<sub>2</sub>O = 250 kg ha<sup>-1</sup> year<sup>-1</sup>). In the three greenhouses, whose total size was 1280 m<sup>2</sup>, an irrigated tomato-cucumber rotation was adopted.

The soil samples were collected at the beginning of the project for the chemical and physical analysis, and just before and after each crop harvesting for chemical analysis at two soil depth (0-20 and 20-40 cm). Soil organic matter (SOM) was estimated with the potassium dichromate external heating method; total nitrogen (TN) was determined with the Kjeldhal method; total phosphorous (TP) was determined with the molybdenum-antimony anti-colorimetric method, available potassium (K) was determined with the ammonium acetate flame photometry method.

Earthworms were collected 5 times in the period March-June 2006. The samples were taken by hand sorting from soil cores of 30×30×20 cm at soil depth of 0-20 and 20-40 cm, three samples for each system management, choosing the optimum soil moisture, for each sampling date.

Analysis of data was performed to evaluate the main effects of soil management using the ANOVA procedure of the SAS program.

### Results

The soil chemical and physical properties at the beginning and at the end of the experiment are reported in table 1. The analyzed soil parameters result generally increased over the 4-year period, with very similar patterns at different depth. In both the 0-20 and 20-40 cm soil layers, four years of contrasting soil management induced significantly large differences among the three management regimes in TN, TP, K, C/N ratio and SOM, with markedly higher increase in the organically managed soil in comparison with the conventional one. After four years of different soil management, the bigger variation between Org and Conv has been observed in K and SOM at 0-20 cm soil depth. These results are in accordance with other previous research, which has shown that soils in organic regime have higher increase of soil organic matter and soil nutrients in comparison with the conventional ones supplied with chemical fertilizers (Andrews et al, 2002).

The soil earthworm abundance is reported in figure 1. Four years of contrasting soil management were enough to produce a consistent significant difference in the soil earthworm abundance. A wealth of earthworms was observed mainly in the organic regime at 0-20 depth, with decreasing

population in low-input and Conventional managements. Therefore, the soil fertility condition with high SOM content in the organic regime determined the best situation for the increase of earthworm population. At the beginning of the spring period, the earthworm population was higher at 0-20 cm soil depth than at 20-40 cm, probably because the activity of earthworm was more strengthened and the population enlarged with combining soil tillage with organic amendment. At the beginning of summer, the earthworm population in the top layer dropped to the minimum, most earthworms being living under the arable layer during this season.

Table 1 - Chemical and physical properties of soil in 2002 and 2006 (within each group of soil depth and year, values with different letters are significantly different at  $P \leq 0.05$ )

	Total N (%)		Total P (%)		Available K (ppm)		C/N ratio		SOM (%)	
	0-20	20-40	0-20	20-40	0-20	20-40	0-20	20-40	0-20	20-40
2002										
Conventional	0.136a	0.074a	0.222a	0.108a	212.8b	135.3a	8.1a	6.8a	1.89a	0.86a
Low-input	0.119b	0.068a	0.124b	0.079b	364.3a	131.2a	7.4a	6.1a	1.53b	0.71a
Organic	0.117b	0.077a	0.138b	0.104a	257.3ab	129.3a	8.3a	7.2a	1.66b	0.96a
2006										
Conventional	0.185c	0.101b	0.249b	0.155b	348.2c	248.1c	8.7b	8.7a	2.79c	1.52b
Low-input	0.243b	0.126b	0.215c	0.120c	546.2b	364.6b	9.3a	8.4a	3.90b	1.83b
Organic	0.352a	0.157a	0.270a	0.174a	734.2a	489.7a	9.5a	9.6a	5.79a	2.59a
<i>Conventional</i> <sup>(1)</sup>	**	**	*	**	***	**	**	*	**	**
<i>Low-input</i> <sup>(1)</sup>	***	***	***	***	*	***	***	*	***	***
<i>Organic</i> <sup>(1)</sup>	***	**	***	***	***	***	**	***	***	***

<sup>(1)</sup>Significance of t-test comparisons for each management regime between years (2002 vs. 2006)

Figure 1 - Earthworm population during the tomato crop growth in 2006 (within each group, bars with different letters are significantly different at  $P \leq 0.05$ )

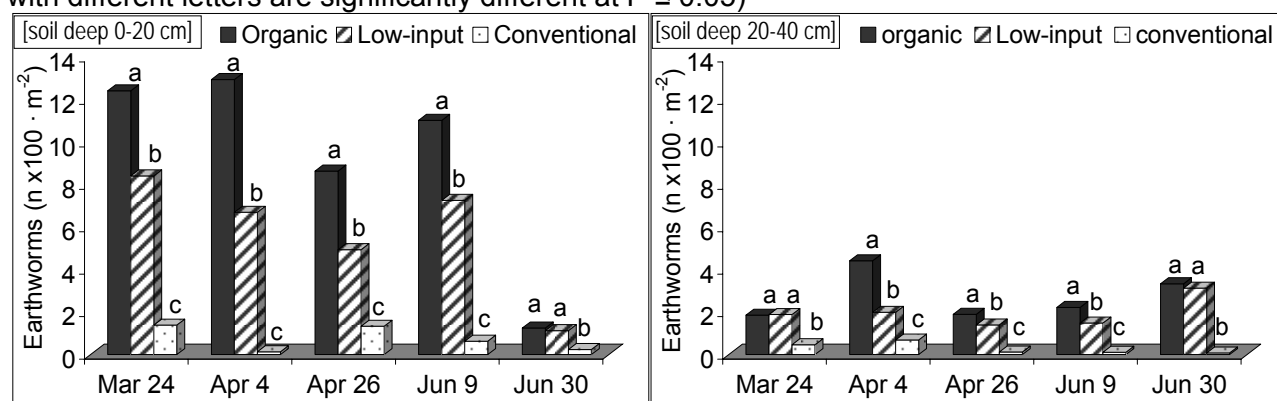

## Conclusions

The organic fertilizer application in greenhouse was beneficial to improving the value of several indicators of soil chemical fertility. In addition, the organic management practices were able to influence positively the distribution and activities of the earthworm population in the soil and therefore the soil quality. These results confirm the general rule that, wherever it is possible and economically feasible to use organic manure, benefits to soil quality improvement are to be expected in both organic and conventional farms.

## References

- Andrews S.S., Mitchell J.P., Mancinelli R., Karlen D.L., Hartz T.K., Horwath W.R., Pettygrove G.S., Scow K.M., Munk D.S., 2002. On-Farm Assessment of Soil Quality in California's Central Valley. *Agron. J.* 94, 12-22.
- Rees R.M., Ball B.C., Campbell C.D., Watson C.A., 2001. Sustainable management of soil organic matter. CABI, London.
- Schjonning P., Elmholt S., Christensen B.T., 2004. Managing Soil Quality: Changes in Modern Agriculture. CAB International.
- Werner M.R., Dindal D.L., 1989. Earthworm community dynamics in conventional and low-input agro-ecosystems. *Rev. Ecol. Biol. Sol.* 26, 427-437.

## The Ecologically Optimum Application of Nitrogen in Rape Season of Rice-Rape Cropping System

Xinqiang Liang, Hua Li\*, Yingxu Chen, Zhijian Zhang, Miaomiao He

Dep. of Environmental Engineering, Zhejiang University, China, [liang410@zju.edu.cn](mailto:liang410@zju.edu.cn)

### Introduction

Because excessive application of N fertilizer for crop production leads environment pollution and low N utility efficiency, a better understanding of the effects of N application rates on crop yields and  $\text{NO}_3^-$ -N leaching is required for developing optimum ecological nitrogen management that reduces  $\text{NO}_3^-$ -N leaching while keeping crop yield.

### Methodology

Field experiments at two sites (SQ and YH) in Taihu region of China were conducted to study the ecologically optimum application of N in rape (*Brassica Napus*) season of rice-rape cropping system. The leaching or crop year was defined as from NOV through the next May and was named according to the site name and the starting year. For example, SQ-2004 meant from NOV 2004 to May 2005 at SQ site.

The experimental field at either site consists of 15 plots (4 m × 5 m) and a strip of 0.3 m land was left between the plots. The field experiment was conducted using a completely randomized block design with three replicates for five urea treatments, receiving 0, 90, 180, 270 and 360 kg N ha<sup>-1</sup> respectively.  $\text{NO}_3^-$ -N in leachate were collected by wedge-shaped fiberglass wick lysimeters. The flow-weighted  $\text{NO}_3^-$ -N concentrations for different seasons and sites were calculated by summing up  $\text{NO}_3^-$ -N masses collected for the seasons divided by the total leachate volume collected in the corresponding seasons. The crop yields were determined on the inner 20 m<sup>2</sup> (4 m × 5 m) of each plot. For each growing season, quadratic curves were fitted to express the crop grain yield responses to the applied urea N rates, and general lines were fitted to express the  $\text{NO}_3^-$ -N leached mass responses to the N rates, separately.

### Results

Table 1 Comparison of nitrogen optimal rate ( $N_{\text{opt}}$ ), corresponding leached nitrate-N (L), and yield ( $Y_{\text{opt}}$ ) under economically and ecological optimal fertilizations.

Site-year	Economically optimal fertilization			Ecological optimal fertilization			Difference¶		
	$N_{\text{opt}}$	$L_{\text{opt}}$	$Y_{\text{opt}}$	$N_{\text{opt}}$	$L_{\text{opt}}$	$Y_{\text{opt}}$	$N_{\text{opt}}$	$L_{\text{opt}}$	$Y_{\text{opt}}$
	kg N ha <sup>-1</sup>	kg N ha <sup>-1</sup>	kg ha <sup>-1</sup>	kg N ha <sup>-1</sup>	kg N ha <sup>-1</sup>	kg ha <sup>-1</sup>			
SQ-2004	217.1	20.2	4336.4	176.6	17.1	4181.4	**	**	*
SQ-2005	228.9	37.3	4560.7	142.6	26.2	4089.8	**	**	*
YH-2005	209.3	47.5	4022.4	125.3	32.5	3501.7	**	**	*
Difference†	*	**	*	**	**	*			
Difference‡	**	**	**	**	**	**			

\*\* Significantly different at the 0.01 level. \* Significantly different at the 0.05 level.

† Differences between 2004 and 2005 years at SQ. ‡ Differences between SQ and YH sites in 2005.

¶ Differences in  $N_{\text{opt}}$ ,  $L_{\text{opt}}$ , and  $Y_{\text{opt}}$  between economically and ecological optimal fertilizations.

The economically optimum yield was available by applying more urea N fertilizer, but it reversely enhanced more  $\text{NO}_3^-$ -N leaching. In the SQ-2005, the economically optimum yield reached 4560.7 kg ha<sup>-1</sup>, but it received a  $\text{NO}_3^-$ -N leaching mass of 37.3 kg N ha<sup>-1</sup>, which was significantly higher than

that in the SQ-2004 at  $p = 0.01$  level due to the larger precipitation (Table 1). In the YH-2005, significant difference was not observed in precipitation at  $p = 0.05$  level due to the plain meteorology in the Taihu region. The  $\text{NO}_3^-$ -N leaching mass at the economically  $N_{\text{opt}}$  in YH-2005 reached  $47.5 \text{ kg N ha}^{-1}$  which was significantly higher than either SQ-2004 or SQ-2005 at  $p = 0.01$  level, mostly attributing to the difference from soil textures.

The ecologically optimum N rate was related to both soil site and crop growing condition. The ecologically optimum N rate in the SQ-2005 ( $142.6 \text{ kg N ha}^{-1}$ ) was significantly lower than SQ-2004 ( $176.6 \text{ kg N ha}^{-1}$ ) at  $p = 0.01$  level, but the corresponding yields were not significantly different between two seasons at  $p = 0.05$  level. This suggests that less urea can be applied to rape in the rain abundant season while keeping the grain yield. Simultaneously, the ecologically optimum N rate and yield in the YH-2005 were significantly lower than either SQ-2004 or SQ-2005 at  $p = 0.01$  level.

By comparison of economically and ecologically optimum N fertilization, it could be found that the economically  $N_{\text{opt}}$  and  $\text{NO}_3^-$ -N mass in leachate every season at SQ or YH were significantly higher than the ecologically  $N_{\text{opt}}$  and the corresponding  $\text{NO}_3^-$ -N mass in leachate at  $p = 0.01$  level, but the corresponding yields were only lower at  $p = 0.05$  level for all seasons. In the SQ-2004, the yield under ecologically optimum fertilization was only cut by 3.6%, while the N rate and  $\text{NO}_3^-$ -N mass in leachate were cut by 10.3% and 15.0%, respectively. In the SQ-2005, the yield decreased by 10.3% but the N rate and  $\text{NO}_3^-$ -N mass in leachate decreased as high as 37.7% and 29.8%, respectively. In the YH-2005, the decreases of N rate and  $\text{NO}_3^-$ -N mass in leachate reached 40.1% and 31.6% following a small decrease of yield by 12.9%.

## Conclusions

The calculated economically optimum N rate for rape was more site related than depending on changing growing conditions from year to year, while the ecologically optimum N rate was significantly different both at sites and growing conditions ( $p = 0.01$ ). The ecologically optimum N rates of  $90\sim 150 \text{ kg N ha}^{-1}$  were suggested to apply to rape season of a rice-rape rotation, because the rape yields at those rates only reduced about 5% to 11% but the  $\text{NO}_3^-$ -N masses in leachate were cut by about 16% to 30% as compared with economically optimum N fertilization.

## References

- D.G. Bullock et al. Quadratic and quadratic-plus plateau models for predicting optimal nitrogen rate of corn: a comparison, 1994. *Agronomy J.* 86,191–195.
- A. Dobermann et al. 2003. Estimating indigenous nutrient supplies for site-specific nutrient management in irrigated rice. *Agronomy J.* 95(4), 924–935.
- F. Nevens et al. Agronomical and environmental evaluation of a long-term experiment with cattle slurry and supplemental inorganic N applications in silage maize, 2005. *Europ. J. Agron.* 22:349–361.

**Session 2.5:  
Sustainability indicators at the farming systems  
level**

**Session Convenors:  
Christian Bockstaller and Concetta Vazzana**

## A METHODOLOGY TO ASSESS THE DIVERSIFICATION AND INTEGRATION OF FARMING SYSTEMS

M.C. Rufino<sup>1,2</sup>, H. Hengsdijk<sup>1</sup>, A. Verhagen<sup>1</sup>

<sup>1</sup>Plant Research International, Wageningen University and Research Centre, The Netherlands  
[mariana.rufino@wur.nl](mailto:mariana.rufino@wur.nl)

<sup>2</sup>Plant Production System Group, Wageningen University, The Netherlands

### Introduction

Diversification is an adaptive strategy to reduce the vulnerability of rural households because it allows them to use a combination of resources thus reducing risk for income generation. Diversification and integration are often associated with the sustainable and efficient use of resources in farming systems. In integrated systems, emphasis is on interaction among and within the biological components of the system, where there is explicit connectivity and less dependency on external inputs (Edwards et al. 1993). Cycling of energy and biomass is considered one of the most important features related to stability and ecosystem functioning. Although there have been several studies that focus on integrated farming systems there is no practical methodology to characterise, quantify, and assess integration of diversified systems. Here, we develop a methodology with a set of indicators based on network analysis to characterise and quantify the integration of diversified farming systems. Network analysis has been extensively applied in ecological studies but seldom in agro-ecosystems (e.g. Fores and Christian, 1993; Dalsgaard and Oficial, 1997). Using network flow indicators the integration of farming systems can be assessed allowing the comparisons among sub-systems and between systems. The objective of this study is to assess the potentials and limitations for using system network analysis to characterise integration of diversified farming systems. We illustrate the methodology using farming systems from the Ethiopian Highlands.

### Methodology

In network flow analysis, the system comprises of compartments that exchange matter characterized by a number of indices and matrices (Finn 1976). In our methodology the unit of analysis is the farm household, where the compartments are household activities, which use resources and contribute to the livelihood of household members. Diversification is assessed through *income diversity (ID)*, calculated by using the Shannon diversity index (Magurran, 1988) adapted to calculate the contribution of individual activities to net income. The indicators of network flow analysis are: *i) Total system throughflow (TST)*, it is the sum of all flows passing through all systems activities, *ii) Cycled total system throughflow (TSTc)*, is the portion of TST that is cycled, *iii) Total inflow (TIN)* takes into account changes in storage of individual activities and indicates the dependency on external inputs, *iv) Path length (PL)* is the average number of activities that an inflow passes - it highlights the intensity of cycling, and *v) Cycling index (CI)* is the fraction of TST that is recycled, it is calculated by dividing the relative cycling efficiency of all activities by TST. It yields values between 0 and 100, with these extremes indicating either nil or full recycling. For illustrative purposes, we use two farm household systems with 7 and 10 activities and the annual flows of nitrogen (N) within the system and the exterior (Fig. 1). More details of the case-study are described in Rufino et al. (2007).

### Results

The less diversified system B (ID= 1.6) produces less, uses less resources but recycles more N than the more diversified system A (ID=1.8). Both systems depend for their production largely on imported N from the exterior (TIN). Fig. 1 illustrates the diversity in activities of both farm households and the intensity of current N use through internal and external flows. System A is more diverse but less integrated than system B in which PL and CI are higher (Table 1). The amount of N re-cycled (TSTc) is relatively small for both systems when compared to the total system throughflow needed to support production. TST is considered the mobile N pool in the system associated with the system's actual production.

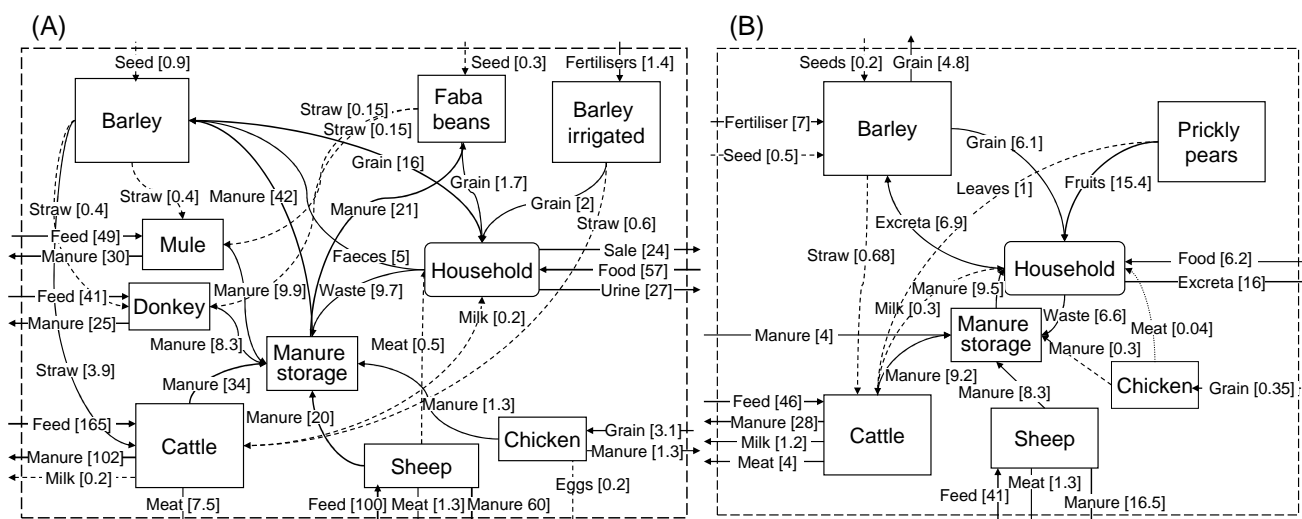

Figure 1: Flow diagram of a farm household with 10 activities (A) and a farm household with 7 activities (B) with different income diversity. N flows are expressed in kg per year and indicated between brackets. The thickness of the arrows represents different N flows: dotted lines are small flows, thick solid are large flows.

Part of the N entering the system may flow through a number of activities and leave, while another part may be recycled repeatedly before leaving the system. PL is dependent on the number of activities because usually more activities mean higher TST and less N inflow means larger PL for a given TST. N management in these two systems could be improved by retaining more manure N from the livestock activities and applying it to the crops, increasing consequently crop yields and reducing the import of food.

Table 1: Integration indicators TIN, TST and TSTc, expressed in kg N per year per farm household, PL (dimensionless) and CI (%) for farm household A and B.

Farm household	TIN	TST	TSTc	PL	CI
A	418.9	596.1	10.6	1.4	1.8
B	121.5	185.9	8.2	1.5	4.3

## Conclusions

The cycling index can be as high as 75% for natural ecosystems (Finn, 1980). In agricultural systems harvested products are exported. Consequently, large amounts of N are withdrawn from the system resulting in much lower cycling indices in farming systems. In addition, integration indicators are sensitive to the number of activities, as usually more activities mean a higher total throughflow of the system. Diversification of farm household activities does not necessarily mean integration of these activities through increased exchange of resources (i.e. N). Increased N cycling reduces total N inflow and therefore dependency on external inputs. Linking integration indicators with farm economic indicators enables the identification of synergies and trade-offs and the design of more resource use efficient and robust systems.

## References

- Dalsgaard, J.P.T. and R.T. Oficial, A quantitative approach for assessing the productive performance and ecological contributions of smallholder farms, 1997. *Agric. Syst.* 55, 503-533.
- Edwards, C.A. et al., The role of agroecology and integrated farming systems in agricultural sustainability, 1993. *Agric. Ecosyst. Environ.* 46, 99-121.
- Finn, J.T., Measures of ecosystem structure and functioning derived from analysis of flows, 1976. *J. Theor. Biol.* 56, 363-380.
- Finn, J.T., Flow analysis of models of the Hubbard Brook ecosystem, 1980. *Ecology* 61, 562-571.
- Fores, E. and R.R. Christian, Network analysis of nitrogen cycling in temperate wetland ricefields, 1993. *Oikos* 67, 299-308.
- Magurran, A.E., Ecological diversity and its measurement, 1988. Cambridge University Press, UK: 145-149.
- Rufino, M.C. et al., Low-cost economic and environmental performance assessment of farm households systems: Application to mixed crop-livestock systems in the Ethiopia highlands, 2007. *J. Sust. Agric. in press*

## TASHUR – AN INTEGRATION OF INDICES TO ASSESS DESERTIFICATION

M. Elhag<sup>1</sup>, S. Walker<sup>2</sup>

<sup>1</sup> Dept of Agricultural Engineering, University of Gezira, Sudan, [munaelhag@yahoo.com](mailto:munaelhag@yahoo.com)

<sup>2</sup> Dept of Soil, Crop and Climate Sciences, University of the Free State, Bloemfontein, South Africa, [walkers.sci@ufs.ac.za](mailto:walkers.sci@ufs.ac.za)

### Introduction

Desertification encompasses a wide range of processes of a physical and biological nature. Knowing the extent and severity of the land degradation is important as decisions for effective control of the land degradation are made by policy makers, resource managers as well as local communities and nomads (Gisladottir & Stocking, 2005). Therefore, land degradation must be monitored on a regular basis so as to implement control measures in good time. At present there is no easy way for these decision makers to access the information available from scientific research and so many of the decision are made with inadequate or incomplete datasets. This should not be the case, as there are many highly sophisticated methods that could be used to analyse the data. The aim here was to make it easier for decision makers at various levels to access the data and integrate it so as to use it to make an informed decision.

The wide range of physical and biological processes involved in land degradation and desertification are seldom integrated into a single index. The challenge is to bring local and scientific knowledge systems together into a single accessible and structured database. This would provide land users and managers as well as scientists with more opportunities to inform and stimulate each other to making improved assessment of the situation and a common basis to work from for sound decision making. If land use planners, managers and land users are to be encouraged to become formally involved in the monitoring and adaptive management process, they also require access to user friendly tools, which provide them with a view on the current status of the situation (Squires, 1998). The decision support framework would provide an opportunity for the inclusion of software to support land planners and managers in assessing and interpreting the condition of their land. The most important part of the Decision Support Tool (DST) paradigm is the focus on the end-user (Stuth & Stafford Smith, 1993) and the aim of developing a simple user friendly tool that can address some of the questions facing them.

### Methodology

The “Tashur” (meaning ‘desertification’ in Arabic) decision support tool was developed as a user friendly tool to assess the severity of desertification in arid and semi-arid regions by integrating biophysical and social parameters (Elhag, 2006). It uses macros in a Microsoft Excel spreadsheet. It is based on the interaction between vegetation and climate factors with human activities, highlighting the role of climate change and climate variability in land degradation. “Tashur” is to be used to raise the awareness of the planners and policy makers working in agriculture, forestry, environment, water affairs and landscaping in the arid and semi-arid regions concerning the impact of desertification. It brings together several indices to assist with this type of operational decision.

The inputs include long-term rainfall time series data (either daily or monthly data) and NDVI (Normalized Difference Vegetation Index) (from FewsNet), Aridity Index (AI) (Hare, 1993), long-term rainfall trends (from either daily or monthly data), Bare Soil Index (BSI), Moving Standard Deviation Index (MSDI) for at least two time intervals and the Human Activities Impact (HAI). NDVI is the most widely used vegetation index calculated from the visible red and infra-red channels monitored by various satellites and is sensitive to the presence of vegetation on the land surface. AI is important, as predictions from global models are that drylands will become hotter and drier due to an increased evaporation. AI is the ratio between precipitation and potential evapotranspiration so can give an idea of changes in aridity of an area over time. BSI is used to map the bare soil areas and differentiate them from those covered with vegetation using various bands of Landsat data. MSDI is a standard deviation calculated for a moving window of nine pixels of data so as to be able to monitor the changes in the landscape that would be noticeable if



degradation was occurring. HAI is calculated as the residual effect from the NDVI and the rainfall using a residual trend method (Wessels, 2005).

The model starts with an assessment of the trends in NDVI then proceeds to analyse the rainfall and AI trends. If these all show stable or increasing trends it means that there is no sign of degradation, then the condition is considered to have remained stable or could even have improved. However, if any two of those indices show a declining trend then it is necessary to do further analysis of soil and human activities. The model then proceeds to check BSI, HAI and MSDI, to give an indication of the severity of desertification. If BSI, heterogeneity of the landscape and HAI have all increased then the area is classified as “*severe desertification*”. If BSI increased but HAI is stable or decreasing there is “*moderate desertification*”. If BSI and HAI were decreasing or stable then there is “*slight desertification*”. All the necessary data needs to be acquired for the selected period and entered on a spreadsheet in the required format. Then the model can be run. If the trends of NDVI and rainfall are declining, then second stage computations will be made before the result is displayed. The final display will state the level of desertification in the selected area and then give the outcome of the three trends (NDVI, rainfall & AI) and the direction of the changes of the other three factors (BSI,MSDI & HAI).

## Results

Validation of “Tashur” was done using three sites – two in grazing areas in the western part of the Butana region and one irrigated site in the Rahad irrigation scheme. The output was “*severe desertification*” for both of the grazing sites as the NDVI, rainfall and AI all gave decreasing trends and so the MSDI, BSI and HAI indices were consulted and all gave increasing trends. This particular combination of factors then results in the output advice “*severe desertification*”. This result agreed with the observations made during the field survey visits from March to August 2005. The desertification in those areas has led to sand encroachment and accelerated development of dunes. The Rahad site gave an output of “*slight desertification*” which is also in line with observations made in that area.

## Conclusions

The output from “Tashur” can then help the planners (agriculturist, foresters and landscape planners) and decision makers in arid and semi-arid regions to assess the landscape conditions and to monitor and map

## References

- M.M. Elhag, Causes and impact of desertification in the Butana area of Sudan, 2006. Ph.D. in Agrometeorology, Univ. Free State, South Africa
- G. Gisladottir & M. Stocking, Land degradation control and its global environmental benefits, 2005. Land Degrad. Develop. 16, 99-116
- F.K. Hare, Climate variations, drought and desertification, 1993. WMO #653, Geneva, Switzerland
- V.R. Squires, Expert systems and other computer-based decision support systems for managing marginal rangelands, 1998. In V.R. Squires & A.E. Sidahmed (ed) Drylands sustainable use of rangelands into the 21<sup>st</sup> century. IFAD Technical Report, Rome, Italy p. 125-137
- J.W. Stuth & M. Stafford Smith, Decision support for grazing lands: An overview, 1993. In J.W. Stuth & B.G. Lyons (ed) Decision support systems for management of grazing lands. UNESCO, Paris, p. 1-36
- K.J. Wessels, Monitoring land degradation in southern Africa by assessing changes in primary productivity, 2005. Ph.D., Univ. Maryland, USA

the extend of the land degradation. This will enable them to make better management and planning decisions for the sustainable use of natural resources in these regions.

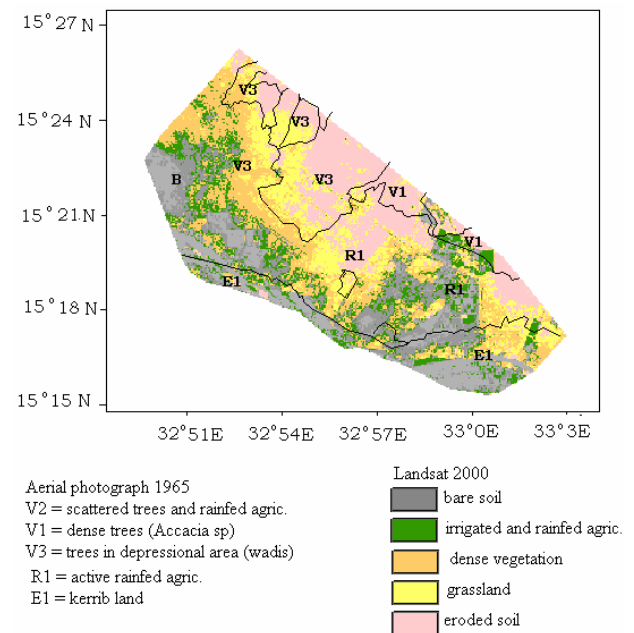

## INTEGRATED ANALYSIS OF VEGETABLE FARMING SYSTEMS. THE CASE OF BRETAGNE, WEST OF FRANCE

N. Akkal-Corfini, S. Lopez-Ridaura, C. Walter, S. Menasseri-Aubry, C. Bissuel-Belaygue

INRA, Agrocampus Rennes, UMR 1069, Sol Agronomie Spatialisation, France [akkal@rennes.inra.fr](mailto:akkal@rennes.inra.fr)

### Introduction

Bretagne is the most important region for vegetable production in France, annually generating over 450 million euros worth of horticultural products (CERAFEL, 2007). To reach such productivity, vegetable farmers have specialised and intensified their crop rotations with consequential environmental effects such as soil compaction, decreased soil organic matter content and increased concentrations of nutrients and pesticides in water and soils.

Under current socioeconomic and environmental pressure, vegetable farmers in the region are required to practice more sustainable farming systems that remain productive and reduce their negative impact on the environment. The objective of this paper is to present a tool for the integrated evaluation of current vegetable production systems to support of the design of alternative farming systems that satisfy a multiplicity of environmental and socioeconomic objectives.

### Methodology

We conducted an exhaustive survey on 48 farms about the crop rotations practiced in the last 10 years. Over 470 vegetable-crop rotations were characterized including 27 different crops and different management techniques (e.g. sowing date, soil preparation, manure and fertilizer doses and pesticide use). Main crops included brassicas (e.g. cauliflower, broccoli, cabbage), artichoke, shallots and endives which are rotated with potatoes, cereals and several other leafy and tuber vegetables.

To evaluate current farming systems we selected over a dozen socioeconomic and environmental indicators and quantified the contribution of each rotation to the value of the indicators.

Quantitative description of the rotations was based on data provided by farmers and technicians, statistics and expert knowledge. All data were averaged over the length of the rotation to express it on a yearly basis. A Multiple Goal Linear Programming (MGLP) model (van Keulen, 1990) was programmed in GAMS™ to (i) explore different scenarios in relation to the satisfaction of multiple objectives by maximizing or minimizing certain indicators with other indicators set as constraints and (ii) to describe the trade-offs among indicators by gradually relaxing or tightening the constraints imposed.

### Results

Figure 1 shows the normalized comparison, for some selected indicators, of three scenarios representing the maximization of gross margin (MAX\_GM), the minimization of pesticide use (MIN\_PEST) and the minimization of partial nitrogen balance (MIN\_NB).

For the MAX\_GM scenario a shallot-autumn leek rotation is selected as both crops have high market prices generating over 31 000 € ha<sup>-1</sup> yr<sup>-1</sup>, however this rotation requires high doses of pesticides, intensive soil preparation (7.5 passes per year) and leaves the soil bare for more than 86 days during winter, increasing the risk of soil and nutrient losses.

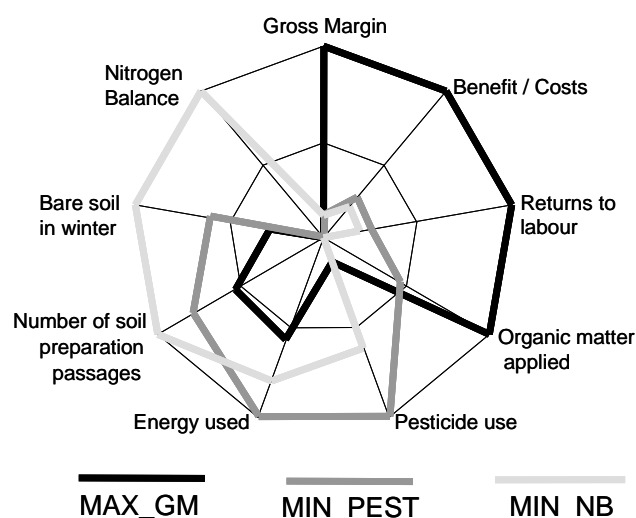

Figure 1. Normalized comparison of three scenarios (see text for details)

For the MIN\_PEST scenario, a rotation based on summer and autumn cauliflower and cabbage is selected, as both crops are on the field during the dry period of the year when the risk of clubroot fungus infection (*Plasmodiophora brassicae*) is lowest; however, the economic profitability of this rotation is low, and it leaves the soil bare during winter for 39 days.

For the MIN\_NB scenario a winter wheat-autumn cauliflower rotation is selected, since, despite having a low economic performance, it requires low nutrient inputs, keeps the soil covered during winter and requires less than 4 soil-preparation passes per year.

With the help of the MGLP model the trade-offs between some of the indicators can be quantitatively described. Figure 2 shows the trade-offs (A) between gross margin and nitrogen balance and (B) between gross margin and pesticide use. Gross margin is strongly constrained by the restriction on nitrogen balance, with a marginal value of 87 € per kg of N allowed in the nitrogen balance. Gross margin is also strongly constrained by the restriction on the use of pesticides; nonetheless, above 11 kg of active ingredient ha<sup>-1</sup> yr<sup>-1</sup> it does not represent a burden to reach maximum profitability.

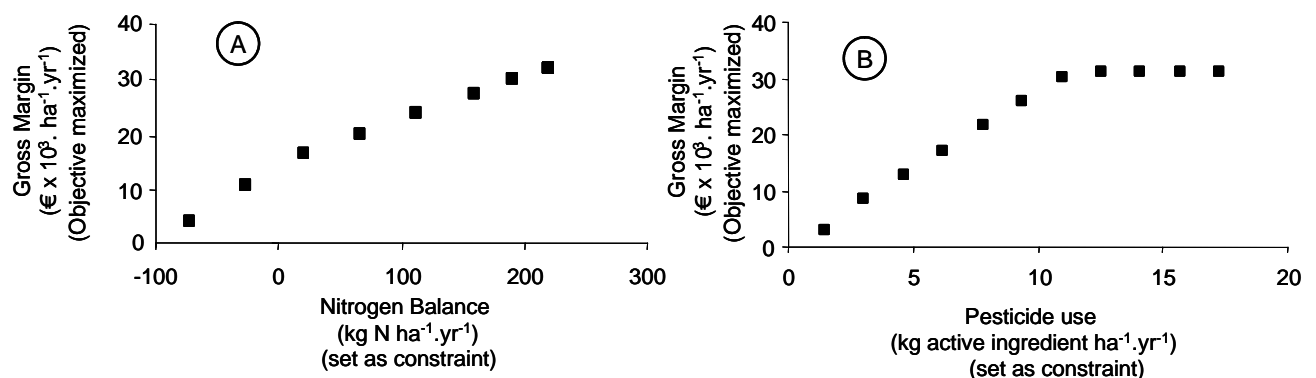

Figure 2. Trade-offs between (A) gross margin and nitrogen balance and between (B) gross margin and pesticide use

Another important conflict in the legume farming system exists between the objectives of reducing nutrient balances and increasing the organic matter content of soils. Figure 3 shows this trade-off by minimising the nitrogen balance with the dose of imported organic matter (manure and compost) set as the constraint. This trade-off curve shows that it is possible to have equilibrated nitrogen balances with an application of up to ca. 40 tons of organic matter ha<sup>-1</sup> yr<sup>-1</sup> but not for greater doses of organic matter.

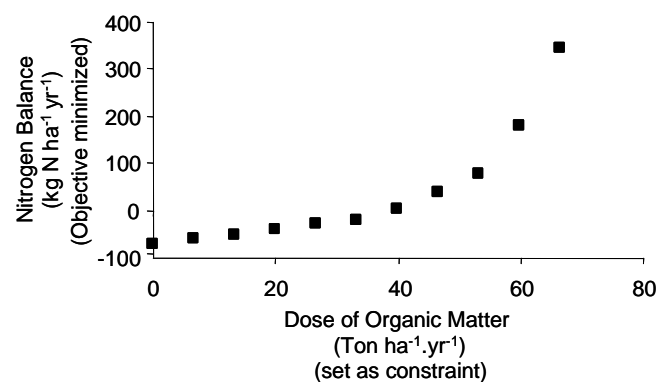

Figure 3. Trade off between nitrogen balance and organic matter applied

## Conclusions

Vegetable farming in Bretagne faces a situation where economic and environmental objectives are often in conflict, and finding a perfect solution that simultaneously satisfies both seems impossible. In the future; however, vegetable farmers will need to adapt in order to cope with the increasing environmental aspirations of society and regulations imposed by governments. The tool presented in this paper may contribute to finding compromise solutions and to design alternative, more sustainable, farming systems by identifying the main strengths and weaknesses of current cropping systems as well as room for improvements.

## References

- CERAFEL (Comité Economique Régional Agricole Fruits Et Légumes), Les légumes bretons en chiffres, 2007. [www.cerafel.com/region\\_leg/default.php](http://www.cerafel.com/region_leg/default.php) (accessed 5 July 2007)
- H.van Keulen, A multiple goal programming basis for analysis of agricultural research and development, 1990. In: Rabbinge, R. et al., *Theoretical Production Ecology: Reflections and Prospects*. Pudoc, Wageningen, The Netherlands, pp. 265-276

## TO DESIGN OR TO REDESIGN : HOW CAN INDICATORS CONTRIBUTE ?

S. Bellon<sup>1</sup>, C. Bockstaller<sup>2</sup>, J. Fauriel<sup>1</sup>, G. Geniaux<sup>1</sup>, C. Lamine<sup>3</sup>

<sup>1</sup> INRA-SAD, UR767 Ecodéveloppement, Avignon, France ([bellon@avignon.inra.fr](mailto:bellon@avignon.inra.fr))

<sup>2</sup> INRA, UMR INPL-(ENSAIA)-INRA Nancy-Colmar, Colmar, France, ([bockstal@colmar.inra.fr](mailto:bockstal@colmar.inra.fr))

<sup>3</sup> INRA, UAR1240, Eco-Innov, Centre de Grignon, BP 01, 78850 Thiverval-Grignon

### Introduction

This positioning paper introduces the concept of redesign and uses integrated fruit production (IFP) and organic food & farming (OF&F), as examples highlighting transition issues in agriculture. Whereas design can be considered as resulting from *in silico* activities (*ex ante* approach), redesign entails both an assessment of existing situations and explicit objectives guiding changes in farming systems (*in itinere* approach). Ecologisation can be considered as a driving force for redesigning agriculture (Deverre & Ste Marie, 2007), since regulations at various levels encourage cross-compliance and invite farmers to develop new practices. A framework is proposed to address how indicators can contribute to meeting agroecology challenges.

### Methodology

Literature reviews on conversion to OF&F (Sylvander et al., 2006; Lamine & Bellon, 2007) and indicators frameworks (Geniaux et al, 2005) were used to address transitions in agriculture and identify system properties guiding both the selection and the interpretation of indicators. The outputs from projects dealing with ecological fruit production and crop protection were used to test and adapt a specific framework. Methods used in such projects encompassed farmers interviews with field monitoring, post-harvest measurements and indicator-based assessments.

### Results

#### ***Specifying a framework to address redesign: the “ESR” model***

In the perspective of a transition towards a more sustainable agriculture, the ESR model identifies three approaches (Hill, 1985): « input **E**fficiency - input **S**ubstitution - system **R**edesign ». The first option (E) consists of making inputs more efficient as regards production costs and accounting for their use (traceability). The second one (S) replaces chemical by biological and environmentally more harmless inputs. Both these options do not entail profound changes within the systems whereas the third option entails a paradigm shift, arising from the transformation of system functions and structure. Redesign (R) refers to the construction of diversified agroecosystems, enhancing ecological principles, where interactions between system components guarantee fertility, productivity and resilience properties. The basic components of such “redesigned” agroecosystems are defined in Altieri (1995).

#### ***Using the ESR model in Integrated Fruit Production (IFP) and Organic Farming (OF&F)***

In IFP, Bellon et al. (2007) showed how technical guidelines (El Titi et al., 1993) are interpreted by various stakeholders (farmers, research and technical staff) and analysed their consequences in terms of innovation. IFP aims at combining several objectives at farm level. However, linking fruit and environmental quality is difficult in the current market situation, which does not reward economically farmers' initiatives and still favours zero-default fruits. Innovations can be fostered by increased interactions between crop production and protection, encompassing higher levels of organization – beyond the tree or the orchard – to integrate ecological infrastructures as functional elements of agroecosystems. This would include (i) maintenance of vegetative cover with reduced tillage, cover crops and mulches and (ii) habitat management favouring natural pest regulation. In OF&F, the ESR model opposes a basic compliance with OF&F standards (EU reg. 2092/91) based on input substitution (**S**), to a system redesign enhancing interactions, sustaining natural regulation processes and linking farmers and consumers (Sylvander et al., 2006).

Two common challenges for redesign can be derived from these two production systems. First, interdisciplinary work involving agricultural and social scientists lead to consider how more direct connections can be made between those who grow the food and consumers. This would be a fourth option in the ESR model, consistent with agroecology as redefined by Gliessman (2007). Secondly, ecological transitions entail a shift from means-based to performance-based approaches, namely in the field of environment and biodiversity.

### **Identifying roles and rules for indicators, as related with redesign**

Indicators are used primarily to evaluate and monitor farming systems. A progress loop would enable the fine tuning or improvement of such systems gradually, but the direction for change is usually missing or taken for granted.

In terms of input efficiency (**E**), Halberg et al. (2005) reviewed 10 input-output accounting systems (IOA) at field and farm level. They identify indicators such as N-efficiency, Treatment Frequency Index ... They suggest that better reference values are needed to interpret indicators at farm level, and that the relation between changed management practices or conditions and changes in indicator values on a given farm over a period of time should be clarified with further research. However, efficiency indicators usually neither integrate costs in fossil energy to improve balances, nor absolute values to measure a reduction in the amount of pesticides used.

As for input substitution (**S**), indicators can be derived from the previous category. However, the efficiency of biological methods is often partial. For crop protection, several authors advocate the use of bioindicators and field observations to monitor pest populations and their natural enemies. Cropping systems performances do not only depend on inputs. They also result from technical management and environmental features (soil cover before winter and properties). Rosnoblet et al. (2006) identified only 9 and 5 among 85 methods which respectively include indicators assessing the regulating effects of crop sequences and ecological infrastructures.

Indicators for redesign (**R**) are generally associated with sustainability issues. Several indicator-based methods take into account various environmental objectives and dimensions of sustainability (e.g. for *ex-ante* evaluation of new options). Guthman (2000) used methods based on indicators so as to classify the farmers according to their degree of adoption of agro-ecological principles. Geniaux et al. (2005) identified various initiatives and proposed a framework guiding the selection of candidate indicators likely to foster key system properties (e.g. productivity, stability), instead of using indicators based on agricultural practices and/or environmental compartments. Such combined properties could act as "orientors" and indicators would be used with relative target values ("Benchmarking" approach) to measure progress at various levels (farm, community, etc.). Systems of indicators would then contribute to select a path and measure a redesign effort.

### **Brief discussion and conclusions**

The systems considered (agrosystem, farm system, agroecosystem or food system) as well as the indicators generated or used differ according to the privileged option (ESR). The identification of system properties and objectives can guide indicator selection. It can also contribute to « backcasting » adaptive farming systems, *i.e.* taking as a starting point a future prototype situation instead of a set of constraints or prevailing conditions. This would support a "doubly-eco-redesign" of farming systems, integrating both ecological and economic dimensions as driving forces.

### **References**

- M. Altieri, *Agroecology: the science of sustainable agriculture*, 1995, Westview Press.
- S. Bellon et al., *La PFI en France: le vert est-il dans le fruit?*, 2007. *Courr. Env Inra* 53, 5-18.
- C. Deverre & C. de Sainte Marie, *L'écologisation de la politique agricole européenne*, 2007. Working Paper
- A. El Titi et al., *Integrated production. Principles and technical guidelines*, 1993. IOBC/WPRS vol 16(1)
- G. Geniaux et al., *Sustainable Development Indicators: Frameworks and Initiatives*, 2005. PD 2.2.1. Seamless EU Integrated Project. 149p
- S. Gliessman, *Agroecology. The Ecology of Sustainable Food Systems*, 2007. 2<sup>nd</sup> Ed. CRC Press.
- J. Guthman, *An agro-ecological assessment of grower practices in California*, 2000. *Agric. and human values*, 17: 257-266
- S. B. Hill, *Redesigning the food system for sustainability*, 1985. *Alternatives*, 12(3-4), 32-36.
- N. Halberg et al., *Farm level environmental indicators; are they useful? An overview of green accounting systems for European farms*, 2005. *Agric., Ecosyst. & Env.* 105(1-2)
- C. Lamine & S. Bellon, *Conversion to organics, a multidimensional subject at the crossroads of agricultural and social sciences*, 2007. Submitted for reviewing.
- J. Rosnoblet, *Analysis of 15 years of agriculture sustainability evaluation methods*, 2006. In M. Fotyma, and B. Kaminska, (Eds.), 9th ESA Congress. Warsaw, Poland, Sept 4-6, 2006, p. 707-708
- B. Sylvander et al., *Facing the organic reality: the diversity of development models and their consequences on research policies*, 2006. *Hub Joint Organic Congress*, Odense (DK)

## COMPARING ENVIRONMENTAL FARM MANAGEMENT TOOLS BASED ON INDICATORS

C. Bockstaller<sup>1</sup>, G. Gaillard<sup>2</sup>, D. Baumgartner<sup>2</sup>, R. Freiermuth Knuchel<sup>2</sup>, R. Brauner<sup>3</sup>, M. Reinsch<sup>3</sup>

<sup>1</sup> INRA, UMR INPL-(ENSAIA)-INRA Nancy-Colmar, F-68021 Colmar, France, [bockstal@colmar.inra.fr](mailto:bockstal@colmar.inra.fr)

<sup>2</sup> Agroscope Reckenholz-Taenikon Research Station ART, Zurich, Switzerland, [gerard.gaillard@art.admin.ch](mailto:gerard.gaillard@art.admin.ch)

<sup>3</sup> Öko-Institut e.v., Freiburg, Germany [Martina.Reinsch@ltz.bwl.de](mailto:Martina.Reinsch@ltz.bwl.de)

### Introduction

During the last decade, numerous environmental farm management tools and evaluation methods based on indicators were developed (Rosnoblet et al., 2006). This raised several questions among potential users e.g. about the strengths and limits of each method, about the convergence of the results provided by them. To answer these questions, four methods were systematically evaluated regarding their use as farm management tool.

### Methodology

The following farm management tools were analysed (see Bockstaller et al., 2006):

- SALCA (CH), an LCA-method based on models and balances.
- INDIGO<sup>®</sup> (F), an indicator-method based on operational models and fuzzy logic.
- REPRO (D), a modular indicator-method based on models and balances.
- KUL/USL (D), a criteria-method based on balances and checklists.

The evaluation was done by the use of a methodology developed within the project. It consists of 15 valuation criteria which are grouped in three domains: “scientific soundness”, “feasibility” and “utility”, each of them being clearly defined and expressed in scores between 1 and 5 (the highest). The scoring of the evaluation criteria on “feasibility” and “utility” took into account the experiences gained during the application of the four methods on a network of 13 farms (arable, mixed or livestock farms) in Switzerland, France and Germany for two production years (2002 and 2003). The evaluation was performed by the authors with reciprocal control. Comments of authors of the methods REPRO and KUL/USL, not directly involved in the assessment were considered.

Correlations between the environmental rankings of the 13 farms obtained with each method were assessed by means of a Spearman correlation coefficient. A conformity index was developed specifically to compare the recommendations to the farmers independently deduced for two methods:

$$I_K = 1 - [ \sum_{p=1 \text{ to } n} \sum_{q=1 \text{ to } b} \sum_{r=1 \text{ to } vk} | i_{pqr} - j_{pqr} | / (2nb) ]$$

with:  $i_{pqr}$ : degree of achievement of variant  $r$  for the production factor  $q$  for farm  $p$  for method 1;

$j_{pqr}$ : degree of achievement of variant  $r$  for the production factor  $q$  for farm  $p$  for method 2;

$n, b, vk$ : respectively number of, farms, production factors and variants per production factor.

### Results

Results yielded by each method for the 15 criteria are shown in Figure 1. For the domain “scientific soundness”, SALCA presents on the whole the best scores, though none of the methods was able to cover all relevant environmental issues (especially regarding biodiversity). The low scores of INDIGO<sup>®</sup> for the criteria “coverage of agricultural production” and “consideration of production factors” result from its specialization on plant production. The “depth of environmental analysis” is low for REPRO due to the selection of indicators considered within this study and for KUL because of the type of used indicators. The latter takes into account only farmers’ practices and not emissions or impacts. The low score of KUL/USL for the criterion “transparency” reflects the non-accessibility of the software, which is balanced by the score in the domain “feasibility” for which KUL/USL receives the best scores as a result of its cleverly devised organisation form. On the contrary, SALCA’s electronic entry data form is not user-friendly. The evaluation with REPRO is comparatively more time-consuming. For the domain “utility”, no great differences were observed on the whole. The better score of KUL/USL is due to the criterion “communicability” thanks to the possibility of labelling which is compensated by the lack of specific recommendations at field level.

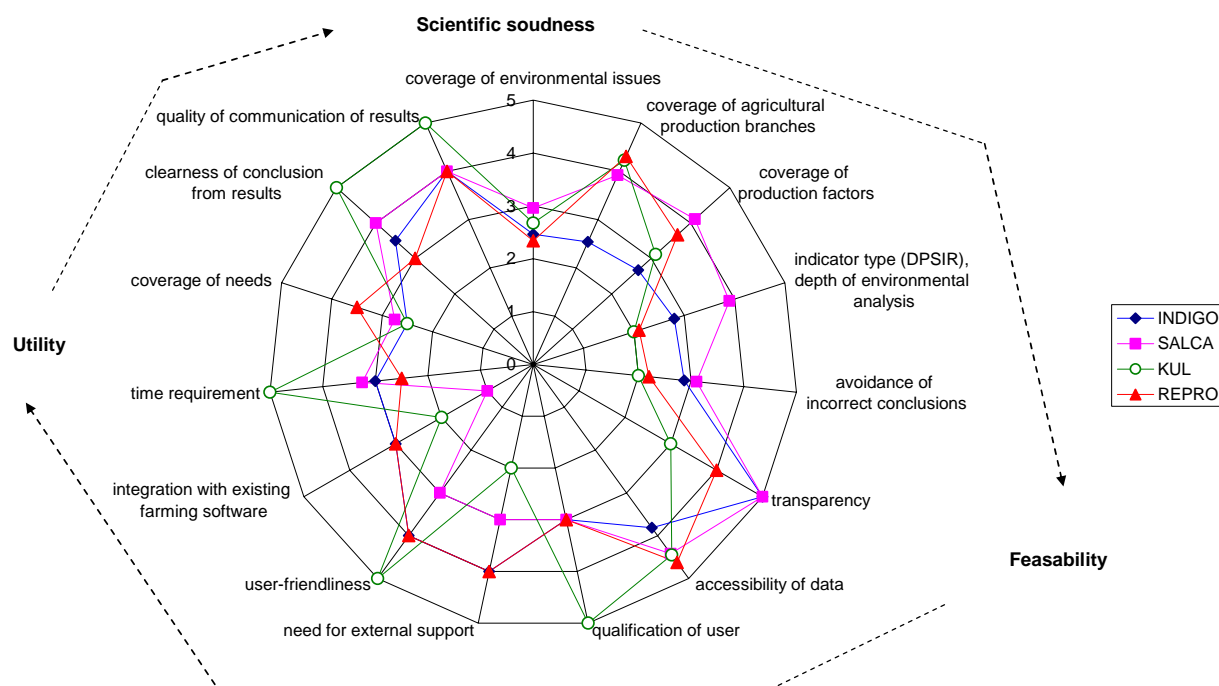

Fig. 1: Comparison of the environmental management tools SALCA, INDIGO<sup>®</sup>, REPRO and KUL/USL according to 15 valuation criteria (1 is the lowest, 5 is the highest possible score).

There was a high correlation between SALCA, REPRO and INDIGO<sup>®</sup> (not enough farms for KUL/USL) regarding the environmental ranking of the analysed farms (Spearman coefficients range between 0.72 and 0.88). In other words for the compared methods, there is no reason to fear that the choice of the environmental management tool determines whether a farm performs well or bad from an environmental point of view. The conformity index shows a low convergence between the recommendations for the four methods (index range between 0.48 and 0.64). These discrepancies are explained by major conceptual differences between the investigated methods, namely: i) in the different environmental issues considered, ii) in the production factors which are used for the calculations of indicators dealing with similar issues and iii) to lesser extent in the benchmark used to derive a recommendation for some similar indicators.

## Conclusions

Beside the methodological development, this work showed that each method has its particular strengths and limitations: according to the methods' status in mid 2004, SALCA yields good results for the scientific soundness but needs improvement (which are planned) towards user-friendliness, INDIGO<sup>®</sup> allows a deep analysis of cropping systems but not of animal husbandry, REPRO covers the agricultural production particularly well but is time-consuming and the results of KUL/USL are formulated in a useful way at the expense of transparency. A similar comparison should be done for the updated versions of the methods with additional criteria (e.g. cost of implementation).

## Acknowledgment

This research within the COMETE project was partly funded by the ITADA (Institut transfrontalier d'application et de développement agronomique) which is sponsored by the EU (Program INTERREG 3).

## References

- C. Bockstaller et al., Méthodes d'évaluation agri-environnementale des exploitations agricoles : Comparaison des méthodes INDIGO, KUL/USL, REPRO et SALCA, 2006. Colmar, ITADA, p. 112. <http://www.itada.org>
- J. Rosnoblet et al., Analysis of 15 years of agriculture sustainability evaluation methods, 2006. In M. Fotyma, and B. Kaminska, (Eds.), 9th ESA Congress. Warsaw, Poland, September 4-6, 2006, p. 707-708.

## DEVELOPING AN INDICATOR FRAMEWORK TO ASSESS SUSTAINABILITY OF FARMING SYSTEMS

C. Bockstaller<sup>1</sup>, S. Bellon<sup>2</sup>, F. Brouwer<sup>3</sup>, G. Geniaux<sup>2</sup>, T. Pinto Correia<sup>4</sup>, L.M. Stapleton<sup>5</sup>, J. Alkan-Olsson<sup>6</sup>

<sup>1</sup> INRA, UMR INPL-(ENSAIA)-INRA Nancy-Colmar, F-68021 Colmar, France, [bockstal@colmar.inra.fr](mailto:bockstal@colmar.inra.fr)

<sup>2</sup> INRA-SAD, UR767 Ecodéveloppement, Avignon, France [bellon@avignon.inra.fr](mailto:bellon@avignon.inra.fr),  
[ghislain.geniaux@avignon.inra.fr](mailto:ghislain.geniaux@avignon.inra.fr)

<sup>3</sup> LEI, LS 's-Gravenhage, The Netherlands, [floor.brouwer@wur.nl](mailto:floor.brouwer@wur.nl)

<sup>4</sup> Department Landscape and Biophysical Planning, University of Evora, Evora, Portugal, [mtpc@uevora.pt](mailto:mtpc@uevora.pt)

<sup>5</sup> Centre for Rural Economy, Newcastle University, Newcastle-upon-Tyne, NE1 7RU, United Kingdom,  
[L.M.Stapleton@ncl.ac.uk](mailto:L.M.Stapleton@ncl.ac.uk)

<sup>6</sup> LUCSUS, University of Lund, Lund, Sweden, [Johanna.alkan\\_olsson@lucsus.lu.se](mailto:Johanna.alkan_olsson@lucsus.lu.se)

### Introduction

Following more than a decade of development of initiatives based on sustainability indicators (Geniaux et al., 2005; Rosnoble et al., 2006), it is now accepted that the selection of indicators has to be motivated and organised within a framework. Among several types of frameworks distinguished by Gudmundsson (2003), conceptual frameworks aim to organize a list of indicators according to a certain logic, e.g. a cause-effect chain as for the Driving forces-Pressures-State-Impact-Response (DPSIR) framework. This and other conceptual frameworks can thus translate, consciously or unconsciously, a vision of sustainable development (Geniaux et al., 2005). The paper presents two proposals for conceptual frameworks which were developed within the SEAMLESS<sup>1</sup> project.

### Methodology

The first framework is a goal-oriented indicator framework (GOF) which considers two domains or system components: the sustainability of agriculture itself and its effect on the rest of the world (Figure 1). The GOF is based on three generic themes across the three dimensions of sustainable development (SD), i.e. the environmental, economic and social ones. Referring to a causal chain of action, these themes are categorized into *ultimate goal*, *processes for achievement* and *means*. The wording "*ultimate*" does not imply that this theme is more important than the other two but it refers to its position in the chain of action. The themes *means* and *processes for achievement* are considered as intermediate goals to achieve the *ultimate goals*. Within each dimension, each theme is specified and structured into sub-themes or specific goals

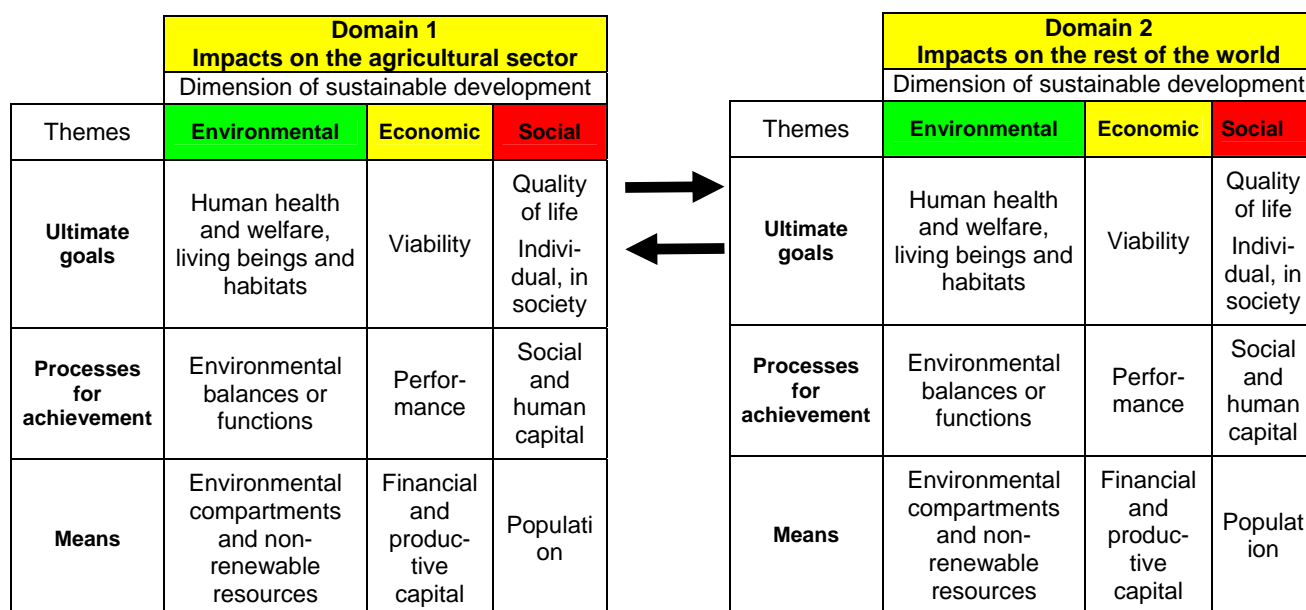

Figure 1. General structure of the goal-oriented indicator framework (GOF)

<sup>1</sup> a project funded under the European Union's Sixth Framework initiative, <http://www.seamless-ip.org/>



Inspired by system theory, the second framework, the system property-oriented indicator framework (SPOF) is based on systemic properties. Like the GOF, the SPOF differentiates between two domains: agricultural system and contribution to global system. Based on the work of Bossel (2000), an assumption is made that every system can be described by a restricted set of generic system properties (e.g. *productivity, existence, effectiveness*) which avoid redundancy within a list of candidate indicators (Figure 2).

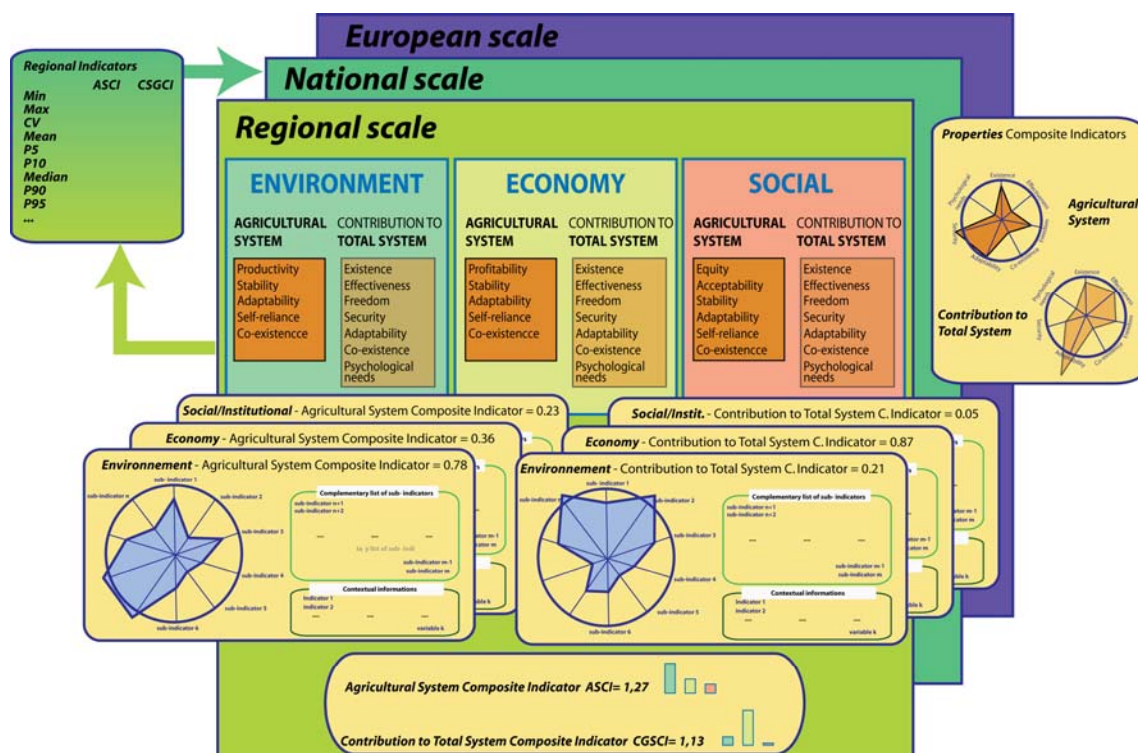

Figure 2. General structure of the system property-oriented indicator framework (SPOF)

## Results

The GOF is about to be implemented in the second prototype of SEAMLESS IF, the integrated assessment tool of the SEAMLESS project. Using the GOF, 85 indicators (54 environmental, 14 economic, 17 social) have been proposed. The SPOF has not been implemented so far. It could be used as a comparative and critical tool during the implementation of the GOF in SEAMLESS.

## Conclusions

The two indicator frameworks presented here can be compared with two different conceptions of sustainability (Hansen, 1996). By using the same logic for the categorization of the three dimensions of SD, the GOF facilitates communication between researchers and policy experts working in different dimensions of SD as both research and administration most often only cover one dimension at a time. But the GOF can easily lead to very long lists of indicators as it implicitly aims at completeness without a clear definition of essential and universal properties of SD, as is the case for the SPOF. The implementation of the SPOF, however, requires more work to make it easily understandable to stakeholders who are not familiar with systemic properties.

## References

- H. Bossel, Policy assessment and simulation of actor orientation for sustainable development 2000. *Ecol. Econ.* 35, 337-355.
- G. Geniaux et al., PD 2.2.1: Sustainable Development Indicator Frameworks and Initiatives, SEAMLESS integrated project, 2005. EU 6th Framework contract no. 010036-2, p. 148.
- H. Gudmundsson, The policy use of environmental indicators - learning from evaluation research, 2003. *J. Transdisciplinary Environ. Studies* 2, 1-11.
- J. W. Hansen, Is agricultural sustainability a useful concept?, 1996. *Agr. Syst.* 50, 117-143.
- J. Rosnoblet et al., Analysis of 15 years of agriculture sustainability evaluation methods, 2006. In M. Fotyma, and B. Kaminska, (Eds.), 9th ESA Congress. Warsaw, Poland, September 4-6, 2006, p. 707-708.

## Indicators of resource use, energy and environmental impact to evaluate sustainability at farming system level

Calabrese G. <sup>(1\*)</sup>, Lazzerini G. <sup>(2)</sup>, Rouphael S. <sup>(1)</sup>, Vazzana C. <sup>(2)</sup> (Arial 10, centered)

(1) Istituto Agronomico Mediterraneo Bari, Italy calabrese@iamb.it.

(2) Department of Agronomy and Land Management, University of Florence, Piazzale delle Cascine, 18-50144-Florence, Italy.

### Introduction

The energy consumption and CO<sub>2</sub> emission in the atmosphere is one of the conditions for sustainability and a high level of energy efficiency would allow fossil resources preservation, air pollution decrease and financial saving. The agricultural sector has often been thought to be an increasingly heavy consumer of energy. The objectives of the study were to choose and test a set of indicators that could be easily applied in different situations and could be able to describe and investigate the overall sustainability of the productive processes. In the case of wheat production the impact of the related practices on the environment in terms of energy consumption and efficiency, CO<sub>2</sub> emission, impact on water resource quality and on soil functions, jointly with the analysis of non-renewable energy sources use and on CO<sub>2</sub> emission were performed and a set of indicators applied and evaluated.

### Methodology

The productive process of wheat crop of four organic farms was compared to four conventional ones in two different regions of Italy (Gravina in Apulia and Val d'Orcia in Tuscany) both vocated for high quality durum wheat production. Different indicators were performed and then a set was chosen. Direct and indirect energy inputs and outputs were determined. The energy balances (outputs-inputs) and input use efficiencies were assessed. The relevance of farm dependence from non renewable energy resources for productive processes was calculated dividing the energy of input coming from non-agricultural sectors, non-renewable, by the total energy input (Tellarini and Caporali, 2000). On the basis of the results of the energy analysis the CO<sub>2</sub> emission per hectare and per kg of wheat was calculated. The impact of farms specific practices on agro-ecosystem was assessed too, calculating the N and P balances, N surplus and, in the case of conventional farms, the Environmental Potential Risk of Pesticide use.

A list of indicator is reported in table 1:

Impact category	Indicator		Unit of measure	Reference
Energy consumption	Total Energy consumption	TEC	Gj/ha	Hülsbergen and Kalk 2001
	Energy Efficiency (output/input)	EE	Mj in/Mj out	Hülsbergen and Kalk 2001
	Dependence from non-renewable energy sources	DNRE	Mj/Mj	Tellarini and Caporali, 2000
CO <sub>2</sub> emission	CO <sub>2</sub> emission per product unit	CO <sub>2</sub> /kg	Kg CO <sub>2</sub> /kg	Haas and Kopke 1994
	CO <sub>2</sub> emission per ha	CO <sub>2</sub> /ha	t CO <sub>2</sub> /ha	Haas and Kopke 1994
Water	Nitrogen Balance	NB		Vereijken , 1995
	Nitrogen Surplus (input-output)	NS	Kg/ha	Haas et al, 2001
	Phosphorus Balance (input-output)	PB	Kg/ha	Vereijken , 1995
	Environmental Potential Risk Indicator for Pesticides	EPRIP		Trevisan et al.,1993 e 1999
Soil	Organic Matter Balance	OMB	Kg/ha	Vereijken , 1995

---



---

Organic Matter content   OM                      %                      Vazzana e Raso 1997

---

## Results

All results were compared with suggested or with threshold values.

Indicator		Organic				Conventional					
		Costantini	Desiante	Pace	Simonelli	Caputo	Trotta	Crespi	Pasquini		
TEC	GJ/ha	4,46	6,42	26,30	6,57	19,82	7,15	16,29	18,64	< 10	
EE	Mjin/Mjout	13,09	8,99	4,58	9,88	5,36	6,88	8,47	5,60	>7	
DNRE	Mj/Mj	0,80	0,79	0,96	0,70	0,93	0,82	0,90	0,80	0,00	
CO <sub>2</sub> /kg	KgCO <sub>2</sub> /Kg	0,03	0,04	0,07	0,03	0,05	0,03	0,03	0,03	> 1	
CO <sub>2</sub> /ha	t CO <sub>2</sub> /ha	0,10	0,09	0,13	0,10	0,08	0,06	0,20	0,10	<0,4	
NB	Kg/ha	0,40	0,35	0,79	0,70	1,86	1,66	1,60	3,90	<1	
NS	Kg/ha	-26,90	-37,34	-9,74	-17,70	33,73	32,93	58,60	237,70	0,00	
PB	Kg/ha	0,02	-7,28	4,4	1,30	-4,70	-6,21	1,00	2,40	<1,1	
EPRIP	Number	0,00	0,00	0,00	0,00	4	36	95,00	160,00	<81	
OMB	Kg/ha	0,70	0,73	0,32	3,20	0,45	0,92	0,40	0,20	> 1	
OM	%	2,40	0,13	0,37	2,10	0,23	0,11	1,88	1,20	> 2	

## Conclusions

Organic farms perform better in term of environmental impact either for TEI and for EE. CO<sub>2</sub> emission values don't appear to differ for both management typologies, but all perform below the threshold values. All farms showed a high the dependence from non-renewable energy. Many other indicators can be used to further analysis or investigations but the applied indicator set was able to describe the environmental impact of the different productive processes, was easily applicable in different environmental situations and resulted to be strongly connected to the farm processes.

## References

- G. Haas G., F., Wetterich, U. Kopke, Comparing intensive, extesified and organic grassland farming in southern Germany by process life cycle assessment, 2001. *Agriculture, Ecosystems and Environmental* 83, 43-53.
- G Haas and Köpke U. Vergleich der Klimarelevanz Ökologischer und Konventioneller Landbewirtschaftung, 1994. Studie (Studie H) im Auftrag der Enquetekommission des Deutschen Bundestages "Schutz der Erdatmosphäre". *Economia Verlag*.
- K.J Hülsbergen,. and W.D. Kalk. Energy balances in different agricultural systems- can they be improved?, 2001. *The international Fertilizer Society Proceedings* 476, 36 pp.
- IPCC (Intergovernmental Panel on Climate Change), *Climate change 1995, the science of climate change*, 1996. University Press, Cambridge, UK.
- D. Pimentel, and A. Wilson. *World Population and Agriculture*, 2005. *World watch magazine*, vol 8, 2: 256-284.
- M. Stolze et al., *The Environmental Impacts of Organic Farming in Europe*, 2000. In *Organic Farming in Europe Economics and Policy*, University of Hohenheim, 6, 1-144.
- V. Tellarini, and F. Caporali, *An input/output methodology to evaluate farms as sustainable agroecosystems: an application of indicators to farms in central Italy*, 2000. *Agriculture Econosystem and Environment* 77, 111-113.
- M. Trevisan, et al, Appendix 2H *Environmental potential risk indicator for pesticides*. In *Comparing Environmental risk indicators for pesticides – Results of the European CAPER Project*, 1999. Centre for Agriculture and Envrinment Utrecht.
- M. Trevisan, et al, *The use of contamination potential indices to assess aquifer vulnerability in the north east area of Piacenza province*, 1993. *Proceed. IX Simposium Pesticide Chemistry - Univ. Catt. S. Cuore*
- C. Vazzana , E. Raso, *Una metodologia europea per la progettazione e realizzazione di un agroecosistema a basso o nullo impatto ambientale*, 1997. *S.I.T.E. Notizie, Bollettino della Società Italiana di Ecologia*, XVII, .51-54.
- P. Verejken, *Designing and testing prototypes: Progress report n.2 of the research network on integrated and ecological arable farming system for UE and associated contries*, 1995. Wageningen (NL), AB-DLO

## EVALUATION OF ORGANIC AND CONVENTIONAL FARMS THROUGH SUSTAINABILITY INDICATORS

F. Caporali<sup>1</sup>, R. Mancinelli<sup>1</sup>, E. Campiglia<sup>1</sup>, V. Di Felice<sup>1</sup>, Y. L. Xie<sup>2</sup>

<sup>1</sup> Dep. of Crop Production – University of Tuscia, Viterbo, Italy, caporali@unitus.it, mancinel@unitus.it, campigli@unitus.it, difelice@unitus.it

<sup>2</sup> Dep. of Ecol. and Ecological Eng., China Agricultural University, Beijing, P.R.China, xieyongli@126.com

### Introduction

Agricultural systems are directly connected to ecological systems and the farm management plays an important role in environmental sustainability. In a perspective of integration among organization levels, the farm hierarchical level is the result of the farmer's decision making process concerning the balance between the utilization of resources and the biophysical and socio-economic constraints. In order to evaluate sustainability at the farm level, an input/output methodology based on the use of the Agroecosystem Performance Indicators (APIs) can be adopted (Tellarini and Caporali, 2000; Caporali et al., 2003). This methodology has been used in order to compare two groups of farms in contrasting management regimes (organic vs. conventional).

### Methodology

The study has been carried out in an area (Tuscia, Viterbo) of Central Italy on a group of 33 farms (18 organic and 15 conventional, whose size was 42 ha and 62 ha of average arable area, respectively). Sub-groups of mixed farms (with livestock) (11 organic and 6 conventional) and arable farms (without livestock) (7 organic and 9 conventional) have been also detected and monitored. For each farm, the input provenance and the output destination have been detected. Among economic inputs, only the variable costs have been considered and the human labor has been not included. Each input and output, defined in terms of quantity units, has been transformed into energy values (through conversion indexes) and into monetary values (through market prices with reference to the year 2006) to obtain both an energy and a monetary analysis. Comparatively to other sectors, agriculture produces renewable resources on the base of biomass accumulation and its use. On this base the inputs have been distinguished in:  $i_1$  = re-use of current year production;  $i_2$  = external produced by agriculture (the  $i_2$  component comes from renewable production, this production can be based on the use of non-renewable inputs, e.g. fertilizer);  $i_3$  = external produced by other sectors (non-renewable);  $i_4$  = total external ( $i_2 + i_3$ );  $i_5$  = total renewable ( $i_1 + i_2$ );  $i_6$  = total ( $i_1 + i_2 + i_3$ ). The outputs have been distinguished in:  $o_1$  = destined to on farm re-use;  $o_2$  = destined to final consumption;  $o_3$  = total ( $o_1 + o_2$ ). The APIs were subdivided in 'structural' ones (able to describe the relevant characteristics of agricultural systems and to compare them) and 'functional' ones (able to describe the efficiency of the different systems).

### Results

The values of the APIs expressed in terms of energy are reported in table 1. The structural APIs show that the conventional farms are largely dependent on non-renewable energy sources ( $i_3/i_6$ ) in comparison with the organic ones (0.64 vs. 0.41 respectively). This dependence increases in the arable farms and decreases in the mixed farms for both compared management regimes. The organic management results to be largely more sustainable than the conventional one, as showed by the overall sustainability indicators ( $i_5/i_6$ ) (0.67 and 0.41, respectively). In the organic farms with the presence of livestock the consumption of fossil energy is reduced at the lowest level and the overall sustainability indicator reaches the maximum value (0.81). The functional APIs values show that the total input efficiency index ( $o_3/i_6$ ) is similar in the two management regimes. The mixed and the arable farms being considered, the highest values are observed in the latter ones. In the arable farms, the energy re-use within the system is very low, in accordance with the lower values of the overall sustainability index. On the contrary, the organic management regime shows efficiency values largely higher than the conventional ones in terms of total re-used inputs ( $o_3/i_1$ ) (3.05 vs. 1.83) and external non-renewable sources ( $o_3/i_3$ ) (7.09 vs. 4.92).

The values of the APIs expressed in terms of money are reported in table 2. The non-renewable

energy costs result basically doubled in the conventional management regime in comparison with the organic one, as showed by the dependence on non-renewable energy sources index ( $i_3/i_6$ ) (0.54 and 0.28 in the conventional and organic farms, respectively). In the organic farms, large amounts of inputs come from agriculture as showed by the overall sustainability index (0.81). The total input efficiency indicator ( $o_3/i_6$ ) shows higher values in the organic regime with the largest gap in the arable farms. This is principally due to both the higher market prices of organic products and the financial supports by the European Common Agricultural Policy (CAP). In addition, the non-renewable input efficiency ( $o_3/i_3$ ) is largely higher in the organic management regime.

Table 1. Agroecosystem Performance Indicators in terms of energy ( $\text{GJ}\cdot\text{GJ}^{-1}$ ) of organic (Org), and conventional (Conv) farms (standard error values are reported in brackets).

APIs	Total farms		Arable farms		Mixed farms	
	Org	Conv	Org	Conv	Org	Conv
<b>Structural</b>						
dependence on non-renewable energy ( $i_3/i_6$ )	0.41(0.08)	0.64(0.09)	0.78(0.08)	0.90(0.03)	0.19(0.04)	0.25(0.07)
farm autonomy ( $i_1/i_6$ )	0.60(0.06)	0.61(0.06)	0.16(0.01)	0.00	0.64(0.05)	0.61(0.06)
overall sustainability ( $i_5/i_6$ )	0.67(0.06)	0.41(0.10)	0.35(0.08)	0.13(0.03)	0.81(0.04)	0.75(0.07)
immediate removal ( $o_2/o_3$ )	0.76(0.06)	0.91(0.04)	0.99(0.01)	1.00	0.62(0.06)	0.77(0.05)
<b>Functional</b>						
gross output / total farm input ( $o_3/i_6$ )	2.52(0.78)	2.54(0.37)	4.47(1.55)	3.52(0.31)	1.17(0.16)	1.07(0.05)
gross output / total farm re-used input ( $o_3/i_1$ )	3.05(0.99)	1.83(0.20)	11.00(0.01)	0.00	2.32(0.74)	1.83(0.20)
gross output / external non-renewable input ( $o_3/i_3$ )	7.09(1.21)	4.92(0.77)	6.72(2.52)	3.93(0.35)	7.01(0.98)	6.41(1.78)
gross output / total external input ( $o_3/i_4$ )	4.04(0.76)	3.43(0.33)	4.47(1.55)	3.52(0.31)	3.66(0.60)	3.30(0.73)

Table 2. Agroecosystem Performance Indicators in economic terms ( $\text{€}\cdot\text{€}^{-1}$ ) of organic (Org), and conventional (Conv) farms (standard error values are reported in brackets).

APIs	Total farms		Arable farms		Mixed farms	
	Org	Conv	Org	Conv	Org	Conv
<b>Structural</b>						
dependence on non-renewable energy ( $i_3/i_6$ )	0.28(0.07)	0.54(0.08)	0.50(0.13)	0.76(0.06)	0.13(0.03)	0.20(0.03)
farm autonomy ( $i_1/i_6$ )	0.55(0.06)	0.54(0.04)	0.15(0.01)	0.00	0.59(0.05)	0.54(0.04)
overall sustainability ( $i_5/i_6$ )	0.81(0.03)	0.53(0.08)	0.69(0.05)	0.31(0.04)	0.87(0.03)	0.80(0.03)
immediate removal ( $o_2/o_3$ ) <sup>a</sup>	0.90(0.02)	0.94(0.03)	0.99(0.01)	1.00	0.84(0.02)	0.85(0.05)
immediate removal ( $o_2/o_3$ ) <sup>b</sup>	0.86(0.03)	0.93(0.03)	0.99(0.01)	1.00	0.78(0.03)	0.81(0.06)
<b>Functional</b> (*)						
gross O / total farm I ( $o_3/i_6$ ) <sup>a</sup>	5.82(1.71)	5.00(1.37)	11.05(3.69)	6.93(2.07)	2.50(0.25)	2.09(0.20)
gross O / total farm re-used I ( $o_3/i_1$ ) <sup>a</sup>	7.10(2.27)	4.06(0.64)	26.83(0.01)	0.00	5.31(1.53)	4.06(0.64)
gross O / external non-renewable I ( $o_3/i_3$ ) <sup>a</sup>	23.98(3.96)	10.00(1.62)	23.48(6.86)	8.44(1.90)	24.31(5.05)	12.33(2.79)
gross O / total external I ( $o_3/i_4$ ) <sup>a</sup>	8.77(1.63)	6.00(1.25)	11.05(3.69)	6.93(2.07)	7.32(1.30)	4.60(0.30)
gross O / total farm I ( $o_3/i_6$ ) <sup>b</sup>	4.28(1.35)	4.22(1.36)	7.87(3.09)	5.81(2.13)	1.99(0.24)	1.83(0.22)
gross O / total farm re-used I ( $o_3/i_1$ ) <sup>b</sup>	4.82(1.34)	3.60(0.67)	11.00(0.01)	0.00	4.25(1.33)	3.60(0.67)
gross O / external non-renewable I ( $o_3/i_3$ ) <sup>b</sup>	18.22(3.41)	8.61(1.66)	16.25(5.79)	7.01(2.01)	19.47(4.38)	11.00(2.76)
gross O / total external input ( $o_3/i_4$ ) <sup>b</sup>	6.65(1.35)	5.08(1.28)	7.87(3.09)	5.81(2.13)	5.88(1.12)	3.99(0.30)

(\*) O = output, I = Input; <sup>a</sup> with European CAP supports; <sup>b</sup> without European CAP supports.

## Conclusions

In general, organically managed farms performed better than conventional ones because their organization was based on: a) increased re-use of on-farm produced energy-matter flow; b) reduced demand of external inputs of non renewable energy-matter sources.

This study has confirmed the fundamental role of livestock as crucial agroecosystem component that improves the efficiency and sustainability of farms in terms of non-renewable energy saving. This role is not yet acknowledged by society in economic terms.

## References

- Caporali F., Mancinelli R., Campiglia E., 2003. Indicators of cropping system diversity in organic and conventional farms in Central Italy. *International Journal of Agricultural Sustainability* 1, 67-72.
- Tellarini V., Caporali F., 2000. An input/output methodology to evaluate farms as sustainable agroecosystems: an application of indicators to farms in Central Italy. *Agr. Ecosys. Environ.* 77, 111-123.

## CROPPING SYSTEMS SUSTAINABILITY EVALUATION WITH AGRO-ECOLOGICAL AND ECONOMIC INDICATORS IN NORTHERN ITALY

N. Castoldi<sup>1</sup>, L. Bechini<sup>1</sup>

<sup>1</sup> Dep. of Crop Science, Univ. of Milano, Italy, [nicola.castoldi@unimi.it](mailto:nicola.castoldi@unimi.it)

### Introduction

The objective of this work is to evaluate the environmental and economic sustainability of crop management in seven farms of the Sud Milano Agricultural Park (Italy; 45°N, 9°E), one of the most intensive and lucrative agricultural areas in Italy, with environmental concerns derived by the intensive use of resources (nutrients, energy, and pesticides). One of the most suitable tools which can be applied in this context are agro-ecological indicators based on farmers' interviews (Castoldi and Bechini, 2006; Castoldi et al., 2007). We present the preliminary results of two years (2005-2006).

### Methodology

We used information derived by interviewing the managers of seven farms of different types (DAI-INT = dairy intensive; DAI-EXT = dairy extensive; SWI-INT = swine intensive; SWI-EXT = swine extensive; RIC-POU = rice and poultry; MIX = mixed; CER-RIC = cereals with rice; Table 1). A set of indicators was been selected and calculated at field level (for a total of 131 fields), by aggregating the observations of a 2-year period. The indicators are divided in five classes: i) economic indicators: gross income (GI), variable costs (VC: sum of the costs for gasoline, lubricants, pesticides, fertilizers, and seeds), economic balance (GI-VC) and economic efficiency (GI/VC); ii) nutrient indicators: NPK soil surface balances; iii) energy indicators: energy input (EI: sum of energy in the gasoline, lubricants, pesticides, fertilizers, seeds, and machinery), energy output (EO: energy content of yield), energy balance (EO-EI), and energy efficiency (EO/EI); iv) soil indicators: crop sequence indicator (it evaluates the average goodness of each previous-successive crop combination), soil cover index (the percentage of soil cover by crops or residues in one year), and soil organic matter indicator (it evaluates if the management on a specific soil tends to accumulate or deplete soil organic matter); v) pesticide indicators: load index (the ratio between the application rate and the toxicity of active ingredient, a.i.), calculated separately for rats, birds, earthworms, bees, fishes, crustaceans, and algae, environmental exposure-based pesticide indicators (calculated using physical-chemical properties of each a.i. characterizing its fate in air, soil, and groundwater).

Optimum and unsustainable ranges for each indicator have been taken from literature, expert knowledge, or from simulation models (meta-models); a sustainability function provides a sustainability index ( $S_i$ ), which equals 1 if the indicator value is in an optimum range and 0 if it is in an unsustainable range. In order to avoid a sharp boundary, values between 0 and 1 are assumed in between these ranges, with a user-defined linear (Fig. 1a), or non-linear (Fig. 1b) function. The  $S_i$  were averaged by indicator class ( $S_c$ ), field ( $S_f$ ) and farm.

**Table 1 – Characteristics of the seven farms monitored**

Farm	DAI-INT	DAI-EXT	SWI-INT	SWI-EXT	RIC-POU	MIX	CER-RIC
Total area (ha)	58	135	35	81	115	48	55
Crop type (%)							
Corn	55	17	74	82	13	43	32
Rice					85		41
Wheat	3			8		10	19
Barley	6	1				19	
Meadows	27	81				9	
Others crops	4					11	3
Trees			26				
Set-Aside (%)	5	1		10	3	9	5
Livestock (Mg l.w. ha <sup>-1</sup> )	1.92	0.73	6.37	1.22	0.16	0.24	0.00

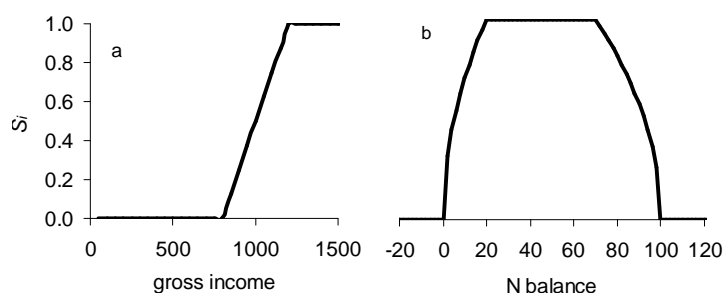

**Figure 1 – Sustainability function for the gross income (€ ha<sup>-1</sup>) and the soil surface N balance (kg N ha<sup>-1</sup>).**

## Results

**Table 2 – Farm-level sustainability indexes: average values ( $S_c$ ) for each indicator class, and statistics of field-level indexes ( $S_f$ )**

		DAI-INT	DAI-EXT	SWI-INT	SWI-EXT	RIC-POU	MIX	CER-RIC
Farm-average $S_c$	Economic	1.00	0.58	1.00	0.97	0.90	0.81	0.90
	Nutrients	0.51	0.77	0.33	0.36	0.51	0.51	0.70
	Energy	0.98	0.73	1.00	0.88	0.84	0.95	0.64
	Soil	0.62	0.89	0.52	0.56	0.32	0.69	0.51
	Pesticides	0.94	0.97	0.98	0.84	0.38	0.92	0.48
$S_f$	Farm-average	0.81	0.79	0.77	0.72	0.59	0.78	0.65
	Minimum	0.66	0.61	0.75	0.62	0.47	0.44	0.34
	Maximum	0.95	0.83	0.80	0.77	0.69	0.92	0.78
	St. dev.	0.10	0.08	0.02	0.03	0.07	0.12	0.11

The aggregated indexes at farm level are shown in Table 2. The  $S_c$  for the economic indicators shows a complete sustainability (1.00) for the intensive livestock farms, and is lower (0.58) for the DAI-EXT. One reason is that, by partially accounting the nutrient content of manure, intensive farms save mineral fertilizers and therefore reduce VC; furthermore their yields are usually high, increasing the GI. On the other hand the hay has a low price, penalizing particularly the DAI-EXT farm.

Sustainability of nutrient management is generally poor, especially for the swine farms. The  $S_c$  for energy is normally high, due to the good energy performance of corn, present in all farms. The lowest value (0.64) is in the CER-RIC, due to the relatively low yields of rice and wheat. Soil management is correct (0.89) in DAI-EXT (use of animal manure and crop residues to maintain soil organic matter; continuous soil cover) and unsatisfactory in the other farms that do not have enough manure for all fields and where in some cases the straw is harvested. The intensive use of pesticides in rice cropping induces a very low  $S_c$  for the rice farms (0.38 and 0.48); the opposite situation occurs in the meadows, where no pesticides are used and in the barley and wheat, where herbicides are occasionally used. Overall, farm-average  $S_f$  is satisfactory for the dairy farms (0.81-0.79). Moderate average  $S_f$  are obtained by swine (0.77-0.72) and MIX (0.78) farms. The minimum  $S_f$  is not very low in the dairy and swine farms (>0.60), while in the others there are fields with low (0.47-0.44) or very low (0.34)  $S_f$ s. None of the fields is completely sustainable ( $S_f=1$ ), and in many cases the maximum  $S_f$ s are lower than 0.90. The variability of  $S_f$  among farm types is relatively limited, as, due to the large number of indicators used, a bad rate for a given indicator may be compensated by the good performance of another.

## Conclusions

According to this framework, dairy farms are among the best farming systems of the area. This is partly due to the role of permanent meadows, which appear to be very sustainable. In fact, meadows have low inputs of nutrients, pesticides and energy, and good soil management, even if they have limited economic value. The mixed and the intensive swine farms are also good. The sustainability of rice cropping systems is much lower, due to intensive use of herbicides and fungicides. Maize cultivation is also critical, due to intensive use of nutrients, particularly in animal farms. A critical step in this approach is the definition of the sustainability functions that provide the  $S_f$  index based on the value of the indicators. Another limitation is that we have given the same weight to each indicator class and to each indicator within each class. This choice, apparently simplistic, is partly justified by less restrictive ranges assigned to less important indicators. The calculation can be improved by differentiating the weights assigned to indicators or to classes, basing the choice on different stakeholders' interests. Finally, this approach takes into account only crop cultivation; further work is needed to evaluate the economic and ecological sustainability of animal production systems. This might change substantially the overall farm sustainability: for example, it is expected that the inclusion of the income due to milk production will improve the economic balance for the dairy farms.

## References

- N. Castoldi, L. Bechini, Agro-ecological indicators of field-farming systems sustainability. I. Energy, landscape and soil management, 2006. Ital. J. of Agrometeorology, 1, 19-31.
- N. Castoldi et al., Agro-ecological indicators of field-farming systems sustainability. II. Nutrients and pesticides, 2007. Ital. J. of Agrometeorology, 1, 6-23.

## RISE (RESPONSE-INDUCING SUSTAINABILITY EVALUATION) – A TOOL TO ASSESS SUSTAINABILITY AT FARM LEVEL

F. Haeni<sup>1</sup>, A. Staempfli<sup>1</sup>, H. Porsche<sup>1</sup>, C. Thalmann<sup>1</sup>, C. Studer<sup>1</sup>

<sup>1</sup>Swiss College of Agriculture (SHL), Zollikofen, Switzerland, [christoph.studer@shl.bfh.ch](mailto:christoph.studer@shl.bfh.ch)

### Introduction

Response-Inducing Sustainability Evaluation RISE (<http://rise.shl.bfh.ch>) is a computer-based tool that allows assessing the sustainability of agricultural production and trends hereof at farm level. Thereby we followed a definition of *sustainable development* that is based on the Brundtland Report (WCED, 1987), but it has been augmented by two more dimensions: 'human dignity' and 'the environment': *Sustainable development* allows a life in dignity for the present without compromising a life in dignity for future generations or to threaten the natural environment and endangering the global ecosystem (Häni et al., 2002). Further, *sustainable agriculture* adopts productive, competitive and efficient production practices, while protecting and improving the environment and the global ecosystem, as well as the socio-economic conditions of local communities, in line with the principles related to human dignity.

The holistic sustainability assessment follows a systems approach and covers ecological, economic and social dimensions. The tool identifies strengths (potentials) and weaknesses with regard to sustainability, hereby providing the farmer with a testimonial on one side and the identification of intervention points for improvement on the other. RISE thus not only aims at diagnosis, but rather at the initiation of measures to improve sustainability of agricultural production.

### Methodology

The sustainability evaluation is based on the assessment of twelve indicators which are determined from more than sixty parameters. The indicator set covers **ecological** (*Energy, Water, Soil, Biodiversity, N&P Emission Potential, Plant Protection, Waste*), **economic** (*Economic Stability, Economic Efficiency, Local Economy*) and **social aspects** (*Working Condition, Social Security, Local Economy*) fundamental to the sustainability of agricultural production. The determination of several (not a single) sustainability indicators allows a differentiated appraisal and to pinpoint possible trade-offs (goal conflicts). Source for the data is an on-farm interview. In contrast to the Driving force-State-Response (DSR) framework and other related frameworks, 'State' (current situation) as well as 'Driving force' (pressures) parameters are aggregated into a degree of sustainability for each indicator. The calculated degree of sustainability therefore not only reflects the current situation on the farm, but also indicates to a certain extent the dynamics inherent in the system (trends and possible risks with regard to the future). State, driving force and degree of sustainability of each indicator are displayed in a comprehensive and easy-to-read sustainability polygon.

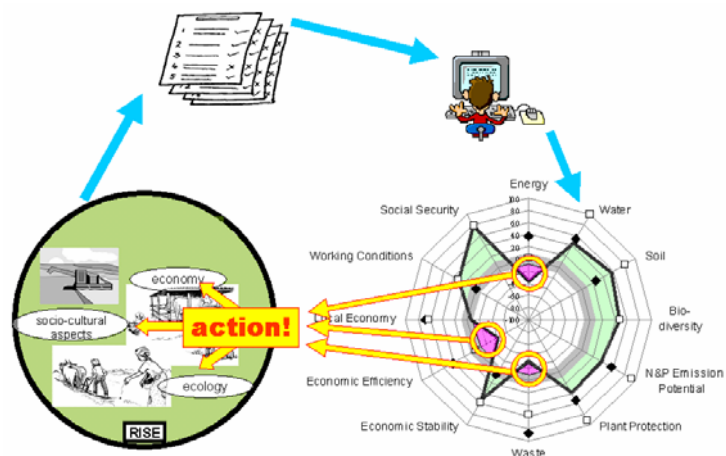

Fig.1: Principle method for a Response-Inducing Sustainability Evaluation RISE

RISE uses a standardized and simple methodology of data entry and output, which allows for sustainability assessments of different farm types and production systems at international level.



Although calculations within the model are quite sophisticated, the interpretation of analysis results is comprehensible for farmers and advisors, and understandable for a wider public. The collected data is stored confidentially in a central database.

Due to its versatility RISE is a useful tool for various actors in the domain of sustainable agricultural production: Principal target user is the farmer (farm manager), who can - possibly together with an experienced advisor - identify specific measures to improve sustainability of production. To assist planning, different scenarios can be calculated with RISE. Repeated RISE evaluations may serve for holistic monitoring and impact assessment. By evaluating groups of farms, RISE allows for benchmarking and comparisons (spatially and temporally), and for the identification of framework conditions particularly conducive or unfavourable for sustainable production. This may be particularly attractive for political entities, producers, trade or label organisations, the processing industry and retailers, as well as for development organizations. RISE may thus contribute to improved agricultural production through concrete measures at farm level, by improving critical framework conditions, and by initiating a change of mindset with relevant actors in the domain.

## Results

RISE was tested and applied in projects on over 250 farms of different background and production systems, producing a range of commodities in various countries and environments (China, Canada, Brazil, Russia, Ukraine, Switzerland, Lebanon, Ivory Coast, Columbia, Kenya, Armenia, and Mongolia).

From the RISE application so far the following experiences have been made and were considered for further development of the tool:

- The model was well applicable on different types of farms;
- Various problems and specific potentials of farms could be highlighted;
- The presentation of results in a sustainability polygon were widely appreciated;
- Some of the indicators reacted too insensitive on farms under comparable conditions and were therefore reworked to allow a more differentiated comparison of similar entities;
- Evaluations on a voluntary basis generally result in an over-representation of progressive farms, and therefore yielding biased samples;
- The data required for an analysis can be collected efficiently and improves with growing experience of the consultant (3-6h per farm);

Individuals with well-founded agricultural knowledge are able to conduct an analysis after a few sessions of introduction by an experienced analyst. To ensure standardized assessments supervision is required, in particular during the introduction period. Documentation and records are being developed and improved on a continuous basis.

## Conclusions

The practical experience so far has shown that RISE fulfils its most important objective: RISE helps to visualize a holistic picture of the sustainability of agricultural production systems while promoting strengths and potentials as well as pinpointing weaknesses, which allows to select specific measures to improve the situation and monitor the results achieved over time.

Further dissemination and development of RISE is planned through cooperation projects (e.g. the establishment of regional RISE hubs), education work and fee-for-service arrangements.

## References

- Häni F., Stämpfli A., Keller T., Barth L., MONA – Nachhaltigkeitsanalyse auf Betriebsebene, 2002. AGRARForschung 9 (5): 194-199.
- Häni F, Braga F, Stämpfli A, Keller T, Fischer M, Porsche H, RISE, a Tool for Holistic Sustainability Assessment at the Farm Level. 2003, IAMA International Food and Agribusiness Management Review 6 (4): 78-90.
- Studer C, Häni F, Porsche H, Stämpfli A, Thalman C, RISE – Response-Inducing Sustainability Evaluation: Model synopsis, 2005. Swiss College of Agriculture, Zollikofen, 12 S.
- WCED (The World Commission on Environment and Development), 1987. Our common future, Bruntland, G (ed.). Oxford University Press, Oxford, New York.

## AN OPERATIONAL METHOD FOR EVALUATING RESOURCE USE AND ENVIRONMENTAL IMPACTS OF FARM SYSTEMS

H.M.G. van der Werf<sup>1</sup>, C. Kanyarushoki<sup>2</sup>, M.S. Corson<sup>1</sup>

<sup>1</sup> UMR SAS, Institut National de la Recherche Agricole, Rennes, France, [hayo.vanderwerf@rennes.inra.fr](mailto:hayo.vanderwerf@rennes.inra.fr)

<sup>2</sup> École Supérieure d'Agriculture d'Angers, France, [c.kanyarushoki@groupe-esa.com](mailto:c.kanyarushoki@groupe-esa.com)

Environmental impacts of farms depend largely on farmer practices, but the causal chain of farmer practices → pollutant emissions → environmental impacts is affected by other factors such as weather and soil characteristics, pollutant fate, and the sensitivity of environmental targets. Interactions among farmer practices themselves also can influence their impacts; for example, incorporating manure into soil soon after spreading it tends to decrease nitrogen losses through ammonia volatilization but increase them through nitrate leaching. The environmental evaluation of farms can rely on indicators of practices (means-based), emissions (emission-based), or emission impacts (effect-based). Although means-based indicators (e.g., amount of fertilizer applied) and emission-based indicators (e.g., N<sub>2</sub>O fluxes) are simpler to implement, they do not include evaluation of environmental impact. In contrast, developing effect-based indicators requires more data collection and understanding of the practice-to-impact causal chain, but does allow estimation of environmental impacts (Payraudeau and van der Werf, 2005). Evaluation methods using effect-based indicators may be difficult to conduct, however, because they may demand time or data that are not available. We developed a method to evaluate the environmental impacts of farms using effect-based indicators that requires a limited amount of time and data. The method follows the life-cycle-assessment (LCA) framework (Guinée et al., 2002). We transformed the method into a spreadsheet tool named EDEN ("Evaluation of Farm Sustainability" in French) that calculates multiple LCA effect-based indicators to assess both resource use and potential environmental impacts. We applied EDEN to dairy farms in western France to evaluate and compare their potential environmental impacts and sustainability.

### Methodology

The tool EDEN is a Microsoft® Excel workbook containing several spreadsheets for entering farm data, holding reference tables, calculating intermediate and final resource flows, estimating nutrient and heavy-metal emissions, and estimating total non-renewable energy use and potential environmental impacts. To calculate potential annual impacts of farm practices, EDEN requires one year of farm data about factors such as crops grown, composition of the dairy herd, feeding or grazing strategies, milk production, manure management, fertilizer and pesticide use (as well as their plastic containers), energy and machinery use, and some basic social and economic values. EDEN has been designed so that all the necessary data would be known or readily available to the farmer and that evaluation of each farm would take less than one day. Once entered, the data are combined with reference tables of average values of fertilizer, feed, milk, and manure nutrient-content; machinery mass and fuel-efficiency; fuel energy-content; cow and manure methane emissions; and seasonal manure and soil emissions of nitrogen (as NH<sub>3</sub>, N<sub>2</sub>O, N<sub>2</sub>, and NO<sub>3</sub>) to estimate intermediate and final nutrient balances and resource and energy flows. EDEN divides emissions and non-renewable energy use into direct (on-farm) and indirect (off-farm) components and tallies both by source or stage of production (e.g., machines, energy sources, fertilizers, feeds, and manure). Emissions are multiplied by characterization factors to estimate their potential impacts in several LCA-derived categories: eutrophication, acidification, climate change, and terrestrial toxicity. Total potential impacts on each farm are divided by its milk production and the area of land occupied (on-farm and off-farm) to estimate potential impacts and non-renewable energy use for each of two functional units: (1) 1000 litres of milk delivered to the farm gate and (2) one ha of land area occupied. LCA indicators of potential environmental impact are complemented by indicators of social and economic performance. With the aid of extension personnel from the Brittany Chamber of Agriculture, we evaluated 46 conventional and 14 organic dairy farms in Brittany with EDEN using one year of farm data for each from the period 2003-2005. Output from EDEN allowed us to estimate and compare non-renewable energy use and potential environmental impacts of these two groups of farms and thereby evaluate their sustainability.

## Results

Farm characteristics: Conventional dairy farms had smaller mean usable agricultural and forage areas, but a higher mean annual milk production than organic farms, due in large part to their greater use of concentrated feed (Table 1). Conventional farms had similar mean stocking rates as organic farms but sold more milk per unit of usable agricultural area per year. All conventional farms but one imported nitrogen fertilizer, while only one organic farm did so (Table 1).

Table 1. Mean characteristics for conventional (n=46) and organic (n=14) dairy farms studied in Brittany.

Characteristic	Units	Conventional farms	Organic farms
Usable agricultural area	ha	58.6	72.4
Farm forage area	ha	44.2	62.9
Milk production per dairy cow	t/yr	7.5	5.6
Concentrated feed use per cow	kg/yr	804	334
Stocking rates	animal units/forage ha	1.4	1.3
Milk sold	t/ha/yr	5.3	3.9
Nitrogen fertilizer importation	kg N/ha	59.6	0.9

Energy use and potential impacts: Per 1000 l of milk produced, conventional dairy farms used a mean of 5% more energy than organic farms and had higher mean potential impacts for acidification (11%) and eutrophication (29%) (Table 2). In contrast, the mean potential climate-change impacts of conventional farms were 9% smaller (Table 2). Per ha of agricultural area occupied, conventional farms had higher potential impacts in all categories (e.g., climate change by 20%, energy use by 36%, acidification by 44%, eutrophication by 87%) (Table 2).

Table 2. Mean estimated non-renewable energy use and potential environmental impacts (1) per 1000 l of milk produced and (2) per ha of land occupied for conventional and organic dairy farms studied in Brittany.

Potential impact	Units	Per 1000 l of milk		Per ha	
		Conv.	Organic	Conv.	Organic
Non-renewable energy use	MJ	3,273	3,114	20,227	14,867
Eutrophication	kg PO <sub>4</sub> -equivalent	6.4	5.0	39.0	20.9
Acidification	kg SO <sub>2</sub> -equivalent	7.9	7.2	48.6	33.8
Climate change	kg CO <sub>2</sub> -equivalent	823	908	5,067	4,236

## Conclusions

Conventional dairy systems, which made more intensive use of energy and imported feeds, were able to produce more milk per farm and per ha than organic dairy systems. Consequently, their potential environmental impacts per 1000 l of milk were not exceptionally greater than those of organic systems. In fact, their potential for climate change appeared lower due to the gaseous emissions of compost imported by organic farms. On a per-ha basis, conventional dairy systems had relatively much greater potential environmental impacts, because their intensive systems resided on smaller areas. The use of different years of data among farms made the comparison between systems susceptible to annual differences in weather. Nonetheless, organic farming systems appeared closer to achieving sustainability and thus, may be environmentally preferable. In this study, however, they produced (on average) 26% less milk per ha of usable agricultural area. These characteristics, with their potential consequences on farm income and consumer prices of milk, may have a negative influence on widespread adoption of organic dairy systems. In conclusion, the tool EDEN appears useful as a method to evaluate the potential environmental impacts of dairy production systems in relatively little time. This approach can be used by extension personnel to evaluate individual farms and by researchers to evaluate a larger number of farms (e.g., in land-use studies).

## References

- JB Guinée, Handbook on Life Cycle Assessment, 2002. CML, Leiden University, the Netherlands.  
 S Payraudeau and HMG van der Werf, Environmental impact assessment for a farming region: a review of methods, 2005. Agriculture, Ecosystems & Environment 107, 1-19.

## Evaluation of the Sustainability of Bovine Meat Production Systems

A.A. Marta-Costa<sup>1</sup>, A. Dinis Poeta<sup>2</sup>

<sup>1</sup> Dep. of Economy, Sociology and Management, UTAD, Vila Real, Portugal, [amarta@utad.pt](mailto:amarta@utad.pt)

<sup>2</sup> Dep. of Economy, Sociology and Management, UTAD, Vila Real, Portugal, [apoeta@utad.pt](mailto:apoeta@utad.pt)

### Introduction

The discussion on the concept of development has become a subject of current interest, from the theoretical and technical points of view, regarding social, economic, environmental and political issues. In order for this discussion to contribute to develop sustainability, significant contributions are necessary, which can promote changes to existing models. An essential step towards this objective is the development of evaluation methodologies that explicitly demonstrate the economic, social and environmental advantages and disadvantages of different handling strategies and systems, by integrating them in a structure for common analysis.

This work, based on meat production systems of the Maronesa local cattle breed, intends to evaluate its sustainability, in order to identify the positive and negative features, regarding the sustainability of the agrarian practices employed.

The systems under study were selected due to set of economic, social, and environmental reasons. Amongst these, a critical one is the contribution of these systems to fight human desertification of mountain areas, by providing added value in economic and socio-environmental terms. These systems need revitalisation, by improving their profitability and promoting the rejuvenation of the farming population, but also by dealing with cattle breeds of high rusticity, natural transformers of intrinsic resources of the mountain zones: a significant regression of herds has been registered (to the current point, where they reached “risk of extinction” status) which can lead to loss of genetic assets.

### Methodology

The sustainability was evaluated by comparison of the production system of Maronesa cattle with other cattle production systems adopted in the area under study. Two main reasons allowed us to proceed this way:

1. The production system of Maronesa cattle has been replaced, in many situations, by systems with more productive breed cattle.
2. The goal of the study was to evaluate the sustainability in economic, social and environmental terms, by performing comparisons between production systems of Maronesa cattle and other cattle production systems in the study area.

The identified production systems, sorted by cattle breed, were: “Maronesa breed” - farms exclusively devoted to Maronesa cattle; “Other cattle breeds” - farms exclusively with cattle of non-Maronesa breed; “Mixed cattle breeds” - farms which combine Maronesa cattle and other breeds. However, farm sustainability can also be influenced by a number of factors, such as its headage and the level of natural resources available. We tried to measure this influence, by comparing the sustainability of these three groups of farms, in terms of headage (5-9 cows and more than 10 cows) and spatial distribution (combined altitude and slope).

The research took place on a significant sample (112) of existing farms within the study area (mountainous), having five or more adult animals, whose main activity is the production of bovine. The evaluation of sustainability was made using the MESMIS<sup>1</sup> methodology, based on FAO's Framework for the Evaluation of Sustainable Land Management (Food and Agriculture Organisation of the United Nations, 1993), whose proposal for assessment of sustainability is based on a strategy of full analysis of production systems, including economic, social, and environmental aspects. MESMIS is an analytical methodology that tries to mitigate the lack of integration of variables and indicators of many sustainability evaluation methods, overcoming the need for non-quantifiable variables and the presence of variables of biophysical, economic and social aspects. It consists of a comparative evaluation of a series of indicators of sustainability.

---

<sup>1</sup> “Marco para la Evaluación de Sistemas de Manejo de Recursos Naturales Mediante Indicadores de Sustentabilidad” (Framework for Evaluation of Natural-Resource Systems Handling through Sustainability Indicators) (Masera *et al.*, 2000).

Sustainability cannot be evaluated *per se*, but only relatively or comparatively, by contrasting two systems of management or two moments in the evolution of one system.

In this sense, and having in account that the degree of sustainability of natural-resources systems will depend on the satisfaction of seven attributes<sup>2</sup>, we performed a detailed analysis of the systems under study, with the purpose of identifying their critical points. This procedure allowed us to elaborate a diagnosis and define criteria that were the basis for the 54 indicators selected.

## Results

Table 1. Relationship of sustainability attributes for the three groups in relative units

ATTRIBUTE	"Mixed cattle breeds" vs. "Maronesa breed"				"Other cattle breeds" vs. "Maronesa breed"			
	Without financial support		With financial support		Without financial support		With financial support	
	Total	≥ 10 Heads	Total	≥ 10 Heads	Total	≥ 10 Heads	Total	≥ 10 Heads
Productivity/Profitability	241	577	125	126	440	964	171	142
Stability, Resiliency and Trust	98	94	93	93	95	72	79	62
Adaptability	116	87	116	87	129	102	129	102
Equity	100	84	89	79	206	144	113	99
Autonomy	81	69	81	69	99	78	99	78
<b>Sustainability</b>	<b>127</b>	<b>183</b>	<b>101</b>	<b>91</b>	<b>194</b>	<b>272</b>	<b>118</b>	<b>97</b>

- An analysis of the main results achieved (table 1) supports the empirical belief that farms with other cattle breeds besides Maronesa present a greater relative sustainability. Observing farms with mixture of cattle breeds, we find them in intermediate positions.
- The “productivity/profitability” dimension was identified as the one with clearer disparity amongst the studied groups. The remaining attributes are not as distinct between the three groups under analysis, and one can emphasize the biggest “autonomy” and “stability/resiliency/trust” of the “Maronesa breed” group.
- When one takes into account the financial support provided to the current activity of the farms, the groups of farms under analysis become more similar.
- A comparison of the three groups of farms by headage classes does not provide any significant change to these results. It only strengthens the “productivity/profitability” of the “Mixed cattle breeds” and “Other cattle breeds” groups in headage classes over ten normal heads. And this effect is diluted when one takes into account the financial support provided to the current activity of the farms.

## Conclusions

- Farms with mixture or other cattle breeds besides Maronesa present a greater relative sustainability, essentially when the financial support provided to the current activity of the farms is not accounted.
- The observation and analysis of the results allow us to point out the biggest “autonomy” and “stability/resiliency/trust” as the strong points for the sustainability of the farms that adopt the local cattle breed Maronesa.
- The weak points for the sustainability of this group are associated, essentially, to lesser economic “productivity/profitability” underlying them. Although they have lesser production costs, their achieved income is far from that attained with cattle farming using more productive cattle breeds. However, the existence of financial support to the current activity of the farms allows this effect to be masked.

## References

- Masera, Ó.; Astier, M. & López-Ridaura, S., (2000). *Sustentabilidad y Manejo de Recursos Naturales. El Marco de Evaluación MESMIS*. GIRA - Mundi-Prensa, México.
- FAO (1993). *FESLM: An International Framework for Evaluating Sustainable Land Management*. World Soil Resources Reports n.º 73, FAO, Roma.

<sup>2</sup> (a) Productivity; (b) Stability; (c) Trust; (d) Resiliency; (e) Adaptability; (f) Equity; (g) Autonomy (Masera *et al.*, 2000).

## GENETIC INFORMATION ON CROP VARIETIES PROVIDE HIGH QUALITY INDICATORS TO ADDRESS AGRI-ENVIRONMENTAL ISSUES

C. De Pace<sup>1</sup>, M. Pasquini<sup>2</sup>, A. Matere<sup>2</sup>

<sup>1</sup> Dep. of Agrobiology and Agrochemistry, Univ. Tuscia, Viterbo, Italy, [depance@unitus.it](mailto:depance@unitus.it)

<sup>2</sup> CRA-Experimental Institute for Cereal Research, Rome, Italy, [pasquinimarina@mclink.it](mailto:pasquinimarina@mclink.it)

In farming systems aimed to sustainable crop production, the pressure of certain activities (i.e. agrochemical distribution, crop variety choice) on the environmental media (soil, water or air) and systems (biodiversity and landscape) is gauged by indicators such as the net surpluses of soil nutrients and pesticide residue into the soil and crop products. Several factors account for levels of those difficult-to-measure indicators, but the genetic pool of crop species and varieties used for production has the major share. Mixtures of crop species and crop varieties that withstand pathogen epidemics favour pesticide input reduction and increase crop yield per unit of inputs compared to the monoculture of the single components (Zhu et al., 2000). Therefore, temporal and spatial genetic diversification in crop fields achieved through crop rotation, intercropping, variety mixture and stacking resistance genes in one variety, is a strategy that slows down the rate of pathogen and pest evolution, enforces host resistance, reduces pesticide use and increases the output performance of the system compared to the mean of its components or genes (Collins and Qualset, 1999). This suggests that the 'number of components' in intercrop, rotation, or mixture is a reliable indicator of lower pressure over the environment. Crop varieties with durable genetic resistance to major pests and diseases reduce also the use of fungicides and input resources. Therefore, in a DPSIR (Driving forces-Pressure-State-Impact-Response) (EEA, 1999) conceptual framework, the "number of genes" controlling the productivity resilience of stress resistant crop varieties or an index of the reduction of disease severity symptoms due to genetic field resistance, will be consistent and reliable driving force indicators linked to a reduced pressure of agriculture on environmental resources.

Here we provide evidence that driving force sustainability indicators can be standardized from genetic information on: (a) *Triticum aestivum* (bread wheat) response to powdery mildew disease caused by *Blumeria* (syn. *Erysiphe*) *graminis* f. sp. *tritici*, and (b) *T. turgidum* var. *durum* (durum wheat) field response to brown rust disease caused by *Puccinia triticina*.

### Methodology

The bread wheat breeding line CSxV-63 carrying the *Pm21* gene (from *Dasypyrum villosum*) controlling resistance to *B. graminis*, has been tested for severity of powdery mildew symptoms in 10 locations in comparison to other 84 breeding lines and varieties. Plot size was 2 x 1 m row. Disease assessment was rated at adult stage using a "disease severity symptom" (DSS) scale based on the "Cobb score" (0 to 100% as modified by Peterson et al., 1948) that accounts for intensity of infection on the leaves and height of disease symptoms on the plant. Line CSxV-63 was also tested at 10-day-old seedling stage in three independent controlled infection experiments in the greenhouse using different powdery mildew isolates. Symptoms were scored using a 0 (absence of fungal growth) to 4 (maximal fungal growth) scale.

The responses of twenty-five durum wheat varieties to brown rust natural infection in the field have been evaluated for 11 years (1991 to 2002) and for about 5 locations each year. In every location the trials were planted in an incomplete block design. For each year-location-variety combination, individual plot size was 2 rows by 1 m long by 0.30 m apart. DSS was estimated as before with reference to rust infection severity.

Plot-level data for the durum wheat multienvironment trial were subjected to a linear mixed model analysis using ReML in GENSTAT v. 9.1 (2006). The data across environments were analyzed based on the following linear mixed effects model:  $y_{ijk} = \mu + G_i + Y_j + (G \times Y)_{ij} + Y(L)_{jk} + \varepsilon_{ijk}$ , where  $y_{ijk}$  is the plot DSS score,  $\mu$  is the general mean,  $G_i$  is the effect of variety  $i$ ,  $Y_j$  is the effect of year  $j$ ,  $(G \times Y)_{ij}$  is the effect of variety  $i$  in year  $j$ ,  $Y(L)_{jk}$  is the nested effect of locality  $k$  within year  $j$ , and  $\varepsilon_{ijk}$  represents the residual for the  $ijk$  plot. Varieties were considered sources of fixed genetic effect for disease response and year and location were considered sources of random effects.

The driving force indicator variable for each variety was equated to  $|DSI_i|$ , where  $DSI_i$  is the Disease Severity Index standardized for each variety from the magnitude of  $G_i$ 's as follow:  $DSI_i = [(G_i - G_{Max}) / (G_{Max} - G_{Min})]$ ,  $G_{Max}$  is the highest positive value for  $G_i$  in the set of tested entries and should correspond to the susceptible check variety;  $G_{Min}$  is the negative  $G_i$  value from the less susceptible entry. "Appulo" was the susceptible check variety in the multienvironment experiment to evaluate field response to brown rust. DSI ranged from 0 (for varieties as susceptible as the check variety) to -100 (for the least susceptible variety).  $G_i$ 's for resistance were those from varieties expressing  $DSS \leq 25\%$ ; significance of DSI was assessed by comparing  $[G_i - G_{Max}] / SE_D$  with tabular "t";  $SE_D$  is an output of the ReML directive.

Fig. 1- Disease severity index (DSI) after exposure of 25 durum wheat varieties for 11 years (1991 to 2002) and 5 localities per year to natural inoculum of brown rust spores. "Appulo" was the susceptible "check" variety.  $DSI_i = [G_i - G_{APPULO}] / (G_{APPULO} - G_{BELFUGGITO})$ .  $G_i$  is the generalized least square estimator of the fixed genetic term in the mixed model ReML analysis.  $G_{APPULO} = 12.73$  and  $G_{BELFUGGITO} = -32.38$ . SE for pairwise difference of  $G_i$  is 3.15

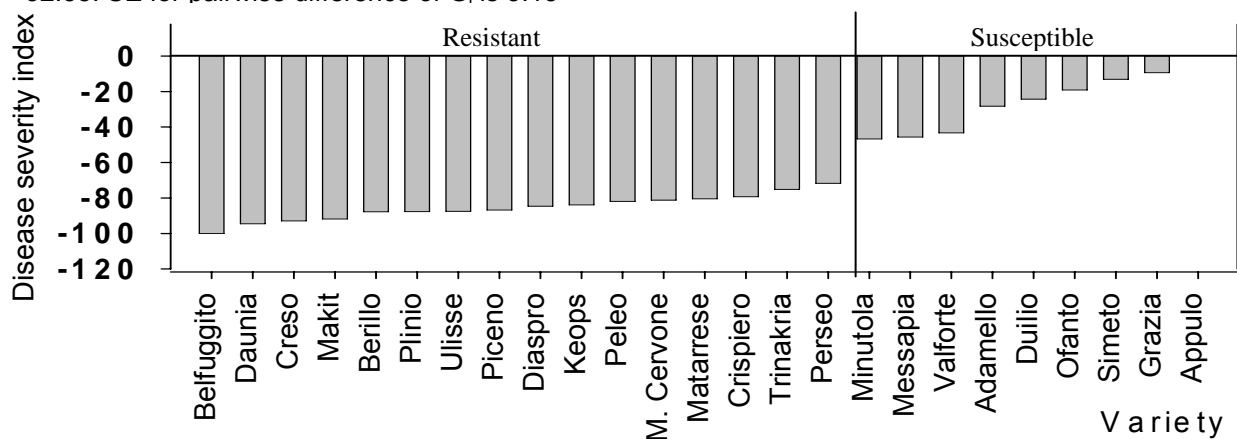

## Results and Conclusions

The CSxV63 bread wheat breeding line showed immunity to powdery mildew in both field and greenhouse experiments. The presence of the *R* allele at the *Pm21* locus accounts for the immunity response. The driving force indicator for this line was 100, denoting the farmer that will grow a variety carrying the *Pm21R* allele as a contributor to agriculture sustainability compared to farmers sowing varieties with a lower value for the indicator variable. This is because the *Pm21R* allele will provide the most economical and environmentally safe mean to control powdery mildew, averting yield loss due to the genetic protection against the disease. Sixteen durum wheat varieties were resistant to brown rust ( $DSS \leq 25\%$ ). The average  $G_i$  effect stemming from the complex of genes conferring field resistance allowed the indicator variable for those varieties to range between 70 and 100 (Fig. 1). Adoption of those varieties for durum wheat production has been instrumental for increasing the grain yield per hectare. Genetic field resistance to brown rust in varieties such as "Creso" prevented yield loss due to the disease and still provides economical and environmental benefits to farmers for its higher grain outputs for each unit of inputs. The implementation of a sustainable agricultural system based on the use of  $|DSI|$ , requires a feasible two step process: 1) data collection on disease resistance and agronomic performance of varieties included in comparative trials supported by National Agricultural Research programs; 2) grant support to farmers adopting a regional program designed to monitor spatial and temporal rotation of genetically different varieties with high  $|DSI|$  and agronomic performance. The rationale for the second step is linked to the principle that spatial and temporal crop field heterogeneity for genetic resistance will increase resistance durability with respect to the pathogen evolutionary flexibility.

## References

- W.W. Collins and C.O. Qualset (Eds), Biodiversity in agroecosystems, 1999. CRC Press LLC.  
 EEA, Environment in the European Union at the turn of the century, 1999. Copenhagen.  
 R.F. Peterson et al., A diagrammatic scale for estimating rust intensity on leaves and stems of cereals, 1948. Canadian Journal of Research Section 26, 496-500.  
 Y. Zhu et al., Genetic diversity and disease control in rice, 2000. Nature 406, 718-722.

## MODELLING WORK ORGANIZATION TO ACCOMPANY CHANGES IN LIVESTOCK FARMS

S. Madelrieux<sup>1</sup>, B. Dedieu<sup>2</sup>, L. Dobremez<sup>3</sup>

<sup>1</sup> CEMAGREF DTM, Grenoble, France, [sophie.madelrieux@cemagref.fr](mailto:sophie.madelrieux@cemagref.fr)

<sup>2</sup> INRA - UMR 1273 Métafort, Clermont Ferrand, France, [dedieu@clermont.inra.fr](mailto:dedieu@clermont.inra.fr)

<sup>3</sup> CEMAGREF DTM, Grenoble, France, [laurent.dobremez@cemagref.fr](mailto:laurent.dobremez@cemagref.fr)

### Introduction

Working questions are critical issues for the sustainability of livestock farming systems (LFS) and for their adaptive capacities. Society and market chain pressure into new manners of doing that modify the tasks distribution and the priorities between tasks, for example, to delay hay making for floristic biodiversity preservation, or to fill up in time subsidies formulars or traceability papers. At the same time, increasing labour productivity is a general trend as well as the deep changes in the labour force composition (less family workers, more associations between farmers or wage-earning workers). Diversification and off farm activities also constraint the time available for livestock activities. More than ever, characterizing and evaluating a LFS (its rooms for manoeuvre), designing innovative ones that have to be integrated into "real" farms, require 1) to consider farmers as technico-economical decisions makers but also as work organizers and workers themselves, 2) models that make intelligible the interactions between livestock and land management practices, workforce and the combination of activities of farmers. In this short paper, we present the main traits of a model *Atelage* (Madelrieux et al. 2006) that aims at characterizing and qualifying work organization in livestock farms.

### Methodology

The model is designed i) in an interdisciplinary framework combining livestock management and ergonomics points of view on work organization, ii) from 15 herbivores farms surveyed in the Northern Alps and debated by experts. In reference to Knowledge Engineering, we formalize i) a model of the domain or ontology, which defines the concepts used ii) a model of reasoning from the data of a case (who does what, when, where) to the description and the qualification of work organization at the yearly level, with qualitative and quantitative criteria.

### Atelage conceptuel framework

The livestock management point of view on work organization is based on four major assertions (Madelrieux & Dedieu 2006). 1) Work is a set of i) tasks to do and ii) of persons to carry them out. Work organization refers to the contents and the ajustement of the both terms. 2) All tasks are not equivalent. They can be distinguished according to their rhythms and their character of being deferred. Some tasks have a *daily rhythm* (milking), others are *non daily* (weekly or seasonal). Non daily tasks may be delayed (the shearing date...) or not (the market days where the farm products are sold). 3) All the workers are not equivalent according to their function in the work group, their rhythm of involvement and the way there are remunerated. We distinguish the *basic group* of workers whose agricultural activity is preponderant and who organize the work on the farm (the farmer, the farming couple, the associates of a farming association...) and the other workers: volunteers (such as retired people), mutual help, subcontractors and salaried workers. 4) The work organization at the year scale results from the chaining of periods whose organizational characteristics are different (either due to the evolution of the tasks to do, the manpower or to the combination of activities).

Ergonomists consider work organization as a dynamic system of working activities with regulations (Curie & Hajjar 1987). An activity associates workers and daily / non daily tasks (for instance the milking tasks and the couple of farmers who are milking together). Activities are linked with temporal relations or priority orders (*priority, succession, interruption, conditional connection*), or are carried out in parallel. Regulations refer to the alternation (either during one period, or from one period to another) of "daily forms of organization" (FDO). FDO represent "typical work days", gathering particular daily combinations of activities that present the same daily activities -DA- and the same type of relation between daily and non daily activities -NDA-. If the daily activities change



or if the relations between daily and non daily activities change (reversal in the orders of priority), the FDO changes. But if it is just the content of the non daily activities that changes from one day to another (due to the climatic conditions for instance), the FDO is the same (figure 1).

Figure 1: Different working days for a same FDO



**Qualifying work organization in livestock farms**

Qualification is based on two time scales: the period (or *organizational sequence*) and the year. Qualification criteria at the period scale are summarized in table 1. The year is analyzed as the chaining of the organizational sequences from winter to autumn (figure 2).

Table 1: Criteria of qualification and their modalities (at the organizational sequence)

Criteria		Modalities of the criteria qualifying the work organization
Regulations (modalities of alternation)		1) Sequence <i>stable</i> (1 FDO) or with a <i>weekly</i> or a <i>day by day alternation</i> (more than 1 FDO); 2) Alternation which <i>origin</i> is technical or non technical
Relations between agricultural and non agricultural activities		<i>juxtaposition</i> (activities in parallel) or <i>imbrication</i> (activities in relation)
Labour division	Relocation of agricultural activities	<i>total / partial relocation</i> of the daily / non daily activities
	Degree of implication of the basic group in DA and NDA	- <i>autonomy</i> ; <i>partial sharing</i> ; <i>total sharing</i> ; <i>partial delegation</i> ; <i>total delegation</i> for daily/non daily activities
	Labour division inside the basic group	The members of the basic group work <i>together or separately</i>

Figure 2: One profile of organizational sequences in a livestock farm of Northern Alps

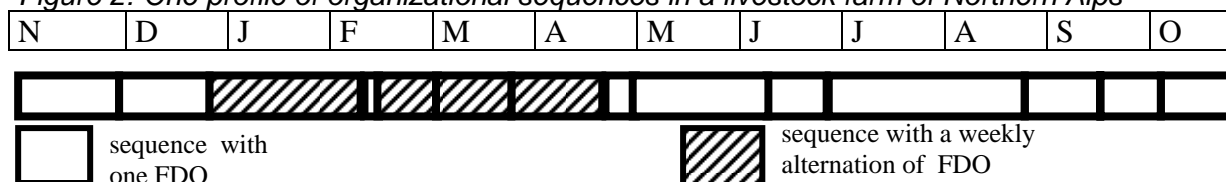

Considering the regulation criteria: this profile presents weekly alternations located in winter due to a non-agricultural activity that is a salaried activity with two days free per week (a job in a ski resort). The rest of the year there is no alternations of FDO inside sequences. The number of sequences is important in relation with the livestock process.

**Conclusion**

*Atelage* model authorize to produce knowledge on the diversity of work organization and its determinants. Are the sequences chaining, the alternations, the FDOs due to livestock management priorities, interaction with other activities, workforce availability, working peak? These determinants are those who may change in relation with the transformations evoked in introduction. The model is now integrated into extension tools. It is notably the basis of a farm settlement tool specifically devoted to clear up the strengheness of futur farmers LFS projects when debating on work.

**References**

Curie J., Hajjar V., Vie de travail, vie hors travail : la vie en temps partagé, 1987. In Lévy - Leboyer C., Sperandio J.C., *Traité de psychologie du travail*, 37-55.  
 Madelrieux S., Dedieu B, Qualification and assessment of work organization in livestock farms: the French experience, 2006. 57<sup>th</sup> EAAP Meeting, Antalya (Turkey), 17-20 sept, session L.31. Scale dependant opportunitites and efficiency in livestock farming development, 23 p.  
 Madelrieux S., Dedieu B., Dobremez L., ATELAGE : un modèle pour qualifier l'organisation du travail dans les exploitations d'élevage, 2006. INRA Prod. Anim. , 19(1), 47-58.

## ENERGY INDICATORS OF AGRICULTURAL SUSTAINABILITY – A SURVEY OF DAIRY FARMING AT TERCEIRA ISLAND (AZORES)

E. Batista<sup>1</sup>, J. Batista<sup>2</sup>

Dep. of Agricultural Sciences, CITA, University of the Azores, Portugal

[ebatista@mail.angra.uac.pt](mailto:ebatista@mail.angra.uac.pt); [jbatista@mail.angra.uac.pt](mailto:jbatista@mail.angra.uac.pt)

### Introduction

Among the difficulties facing the Azorean agriculture productivity are the small or very small sizes of 84% of holdings, excessively high production costs, transport and supply problems, inadequate processing and marketing infrastructure as well as a heavy dependency from external direct or indirect energy inputs. Rocky terrain and high rainfall may sometimes result in environmental damage and require permanent plant cover to be maintained in areas at risk, while in some islands agriculture is provoking the eutrophication of lake water. Among the region's strengths are its mild Atlantic climate and volcanic soils, which make agriculture very productive up to 300 m altitude, while the land is well suited for grazing above that altitude. The aim of this study was to determine baseline data on total energy inputs as sustainable indicators of dairy farm production at Terceira Island.

### Material and methods

Data on farm production, direct farm energy use, indirect inputs such as fertilizers, agrochemicals, purchased feedstuff and seeds, and capital inputs associated with buildings and machinery, were collected from 10 farms in collaboration with Terceira Island Farmers Association, for the period of 1998-2002. This was assumed as a first step for further analysis, surveying more farms. In our study, we used process analysis (Fluck, 1992), evaluating both direct energy inputs and all indirect energy inputs. Human labour and solar energy were not considered. Indirect energy was only used one-step backwards from the farm. For each farm, milk production in kilograms of milk solids was calculated annually. Milk was considered the main output from dairy farms. The average calorific value for milk was considered  $3.11 \text{ MJ kg}^{-1}$ , with a milk solids content of  $125 \text{ g kg}^{-1}$  of milk.

### Results

#### Energy indicators

For the surveyed farms, the average milk production in terms of litres cow<sup>-1</sup> represents  $5405.3 \pm 1011.9$  (from a minimum of 2663.5 to maximum 7463.4) and for litres ha<sup>-1</sup>,  $9981.8 \pm 3391.8$  (minimum 1535, maximum 19752.9). On average, the surveyed farms can be classified as intensive farming systems. The average energy indicators for the surveyed farms are shown in Table I.

#### Input costs

For the total number of farms, feedstuffs represent 45% of the total costs, fertilisers 18%, machinery and other capital 17%, fuel 12%, agrochemicals 3% and others 5%. For the cost of each litre of milk, only including the studied direct, indirect and capital inputs, we found an average of  $0.08 \pm 0.02 \text{ €}$ , for a minimum of 0.05 € and a maximum of 0.12 €.

#### Discussion

From this study, the most significant energy requirements for the average farm are associated with the manufacture and conservation of feedstuffs (64.5 %), supply and use of liquid fuels (13.1 %) and supply of artificial fertilizers (9.0 %). Production of all capital inputs accounts for a further 1.7 % of total primary energy requirements, with the balance being used for the production of other indirect inputs, such as agrochemicals, seeds and electricity as a direct input.

Despite good natural conditions, renewable energy sources are not used in the surveyed farms. This means that the dairy farmers are highly vulnerable to fossil energy supply reliability and price fluctuations, since fossil fuels make up the majority of energy requirement for the manufacture of indirect and capital inputs. From international data, we could conclude that the surveyed farms represent an intensive farming system, comparable to other intensive dairy farm systems in Europe or elsewhere. In terms of economic results, the situation is quite favourable for the analysed farms. However, traditional crop rotation has been abandoned in favour of gramineous species prevalence, demanding high rates of N supply. More milk per unit of area or per cow means more input of imported feed, relegating the large potential of local natural resources. The most important

TABLE I - Average Energy Indicators for Surveyed Farms

<i>Total Energy Indicator</i>	<i>Mean value ± 95 % Confidence Interval</i>	<i>Range</i>
Total Energy Intensity (GJ ha <sup>-1</sup> )	31.3 ± 7.3	12.7 – 46.1
Total Energy Input per Unit Production (MJ kg <sup>-1</sup> MS)	30.7 ± 5.1	22.1 – 39.4
Direct Energy (%)	16.3 ± 4.2	7.4 – 25.7
Indirect Energy (%)	79.4 ± 7.5	50.8 – 87.6
Capital Energy (%)	8.8 ± 4.6	2.2 – 25.5
Overall Energy Ratio (MJ in/MJ out)	3.8 ± 0.6	2.8 – 4.9
Protein Energy Ratio (MJ in/MJ protein)	0.6 ± 0.1	0.5 – 0.8
Gross CO <sub>2</sub> Emission Ratio (kg CO <sub>2</sub> kg <sup>-1</sup> MS)	2.4 ± 1.8	0.2 – 9.1
Gross Emission Intensity (tons CO <sub>2</sub> ha <sup>-1</sup> )	14.7 ± 11	4.1 – 56.7
Average animal productivity (kg MS ha <sup>-1</sup> )	1119.7 ± 340.7	197.6 – 1733
Stocking density (cows ha <sup>-1</sup> )	1.8 ± 0.4	0.6 – 2.7
Land Productivity (kg MS cows <sup>-1</sup> )	690 ± 131	342.9 – 960.9
Renewable Energy (%)		0

question has to do with efficiency. In terms of energy utilization, it seems that on average, the set of chosen farms it is not efficient, not sustainable in a future perspective, limiting the sector's competitive capacity. More work has to be done in order to get more representative data.

### References

- Fluck, R.C., 1992. Energy in Farm Production. Elsevier, Amsterdam, 367 pp.  
 Meul *et al.* 2005. Eco-efficiency of specialised dairy farms in Flanders. Accessed on:  
<http://www.kuleuven.ac.be/stedula//nl/publicaties/meul.pdf>

## COMPARING THE SUSTAINABILITY OF FARMING IN IRELAND AND FRANCE

E. Dillon,<sup>1\*</sup> C. Garnache,<sup>2</sup> T. Hennessy,<sup>1</sup> S. Hynes.<sup>1</sup>

<sup>1</sup> Rural Economy Research Centre, Teagasc, Athenry, Co. Galway, Ireland.

<sup>2</sup> AgroParisTech School /INRA: Department of Public Economy, Paris-Grignon, France.

### Introduction

Sustainable agriculture is defined as a practise that meets current and long-term needs for food, fibre, and other related needs of society, while maximizing net benefits through the conservation of resources to maintain other ecosystem services and functions, and long-term human development. This definition emphasizes the multidimensional (economic, environmental and social) goals of sustainable development in agricultural terms (Rao and Rogers, 2006). Sustainable development at sectoral (i.e., agriculture) and territorial (i.e., rural area) level represents a priority objective of European Union strategy (Commission of the European Communities, 2001). The overall objective of this paper is to examine and compare the sustainability of farming in two European Member States; Ireland and France, using FADN data to develop a number of relevant sustainability indicators.<sup>1</sup> Irish agriculture is an indigenous sector that has strong linkages within the economy. Of the total land area (6.9m ha.), 64% (4.3m ha.) is used for agriculture with a further 11% used for forestry (710,000 ha.) 80% (3.4m ha.) of this agricultural area is devoted to grass, 11% (0.5m ha.) to rough grazing and 9% (0.4m ha.) to crop production. Although the economic importance of primary agriculture has reduced in recent years, it remains significant, accounting for 2.3% of GDP at factor cost, in 2006 (Department of Agriculture & Food, 2007). French agriculture is more diversified and is typically carried out on a much larger scale.<sup>2</sup> 33 million hectares (60%) of French land is used for agricultural purposes, among which one-third consists of permanent grassland. Worth €61bn. in 2005, French agriculture accounted for 22.5% of the EU-15 and 22% of EU-25 agricultural production (SCEES, 2006).

### Methodology

Both economic and environmental indicators of sustainability are calculated here. The Irish data used is that of the National Farm Survey, which is collected as part of the Farm Accountancy Data Network of the EU (FADN). It is a random sample of 1,200 farms representing approximately 115,000 farms.<sup>3</sup> The dataset Réseau d'Information Comptable Agricole (RICA) is the French equivalent where an average of 7,350 farms are surveyed annually and the sample is representative of farming system types from both the regional and national levels. Twelve *environmental indicators* were calculated; these concerned soil quality (stocking capacity, soil compaction from bovine pressure, contamination from crop protection products); soil quantity (erosion and carbon loss risk); water quality (organic nitrogen produced on-farm, mineral nitrogen used, total nitrogen pressure) and air quality (CO<sub>2</sub> - energy use, methane (CH<sub>4</sub>) and nitrous oxide (N<sub>2</sub>O) emissions and Green House Gas emissions in CO<sub>2</sub> equivalents from methane and N<sub>2</sub>O). *Economic indicators* calculated broadly relate to family farm income (FFI), viability and reliance on subsidies (per hectare, per labour unit and per asset value).

### Results

For illustrative purposes, two indicators are reported on here. Firstly, it was found that on average Irish farms ranked higher on organic nitrogen production but lower for mineral nitrogen fertiliser consumption than their French counterparts (see fig. 1 below). As Ireland is more specialised in livestock than France, relatively more manure is produced and thus additional mineral fertilisers are not therefore required in as large a quantity as is the case in the latter.

\* Corresponding author – [Emma.Dillon@teagasc.ie](mailto:Emma.Dillon@teagasc.ie)

<sup>1</sup> This paper will focus on the economic and environmental dimensions of sustainability due to the lack of information in the FADN data on the social element.

<sup>2</sup> Among the 545,000 farms in 2005, 64% were termed 'commercial' farms, employing 820,000 people.

<sup>3</sup> These can be differentiated by farm system and there is a nationally representative weighting attached. Please note that a warning attaches the interpretation of results as the sampling method for both datasets is not the same.

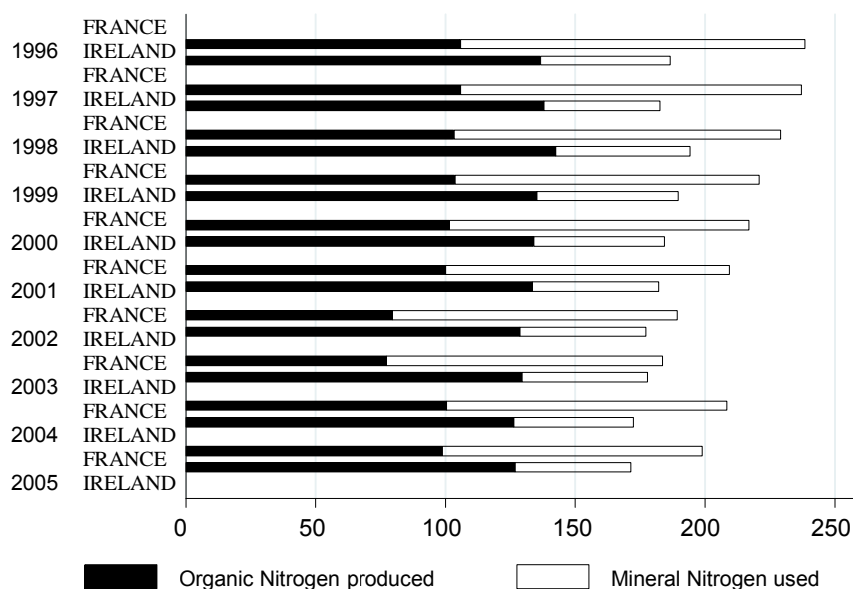

Fig. 1: Total Nitrogen on-farm (kg/ha)

Secondly, taking FFI per ha. into account, it was found that, on average; French farms fared much better than Irish farms over the period 1996 – 2005 (see fig. 2 below). Average FFI per ha. was found to be €1,991 and €450 respectively; albeit with a larger standard deviation. FFI per labour unit and per asset value were also found to be higher on average, in France, over the ten-year period.<sup>4</sup>

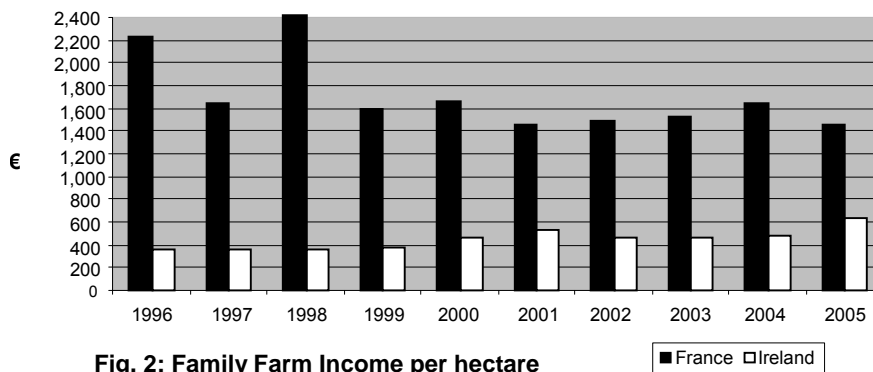

Fig. 2: Family Farm Income per hectare

**Conclusions**

Differences across the agricultural landscape were found to have a bearing on the environmental sustainability of agriculture in both Ireland and France. In economic terms, FFI tended to be generally higher in France with a higher reliance on subsidies per ha and per labour unit (on average) in Ireland.

**References**

- Department of Agriculture and Food. Compendium of Agricultural Statistics, 2006.
- European Commission, 2001. A Framework for Indicators for the Economic and Social Dimensions of Sustainable Agriculture and Rural Development. European Commission, Agriculture Directorate-General.
- Rao, N., H., and Rogers, P. P., 2006. Assessment of agricultural sustainability in *Current Science*, vol. 91, No. 4, August, 2006.
- SCEES – Bureau de l’information statistique. Agreste Cahiers - Enquête sur la structure des exploitations en 2005. Agreste Cahiers No. 4, December 2006.

<sup>4</sup> These results are further detailed in Dillon et al (forthcoming in the Teagasc RERC Working Paper Series).

## AGRICULTURAL MANAGEMENT AND SUSTAINABILITY ANALYSIS OF THE FARMING SYSTEMS IN THE CAPITANATA DISTRICT

M. Florio, M. Monteleone, E. Tarantino

Department of Agro-Environmental Science, Chemistry and Plant Defense, University of Foggia, Italy.  
[m.florio@unifg.it](mailto:m.florio@unifg.it)

The assessment of sustainability of agricultural systems in Capitanata (a plain area of widespread intensive agriculture in the Apulia region – South Italy), is of primary importance for an agro-ecological analysis. This study, after setting the methodology, deal with the analysis of agricultural management at farm level, with particular reference to the risk assessment of soil fertility and other agro-ecological resources. A comparison was moreover set up between conventional and integrated/ecological agricultural systems, the latter assumed as desirable reference.

### Methodology

The methodology used for this study is the European standard related to the I/EAFS planning (Vereijken, 1997), with the addition of further local indicators, complementary or specific to the analysis. The usual general indicators of the I/EAFS methodology were applied, such as the Ecological Infrastructure Index (EII), Soil Cover Index (SCI), the Net Surplus (NS), the Quality Production Index (QPI), the pH and electrical conductivity of the soil (ECe), Nitrogen in Ground Water (NGW), Organic Matter Annual Reserves and Organic Matter Annual Balance (OMAR, OMAB), Total Nitrogen Reserve/Balance (TNAR, TNAB), Phosphorus Reserve/Balance (PAR, PAB), Potassium Reserve/Balance (KAR, KAB). A Multifunctional Crop Rotation (MCR) appraisal has been also applied and its parameters have been determined (share species, share group, cover index, structure index, etc.). Further crop-system analysis were performed in order to assess the local levels of external energy input (measured as  $Tep\ ha^{-1}$ ) and energy use efficiency (output-input energy ratio) with respect to each crop. Another new index was also taken into account, set up to evaluate the quality (toxicological class) and quantity ( $kg\ ha^{-1}$ ) in the use of pesticides (IUP). Nine farms were examined, chosen in order to study at best all possible factors of farm diversification (economic structure, field dimension, crops system, etc). For each farm the management modes were analyzed, with specific reference to the type of agronomic management of the crops, crop rotation, irrigation management, management of cropping residues, land water management, etc.

Based on the results of farm analysis and on the assessment in terms of agronomic management, a crop-based energy analysis was carried out, aiming at the identification of external energy inputs, product output and consequent energy efficiency. According to Parenti et al., 1993, energy inputs necessary to production were subdivided in "direct" (combustible material, fuels, electric energy, etc.) and "indirect" (fertilizers, pesticides, irrigation water, machines, tools, etc.). Although some authors judge it immaterial, human labor was also taken into account, evaluating it based on the energy contained in the human food ration, in order to make a comparison between different crops taking the various labor needs into account.

### Results

Farm analysis indicated a non sustainable agricultural scenario, with a general state of agro-environmental deterioration associated with a global economic and productive dissatisfaction of farmers. The conventional agricultural system, usually applied, is very far from integrated or

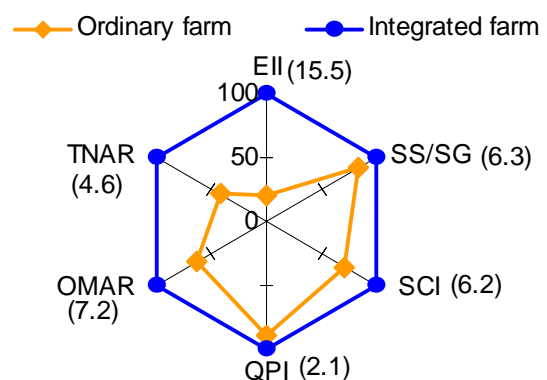

Fig. 1 – Few agricultural sustainability indicators as compared between conventional and integrated agricultural systems (the indexes are expressed as percentage with respect to the integrated farming conditions; standard error of the mean in parenthesis).

ecological agricultural systems. Farmers have very different objectives compared to those indicated by I/EAFS. Their primary objective is income, mainly considered in terms of quantity and not quality. Environmental targets as soil resources, water conservation or biodiversity protection have a secondary or even marginal role.

In this study, for the sake of concision, only a few of the agro-environmental indicators collected in 9 farms over the 2003-2005 period are reported. Such values moreover represent an average among the farms taken into account, each of them however being always very far from its respective integrated agricultural systems (Fig. 1).

Such values are moreover sided by the assessment of a scarce ecological awareness: farms often lack of land water management practices completely, they carry out incorrect irrigation management and practices like burning cropping residues are, unfortunately, well established. Conventional agricultural management is moreover based on continuous and massive external energy input, without a rationale for optimization. Moreover, to each crop may correspond very different energy inputs.

Energy balances were processed for tomato, sugar beet, durum wheat, grapevine and olive groves, the main crops of the high Capitanata plain (Fig. 2). Such analysis highlighted a considerable variability of energy inputs among different crops.

Moreover, higher inputs not always correspond to a higher energy efficiency. For the tomato, for example, very high energy inputs correspond to a very low efficiency. This analysis highlighted, in general, that tomato is the crop with the higher energy impact. Such crop is also marked by other factors which have a negative impact on farm management.

In particular, tomato cropping induces, given the absence of catch-crops, long periods of bare soil without cover, thus causing considerable risks of erosion, especially during winter. At the same time, in the Capitanata district context, the tomato crop is doubtlessly the highest yielding crop among those analyzed. This observation therefore confirms the conflict between the "revenue" and "environment" objectives.

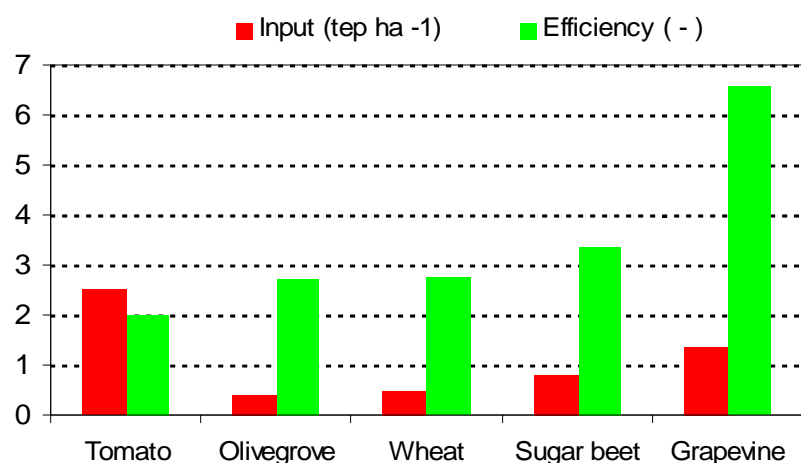

Fig. 2 – Crop based input and energy efficiency

## Conclusions

The analysis allowed to highlight the critical nature of ordinary farm management in relation to sustainable agricultural systems and the identification of the crop having the highest energy and agronomic impact and in general with the highest risks of agro-environmental deterioration. In the district of Capitanata, a better balance in farm management should be encouraged, developing and enhancing ecologic awareness and applying the "Agricultural good practice norms" correctly. It is moreover necessary to avoid the excess increase of processing tomato crops, which have boosted over the last few years due to the crises of the sugar production sector and progressive reduction of sugar beet crops. Alternative crops must be promoted, possibly re-discovering traditional ones (pulses, other cereals, etc).

## References

- P.Vereijken, A methodical way of prototyping integrated and ecological arable farming system (I/EAFS) in interaction with pilot farms, 1997. *European Journal of Agronomy*, 7, 235-250.
- C.Pacini, et al., Valuation of sustainability of organic, integrated and conventional farming system: a farm and field scale analysis, 2003. *Ecosystems and Environment*, 95, 273-288.
- A.Parenti et al., L'analisi energetica per un miglior uso delle risorse nei processi agricoli. Applicazione ad aziende toscane, 1993. *Rivista di Ingegneria Agraria*, 4, 246-254.

## **AN ENVIRONMENTAL ASSESSMENT TOOL FOR ORGANIC VITICULTURE BASED ON A FUZZY EXPERT SYSTEM**

G. Fragoulis<sup>1</sup>, M. Trevisan<sup>1</sup>, E. Capri<sup>1</sup>, A. Di Guardo<sup>2</sup>, A. Sorce<sup>2</sup>

<sup>1</sup> Istituto di Chimica Agraria ed Ambientale, Università Cattolica del Sacro Cuore, Via Emilia Parmense 84, 29100, Piacenza, ITALY. e-mail: george.fragoulis@unicatt.it

<sup>2</sup> Informatica Ambientale S.r.l., Via Teodosio, 13, 20131, Milan, ITALY

### **Introduction**

The agricultural practices vary; from the fertilization to the protection of the culture with plant protective products, from the irrigation to the soil cultivation. As far as concerns the environmental impact related to organic viticulture it is not clear how much the organic farms improve the environmental quality compared to the traditional agricultural activities. The aim of this paper is to describe the development of an environmental assessment tool, reliable to EU organic farm management that could help as a decision support system for farmers and other property managers in choosing among options and evaluating the impact of their choices. The tool aims to measure the actual environmental impact produced by agro-ecosystem in the spatial boundaries of the farm and produce advice for improving the sustainability of the human actions.

### **The fuzzy expert system**

The theory of fuzzy is used to describe relationships that are best characterised by compliance to a collection of attributes (Zadeh, 1965). For each agronomical practice, two functions describing membership to the fuzzy subsets Favourable (F) and Unfavourable (U) have been defined. At the same time, the limit values beyond which the index is certainly F or U must be given. With this procedure, three membership classes are created; F, U, and partial (or fuzzy) membership. These limit values are based on criteria drawn from the literature or on expert judgment. The fuzzy theory addresses this type of problem allowing one to define the degree of membership of an element in a set by means of membership functions that can take any value from the interval [0.0, 1.0]. The value 0.0 represents complete non-membership; the value 1.0 represents complete membership and the values in between represent partial membership. The hierarchical structure of this technique is used to aggregate indices into first level fuzzy indicators and next, into a second level fuzzy indicator for the whole system. Each objective in the attribute hierarchy is given a weight. For each module a set of decision rules has been formulated, attributing values between 0 and 1 to an output variable according to the membership of its input variables to the fuzzy subsets F and U and according to Sugeno's inference method (Sugeno, 1985).

### **The structure of the assessment tool**

The main agronomic practices used in the organic viticulture and having an impact on the environment are: a) the pest control management b) the soil management and machinery use c) fertilization management and d) the irrigation management. The impact of organic viticulture on soil organic matter and on flora and fauna biodiversity is also estimated.

The assessment tool is organized in 6 modules:

#### **Module for Pest Management**

The module for pest management is based on the Environmental Potential Risk Indicator for Pesticide (EPRIP, Padovani et al., 2004) and is composed of modules for groundwater, surface water and soil compartments.

#### **Module for Fertilization Management**

The module for the fertilization management takes into account the presence, the type (legumes, grass or other, mixture) and the yield (kg/ha) of cover crops, the use of compost and the possible use of commercial fertilizer and is composed of a nitrogen (N), a phosphorous (P<sub>2</sub>O<sub>5</sub>) and a potassium (K<sub>2</sub>O) sub-indicators. These three sub-indicators take into account the demand for nutrients (N, P<sub>2</sub>O<sub>5</sub>, K<sub>2</sub>O) of an organic vineyard with or without the presence of cover crops. The module also estimates the N release from humus mineralization, the cover crop demand for N or



the cover crop contribution of N, and the total nutrient that becomes available for the plant uptake after the compost and/or commercial fertilizer use.

### **Module for Water Management**

The modules relevant to the water management are: a) the module for water management irrigation rate that estimates the net irrigation requirements for a vineyard using data of the reference evapotranspiration (ET<sub>o</sub>), crop coefficient (K<sub>c</sub>) for grapevines, monthly average rainfall and average in-season irrigation requirements for cover crops and it compares it with the irrigation water (IW, mm) applied during the vine growing season. b) the module for irrigation water quality that is composed of three sub-indicators: The Water Management Salinity Indicator is a function of electric conductivity (EC, mmhos/cm) and total dissolved solids (TDS, mg/l) in irrigation water and irrigation system. The Water Management Infiltration Indicator (WMII) is a function of EC and sodium adsorption ratio (SAR, mmol/l) in irrigation water and irrigation system. Finally Water Management Ion Toxicity Indicator (WMITI) is a function of the concentration of sodium (Na, meq/l), chlorine (Cl, meq/l) and boron (B, mg/l) in irrigation water.

### **Module for Soil Management and Machinery Use**

The module for soil management and machinery use is composed of three sub-indicators. The module for machinery use takes into account the machinery power per hours and the level of soil compaction. The module for cover crop use sees the use of cover crops as a positive soil management practice and finally the module for commercial fertilizer use sees the commercial fertilizer use negatively on the soil management.

### **Module for Soil Organic Matter**

The module for soil organic matter is based on the organic matter indicator ( $I_{mo}$ , Bockstaller et al., 1997) and is a function of the recommended annual organic matter input for the vineyard and the actual annual organic matter input from compost (or manure) and cover crops (kg/ha).

### **Module for Soil Fauna and Flora Biodiversity**

The module relevant to the biodiversity are: Module for soil fauna biodiversity and module for flora biodiversity and are both based on the Simpson's Diversity Index (D).

### **Environmental Impact of Organic Viticulture**

Synthesising the 6 mentioned modules, the overall indicator for the environmental impact of the agronomical practices in organic viticulture is obtained according to a set of 64 decision rules.

### **Discussion**

The objective of an agro-ecological indicator is to render reality intelligible, and thus its validation consists of determining its value to potential users (Girardin et al., 1999). The tool to assess the environmental impact of organic viticulture proposed is currently being tested (validated) on several pilot organic farms in Italy, Germany, Switzerland and France.

### **References**

- Bockstaller, C., P. Girardin, and H.M.G. van der Werf., 1997. Use of agro-ecological indicators for the evaluation of farming systems. *Eur. J. Agron.* 7:261–270.
- Girardin P, C Bockstaller, H Van der Werf, 1999. Indicators: Tools to evaluate the environmental impacts of farming systems *Journal of Sustainable Agriculture*, 13(4): 5-21.
- Padovani L., Trevisan M., Capri E. 2004. A calculation procedure to assess potential environmental risk of pesticides at the farm level. *Ecological Indicators* 4: 111–123.
- Simpson E. H. (1949) Measurement of diversity. *Nature* 163:688
- Sugeno, M., 1985. An introductory survey of fuzzy control. *Inf. Sci. (NY)* 36:59–83.
- Zadeh, L.A. 1965. Fuzzy sets. *Inf. Control* 8:338–353.

## INDICATION OF PLANT PROTECTION MEASURES ON THE FARM LEVEL WITHIN A FARM EVALUATION CONCEPT

W Heyer, O Christen

Martin-Luther-Universität Halle, Ludwig-Wucherer Str. 2, D-06108 Halle/Saale, Germany  
Email: [wolfgang.heyer@landw.uni-halle.de](mailto:wolfgang.heyer@landw.uni-halle.de); [olaf.christen@landw.uni-halle.de](mailto:olaf.christen@landw.uni-halle.de)

### Introduction

In the context of the common agricultural policy of the EU, environmentally sound agricultural production as well as increasing requirements of health and consumer protection have gained a greater importance. On the farm level this is reflected in the development of environment and/or quality management systems. These systems support the farmer in decision making and help to optimise the use of plant protection measures. In this paper we introduce the REPRO system, which is a computer based tool for farm and environmental management. With REPRO it is possible to evaluate the impact of all farm operations on environmental goods. In various projects we could demonstrate that the REPRO plant protection indicators were suitable for both decision making within the farm management process and assessment of the potential environmental impact of plant protection intensity.

### Methodology

The software "REPRO" creates a virtual farm (including farm site, farm structure and the farmer activities). This virtual farm is the basis for data analysis, allowing economic and environmental evaluation. Key parameters managed within the system include: (a) farm site (weather and basic soil data); (b) farm structure (fields, cropping patterns, crop rotation, livestock categories, livestock performance); (c) cropping (technology, fertilization, yields, products); (d) yield (main and by product) and product quality; (e) storage (product in- and output); (f) costs (gross margins, total costs). These data are completed using comprehensive data master files. These contain product information (fertilizer, pesticides), results of long-term experiments (e.g. humus formation) and various other standard data and coefficients (e.g. soil characterization, machinery). These data allow farm processes to be analysed, and enable the impact of farm operations on environmental goods to be evaluated. In addition to plant protection data, analyses also consider, for example, on-farm matter cycle (N, P, K, C), N-turnover, humus and energy balancing, erosion risks and biodiversity.

### Results

Plant protection forms an important part of the whole-farm evaluation. Data input is ensured with the support of comprehensive master files. This allows the correct recording of applied products, whether using the product name or the official registration number. In addition, the date of application, product quantity per ha, extent of treatment (complete field or field parts), the application method (spray or seed treatment) and costs (product and process) are also included. REPRO involves the plant protection indicators shown in Table 1 (Heyer *et al.*, 2005).

Analysis of several agricultural enterprises (n = 25) on the basis of 'treatment index' and 'REPRO assessment number' showed an agriculturally acceptable use of pesticides. Nevertheless, between the enterprises, differences in plant protection intensity were

Table 1. Plant protection indicators within the REPRO concept.

	Reference unit / level	Content and aim of indicator application
<i>Indicators used in documentation and management</i>		
Product quantity (litres/ha, kg/ha)	Field and sub-field; crop groups and crop; crop rotation; arable land, grassland; farm	Quantitative indicators, used with the aim of farm management.
Costs (€/ha)		
Number of applications		
Treated area (ha or %)		
Non-treated area (ha or %)		
<i>Indicators used in farm evaluation</i>		
Farm application index (without dimension)	10 most important crops in the farm	Indicator with aggregated information about frequency, amount and area of treatment. Plant protection intensity.
REPRO valuation index (without dimension)	10 main field crops; farm level	Adaptation of the 'Farm application index' to the REPRO concept. Purpose of comparability to other REPRO indicators.
Fossil energy use (MJ/ha)	See above	Basic information for energy balancing.
<i>Indicator used in environmental risk evaluation</i>		
Automated data transfer to external software (e.g. SYNOPS, Heyer et al. 2005)	See above	Potential environmental risk evaluation focused on soil, water and biotic goods. Scientific questions.

demonstrated, which could not be explained by different cropping patterns or by farm site. This finding indicates that the plant protection management of farms compared was handled very differently and that there are possibilities to optimise plant protection activities. It also illustrates that more intensive plant protection measures often did not result in higher yields or that N efficiency was reduced following adoption of sub-optimal plant protection measures.

### Conclusion

Considering the different evaluation levels (sub-field, field, crop, crop rotation or the complete farm), the analyses were comprehensive and ways to improve plant protection strategies could often be recommended. Further qualification of the REPRO results requires improved means for complex data analysis of factors such as the interactions between plant protection, fertilization and energy gain. This work is currently underway.

### References

Heyer W; Rossberg D; Abraham J; Christen O (2005). Erfassung und Beurteilung der Intensität des betrieblichen Pflanzenschutzes innerhalb des REPRO-Konzeptes. *Nachrichtenblatt des Deutschen Pflanzenschutzdienst* **57**, 126-131.

## A FARM-SCALE INTERNET-BASED TOOL FOR ASSESSING NITROGEN LOSSES TO THE ENVIRONMENT

N.J. Hutchings, B.M. Petersen, I.S. Kristensen, M.S. Jørgensen, F.P. Vinther and N. Detlefsen

Inst. of Agroecology, University of Aarhus, Denmark, [nick.hutchings@agrsci.dk](mailto:nick.hutchings@agrsci.dk)

### Introduction

When farmers wish to intensify their operations, the authorities must consider compliance with a range of EU Directives. Regarding nitrogen (N), these include the National Emission Ceiling (NEC), Habitat, Nitrates and Water Framework Directives. On livestock farms, the N emission sources are losses of ammonia (NH<sub>3</sub>), oxides of nitrogen (NO<sub>x</sub>) and dinitrogen (N<sub>2</sub>) from animal housing, manure storage, field-applied manure and fertilizer, crops and soil. N imported to the farm as fertilizer or animal feed passes through a variety of interlinked pathways, so emissions from one source can influence the emissions from other sources. This makes it difficult to assess the effect of increases in intensification or the application of abatement measures on N losses to the environment. The farm N surplus (import - export) includes these losses but the problem is whether it is feasible in practice to partition the surplus between losses. Here we describe a prototype decisions support tool developed in Denmark.

### Methodology

The farm N inputs are imports of the purchased items; mineral fertilizer, animal feed, bedding, animal manure, livestock and seed, and the non-purchased items; N fixation and atmospheric N deposition. The farm N outputs are the crop and animal products sold, including any livestock manure. An N flow approach is then used in the calculation of internal N flows and emissions.

The following inputs will be known for the farm after the proposed intensification; the number and type of livestock to be kept, the animal housing and manure storage facilities to be used, the area and soil type of the fields available to the farm, previous land use and proposed field management (cropping, fertilization, manure application method), the proportion of the production of each crop to be sold, whether any straw produced is to be sold and whether a crop is to be grazed. For livestock, the production parameters will be known, e.g. the expected growth rate, annual milk production. For ruminants, an estimate of the proportion of feed from home-grown crops will be known. Standard values are available for the dry matter, energy and protein in crop production, depending on soil type and assuming the maximum N fertilization permitted by national legislation.

The model calculates the import of animal feed that is necessary to satisfy the livestock requirements from standard values or relationships. If crop production exceeds livestock requirements, the surplus will be sold. N excreted in feces and urine is estimated, based on the feed ration and the N partitioned to animal products. The type of animal housing determines the type of manure produced and the addition of N in bedding. The emission of N as ammonia (NH<sub>3</sub>) from animal housing, as NH<sub>3</sub>, nitrous oxide (N<sub>2</sub>O) and dinitrogen (N<sub>2</sub>) from manure storage and as NH<sub>3</sub> following field application are then estimated using standard emission factors for each combination of manure type x application technique (Hutchings *et al*, 2000). The maximum capacity of the crops to utilize N is calculated from the crop mixture and the maximum N fertilization permitted for each crop. If insufficient manure N will be available, the deficit is filled using supplementary mineral N fertilizer. If the manure N available exceeds the permissible application, the surplus must be exported.

The N input to the fields and the amount exported in the harvest are now calculated. The difference is then partitioned between losses of N<sub>2</sub>O, N<sub>2</sub>, NO<sub>3</sub> and changes in the soil N. Simple models are used for soil N<sub>2</sub>O and N<sub>2</sub> emissions via denitrification (Vinther and Hansen, 2004), NO<sub>3</sub> leaching (Simmelsgaard and Djurhuus, 1998) and the change in soil N (Petersen *et al*, 2002).

Since the sum of the total predicted N loss and change in soil N is inevitably either be greater or lesser than the farm N surplus, it is necessary to partition the residual. The residual is partitioned by a very simple algorithm, utilising constants for the fraction of the residual accounted for by leaching, denitrification, the change in soil N and harvested N.

The model was used to simulate the N losses from two scenarios; Scenario 1 is a pig farm with fully-slatted flooring and manure application by trailing hose. In Scenario 2, measures are introduced to reduce NH<sub>3</sub> emission from the housing and manure application. In Scenario 3, the mineral fertilizer used is reduced until the NO<sub>3</sub> leaching is no greater than in Scenario 1.

## Results

Table 1 shows the annual farm N balance and the main components.

Item	Scenario 1		Scenario 2		Scenario 3
	Result	Adjusted	Result	Adjusted	Adjusted
	kg ha <sup>-1</sup> a <sup>-1</sup> N				
Imported fertilizer	37	37	28	28	23
Imported animal feed	245	245	245	245	245
Imported seed	3	3	3	3	3
Deposition from atmosphere	15	15	15	15	15
<i>Total import</i>	<i>299</i>	<i>299</i>	<i>291</i>	<i>291</i>	<i>286</i>
Exported crop	65	83	65	85	82
Exported meat	63	63	63	63	63
Exported manure	0	0	0	0	0
<i>Total export</i>	<i>128</i>	<i>146</i>	<i>128</i>	<i>148</i>	<i>145</i>
<i>Surplus</i>	<i>171</i>	<i>153</i>	<i>163</i>	<i>143</i>	<i>141</i>
NH <sub>3</sub> from animal housing	25	25	13	13	13
NH <sub>3</sub> from manure storage	4	4	4	4	4
NH <sub>3</sub> from field-applied manure	12	12	8	8	8
N <sub>2</sub> /N <sub>2</sub> O from soil	7	11	8	13	12
NO <sub>3</sub> leached	75	89	83	100	89
Change in soil N	8	12	8	14	13
<i>Residual</i>	<i>40</i>	<i>0</i>	<i>43</i>	<i>0</i>	<i>0</i>

## Discussion and conclusions

The introduction of measures to reduce the NH<sub>3</sub> emission resulted in an increase in crop yield but also in the loss of NO<sub>3</sub> and N<sub>2</sub>/N<sub>2</sub>O. The additional losses could be removed by adjusting the input of mineral N fertilizer. This shows the need to consider the whole farm system when assessing the consequences of measures to reduce losses to the environment.

In the initial calculation, the fate of over 40kg of the N surplus could not be determined. Since the reduction in N losses resulting from the abatement measures was only 10 kg, the example shows there is a need for the development of a more sophisticated method for partitioning the N surplus.

## References

- N.J.Hutchings et al., A detailed ammonia emission inventory for Denmark, 2001. Atmos. Environ. 35, 1959-1968.
- B.M.Petersen et al., A flexible tool for simulation of soil carbon turnover, 2002. Ecol. Modelling 151, 1-14.
- S.E.Simmelsgaard and J.Djurhuus, An empirical model for estimating nitrate leaching as affected by crop type and the long-term N fertilizer rate, 1998. Soil Use and Management 14, 37-43.
- F.P.Vinther and S.Hansen, SimDen – A simple model to quantify N<sub>2</sub>O emission denitrification. Danish Institute of Agricultural Sciences, 2004. Report no 104, pp 47. (in Danish).

## OUTDOOR PIGS: THEIR IMPACT ON THE ENVIRONMENT

C. F. E. Topp<sup>1</sup>, C. A. Watson<sup>2</sup>

<sup>1</sup> Land Economy & Environment Group, Research Division, SAC, UK, [Kairsty.Topp@sac.ac.uk](mailto:Kairsty.Topp@sac.ac.uk)

<sup>2</sup> Crop and Soil Systems Group, Research Division, SAC, UK, [Christine.Watson@sac.ac.uk](mailto:Christine.Watson@sac.ac.uk)

### Introduction

Approximately 25% of the UK pig breeding herd is kept in outdoor systems. This method of production is preferred by consumers as it has perceived animal welfare benefits. In addition, outdoor pig production appears to meet the criteria for social and economic sustainability (Edwards, 2005), however there are potentially large losses of nutrients which brings into question its environmental sustainability. The leaching and gaseous losses occur because of the high level of nutrients deposited on free draining land, and the removal of vegetation by the foraging activity of sows. This paper explores the environmental consequences of outdoor breeding pig production at the farm level in an area of East Anglia, which has a significant number of outdoor pig producers. To evaluate the rotation / management strategies of outdoor pig production the NDicea (Nitrogen Dynamics In Crop rotations in Ecological Agriculture) model has been used. It simulates the key processes of nitrogen dynamics and has location-specific inputs and it was developed to enable assessment of organic fertilization strategies and crop rotations within the context of the farm using relatively easily obtainable information on initial states, parameters and driving variables (Van der Burgt et al., 2006). The model describes dynamics of soil water, carbon, organic matter, organic nitrogen and inorganic nitrogen for a soil with two layers in relation to weather and crop demands over the course of the rotation.

### Methodology

Using data from surveys that were conducted in the area which has been augmented with information from a farm business advisor, a typical rotation has been developed, Fig 1a. The soil type in East Anglia was assumed to be slightly loamy sand. It is assumed that the pig excretions from the 19 sows ha<sup>-1</sup>, which results in an application rate of 650 kg N annum<sup>-1</sup>, are applied on a monthly basis. For the NDicea model, which has been used to assess the different rotations, the input variables include the quantity of manure / fertilizer applied, the planting date and harvest date and the expected yield of the crop.

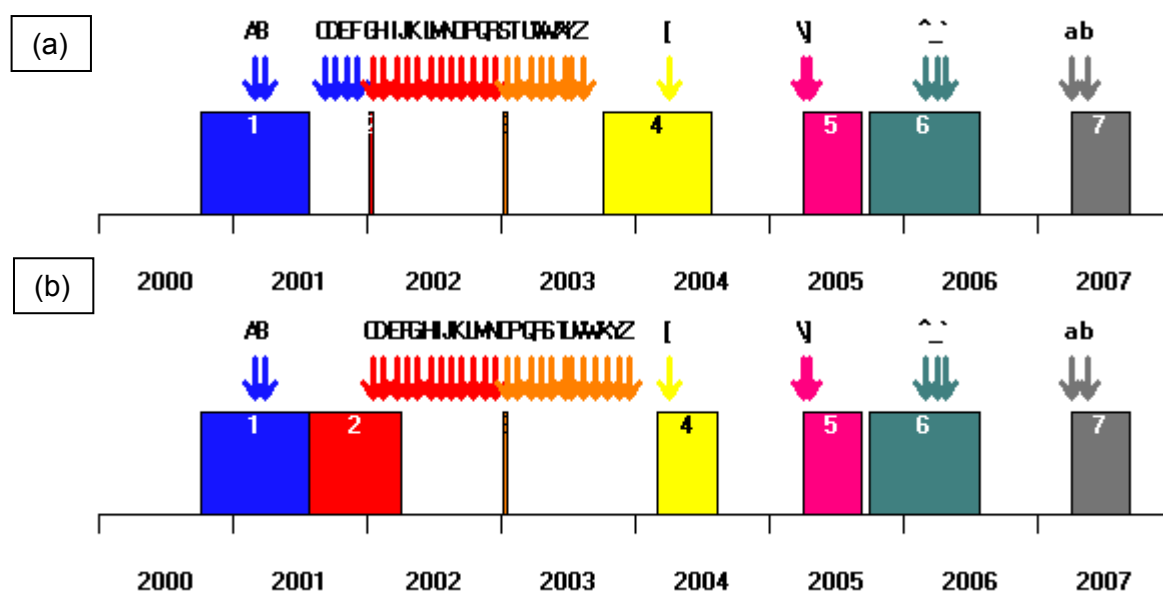

Fig 1. A typical and an alternative crop rotation including outdoor sows. The arrows indicate the applications of manure or fertilizer. (a) winter barley (1), pigs (2), pigs (3), winter wheat (4), sugar beet (5), winter wheat (6), potatoes (7). (b) winter barley (1), barley stubble undersown with grass (2) pigs, pigs (3), spring barley (4), sugar beet (5), winter wheat (6), potatoes (7).

An alternative scenario is presented in Fig 1b. In scenario 1b, the winter wheat stubble is undersown with grass. In order to allow the grass time to establish, the pigs are not put on the paddock until January; and hence the crop following the pigs is spring barley.

## Results

The predicted impact in East Anglia of putting the pigs on to a grass paddock in January of 2002 instead of the autumn of 2001 is that the leaching and denitrification losses in 2001 and 2002 are reduced, Fig 2. However, the predicted leaching losses in 2003 are substantially increased, and thus there is only a very slight reduction in the leaching losses over the whole rotation. This is partially because of the change in the cropping rotation to accommodate the undersowing and establishment of the grass, which results in a reduction in N-uptake of 50 kg N for the grass and spring barley compared to the winter wheat crop. These scenarios were also run for climatic and soil conditions experienced in Aberdeenshire (results not shown). These predicted results indicate that although the climate and soil type impact on the overall losses from the system, the relative differences between the scenarios is very similar. Nevertheless, the climate and soil do have a small impact on the predicted ratio of leaching to denitrification losses.

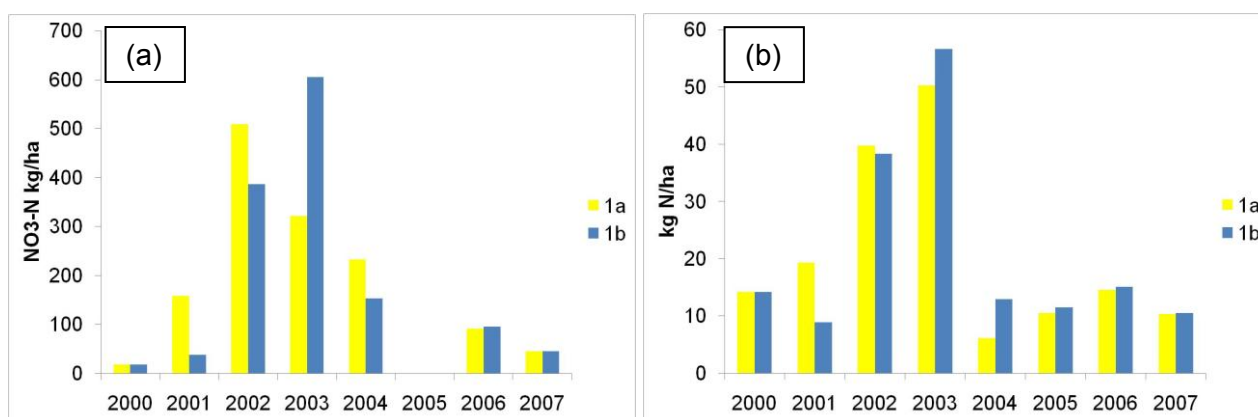

Fig 2. The annual (a) leaching losses and (b) denitrification losses for scenarios 1a and 1b for East Anglia.

## Conclusions

The predicted results indicate that it is crucial to assess the impact of changes in any given year on the whole rotation as any change can have a knock-on effect in subsequent years, and hence has implications for the nutrient losses from the farm. Although changes in soil type and climate do impact on the predicted results, it is crucial in this model to have realistic information of the expected yields and manure / fertilizer applications at the site of interest as these determine the crop uptake and hence impact on the predicted availability of nitrogen within the soil and the losses from the rotation. Nevertheless, this example has shown that the model is a useful tool in comparing different alternative scenarios, and hence how the management of the outdoor pigs impact on the environmental sustainability of the farm. In addition, this example shows that the NDicea model can be used to assess the implications of rotation management on nutrient losses, which has consequences for farm sustainability.

## Acknowledgments

Funding was provided by the Defra project Ecopig (IS0215) and the Scottish Executive. The authors would like to thank the Ecopig project partners and Geert-Jan van der Burgt for his assistance in using the NDicea model.

## References

- S.A. Edwards, Product quality attributes associated with outdoor pig production, 2005. *Livestock Production Science* 94, 5-14.
- G.J.H.M. van der Burgt et al., The NDICEA model, a tool to improve nitrogen use efficiency in cropping systems, 2006. *Nutrient Management and Agroecosystems* 74, 275-294.

## OPTIMIZATION OF SUSTAINABLE FARMING SYSTEMS IN KARNATAKA STATE, INDIA - A LINEAR PROGRAMMING APPROACH\*

V.R.Kiresur<sup>1</sup>, V.S.Kulkarni<sup>2</sup>, G.M.Gaddi<sup>3</sup>, K.C.Gummagolmath<sup>4</sup> and P.S.Hiremath<sup>5</sup>

<sup>1</sup> University of Agricultural Sciences, Dharwad, Karnataka State, India, [kiresur\\_vr@yahoo.co.in](mailto:kiresur_vr@yahoo.co.in)

<sup>2</sup> University of Agricultural Sciences, Dharwad, Karnataka State, India, [vilasdharwad@rediffmail.com](mailto:vilasdharwad@rediffmail.com)

<sup>3</sup> College of Agriculture, Hassan, University of Agricultural Sciences, Bangalore, [gmgaddi@rediffmail.com](mailto:gmgaddi@rediffmail.com)

<sup>4</sup> National Institute of Agricultural Marketing, Jaipur, Rajasthan State, India, [kcgum@rediffmail.com](mailto:kcgum@rediffmail.com)

<sup>5</sup> GE Money-Global Decision Science Labs, Bangalore, Karnataka State, India, [prashantw9@yahoo.co.in](mailto:prashantw9@yahoo.co.in)

Due to continuous and intensive cultivation of land for meeting the objective of food security, natural resources have drastically degraded over time. Many a times, this process is irreversible and hence, such a loss of natural resources must be minimised in future at all costs; otherwise the costs of recovery would be too high to imagine if left unattended. Sustainable farming systems approach is one of the feasible options advocated for reducing degradation of natural resources. Sustainable agriculture is gaining lot of importance in recent years owing to its appropriate trade-off between resource conservation and profit maximisation. The adoption of agro-ecologically and socio-economically sustainable farming systems would lead to environment-friendly agricultural production, provide viable livelihoods to farm families and improve the quality of land, water, environment and living standards of the people- all on a continuous basis. Using certain suitable “sustainability indicators” and “optimization techniques”, the several farming systems practised across space and time could be assessed for their socio-economic and agro-ecological consequences on farming community, in particular and humanity in general. The present study attempts to identify the prevailing farming systems, assess the sustainability thereof, evolve optimum farm plans in the six northern agro-climatic zones of Karnataka State, India and suggest appropriate policy measures.

### Methodology

The study is based on primary data collected through structured survey using personal interview method from 360 farm households spread across six agro-climatic zones of Karnataka. Data were processed using, among others, Benefit-Cost Analysis (BCA), Sustainability Value Index (SVI) and Linear Programming (LP) technique. The BCA involved the computation of net farm income (NFI) and the Benefit-Cost Ratio (BCR). The NFI is the gross farm income minus total cost of production, whereas the BCR is the ratio between the two. While gross farm income refers to the market value of farm output, the total cost of production includes the cost of seed, manure, irrigation charges, animal feed, veterinary expenses, wages of human and bullock labour, depreciation of farm buildings and machinery, rental value of land, interest on working capital and marketing cost, etc. The benefits and costs in dairy, horticulture and fishery enterprises were amortized annually for comparison purposes. The SVI was computed as  $\{[ANI-(1.96*SD)]/MNI\}$  wherein ANI referred to Annual Net Income, MNI to Maximum Net Income (in the sample domain) and SD to Standard Deviation of net income. The deterministic LP technique was employed to estimate the maximum attainable income through optimisation of resource use and hence to identify optimum farm plans.

### Results

Seven major farming systems (FS) were identified in the study area, that is, six northern agro-climatic zones of Karnataka State (Z-1, Z-2, Z-3, Z-8, Z-9 and Z-10) as shown in Table-1. The NFI [in terms of rupees (INR) per hectare] and BCR were higher under FS-1 compared to FS-2 in Z-1, Z-2, Z-3 and Z-8, in general, due to saving in the cost of farm yard manure for cropping and on-farm availability of fodder for dairy animals. In Z-9, BCR was much higher under FS-4 compared to FS-1. In Z-10, the BCR was the highest under FS-4 followed by FS-6, FS-3, FS-4, FS-7 and FS-1. This indicates that dairy and horticulture crops were the most profitable enterprises complementing crop enterprise.



**Table-1: Benefit Cost Analysis across Farming Systems and Zones**

FS*	Z-1#		Z-2		Z-3		Z-8		Z-9		Z-10	
	NFI	BCR	NFI	BCR	NFI	BCR	NFI	BCR	NFI	BCR	NFI	BCR
FS-1	52,242	1.48	35,225	1.32	35,484	1.48	26,596	1.33	68,388	1.64	78,389	2.07
FS-2	38,799	1.45	13,852	1.16	27,939	1.46	10,686	1.17				
FS-3											523,863	2.16
FS-4									823,023	3.56	474,092	3.07
FS-5											1,824,622	2.43
FS-6											1,121,563	2.85
FS-7											417,553	2.64

\* FS-1=Crop+Dairy+ Draught Animals; FS-2= Crop+Draught Animals; FS-3=Crop+Horticulture; FS-4=Horticulture+Dairy; FS-5=Horticulture+Fisheries; FS-6=Horticulture; FS-7=Crop+Fisheries.  
 #Z-1=North-Eastern Transitional Zone; Z-2=North-Eastern Dry Zone; Z-3=Northern Dry Zone; Z-8=Northern Transitional Zone; Z-9=Hilly Zone; Z-10=Coastal Zone.

The SVI was higher under FS-1 (0.27, 0.14, 0.07 and 0.18) than under FS-2 (0.06, 0.01, 0.07 and 0.16) in Z-1, Z-2, Z-3 and Z-8, respectively. This was due to supplementary and complementary effects of dairy enterprise in these zones. While in Z-9, SVI was higher under FS-4 (0.34) than under FS-1 (0.01). The system wise comparison of SVI also indicated that horticulture in combination with crop enterprise (FS-4) was more stable than crop with dairy enterprise (FS-1). In Z-10, SVI was the highest under FS-1 (0.27) followed by FS-5, FS-7, FS-4 and FS-6.

The results of LP reveal that, in general, the existing allocation of resources by the farmers was sub-optimal. Hence, by mere reallocation of resources within the resource constraints (Model-I), farmers' net incomes could be increased by the order of 4 to 107 per cent over the existing net farm incomes, across all the zones and farming systems. Further, if resources could be reallocated relaxing any or all of the resource constraints (Model-II), the net farm incomes could be increased by 16 to 147 per cent over the existing net farm incomes. There was, however, some scope for relaxation of resource constraints, particularly labour and capital.

## Conclusions

In the selected six northern agro-climatic zones of Karnataka State, India, in general, there was ample scope for increasing the net farm income through introduction of dairy animals by the farmers under FS-2, while mere reallocation of resources would enhance farmers' net income considerably in FS-1. The results obtained in Z-9 and Z-10 could be demonstrated to farmers of other zones, particularly with respect to FS-4, FS-6 and FS-3. In order to increase and stabilize the incomes, there was a need to take up dairy enterprise with breeds, practices and facilities suitable to the agro-ecology of the region. FS-1 in Z-1, Z-2, Z-3, Z-8 and Z-10 and FS-4 in Z-9 were relatively more sustainable than other farming systems practised in the respective zones. Thus, dairy and horticulture enterprises in these zones could be encouraged through policy and infrastructure support. Through rigorous outreach activities, farmers in the region could be educated about the enhancement in their NFI due to reallocation of existing resources and also due to relaxation of resource constraints towards optimum farm plans. Farm resources, particularly capital, could be relaxed, if farmers were facilitated with liberalised and timely institutional finance.

## References

- Byerlee, D. *et al.*, Farming systems research - Issues in research strategy and technology design, 1982. *American Journal of Agricultural Economics*, **64**(5), 897-904.
- Grewal, S.S., Rapporteur's report on "Farming Systems in the Post-Green Revolution Belt", 1991. *Indian Journal of Agricultural Economics*, **46**(3), 498-501.
- Henny Mayrowani and Junk Goto, Potentials and constraints of banana-based farming systems: A case of an upland village in West Japan, 2002. *Japan International Research Centre for Agriculture Sciences*, No.29.
- Maji, C.C., Farming systems in the post green revolution belt, 1991. *Indian Journal of Agricultural Economics*, **46**(3), 403-411.
- Patil Jayant, Sustainable agricultural development: Issues and programs, 2003. *Financing Agriculture*, **35**(1), 35-37.
- Singh, R.K., Farming systems research: Present status and the future prospects in Indian context, 1994. *Agricultural Situation in India*, **49**(1), 3-12.

## ASSESSING SUSTAINABILITY OF AGRICULTURAL PRODUCTION SYSTEMS AT REGIONAL LEVEL: A CASE STUDY OF KHORASAN, IRAN

A. Koocheki, M. Nassiri

Department of Agronomy, Ferdowsi University of Mashhad, Iran, akooch@ferdowsi.um.ac.ir, mnassiri@ferdowsi.um.ac.ir

### Introduction

Khorasan province is located in North East of Iran between 36-37° N, with about 300,000 km<sup>2</sup> of surface area representing almost 20% of the country. Overall climate of Khorasan is semi-arid with mean annual precipitation of 250 mm. However, at least three different agroclimatic zones can be distinguished across the province. This climatic variability is led to development of diverse agricultural systems with significant contribution to the national food production. However, sustainability of agricultural systems of the province is poorly investigated.

Although a large number of indicators have been developed to evaluate agricultural sustainability, due to variation in biophysical and socioeconomic conditions, indicators used in one country are not necessarily applicable to other countries. Therefore, indicators should be location specific, constructed within the context of contemporary socioeconomic situation (Power, 1999). The objective of this study was to develop indicators appropriate for evaluating agricultural sustainability at the regional level in the Khorasan province, Iran.

### Methodology

Criteria and indicators were selected according to data availability, data sensitivity to temporal change, and the capacity of the data to quantify the behavior of the regional agricultural systems. Data were collected from statistical database of the Agricultural Ministry and farmers through a questionnaire survey, observation and discussions with progressive farmers, and extension officials. The survey was conducted in the agricultural years 1993, 2001 and 2005.

Five criteria were taken into consideration and each criterion was assessed by means of several indicators. The selected criteria included productivity (indicators: yield and yield stability), compatibility (indicators: biodiversity and biocide use) agroecosystem efficiency (indicators: fertilizer/water use efficiency, input/output of energy) nutrient balance (indicator: input/output ratio of the total quantity of N, P and K) and equity (indicators: per capita income, net output per unit land, education level). Indicators were quantified as partial indices. The partial indices describing the indicators were normalized between 0 and 1 relative to their maximum values. An aggregated index of sustainability was generated by averaging the partial indexes, following the approach implemented by Hansen and Jones (1996) for farming systems.

### Results

Average crop yield in the studied region is increased by 50% during the last decade due to intensive use of inputs. However, all criteria of agricultural sustainability of Khorasan province were declined over time as shown in Fig. 1. In spite of increased yield, productivity of the system was reduced because of high yield variability which in turn is related to low stability of the intensely managed systems (Rasul and Thapa, 2003). Decreased efficiency was again associated with large inputs of fertilisers and pesticides as was described also by Biswas et al. (2006). Compatibility of the production systems was reduced as a result of decreased biodiversity and increased pesticides use. As was reported by Koocheki et al. (2007) continuous monoculture cropping, lack of proper crop rotation and use of few high yielding crop varieties are the main causes of biodiversity loss in the studied agroecosystems.

An aggregated sustainability index (ASI) was calculated based on the criteria presented in Fig 1. The degree of agricultural sustainability was then categorized as strongly sustainable (ASI>0.75), weakly sustainable (ASI=0.50- 0.75), and not sustainable (ASI<0.50). According to this criterion, agricultural sustainability in Khorasan was weak until the mid-1990s with a tendency to decrease over time (Fig. 2). Sensitivity analysis by assignment of different weights to normalized scores of each sustainability criteria and re-calculation of ASI indicated that compatibility and efficiency are the key components of agricultural sustainability of the studied ecoregion.

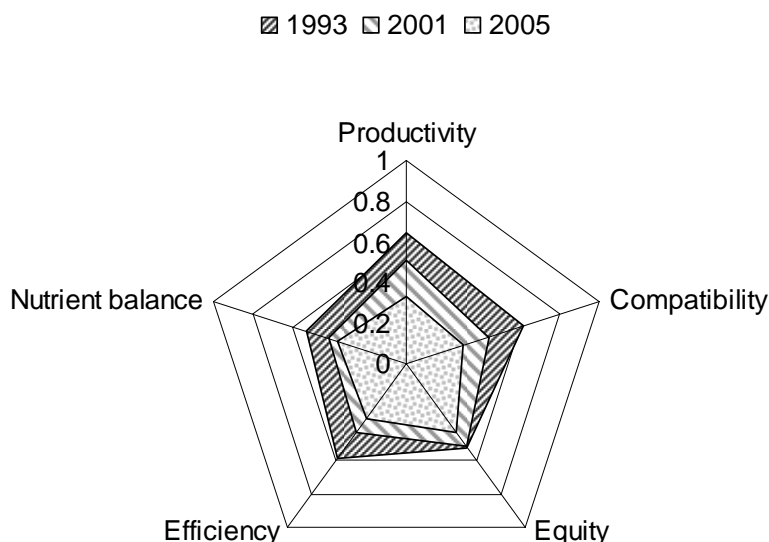

**Figure 1:** Temporal changes in normalized scores of five selected agricultural sustainability criteria in Khorasan province.

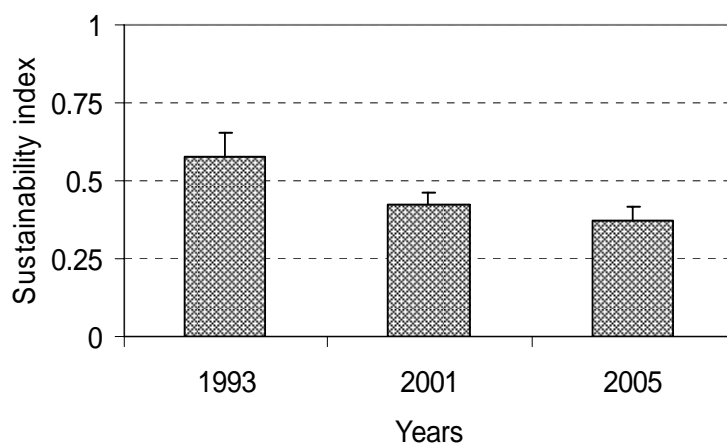

**Figure 2:** Temporal changes in agricultural sustainability index of Khorasan province, for each year SE is shown by vertical bars.

### Conclusions

The sustainability index developed in this study suggests that agricultural systems of Khorasan province are slightly sustainable with a tendency to deteriorate with time. Sensitivity analysis on different criteria showed that conversion of biodiversity as the main indicator of compatibility and optimized use of external inputs as the main determinant of agrorcosystem efficiency are the key elements for sustaining agriculture production in Khorasan province.

### References

- J. Hansen, and J. Jones, A systems framework for characterizing farm sustainability, 1996. *Agricultural Systems*, 51, 185-201.
- A. Koocheki et al., Agrobiodiversity of field crops: a case study of Iran, 2007. *J. Sustainable Agric.* (in press).
- A.G. Power, Linking ecological sustainability and world food needs, 1999. *Environment, Development and Sustainability* 1, 185–196.
- G. Rasul and G.B. Thapa, Sustainability analysis of ecological and conventional agricultural systems in Bangladesh, 2003. *World Development*, 31, 1721–1741.
- B. Biswas, et al., Integrated assessment of cropping systems in the Eastern Indo-Gangetic plain, 2006. *Field Crops Res.* 99, 35–47.

## DEVELOPING INDICATORS FOR EVALUATING OF AGROBIODIVERSITY AND ITS EFFECTS ON THE SUSTAINABILITY OF A WHEAT- COTTON CROPPING SYSTEM IN IRAN

A. Mahdavi Damghani<sup>1</sup>, A. Koocheki<sup>2</sup>, H. Liaghati<sup>3</sup>

<sup>1</sup> Department of Agroecology, Shahid Beheshti University, Iran, [mahdavi.a@sbu.ac.ir](mailto:mahdavi.a@sbu.ac.ir)

<sup>2</sup> Department of Agronomy, Ferdowsi University of Mashad, Iran, [az52@yahoo.com](mailto:az52@yahoo.com)

<sup>3</sup> Department of Environmental Economics, Shahid Beheshti University, Iran, [h-liaghati@sbu.ac.ir](mailto:h-liaghati@sbu.ac.ir)

Intensive and continuous changes in agriculture during last century have resulted in biodiversity losses in both natural and agricultural ecosystems. In natural ecosystems, wide application of agrochemicals in agroecosystems in form of fertilizers and pesticides has led to decrease in diversity of fauna and flora. In other hand, the biodiversity of agroecosystems has decreased because of rapid developing of intensive farming and monoculture. Therefore, improvement of agrobiodiversity (biodiversity in farming systems) by introducing crop species which have functions similar to off-farm inputs, reduces agroecosystem dependency and increases its self-sufficiency and sustainability.

The objective of present study is to evaluate the agrobiodiversity in a wheat-cotton cropping system in Khorassan, Northeastern Iran, and its effects on the ecological sustainability of the system.

### Methodology

The data of study gathered from three towns (Neyshabour, Bardaskan and Ferdows) in Khorassan province, northeast of Iran using 518 questionnaires. The questionnaires passed the validity test and were filled during interview with farmers in the wheat-cotton agroecosystems. Agrobiodiversity indicators used in the study are growing other crops than wheat and cotton, planting forage legumes, planting green manure, livestock presence in the farm and livestock diversity. In addition, other indicators classified in further seven groups (socio-economic, crop production, chemical fertilizer and pesticides, crop residue management, water and irrigation, tillage and machinery and weed management indicators) to develop a sustainability index. The weighting sum method (Andreoli and Tellarini, 2000) was used to calculate sustainability of the cropping system (Mahdavi Damghani et al., 2006). Each indicator had a score ranging from zero to a maximum value. The highest and lowest score were for the most favorable and the worst conditions, respectively. For example, for scoring indicator of crop species diversity, planting no other crop than wheat and cotton had zero, planting one crop had 1, two crops had 3 and planting more than two crops had 5 score. After quantifying system sustainability, the relationships between Agrobiodiversity and sustainability of the cropping system were determined.

### Results

78 percent of farmers grow other crops than wheat and cotton in which, 18 percent grow one, 31 percent grow two and 29 percent of them grow more than two other crops. There was a significant positive correlation between crop species diversity with sustainability (Table 1). 7.9 percent of farmers introduce forage legumes in their crop rotation program in which, in Bardaskan, only one percent of them grow forage legumes. Climatic condition can be accounted as the main limiting factor in applying forage legumes in these cropping systems, because forage legumes generally have high water demand and the Khorassan province is located in an arid environment.

Livestock are present in about half of the cropping systems (Fig. 1). The highest and lowest measures were respectively for Ferdows (67 percent) and Bardaskan (23 percent). Data on livestock diversity showed that in most farms, there is only one kind of livestock and only in one percent of them, there are more than two livestock species. Although near half of farms have livestock, but according to low livestock milk and meat production (data not shown), it seems that livestock are mainly treating for farmers' family consumption and it is not reasonable to include them as a part of production system. However, positive correlation of livestock presence and

diversity with sustainability index in this study indicates their role in sustainability of farming systems.

Table 1. Correlation coefficient of agrobiodiversity indicators with sustainability index of cropping system in the studied area.

	Agrobiodiversity indicators				
	FLG	GMA	CD	LPF	LD
Correlation coefficient	0.228**	0.062	0.323**	0.265**	0.259**
No of samples	518	518	518	514	514

FLG: forage legume growing, GMA: green manure application, CD: crop diversity, LPF: livestock presence in the farm and LD: livestock diversity.

\*\* : significant at  $p < 0.01$

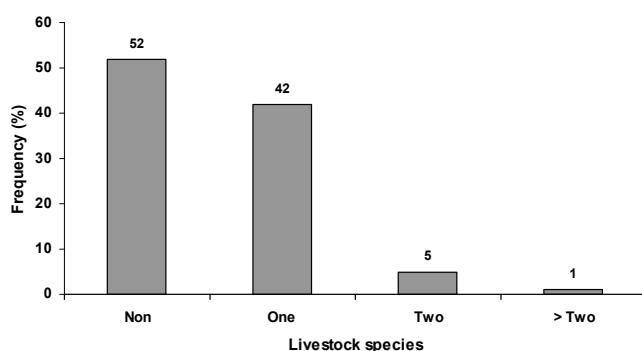

Figure 2. Livestock species diversity in wheat-cotton cropping system (*Non* means that there is not any livestock in the farm).

## Conclusions

Improving sustainability of wheat-cotton cropping systems through enhancing agrobiodiversity in Iran needs a multidimensional struggle by farmers, researchers and policy-makers. First, researchers should conduct experiments in order to determine suitable plant species and cultivars for introducing to these farming systems as forage legume or green manure. These crops should have a low water demand and high water use efficiency as well as tolerating environmental stresses like salinity and high temperature. They, meanwhile, should be economically competitive with crops like cotton, sugar beet and cereals which are cash crops of the studied area. Second, education and extension attempts should be done to make farmers familiar with several benefits of forage legumes and green manure and agronomic practices for their production. Finally, policy-makers should facilitate the atmosphere by supporting smallholder farmers in introducing new crops and animal husbandry through financial support, providing machinery and education as well as subsidy to pioneer farmers.

## References

- M. Andreoli and V. Tellarini. Farm sustainability evaluation: methodology and practice. 2000. Agric. Ecosys. Environ., 77: 43-52.
- R. Caballero. An experts' survey on the role of forage legumes in arable cropping systems of the Mediterranean area. 1993. Jour. Sust. Agric., 3: 133-154.
- C. Devendra and D. Thomas. Crop- animal systems in Asia: Importance of livestock and characterization of agro-ecological zones. 2002. Agric. Sys., 71: 5-15.
- A. Mahdavi Damghani et al., Studying the sustainability of a wheat-cotton agroecosystem in Iran. 2006. Asian J. Plant Sci., 5: 559-562.

## STUDYING THE SUSTAINABILITY OF A WHEAT- SUGAR BEET CROP ROTATION IN IRAN USING A SUSTAINABILITY INDEX

A. Mahdavi Damghani<sup>1</sup>, A. Koocheki<sup>2</sup>, M. Nassiri Mahallati<sup>3</sup>

<sup>1</sup> Department of Agroecology, Shahid Beheshti University, Iran, [mahdavi.a@sbu.ac.ir](mailto:mahdavi.a@sbu.ac.ir)

<sup>2</sup> Department of Agronomy, Ferdowsi University of Mashad, Iran, [az52@yahoo.com](mailto:az52@yahoo.com)

<sup>3</sup> Department of Agronomy, Ferdowsi University of Mashad, Iran, [nassiri20@yahoo.com](mailto:nassiri20@yahoo.com)

A Sustainability Index (SI) is a quantitative value that measures the sustainability of an agroecosystem. Each SI consists of several sustainability indicators which are biological, physical, chemical and socio- economic variables affecting the structure and function of the ecosystem. Sustainability indices reflect the viability of an agroecosystem quantitatively and are useful tools for evaluating the quality and effectiveness of the system as well as making proper decisions in its management. Previous studies on sustainability of agroecosystems in Iran (Hayati and Karami, 1996) indicate that these systems are not managing in a sustainable manner.

### Methodology

Eighty four indicators selected to develop a sustainability index. Indicators were classified into 10 groups as socioeconomic, crop production, livestock production, organic and chemical fertilizers and synthetic pesticides, crop residue management, water and irrigation, tillage and machinery, agrobiodiversity, weed management and finally, using wood and manure as fuel (Table 1). The weighting sum method (Andreoli and Tellarini, 2000) used to calculate the sustainability index. Each indicator had a score ranging from zero to a maximum value. The highest and lowest score were for the most favorable and the worst condition, respectively. The final value of 100 for the SI was the sum of all indicators' score. After calculating SI, the backward stepwise regression was done to select the most significant indicators in determining SI. In the procedure, SI selected as dependent and indicators as independent variables and then analyzed and the indicators that had not significant effect in SI estimation were eliminated. Finally, the model equation of determining SI and crop yield were extracted using multiple linear regressions.

Data of indicators gathered using 618 questionnaires in three counties in Khorassan province, Northeastern of Iran. Questionnaires passed the validity test and were filled during interview with farmers who grow wheat and sugar beet (either as a crop rotation or in different parts of a farm, simultaneously).

Table 1. Indicator groups used for developing the sustainability index and their weight (from total 100). The number in parenthesis is number of indicators in each group

Indicator groups	Weight
Socio-economic (24)	29.50
Crop production (4)	7.50
Livestock production (2)	3.00
Organic and mineral fertilizers and chemical pesticides (17)	14.50
Crop residue management (7)	5.75
Water and irrigation (8)	14.50
Tillage and mechanization (11)	15.75
Agrobiodiversity (6)	6.00
Weed management (3)	3.00
Using wood or manure as fuel (2)	9.50
Total	100

## Results

Results showed that 44.6% of farms gained the half or more of SI score and the mean SI score was 48.7 which indicate that these agroecosystems are not sustainable. Results of this study are in consistence with other reports in other regions of the country. Livestock production, crop production and crop diversity indicators had the lowest scores (9.3, 40.4 and 44.0 from 100, respectively). The backward stepwise regression analysis indicated that SI can be predicted from a linear combination of wheat and sugar beet yield, type of crop residue management, farmers' income from crop and livestock production and input availability as below:

$$SI = 27.7 + (0.0013A) + (0.000B) + (0.994C) + (1.01D) + (2.66E) - (1.25F) + (1.34G) + (1.63H) - (1.31I) + (0.02J) + (0.001K) + (0.008L) - (0.0001M) - (0.005N) + (2.81O) + (0.999P) + (0.627Q)$$

Which SI is sustainability index and parameters are A: wheat yield (kg/ha), B: sugar beet yield (kg/ha), C: crop diversity, D: insecticide type diversity in sugar beet, E: fungicide type diversity in wheat, F: fungicide dose application in wheat, G: returning wheat residue to soil, H: returning beet residue to soil, I: selling beet residue, J: income from wheat (USD per ha), K: income from sugar beet (USD per ha), L: income from livestock (USD per ha), M: other incomes (USD per ha), N: distance of farm to farmer's home, O: accessibility to production inputs, P: accessibility to loan and financial supports and Q: accessibility to extension service.

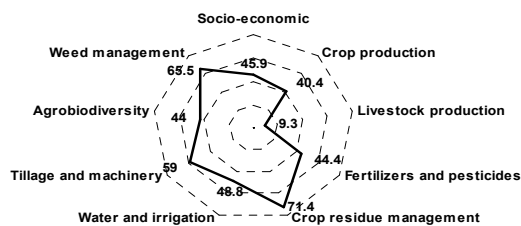

Figure 1. Final score of different indicator groups in the wheat- sugar beet crop rotation.

## Conclusion

Most farmers do not use sustainable approaches such as application of green manure, agrobiodiversity and integrated weed and pest management which can be attributed to their low level of education and access to extension services. Furthermore, more than 87% of farmers are illiterate or passed primary education and only less than 3% of them have academic education. Therefore, any improvement in farmers' education will increase system's sustainability. Farm size is one of most important limiting factors in these systems which prevent any proper application of machinery. Improper irrigation systems also have decreased water use efficiency as well as crop production. Increasing farm's economic viability through improvement in crop production management could improve overall sustainability of these agroecosystems substantially and this could be facilitated by governmental and non-governmental subsidies.

## References

- M. Andreoli and V. Tellarini. Farm sustainability evaluation: methodology and practice. 2000. *Agric. Ecosys. Environ.*, 77: 43-52.
- D. Hayati and A. Karami. Developing an index to evaluate the sustainability of agroecosystems for applying in socio-economic research. 1996. 1<sup>st</sup> conference on Iran Agricultural Economy, University of Sistan and Baluchestan, 634-649.
- A. Mahdavi Damghani et al., Studying the sustainability of a wheat-cotton agroecosystem in Iran. 2006. *Asian J. Plant Sci.*, 5: 559-562.
- J.P.G. Webster. Assessing the economic consequences of sustainability in agriculture. 1997. *Agric. Ecosyst. Environ.*, 64: 95-102.

## **AN INTEGRATED FARM SUSTAINABILITY MONITORING TOOL: METHODOLOGY AND APPLICATION ON FLEMISH DAIRY FARMS**

M.Meul

Flemish Institute for Agricultural and Fisheries Research, Belgium, [marijke.meul@ilvo.vlaanderen.be](mailto:marijke.meul@ilvo.vlaanderen.be)

### **Introduction**

Indicators are logical devices to be used in sustainability monitoring. For agriculture, indicator-based farm monitoring systems already exist and are applied in practice. An overview of those monitoring instruments learns that many of them focus on a rather restricted number of sustainability aspects, in general economic and/or ecological (von Wirén-Lehr, 2001). Furthermore, only few authors explain how and why the considered sustainability aspects and indicators were selected (van der Werf & Petit, 2002). The aim of our study was therefore to develop an indicator-based monitoring system for integrated farm sustainability – considering economic, ecological as well as social aspects – that is based on a supported vision on sustainable agriculture. Since we aspire that the monitoring system will actually be used in practice as a management guiding tool, we paid specific attention to aspects of communication and user-friendliness. In this paper, we describe the applied methodology for developing this monitoring system.

### **Methodology**

The methodology consists of four successive steps:

1. *Translating the major principles of a supported vision on sustainable Flemish agriculture into concrete and relevant themes for individual farms*

Sustainable development processes should be based on a well conceived vision, with concrete and inspiring images of an envisioned future. Nevens et al. (2007) describe a process of vision development on a sustainable (future of) agriculture in Flanders. This process was based on a transdisciplinary dialogue between the multiple stakeholders of Flemish agriculture. We considered the resulting vision as a publicly supported guideline for all actors (including farmers, agricultural industry, consumers and government). It integrates major principles for the ecological, the economic and the social sustainability dimension of agricultural systems. In mutual agreement with stakeholders, we translated those major principles into concrete themes, to make 'sustainability' more tangible at a practical level, to be able to take directed actions and to design relevant indicators.

2. *Designing indicators to monitor progress towards sustainability for each of those themes*

Extended literature is available on the development and use of indicators to measure farm sustainability. Whenever such existing indicators complied with our supported vision, the derived themes and imposed quality criteria (related to their causality, sensitivity, solidness, use of benchmarks and comprehensibility), we integrated them in our monitoring system. When little or no scientific information was available - which was particularly the case for the social themes - we consulted stakeholders (including experts) for selecting or designing relevant indicators, again taking into account the pre-defined quality criteria. For some social aspects of sustainable farming, neither scientific information, nor expert knowledge was available. In these cases, we performed new fundamental research. Before accepting and implementing the indicators into the monitoring system, they were validated by presenting them to a feedback group of experts and stakeholders. This group discussed the indicators' relevance and underlying methodological choices such as indicator design, data use, choice of benchmarks and indicator weights. That way, we also created a support base for the indicators and the monitoring system, since as many stakeholders as possible were involved in their development.

3. *Aggregating the indicators into an integrated farm sustainability monitoring system*

We aggregated the indicators in a graphic system, where all relevant themes are presented individually, instead of combined into a single aggregated index. We further focused on a user friendly and communicative design of the system by (1) providing the ability to add the average indicator scores of a group of comparable farms. This option is particularly useful for farmers who wish to communicate on their farm sustainability in a discussion group; (2) visualising the indicator weights. That way, a farmer can readily distinguish which indicators are considered more or less important when evaluating the sustainability of a specific theme; (3) using a multi-level monitoring system. Level 1 gives an overview of the farm's overall sustainability. Level 2 gives an overview of



the sustainability themes within a specific sustainability dimension (economic, ecological or social). In level 3, the indicator scores for a specific theme are visualised. That way, starting from an overall view of his farm's sustainability, a farmer can zoom in on the underlying themes and indicators into as much detail as desired.

#### 4. *Applying the monitoring system on a practical farm, as a first end-use validation*

We applied the methodology to the dairy sector as an example and we used the monitoring instrument on a specific dairy farm as a case study as a first end-use validation of the system.

## Results

We translated the major principles of sustainable agricultural systems into 10 relevant themes. In total, 60 indicators were developed to monitor progress towards sustainability for each of the themes. The indicator values were translated into scores between 0 and 100, which we aggregated in an adapted radar graph (Figure 1). Within a specific theme, we considered all indicators as equally important and hence the theme's score was calculated as the average of the related indicator scores, except when – based on expert opinions or on literature reviews – there was considerable proof that certain indicators are in fact more important than others when used to evaluate the sustainability of the specific theme. This was specifically the case for the indicators designed to evaluate a farm's (economic) 'productivity' and for 'soil quality'

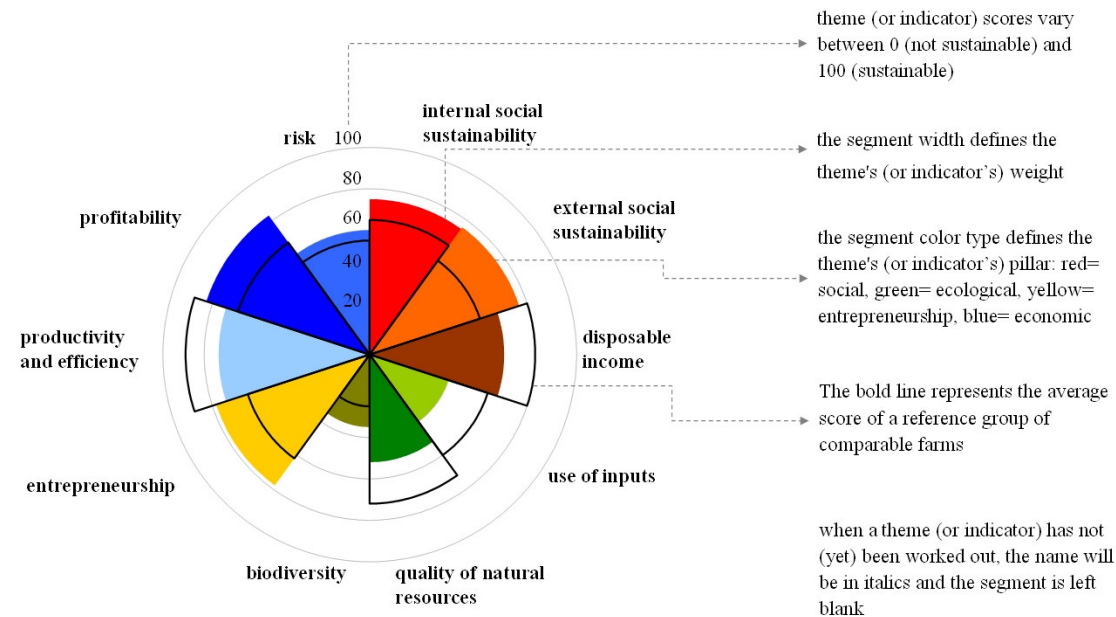

Figure 1. The integrated indicator-based sustainability monitoring instrument at level 1, presented with a legend concerning the reading and interpretation.

## Conclusions

In this study, we developed a user-friendly and strongly communicative instrument to measure progress towards integrated (economic, as well as ecological and social) sustainable dairy farming systems. The sustainability monitor fits within a well founded methodological framework and is based on a set of relevant indicators. In our opinion, the end-use validation of the system is of critical importance to its optimization and continuous improvement. For that reason we encourage its application on as many practical Flemish farms as possible.

## References

- F. Nevens et al., On tomorrow's grounds; development of a vision on Flemish agriculture in 2030, 2007. *Journal of Cleaner Production*, *in press*.
- H.M.G. van der Werf & J. Petit, Evaluation of the environmental impact of agriculture at the farm level: a comparison and analysis of 12 indicator-based methods, 2002. *Agric. Ecosyst. Environ.* 93, 131-145.
- S. von Wirén-Lehr, Sustainability in agriculture – an evaluation of principal goal-oriented concepts to close the gap between theory and practice, 2001. *Agric. Ecosyst. Environ.* 84, 115-129.

## REDUCING THE COMPLEXITY OF ENVIRONMENTAL INDICATORS FOR IMPROVED COMMUNICATION AND MANAGEMENT

T. Nemecek, G. Gaillard, Agroscope Reckenholz-Tänikon Research Station ART, CH-8046 Zurich, Switzerland, [thomas.nemecek@art.admin.ch](mailto:thomas.nemecek@art.admin.ch), [gerard.gaillard@art.admin.ch](mailto:gerard.gaillard@art.admin.ch)

### Introduction

Life cycle assessment (LCA) is known to offer a sound basis for sustainability assessment of farming systems. LCA enables the assessment of the environmental impacts related to a product or process, by considering the whole life cycle. In this way it is possible to avoid shifts of environmental burdens along the life cycle. Furthermore, LCA strives to include all relevant environmental impacts, in order to avoid displacement of environmental burdens. Two different approaches are used in agricultural LCAs to analyse the impacts on the environment: the mid-point approach, working with typically 10-15 impact categories like energy demand, global warming potential and eutrophication and the end-point approach, aggregating all environmental impacts into a single score. The first approach often yields contradictory results for different impact categories making decisions difficult, while the second one is highly subjective, which hampers the acceptance of the results. This paper presents an alternative approach based on the grouping principle: starting from a large number of mid-point indicators, the complexity of the results is reduced by means of multivariate techniques.

### Methodology

The life cycle assessments were carried out with the SALCA-methodology (Swiss Agricultural Life Cycle Assessment) of Agroscope Reckenholz-Tänikon (see Nemecek *et al.*, 2005) by using the ecoinvent database. Multivariate techniques such as non-parametric correlation analysis (Nemecek *et al.*, 2005), factor analysis (Rossier and Gaillard, 2001) or principal component analysis (Mouron *et al.*, 2006) were used to reveal close relationships between the different life cycle impact categories.

### Results

The impact categories could be classified into three groups (Fig. 1): The *resource management* encompasses the energy demand, the global warming potential and the ozone formation. The *nutrient management* is represented by the eutrophication and the acidification. The aquatic and terrestrial ecotoxicity as well as the human toxicity can be summarised by the *pollutant management*. The impact categories *biodiversity* and *soil quality* are influenced by all three abovementioned management axes and must therefore be dealt with separately. These five environmental areas cover the whole analysis, enabling a simplified communication to decision makers. The management axes are related to different management actions with different time horizons (from long-term to short-term decisions) like use of machinery, application of fertilisers and pesticides.

Fig. 2 shows a practical application of the concept. Rossier and Gaillard (2001) analysed 35 milk production farms in respect of their environmental performance. It reveals that farm no. 10 has low environmental impacts for all three management axes, while the environmental performance of farm no. 18 is poor in all respects. We see also farms that have a problem in one dimension (e.g. no. 15 and 27) or two dimensions (e.g. no. 4 and 9). This representation allows a quick assessment of the environmental impacts of each individual farm and the derivation of improvement measures. The shown example makes also clear that there is not necessarily an environmental trade-off between the groups of impact categories: it is possible to have good results in all three dimensions.

### Conclusions

Multivariate statistical methods allow reducing the information contained in the environmental profile as determined by LCA. In most farming systems analysed up to date, it is possible to summarise the impacts into three dimensions, namely resource management, nutrient management and pollutant management. All three axes can be related to management options, so that recommendations to farmers can be given.

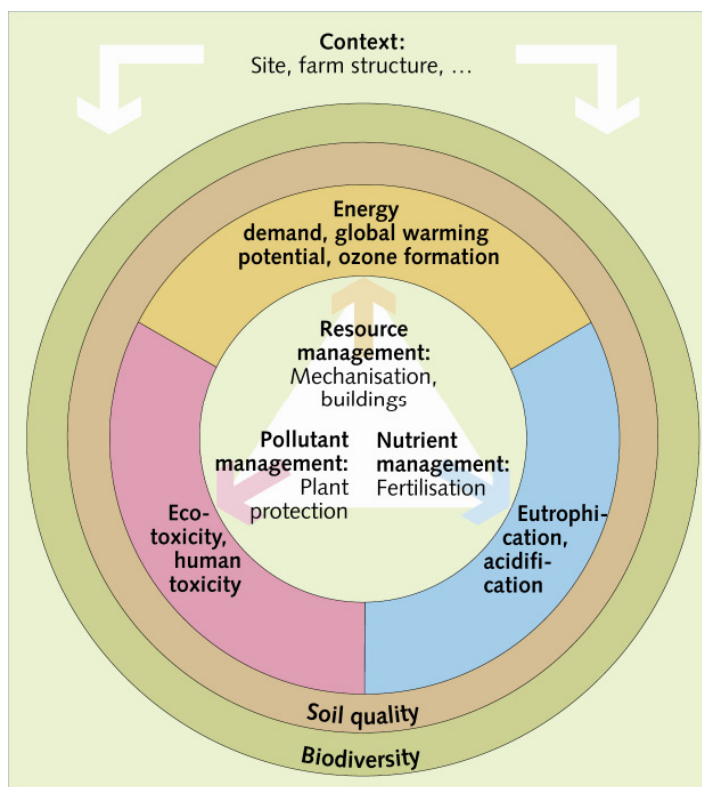

Fig. 1: Management triangle of farming systems (from Nemecek *et al.*, 2005).

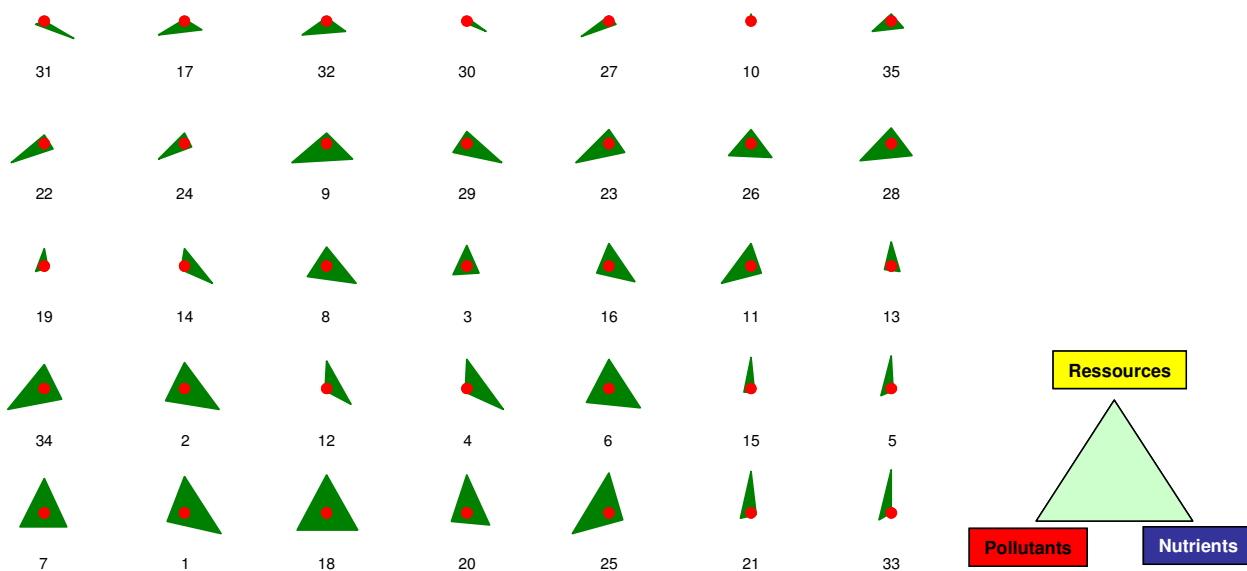

Fig. 2: Example of environmental impacts for 35 milk producers, impacts per kg milk. The triangles represent the three impact groups resource, nutrient and pollutant management. A small area is favourable for the environment (from Rossier and Gaillard, 2001).

### References

- Mouron P. *et al.*, Management influence on environmental impacts in an apple production system on Swiss fruit farms: Combining life cycle assessment with statistical risk assessment, 2006. *Agriculture, Ecosystems and Environment* 114, 311-322
- Nemecek T. *et al.*, *Ökobilanzierung von Anbausystemen im schweizerischen Acker- und Futterbau*, 2005. Agroscope FAL Reckenholz, Zürich; Schriftenreihe der FAL 58, 155 p.
- Rossier D., Gaillard G., *Bilan écologique de l'exploitation agricole: Méthode et application à 50 entreprises*, 2001. Report SRVA, FAL, 105 p.

## AN INDICATOR-BASED FRAMEWORK TO EVALUATE ECOLOGICAL SUSTAINABILITY AT THE FARMING SYSTEM LEVEL

Pacini C.<sup>1\*</sup>, Lazzerini G.<sup>1</sup>, Migliorini P.<sup>1</sup>

<sup>1</sup> Dep. of Agronomy and Land Management, Florence University, Italy, [gaiocesare.pacini@unifi.it](mailto:gaiocesare.pacini@unifi.it), [giulio.lazzerini@unifi.it](mailto:giulio.lazzerini@unifi.it), [paola.migliorini@unifi.it](mailto:paola.migliorini@unifi.it)

Agricultural researchers widely recognise the importance of sustainable agricultural production systems and the need to develop appropriate methods to measure sustainability at the farm level. Policymakers need accounting and evaluation tools to be able to assess the potential of sustainable production practices and to provide appropriate agro-environmental policy measures. Farmers are in search of sustainable management tools to cope with regulations and enhance efficiency. This paper proposes an indicator-based framework to evaluate sustainability of farming systems. Indicators can be strongly ecological in focus and very detailed, or they are policy oriented. So, indicators are developed that differ greatly in information

content and condensation of this information (Figure 1).

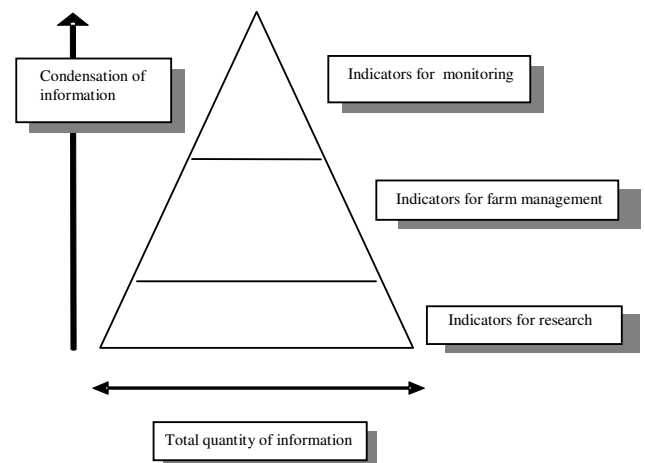

Figure 1. Relationship between indicators (Braat, 1991)

### Methodology

Main features of the indicators' framework are the relevance given to different spatial scales (farm, site and field), production and pedo-climatic factors, and a holistic view of the agro-ecosystem. The framework has been conceived to tackle different purposes ranging from detailed scientific analyses to farm-level management systems and policy monitoring. Besides, the framework has been designed and tested to be coherent with the environmental accounting model DPSIR (Driving forces-Pressure-State-Impact Response), as well as with the current European financial accounting model FADN (Farm Accountancy Data Network).

The framework has been developed from previous experiences dating since 1991 (Vazzana e Raso, 1997; Vereijken, 1999), aiming at finding a balance between a range of information systems with different levels of detail, and corresponding calculation methods of indicators. Agro-environmental indicators can be calculated, simulated with models or directly measured with different levels of detail proportionally to the aims of the evaluation exercise. The framework is organised in a number of environmental systems (e.g., water, soil, etc.) and modules (e.g., water quality, water balance, drainage system, etc.). For each system environmental critical points (e.g., flood risk, soil erosion, biocide pollution, etc.) are identified with corresponding agro-environmental indicators and processing methods.

### Review of applications

Applications range from prototyping farming systems, to integrated economic-environmental accounting systems, policy planning, comparisons between organic, integrated and conventional farming systems, farm eco-management voluntary audit schemes and cross-compliance. Case-study farms include small, medium and large enterprises, and range from arable to mixed cattle-arable, vineyard, olive, vegetable, fruit and ornamental plant nursery production. A review of selected applications of the indicators of the framework in Tuscany, Italy, is presented in the table.

Table 1. Review of selected applications of the indicators of the framework in Tuscany, Italy

Indicator	Spatial reference	Factors included	Procedure	Application
Water balance	Fi	P&P	GLEAMS	R, C, Pp <sup>1,2</sup>
Soil erosion	Fi	P&P	GLEAMS,	R, C, Pp <sup>1,2,3</sup>
Herbaceous and arboreal species diversity and richness	Fi	P&P	Modified Braun-Blanquet method, Raunkiaer method, transect method	R, C, Pp, EMS <sup>1,2,3,4,5,6,7</sup>
Insect diversity and richness	Fi	P&P	Pit-fall traps	R, C, Pp <sup>9,10</sup>
Hedge biodiversity	Fi	P&P	In-field observations	R, C, Pp, EMS <sup>2,3</sup>
Nutrient losses	Fi	P&P	GLEAMS	R, C, Pp <sup>1,2,3</sup>
Environmental potential risks of pesticide use	Fi	P&P	EPRIP yardstick	R, C, Pp, EMS <sup>1,2,3,5,7</sup>
Non-renewable energy use	Fi	Pr	Farm records	R, C <sup>5</sup>
Drainage system length	Fi	P&P	In-field observations	R, C, Pp, EMS <sup>2,6,7</sup>
Soil organic matter content	S	Pe	Chemical analyses	R, C, Pp <sup>5,7</sup>
Crop diversity	S	Pr	Modified Shannon index	R, C, EMS <sup>1,4,5,7</sup>
Potential risk of soil erosion	S	Pr	Farm records, In-field observations	C, EMS <sup>5,7</sup>
Semi-natural habitat areas	Fa	P&P	Farm records, In-field observations	C, EMS <sup>7</sup>
Nutrient surplus/balance	Fa	Pr	Farm records	C, EMS <sup>5,7</sup>
Water use	Fa	Pr	Farm records	C, EMS <sup>7</sup>
Organic matter balance	Fa	Pr	Farm records	C, EMS <sup>5,7</sup>

Legend: Fi, field; S, site; Fa, farm; P&P, production and pedo-climatic factors; Pr, production factor; Pe, pedo-climatic factor; R, research in the fields of prototyping farming systems and integrated economic-environmental accounting systems; C, comparisons between organic, integrated and conventional farming systems; Pp, policy planning; EMS, farm environmental management systems; <sup>1</sup>Pacini et al. (2004b); <sup>2</sup>Pacini et al. (2004a); <sup>3</sup>Pacini et al. (2003); <sup>4</sup>Migliorini (2007); <sup>5</sup>Migliorini (2006); <sup>6</sup>Lazzerini et al (2007); <sup>7</sup>Lazzerini et al, 2006

## Conclusions

Different versions of the framework were applied with case-specific sets of indicators and calculation procedures to a large range of hierarchical spatial levels, production systems and methods, farm sizes, basic and applied research purposes. The framework proved to be flexible and effective in grounding the sustainability concept in the reality of farming systems. Few attempts to extend the framework to socio-economic indicators have been carried out. Further research concerns an expansion of this activity.

## References

- G. Lazzerini and C. Vazzana, The role of field margins in agro-biodiversity management at the farm level, 2007, Italian Journal of Agronomy (in press).
- G. Lazzerini et al, Rapporto finale Bando di Ricerca ARSIA "Sistemi Informativi e Comunicazione per le Politiche Agroambientali", 2004-2006 (in Italian).
- P. Migliorini and C. Vazzana, Biodiversity Indicators for sustainability evaluation of conventional and organic agro-ecosystems. Italian Journal of Agronomy (in press).
- P. Migliorini and C. Vazzana, Evaluation of sustainability: results from a long term experimental arable systems in Tuscany. "What will organic farming deliver?" Colloquium of Organic Researchers (COR2006) Edinburgh Conference Centre, Heriot-Watt University, Edinburgh on 18-20 September 2006.
- C. Pacini et al., Evaluation of sustainability of organic, integrated and conventional farming systems: a farm and field-scale analysis, 2003. Agric., Ecosyst. Environ. 95, 273-288.
- C. Pacini et al., Ecological-economic modelling to support multi-objective policy making: a farming systems approach implemented for Tuscany, 2004a. Agric., Ecosyst. Environ. 102, 349-364.
- C. Pacini et al., The EU's Agenda 2000 reform and the sustainability of organic farming in Tuscany: ecological-economic modelling at field and farm level, 2004b. Agric. Syst. 80, 171-197.
- C. Vazzana, E., Raso, Una metodologia europea per la progettazione e realizzazione di un agroecosistema a basso o nullo impatto ambientale, 1997. Bollettino della Società Italiana di Ecologia XVII, 51-54 (in Italian).
- P. Vereijken, Manual for prototyping integrated and ecological arable farming systems (I/EAFS) in interaction with pilot farms, 1999. AB-DLO, Wageningen (NL).

## ENERGETIC ANALYSIS OF THREE CROPPING SYSTEMS

F. Alluvione, D. Sacco, C. Grignani

Dep. AgrSelviTer, Univ. of Turin, Italy, [dario.sacco@unito.it](mailto:dario.sacco@unito.it)

### Introduction

The recent forecast about the reduction of availability of fossil fuels and the environmental impact of non renewable energy resources drive more attention to the energetic balances of the agricultural activities. In the present work, energetic analysis of three cropping systems were determined in a 8-year field experiment in the Po valley (Northern Italy). The energy efficiency of the cropping systems was assessed.

### Methodology

The three cropping systems were based on a wheat, maize, soybean, maize crop rotation. The first cropping system was a low input system (LI), characterised by minimum tillage, cover crops and low levels of fertilizers; the second (PSR) was based on the Piedmont Region law application of the 99/1257/EC Directive; the third followed the typical management of the area (CONV).

Energetic analysis at the “farm gate” level was calculated according to the “Process Analysis” method: non renewable energetic inputs were compared with total outputs on a year basis. Crop management was converted in inputs considering the direct and indirect non renewable energy of mechanical operations (machinery, fuels and lubricants), fertilizers, irrigation, pesticides and seeds. Solar energy, human labour, the energetic consumption for buildings construction and products conservation and transformation were not accounted. Energy equivalents were taken from literature (Pimentel, 1980; Fluck, 1992; Bonari et al., 1992); total energy of farm equipments was re-distributed with reference to a standard lifetime.

Total average biomass production (products and residues) and changes in soil organic matter were converted in energy output using their calorific value (Jarrige, 1978 and 1988).

Energy efficiency was evaluated mainly through two indexes. The “Human Inputs Global Efficiency” (HIGE, ratio between total energy outputs and total inputs), to evaluate the efficiency of the system in using the energy from the human inputs, and the “Environmental Global Efficiency” (EGE, ratio between total production energy and the difference between total inputs and the soil organic matter content -SOM- modification) to evaluate the efficiency of the system also considering the SOM as energy stored in the environment (any decrease is an input to the cropping system).

### Results

CONV (total input: 24.2 GJ\*ha\*y<sup>-1</sup>) was the most intensive system followed by LI (19.4 GJ\*ha\*y<sup>-1</sup>) and PSR (18.8 GJ\*ha\*y<sup>-1</sup>). LI input level was similar to the PSR input despite plowing was not performed. The cover-crops in the LI system sharply increased energy input. Soybean (11.7 GJ\*ha\*y<sup>-1</sup>) and wheat (15.5 GJ\*ha\*y<sup>-1</sup>) required less energy than tomato (21.6 GJ\*ha\*y<sup>-1</sup>) and maize (26.9 GJ\*ha\*y<sup>-1</sup>). Fertilizers resulted to be the most important energetic input (at least 40% of total inputs), followed by mechanical operations (highest in the LI) and irrigation. Pesticides and material for crops propagation represented together less than 10% of total input.

LI produced 383 GJ\*ha\*y<sup>-1</sup> of total output (due to the cover-crop biomass), CONV 378 GJ\*ha\*y<sup>-1</sup> and PSR 343 GJ\*ha\*y<sup>-1</sup>. Maize photosynthetic efficiency resulted in the greater energy production (446 GJ\*ha\*y<sup>-1</sup>), followed by wheat (266 GJ\*ha\*y<sup>-1</sup>) and soybean (220 GJ\*ha\*y<sup>-1</sup>). The energy ratio between harvestable products and crop residues seemed to increase with the decrease of total input: when input is lower crops invest a greater fraction of the available energy in the harvestable products (figure 2). Nevertheless crop residues always gave a big contribution to soil fertility. They always represented more than the 50% of total energy output and their NPK content is at least 60% of the fertilizers energy supplied.

HIGE index was greater for low input systems (19.7 for LI and 18.3 for PSR) than for CONV (15.6). The most efficient crops were soybean (HIGE=18.8) and maize (HIGE=17.4), due to the nitrogen fixation and the C4 cycle respectively. Increasing inputs decreased differences between crops,

leading to a standard efficiency system in which the high energy inputs cover biological differences.

EGE index showed a sharp difference between LI (79.8) and the other systems PSR (2.8) and CONV (2.0). The ability of LI to store energy in the environment by SOM accumulation was remarkable.

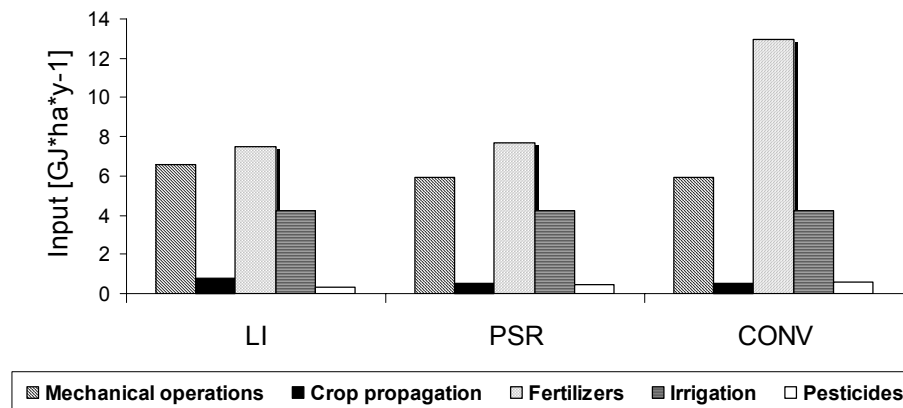

Figure 1 – Average annual inputs of the different cropping systems.

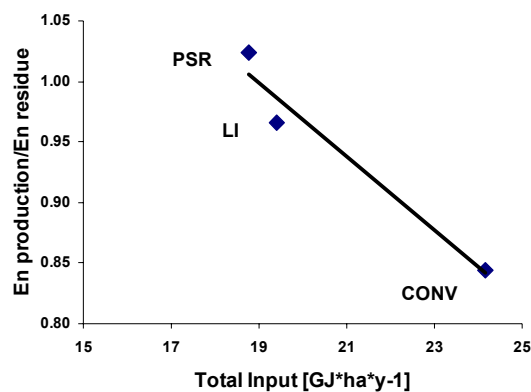

Figure 2 – Relation between energy ratio of products and residues and total input to the cropping system. Cover crops are included in total input only as agricultural practices.

## Conclusions

The energetic analysis resulted to be a good tool to evaluate the ability of crops and cropping systems in optimizing non renewable resources used by farmers.

Energy efficiency decreases with increasing inputs, both for the system and for the crops.

Physiology influences crops energy efficiency, even though high inputs levels depress differences.

Fertilizers, mechanical operations and irrigation are confirmed to be the most important inputs.

Total input reduction can be performed more easily trough a reduction in fertilizers than trough a reduction in mechanical operations.

Cover-crops negatively influences the HIGE of cropping systems: their presence in the rotation must be carefully evaluated on the base of the effect on SOM and leaching.

EGE resulted to be the best index for the evaluation of the global (human and environmental) effect of a cropping system.

## References

- E. Bonari et al., Valutazioni energetiche di sistemi produttivi a diverso livello di intensificazione colturale, 1992. L'Informatore Agrario, 48, Suppl., 11-25
- R.C.Fluck, Energy in farm production, 1992. Elsevier Editions
- R.Jarrige, Alimentation des ruminantes, 1978. Ed. INRA Publications
- R.Jarrige, Alimentation des bovins, ovins & caprins, 1988. Ed. INRA Publications
- D.Pimentel, Handbook of energy use in agriculture, 1980. CRC Press, Boca Raton, Fl.

## AN INDICATOR-BASED MCDA FRAMEWORK FOR *EX ANTE* ASSESSMENT OF THE SUSTAINABILITY OF CROPPING SYSTEMS

W. Sadok<sup>1</sup>, F. Angevin<sup>2</sup>, J.-E. Bergez<sup>3</sup>, C. Bockstaller<sup>4</sup>, B. Colomb<sup>3</sup>, L. Guichard<sup>1</sup>, R. Reau<sup>1</sup>, N. Landé<sup>5</sup>, X. Coquil<sup>6</sup>, A. Messéan<sup>2</sup>, M. Bohanec<sup>7</sup>, T. Doré<sup>1</sup>

<sup>1</sup>INRA, UMR211 INRA/AgroParisTech, F-78850 Thiverval-Grignon, France, [Walid.Sadok@grignon.inra.fr](mailto:Walid.Sadok@grignon.inra.fr), [guichard@grignon.inra.fr](mailto:guichard@grignon.inra.fr), [Raymond.Reau@grignon.inra.fr](mailto:Raymond.Reau@grignon.inra.fr), [thierry.dore@agroparistech.fr](mailto:thierry.dore@agroparistech.fr)

<sup>2</sup>INRA, UAR 1240 Eco-Innov, F-78850 Thiverval-Grignon, France, [Frederique.Angevin@jouy.inra.fr](mailto:Frederique.Angevin@jouy.inra.fr), [messean@grignon.inra.fr](mailto:messean@grignon.inra.fr)

<sup>3</sup>INRA, UMR1248 AGIR INRA/ENSAT, Auzeville, F-31326 Castanet Tolosan, France, [Jacques-Eric.Bergez@toulouse.inra.fr](mailto:Jacques-Eric.Bergez@toulouse.inra.fr), [Bruno.Colomb@toulouse.inra.fr](mailto:Bruno.Colomb@toulouse.inra.fr)

<sup>4</sup>INRA, UMR INPL-(ENSAIA)-INRA Nancy-Colmar, F-68021 Colmar, France, [bockstal@colmar.inra.fr](mailto:bockstal@colmar.inra.fr)

<sup>5</sup>CETIOM, Estrees-Mons, F-80203 Peronne, France, [lande@cetiom.fr](mailto:lande@cetiom.fr)

<sup>6</sup>INRA, UR55 SAD – Station de Mirecourt, F-88501 Mirecourt, France, [coquil@mirecourt.inra.fr](mailto:coquil@mirecourt.inra.fr)

<sup>7</sup>JSI, Dep. of Knowledge Technologies, Jamova 39, SI-1000 Ljubljana, Slovenia, [marko.bohanec@ijs.si](mailto:marko.bohanec@ijs.si)

### Introduction

Sustainability assessment of agricultural systems can be considered as a typical decisional problem which could be handled *via* multi-criteria decision-aiding (MCDA) methodologies. However, though some MCDA-based frameworks have allowed the implementation of sustainable forms of agriculture, four main developments for innovative sustainability assessment are increasingly requested. Firstly, there is a need for faster *ex ante* assessment approaches for rapidly identifying alternative systems without assessing the entire systems in the field. Secondly it is needed to use MCDA approaches able to handle situations where sustainability objectives cannot be translated realistically into quantitative indicator-based information, either because of the holistic nature of some sustainability criteria (Munda et al. 1994) or the impossibility of their quantitative measurement *ex ante*. Thirdly, it is increasingly requested to use alternative MCDA approaches, especially those based on decision rules as they are able to take into account preferential information realistically from a wide range of decision-makers through qualitative reasoning (Dent *et al.* 1995). Fourthly, it is needed to target scales currently insufficiently dealt with, such as the cropping system level, and to process assessments for a large variety of systems and contexts. Our work aims at achieving these developments with help of a qualitative decision rule-based MCDA framework. In this paper, we summarize the whole approach, focusing on the sub-unit of the MCDA model addressing the environmental dimension.

### Methodology: Overall approach

The core of the framework consists of a hierarchical multi-attribute MCDA model developed within a decision support tool called DEXi (Bohanec, 2007) and is based on two main steps. Firstly, the hierarchical MCDA model structure is designed based on expertise. The model decomposes the sustainability assessment decision problem into three sub-problems representing economic, social and environmental dimensions of sustainability (Fig. 1). Each of these sub-problems is represented by a sub-model in which all variables (or attributes) are qualitative (i.e., a value from a predefined qualitative scale). These attributes are organized according to a hierarchy which decomposes the considered sub-problem into less complex units, down to the level of input attributes representing the sustainability criteria of cropping systems. The latter are of two types: (i) environmental sustainability indicators stemming from the INDIGO method (Bockstaller *et al.* 1997) and (ii) other environmental and socioeconomic expertise-based sustainability criteria. For each of the three sub-models, the value of a given input attribute is calculated on the basis of the crop rotation timescale and transformed into a qualitative appreciation, which is chosen from a pre-defined four-value qualitative scale. Secondly, for each level of aggregation, a utility function ( $UF_x$ , Fig. 1) is established in order to determine the dependency level between the considered attribute and its immediate hierarchical descendants. Each utility function consists of an aggregation rule (i.e., weightings) based on transparent and qualitative *if-then* decision rules established by the user (example on Fig. 1). The evaluation of the sustainability of cropping systems is then performed by an overall aggregation that is carried out from bottom to the top of hierarchy according to its structure, the defined utility functions and the qualitative values assigned to the input attributes.



## Results: Environmental sustainability model

This model is composed of three sub-models evaluating the impact of the considered cropping systems on the local (i) Biotic resources, (ii) Pollution risks and (iii) Abiotic resources (Fig. 1). The input data of the three sub-models consists of 8 indicator-based attributes and 4 expertise-based ones which are aggregated along the hierarchy through 6 utility functions. The assignment of the qualitative values to the input attributes (see example of  $I_{Energy}$  in Fig. 1) and the subsequent aggregation rules are made on the basis of (i) local/ regional conditions and norms and (ii) the specific views of the decision-maker(s). However, thresholds values of aggregation rules are predefined by expertise and suggested for each utility function, in order to prevent the decision-maker(s) from using extreme weightings.

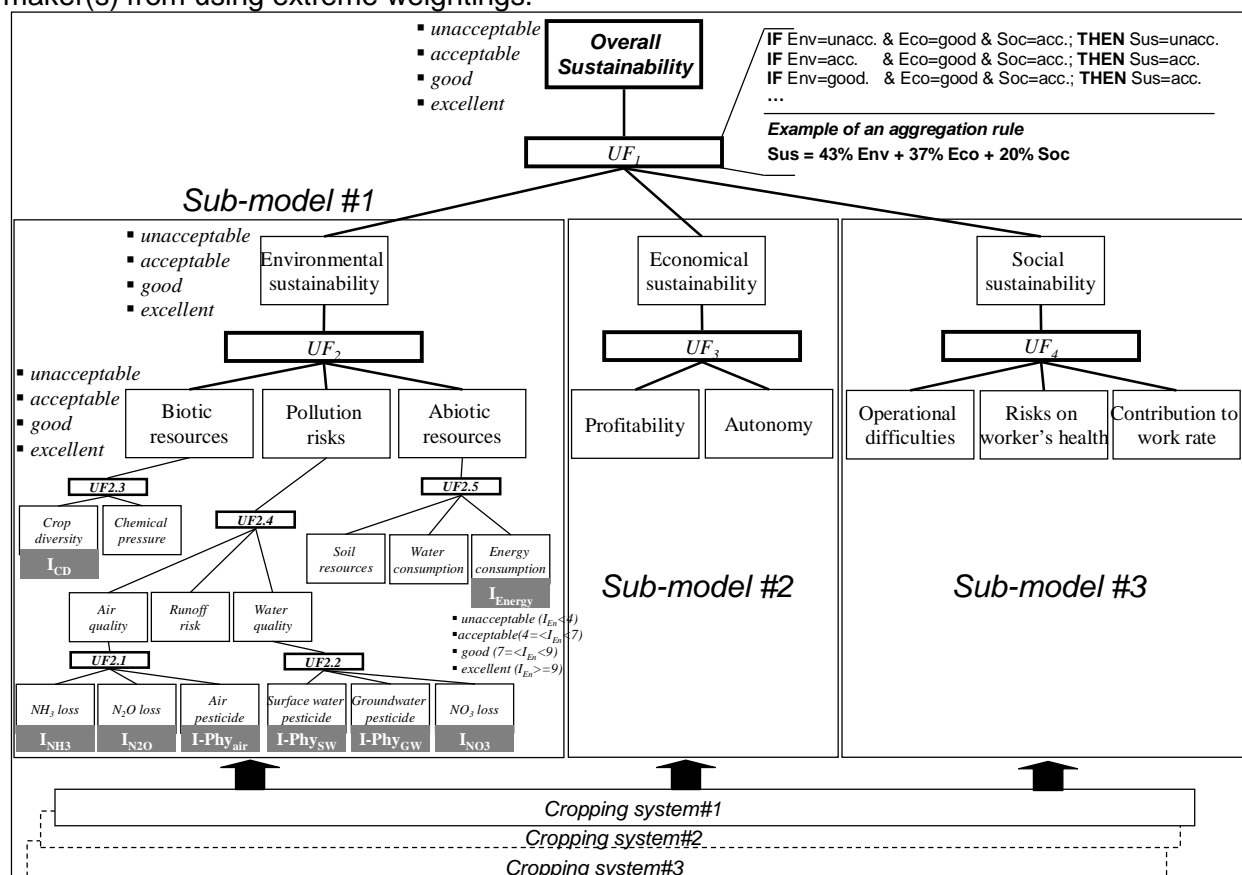

**Figure 1. Structure of the environmental sub-model of the hierarchical model developed for ex ante assessment of the sustainability of cropping systems.** Grey boxes represent sustainability indicators stemming from the INDIGO method which are used as input attributes aiming at estimating: Crop diversity;  $NH_3$ ,  $N_2O$  and  $NO_3$  losses; Air, Surface and Ground water pesticide levels and Energy consumption. An example of an aggregating rule resulting from *if-then* decision rules is illustrated on the right top of the figure.

## Prospects

Sensitivity analysis and submission of the overall MCDA model to a panel of decision-makers are the two next main steps necessary to adjust the framework and to make it operational for a wide range of cropping systems and contexts.

## Acknowledgments

This study was funded by the ANR (*Agence Nationale de la Recherche*) under the Federator Program ADD (*Agriculture et Développement Durable*) via the INRA Project DISCOTECH.

## References

- C. Bockstaller et al., 1997. Eur. J. Agron. 7, 261–270
- M. Bohanec, DEXi: A Program for Multi-Attribute Decision Making, 2007. <http://www-ai.ijs.si/MarkoBohanec/dexi.html>
- J.B. Dent et al., 1995. Agric. Syst. 49, 337–351
- G. Munda et al., 1994. Ecol. Econ. 10, 97–112

## ANALYSIS OF BIRD POPULATION TO ASSESS THE BIODIVERSITY IN AGRICULTURAL AREAS IN NORTH EAST ITALY

M. Salvato<sup>1</sup>, D. Tocchetto<sup>2</sup>, M. Borin<sup>3</sup>

<sup>1</sup> Dep. of Environ. Agronomy and Crop Production, University of Padova, Italy, [michela.salvato@unipd.it](mailto:michela.salvato@unipd.it);

<sup>2</sup> P.A.N. srl, Padova, Italy, [sviluppo@panspinoff.com](mailto:sviluppo@panspinoff.com);

<sup>3</sup> Dep. of Environ. Agronomy and Crop Production, University of Padova, Italy, [maurizio.borin@unipd.it](mailto:maurizio.borin@unipd.it);

### Introduction

Increasing interest is given to assess the role of the agricultural systems in protecting and ameliorating natural resources. Taking into account animal biodiversity, the analysis of bird population is one of the informative ways to produce useful indicators and is also suggested by the EU directives. In this paper, two approaches for evaluation of birds biodiversity in two agricultural territories within Regional Natural Parks of Veneto (N-E Italy) are briefly presented.

### Methodology

The first approach is based on the organization and management of listening points. It is a qualitative method which allows to contact with a certain easiness the animals difficult to be observed. The technique aims to identify the species present in the area of the study, listening their singings from an adequate number of points of listening which are georeferred using a GPS. The main assumptions of this method consist in the correct species identification and in the fact that every individual does not be counted more times. Listening intervals can change from 5 to 20 minutes, but usually in the first 10 minutes about the 80% of the contacts is already obtained. The method has been applied in four sample farms inside the Regional Park of Euganean Hills. The farms differ for agricultural land use: one is mostly oriented to grape cultivation, one to olive, two to arable crops, one with conventional the other with organic cultivation methods. In all the farms there was an average presence of 118 metres of hedgerows per hectare that is considered a good equipment for bird population (O'Connor and Shrubbs, 1986). Listening campaigns have been carried out in different seasons during 2006 and 2007. Another way to study birds populations and their presence in agricultural systems is the counting of movements between fields and hedgerows in order to estimate how much important are boundaries in birds movements. This second method has been applied in the Regional Park of Sile River in the following observations points (OP): 1) wheat cultivated field completely surrounded by hedgerows (560 m/ha); 2) field grown with maize and grass, surrounded by hedgerows (370 m/ha); 3) similar to 1, but with 370 m/ha of hedgerows, with maize grown field; 4) maize grown field, without hedgerows but with some few isolated trees. In this case observations took place monthly from June to September 2006.

### Results

In the Regional Park of Euganean Hills, 44 species (*Aegithalos caudatus*; *Alauda arvensis*; *Alcedo atthis*; *Anas platyrhynchos*; *Anthus pratensis*; *Apus apus*; *Ardea cinerea*; *Carduelis chloris*; *Casmerodius alba*; *Columba palumbus*; *Corvus corone cornix*; *Delichon urbica*; *Dendrocopos major*; *Emberiza cirius*; *Erithacus rubecula*; *Fringilla coelebs*; *Galerida cristata*; *Gallinula chloropus*; *Hippolais polyglotta*; *Hirundo rustica*; *Jynx torquilla*; *Lanius collurio*; *Luscinia megarhynchos*; *Motacilla flava*; *Oriolus oriolus*; *Parus caeruleus*; *Passer italiae*; *Passer montanus*; *Phasianus colchicus*; *Phoenicurus phoenicurus*; *Pica pica*; *Picus viridis*; *Prunella modularis*; *Saxicola torquata*; *Serinus serinus*; *Streptopelia turtur*; *Streptopelia decaocto*; *Sturnus vulgaris*; *Sylvia atricapilla*; *Sylvia melanocephala*; *Troglodytes troglodytes*; *Turdus merula*; *Turdus pilaris*; *Upupa epops*) and 267 individuals were contacted. There are 29 species protected by European's conventions or directives or by national's laws. Only small differences were observed among agro-environments (table 1), probably due to the fact that the farms are in the ray of 4 kilometres and are rich of hedgerows and non cultivated area with intensive methods and also present a lot of habitat and ecotons. In the two farms with arable crops the presence of ditches justified the presence of birds connected with this habitat.

Table 1. Bird population characteristics in relation to agricultural land use. In brackets the number of protected species by european's conventions or directives or by national's legislation

Agro-environment	N° of species	N° of individuals	Shannon index	Simpson index
Grape	23 (17)	119	2.78	0.92
Olive	22 (14)	67	2.77	0.92
Arable conventional	25 (12)	94	2.90	0.92
Arable organic	25 (15)	53	2.96	0.93

In the Regional Park of Sile River the presence of hedgerows is a key factor in favouring bird movements, both in terms of total flights and variety of flights type. In absence of hedgerows, almost all the observations regarded flights above the site without interactions with ground (table 2). Taking the flights within OP, the highest the length of hedgerows, the higher the number of hourly flights and the more the birds' mobility within the field and/or among field and boundaries (table 3).

Table 2. Bird movements in relation to presence of hedgerows and land use

Total observations in each point	OP1	OP2	OP3	OP4	TOTAL
High above the site	3	22	10	21	56
From hedgerow to field	26	4	4	0	34
Between two or more hedgerows	9	3	9	0	21
From plant to plant	11	7	9	0	27
Leaving the site	11	6	4	2	23
Into the field or hedgerow	14	5	12	0	31
From field to hedgerow	4	8	6	2	20
Total	78	55	54	25	212

Table 3. Average bird flights within the fields in relation to hedgerows length

hedgerows length (m)	Area (Ha)	flights inside the OP (n/hour)	flights/100 m of hedgerows (n)
OP 1 314	0.56	8.4	1.2
OP 2 423	1.14	2.9	0.3
OP 3 883	2.41	4.3	0.2
OP 4 0	9.37	0.0	0.0

## Conclusions

The results have to be considered as preliminary, because studies on bird population require higher number of observations (even in nesting and wintering periods) to give useful indications.

In spite of this only some considerations can be drawn: the species as *Saxicola torquata*, *Sylvia melanocephala*, *Emberiza cirius*, *Lanius collurio*, *Picus viridis*, *Upupa epops*, *Dendrocopos major*, *Streptopelia turtur* e *Alauda arvensis* are good indicators of a good environment in the countryside because they need a complex habitat with hedgerows and trees. It is well known that the landscape structures have a direct influence on the bird populations. Small woods, isolated trees, hedges, farm fields, etc., allow and invite the movement of the birds (Hinsley and Bellamy, 2000; Bellamy and Hinsley, 2005). The first results show that these elements had a great influence on the birds presence and in the daily activity and movement inside the study area and outside from there to the adjacent zones.

The research was carried out in the frame of the PRIN Project "An agriculture for the protected areas" founded by the Italian Ministry of University and Research. Paper N° 14

## References

- P.E.Bellamy, S.A.Hinsley, The role of hedgerows in linking woodland birds populations 2005. Proceeding of International Association of Landscape Ecology (UK) Conference 2005, 'Landscape Ecology: Planning, People and Practice - the landscape ecology of sustainable landscapes'. Northampton, 12-16 September
- S. A. Hinsley, P. E. Bellamy, The influence of hedge structure, management and landscape context on the value of hedgerows to birds. A review 2000. J. of Environ. Manag. 60, 33-49
- R. J.O'Connor, M.Shrub, Farming and Birds 1986, Cambridge University Press, Cambridge

## ASSESSING AGRICULTURAL MANAGEMENT VIA MULTI-CRITERIA ANALYSIS: CASE-STUDY ON MAIZE SYSTEMS

N. Silvestri<sup>1</sup>, M. Andreoli<sup>2</sup>, G. Bellocchi<sup>1</sup>

<sup>1</sup> Dept. of Agron. & Agro-Ecosystem Manag., University of Pisa, Italy, [nsilve@agr.unipi.it](mailto:nsilve@agr.unipi.it), [g.bellocchi@isci.it](mailto:g.bellocchi@isci.it)

<sup>2</sup> Department of Business Economics "E. Giannessi", University of Pisa, Italy, [mandreol@ec.unipi.it](mailto:mandreol@ec.unipi.it)

### Introduction

Recent trends in agro-technological innovation, market trends and subsidy policies brought about an increasing habit to base farm planning decisions on short term revenues while complying with long-term objectives (sustainability). However, farmers' choices aiming at achieving good economic results might not satisfy social and environmental needs. In such context, multi-criteria analysis (MCA) could assume an important role. MCA is peculiar for assessing the suitability of cropping systems (CS) in relation to more than one criterion (economic, agronomic and environmental), either considered as autonomous or interacting with other ones. This kind of analysis aims to rationalize the decision process through optimizing a vector of multiple indicators, weighed according to pre-defined priority criteria. In this study, the use of indicators is organized in two levels. Firstly, the most relevant indicators were selected and transformed in terms of utility; then, they are assigned to single assessment criteria, and weighed. The advantage stands in using only one evaluation procedure for both economic and non economic criteria, the latter expressed in physical or qualitative terms. MCA was performed on four alternative options for the management of maize.

### Methods and material

*Cropping systems* Data were analyzed from a long-term experiment (started in 1990 and still in course) on continuous maize crops, carried out at the "E. Avanzi" Inter-Departmental Centre for Agro-Environmental Research of the University of Pisa (Italy). The research compared a conventional system (SC) based on the management traditionally adopted in the area for irrigated maize, two low-input systems (SR, lower amount of chemicals than SC, on the whole surface; SB lower amount of chemicals obtained by reducing the treated area), and a no-chemical system (SO). These four maize systems were assessed over the period 1990-2000 (Pampana et al., 2002). Such temporal interval is sufficiently long to appraise the evolution of the systems; however, it is not excessively long and can be considered representative of a given technology in the context of the same political framework. Relevant management details for each maize system are reported in Tab. 1.

Tab. 1. Management details for four maize systems  
(SC: conventional; SR: low chemicals; SB: reduced area of chemical treatment; SO: organic farming).

management option	maize system			
	SC	SR	SB	SO
Tillage	0.3-m ploughing	rotary hoeing	sod-seeding	0.3-m ploughing
Fertilization	335 kg N ha <sup>-1</sup> , 150 kg P <sub>2</sub> O <sub>5</sub> ha <sup>-1</sup> , 150 kg K <sub>2</sub> O ha <sup>-1</sup>	215 kg N ha <sup>-1</sup> , 85 kg P <sub>2</sub> O <sub>5</sub> ha <sup>-1</sup> , 85 kg K <sub>2</sub> O ha <sup>-1</sup>	220 kg N ha <sup>-1</sup> , 75 kg P <sub>2</sub> O <sub>5</sub> ha <sup>-1</sup> , 75 kg K <sub>2</sub> O ha <sup>-1</sup>	335 kg N ha <sup>-1</sup> , 150 kg P <sub>2</sub> O <sub>5</sub> ha <sup>-1</sup> , 150 kg K <sub>2</sub> O ha <sup>-1</sup>
Weed control	"whole field" pre-emergence herbicide	"whole field" post-emergence herbicide	localized pre-emergence herbicide	flame weeding + finger harrowing

The four systems share the same hybrid (class FAO 700) and the same irrigation amounts (~700 m<sup>3</sup> ha<sup>-1</sup>)

*Multi-criteria analysis* The performances of the four systems were assessed based on a variety of indicators, referred to three criteria: environmental, agronomic and economic (Tab. 2). VISPA (*Valutazione Integrata per la Scelta tra Progetti Alternativi*, Colomi et al., 1988) software tool was used for MCA. The analytical procedure was organized in the following stages: conversion of the physical data from original scales to utility functions; attribution of normalized weights to single indicators as a product from normalized weights within each criterion (technical weights) and normalized weights of criteria ("political" weights); sorting of alternatives. Normalized weights

(summing up to 1) make results independent on both the number of indicators used and the absolute values attributed to weights.

Tab. 2. Indicators to assess the performances of maize systems  
(ENV: environmental; AGR: agronomic; ECO: economic)\*

Indicators		
ENV	AGR	ECO
Zinc, copper, lead, nickel in soil (F)	Soil organic matter content (F)	Gross margin (R)
Pesticide residue in soil (U)	Soil total nitrogen, assimilated phosphorous (F)	Gross margin per work hour (R)
Nitrates in soil (R)	Yields (R)	Transferability index (U)
Nitrates, phosphates in soil solution (R)	Yields stability (U)	VFO <sup>(1)</sup> / EU contributions (R)
Run-off, soil erosion (R)	Weed seeds in soil (F)	Revenues / costs (R)
Nitrates, phosphates in run-off (R)	Bulk density (F)	Gross margin stability (R)
Protein content in grain (R)	Penetration resistance (F)	
Biodiversity Shannon-Weiner index (R)		

\*F: 'final', value acquired when the experimentation had come on "regime effectiveness"; U: 'unique', value acquired in one time, providing "distributed" information for the whole period of time considered; R: 'repeated', value determined from the average of repeated measurements. <sup>(1)</sup>Value of Final Output: quantity of a commodity which can be sold off the farm.

## Results

With equal importance given to ENV, AGR and ECO criteria, results are summarized in Tab. 3. With weighted sum ranking (alternatives sorted out for their overall utility, computed as sum of products of the utility associated with each indicator and its weight), the best score (0.605) was attributed to SB, and the second best (0.599) to SR. The other two systems presented lower scores (0.505 for SO, 0.492 for SC). With other ranking methods, modifications were observed in the order of alternatives, where SB and SR, or SO and SC, were exchanged in position. The former took place when adopting the worst case (minimization of risk), discordance index (minimization of standardized risk, based on the maximum difference between alternatives), and weak dominance (based both on concordance and discordance matrices). The latter occurred with the concordance index (based on a concordance matrix where each datum is the sum of weights for which the indicators of an alternative are better than or equal to the ones of another alternative). Partial changes to the weights attributed to the three criteria (e.g. 0.5 to one and 0.25 to both the other two) did not determine variations in the ranking of alternatives for any of the ranking methods considered.

Tab. 3. MCA results: ranking of maize systems according to alternative methods.

ranking methods	best value	maize system			
		SC	SR	SB	SO
weighted sum	highest	0.492	0.599	0.605	0.505
worst case	highest	0.050	0.173	0.165	0.102
concordance index	highest	-0.433	0.379	0.439	-0.385
discordance index	lowest	1.857	-1.807	-0.750	0.701
weak dominance	lowest	0.472	0.000	0.185	0.428

## Conclusions

MCA is characterized by traits of subjectivity associated with the use of indicators, their conversion in terms of utility, and definition of a weighting system to keep into account preferences. In some cases however, it comes up with unambiguous results, to be considered stable in relation to reasonable variations in the hypotheses adopted. In the cases examined, the superiority of SR and SB in comparison to the other alternatives was clearly disclosed. These results suggest that some changes are required in the farming practices adopted by farmers of coastal plains of central Italy, where conventional maize mono-crop represents a key CS. Sensitivity to the weights will be analyzed later.

## References

Colorni et al., VISPA, software territoriale e ambientale, 1988, CLUP, Milano  
Pampana et al. Bilanci economici, energetici e nutrizionali in sistemi maidicoli del centro Italia: l'esperienza di un decennio, 2002. Rivista di Agronomia 36, 297-305

**Session 2.6:  
Paddock / Farm / Catchment Model Platforms**

**Session Convenors:  
Dean Holzworth and Andrea Rizzoli**

## SOFTWARE COMPONENTS TO SIMULATE SURFACE RUNOFF, WATER, CARBON AND NITROGEN DYNAMICS IN SOIL

M. Acutis<sup>1</sup>, P. Trevisiol<sup>1</sup>, A. Gentile<sup>1</sup>, D. Ditto<sup>1</sup>, L. Bechini<sup>1</sup>

<sup>1</sup> University of Milan, Department of Crop Science, Milan, Italy, {marco.acutis, patrizia.trevisiol, antonella.gentile, domenico.ditto, luca.bechini}@unimi.it

### Introduction

RunoffErosion, Water and Nitrogen are stand-alone .NET components, developed in the Seamless project framework. The RunoffErosion component provides a structured repository of methods for soil runoff and erosion simulation. The Water component simulates soil water dynamics and percolation. The Carbon/Nitrogen component simulates carbon and nitrogen dynamics in the soil, including nitrate leaching, losses of CO<sub>2</sub>, ammonia volatilization and denitrification. The components handle in input irrigation, tillage and fertilization events. They are programmed according to the OOP paradigm using C# in the .NET platform, and respond to the concepts of modularity, interchangeability, and extensibility, increasingly requested in recent years to develop biophysical models (Donatelli and Rizzoli, 2007). Consequently, these components can also be deployed independently for other uses than in the Seamless framework. Components have the following features: 1) explicit ontology: all variables include the measurement unit, maximum and minimum allowed values, default value and textual description; 2) capability to extend the component models by adding new simulation strategies without recompiling the component and still using the same call; 3) test of pre- and post-conditions; 4) capability to extend the component's data structure. Components can be freely used and distributed by modellers and developers in their own applications.

### Methodology

A short description of the models implemented in the components follows:

Soil Conservation Service Curve Number: this empirical model calculates the soil surface runoff using, as input data, daily rainfall and maximum soil water retention.

Kinematic wave (KW): the KW approach (a simplification of the De Saint Venant equation), jointly with a soil water infiltration function, allows the development of a distributed physically based models describing water runoff from small agricultural and urban watersheds. The maximum time step allowed for rainfall data is one hour, but a shorter time step of rainfall data allows a better simulation of this instantaneous phenomenon.

MUSLE: (Williams et al., 1995): it is a physically based approach introduced as an improvement to the USLE (Wischmeyer 1978), where the rainfall energy term is substituted by a term based on the runoff volume and peak discharge flux. This allows for a single event simulation, while the USLE approach is based on annual data.

Cascading model: the cascading model assumes that water can move only vertically down the soil profile from top to bottom. Water is drained when the water content of a soil layer exceeds the field capacity. Excess water is instantaneously transferred to the layer below. The main advantage of this approach is the speed of calculation and the need of only two soil parameters (field capacity and wilting point). A modification of the cascading approach, including a water travel time, is also available.

Richards' equation: the model assumes that water flow between two points is a function of the pressure gradient between the points and of the hydraulic conductivity. Consequently, water retention and hydraulic conductivity curves are needed. The difficulty in solving the Richards' equation is due to the parabolic differential equation and the non-linearity of the hydraulic functions that correlate the water content, the water potential and the hydraulic conductivity. The calculated water flows depend on the structure of the numerical outline, the interval time and the steps spaces (vanGenuchten, 1982; Milly, 1985; Miller ET al., 1998). Here the Richards' equation is solved in 1D, following the approach of van Dam et al. (2000), because it allows the presence of a water table in the soil profile.

Carbon/Nitrogen model: it is an implementation of SOILN (Johnsson et al., 1987). It describes soil organic matter using three pools [slow-cycling humus, and fast-cycling litter (L) and faeces (F)].

Added organic materials are decomposed with first-order kinetics by the soil microbial biomass (implicitly represented in L and F), and are partly respired (releasing CO<sub>2</sub>) and partly humified. Nitrogen transformations that are simulated include: mineralisation, immobilization, urea hydrolysis, nitrification, denitrification, atmospheric depositions, leaching, crop uptake, and ammonia volatilization.

Tillage model: effect of about 80 tillage implements in terms of soil mixing, bulk density changes and soil surface characteristics is implemented according to the WEPP model (Alberts et al, 1995). The tillage model allows also for residual and fertilizer incorporation in the soil.

## Results

The result is the realization of three software components, with the characteristics in term of design and use described below.

Each component is a part of a package that contains the component itself and CRA.Core.Precondition.dll. The last one is a component (<http://www.sipeaa.it/tools>), used to implement the design by contract paradigm, which allows for testing if the input and output data respect the range of values defined in the component to which the data belong.

The three components implement the design pattern strategy. This means the component can provide one or more approaches (strategies) to simulate the same physical process. This type of design is advantageous both for the user, who can choose among alternative algorithms, and for the software developer, who can add new algorithms without recompiling the component, while keeping the same interface and the same call.

The input and output data of the methods, to simulate the soil physical processes, are state, rate, exogenous and auxiliary variables that belong to the each component domain. The variables constitute the data structure that can be extended, adding new variables. The methods and the data are called in input by the method "update()", instead the events of tillage and irrigation are handled in input by the method "HandleEvents()". This method exists in addition to the method "update()" because the events are called only if they occur.

The three components can be used as stand alone components or inside a framework. In the last case they can communicate among themselves and with other components if they are present in the framework. Parameters of the different models are stored in an XML files and specific tools are available (MPE, <http://www.apesimulator.it/help/tools/mpe/>) for editing and append new parameters.

## Conclusions

The RunoffErosion, Water and Carbon/Nitrogen components are easy to maintain, reusable, interchangeable and extensible. This type of software design should be appreciated by the scientists who implement new algorithms and want to use them in components already developed and tested. Moreover, in these components the users can find different well-tested approaches relative to empirical and physically based models. The actual prototypes of components are available at no cost at <http://www.acutis.it/seamlessSoil.htm>. All the DLLs needed to run the component and an extensive and detailed help file (with examples of source code) can be downloaded for each component.

The work presented in this publication is partially funded by the SEAMLESS integrated project, EU 6th Framework Programme

## References

- E.E. Alberts et al., WEPP Model User guide. Chapter 7. SOIL COMPONENT, 1995. NSERL Report No. 10  
 M. Donatelli, A. Rizzoli, A design for framework-independent model components... 2007 These proceedings  
 C.T. Miller et al., Robust solution of Richards equation for ....., 1998. Water Resour. Res. 34, 2599-2610.  
 H. Johnsson et al., Simulated nitrogen dynamics and losses ..., 1987. Agr., Ecos, and Environ. 18, 333-356.  
 J.R. Williams, Chapter 25: The EPIC model, 1995. In V.P. Singh (ed) Computer models of watershed hydrology. Water Resources Publication, 909-1000.  
 M.T. vanGenuchten, A comparison of numerical solutions of the ....., 1982. Adv. Water Resour. 5, 47-55.  
 P.C.D. Milly, A mass conservative procedure for time stepping in ....., 1985. Adv. Water Resour. 8, 32-36.  
 W.H. Wischmeyer, D.D. Smith, Predicting rainfall erosion losses, 1978. Agr. Handbook 537, USDA, Washington D.C.



## SENSITIVITY ANALYSIS OF THE MODEL WARM IN FIVE EUROPEAN RICE DISTRICTS USING DIFFERENT METHODS: MORRIS AND SOBOL'

R. Confalonieri<sup>1</sup>, M. Acutis<sup>2</sup>, M. Donatelli<sup>3</sup>, G. Bellocchi<sup>4</sup>, G. Genovese<sup>1</sup>

<sup>1</sup> EC Directorate General JRC, IPSC, Agriculture and Fisheries Unit, Ispra (VA), Italy, [roberto.confalonieri@jrc.it](mailto:roberto.confalonieri@jrc.it), [giampiero.genovese@jrc.it](mailto:giampiero.genovese@jrc.it)

<sup>2</sup> University of Milan, Department of Crop Science, Milan, Italy, [marco.acutis@unimi.it](mailto:marco.acutis@unimi.it)

<sup>3</sup> Agricultural Research Council, Research Centre for Industrial Crops, Bologna, Italy, [m.donatelli@isci.it](mailto:m.donatelli@isci.it)

<sup>4</sup> EC Directorate General JRC, IHCP, Biotechnology and GMOs Unit, Ispra (VA), Italy, [gianni.bellocchi@jrc.it](mailto:gianni.bellocchi@jrc.it)

### Introduction

Biophysical models (including crop models) may require a large number of input parameters, which values are not known with certainty. Parameterization errors are considered one of the primary sources of uncertainty in model response. In general, model which respond to minor changes in inputs with large changes in outputs are of suspect reliability, especially if the sensitive parameters are difficult to determine accurately. The understanding of model response to the variation of parameter values is therefore needed as one of the pre-requisites for model use. Sensitivity analysis (SA) calculates to which extent the outputs of a model depend on its inputs and is an important step of model evaluation to address parameter uncertainty. Advanced software tools are required to perform SA on crop models because of links needed and data-intensive processing (Confalonieri et al., 2006). This paper reports on the results of a SA study performed on a model for rice (*Oryza sativa* L.) simulation (WARM, <http://agrifish.jrc.it/marsstat/WARM>), run over sites representative of important rice districts in Europe.

### Methodology

Rice cultivation areas were selected from Northern Italy (45.08 °North, 8.68 °East), Southern Spain (37.20 °North, 6.00 °West), Southern France (43.66 °North, 4.36 °East), Central Portugal (40.01 °North, 8.44 °West), and Northern Greece (42.14 °North, 24.56 °East). For these sites, extended records of daily weather data from 50-km grid points were supplied by the MARS database (<http://agrifish.jrc.it/marsstat/datadistribution>) of the European Commission - Joint Research Centre (Ispra, Italy). At each site, a simulation study was performed with WARM at three years, differing for the continentality regime (intermediate, low and high, appreciated via the relative extreme amplitude criterion: difference between the mean daily maximum temperature of the warmest month and the mean daily minimum temperature of the coldest month). The variation of aboveground biomass at physiological maturity (AGB), in response to crop parameters change, was investigated using two SA methods supplied by a tool integrated in the WARM modelling environment, based on SimLab DLL (<http://simlab.jrc.it>). The Morris' method, less demanding of computational resources, is suitable for general screening between sensitive and insensitive parameters. The Sobol's method was applied for rigorous quantification of the sensitivity. A total of 646920 simulations were run.

### Results

Tab. 1. Long-term and low/intermediate/high yearly continentality regimes at different European regions (lowland littoral; \* semi-continental; \*\* continental)

Region	Low		Intermediate		High		Long-term median value
	Year	Continentality index (°C)	Year	Continentality index (°C)	Year	Continentality index (°C)	
South France	1977	24*	1998	28*	2003	32**	28**
North Greece	1979	30**	1999	34**	2001	39**	34**
North Italy	1996	25*	1975	28*	1985	33**	32**
South Spain	1990	23*	1986	30**	1993	33**	30**
Central Portugal	2002	17*	1993	24*	1989	28**	24*

With the exception of Central Portugal, where lowland littoral conditions are dominant, semi-continental regimes were prevalently observed in the study-sites (Tab. 1). In North Greece, continental

conditions are also likely to occur. For both SA methods, results are reported relative to the three most sensitive parameters (Tab. 2). Based on Morris' method, the model was highly sensitive to radiation use efficiency (RUE), optimal temperature for growth (Topt) and Biomass partitioned to leaves at emergence (RipL0) at all sites. Under some lowland littoral regimes (1977 in France, 1993 and 2002 in Portugal), Topt tended to become more relevant than RUE. Leaf Area Index at emergence (LAlini) resulted as relevant parameter with Sobol's method. The relevance of Topt was confirmed with this method for modest continentality regime (Portugal). For distinct continental conditions (e.g. 2003 in France, 1993 in Spain), the two emergence and leaf-related parameters became important.

Tab. 2. Results of SA with Morris and Sobol' method ( : mean influence of the parameter on the output in the Morris method;  $S_T$ : variance-based total sensitivity in the Sobol' method) for different regions. RUE: radiation use efficiency; Topt: optimum temperature for biomass accumulation; RipL0: biomass partitioned to leaves at emergence ; LAlini: leaf area index at emergence.

Morris method						
Continentality →	Low		Intermediate		High	
Region	Parameter		Parameter		Parameter	
South France	Topt	932	RUE	1567	RUE	1583
	RUE	805	Topt	1215	Topt	878
	RipL0	350	RipL0	566	RipL0	624
North Greece	RUE	700	RUE	754	RUE	702
	Topt	612	Topt	601	Topt	554
	RipL0	361	RipL0	387	RipL0	360
North Italy	RUE	1317	RUE	1179	RUE	1430
	Topt	987	Topt	1005	Topt	1264
	RipL0	544	RipL0	484	RipL0	573
South Spain	RUE	1596	RUE	1689	RUE	1569
	Topt	1010	Topt	998	Topt	734
	RipL0	570	RipL0	592	RipL0	599
Central Portugal	Topt	1182	Topt	1414	RUE	1451
	RUE	919	RUE	1297	Topt	1246
	RipL0	363	RipL0	499	RipL0	590
Sobol' method						
Continentality →	Low		Intermediate		High	
Region	Parameter	$S_T$	Parameter	$S_T$	Parameter	$S_T$
South France	RUE	0.36	RUE	0.49	RUE	0.53
	Topt	0.35	Topt	0.20	LAlini	0.17
	LAlini	0.12	LAlini	0.15	RipL0	0.11
North Greece	RUE	0.38	RUE	0.41	RUE	0.40
	Topt	0.19	Topt	0.15	Topt	0.15
	LAlini	0.13	LAlini	0.14	LAlini	0.14
North Italy	RUE	0.48	RUE	0.45	RUE	0.45
	Topt	0.18	Topt	0.22	Topt	0.23
	LAlini	0.16	LAlini	0.15	LAlini	0.14
South Spain	RUE	0.53	RUE	0.54	RUE	0.56
	LAlini	0.17	LAlini	0.18	LAlini	0.18
	Topt	0.14	Topt	0.13	RipL0	0.11
Central Portugal	Topt	0.41	RUE	0.39	RUE	0.45
	RUE	0.32	Topt	0.33	Topt	0.22
	LAlini	0.10	LAlini	0.12	LAlini	0.14

## Conclusions

The integration of SA tools within simulation environments is a key feature to manage model development and parameterization. For crop models, examples of SA are rare. In this study, sensitivity of simulated rice AGB was assessed by the SimLab-based tool integrated in the WARM environment. A complex pattern emerged on the relationship between sensitivity and climatic conditions, with diverse responses coming out of alternative SA methods. Further studies are required.

## References

R. Confalonieri et al., Exploratory sensitivity analysis of CropSyst, WARM and WOFOST: a case-study with rice biomass simulations, 2006. Ital. J. Agrometeorol. 11, 17-25

## CLIMINDICES: A SOFTWARE COMPONENT TO COMPUTE AGRO-METEOROLOGICAL INDICATORS

R. Confalonieri<sup>1</sup>, G. Bellocchi<sup>2</sup>, M. Donatelli<sup>2</sup>, M. Rivington<sup>3</sup>, K. Matthews<sup>3</sup>

<sup>1</sup> EC Directorate General JRC, IPSC, Agriculture and Fisheries Unit, Ispra (VA), Italy,

[roberto.confalonieri@jrc.it](mailto:roberto.confalonieri@jrc.it)

<sup>2</sup> Agricultural Research Council, ISCI, Bologna, Italy, [gianni.bellocchi@jrc.it](mailto:gianni.bellocchi@jrc.it), [m.donatelli@isci.it](mailto:m.donatelli@isci.it)

<sup>3</sup> Macaulay Institute, Aberdeen, United Kingdom, [m.rivington@macaulay.ac.uk](mailto:m.rivington@macaulay.ac.uk),  
[k.matthews@macaulay.ac.uk](mailto:k.matthews@macaulay.ac.uk)

### Introduction

The advent of component-based programming has enabled the development of scalable, robust, large-scale applications in a variety of domains, including agro-ecology (Argent, 2004). Software components promote re-usability, inter-changeability, and extensibility of approaches (Donatelli et al., 2006). In this context, we have addressed the calculation of agro-meteorological indicators which have been developed and used in agro-ecological research (e.g. Bellocchi et al., 2004; Matthews et al., 2007). Such indicators, generally computed on daily weather data, are used either to analyze weather patterns, or as inputs to biophysical models. A specific use of such indicators is in the assessment of the impact of climate change on agricultural systems, as a complement to simulation models. Beyond the variety of scenarios produced by global circulation models, the spatial downscaling techniques also add datasets which can be used for further processing. It is needed to characterize each dataset for an *ex-ante* analysis, and also as an *ex-post* source of information. To facilitate the computation of a large variety of indices and provide a transparent knowledge base, a software component (ClimIndices) was developed for use in various applications. In this paper, the component features are described.

### Agro-ecological indices

A variety of indices, as developed and reviewed by Matthews et al. (2007), were implemented in groups of six types (Tab. 1): *Dates*, the first/last occurrence of a phenomenon in a period of time; *Counts*, recording the number of times a phenomenon occurs; *Thermal Units*, growing-degree days above/below a temperature threshold; *Water balance*, related to inputs/outputs of a simplified water balance representing the temporal sequence of changes of water within the soil; *Waves*, due to the cyclical occurrence of phenomena; *Indices*, to be compared to standard values.

Tab. 1. Agro-meteorological indicators implemented in ClimIndices.

type	indicator	type	indicator
Dates	Last spring air frost (doy)	Thermal sums	Accumulated air frost temperatures (°C-days)
	First winter air frost (doy)		Accumulated heating (°C-days)
	Last spring grass frost (doy)		Accumulated growing degree days (°C-days)
	First winter grass frost (doy)	Water balance	Wettest week amount (mm)
	Maximum soil moisture deficit (doy)		Excess winter rainfall (mm)
	Minimum soil moisture deficit (doy)		Maximum summer moisture deficit (mm)
	Wettest week (doy of midpoint)		Minimum summer moisture deficit (mm)
	Start of growing season (doy)	Waves	Longest heat wave (days)
	End of growing season (doy)		Longest cold spell (days)
	End of field capacity (doy)		Longest dry spell (days)
	Return to field capacity (doy)		Longest wet spell (days)
	Counts	Air frost days	Indices
Grass frost days		Rainfall seasonality index	
Heat stress days		Modified Fournier index	
Growing season range days			
Growing season days			
Dry days			
Wet days			
Access period range			
Access period days			
Dry soil days			
Very dry soil days			

Threshold criteria and definitions (e.g. base temperature, requirements for growth season start etc) are flexible and can be set by the user.

### Software component

ClimIndices (Fig. 1) is a software component written in C# for the .NET 2.0 platform of Windows, which is re-usable using any of the .NET languages. ClimIndices is supplied along with a sample client (including source code), and includes an application (MCE: Model Component Explorer) to facilitate input/output identification of alternative indicators. Component features are: explicit ontology, full documentation of both indices and source code; possibility for third parties to add new approaches without the need of re-compiling; test of pre- and post-conditions; messaging at various levels (critical, error, warning, information, verbose) to listeners (e.g. on screen, on a log file etc.) which can be defined in client applications. Each indicator is implemented as a discrete unit, which uses as input a domain object containing daily input data. The domain class from which the domain object is instantiated can be extended. The library of indicators can also be extended, and composite indicators can be built using simple indicators using fuzzy-logic based rules via the associated component IRENE. The component also uses a statistical component, NMath, for basic statistical functions. ClimIndices is freely distributed through the web site <http://www.sipeaa.it/tools>.

Fig. 1. Unified Modelling Language component model of ClimIndices.

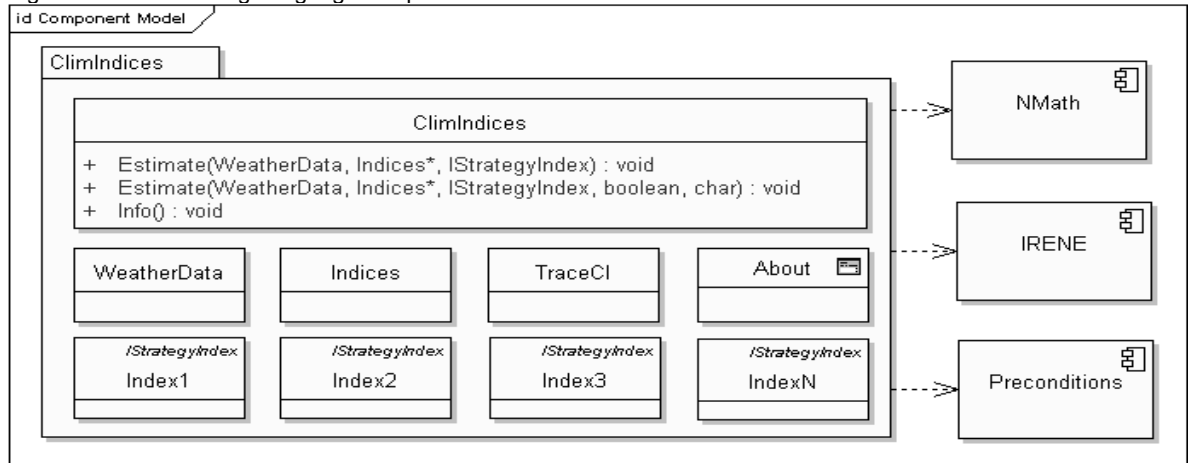

### Remarks

The goal of ClimIndices development is to extend access to agro-meteorological indicators while providing a software architecture which allows easy re-use and extension of coded metrics independently by third parties. Via its documentation and the metadata associated with each variable, ClimIndices component is a suitable way to share agro-climatic knowledge making it available for operational use in a variety of applications.

This research was partially granted of the FP6 EU project CLARIS (A Europe-South America Network for Climate Change Assessment and Impact Studies) <http://www.claris-eu.org>, and under the auspices of the project SIENA, supported by the Province of Siena (Italy) in cooperation with Agrichiana Farming (Montepulciano, Italy). The Scottish Executive Environment and Rural Affairs Department is also gratefully acknowledged.

### References

- R.M. Argent, An overview of model integration for environmental applications - components, frameworks and semantics, 2004. Environ. Modell. Softw. 19, 219-234
- G. Bellocci et al., Scenario characterization within a multi-factorial study of climate change impacts on whole-farm systems, 2004. Proc. 8<sup>th</sup> ESA Congress, 11-15 July, Copenhagen, Denmark, 219-220
- M. Donatelli et al., Sharing knowledge via software components: models on reference evapotranspiration, 2006. Eur. J. Agron. 24, 186-192
- K.B. Matthews, Characterising and communicating the agro-meteorological implications of climate change scenarios to land management stakeholders, 2007. Agric. Forest Meteorol. (submitted)

## A SOFTWARE COMPONENT FOR ENERGY BALANCE COMPUTATIONS IN AGRICULTURAL PRODUCTION SYSTEMS

E. Ceotto<sup>1</sup>, M. Donatelli<sup>2</sup>

<sup>1</sup> CRA – ISAGRO, SOP di Modena, Italy, [enrico.ceotto@entecra.it](mailto:enrico.ceotto@entecra.it)

<sup>2</sup> CRA – ISCI, Bologna, Italy, [marcello.donatelli@entecra.it](mailto:marcello.donatelli@entecra.it)

Plants have the unique ability to convert the incoming flux of solar energy, a renewable form of energy, into crop biomass, in form of food, fodder or fuel. However, in order to fully exploit the potential of crops in transforming SE into useful biomass, crops need to be supplemented with fossil energy (FE), either directly through soil tillage or pumping irrigation, or indirectly through the application of energy-demanding industrial fertilizers and pesticides. Consequently, modern agricultural systems are relatively-highly dependent on fossil energy (FE) and, therefore, are vulnerable to the sudden changes of world fuel prices. Also, agricultural activities are contributing, although at lower extent compared to industrial activities, heating and transportation, to the rise of carbon dioxide, and other greenhouse gases, with a detrimental effects on global warming (Mannion, 1997). There is much scope to achieve a more judicious use of FE in agriculture, which is to meet a reasonable compromise between diminishing GHG gas emission whilst maintaining adequate levels of crop productivity. In literature there are many papers reporting thorough energy balances of agricultural systems. Nevertheless, they normally contain evaluation and comparison among few specific case studies, and extrapolation to other agricultural systems are hardly, if ever, possible. Model systems are being developed to explore options for agricultural management, targeting at identifying *ex-ante* “best-suited” systems given constraints and goals of the optimization (e.g. The SEAMLESS project, <http://www.seamless-ip.org>). Cost functions to be optimized are in general based on economic evaluation, and may include accounting for system externalities. Making available an evaluation of the energy budget of agricultural systems would enrich both the analysis and hopefully the optimization process. The comparison of energy budget of few agricultural systems is a relatively easy task, although time consuming, due to the number of elements that must be taken into account. The major problems arises in dealing with the heterogeneity of input data sources and of conversion parameters. Therefore, a modelling tool is needed to provide means for routine evaluation of single agricultural activities, which can then be scaled to farm and to regions via a farm typology. The objective of this paper is to present a software component to make an energy balance based analysis of agricultural systems.

### Data structure

Each agricultural activity (the management actions implemented to get a product) and the consequent production are the data used to compute energy budget indices. Management actions are subdivided into 5 main categories, and each action has at least two attributes, i.e. *value* and *type*. Each value has attributes, such as minimum, maximum, and default value, units, and description. According to the category, value is a quantifier for the action (e.g. amount of irrigation water, amount of fertilizer, applied tillage operation). *Type* is an identifier, such as fertilizer type, implement type, irrigation method etc. The 5 categories are: 1) Crop operations, 2) Fertilization, 3) Irrigation, 4) Pesticides, and 5) Tillage. All management actions prior to a crop sowing and until crop harvest are conventionally attributed as inputs to the crop harvested. A crop product is described as type, biomass, harvest index, and crude protein content; the latter three have the same attributes as listed above. *Type* is also used as identifier in the database of parameters which include the conversion factors to normalize inputs and products in order to estimate the energy budget indices output-input and output/input. Parameters are defined in 5 tables corresponding to the 5 categories of management actions as above. Current definition allows estimating indices according to the Energy Budget (EB) indices methods implemented; however, the data structure, the parameters definition, and the EB methods can all be extended maintaining the compatibility with the currently implemented.

### Software design and implementation

EnergyBudget is a software component (Fig.1) written in C# for the .NET 2.0 platform of Windows, which is re-usable using any of the .NET languages. EnergyBudget is supplied along with a sample

client (including source code), and includes an application (MCE: Model Component Explorer) to facilitate input/output identification of alternative indices and the data attributes. Component features are (Donatelli and Rizzoli, 2007): explicit ontology, full documentation of both indices and source code; possibility for third parties to add new indices (the currently implemented are ENetBalance and EEfficiency) without the need of re-compiling the component; test of pre- and post-conditions; messaging at various levels (critical, error, warning, information, verbose) to listeners (e.g. on screen, on a log file etc.) which can be defined in client applications. Each index is implemented as a discrete unit, which uses as input a domain object containing data of agricultural operations to quantify the energy balance. The domain classes used as types in the domain object is instantiated can be extended. Access to data is done via an extensible library of readers (the default reader allows loading input data from run-time outputs of the component AgroManagement, Donatelli *et al.* 2007), and a simple client is provide to allow input via a graphical user interface. The format used for parameters persistency allows using the generic Model Parameters Editor (Di Guardo *et al.*, 2007) thus facilitating the use of the component in custom developed applications. The component is available at <http://www.sipeaa.it/tools>.

Fig. 1 Unified Modelling Language class diagram (main classes shown) of EnergyBudget.

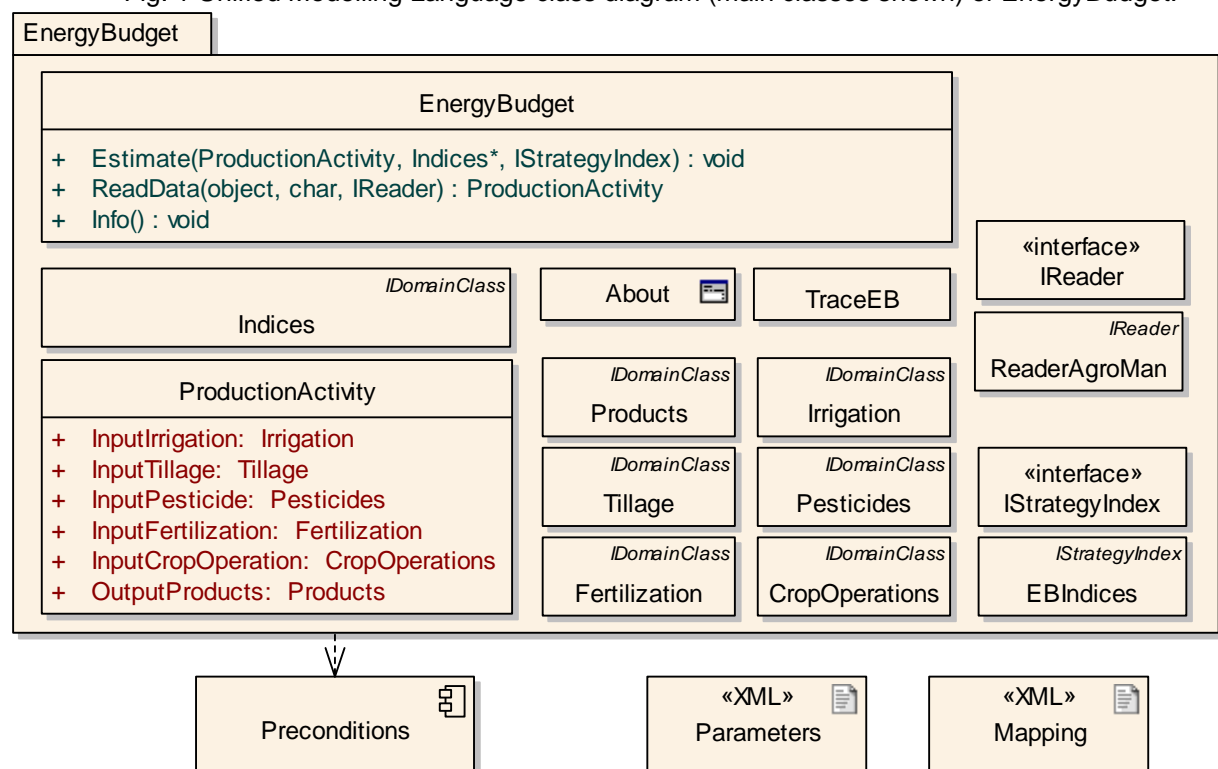

## Conclusions

The energy budget component is a first attempt to formalize and make operational an ontology for energy budget estimation in agricultural production systems. It can be linked, via extensible drivers, to external ontologies for agricultural management; as first example, a driver to link to the component agro-management is provided. The component allows estimating the energy budget of single production activities, which can be composed to upscale to farms. Its extensibility promotes reusability in custom developed applications.

The work presented in this publication is partially funded by the SEAMLESS integrated project, EU 6th Framework Programme

## References

- M. Donatelli, A. Rizzoli, A design for framework-independent model components of biophysical systems 2007 *These proceedings*  
 M. Donatelli et al., A software component to simulate agricultural management, 2007, *These proceedings*  
 A. Di Guardo et al. Two framework-independent components as GUI objects for biophysical system simulation 2007 *These proceedings*  
 A.M. Mannion, Agriculture and Environmental Change. 1997 John Wiley & Sons Ltd., England.

## A COMPONENT AND A SOFTWARE APPLICATION FOR MODEL OUTPUT EVALUATION

L.Criscuolo<sup>1</sup>, M.Donatelli<sup>1</sup>, G. Bellocchi<sup>1</sup>, M.Acutis<sup>2</sup>

<sup>1</sup> CRA-ISCI, Bologna, Italy [l.criscuolo@isci.it](mailto:l.criscuolo@isci.it), [m.donatelli@isci.it](mailto:m.donatelli@isci.it), [g.bellocchi@isci.it](mailto:g.bellocchi@isci.it)

<sup>2</sup> DiProVe, Univ. Milan, Italy, [marco.acutis@unimi.it](mailto:marco.acutis@unimi.it)

### Introduction

Evaluation of model estimates has always been regarded as a crucial step of model testing. Various either general purpose or dedicated statistics have been proposed to evaluate model performance, but no clear procedure is accepted as reference, hence the computation of several, different, indices per analysis may be required. The freeware, COM-based IRENE\_DLL (Integrated Resources for Evaluating Numerical Estimates\_Dynamic Link Library, Fila et al., 2003) was proposed as a flexible tool providing extensive, integrated, statistical and fuzzy-based capabilities for model evaluation, either used into modeling projects or to tailor dedicated applications (Fila et al., 2006). The software architecture of IRENE\_DLL includes only some key requirements desirable for reusable components. A Microsoft .NET version of IRENE was hence implemented according to a component oriented design, to provide third parties with the capability of extending methodologies without re-compiling the component, to ensure a high level of transparency and ease of maintenance, and to provide the test of input data versus their definition prior to any computation. A first prototype of an application (SOE: Simulation Output Evaluator) was developed to make available a client rich of operational options to final users. The objective of this paper is to present both IRENE and SOE.

### The component IRENE

IRENE is a component containing methods to evaluate model performances. Basic statistics can be computed for both estimated and measured data. Several validation metrics are implemented to compare model estimates against measured data (difference based and association based statistics). Residuals (differences between model estimates and actual data) can be related to external variables via Pattern Indices. Test statistics and probability distributions are also computed. The component contains also utilities to compose statistics using fuzzy rules; composition can be made available either using indices made available in IRENE, or it can be made using external inputs. The structure of composite statistics can be saved as XML files for re-use. The data structure allows using as inputs single or replicated measurements, and it allows for computing statistics on dataset based on one-to-one, many-to-one, many-to-many couples of data (for example, many-to-one is the situation in which replicated data, likely from an experiment, are compared to the simulation result of a deterministic model). Each statistics is fully described as minimum, maximum, and default value, description, and units. The component is implemented following the design presented by Donatelli and Rizzoli (2007), hence it can be extended by third parties without requiring re-compilation. The component uses two more components, one to implement the Design-by-contract approach, while the other is a generic statistical library, NMath (CenterSpace Software). The online help of the component is available at: <http://www.apesimulator.it/help/models/irene>.

### The application Simulation Output Evaluator - SOE

SOE is a data analysis tool which makes use of the component IRENE, and it is designed to provide easy access to model evaluation techniques. It provides also some graphical views of data to explore them. For each analysis, two data set must be loaded, consisting either just of one table, or of multiple tables. The formats are either XML with schema, or a more compact binary format (another component to make read/write operation using the binary format is also available and used); the formats are generic and used for instance also in the data visualization tool GDD (Di Guardo et al., 2007). A simple utility allows making XML files from a worksheet of a Microsoft Excel file via copy & paste. When the second dataset is loaded, the combo boxes of tables and variables are populated only with those which are present (same name) in both datasets. Further, when a variable is selected, only the couples matching dates are loaded for analysis. Finally, the user can select a subset of data, based on the dates. When the two set of data of a variable are loaded,

another variable, to be used as co-variate in the pattern analysis, can also be loaded. Once data of the user chosen variable are loaded, several analysis can be performed and displayed in various tabs of the application. As an example, the screenshot illustrates numerical and graphical evaluation for two data series, representing daily meteorological data. They differ only for the

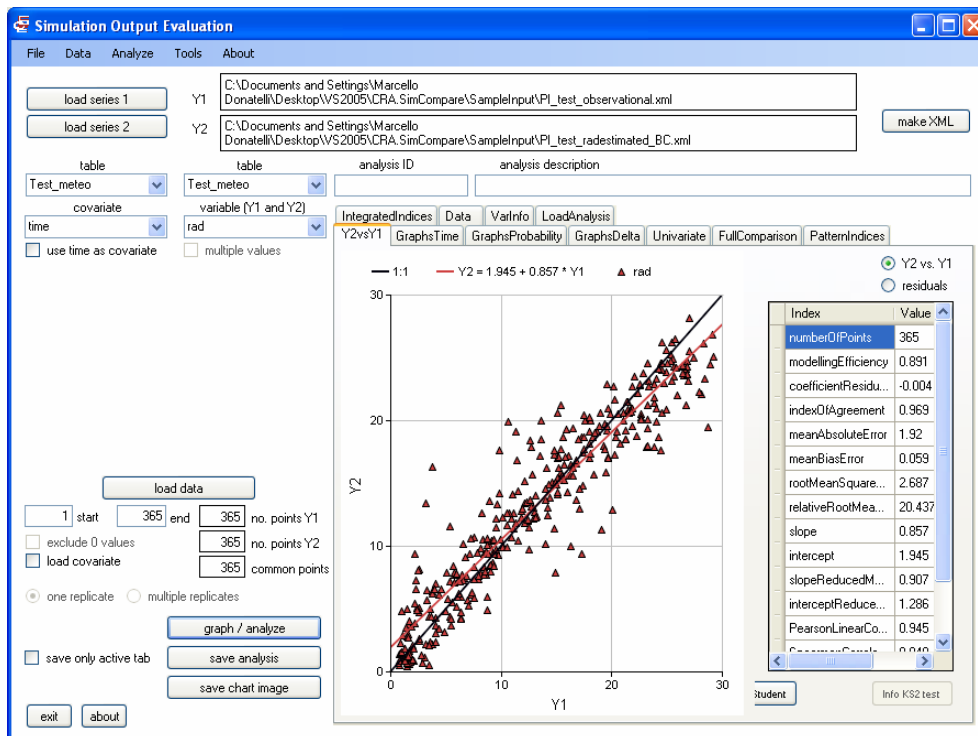

variable global solar radiation (rad), which is measured in the first series and estimated in the second. The aim of this analysis is to evaluate to which extent the estimated data differs from the measurements. A set of difference-based statistics is computed and shown in the table, and two classical graphics are produced: the  $Y_1$  vs.  $Y_2$  (shown) and the residuals. In the first one also the interpolating straight line and the 1:1 line

are plotted. Other tabs allow: 1) graphics vs. time of both variables and of  $Y_1 - Y_2$ ; 2) probability distributions; 3) cumulated values and increments vs. time; 4) univariate statistics; 5) comparison via the statistics available of a set of variables selected by the user; 6) Pattern Indices; 7) composite indices. The Data tab shows all data of each series in a tabular form, whereas the VarInfo tab shows the attributes (minimum, maximum, and default value, units and description) of each index computed by the application. The last tab contains a summary of the analyses done which is saved as an XML file once the analysis is run; all the images of the graphics done are also saved as .jpg files, one per graph, in a directory of choice.

The statistics computed are fully described in the help file of the component IRENE. The online help of SOE can be accessed at <http://www.apesimulator.it/help/tools/soe>.

## Conclusions

The goal of IRENE development is to extend access to model evaluation statistics to multiple users, and to provide architecture to ensure re-use and extensibility of coded models. IRENE attempts to overcome some of the technical challenges that to date have limited the development of reusable evaluation capabilities within integrated modeling environments. Via model documentation and the metadata associated to each variable, IRENE is also a way to share knowledge in an operational way.

The application SOE allows making a practical use of IRENE providing commonly needed views on data, when comparison between two series are made. It can be easily added to a simulation application as tool to analyze and compare model outputs.

Both software units are at a pre-release state, but they already allow an operational use.

The work presented in this publication is partially funded by the SEAMLESS integrated project, EU 6th Framework Programme

## References

- A. Di Guardo et al., Two framework-independent components for applications to sim... 2007 *These proc.*
- M. Donatelli and A. Rizzoli A design for framework -independent model components... 2007 *These proc.*
- G. Fila et al., IRENE\_DLL: A class library for evaluating numerical estimates. 2003. *Agron. J.* 95, 1330-1333
- G. Fila et al., PTFIndicator: an IRENE\_DLL-based application ... 2006. *Environ. Modell. Softw.* 21, 107-110



## COMPONENT REUSE IN BIOPHYSICAL MODELS – WHY IS IT SO HARD?

D. Holzworth<sup>1</sup>, N. Huth<sup>1</sup>, P. deVoil<sup>2</sup>

<sup>1</sup> Division of Sustainable Ecosystems, CSIRO / APSRU, Toowoomba, Qld, Australia

<sup>2</sup> Department of Primary Industries, DPI / APSRU, Toowoomba, Qld, Australia

### Introduction

The modelling world is awash with environmental / agricultural models, frameworks and components; these proceedings are proof of that. Generally there is not a great deal of compatibility between them. There are a lot of one-off models created to help inform particular problem domains and so compatibility isn't required. In other cases though, models are created to be compatible with one of the major frameworks in existence. There seems to be a cluster of frameworks used around the world; their use being geographically orientated. OpenMI (Gijsbers et. al.) is an emerging standard in Europe, APSIM (Keating et. al.) and TIME (Rahman et. al.) are widely used in Australia, DSSAT and CropSyst in the United States. All of these more or less define "standards" on how a model should be written to behave in the target system. Of course each of these standards is different. The challenge for software developers is to provide a mechanism allowing components to execute in multiple target frameworks. The user then gains the ability to choose the framework that is best suited to the task at hand and being able to link different components from different authors to construct diverse simulations.

One way to achieve this is for the modelling world to adopt OpenMI, TIME, APSIM or some other framework and everyone builds components compatible with that framework. This isn't going to happen for many reasons; political, economic, or simply suitability to the task at hand. An alternative is to devise an interface that is independent of the framework and operating system that allows components to be compiled and executed in multiple frameworks. This paper introduces this concept as a source code application programming interface (API).

### A Framework Independent API

In recent years, the authors have been guided by many of the Agile software development foundation principles ([www.agilemanifesto.org](http://www.agilemanifesto.org)). Key among these is: "Simplicity--the art of maximizing the amount of work not done--is essential." Translated to this project it becomes: "The simplest possible source code interface that enables a component to function in a range of frameworks". Other key elements of these principles include abstraction (such that the component is isolated from the simulation framework) and allowance for different language bindings, of particular interest given the authors development of APSIM modules in FORTRAN, C++, Delphi and the .NET languages.

At its simplest level, a component needs to initialise and terminate itself, get values of variables from elsewhere, arguably change values elsewhere and perform a time step calculation. Some publish / subscribe mechanism for notification of events, as supported by APSIM and OpenMI, may also be required.

Figure 1 graphically shows how a component talks to an API that abstracts the rest of the simulation and framework. The component knows nothing about the environment it is running in.

The form that this API takes is dependant on the capabilities of the language. For FORTRAN components, there needs to be an Initialise, Terminate and DoTimeStep routines in the FORTRAN source that the infrastructure calls. In addition the FORTRAN component can then call the routines in Figure 2 to read parameters, get and set variables, publish and subscribe to events and expose variables to the rest of the

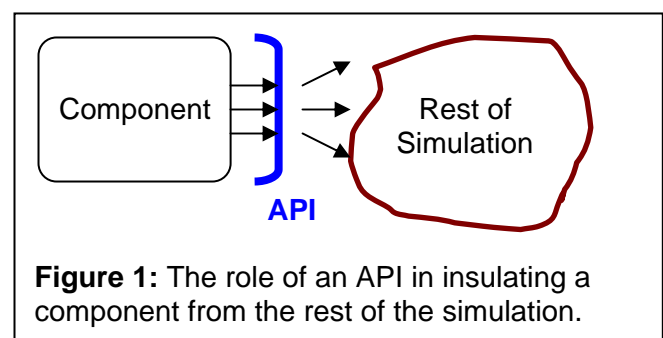

simulation. The whole API is then overloaded on data types.

The C++ and Delphi mappings of the API do away with the Initialise and Terminate routines in favour of class constructor and destructors. The rest of the API remains unchanged.

```
Subroutine Read(Name, Units, Data)
Subroutine Get(Name, Units, Data, Lower, Upper)
Subroutine Set(Name, Units, Data)
Subroutine Subscribe(Name, Handler)
Subroutine Publish(Name, Data)
Subroutine Expose(Name, Units, Desc, Writable, Data)
```

**Figure 2:** The FORTRAN component API.

More modern languages, like the .NET languages and Java, support reflection / introspection that make the API even simpler to specify. As an example, Figure 3 shows a sample component from the TIME platform (Rahman et. al. 2003). It uses reflection to specify model inputs, parameters and outputs, along with a runTimeStep method to perform timestep calculations. APSIM's .NET bindings likewise use reflection in a very similar manner.

The important thing to note in all these examples is the lack of framework and operating system knowledge e.g. type structures, byte fields, ID's and the like. In addition, older, simpler languages can also use these techniques. The more modern languages simply refine the specification.

```
public class ToyModel : Model
{
    [Input,Minimum(0.0)] double rainfall;
    [Input,Minimum(0.0)] double actualET;
    [State] double netRainfall;
    [Parameter,Minimum(0.0),Maximum(1.0)]
    double coefficient;
    [Output] double runoff;
    public override void runTimeStep( )
    {
        netRainfall = Math.Min(0.0,
                               rainfall-actualET);
        runoff = coefficient * netRainfall;
    }
}
```

**Figure 3:** A sample component from TIME Rahman et. al. (2003)

## Conclusion

A software interface is only a small part of the process of wrapping components to execute in different frameworks. System boundary and code structure are still important issues (the OpenMI guidelines devotes a whole section to them). Other issues include the semantic meaning of data going into and out of a component. Ontologies are one way of providing meaning to data. Simple documentation or even self describing source code are other mechanisms.

Whatever API a component uses to communicate with the rest of the simulation, two overriding principles should prevail; framework technologies in the interface should be avoided and above all else, **keep it simple!**

## References

- Gijsbers, P., Gregersen, J., Westen, S., Dirksen, F., Gavardinas, C., Blind, M., (2005), OpenMI Document Series: Part B Guidelines for the OpenMI (version 1.0), Edited by Isabella Tindall, on web: <http://www.OpenMI.org>
- Keating, B.A., Carberry P.S., Hammer, G.L., Probert, M.E., Robertson, M.J., Holzworth, D., Huth, N.I., Hargreaves, J.N.G., Meinke, H., Hochman, Z., McLean, G., Verburg, K., Snow, V., Dimes, J.P., Silburn, M., Wang, E., Brown, S., Bristow, K.L., Asseng, S., Chapman, S., McCown, R.L., Freebairn, D.M., Smith, C.J., An overview of APSIM, a model designed for farming systems simulation, *European Journal of Agronomy*, 18:3-4, 267-288, 2003.
- Rahman, J.M., Seaton, S.P., Perraud, J-M, Hotham, H., Verrelli, D.I. and Coleman, J.R. (2003) It's TIME for a New Environmental Modelling Framework. Proceedings of MODSIM 2004 International Congress on Modelling and Simulation, Townsville, Australia, 14-17 July 2003. Modelling and Simulation Society of Australia and New Zealand Inc., Vol 4, pp 1727-1732

## TWO FRAMEWORK-INDEPENDENT COMPONENTS FOR APPLICATIONS TO SIMULATE BIOPHYSICAL SYSTEMS

A. Di Guardo<sup>1</sup>, M. Donatelli<sup>2</sup>, M. Botta<sup>1</sup>

<sup>1</sup> Informatica Ambientale S.r.l., Milan, Italy, [diguardo@iambientale.it](mailto:diguardo@iambientale.it), [botta@iambientale.it](mailto:botta@iambientale.it)

<sup>2</sup> CRA-ISCI, Bologna, Italy, [marcello.donatelli@entecra.it](mailto:marcello.donatelli@entecra.it)

### Introduction

One way to describe a biophysical system is as a collection of several environmental compartments and connections among them. When such systems need to be modeled, a compartment view of the system leads naturally to envision discrete model units to be composed with the aim of simulating system behavior. This has led to the adoption by the biophysical modeling community of the component-based paradigm of the software industry. Component based simulation systems are designed to maximize both the ease of model maintenance and the flexibility in building new models as result of composition of pre-existing modules. Modeling units are linked as components via frameworks, which take care of repetitive tasks generalizing operations such as model linking, data I/O, and user interaction (e.g. Donatelli et al., 2002). Such frameworks should also implement the component based design paradigm, possibly making use of components which are not framework-specific, consequently being available for re-use in different applications, including other frameworks. The most critical choice in designing such components is the trade-off between a generic range of use, which promotes re-usability, and domain specific features, which increase both ease and effectiveness of use via specialization.

The objective of this paper is to present two graphical user interface software components which serve as dynamic parameter editor and as data visualization.

### The Model Parameter Editor - MPE

Composite models are made of simpler model, which can be often interchanged by alternative formulations. This means that the development and management of a simulation system may require the ability to deal with the fact that the number and type of the parameters of the composite model may change, each time a sub model is substituted. As parameters we mean quantities to be made available at run-time which do not vary during simulation and which are model specific (e.g. the  $\alpha$  parameter of a Weibull distribution). If the software system is made of interchangeable components, the need of dealing with different sets of parameters is likely more frequent, to the point of being considered an inherent feature of the system itself; an alternate component may model the same domain variables, but its approaches may demand for different, model specific, parameters. The need of changing parameters used has a primary impact on the graphical user interface (GUI) developed for the system: such GUI must be easily maintainable, and it must present the same look and feel to the user across versions. A parameter editor with these features must allow for changing the type of parameters to be edited without changing the code of the application, hence without a need for re-compilation of the editor.

The MPE is a Microsoft .NET component which allows generating dynamically a dedicated user interface for each set of parameter definition made available. A parameter definition is an XML file in which an alphanumeric called *parameter key* is used as indexing field for a set of parameters

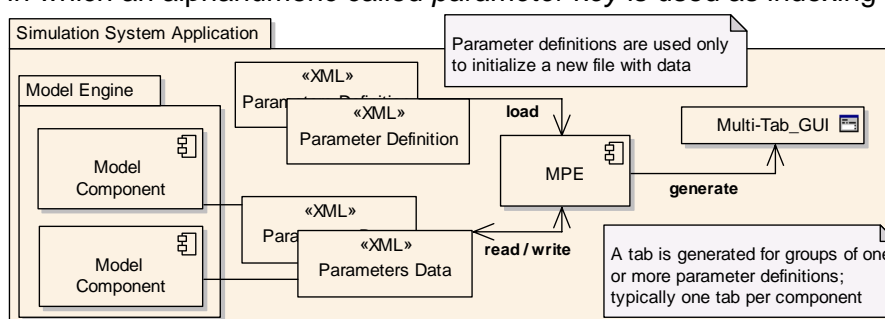

which can be defined, each of them, as a scalar, or vector, or typed collection. Also, for each parameter some attributes are declared: minimum, maximum, and default values, description, units. Parameters definitions are XML files which can be created via another

Fig.1 MPE in a biophysical simulation system application

application, as detailed in the help file. MPE allows either selecting parameters definitions, or loading automatically a pre-defined set of parameters definitions. A test of values adequacy (values within the range provided in their definition) is performed when saving values, providing an on screen feed-back. The help online is available at: <http://www.apesimulator.it/help/tools/mpe>

## The Graphic Data Display - GDD

Providing data views via graphical user interfaces is a common need for every application built to make use of models. If model output is generated by a modular system in which model components are interchangeable, output variables may change, thus maintaining such graphical user interfaces can be challenging and resource demanding. A tool which can load dataset with various schema and which helps the user to visualize data in various ways would speed up application development, allowing focusing on models, rather than on user interfaces. In such a tool, whether flexibility of use is a need, providing domain specific views of data would add value both in operational use and in model development.

The component GDD (Graphic Data Display) is a Microsoft .NET component which has the specific purpose to retrieve a set of output variables and to allow displaying values either by textual tables or by several kinds of graphs. GDD can be used as a stand-alone tool or as a component inside an application. In the former case it provides access to a file dialog to allow the user selecting a file, whereas in the latter case it can be opened inside a modeling framework directly loading the current dataset. At this development stage, GDD accepts inputs via two different formats: XML and a more compact/faster binary (another component, also available, allows I/O operations with the binary format). Readers can however be extended by third parties implementing the proper interface. Each variable can be either a table column, or an entire table of the dataset, depending on the fact that it is either only time-variant or time and 1 dimension space-variant (the latter are variables that vary across soil profiles, such as soil temperature). GDD has 5 tab pages in which different view types of data views are available. The first allows selecting a single table from the dataset and allow visualizing its content on screen; export in a Microsoft Excel format is possible for both the table currently selected and the entire dataset. The second tab provides the opportunity to plot up to seven variables vs. time allowing the user to set the time period and providing some graph options. The third tab is a scatter-graph representation of the relationship between two variables. In the fourth tab histograms can be plotted. The last tab is a domain specific graphical representation of a selection of variables generally available in a biophysical system simulation; the graph is divided into three contiguous sections. The upper graph panel allows plotting "crop/tree-related"

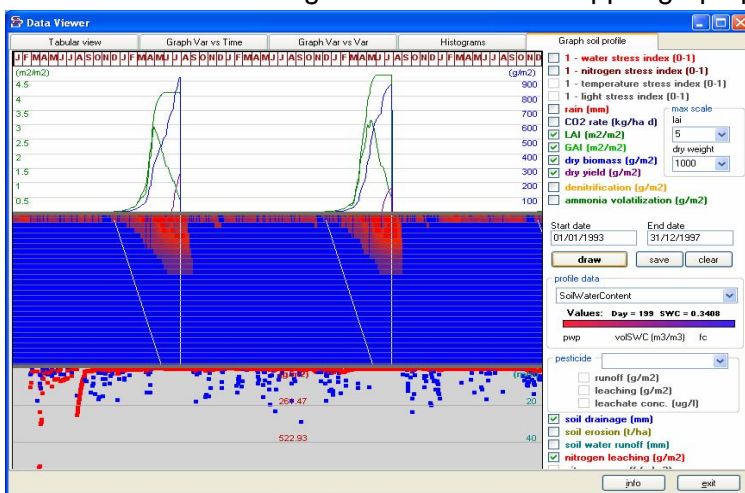

variables, and some emissions such as CO<sub>2</sub> and NO<sub>2</sub>. The central one plots the soil profile (soil water content, pesticide concentrations, soil temperature, soil nitrogen). The bottom panel allows plotting soil summary variables such as water drainage, nitrogen leaching, and pesticide leachate concentration. The first four tabs require generic data, whereas the fifth requires specific tables and variables; name of relevant tables and variables can be mapped via an XML file to the names used in the dataset to be loaded. Not all such variables need to be available in a

given dataset; for instance, if data of pesticides in the soil profile are not available, the relevant soil profiles will not be made available as options for plotting. Each graph of GDD can be exported to an image. The GDD online help is available at: <http://www.apesimulator.it/help/tools/gdd>

## Conclusions

The tools presented are examples of framework non-specific components. Although with some purposely implemented domain specificity in GDD, they allow developing biophysical models applications targeting at facilitating maintenance across rapidly evolving simulation systems.

The work presented in this publication is partially funded by the SEAMLESS integrated project, EU 6th Framework Programme

## References

M. Donatelli et al., What software design for evolution? 2002 Eur. J. Agron. 18 :7-9

## A SOFTWARE COMPONENT TO SIMULATE AGRO-MANAGEMENT

M. Donatelli<sup>1</sup>, E. Ceotto<sup>1</sup>, M. Acutis<sup>3</sup>

CRA-ISCI, Bologna, Italy [marcello.donatelli@entecra.it](mailto:marcello.donatelli@entecra.it) [enrico.ceotto@entecra.it](mailto:enrico.ceotto@entecra.it)  
DiProVe, University of Milan, Italy [marco.acutis@unimi.it](mailto:marco.acutis@unimi.it)

Expert knowledge exists in different environments to implement agro-management actions. Such knowledge is however available with different formalisms, so that working with simulation tools in different environments aiming at reproducing current conditions, as a base line to be compared to technological innovation, is challenging. Simulation of agricultural production activities is made via crop/cropping models (e.g. Stockle et al., 2003) which use a proprietary ontology to define agricultural management events, and often embed in their systems part of the information needed to model the relevant impact. The implementation of the management handling is hence hard-coded, so that, changes in the agro-management models require coding/re-coding them in the modeling systems. To overcome the problems above, a formalized description of agro-management and a software component to simulate agro-management actions in a component based simulation system was presented by Donatelli et al. (2006). This paper presents the developments of that software component.

### The rule-impact approach

When the decision making process is based on biophysical drivers, each management action is implemented given to a pre-made management plan defining actions and time windows, and in response to the state of the system. A typical example is irrigation: irrigation is planned, and then it is implemented if the soil becomes dry (*rule*), or if cumulated evapotranspiration exceeds a given threshold (*alternate rule*). *Rules* can be composite. Once a *rule* is met, the parameters an agro-management action are published, say irrigate 40 mm using a sprinkler (*impact*). *Rules* can be considered models, with their inputs and parameters. *Impacts* are set of parameters to implement a given action. Consequently, *rules* are a formal way to model farmers' behavior and actions. When building an agro-management plan, *rules* are coupled to *impacts*. A set of such couples *rule-impact* is hence the planned production technology applied to a specific production enterprise (the latter also defined via *rules* and *impacts*). A graphical representation of the relevant schema is:

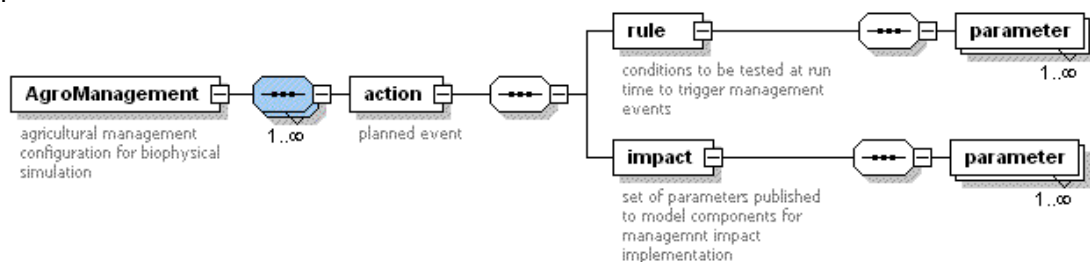

Fig. 1 Diagram representation of the schema of agro-management configuration for a simulation

### Implementing *rules* and *impacts*

We have created a generic AgroManagement component that implements the *rule-impact* mechanism described in this paper. A major feature of this component is its extensibility: new *rules* and *impacts* can be added without requiring re-compilation of the component. In the first prototype enumerators were used for some attributes of the *impacts*. For instance, *TillageImplement* was used by a component to identify a record of parameters needed to model the impact of a tillage operation, given a specific modeling approach. Different implements were consequently coded as enumerators in one *impact*, so that new implements could not be added without recompiling the component. The

new version of the component allows setting *impact* attributes by loading values from an XML file, hence allowing the extensibility also of *impacts* implemented. Other examples of enumerators which needed to be extended by third parties were crops, pesticides, irrigation methods. Extensibility of such keys to identify records of parameters has an important use when the agro-management component is used in one application. In fact, it allows users to add new record of parameters, which can be used immediately to build new agro-management configurations.

### The AgroManagement Configuration Generator - ACG

The ACG is an application, based on the AgroManagement component, which allows building XML files which are agro-management plans. Several improvements were implemented with respect to the first prototype, the most important being: 1) The possibility of merging easily different configurations: for instance, a configuration for a crop can be merged with one of another crop building a two-years rotation, 2) The attributes of each parameter (minimum, maximum, and default values, description, units) can be visualized while building a configuration, both in rules and impacts, and 3) the configuration can be visualized graphically, as in the screenshot below:

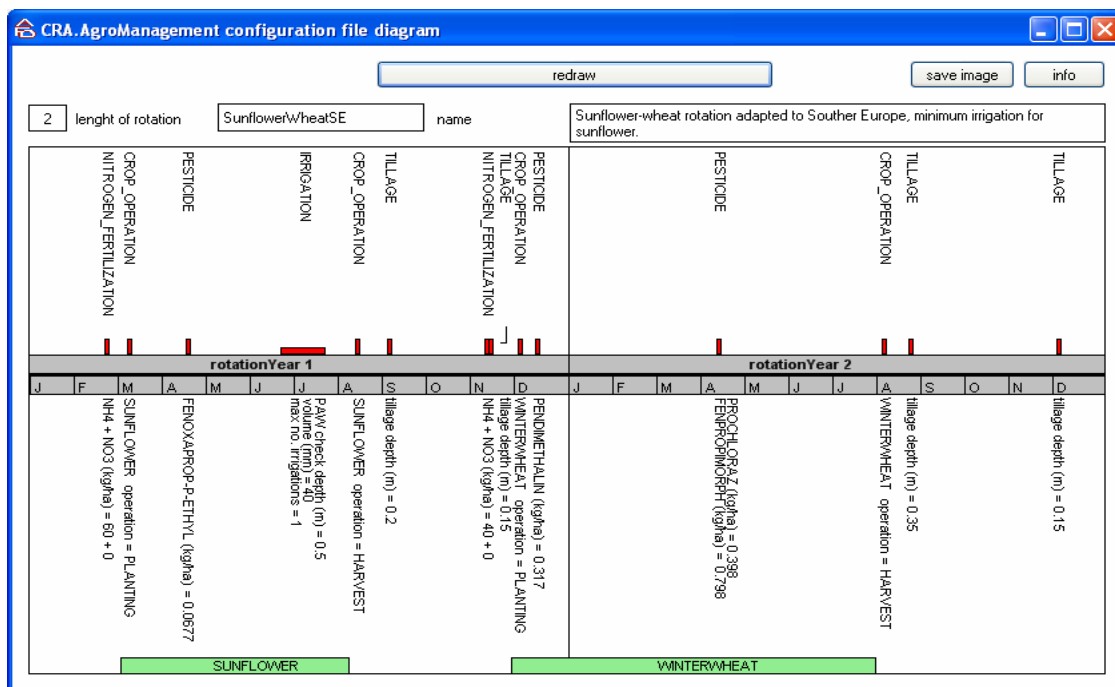

### Conclusions

The rule-impact approach allows specifying any biophysical driver of the decisional process to apply management, specifying any agro-technical input, and using any model to implement the impact of the action. The conceptual framework presented allows formalizing in a transparent and extensible way all the concepts relevant to agro-management, bridging expert knowledge to operational use in simulation. A tool to build graphically agro-management plans, thus facilitating prototyping, is being developed.

The work presented in this publication is partially funded by the SEAMLESS integrated project, EU 6th Framework Programme

### References

- M. Donatelli et al. A component to simulate agricultural man.... 2006. IEMSS congress, USA  
 C. O. Stöckle, et al. CropSyst, a cropping systems simulation... 2003. Eur. J. Agron. 3-4:289-307.

## A DESIGN FOR FRAMEWORK-INDEPENDENT MODEL COMPONENTS OF BIOPHYSICAL SYSTEMS

M.Donatelli<sup>1</sup>, A.Rizzoli<sup>2</sup>

<sup>1</sup> CRA-ISCI, Bologna, Italy [m.donatelli@iscsi.it](mailto:m.donatelli@iscsi.it)

<sup>2</sup> IDSIA, Manno-Lugano, Switzerland, [andrea@idsia.ch](mailto:andrea@idsia.ch)

### Introduction

Development in the design of software frameworks for biophysical systems simulation has focused mainly on the compromise between domain specificity and use flexibility. Models in such frameworks have been traditionally categorized either as framework-specific, or as “legacy” code. In the former case, models implemented as software components can take full advantage of the framework services and they depend on the framework. In the latter case, components are seen as discrete units of software, in general of coarse granularity in modeling terms, and the dependency on the framework is minimal, but the use is limited to the algorithms implemented. Thus, modellers who want to use a modelling framework are faced with two choices: if the framework is extensible, implement a framework specific component (i.e. not reusable outside the specific framework); the alternative is to provide a component as a black-box, taking little or no advantage of the framework itself. The objectives of this paper are: 1) to present a software design of non-framework specific component, and 2) introduce real-world sample applications of the concept.

### The design

The re-usability of software components can be enhanced by addressing the following requirements: 1. The component must target the solution of a sufficiently widespread modeling problem; 2. The published interface of the component must be well documented and it must be consistent, 3. The configuration of the component should not require excessive pre-existing knowledge and help should be provided in the definition of the model parameters 4. the model implemented in the component should be extensible by third parties, 5. The dependencies on other components should be limited and explicit, 6. The behavior of the component should be robust, and degrade gracefully, raising appropriate exceptions, 7. The component behavior should be traceable and such a trace should be scaleable (browsable at different debug levels), and 8. The component software implementation should be made using technologies with a widespread adoption. There are a number of solutions to address these requirements and we present the choices made for the design we have used in some components we have developed.

1. Targeting an explicit common modeling problem is associated with the granularity of the modeling approach. Fine grained components are more likely to be reused for specific computations, in the context of larger modeling problems. Simple model units can either be used in isolation or they can be composed to develop other modeling units. An example are the CLIMA components (Donatelli et al. 2006a; Carlini et al., 2006) which implement fine-grained models that generate synthetic weather variables. The component architecture adopts the Strategy design pattern in order to allow for the plugging-in of alternative model formulations to generate the model output, since various models can be used for the same purpose. The components referenced above match such requirements. A large coarse-grained component that simulates groundwater transport of a contaminant over a region might require a very complex configuration. This does not mean that large components are not reusable, but the effort to reuse them is bigger.

2. Components depend on the data they access (inputs, parameters, states etc.). Such data can be described and implemented by means of data structures called Domain Classes (DeI Furia et al., 1995). Each attribute of such classes will also have, beside its value, a set of attributes such as minimum, maximum, and default value; units; description, and may refer to a publicly available ontology via the attribute URL. Reflection can be used on such types thus allowing access to their ontology. The values of domain classes goes beyond their meaning as software implementation items, in fact they describe the domain of interest. The use of domain classes is equally valid for static and dynamic components (e.g., Acutis et al., 2007; Trevisan et al., 2007). If domain classes and interfaces are implemented in a separate discrete unit from models, the model unit can be replaced without affecting the client using the components (this is the Bridge design pattern). A component implementing domain classes and interfaces and another implementing models are a *unit of reuse*; the model component alone can be defined as a *unit of interchangeability*.

3. The API of the component must implement a pattern like the Create-Set-Call; objects are created via a default constructor, some attributes are set, and finally the model is called. The interface used for models should be the same for all modeling solutions in the component, implementing the Façade pattern to hide the complexity of each model solution. This leads to having a unique signature for internal and (see below) extended models. Such unique signature (its first overload in its simplest form), can be like: `Update(DomainClass d, IStrategy s);` being `d` an input-output object. Components should be stateless, to simplify their use in different systems. Sample clients, inclusive of code, must be made available.
4. The component must expose public interfaces to allow extensibility by third parties without requiring the re-compilation of the component, and to allow freedom of implementation. Components can be extended inheriting also from domain classes to extend them.
5. While dependencies should be kept at a minimum, we found necessary and particularly useful to introduce a dependency to another component, available both in .NET and Java (<http://www.apesimulator.it/help/utilities/preconditions>) which implements the Design-by-contract approach (see next point), and provides a type (`VarInfo`) to set the attributes of each variable. Moreover, it provides other base interfaces for models (strategies) and domain classes. Other dependencies to specific libraries (e.g. for numerical calculus) can be included, but no dependency to specific frameworks is implemented.
6. The robustness of the component is ensured by the implementation of the Design-by-contract approach, thus a clear contract between client and server is established. This allows not only developing a better targeted library of unit tests, but it also sets the domain of applicability of the models, contributing to the transparency of the modeling solution. If an unhandled exception occurs, an informative message describes the error and model and component source of the exception, allowing for continuing execution of the client according to a user choice.
7. The traceability of component behavior is implemented in the .NET versions using the `TraceSource` class, in one implementation that allows setting the listeners by the client. Various levels of tracing can be hence pooled in one or more listeners with all traces from other components and from the client. In Java components this is obtained using a logger.
8. The technology used is based on the object oriented programming (OOP) paradigm via the MS .NET 2.0 framework. However, the object model of .NET allows easy migration to the Sun Java platform. Such migration has been realized for some of the components referenced.

### Proofs of concept

Components implementing the solutions above have been made available for public use and other are being developed (examples are referenced below). The design has been tested on static and dynamic biophysical models, on agro-management models, and on statistical indices. Use of components has been done on applications and via frameworks such as TIME and Modcom.

### Conclusions

Balancing the focus from frameworks to a component design which follows the component oriented design results in a greater chance for model re-use. Framework independency stimulates model developers which do not feel constrained by a dependency to groups which develop specific frameworks, instead, components can be easily used in several frameworks via simple wrappers. Design choices related to the modularity of model implementation and the implementation of an explicit ontology for interfaces increase the transparency of the model construct and allow sharing knowledge in quantitative and usable terms. The design presented allows for extensibility by third parties which can then build on the domain description and models made available.

The work presented in this publication is partially funded by the SEAMLESS integrated project, EU 6th Framework Programme

### References

- M. Acutis et al. Software components to simulate water and nitrogen dynamics in soil. 2007 *These proc.*
- L. Carlini et al., Rain, a software component to generate synthetic ... 2006 *Agron. J.* 98:1312-1317
- L. Del Furia et al, Lakemaker: a general object-oriented software tool for modeling ... 1995 *Env. Soft.*
- M. Donatelli et. al., A software component for estimating solar radiation. 2006a *Env. Model. Soft.* 21:411-416
- M. Donatelli et al., Sharing knowledge via software components: models... 2006b *Eur. J. Agron.* 24:186-192
- M. Donatelli et al., A software component to simulate agro-management. 2007 *These proc.*
- M. Trevisan et al., A software component to simulate agro-chemicals fate. 2007 *These proc.*



## STUDYING CROPPING SYSTEM MANAGEMENT BY SIMULATION: THE RECORD PLATFORM PROJECT

J.-E. Bergez<sup>1</sup>, P. Chabrier<sup>2</sup>, F. Garcia<sup>2</sup>, C. Gary<sup>3</sup>, M.-H. Jeuffroy<sup>4</sup>, R. Martin-Clouaire<sup>2</sup>, H. Raynal<sup>2</sup>, D. Wallach<sup>1</sup>.

<sup>1</sup> INRA, UMR ARCHE, Castanet-Tolosan, France, {jbergez,wallach}@toulouse.inra.fr

<sup>2</sup> INRA, UBIA, Castanet-Tolosan, France, {chabrier,fgarcia,rmc,raynal}@toulouse.inra.fr

<sup>3</sup> INRA, UMR SYSTEM, Montpellier, France, gary@supagro.inra.fr

<sup>4</sup> INRA, UMR Agronomie, Thiverval-Grignon, France, jeuffroy@grignon.inra.fr

### Introduction

The pressing need in adapting and improving farming practices has motivated research efforts to extend the classical analyses of soil-crop-climate systems to considerations of their management at field, farm and regional scales. For the specific question of analysing and designing innovative cropping systems, INRA (French National Institute for Agricultural Research) has launched the development of a simulation modeling platform called RECORD. This modelling platform is intended to ease complex model development and to promote model reusability. The platform will also offer common methods for estimating model parameters, analysing simulation outputs and optimizing management policies. In the following, we first present the main functional requirements of RECORD. We then present some preliminary choices concerning the platform architecture.

### Modelling and simulation of cropping systems

The RECORD platform has been designed as a modelling and simulation software platform where researchers can build, assemble and couple their own pieces of model to pre-existing ones, and can simulate the resulting models. Analysing and designing cropping systems by modelling and simulation require to consider the interactions between agronomical, environmental and socio-economics components. In particular, both biophysical models like crop models, weed models, bioaggressor models, and decision models, for tactical decisions, strategic management, must be integrated if needed, and a key feature of the project is to put the management of cropping system on an equal foot with biophysical aspects. In order to open widely the platform to all the models, we chose to make no restrictions on the type of biophysical and decisional models that will be developed or plugged in our environment.

Modelers often encounter problems when they have to deal with temporal or spatial aspects in modelling work. The temporal granularity may be heterogeneous in cropping system models, from hours to years, with a time horizon going from weeks to several years and including cumulative aspects. Concerning the spatial aspects, the granularity is defined through elementary spatial units which are, most often, the agricultural parcels. The spatial horizon that has to be considered is rather wide, from fields to small agricultural regions.

The RECORD modelling environment will thus have to facilitate the implementation of heterogeneity and interactions between different kinds of spatial dynamic models, at different scales. These models can be either deterministic or stochastic, and are described within different modelling formalisms like difference equations, differential equations, partial differential equations, cellular automata for biophysical models, discrete events models or agent-based models for decision models.

Another key feature of the platform concerns the different services it will offer for the simulation activity (Wallach et al., 2006). They concern three major issues: the management of data, the statistical analysis of output data and some essential tools for the design and optimization of innovative farming systems. Simulation models may require a lot of input data and produce a large amount of output data of various types (time series, probability distribution, action chronicles, maps...). This is particularly true when user wants to perform wide range multi-simulations. So, the platform has to provide services concerning the management of these data. It is also important to offer an interface between models and some well-known databases available to agronomical researchers, such as soil databases for example. In order to analyse the output data, different statistical tools like *R* software will be available from the platform, and RECORD will provide special support on some statistical methods used for example for sensitivity analysis. The scientific

purpose of the RECORD project is to analyse and design innovative farming systems in a context of climate change and sustainable development. Methods in simulation optimization, multicriteria decision analysis and data mining will have to be integrated to the platform.

### **The platform architecture**

We identify three main issues to consider in the definition of the platform architecture.

First, the main contribution of the framework should be to encourage modelers to adopt a systemic approach when they model cropping system. For that, we propose to provide a convenient way to design clearly hierarchically structured models, and to make available to users all the mechanisms for easily defining systems and subsystems through their interactions, their states, their inputs and outputs and their dynamics. We see this systemic approach as a way of enhancing model intelligibility and reusability, by allowing a clear identification of component boundaries, and by easing their extraction in the process of elaborating new models.

This systemic approach is clearly suitable but must be accompanied with capabilities to adapt existing model components. Some specific features might need to be added, enriched or removed. Facilities for modeling by composition are important but the possibility to create brand new components and models is fundamental as well. The object-oriented paradigm and the incorporated ideas of polymorphism, inheritance, interface-based communication are offering clean and efficient means in the modeling process. In other words, the object-oriented representation should ideally be embedded with the systemic structuring approach.

Second, the framework has to provide flexibility, extensibility, and compatibility. We already saw that cropping system modeling could require the use of different modeling formalisms that have to be simulated all together. The architecture of the framework should then clearly separate the layer dedicated to the scientist user, based on representation languages directly related to the modeling formalisms used by modelers, from the layer that realizes integration of these different modeling formalisms. We must then consider that there are two specific levels for describing frameworks; the modeling level and the implementation level (Van Evert, 2005). The underlying requirement of this architectural design is then the need of strong theoretical basis and existing algorithms to address the required formalism heterogeneity through these two levels.

Third, the framework should support the co-existence of different types of coupling between several model components. To build a new model, components might be associated in a very loose way. In that case the idea is to manage parallel simulation of different models, with some data exchange at run time between these models seen as communicating components. This is the kind of solution developed for instance in the OpenMI framework, used for integrated water management modeling (Gregersen and Blint, 2004). When several models need to be closely connected and require frequent synchronizations, sophisticated protocols are required in order to avoid inefficiency problems. In this case, it seems preferable to have a single simulation machinery and to force all models to conform to a common implementation-level formalism. Such a formalism should be able to deal with a large range of simulation models, either continuous or of discrete event type. DEVS (Zeigler et al., 2000) is typically in this category.

### **Perspectives**

We intend now to evaluate the VLE modeling and simulation environment (Quesnel et al., 2007), which supports the DEVS formalism, as a basis for the development of the RECORD platform. The main issues will concern the development of the modeling formalisms that fit the needs, in particular for the spatial and decision making aspects. See <http://record.toulouse.inra.fr> for more about this project.

### **References**

- Evert, F. Van et al., Convergence in integrated modeling frameworks, 2005. Proc. MODSIM'05 Conference, Melbourne, Australia.
- Gregersen, J.B., M. Blint. OpenMI: The Essentials Concepts and their Implications for Legacy Software, 2004. Proc. of the IEMSS Conference Complexity and Integrated Resources Management, Osnabrück, Germany.
- Quesnel, G. et al., VLE – A Multimodeling and Simulation Environment, 2007. Proc. SCS'07, San Diego, USA.
- Wallach, D. et al. (Ed.), Working with Dynamic Crop Models : evaluating, analyzing, parameterization and applications, 2006. Elsevier, Amsterdam (NL).
- Zeigler, B.P. et al., Theory of Modeling and Simulation, Second Edition, 2000. Academic Press.

## THE MODCOM FRAMEWORK FOR COMPONENT-BASED SIMULATION

Frits K. van Evert<sup>1</sup>, E.J.J. (Arjan) Lamaker<sup>2</sup>

<sup>1</sup> Plant Research International, Wageningen, The Netherlands, [frits.vanevert@wur.nl](mailto:frits.vanevert@wur.nl)

<sup>2</sup> WUR Facility Services, Wageningen, The Netherlands, [arjan.lamaker@wur.nl](mailto:arjan.lamaker@wur.nl)

### Introduction

It is usually difficult to reuse a part of an agro-ecological simulation model, or replace a part of it with a functionally equivalent part that is based on another model. Also, the implementation details of each model make it difficult to develop generic tools for such common tasks as calibration, parameter estimation and sensitivity analysis. In this paper, we describe MODCOM, a software framework that facilitates the assembly of simulation models from previously and independently developed component models. MODCOM also facilitates the development of generic tools because simulation models can be accessed through a single interface.

### Methodology

An overview of the most important MODCOM classes is given in Figure 1. A MODCOM simulation consists of one or more components that each implement a model of a part of the whole system. A MODCOM simulation is driven by events that are scheduled to occur at a certain time. Simulation objects respond to events in a way that makes sense to them. For example, integrator objects (objects that implement *IIntegrator*) perform an integration step. Events are implemented as classes and thus can encapsulate arbitrary amounts of information. This makes it possible that a crop object responds to “Harvest” events, for example by reducing its biomass; and that a soil object responds to “Tillage” events that carry information about the implement used and the depth of the tillage (Donatelli and Van Evert, 2006). The event list is flexible: new events can be added while a simulation is in progress, while events scheduled but not yet handled can be removed. Thus, an integration object may schedule additional integration events if the time step of numerical integration must be changed; and a farm management object may schedule irrigation events in response to soil water status.

MODCOM fully supports both time and state events, using iteration to execute the state event within specified bounds of precision (Fig. 2).

From the above it is clear that MODCOM is basically a DEVS implementation (Zeigler et al., 2000). But MODCOM differs from most other DEVS implementations in that it offers special support for differential-equation based models. This support is provided through the *IIntegrator* interface.

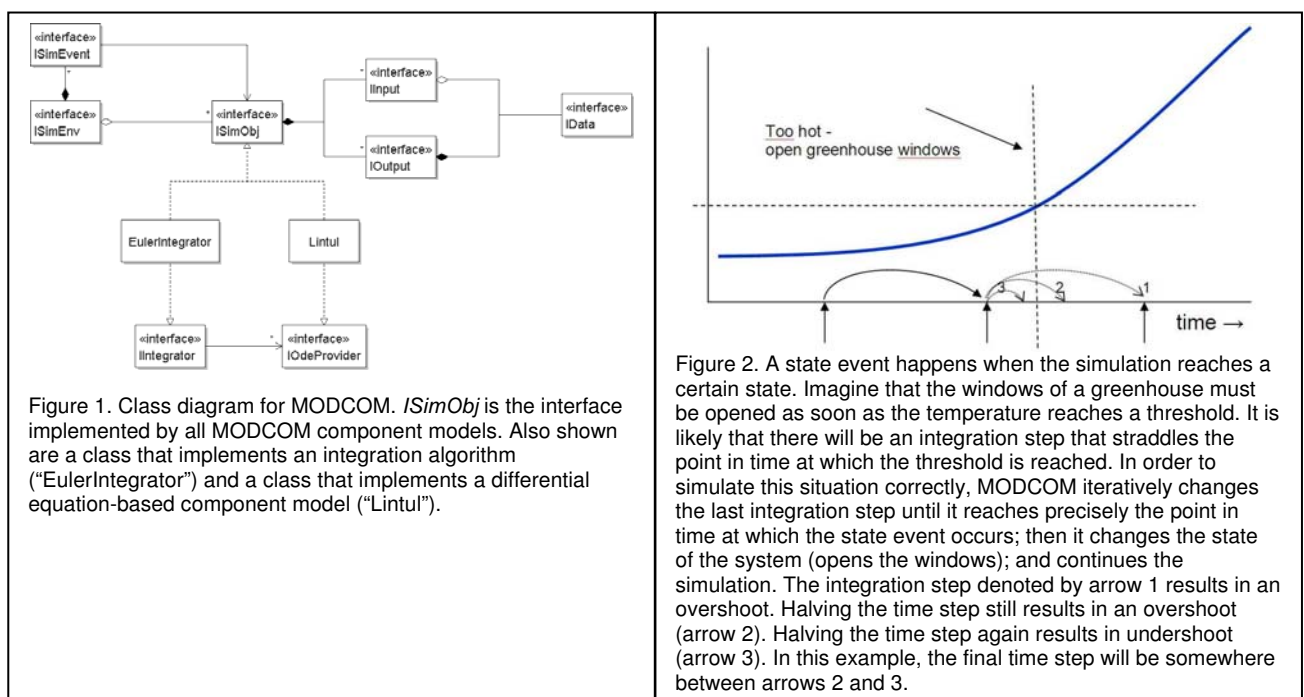

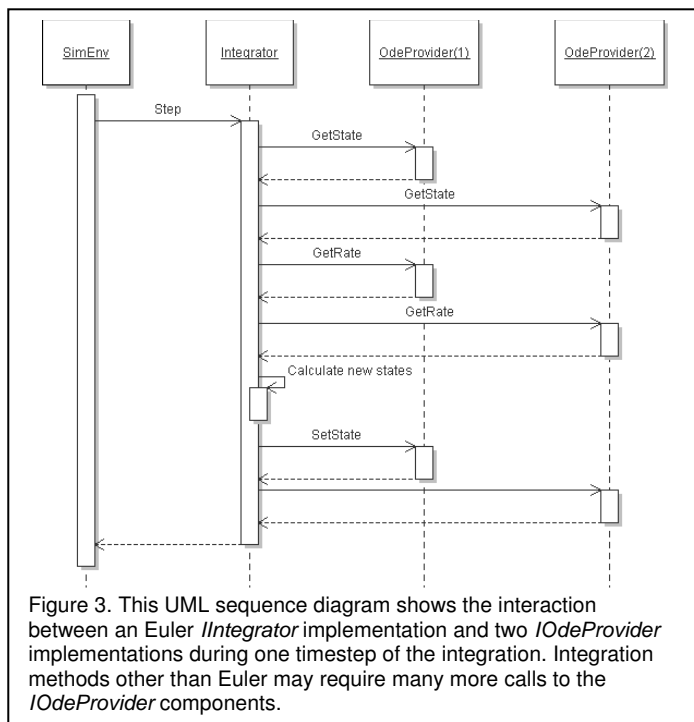

Components that implement this interface can be used to perform numerical integration of components that implement the *OdeProvider* interface (Fig. 3). Because MODCOM numerical integrators are implemented as components, users can write their own integrators and use these instead of or in addition to the integrators provided with the framework.

### Results

Development of MODCOM started with an international workshop held in Wageningen in 2000. A version written in C++ and using Microsoft COM was made available in 2001 (Hillyer et al., 2003). A .NET version was made available in 2004; using Mono ([www.mono-project.com](http://www.mono-project.com)) this version runs under Linux as well as under Windows. With a compiled size of only 88 kB, MODCOM is extremely light-weight.

Despite this small size, it has been proven

to be more than adequate in a number of projects. Currently, MODCOM is in use to develop the dairy farm model FARMMIN (Van Evert et al., 2007); to develop the cropping systems model APES for the EU FP6 SEAMLESS project ([www.seamless-ip.org](http://www.seamless-ip.org)); and to write a new version of the greenhouse crop growth model Intkam (Marcelis et al., 2000). In addition, we are implementing a set of parameter estimation routines for MODCOM models (Wallach et al., 2006).

### Conclusions

MODCOM is a light-weight simulation framework. It offers connectivity, time and state events, and numerical integration. It does not offer facilities to express spatial or other semantic relationships between components, nor does it offer facilities to make statements about what kind of model an *ISimObj* implements. But MODCOM imposes no restrictions on relationships between component models or on the formalism used to express its component models. Thus, spatially explicit simulation could be handled via a tool that creates instances of MODCOM components and establishes appropriate links between them, without MODCOM needing to know about these links. Likewise, an *ISimObj* implementation could be based on a stochastic model, on a discrete-event model, or on an agent model, without MODCOM needing to know.

### Acknowledgements

This publication has been partially funded under the SEAMLESS Integrated Project (European Commission, DG Research, contract no. 010036-2).

### References

- Donatelli, M., and F.K. van Evert, 2006. Formalizing expert knowledge for agricultural management simulation: the agromanagement software component. *Bibliotheca Fragmenta Agronomica* 11, 271-272.
- Filippi, J.B., and P. Bisgambiglia, 2004. JDEVS: an implementation of a DEVS based formal framework for environmental modelling. *Environmental Modelling & Software* 19, 261-274.
- Hillyer, C., et al., 2003. The ModCom modular simulation system. *Europ. J. Agronomy* 18, 333-343.
- Marcelis, L.F.M., et al., 2000. Control of crop growth and nutrient supply by the combined use of crop models and plant sensors. *Proc. Int. Conf. Modelling and Control in Agriculture, Horticulture and Post-Harvested Processing IFAC*: 351-356.
- Van Evert, F.K., et al., 2007. Exploring the effect of dairy farm management on soil carbon stocks and greenhouse gas emissions. *NJF Report* 3, 85-86.
- Wallach, D., et al. (eds.) 2006. *Working with dynamic crop models*. Elsevier, Amsterdam.
- Zeigler, B.P. et al., 2000. *Theory of modeling and simulation*. Academic Press, San Diego.

## GENERATION OF ARTIFICIAL CROP ROTATION SCHEMES AS CYCLIC PERMUTATIONS

Ioannis N. Athanasiadis<sup>1</sup>, Andrea E. Rizzoli<sup>1</sup>, Sander Janssen<sup>2</sup> and Martin van Ittersum<sup>2</sup>

<sup>1</sup> Istituto Dalle Molle di Studi sull'Intelligenza Artificiale, Lugano, Switzerland, {andrea.ioannis}@idsia.ch

<sup>2</sup> University of Wageningen, The Netherlands, {sander.janssen,martin.vanittersum}@wur.nl

### Introduction

Farm production planning involves the simulation and evaluation of alternative crop succession schemes, known also as crop rotation cycles. A crop rotation cycle is a sequence of crops that are applied cyclically on the same piece of land. Typically, artificial crop rotation schemes are generated as all possible rearrangements of the available crops that are subsequently filtered with respect to cyclic equivalence and crop succession suitability requirements. Given a set  $C$  of  $n$  crops and a desired length of rotations  $r$ , the traditional approach requires the evaluation of a solution space, sized  $n^r$ . This practice limits the length of rotations to be evaluated as the memory required for storing all crop rearrangements expands exponentially. In this paper, we present an alternative generation algorithm that excludes from the solution space all cyclically equivalent rotations. The algorithm represents each crop rotation cycle as a number in the  $n$ -based numeral system, and is capable of excluding the generation of cyclic equivalent rotations, through a single modulo operation. Two alternatives of the algorithm are presented: The first excludes the cyclic equivalent rotations of the same length (i.e. the maize – fallow – maize rotation is equivalent with the rotation maize – maize – fallow). The second variation of the algorithm also excludes the cyclic equivalent rotations of lesser orders (i.e. the maize – fallow – maize – fallow rotation of length four is equivalent with the rotation maize – fallow of length two).

### Methodology

Let  $C = \{c_0, c_1, \dots, c_{n-1}\}$  be a set of  $n$  crops. A rotation of length  $r$  is an ordered sequence (rearrangement) of  $r$  elements of  $C$ . A rotation can be considered as a permutation with repetition of size  $r$  of the elements of  $C$ . The number of all possible sequences of crops is the number of permutations with repetition and equals to  $n^r$ . In general, each permutation can be identified by a unique sequence of  $r$  digits, which represents an integer number in the  $n$ -base numeral system. The actual value of a sequence of  $r$  digits " $d_r \dots d_k \dots d_2 d_1$ " in the  $n$ -base system is given by the equation:  $i = \sum_{k=1}^r d_k \cdot n^{k-1}$ . As an example, the four-digit sequence 1012 in the 3-base system represents the decimal number  $1 \cdot 3^3 + 0 \cdot 3^2 + 1 \cdot 3^1 + 2 \cdot 3^0 = 27 + 0 + 3 + 2 = 32$ . Note that  $d_k = i \text{ modulo } n^{k-1}$ . In the case of having a set of  $n=3$  crops  $C = \{c_0, c_1, c_2\}$ , and a rotation length  $r=4$ , the all possible permutations with repetition, and their representation in the 3-base numeral system are those illustrated in Table 1.

**Table 1:** Example rotations and their representations in the c-based and decimal numeral system

Rotation	Representation (index) in the 3-base system	Representation (value) in the decimal system
$[c_0, c_0, c_0, c_0]$	0000	0
$[c_0, c_0, c_0, c_1]$	0001	1
$[c_0, c_0, c_0, c_2]$	0002	2
$[c_0, c_0, c_1, c_0]$	0010	3
$[c_0, c_0, c_1, c_1]$	0011	4
$[c_0, c_0, c_1, c_2]$	0012	5
$[c_0, c_0, c_2, c_0]$	0020	6
$[c_0, c_0, c_2, c_1]$	0021	7
$[c_0, c_0, c_2, c_2]$	0022	8
$[c_1, c_0, c_1, c_2]$	1012	32
$[c_2, c_2, c_2, c_2]$	2222	80 = $3^4 - 1$

Let  $C = \{c_0, c_1, \dots, c_{n-1}\}$  be a set of  $n$  crops, and  $r$  be the length of the permutations with repetition to be generated.

Each permutation  $[d_r \dots d_3 d_2 d_1]$  of size  $r$  can be uniquely identified by a single integer  $i = \sum_{k=1}^r d_k \cdot n^{k-1}$ , where  $i \geq 0$ ,

and  $i < n^r$ . Simply, by counting from 0 to  $n^r - 1$  in the  $n$ -base numeral system, all possible permutations with repetition of length  $r$  can be generated. In this way, a simple permutation generator with repetition can be specified, as a simple counter from 0 to  $n^r - 1$ . However, for generating artificial crop rotation schemes, we need to produce all **cyclic** permutations with repetition. This means that in the abovementioned example, the rotation  $\{12\}: [c_0, c_1, c_1, c_0]$  is equivalent with the rotation  $\{4\}: [c_0, c_0, c_1, c_1]$ , thus one of the two needs to be excluded from generation. We underline that every sequence of  $r$  digits  $[d_r \dots d_3 d_2 d_1]$  has at most  $r-1$  cyclic equivalents, which can be produced by applying a shift function  $r-1$  times, and they are:  $\{[d_{r-1} \dots d_3 d_2 d_1 d_r], [d_{r-2} \dots d_3 d_2 d_1 d_r d_{r-1}], \dots [d_1 d_r \dots d_3 d_2]\}$ . Note that the index of the sequence  $[d_r \dots d_3 d_2 d_1]$  is  $i = \sum_{k=1}^r d_k \cdot n^{k-1}$ . The index of

the  $m$ -th cyclic equivalent is given by the form:  $i_m = \sum_{k=1}^r d_{k-m} \cdot n^{k-1}$ , where  $m = 1 \dots r$ .

Based on this remark, a generator of **cyclic permutations with repetition** can be defined as follows: Let  $C$  be a set of crops of size  $n$ , and  $r$  be the rotation length, then each permutation with repetition can be uniquely identified by a single integer  $i$ , where  $i \geq 0$ , and  $i < n^r$ . This rotation has (at most)  $r$  cyclic equivalents, with index  $i_m$ , where  $m=1 \dots r$ . Based on the above, the generation of cyclic permutations with repetition can be achieved as follows:

**Algorithm I: Exclude the cyclic equivalents of the same order**

For  $i \in [0, n^r)$ , that represents a candidate rotation, check if there is at least one  $i_m$ , for  $m=[1,r]$ , such as  $i_m < i$ . If this condition is true, then there is at least one cyclic equivalent rotation of the same length generated for for an  $i'$  value smaller than the current  $i$ . Therefore the current rotation with id  $i$  should be skipped. Else consider  $i$  as a rotation for which no cyclic equivalent has been produced before.

**Algorithm II: Exclude the cyclic equivalents of the same or lesser orders**

For each  $i \in [0, n^r)$  evaluate if there is at least one  $i_m$  for  $m=[1,r]$ , such as  $i_m(m) \leq i$ . (The difference with the previous case is the equality condition). If this condition is true then there is at least one cyclic equivalent permutation of the same or lesser length has been already generated, thus do not consider the candidate rotation  $i$ . Else, generate  $i$  as a rotation for which no other cyclic rotation generated of the same or lesser order.

## Results

This paper demonstrated how cyclic equivalent crop rotations could be excluded at generation phase, which affects significantly the volume of the problem space upon which crop succession suitability requirements filters need to be applied. The following table presents the size of all rotations to be evaluated for number of crops  $c=2 \dots 9$  and for rotation length  $r=2 \dots 9$ , for all three cases: the conventional methods, that generates all permutations, and the two variations of the algorithm above (case 1 and case 2). By excluding from the solution space at generation time the cyclic equivalent rotations, the solution space is reduced up to by 90% (i.e. in the case of 8 crops and rotation length equal to 9 instead of more than 134 million rotations, it is sufficient to evaluate less than 15 million alternatives, as the rest 120 millions are cyclic equivalents). It becomes apparent that the proposed method reduces significantly the volume of the alternatives to be evaluated.

The application of agronomic suitability filters remains the same with the current approach as with the conventional ones. However, the volume of solution space is drastically reduced.

**Table 2:** Comparison of the solution space volume for the conventional method and the new two algorithms. Presented for various values of crop set size ( $c$ ) and desired rotation length ( $r$ )

$c$	$r$	CONV ( $n^r$ )	CASE 1	CASE 2	$c$	$r$	CONV ( $n^r$ )	CASE 1	CASE 2
2	2	4	3	1	6	2	36	21	15
2	3	8	4	2	6	3	216	76	70
2	4	16	6	3	6	4	1,296	336	315
2	5	32	8	6	6	5	7,776	1,560	1,554
2	6	64	14	9	6	6	46,656	7,826	7,735
2	7	128	20	18	6	7	279,936	39,996	39,990
2	8	256	36	30	6	8	1,679,616	210,126	209,790
2	9	512	60	56	6	9	10,077,696	1,119,796	1,119,720
3	2	9	6	3	7	2	49	28	21
3	3	27	11	8	7	3	343	119	112
3	4	81	24	18	7	4	2,401	616	588
3	5	243	51	48	7	5	16,807	3,367	3,360
3	6	729	130	116	7	6	117,649	19,684	19,544
3	7	2,187	315	312	7	7	823,543	117,655	117,648
3	8	6,561	834	810	7	8	5,764,801	720,916	720,300
3	9	19,683	2,195	2,184	7	9	40,353,607	4,483,815	4,483,696
4	2	16	10	6	8	2	64	36	28
4	3	64	24	20	8	3	512	176	168
4	4	256	70	60	8	4	4,096	1,044	1,008
4	5	1,024	208	204	8	5	32,768	6,560	6,552
4	6	4,096	700	670	8	6	262,144	43,800	43,596
4	7	16,384	2,344	2,340	8	7	2,097,152	299,600	299,592
4	8	65,536	8,230	8,160	8	8	16,777,216	2,097,684	2,096,640
4	9	262,144	29,144	29,120	8	9	134,217,728	14,913,200	14,913,024
5	2	25	15	10	9	2	81	45	36
5	3	125	45	40	9	3	729	249	240
5	4	625	165	150	9	4	6,561	1,665	1,620
5	5	3,125	629	624	9	5	59,049	11,817	11,808
5	6	15,625	2,635	2,580	9	6	531,441	88,725	88,440
5	7	78,125	11,165	11,160	9	7	4,782,969	683,289	683,280
5	8	390,625	48,915	48,750	9	8	43,046,721	5,381,685	5,380,020
5	9	1,953,125	217,045	217,000	9	9	387,420,489	43,046,889	43,046,640

### Acknowledgement

The work presented in this publication is funded by the SEAMLESS integrated project, EU 6th Framework Programme.

### Bibliography

- D. Knuth, Permutations and Factorials, 1997. The art of computer programming, 3<sup>rd</sup> edition, 45-50.  
 R. Sedgewick, Permutation Generation Methods, 1977. ACM Computing Surveys. 9, 137-164.  
 S. Dogliotti, W. Rossing, M. van Ittersum. ROTAT, a tool for systematically generating crop rotations, 2003. European Journal of Agronomy. 19, 239-250.  
 W.K.Haneveld, A. Stegeman. Crop succession requirements in agricultural production planning, 2005. European Journal of Operational Research. 166, 406-429.  
 N. K. Detlefsen, A.L. Jensen. Modelling optimal crop sequences using network flows, 2007. Agricultural Systems. 94, 566-572.

## A GENERIC MATHEMATICAL PROGRAMMING MODEL (FSSIM-MP) FOR FARMING SYSTEMS ANALYSIS

K. Louhichi<sup>1</sup>, G. Flichman<sup>1</sup>, M. Blanco Fonseca<sup>2</sup>

<sup>1</sup> Mediterranean Agronomic Institute of Montpellier, France, [louhichi@iamm.fr](mailto:louhichi@iamm.fr) ; [flichman@iamm.fr](mailto:flichman@iamm.fr)

<sup>2</sup> Universidad Politécnica de Madrid, Madrid, Spain, [maria.blanco@upm.es](mailto:maria.blanco@upm.es)

### Introduction

The purpose of this paper is to describe the modular structure of a mathematical programming model (FSSIM-MP) developed, within the EU FP6 SEAMLESS project, to assess at farm level the economic and ecological impacts of agricultural and environmental policies and technological innovations. Developed in GAMS (General Algebraic Modelling System) software, FSSIM-MP seeks to describe the behaviour of the farmer given a set of biophysical, socio-economic and policy constraints and to predict farmer's reactions to technology, policy and market changes. FSSIM-MP is developed as a generic model in order to be applicable to every type of arable farming system in the European Union, easily transferable between different geographic locations, reusable and with a rich usability.

### Model specification

In agricultural economic research, a wide range of farm level models are used to assess the implications of market or policy changes at the level of the individual farm. However, the development of these farm models is often characterized by poor transferability and reusability, lack of quality assessment and poor usability (Janssen and Van Ittersum, 2007). To tackle these problems within the SEAMLESS project, a generic and modular model has been developed. Named FSSIM-MP (i.e. Farm System Simulator-mathematical programming model), this model consists of a non-linear programming model calibrated at the farm level. FSSIM-MP is linked in the SEAMLESS project to an agricultural management module (FSSIM-AM), which aims to describe or generate current and alternative activities and quantifies their input-output coefficients (both yields and environmental effects) (Louhichi et al, 2006). Once the potential activities have been generated, FSSIM-MP chooses those that best fit the farmer's objectives, given the set of resource, technological and political constraints.

FSSIM-MP is (i) a static model with a limited number of variants depending on the farm types and conditions to be simulated. Nevertheless, for incorporating some temporal effects, agricultural activities can be defined as "crop rotations" and "dressed animal" instead of individual crops and animals; (ii) a risk programming model with a basic specification relating to the Mean-Standard deviation method in which expected utility is defined under two arguments: expected income and risk; (iii) a positive model in the sense that its empirical applications exploit the observed behaviour of economic agents and where the main objective is to reproduce the observed production situation as precisely as possible; (iv) a generic and a modular system designed with the aim to be easily applied to different regions and conditions.

The general structure of FSSIM-MP model is formulated as follows:

$$\text{Maximise: } U = p'x + s'x - c'(x)x - k - \phi\sigma$$

$$\text{Subject to: } Ax \leq B; x \geq 0$$

Where: **U** is the variable to be maximised, **P** (n x 1) vector of gross revenue of each agricultural activity, **C** (x) vector of accounting costs per unit for each agricultural activity (depending on calibration approaches), **S** (n x 1) vector of subsidies per unit for each agricultural activity (depending on the Common Market Organisations (CMOs)), **X** (n x 1) vector of agricultural activities' level, **K** represents fixed costs (including annuity for investment), **A** (m x n) matrix of technical coefficients, **B** (m x 1) vector of available resource levels, **Φ** scalar of the risk aversion coefficient, **σ** variable representing the standard deviation of income according to states of nature defined under two different sources of variation: yield -due to climatic conditions- and prices.

The principal outputs generated from FSSIM-MP model are land use, production, input use, farm income and environmental effects of the farm type for a specific policy.

### Model structure and components

FSSIM-MP includes several modules namely crops, livestock, investment, premium, Positive Mathematical Programming (PMP), risk and policy which are solved simultaneously. These modules are linked indirectly by an integrative module involving the objective function and the common constraints (Figure 1). Each module includes two GAMS files. The first one links the database and the module's equations and the second file contains the module's equations. Each module generates at least one variable which is used to define the common module's equations.

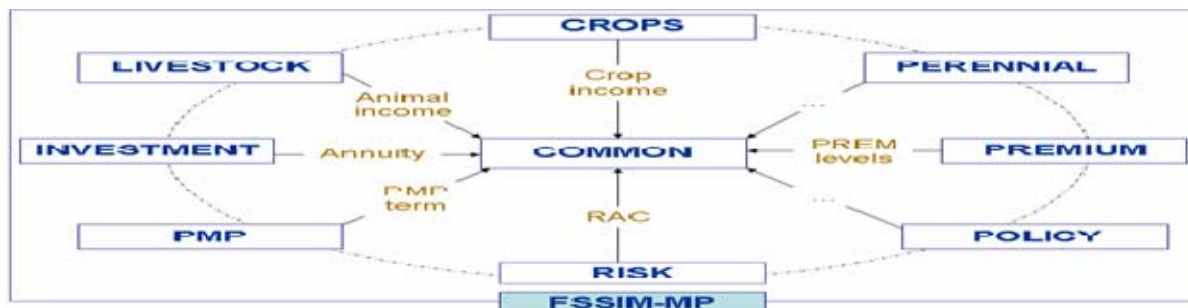

**Figure 1.** FSSIM-MP structure: modularity system

Thanks to this modularity, FSSIM-MP provides the capabilities to add and delete modules (and their corresponding constraints) following the needs of the simulation, to select one or several calibration approaches between different options (risk, Monte Carlo, standard PMP, Rhöm and Dabbert PMP approach...) and to control the flow of data between database and software tools. FSSIM-MP has also the advantage to read input data stored in any relational databases or in Excel or in GAMS include files... providing that they are structured in the required format. Agricultural activities used in FSSIM-MP can be defined as individual crops or as "crop rotations" according to data availability.

In order to make all FSSIM-MP components easier to use a graphical user interface (GUI) was developed. This GUI assists the user in setting up scenarios, running the simulations and storing and reading the output data.

### Results of model application

This model was tested for a set of farms representing the arable farming systems in two European regions (Flevoland (Netherlands) and Midi-Pyrénées (France)) and also in Mali in order to analyse the current situation and anticipate the impact of new alternative scenarios. An example of these results is shown in Table 1 (Louhichi and Belhouchette unpublished).

**Table 1:** FSSIM-MP outputs for farm types in Midi-Pyrénées

	Farm Type 1			Farm Type 2		
	Baseyear [2001]	Reference run [2013]	Scenario1 [2013]	Baseyear [2001]	Reference run [2013]	Scenario1 [2013]
Farm income (k€)	76.8	61.5	57.9	76.3	64.7	61.7
		-20%	-6%		-15%	-5%
Nitrate leaching (kg/ha)	8	9	9	9	10	10
		9%	1%		13%	2%

### Acknowledgement

The work presented in this publication is funded by the SEAMLESS integrated project, EU 6th Framework Programme. More details about FSSIM-MP are available in SEAMLESS website [www.seamless-ip.org](http://www.seamless-ip.org) but the model itself is not available for distribution.

### References

- Louhichi et al. A first version of FSSIM for the arable farming sector to be used within Prototype 1 of SEAMLESS-IF, 2006. SEAMLESS report n° 5, [www.seamless-ip.org](http://www.seamless-ip.org).
- Janssen, S., van Ittersum, M.K. Assessing farm innovations and responses to policies: A review of bio-economic farm models. *Agricultural Systems*, 94, 622-636, 2007.



## MULTISCALE ENVIRONMENTAL SUSTAINABILITY MODELLING IN LARGE IRRIGATION SYSTEMS

S. Khan<sup>1</sup>, J. Mu<sup>2</sup>

<sup>1</sup> International Centre of WATER for Food Security, Charles Sturt University,  
& Cooperative Research Centre for Irrigation Futures, Australia, [skhan@csu.edu.au](mailto:skhan@csu.edu.au)

<sup>2</sup> International Centre of WATER for Food Security, Charles Sturt University, Australia, [jmu@csu.edu.au](mailto:jmu@csu.edu.au)

### Introduction

Unsustainable land and water management practices that violate the system's carrying capacity constraint over long periods can impose significant costs in terms of lost opportunities in farm production and regional development, by causing waterlogging and salinity. To deal with these issues a number of farming policies aimed at achieving long term environmental sustainability of irrigated agriculture have been introduced in southern Australia. These policies include concepts such as rice suitable land, maximum rice water use and limits on the area under rice. Simulation of the various hydrologic and economic conditions of different irrigation areas under these management policies requires the development of a generalised hydrologic economic framework, which are then customised to area specific conditions. The generalised frameworks should be able to upscale and integrate the results of field scale hydrologic and economic processes from the field to the farm, sub-district and irrigation area levels. This paper describes application of a generalised hydrologic economic framework SWAGMAN (Salt Water and Groundwater MANagement). This modelling framework is currently being used to develop management policies in irrigation areas in southern Australia. With the objective to maximise economic returns, model results show that watertable and salinity below a farm can be managed by proper selection of areas of recharging and discharging crops. Results of regional hydrologic economic models suggest that policies aimed at sustainable development of rice farming systems must also consider waterlogging and salinity effects in non-rice areas. The SWAGMAN platform has highlighted the importance of considering groundwater discharge and recharge zones in and around an irrigation area.

### Methodology

In order to achieve environmental targets irrigation communities of the Murray-Darling Basin in Australia are implementing on farm and regional management actions such as:

- Best management practices e.g. bench marking irrigation levels
- On-farm activities e.g. laser levelling, whole farm plans, reducing net recharge from crops on given farms, recycling drainage waters, installing spear point and deep wells
- Regional activities e.g. lining of earthen channels to reduce seepage, installation of community wells, evaporation basins and improving surface drainage

Innovative hydrologic research in partnership with growers and irrigation companies has shaped strategic planning and policy development for environmentally sustainable and economically viable management options in major irrigation areas. Integrated hydrologic, economic, agricultural, and environmental models called SWAGMAN (Salt WATER and Groundwater MANagement) modeling platform, which includes salient features and applications of a detailed process based model (SWAGMAN Destiny), a lumped hydrologic economic model (SWAGMAN Farm) and a distributed biophysical model (SWAGSIM) are used to evaluate the impacts of a range of on-farm interventions on farm income and environmental sustainability (Khan et al, 2003). The models are capable of providing a good understanding of the complex interactions between crop, soil, water, salts and shallow watertable dynamics at point, paddock, farm, sub-irrigation, and irrigation area scales. This paper describes applications of a farm scale hydrologic economic framework SWAGMAN Farm to help guide whole farm water balance and net recharge options for environmental management. SWAGMAN Farm is a lumped water and salt balance model which integrates agronomic, climatic, irrigation, hydrogeological, and economic aspects of irrigated

agriculture under shallow watertable conditions at a farm scale (Khan et al., 2007). This model has been used to develop management concepts such as “net recharge management for control of shallow watertables” which focuses on managing the component of recharge greater than the vertical and lateral regional groundwater flow. It can simulate the effects of growing a certain crop mix on shallow watertable and soil salinity or it can compute an optimum mix of crops for which the watertable rise and soil salinity remain within the allowable constraints for given hydro-climatic conditions.

## Results

A case study using the simulation mode for a hypothetical irrigated farm in the Southern Murray Darling Basin is presented here to show how a dialogue between a farmer and environmental office is started on the basis of existing practices. The total area of the farm is 220 ha with 50 ha of Self Mulching Clays (SMC), 60 ha of Non Self Mulching Clays (NSMC), 80 ha of Red Brown Earths (RBE), 30 ha of sands. The depth to the watertable under the farm is 3.0 m and salinity of the groundwater is 4 dS/m. The total water allocation of the farm is 1400 ML (1 ML=100 mm/ha). The leakage rate under the farm is 0.2 ML/ha per year. The salinity of irrigation water is 0.15 dS/m and salinity of rainfall is 0.01 dS/m. Initial soil water content under the farm is assumed to be 30% (by volume) for all soil types. Average climatic conditions with annual rainfall of 346 mm and 1779 mm of reference evapotranspiration are assumed. The farm annual gross margin is \$90,556. Due to higher gross margins, rice is the most financially attractive land use but its maximum area is restricted due to the constraint on watertable rise. The irrigation application for rice is assumed to be 12 ML/ha, 9 ML/ha for maize, 7 ML/ha for sunflower, 3.5 ML/ha for fababean, 4 ML/ha for canola and 2 ML/ha for barley. The farm rice area in this case is contributing an overall recharge of 37 ML and maize contributes 11 ML/ha whereas irrigated sunflower, canola, barley, and fallow are discharging land uses with individual discharges of 10 ML, 2 ML, 2 ML and 8 ML respectively. The capillary upflow under the farm is zero as the watertable is 3 m deep. The overall rise of watertable is 0.06 m. In this case the farmer is not causing excess recharge but if the farmer increases the area of rice or irrigation levels, corresponding recharge levels are identified and corrective actions such as improved irrigation efficiency or alternative cropping mixes are discussed with the farmer. The following table shows a summary of the salt balance for the farm. The net increase in salts in the soil above the watertable is 87 tonnes. Recharge under the rice area during the irrigation and fallow periods partly remove (leach) the salt brought in by irrigation and capillary upflow.

Salt balance for the example farm (all values in tonnes of salt)				
Irrigation Salt	Rainfall Salt	Capillary Upflow Salts	Total Salt Removed	Salt change in the root zone
133	5	0	51	87

## Conclusions

The results show that policies such as restrictions on area under certain crops, and tradable groundwater recharge/salinity credits both offer higher total gross margin and net present value than the business as usual scenario, specifically in the long run—a win win options for the farmers and the environment. Sensitivity features included in SWAGMAN modeling platform have helped promote awareness of critical parameters influencing the model results, and have highlighted where effort needs to be expended in determining those parameters that will improve confidence in the model results.

## References

- S. Khan et al. Hydrologic-economic model for managing irrigation intensity in irrigation areas for watertable and soil salinity targets. *Environmental Modeling and Assessment* (2007). <http://dx.doi.org/10.1007/s10666-006-9081-3>.
- S. Khan et al, Salt, Water and Groundwater Management Models to Determine Sustainable Cropping Patterns in Shallow Saline Groundwater Regions –*Journal of Crop Production* (2003): 325-340.

## A SOFTWARE COMPONENT TO SIMULATE AGROCHEMICALS FATE

M. Trevisan<sup>1</sup>, A. Sorce<sup>2</sup>, M. Balderacchi<sup>1</sup>, A. Di Guardo<sup>2</sup>

<sup>1</sup> Istituto di Chimica Agraria ed Ambientale, Università Cattolica del Sacro Cuore, Piacenza, Italia  
[marco.trevisan@unicatt.it](mailto:marco.trevisan@unicatt.it), [matteo.balderacchi@unicatt.it](mailto:matteo.balderacchi@unicatt.it)

<sup>2</sup> Informatica Ambientale S.r.l., Milano, Italia, [sorce@iambientale.it](mailto:sorce@iambientale.it), [diguardo@iambientale.it](mailto:diguardo@iambientale.it)

### Introduction

The use of leaching models to predict the fate of pesticides started in the seventies, and the EU directive 414/91 promotes their use in the registration process with the support of FOCUS (FORum for Co-ordination of pesticide fate models and their USE, 2000). These models produce repeatable and comparable results, nevertheless they are implemented in closed applications and their source code is not easily available consequently creating problems for their reuse.

A pesticide model which can be used to analyze the externalities associated with the application of agrochemicals in agricultural contexts requires the following characteristic:

- a modular software architecture,
- a standardized way of communication with other models,
- ease of use as result of both transparency and of software design.

The objective of this paper is to present a software component matching the requirements above.

### The model implemented

The AgroChemicals component is a one-dimensional model that simulates the pesticide fate at field scale using a daily time step.

The model considers four environmental compartments where the pesticide can be found:

- **air:** where drift and plant interception occurs;
- **canopy surface:** where pesticides deposit on branches, leaves, fruits, shoots and green parts (hence the part of the plant above the ground);
- **crop:** agrochemicals storage and transformation inside the plant;
- **soil,** agrochemical processes relevant for agrochemicals fate subdivided as:
  - **available fraction:** the pesticide quantity which can move and can be transformed by biotic processes;
  - **soil aged fraction:** the pesticide trapped within soil micro pores and organic matter and not available for transformation;
  - **soil bound fraction:** the pesticide fraction that can not be extracted from the soil without altering its physical-chemical structure and therefore not available for transformation.

However, for specific modeling purposes, not all the compartments must be modeled (for instance, bound and aged fractions can be excluded).

The AgroChemicals component is targeted at use in systems which simulate crop-soil interactions. A database which can be helpful in simulating pesticide applications as agro-management actions, was developed with the main pesticide properties (i.e. water solubility,  $K_{oc}$ , half life in soil, vapour pressure, etc.) and the relationship between crop and pesticide application. Furthermore, it needs inputs from other compartments, such as:

- soil water content and soil fluxes between layers, and soil temperature. Also, the amount of water which infiltrates the soil is needed;
- size of the field and thickness of soil layers, assuming that the soil profile is discretized into layers, and the soil properties (e.g. bulk density);
- plant phenological stages, and leaf area index;
- rainfall events;
- irrigation and pesticide applications.

Such inputs can be provided by other model components of the simulation system. The AgroChemicals output usually of the greatest importance are: amount of pesticide lost due to drift, amount of pesticide volatilized, amount of pesticide lost due to run off, amount of pesticide flown to the drain system when present, amount of pesticide leached and amount of pesticide remaining in the soil profile.

As indicated in FOCUS rules, simulation for each compound must be carried out for at least 20 years for annual applications, following a 6 years run to make stable the calculations. The Agrochemicals component can easily follow these and other similar procedure since it is a stateless component and thus it does not keep values of variables between calls. Leachate quantity is calculated either at 1 meter depth from the soil surface (as required by the EU procedure) or at the bottom of soil profile or accordingly to user needs. For surface water the peak values of runoff could be used instead of cumulated values.

### The software component

The AgroChemicals component is a Microsoft .NET framework assembly containing several units of modeling entities called strategies. The design patterns strategy allows offering to the user of the component different models (one or more algorithms) by encapsulating each of them in one or more classes, providing different ways to calculate one or more output variables. A strategy can be simple or composite (the latter is a class associated to simple strategies, which is an implementation of the Façade design pattern). A way to define the ontology for strategies used in biophysical systems has been carried out by the EU SEAMLESS project (Donatelli & Rizzoli, 2007), which provides some guidelines to develop non-framework specific components such as the one presented in this paper. The first use of it was inside the APES/Modcom environment, a modular modeling system to simulate plant production and system externalities.

As mentioned above, the AgroChemicals component is stateless. According to the software design mentioned, the component has a class which serves as the API, and which offers two overloads of the calculation method. The methods use the currently selected strategy to produce the output data and one of them performs a test on the input (i.e. a pre-conditions test) and output (i.e. a post-condition test) variables validity.

The main strategy, named `ClsStrategyDefault`, is a composite one which uses 4 simple strategies, related to the 4 environmental compartments in which the model was split:

- **Air** models the processes that happen before the product reaches the soil;
- **Crop** simulates only the plant mass balance, although in this first prototype plant is only a sink of pesticide;
- **Canopy** simulates the processes that happen on the leaf surface;
- **Soil** models the pesticide transport along the soil profiles. Soil profile had to split in discrete layers in which the top and the bottom layers use different models compared to the central layers, due to the different boundary conditions.

Active ingredient properties (such as  $k_{oc}$ , DT50, molecular weight) are stored in an XML file for manageability and easiness of use. The attributes of chemicals can be easily reviewed and modified using a format of the generic Model Parameter Editor as described by Di Guardo et al. (2007).

### Conclusions

The AgroChemicals component is a first attempt to share knowledge in an operational way via a software component with semantically rich interfaces, which implements a modular structure to allow for extensibility. It can be used to add to simulation systems the possibility to integrate estimates of pesticide fate. The help of the component is at:

<http://www.apesimulator.it/help/models/agrochemicals/>

The work presented in this publication is partially funded by the SEAMLESS integrated project, EU 6th Framework Programme.

### References

- FOCUS, 2000, FOCUS Groundwater scenarios in the EU plant protection product review process. Report of the FOCUS Groundwater Scenarios Workgroup, EC Document Reference Sanco/321/2000, 197 pp.
- M. Donatelli, A. Rizzoli, A design for framework-independent model components of biophysical systems, 2007, *These proc.*
- A. Di Guardo et al., Two framework-independent components for applications to simulate biophysical systems, 2007, *These proc.*

**Session 2.7:  
Mechanistic models and expert knowledge: how  
to integrate?**

**Session Convenors:  
Carlo Giupponi, Mike Rivington and Pier Paolo  
Roggero**

## INTEGRATION OF MODELLING AND PARTICIPATORY APPROACHES IN THE REORGANISATION OF IRRIGATION IN THE PIAVE RIVER BASIN (ITALY)

C. Giupponi<sup>1</sup>, G.M. Bazzani<sup>2</sup>, M. Tamaro<sup>3</sup>

<sup>1</sup> Università degli Studi di Milano and Fondazione Eni Enrico Mattei, Italy (carlo.giupponi@unimi.it)

<sup>2</sup> Consiglio Nazionale delle Ricerche - IBIMET, Bologna, Italy (G.Bazzani@ibimet.cnr.it)

<sup>3</sup> Consorzio di Bonifica Destra Piave, Treviso, Italy (tamaro@destrapiave.it)

### Introduction

European agriculture is experiencing a period of substantial reorganisation under the effects of the evolving socio-economic and market drivers, as a consequence of the policy reforms in both agriculture and water sectors: the Mid Term Reform (MTR) of the Common Agricultural Policy and the Water Framework Directive (WFD). While water policy has a clear environmental goal “the good environmental status of the resource” agricultural policy has very different ones. The two policies interact at farm level, where decisions on *what* and *how* to produce are taken by many independent actors, the farmers, who are also influenced by the macro-economic conditions prevailing in the agricultural markets.

The conjoint analysis of both policies is essential to addresses major questions regarding the management of land and water resources at local level.

Water is one of the main agricultural production factors in Italy and irrigation management is therefore a main issue. The work briefly reported here refers to a case study in which a research team has supported a decision process about the reorganisation of the irrigation systems, within the contexts of the innovative principles of the WFD and of the MTR. The investigated area is located in the Piave River Basin in Italy and the research has been developed within the framework of the EU-MEDA project ISIIIMM. In particular, the project was aimed at assessing future trends in agricultural income and employment, water demand, and environmental pressures under different scenarios, focussing on the sustainability analysis of current and planned irrigation systems, i.e. gravitational furrow irrigation vs. pressurised sprinkler irrigation.

### Methodology

The integrated approach adopted for the ISIIIMM falls within the NetSyMoD methodology (Network Analysis – Creative System Modelling – Decision Support; Giupponi et al., 2006). NetSyMoD is a flexible and comprehensive methodological framework, which uses a suite of ICT (Information and Communication Technology) tools, aimed at facilitating the involvement of stakeholders or experts in policy- or decision-making processes which can be formalised as a sequence of six main phases: (i) Actors analysis; (ii) Problem analysis; (iii) Creative System Modelling; (iv) DSS design; (v) Analysis of Options; and (vi) Action taking and monitoring. The approach adopted for the ISIIIMM case includes two main stages.

- First a qualitative analysis is provided in a participatory modelling context, with the participation of the main local stakeholders with the aim to identify the various visions and preferences about the problem, analyse the possible future scenarios and collect qualitative information to obtain a shared cognitive model of the territorial system;
- In a second stage a quantitative analysis is carried out through bio-economic models, providing insights in farmers' behaviour and response via mathematical programming models. In particular, simulation techniques implemented via bio-economic models combining the DSIRR software, for whole farm simulation of farmers' behaviour (Bazzani, 2006), with other tools, such as the cropping system

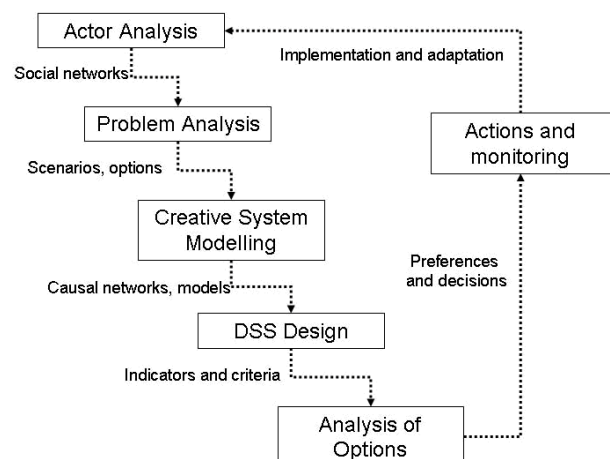

Fig. 1 The main phases of the NetSyMoD approach.

simulator Cropsyst (Stöckle et al., 2003).

In both steps the analyses culminated with the ranking of alternative options by means of multi-criteria analysis through the mDSS software (Giupponi, 2007).

## Results

The combination of the two steps allowed to:

- develop and share with stakeholders scenarios of local futures;
- elicit knowledge and opinions about the proposed irrigation plan;
- integrate opinions and preferences with bio-economic modelling within the same conceptual model in different future scenarios (Uncontrolled urbanisation; Rural development; Environmental sustainability);
- assess the sustainability of current and proposed irrigation systems by combining qualitative local knowledge and preferences with up-to-date mathematical and simulation tools (see example in Fig.2).

As a result of the decision process evidences were acquired about:

1. a common agreement about the need to introduce water saving measures in agriculture, independently from the evolution of the local socio-environmental system;
2. a general pessimism about the future of agriculture in the area, but the multifunctional role of farming and irrigation has been highlighted;
3. the opportunity to integrate the use of water for irrigation with other expanding uses, in particular garden watering in peri-urban areas, within the same pressurised distribution systems.

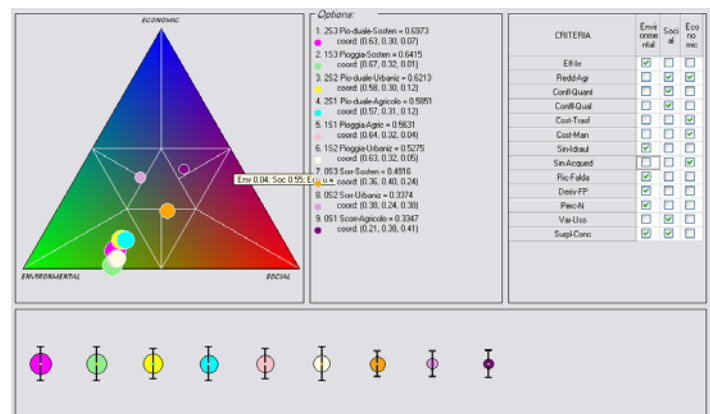

Fig. 2 mDSS: sustainability analysis of the alternative options.

## Conclusions

The results of the case study can offer insights to relevant issues such as: how Integrated Assessment (IA) methods can improve the robustness and transparency of decision making processes; how IA tools can support water managers in their present tasks; how local knowledge and opinions can be integrated with quantitative analyses provided by models; and how different management options can be compared in terms of ecological, economic and social impacts.

The results provided a good ground for the decision to be taken by the Destra Piave Irrigation and Reclamation Board in the coming future and were useful to gain insight into the problem from different perspectives, which may then facilitate the process of decision-making, as well as help to reduce conflicts. On the other hand, it is also evident that the implementation of transparent and scientifically robust decision support methods cannot guarantee that the correct decisions are taken and put in practice, because of the possible opposition of interest groups and lobbies whose power may be significantly limited by approaches similar to the one applied in the ISIIMM case study.

## References

- G.M. Bazzani (2005), An integrated decision support system for irrigation and water policy design: DSIRR. Environmental Modelling and Software, 20, 153-163.
- C. Giupponi (2007). Decision Support Systems for Implementing the European Water Framework Directive: the MULINO approach. Environmental Modelling and Software. 22(2):248-258.
- C.Giupponi, et al.(2006). Network Analysis, Creative System Modelling and Decision Support: The NetSyMoD Approach. FEEM Working Paper. 46-2006:37.
- C.O. Stöckle et al. (2003). CropSyst, a cropping systems simulation model. European Journal of Agronomy, 18, 289 – 307.

## MODELLING THE FARMERS' INFORMATION SYSTEM TO IMPROVE DECISION SUPPORT SYSTEMS

M.A. Magne<sup>1,2</sup>, S. Ingrand<sup>2</sup>, M. Cerf<sup>3</sup>

<sup>1</sup> UMR Tetis, Equipe COPAIN, Cemagref, Clermont-Ferrand, France, [mariemagne@yahoo.fr](mailto:mariemagne@yahoo.fr)

<sup>2</sup> UMR Métafort, Equipe TSE, INRA, Clermont-Ferrand, France, [ingrand@clermont.inra.fr](mailto:ingrand@clermont.inra.fr)

<sup>3</sup> UMR INRA AgroParisTech SAD APT, Paris Grignon, France, [marianne.cerf@agroparistech.fr](mailto:marianne.cerf@agroparistech.fr)

### 1. Introduction

Information is an input required at every step of the decision-making process. The design of Decision Support Systems (DSS) is grounded on the paradigm of information processing in which information is: i) a coded, transmitted and decoded data; ii) a useful data to optimize farm management decisions according to the researchers' viewpoint. One challenge to improve adoption of DSS is to make models as more realistic representations of farming (Solano and *al.*, 2003). Based on an interpretative approach, our study aimed at creating a conceptual model of the farmers' information system which gives account of how and why the farmers choose and use information to master and develop their productive activity and to develop themselves.

### 2. Methodology

#### 2.1. A framework to analyze the diversity of the farmers' informational activity

We focused on the "informational activity", referring to an activity as defined from ergonomics. We analysed how farmers build information as a resource (making sense of information) while acquiring and using this information in a given situation (situated action). To account for this process, we proposed the notion of informational resource which we characterize by 3 components: Support, Origin and Content (SOC). Our conceptual model therefore gives account of a process we called "the mobilization of informational resources". To designed it, we analysed the diversity of the farmers' ways of mobilizing informational resources by using a framework which articulates : i) the stockbreeder; ii) the informational resources; iii) the domains of livestock farming activity (entities which farmers identify as requiring specific informational resources); iv) the management situations (situations for which the farmer mobilizes informational resources).

#### 2.2. Repeated surveys

The follow-up of 9 beef cattle farmers was set up within 3 districts of the Centre of France characterized by different organizations of the advice supply. The farmers were surveyed 3 times over 1.5 year. They were sampled according to their difference in terms of: i) their principles for mobilizing external informational resources (Magne and *al.*, 2005); ii) the change projects they dealt with; iii) the purposes they assigned to either their productive activity or their personal life. The semi-directive interviews rested on a back-and-forth discussion between the recorded farming practices and data on mobilized informational resources. A specific question dealt with the importance the farmers gave to the mastering of the domains of livestock farming activity. Data processing was based on abstraction from case based data to more generic categories and relations which were organized into a model through a systemic approach.

### 3. Results: the structure and the functioning of the model of information system

The model is composed of 2 subsystems the roles of which are respectively to organize and to implement information (Fig1). Each subsystem contains 2 units described below. The structure and the functioning of the whole information system are designed by: i) the categories and their variations in attributes to represent the diversity of the informational activity; ii) some criteria to choose how to instance such attributes ; (iii) relations between categories and subsystems.

#### 3.1. The finalizing unit (organisation subsystem)

It gives direction to the informational activity. It is composed of three elements: i) the domains of livestock farming activity; ii) the purpose ascribes to the mastering and the development of the production ("production finality"); iii) the purpose ascribes to the farmer's development himself ("farmer finality"). Such purposes vary according to domains of livestock farming activity and have to be taken into account to understand the mobilization of the informational resources. We created four criteria to describe the sensitivity of the farmers regarding their need to master given domains of livestock farming activity.



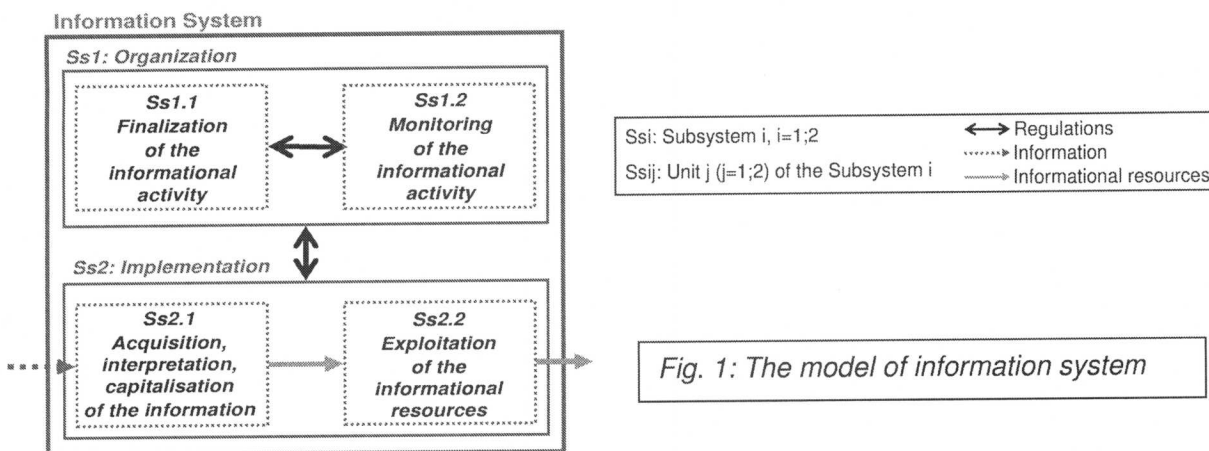

### 3.2. The monitoring unit (organisation subsystem)

It organizes the informational activity on the short term, according to the management situations the farmers meet. It is composed of two elements which characterize such a situation: i) the event which triggers the activity; ii) the function assigned to the informational resources mobilized to face with the situation. Six criteria qualify the farmer's sensitivity to an event and five attributes represent the diversity of functions triggered in a situation. This unit allows then to give account of the way farmers readjust, in a given situation, the direction they assigned to their informational activity.

### 3.3. The acquisition, interpretation and capitalisation unit (implementation subsystem)

It builds the informational resources by making sense of the information. It is composed of 3 elements: i) an informational filter which selects the 3 informational components (SOC), according to 11 criteria which give account of the utility and the usability of the information; ii) a short term informational capital which accumulates in a transitory way the informational resources useful and usable to face with the situation; iii) a long term informational capital which stabilizes informational resources which had been valued as useful and usable.

### 3.4. The exploitation unit (implementation subsystem)

It exploits the informational resources accumulated in the short term informational capital and integrates them in decision-making. Decisions refer to: i) actions i.e. herd management; ii) farm management. In this last case, exploitation refers to an auto-regulation of the information system after the assessment of the informational resources mobilized in a situation or to an exportation of them (e.g.: information for traceability). Three tasks of exploitation were identified to understand how farmers allocate informational resources in a given management situation. These tasks are: the contextualisation, the analysis and the assessment of the informational resources.

## 4. Conclusion

Our conceptual model enables us to describe and understand the diversity of the farmers' informational activity by taking into account both the flow of information and the way farmers make sense of information. We suggest that such a model could be used as a component of bio-decisional models in DSS, to assign information to the decision-making process. The challenge would be then to take into account the diverse farmer's perceptions of the management situations to run the DSS.

## References

- Magne, M.-A., C. Couzy, and S. Ingrand., Comprendre comment les éleveurs de bovin allaitant mobilisent des informations pour concevoir et piloter leur activité d'élevage : distinguer le Support, l'Origine et le Contenu (SOC), 2005, Rencontres, Recherches, Ruminants, 12, 65-68.
- Solano, C., E. Leon, E. Perez, and M. Herrero., The role of personal information sources on decision-making process of Costa Rican dairy farmers, 2003, Agricultural Systems, 76, 3-18.

## FARMERS PARTICIPATION IN DESIGNING A WHOLE FARM MODEL

J. Vayssières<sup>1</sup>, M. Kerdoncuff<sup>2</sup>, P. Lecomte<sup>1</sup>, N. Girard<sup>3</sup>, C.H. Moulin<sup>2</sup>

<sup>1</sup> Cirad, UR SE, Réunion Island, [jonathan.vayssieres@cirad.fr](mailto:jonathan.vayssieres@cirad.fr)

<sup>2</sup> SupAgro, UMR ERRC, Montpellier, France

<sup>3</sup> Inra, UMR AGIR, Toulouse, France

Designed with the participation of six milk farmers (**Fs**), GAMEDE is a Global Activity Model for Evaluating the sustainability of the Dairy Enterprises in Réunion Island. GAMEDE is a Whole Farm Model (**WFM**). By integrating the Fs' decision processes, this simulation model describes the dynamical functioning of biomass flows at farm scale. Based on participative modelling experiences (Walker, 1998; Pahl-Wostl, 2005), the hypothesis was that the six Fs' participation will increase the capacity of the simulator to support farmers' decision. A reflective study, conducted by an external observer (**EO**), aimed to evaluate how GAMEDE has been shaped by Fs' knowledge.

### Methodology

The main designer, a researcher (**R**), has been inquired by the EO to identify key events that have influenced the modelling process. The modelling activity has left traces: meeting reports, conceptual and electronic forms of the WFM, recordings of discussions between the Fs and the R. All those traces have been analysed to build the background history of the modelling project (fig.1).

### Results

The dynamics of the project are described on four aspects: i) the different steps of the model designing, ii) the events of interactions between the Fs and the R, iii) the status of the R according to the Fs' point of view, iv) the modelling objectives.

We can define five steps in the model design: 1) the conceptual modelling that borrows concepts and mathematical functions to models of the literature or, when more pertinent for farmers, proposes original ways to formalise on-field observable processes (e.g. the decision making), 2) the contextualisation of the models of the literature (= setting the models in the case of biophysical models), 3) the computer development of the partial models, 4) the simulation of real scenarios, 5) the validation from Fs' and expert opinion (researchers). This five steps method has been applied to the designing of the six partial biophysical models and the WFM. Contrary to a more classical modelling approach, such as the "Mafate" one (Guerrin, 2007), Fs did not only participate in steps 4 and 5, but also participated in initial steps (1 and 2).

The first year of research was conducted without the participation of the Fs, whereas the rest of the project was conducted with frequent exchanges with the six Fs. Immersions ( in fig.1) in the six farms have developed into a fruitful collaboration between the Fs and the R. The meetings were frequent during three years, including individual meetings six times per year and collective meetings three times per year. For the R, the main objective of those meetings was to show and validate from Fs' knowledge, step by step, the progress of the model design. Initially expected in the research centre, the collective meetings were finally organised in the six surveyed farms as demanded by Fs. Each collective meeting was the occasion for the host farmer to organise a lunch and present his farm. It was a sort of spontaneous Farm Field School (Minjawn *et al.*, 2002).

The status of the R from the Fs' point of view has changed during the modelling project: starting as an inspector he has been progressively recognised as a scientist. This status progression shows that the Fs have placed their trust more and more in R.

The modelling objectives have also changed in contact with Fs. For instance the main objective advanced in the first year was "to evaluate the environmental impact of existing farming systems and to represent impacts of technical innovations (such as composting) on those farming systems". After the immersions, the evaluation of the sustainability was extended to technico-economical and social aspects. The evolution of these objectives led the R to define new components of GAMEDE; Fs were really concerned by timework surplus and economical costs of the technical innovations.

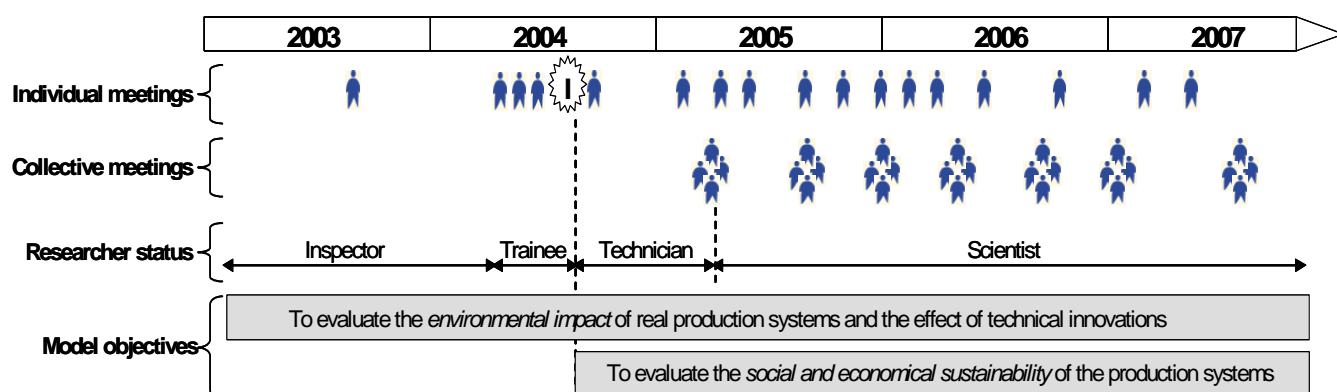

Figure 1. Synthetic background history of the modelling project

GAMEDE is composed of two systems: the decision system (**DS**) and the biophysical system (**BS**). The most significant influences of Fs on the model concern the DS. It was initially proposed to use an existing modelling framework (Martin-Clouaire and Rellier, 2000) to model the decision-making about the drivers of the farm activities. But Fs' emphasis on the adjustments of their action plans led to develop the DS of the model. A Structure for Action Modelling (the SAM) has been specially elaborated to consider decision adjustment rules (Vayssières *et al.*, 2007).

The BS of the model has also been shaped by Fs' reactions. Keeping the example of composting, intra-year and inter-farms variability of mulching practices were observed and linked to straw availability. This led to the development of an original biophysical sub-model that takes into account the effect of different level of mulching on composting efficiency (Vayssières, 2007).

### Conclusions and perspectives

Fs' participation in the design of the WFM was helpful to choose the appropriate level of complexity of both the DS and the BS to represent with realism the functioning of the dairy farms.

Immersion in farms constitute a turning point of the project, the beginning of fruitful collaborations between Fs and R. The fact that the R has taken account Fs' point of view to define the organisation of the meetings had also a significant positive effect on participation. Participation of Fs was essential for the R to gain their confidence and thus to have greater access to data on the six farms, including sensitive data such as economic and manure-management data. Initially sceptical to computer models, Fs consider the experience as positive and see themselves as full contributors to the modelling process. Next step will be the use of the model as a discussion support tool to explore alternative innovations with the same individuals and later with other dairy farmers (Leeuwis *et al.*, 1996; Carberry *et al.*, 2002).

### References

- P.S. Carberry *et al.*, The FARMSCAPE approach to decision support: farmers', advisers', researchers', monitoring, simulation, communication and performance evaluation, 2002, *Agricultural Systems* 74, 141-177.
- F. Guerrin, Representation des connaissances pour la décision et pour l'action, 2007, HDR, 137 p.
- C. Leeuwis, A. Stolzenbach, A language for (disputed) learning: the use of computer generated mineral balances by dairy farmers and extension workers in the Netherlands, 1996, *In Farmers in small-scale farming in a new perspective: objectives, decision making and information requirements*, LEI-DLO, Wageningen, 288-303.
- R. Martin-Clouaire and J.P. Rellier, Fondements ontologiques des systèmes pilotés, 2003, INRA UBIA, Castanet Tolosan, France, 47 p.
- B. Minjauw *et al.*, Development of Farmer Field School methodology for smallholder dairy farmers in Kenya, 2002, International FFS Workshop, October 2002, Yogyakarta, Indonesia, 75-77.
- C. Pahl-Wostl, Actor based analysis and modelling approaches, 2005, *The Integrated Assessment Journal* 5, 97-118.
- J. Vayssières, Modélisation de la composante biophysique du modèle de flux: devenir des effluents d'élevage suite à leur manipulation, 2007, CIRAD / ADEME, 65 p.
- J. Vayssières *et al.*, Modelling farmers' action: decision rules capture methodology and formalisation structure: a case of biomass flow operations in dairy farms of a tropical island, 2007. *Animal* 1, 716-733.
- D.H. Walker, Acquiring qualitative knowledge about complex agroecosystems. Part 2: formal representation, 1998, *Agricultural Systems* 56, 365-386.

## **IMPROVING FARMING SYSTEMS DESIGN BASED ON THE AGILE MODELLING PARADIGM**

M. Langensiepen<sup>1</sup>

<sup>1</sup> Modelling Plant Systems, Institute of Crop Science, Faculty of Agriculture and Horticulture, Humboldt-University of Berlin, Germany, matthias@langensiepen.net

### **Introduction**

Farming systems design is getting increasingly challenging as global food demand is rising, agricultural markets are becoming more volatile, and agro-ecological conditions are influenced by climate change. Agricultural simulation modelling was introduced in the 1950s for dealing with the complexities of agricultural management and farming systems design in a targeted manner by adopting the method of systems analysis which evolved at that time. Numerous simulation models were constructed since then, ranging greatly in scope and complexity. Today, however, the broad application of modelling in agricultural decision support and systems design is still more a vision than a reality. Although 99% of farm businesses in the more developed world own computers, less than 25 % make actual use of decision support tools (Kerr and Winkelhofer 2006). They have virtually no relevance in the less developed areas (Matthews and Stephens 2002).

### **The uptake of agricultural decision support tools has been poor so far**

The states of crisis in agricultural decision support and possible solutions have been discussed in a number of recent publications (see McCown et al. 2002 or Passioura 1996 for example). They identified two key reasons for the poor uptake of decision support tools, namely the lacking involvement of end-users during the model development process and uncertainties associated with coupling engineering and science approaches. Both are caused by a lack of communication which could be improved by introducing a development process which interfaces practical agriculture and basic science. The agile modelling paradigm of the software industries seems to provide such an option. It was introduced in 2001 as a result of a rapid increase of process complexity which rose software development time and costs to unacceptable levels.

### **Application of agile modelling principles is a possible solution**

End users are involved throughout the agile development process which values individuals and interactions more than processes and tools (agilemanifesto.org). New functionality is added during each development iteration which typically requires less than four weeks and involves all phases of contemporary software design: Planning, requirements analysis, design, coding, testing, and documentation. Specific use cases are defined and contain detailed user stories, describe how the modelling system is applied, and what it does for its stakeholders. They place model requirements in practical contexts and corresponding test cases ensure that the model fulfills its desired functionality throughout each development cycle. Test cases are formal statements that can be checked against at any stage during the model development process and ensure that concepts, algorithms, code, and functionality embodied in a software package stay valid at all times. It is this feature of the agile modelling paradigm which makes it particularly useful for interfacing the human and science dimensions of agricultural research and development.

### **Coupling model-based reasoning and agile software design**

Model construction is initialized by the desire to solve problems (see Fig. 1), which are perceived through cognitive skills and then mapped into a hypothetical solution structure which is expressed in linguistic, formulaic, and imagistic informational formats. The formal concepts of programming languages allow a transformation of these formats into standardized computer codes, data-structures, and visual interfaces. The resulting simulation software produces outputs which can be checked against real-world observations. Conversely, they can be also used for improving simulation performance through pattern search and detecting parameter uncertainties. Applying test-driven software development techniques in these contexts promotes logical coherence, integrity, and reliability. Moreover, they also ensure that the modelling process stays relevant for practical purposes, thereby bridging the gap between basic science and agricultural practice.

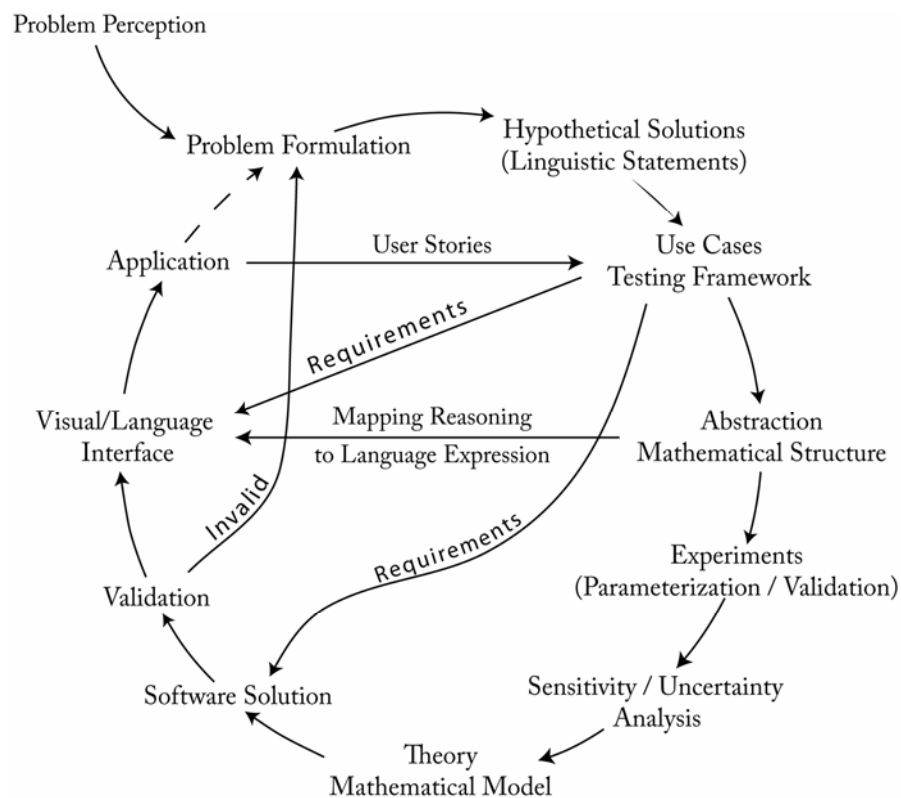

Figure 1 Coupling model-based reasoning and agile software design principles for improving farming system design and management (explanations see text)

### User interface design and application

Basing model design on standardized procedures and language formalisms facilitates a wide dissemination and exchange of information. Agricultural science would greatly benefit from the application of a common modelling jargon across its different disciplines which would likely have a positive impact on the process of farming systems design. Modellers who are commonly focused on hypothesis testing would be additionally persuaded to map their theoretical reasoning to common language expressions which could be further transformed into visual computer interfaces. Human-computer interface design is an area which has been largely neglected by agricultural systems modelers in the past and becomes increasingly relevant with the spread of information and communication technologies in agricultural practice. Standardizations of data formats will additionally simplify information processing and exchange, particularly in highly mechanized farming enterprises, as has been recently demonstrated by the agroXML project ([www.agroxml.de](http://www.agroxml.de)). The application of the agile modelling paradigm in agricultural practice also opens new opportunities for hypothesis testing in practice and would thereby have a positive impact on the efficiency of agricultural research.

### Conclusion

The application of agile software design principles in agricultural systems modelling has many advantages to offer for improving farming system design and management.

### References

- D. Kerr and H. Winklhofer (2006) The effect of rapid rural industry changes on the development of a decision support system for dairy farmers in Australia. *Computer and Electronics in Agriculture* 50, 61-69
- R. B. Matthews and W Stephens (2002) *Crop-Soil Simulation Models: Applications in Developing Countries*. CABI Publishing, Wallingford, UK.
- R.L. McCown et al. (2002) Probing the enigma of the decision support system for farmers: Learning from experience and from theory. *Agricultural Systems*, 74, 11-25.
- J.B. Passioura (1996) Simulation Models: Science, Snake Oil, Education, or Engineering? *Agr.J.*88,690-694.

## **DEVELOPING A GENERIC CROP MODELLING FRAMEWORK: HOW TO USE EXPERT KNOWLEDGE TO DEFINE CROP MODELS?**

M. Adam<sup>1,2,4</sup>, P.A. Leffelaar<sup>1</sup>, F. Ewert<sup>1</sup>, B. Rapidel<sup>2</sup>, M. Corbeels<sup>2</sup>, J. Wery<sup>3</sup>, H. van Keulen<sup>1,4</sup>

<sup>1</sup> Plant Production Systems Group, Wageningen University, the Netherlands, Myriam.adam@wur.nl

<sup>2</sup> CIRAD, UMR System CIRAD-INRA-SupAgro, France, m.corbeels@cgiar.org

<sup>3</sup> SupAgro, UMR System CIRAD-INRA-SupAgro, France, wery@supagro.inra.fr

<sup>4</sup> Plant Research International, Wageningen University and Research Center, the Netherlands

### **Introduction**

Crop models are widely used for a range of applications. Individual models, however, are typically developed for a specific objective and are not easily reusable. Adapting a model to different objectives, such as different crop and/or soil management practices, often requires modification of the original model structure. To overcome this limitation, we aim at combining model concepts and information about their interactions with communication technology to provide a modern and flexible system that will allow model users (at first modelers) to apply the tool effectively.

This paper describes a methodology to create such a system by using an object-oriented design approach. This approach allows creating a framework that comprises different conceptual approaches (e.g. light use efficiency, photosynthesis...), and organizes and synthesizes knowledge and information through "if-then"-type of rules. The novelty of our research does not reside in the modularization of a crop model, but rather in the incorporation of expert knowledge in the framework, to facilitate generic and process-oriented modeling that goes beyond traditional approaches based on monolithic models.

A preliminary result of this approach is presented in this paper. It has been implemented within the Agricultural Production and Externalities Simulator (APES) of the EU-IP SEAMLESS project to simulate the growth and productivity of crops with different phenological patterns. It illustrates how expert knowledge is applied in the selection of existing conceptual approaches in a flexible way to meet different simulation objectives. Future developments are discussed.

### **Methodology**

Ahuja and Howell (2002) defined a modular modeling computer framework as consisting of:

1. a library of alternative modules for different sub-processes of the modeled system
2. an associated database and
3. the logic to facilitate the assembly of appropriate modules to model the system.

The Object Modeling System framework (David et al., 2002) as well as the Common Modelling Protocol (Moore et al., 2007) incorporate these three key features. However, it appears that the logic that facilitates the assembly of the different modules is based primarily on modular and hierarchical system modeling. We propose to go one step further and to use an object-oriented design approach, i.e. more specifically design patterns to create a framework that allows to organize knowledge. We do not want to create an expert system in itself, but we want to provide a shell within which users can express their vision on the system and from which the best, i.e. according to current state-of-the-art, combination of processes can be derived according to their objectives.

To achieve this objective, we use (1) the strategy design pattern to define a family of algorithms and make them interchangeable through the use of an intelligently chosen interface, defined by (2) the Abstract Factory design pattern that creates families of related or dependent objects (Figure 1a). This second component is key to our design, as it allows representing the assemblage of modules in accordance with our understanding of the system and the simulation objective. It could be considered as an inference engine. Indeed, the first component will represent a library of modeling approaches, while the second will represent a library of concepts that will allow formalizing the understanding of the system to reflect, e.g., a specific Genotype \* Environment\* Management interaction (expert knowledge).

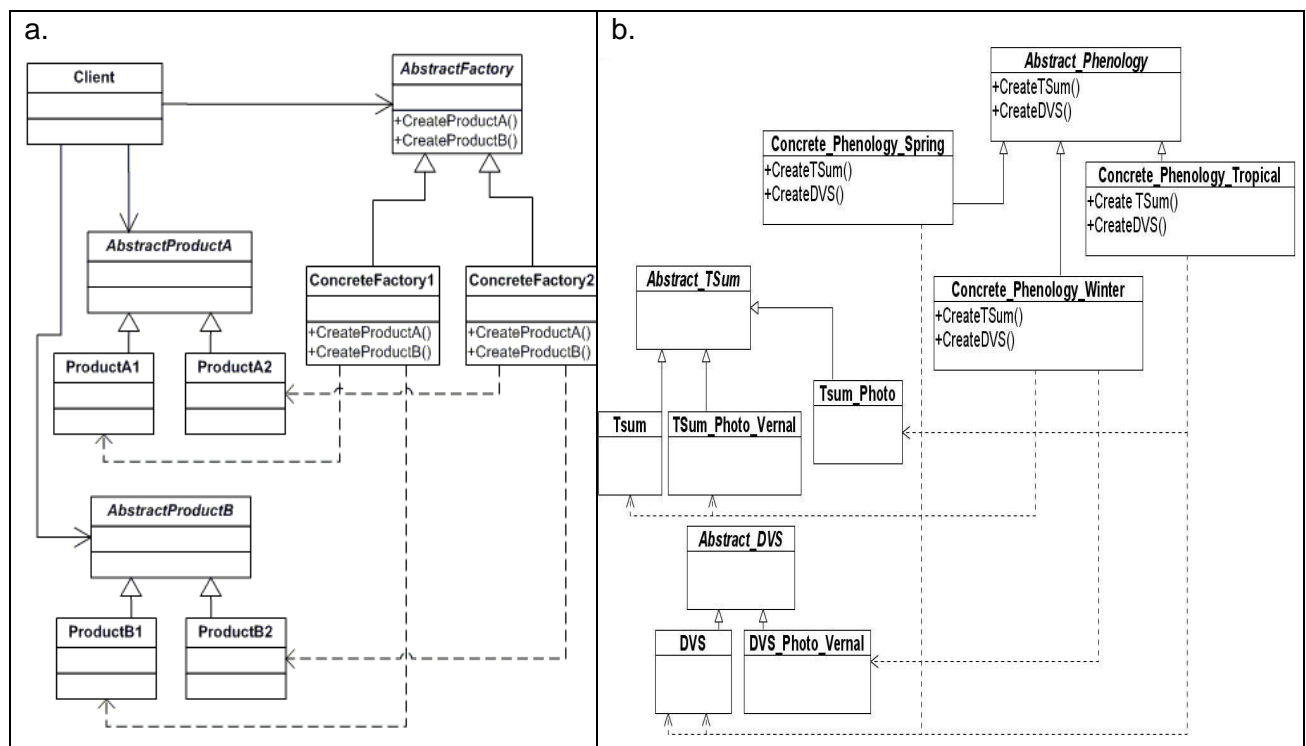

Figure 1: a. Unified Modelling Language diagram (UML) of Abstract Factory design pattern, b. UML diagram applied to the phenology case

## Results

The presented principles are implemented within the biophysical component APES. The focus is on the crop component that encompasses 3 different versions of a common model including crop-specific adaptations. It represents different ways of simulating phenology in dependence of certain crop characteristics (Figure 1b). This design allows the use of the same component “phenology” without using different crop models, but rather using different modeling approaches in dependence of crop characteristics. This is a first example of what can be achieved. However, we aim at extending the approach to emphasize the role of expert knowledge in model construction and identification of relevant processes, in dependence of the simulation objective.

## Conclusions

The described framework is at an early stage of development and we are aware of potential mismatches between the theory explained and the results presented. However, our intention is to proceed in developing a flexible and automated system that will connect the appropriate physiological processes to simulate crop growth and development, and to establish appropriate combinations of crop modeling approaches that can be applied for any specific objective. One of the most fundamental challenges in model building lies in the identification of an appropriate level of abstraction, rather than in replication of the system under study. We believe that application of an object-oriented design approach, and more specifically of design patterns, allows creating a flexible simulation system that can be extended according to needs and enables easy incorporation of expert knowledge to properly represent the system in dependence of the objective of the simulation.

## References

- Ahuja, L.R. and Howell T.A., Whole System Integration and Modeling essential to agricultural Science and Technology in the 21<sup>st</sup> century, in *Agricultural system models in field research and technology transfer*, 2002. Lewis Publishers, p1-7.
- David et al., The Object Modeling System, in *Agricultural system models in field research and technology transfer*, 2002. Lewis Publishers, p317-330.
- Moore et al., The Common Modelling Protocol: A hierarchical framework for simulation of agricultural and environmental systems, 2007. *Agricultural Systems*, in press.

## COMBINING SCIENTIFIC & LAY KNOWLEDGE IN MODEL TO ACCOMPANY ACTORS IN A CHANGING AGRICULTURE

M. Navarrete, M. Tchamitchian, M. Etienne, E. Lécivain, J. Lasseur, M. Napoléone  
Écodéveloppement Unit, INRA Avignon, France,  
{navarret,arm, etienne,lecriv, lasseur, napoleone}@avignon.inra.fr

### Introduction

Two approaches are proposed to help farmers or stakeholders to change their practices and farming systems, by increasing their knowledge and providing them means to evaluate the consequences of new farming systems. These approaches are based on the idea that the design of new cropping techniques or farming systems can benefit from a model of the system and of its biotechnical processes. They are put into application in a context of necessary changes and in response to two different kinds of questions. The first one deals with organisation problems where different stakeholders take decisions and actions modifying the properties and behaviour of a system they share; in this case, a research approach centred on the interactions between stakeholders is used. This companion modelling approach implies stakeholders to participate in the construction of the conceptual model and in the analysis of the current changes of their farming systems by using the model as a tool to design and simulate scenarios, or as a support for role-playing games. The second kind of questions deals with management problems needing more technical solutions; in this case, an approach centred on the biotechnical processes is used. This approach is based on the complementarity between the available scientific knowledge and a reformulation of the lay knowledge, after analysis and some validation.

### Methodology and results of the two approaches

The companion modelling approach considers that dealing with complex farming systems requires the gathering of scientific and lay knowledge in order to co-construct a shared representation of these systems and provide flexible indicators to imagine and evaluate their future state. During the conception step, the different ways of dialogue between researchers and stakeholders are shaped as more or less formalized participatory modelling processes. The goal is to construct a representation of a specific question on a defined situation, to share it among the stakeholders and then to formalize it in a specific way: "unconscious" models such as verbal participatory diagnosis or expert representations, or explicit models such as charts, graphs, schemes or computer models. The process always involves periods of collective exchanges because the underlying hypothesis is that what stakeholders need is less a simple formalization of their own perception than an exchange among stakeholders (including experts and researchers) about such representations, and existing knowledge. By structuring these exchanges, the modelling process helps the stakeholders to validate the interactions between different representations and visualize the farming system dynamics integrated in the model, and ends on a true learning process. During these collective moments, the scientific and technical perception of farming systems is only one among other options, and not the pre-supposed right perception toward which the model should be attracted. The objective is not to produce a unique and definitive ideal farming system, but to enrich the decision-making process by imagining a set of possible options and evaluating them in terms of technical (information assessed, technical quality of actions launched, etc.), or sociological (plurality of discussed matters, reinforcement of stakeholders power) aspects.

Collective decision-making processes are facilitated by making more explicit the various points of view and subjective criteria, to which the different participants refer implicitly or even unconsciously. In such complex situations, the companion modelling process produces imperfect representations and "decision acts", which become less imperfect and more shared during the iterative process. What the participants are looking for is not only the technical quality of the choice, but the quality of the process leading to it. It is not about finding the best technical solution, but to provide powerful means for stakeholders to take into consideration as well as possible the uncertainties of the situation they are collectively dealing with. This approach has already been applied to enhance farming systems organisation in the framework of dairy cooperatives milk supply (Boutonnet, Napoleone et al., 2005), to improve the management of interactions between livestock farming and land use changes (Lasseur, 2005), or to tackle interactions between farming activities and biodiversity conservation (Etienne et al, 2003).



The second approach, centred on the biotechnical processes, considers that because of the complexity of the farming systems at hand, the scientific knowledge available cannot be sufficient to build a proper representation allowing the evaluation of these systems or of new ones. Because of this incompleteness (especially regarding the environmental states and constraints of techniques), it is also necessary to exploit the lay knowledge carried by farmers. Placing value on this lay knowledge is also a way to involve farmers in the design of farming systems. The goal of the model is therefore not only to help the farmers in the design, it is also a frame in which the individual knowledge of every farmer can be represented and made to interact with the relevant scientific knowledge. However, farmers elaborate their knowledge in specific situations, in their local environment and on their farming systems. Modelling this knowledge in an agronomical approach requires that the conditions in which it is obtained and validated be made explicit. To do so, this knowledge must be analysed and different expressions of a given process must be confronted to identify which parts of these expressions are generic and which are dependent on the situation in which the knowledge was obtained. By performing this analysis we create a more generic knowledge which can be validated by observations or experimentations if need be. The model is therefore not directly built on the knowledge of the farmers as they express it, but on a reconstruction of this knowledge by a scientific analysis.

Using the model to help in the design of new cropping or farming systems requires it to be explained to the farmers, because the analytical work carried on their knowledge and the completion by scientific knowledge has created a distance, a change of view between the content of the model and the farmers' perception of the systems represented by the model. Exchanges with the farmers during the building phase of the model are required to bridge this distance. At the same time these exchanges allow two different operations. The first one is the validation by the farmers of the interpretation of the knowledge by the scientists, and the second is an enrichment of the knowledge of the farmers confronted to this rebuilding of their experiences and knowledge. By fulfilling these two goals, the model gains credentials and legitimacy from the farmers, which is necessary for it to be accepted as a tool for decision support and systems design. This approach has been applied to improve grazing management to control shrub encroachment (Lécrivain, 2004) and is currently used to design farming systems allowing the control of soil-borne diseases in protected vegetable cultivation (Navarrete, Tchamitchian et al., 2006).

## Conclusions

Combining scientific and lay knowledge has proved to be an effective way to build models and use them to accompany the stakeholders in changing their farming systems. Although models are at the core of the two approaches and have a similar final utility (support the evaluation of innovations by simulation), they play a different role in the accompaniment of the stakeholders. Where organisational problems are paramount, the building phase of the model is a key period of exchanges of knowledge and point of views, directly facilitating the design of solutions. During this period, new knowledge on the interactions between stakeholders managing common resources is produced. Where technical problems dominate, the building phase of the model feeds research with integrated observations and questions, but does not directly participate in the design of solutions. In this case, an additional phase of sharing is necessary to feed back to the stakeholders the model partly built up on their knowledge. The new knowledge produced deals with the interactions between the agricultural techniques and the biophysical system.

## References

- M. Etienne et al., A step-by-step approach to building land management scenarios based on multiple viewpoints on multi-agent system simulations, 2003. JASSS 6(2) <http://jasss.soc.surrey.ac.uk/6/2/2.html>
- J.P. Boutonnet et al., AOC Pélaridon, filires en emergence. Enseignements et questions vives, 2005 (symposium du prog PSDR Lyon, 9-11/03/05)
- J. Lasseur, Sheep farming systems and nature management of rangeland in French Méditerranée mountain areas, 2005, Livestock Production Science 96, 87-95
- E. Lécrivain, Shepherding: which know-how and relevance to the present day ? 2004, XI World Congress of Rural Sociology. Trondheim (NOR), July 25-30, 11 pp
- M. Navarrete et al., Integrated soil-borne disease management in protected vegetable crops in South-East France, 2006, 9th International Workshop on Plant Disease Epidemiology, Landerneau (FRA), p. 105

## INTEGRATING FARMER KNOWLEDGE, PRECISION AGRICULTURE TOOLS AND CROP SIMULATION MODELLING TO CHANGE MANAGEMENT PRACTICE

Y.M. Oliver<sup>1</sup>, M.E. Robertson<sup>2</sup>, R. Lawes<sup>3</sup>

<sup>1</sup>CSIRO Sustainable Ecosystems, Wembley, Western Australia. [Yvette.Oliver@csiro.au](mailto:Yvette.Oliver@csiro.au)

<sup>2</sup>CSIRO Sustainable Ecosystems, Wembley, Western Australia. [Michael.Robertson@csiro.au](mailto:Michael.Robertson@csiro.au)

<sup>3</sup>CSIRO Sustainable Ecosystems, Wembley, Western Australia, [Roger.Lawes@csiro.au](mailto:Roger.Lawes@csiro.au)

### Introduction

Cropping fields in the Western Australia wheatbelt are often large (50-200 ha) with significant spatially heterogeneous soils, crop performance and by default, profit. Farmers have detailed spatial knowledge of the size and location of poor performing patches within their fields, but rarely understand the patches' spatial extent, its consistency of performance across seasons, or the basis for its poor performance. In an attempt to increase production on poor patches, farmers may apply additional fertiliser or ameliorants without economic or scientific reason. Improved understanding of reasons for poor performance, management options, potential crop yield and economic benefits can give farmers the tools to consider management change.

We have been trialling a process which integrates farmer knowledge, spatial data, scientific understanding and simulation modelling to assist farmers with management decisions around poor performing patches in fields.

### Methodology

At workshops and field days in the low-medium rainfall zone (200-400mm) in the Western Australian wheatbelt we trialled an approach which:

1. Formalised farmer knowledge through the drawing of a field sketch of zone boundaries, a "mud map", which incorporated knowledge of topography, soils, production, frost, weedy areas and other management issues.
2. Used precision agriculture (PA) spatial data to indicate preliminary performance zones (low, medium and high crop performance). These included: yield maps, aerial photographs, Landsat imagery (NDVI and other indices), electromagnetic surveys, gamma radiometric surveys and soil surveys. The availability of spatial data varied from one farmer to the next.
3. Located poor patches by integrating farmer knowledge with the spatial data. This process provides a sensibility test and better understanding of the PA data.
4. Sampled soils to depth in poorly performing areas; analysed for chemical or physical constraints to root exploration. Plant available water capacity (PAWC) was measured at some sites or estimated from texture and rooting depth (for field days).
5. Parameterised a crop simulation model (APSIM, Keating et al. 2003) with soil information collected in each zone to estimate water-limited yield potential. In WA, the soil plant available water capacity (PAWC) is one of the main drivers of yield potential variation and the relationship is seasonally dependant (Oliver et al. 2006). The soil type and soil PAWC are highly correlated which enables estimation of PAWC with knowledge of rooting depth.
6. Used APSIM model outputs to explain the main drivers of yield variation and to provide insight into the variability observed by the farmers and measured by the spatial tools. The crop model was used to explore management scenarios with the farmers. This might involve comparing amelioration for a soil constraint such as soil acidity with a "do nothing" approach, or the response of a poor performing zone to extra nutrient inputs.

### Results

The results obtained with of this approach are best captured in case studies as outlined here. A 148ha field in the Wheatbelt WA that the farmer thought was underperforming was used as a case study and a field day demonstration in 2006. The farmer, who did not have a formal yield map, drew a "mud map" indicating soil types and areas of performance with an estimate of yield potential in each zone over a range of seasons. Preliminary performance zones were created from NDVI image analysis using 5 historical years of cereals (Maling and Adams 2005) and 1:50,000 soil map. In this example the performance zones matched the farmer's knowledge. In other case studies,

performance boundaries have been adjusted due to other factors such as frost or management errors.

Soil pits in each performance zone were dug to 2m, and soil texture and chemistry analysed in the field (and lab), with soil PAWC estimated from texture, constraints to depth and observed rooting depth (Table1). PAWC estimates combined with APSIM modelling were able to estimate the yield potential and explain the variation in yield potential in the performance zones (Table1).

Table 1: Characteristics of farmers field, soil type, PAWC and constraints and estimated potential yield (over 100 years) range (mean+/-SD)

Zone	Area (ha)	Crop yield potential (t/ha)	Soil type	Root depth (m)	PAWC (mm)	Manageable constraints
Low	38	0.6-1.6 t/ha (median 1.1t/ha)	Acid yellow loamy sand	0.4	20	Acidity
Medium	42	1.3-2.4 t/ha (median 1.9 /ha)	Gravelly loam sand (~50% gravel)	1.2	60	None
High	54	1.7-3.6 t/ha (median 2.6 t/ha)	Yellow sandy loam	1.8	100	Hardpan and acidity emerging but not constraining roots

The low yielding site was an acid yellow loamy sand, which the farmer was going to ameliorate. As the acidity continues to depth, amelioration by liming could only increase the rooting depth by 0.2 m or increase PAWC by 20 mm. If liming was 100% effective this could increase yield by an average of 0.6 t/ha (0.1-0.9 t/ha). If amelioration is not effective then the profitability of wheat on that area is low with the yields less than break-even (~1 t/ha) in 41% of years. At the high yielding site the deep yellow sandy loam was showing signs of forming a hardpan and acid layer at 0.2 m. Modelling estimated the yield loss if acidity and hardpan developed, based on reduced root depth, to be 0.4-1 t/ha which is worth ~\$70-180/ha. In the medium yield area, the gravelly loam soil was yielding near potential defined by the soil type.

The farmer was able to base his management options on the information provided by coupling the spatial data with the crop simulation modelling. At the low yielding site there were three options: 1. ameliorate with lime, 2. accept the low yield and reduce nutrients and, 3. alternative land use. At the average and high yielding area he could match fertiliser to the yield potential but could also prevent degradation of his high yielding site through amelioration. Whether amelioration will occur depends on the costs and effectiveness of amelioration options.

## Conclusions

This process helped the farmer understand spatial seasonal influences on yield potential, and had influenced his management of this field. The case study has highlighted the value of simulation modelling in integrating soil constraints with production in a spatial context to assist management of variable fields.

## References

- ML Adams, I Maling. Simplifying management zones – a pragmatic approach to the development and interpretation of management zones in Australia. 2005.. In: Mulla, DJ, Editor. Proceedings of the 7th International Conference on Precision Agriculture, July 25-28, 2004. Precision Agriculture Center, University of Minnesota, St. Paul, Mn.
- BA Keating BA, et al. An overview of APSIM, a model designed for farming systems simulation. 2003. Eur J Agron 18, 267-288.
- YM Oliver et al. PAWC determines spatial variability in grain yield and nitrogen requirement by interacting with rainfall on northern WA sandplain. 2006. Proceedings of the 13th Australian Agronomy Conference, 10-14 September 2006, Perth, Western Australia. Australian Society of Agronomy.

## Acknowledgements :

GRDC for funding this project and the Kellerberrin Demonstration Group for their support.

## INTEGRATION OF MODELS, DATA AND EXPERT KNOWLEDGE BY MEANS OF INDICATORS: THE SEAMLESS PROJECT EXPERIENCE

I.V. Bezlepkina<sup>1</sup>, J. Alkan Olsson<sup>2</sup>, I. N. Athanasiadis<sup>3</sup>, S. Janssen<sup>1</sup>, L. Ruinelli<sup>4</sup>, R. Knapen<sup>1</sup>, H. Li<sup>3</sup>, C. Bockstaller<sup>5</sup>, H. Belhouchette<sup>6</sup>, O. Therond<sup>7</sup>

<sup>1</sup> Business Economics, Wageningen University, the Netherlands  
({irina.bezlepkina,sander.jansen,rob.knapen}@wur.nl)

<sup>2</sup> Lunds University Centre for Sustainability Science, Sweden (johanna.alkan\_olsson@lucsus.lu.se)

<sup>3</sup> Dalle Molle Institute for Artificial Intelligence, Lugano, Switzerland ({joannis,hongtao}@idsia.ch)

<sup>4</sup> AntOptima, Lugano, Switzerland (lorenzo.ruinelli@antoptima.ch)

<sup>5</sup> INRA UMR INPL- (ENSAIA)-INRA Nancy-Colmar, Colmar France (bockstal@colmar.inra.fr)

<sup>6</sup> INRA Montpellier, France (hatem.belhouchette@ensam.inra.fr)

<sup>7</sup> INRA Toulouse, France (therond@toulouse.inra.fr)

### Introduction

The European Commission has introduced impact assessment as an essential step in the policy development. In the SEAMLESS integrated project (<http://seamless-ip.org>), researchers work to develop a computerised Integrated Framework, aiming to provide (among others) with a set of economic, social and environmental indicators allowing the assessment of ex-ante, alternative agricultural and environmental policy options. Stakeholders' involvement is of crucial importance in impact assessment (European Commission, 2005). Key requirement for SEAMLESS-IF is consequently to be generic and transparent for different types of user groups. Indicators in SEAMLESS are built upon model outputs. However for social indicators model support is weak so the number of social indicators is low. These indicators will instead be based on simple causal relations, expected trends and expert or stakeholder assessment. Moreover, threshold and target levels are essential to contextualise indicators. Stakeholders define threshold and target levels and their quantification. The challenge for SEAMLESS-IF is therefore to deploy a software implementation that enables the integration of the results from mechanistic models with the information provided by different types of stakeholder groups.

### Methodology

Due to the broad scope of the project, communication between researchers from different research groups coming from various disciplines and backgrounds, as well as between scientists and stakeholders is a great challenge. To overcome these difficulties the SEAMLESS project has decided to employ ontologies as a medium for systematise communication. Formal domain ontologies are knowledge engineering artefacts that describe an agreed interpretation of domain knowledge, making explicit the terms that represent pertinent concepts and their intended meaning (Uschold and Gruninger, 1996). This approach is in line with the work of Brilhante et al (2006) that presents a sustainability analysis framework, which enables the connection of a software implementation with the analysis of systems sustainability, and the work of Pennington et al (2007), that describe collaborative efforts between a knowledge representation team, a community of scientists, and scientific information managers in developing knowledge models for ecological and environmental sciences. In our case, numerous iterations between researchers in the project and stakeholders in four steps: 1) literature study on indicator frameworks (indicator developers) 2) identification of indicators that can be derived from existing models or require some post-model processing (indicator developers and modellers) 3) knowledge systematization and ontology development (by indicator developers and knowledge engineers) 4) implementation of indicator library and calculator (software engineers). To facilitate the communication, workshops and user forum meetings have been organised frequently.

### Results

The SEAMLESS project has developed a goal-oriented framework (GOF), which aims to facilitate the users' assessment of ex-ante impacts of specific policy options (Bockstaller et al., 2007). The indicator framework is based on a sub division of sustainable development into goals which are linked to the environmental, economic or social dimensions of sustainable development. For each dimension of sustainability, three generic themes are specified and structured in sub-themes. Each sub-theme can host an unlimited list of indicators. Based on interactions with stakeholders form

different categories and scales (EU, national and regional) it became evident that these lists of indicators should be closely related to indicators that are already in use in the EU. Each indicator is specified in detail using an indicator fact sheet and calculation sheet hosting information on e.g. the place of the indicator in the indicator framework (GOF), the model output that the indicator is based on and the detailed calculation of the indicator. These documents have served as an input to the developed indicator ontology aiming to facilitate the handling of the information that is needed to implement the indicator in the tool as well as to facilitate the users selection of indicators for and impact assessment. This structured approach to information harnessing creates the basis for the generic structure of the tool and re-use of indicators between different impact assessment

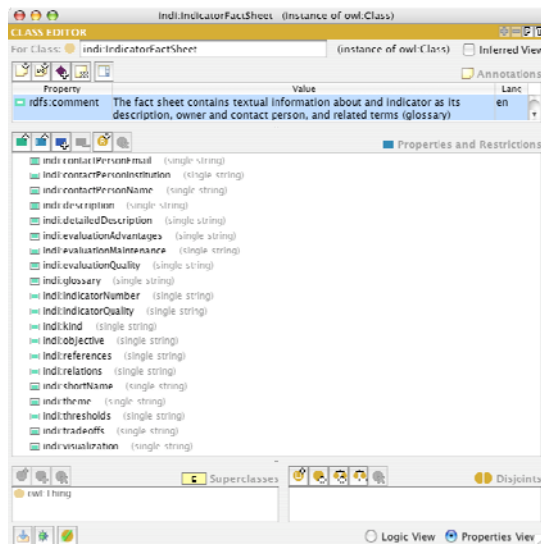

Fig. 1 The indicator fact sheet structure

projects using it. A first, indicator ontology has been drafted upon the indicator fact sheets pertaining their content. A screenshot of that ontology is shown in Fig.1. On top of the developed ontology, that defines the attributes of an indicator, its classification according to themes and some textual comments, we developed a facility that enables end-users to access and modify this information through a web-based prototype. Note that the population of the indicator library is done by non-modellers and non-specialists, since the interface is build with user-oriented concepts. The indicator calculator is a framelet integrated into the SEAMLESS-IF tool. It was build to enable for the calculation of indicators that are transformed model outputs. Through the indicator manager the stakeholders are given the opportunity to define target levels or thresholds that are relevant for the specific impact assessment assignment.

## Conclusions

This paper provides an example how researchers that are distant to software engineering and modelling can contribute to the development of a system for indicator implementation and management within a larger context of a complex computerized tool. The system is designed in such a way that it can be customized to various methodologies of indicator calculation (directly from data, linked to model outputs, transformed model outputs) to fit the scientific reality of economic environmental and social indicators. Since model inputs and outputs and model output transformation are described in the ontology it facilitates the tracing of the model chain needed for indicator calculation. The ontology of the indicator calculator enables the integration of qualitative and quantitative indicators, something that facilitates the inclusion of social indicators. The developed indicator ontologies allow tracing the implementation of an indicator based on a big set of data and visualising the result by means of declarative modelling and various software tools. Through the developed graphical user interface built upon the designed ontology the users will also be able to define their case specific thresholds and target values. The ontology facilitates both the exchange of knowledge between the researches in the project as well as improves the communication between the expert tool and stakeholders.

## References

- C. Bockstaller et. Al. Developing an indicator Framework to assess sustainability of farming systems, Farming Symposium, Catania 2007.
- V. Brilhante et al., Information Integration through Metadata and Ontologies for Sustainability Analysis, 2006. In Proceedings of the Summit on Environmental Modelling and Software (iEMSs), Burlington, Vermont. European Commission, 2005, Impact Assessment Guidelines, SEC (2005) 791
- D.D Pennington et al.. (2007). Computer-Supported Collaborative Knowledge Modeling in Ecology. Workshop on Social and Collaborative Construction of Structured Knowledge at 16th International World Wide Web Conference (WWW2007)
- M. Uschold and M. Gruninger. Ontologies: principles, methods and applications. The Knowledge Engineering Review, 11(2):93-136.

## REPRESENTING SYSTEM DYNAMICS WITH TEMPORAL INTERVALS: APPLICATION TO LIVESTOCK FARMING SYSTEMS MODELLING

T. Pacaud, S. Cournut, C. Poix

UMR Métafort, ENITA Clermont Ferrand, France, pacaud@enitac.fr,ournut@enitac.fr, poix@enitac.fr

### Introduction

This work is taking part into a research current about farming systems analysis framework and modelling approach renewal. As most of farming systems models have been focused on technical and economical aspects, there is a need to explore other stakes like social and environmental ones.

The farming system is usually represented as an articulation through time between two sub-systems (Landais, 1987): the decisional one which elaborates decisions and the bio-technical one which elaborates production. Modelling this articulation into a simulator is far from being easy. On the one hand, the knowledge about biological phenomena comes from scientific studies and is often integrated into mechanistic models. On the other hand, the decisional field is approached differently (Girard and Hubert, 1999) and is usually reduced to a set of coherent rules without the real decision process of the farmers being formalized, notably the times for taking decisions and the real schedule for implementing the linking of decisions and procedures for adjusting the management system.

We suggest a formalism to bring an original solution to this problem and we show its interest by developing a livestock farming system simulator.

### Methodology

Some previous studies showed the importance of temporal logic to characterize the diversity of livestock farming systems (Cournut and Dedieu, 2006). To feed this formalism based on systems temporal logic, a disciplinarian and professional expertise network has been mobilized. Agronomists, animal scientists and field technicians are taking part in the knowledge integration. Computer specialists are carrying out the formalism implementation (Aligot model). Moreover, contacts with professional partners give us the opportunity to access to milk recording data and to start up a farm follow-up. This follow-up is a mean (i) to switch from concrete and real cases to a conceptual representation, integrating the different time dimensions (calendar time, long time, chronologic time, etc.) and (ii) to elaborate a method and a survey protocol in order to characterize the farms temporal logic.

Knowledge integration also requires the use and the treatment of information coming from data. The one that we use have several origins: previous studies data including on-farm surveys, experimental data for biological mechanisms (grass growth or animal reproduction), disciplinarian and professional experts knowledge (e.g. about farms performances) and data stemming from the farm follow-up.

### Results

With this formalism, the farming system dynamics are represented with temporal intervals (figure 1) which can be for example periods which characterize biological behaviour of objects (e.g. lactating animal) or refer to natural phenomena (e.g. rainy periods), periods associated to the management of the farm (e.g. utilization mode of a parcel) or intervals expressing an articulation between those two elements (alimentation calendar for an animals batch). These intervals are managed by a rules base that represents just as well the biophysical system running as the farmer decisions. As it is constructed in a declarative mode, this base can be enriched and precised at any time by adding intervals and rules to manage them. The rules resort to a specific temporal logic, the Allen algebra (Allen, 1987) which allows the expression of qualitative relations between intervals and the manipulation of uncertain temporal data (intervals having no beginning or/and no end): as an example, it is more interesting to have a management rule specifying that a ploughing is after a manure spreading intervention on a parcel than having a precise date for this ploughing.

The major interest of most of the empirical data we use to feed the model is linked to the fact that it includes biotechnical responses, expressed in their own context that is the one we are interested in, the farming system. As an example, this mobilized data set is used to formalize lactation curves (figure 1) taking into account individual trajectories of cows and their temporal position throughout the alimentation calendar. This expression of milk production can by instance be different if cows have a lactation beginning with a corn silage basic ration or if they have a lactation beginning overlapping a grazing period. Another interesting feature of this data set is its long-term nature, which enriches and reinforces expertise about long time and its importance within farming systems management and decision-making. The various information and knowledge sources do not only deal with constructing our formalism and rules bases, but they are also useful to calibrate and initialize our model, which is currently being implemented.

The formalism based on intervals allows us to represent some important aspects of a farming system like the fact that farmers take into account the long time in making decisions, by considering productive trajectories and parcels rotations notions. It is not reduced to one time step but it can articulate different time steps characterizing different processes coexisting within the farming system. Besides, this representation mode makes the superposition of several management levels (e.g. taking into account simultaneously animals and batches) and the integration of different dimensions of a system possible. In our model, we illustrate this capacity by hanging together three components of the livestock farming system: (i) the work organization, for instance with sequences of presence/absence of labour force, (ii) the surfaces represented with intervals of the modes of utilization of parcels and (iii) the herd with intervals characterising animals and batches.

## Conclusions

Although our approach is able to take into account animals' biological responses diversity, it has some limits, especially in natural phenomena representation, which do not allow, at this time, to reach the fineness of some mechanistic models. Intervals representation is actually less efficient for quantitative variables management than models based on mathematical equations.

Nevertheless, this modelling approach is more suitable to reveal temporal coherences that are usually found at different levels of organization within the farming system.

Even if it is currently in an exploratory phase and it has not already produced an operational tool, the originality lies in the new conceptual approach, which aims at studying systems temporal logic.

## References

- J. Allen, Maintaining knowledge about temporal intervals, 1983. Artificial Intelligence and Language processing, Communications of the ACM, 832-843.
- N. Girard, B. Hubert, Modelling expert knowledge with knowledge-based systems to design decision aids: the example of a knowledge-based model on grazing management, 1999. Agricultural Systems 59(2), 123-144.
- E. Landais, Recherches sur les systèmes d'élevage. Questions et perspectives, 1987. Document de travail unité INRA-SAD, 75 pp.
- S. Cournot, B. Dedieu, How dairy farmers face work problems ? Some elements about the adaptation of the technical systems in Central France, 2006. In Langeveld H., Rolling N. (Eds); "Changing European farming Systems for a better future. New visions for rural areas". Wageningen Acad. Press, 227-231.

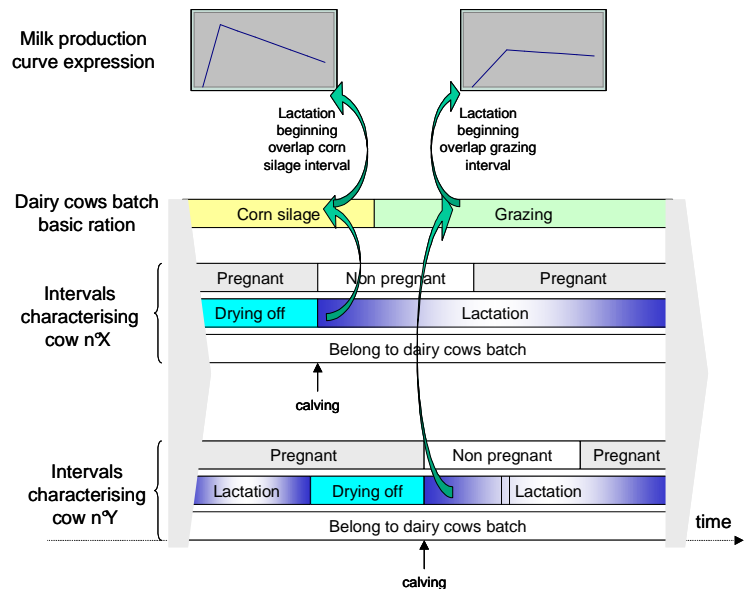

Figure 1. Lactation curve expression linking animal trajectory and alimentation calendar

## Developing more sustainable models of soil and water management in nitrate vulnerable areas with community stakeholders

M. Perugini<sup>1</sup>, D. Gibbon<sup>2</sup>, S. Maurizi<sup>3</sup>, N. Powell<sup>4</sup>, G. Seddaiu<sup>5</sup>, M. Toderi<sup>1</sup>, R. Orsini<sup>1</sup>, P. P. Roggero<sup>5</sup>

<sup>1</sup>**Dep. SAPROV - Department of Environmental and Crop Sciences** - Polytechnic University of Marche - Via Brece Bianche - 60131 Ancona - Italy. Phone: 071/2204916, [m.perugini@univpm.it](mailto:m.perugini@univpm.it).

<sup>2</sup>Rural Livelihood Systems (RULIVSYS), Pearmain, 59, Shrewsbury Road, Church Stretton, Shropshire, SY6 6EX, UK.

<sup>3</sup>La Botte e il Cilindro, teatro Ferroviario, corso Vico 14 - 07100 Sassari (Italy)

<sup>4</sup>Unit for Environmental Communication (UEC), Department of Landscape Planning, Swedish University of Agricultural Science.

<sup>5</sup>Dipartimento di Scienze Agronomiche e Genetica Vegetale Agraria, Università degli Studi, Via Enrico De Nicola 07100 Sassari.

### Introduction

Despite the application of agri-environment measures which imposed a more rational use of nitrogen fertiliser and other chemicals on large contiguous areas, the quality of ground and surface water in the hilly areas of the Marche region of Italy has not improved significantly. This paper shows the outcomes of a participatory experience, the underlying assumption of which was based on the necessity to invest in awareness and understanding of the complex interdependences around nitrate issues, in order to stimulate and facilitate a change in polluting farming practices at the catchment scale.

### Methods

In 1994, fifty municipalities in the Marche region were polluted by nitrates and hence declared undrinkable. From 1996, over five years, two municipalities of the polluted area, Serra de' Conti and Montecarotto (AN) adopted a special measure (action D3 from Reg. CEE 2078/92), applicable to contiguous areas greater than 1,000 ha, consisting of a set of low-input farming prescriptions and subsidies to compensate farmers for expected lower yields, to prevent the diffuse nitrate pollution of water.

The experiment was established from 1993 at the macro-plot scale (Roggero e Toderi, 2002a) and from 1997 at the micro-catchment scale in Serra de' Conti, providing scientific data and a basic knowledge for analysing some relevant bio-physical features of the nitrate issue in a specific context. The micro-catchment experiments provided scientific evidence that pollution was related to a set of bio-physical factors (weather, surface and ground water, soil, farming practices, cropping systems, etc.) and social and economic aspects constraining farmers' behaviour. Nitrate concentration in surface water was high despite the implementation of the low-input prescriptions, particularly in the autumn, when most arable land was bare soil and soil water surplus reached its maximum. At this stage, in 2001, the interdisciplinary research project "SLIM" (<http://slim.open.ac.uk>) provided an opportunity for the agronomy research team to reflect on the complex nature of the nitrate issue, which was recognised as an emerging property of the complex interactions between bio-physical and social processes, according to the view of agroecosystems as learning systems (Ison and Russell, 2000). The biophysical data on cropping systems and surface and groundwater quality were incorporated into different *dialogical tools* (e.g. participatory GIS, focus groups and small group interactive workshops) to facilitate interactions among different stakeholder groups, and used in agricultural simulation models (Eurosem, TOPKAPI, CropSyst) to create interactive scenarios as dialogical tools for integrating different views and knowledge towards new concerted action (Roggero et al, 2006; Toderi, Powell et al., 2003).

A series of events were organised, such as public participatory GIS interactive workshops (Powell e Toderi, 2003), meetings with farmers and people involved in local tourist activities, focus groups with administrators, semi-structured interviews with farmers' Unions and politicians and a civil theatre event. In these events, researchers played an active role in observation → reflection/assessment → design → implementation → observation (Toderi et



al., 2004). A popular theatre event was created by a community theatre team to involve the whole local community of Serra de' Conti (AN). The event was held during the "Festival of the Chickling", an annual festival during which almost all canteens in town are transformed into wine shops and thousands of people thronged the streets. During the theatre over 400 questionnaires were submitted to the public and workshops were organised before and after the event to assess the learning process and to discuss how to develop new actions around desirable and feasible changes in practice.

### Results

The theatre event was followed by regional (e.g. TGR, Weekly TG, newspapers and TV) and national mass-media (e.g. RaiTre Ambiente Italia, Radio 24, the "Focus" magazine) and this enhanced the local community sensitivity around the nitrate pollution issue.

Results from questionnaires indicated that water was perceived as polluted (92%), meant as superficial water (over 50%) and rarely (5%) as groundwater. The responsibility of water management and preservation were attributed by the public to the whole society and agriculture was indicated as the third cause of pollution (12%), after industry (27%) and the whole community (39%). Only 6% of the people who answered the questions suggested that farming could have a role to improve the situation.

From the *ex-ante* and *ex-post* event assessment, it emerged that farmers improved their own understanding of the role of agricultural practices on water and nutrient cycling in their agro-ecosystems. Non-farmer stakeholders showed increased awareness of the complexity and uncertainty of agricultural activities.

### Conclusions

In the specific case of nitrates, agronomy researchers played the role of dialogue facilitators between interdependent stakeholders. Farmers, inhabitants, politicians and policy makers, before the process started, believed that the low-input farming agro-environment prescriptions were sufficient to decrease nitrate concentration in the water below the legal threshold. The participatory meetings gave stakeholders the opportunity to de-construct the nitrate problem and to integrate the scientific knowledge locally gained by researchers and their own experience about the situation, to identify new options, or at least to share the complexity of the issue (Powell and Toderi, 2003). Researchers benefited from this emerging knowledge, in the planning of new research activities and involvement of new stakeholders. The participatory sessions also provided new conditions to promote the stakeholding processes with farmers, consumers and beneficiaries of EU subsidies with the other stakeholders.

### Bibliography

- Ison R.L. & Russell D.B. (eds), 2000. *Agricultural Extension and Rural Development: Breaking Out of Traditions*. Cambridge University Press, Cambridge, UK. 239 p.
- Roggero, P.P. et al. 2006. *Italian Journal of Agronomy*, 4, 000-000. In corso di stampa.
- Roggero P.P. and Toderi M., 2002a. In: Pagliai M. and Jones R. (eds.), *Sustainable land management – environmental protection. A soil physical approach*. *Advances in Geoecology*, 35, Catena Verlag, 471-480.
- Roggero P.P. and Toderi M. (a cura di), 2002b. *Le misure agroambientali: applicazione nelle Marche e analisi di un caso di studio sull'inquinamento da nitrati di origine agricola*. Quaderni 5B, Assam, Ancona, 339 pp.
- Powell, N. and Toderi, M., 2003. *Proceedings of the Symposium for Urban Landscape Dynamics and Resource Use*, Uppsala, Sweden, 28th -31st August, 2003.
- Powell N. and Toderi M., 2003. *Use of GIS and other Techno-dialogical Tools to Facilitate and Monitor Social Learning*; *Proceedings of the Symposium for Urban Landscape Dynamics and Resource Use*, Uppsala, Sweden, 28th –31st August, 2003.
- Toderi M. et al 2004. *Dialogical tools: a methodological platform for facilitating and monitoring social learning processes*, SLIM (Social Learning for Integrated Management and Sustainable Use of Water at Catchment Scale) Case Study Monograph 5 (available at <http://slim.open.ac.uk>).

## INTEGRATION OF CROP MODELS AND CONSTRAINT MAPPING FOR THE PROJECTION OF BIOENERGY PRODUCTION

G.M. Richter<sup>1</sup>, A. Lovett<sup>2</sup>, G. Sunnenberg<sup>2</sup>, A.G. Dailey<sup>1</sup>, A. Riche<sup>1</sup>, A. Karp<sup>1</sup>

<sup>1</sup> Rothamsted Research, Harpenden, AL5 2JQ, United Kingdom (UK), [goetz.richter@bbsrc.ac.uk](mailto:goetz.richter@bbsrc.ac.uk)

<sup>2</sup> School of Environmental Science, University of East Anglia, Norwich, NR4 7TJ, UK, [a.lovett@uea.ac.uk](mailto:a.lovett@uea.ac.uk)

The recent EU target is for 20 % of all energy to be derived from renewable sources by 2020. Bioenergy (BE) from crops is anticipated to make a substantial contribution, and increased land conversion to BE crops is predicted. This raises concerns over potential (i) impacts of such large scale land conversion on the environment, (ii) conflicts with food production and (iii) competition for resources. To satisfy agronomic, energy and environmental objectives, BE crop expansion will need to be based on knowledge of social, environmental and economic constraints obtained through participation of diverse stakeholders. This requires new tools to integrate information at various complexity and spatial scales. We combine activities from two projects (RELU-Biomass; <http://www.relu-biomass.org.uk>) and (TSEC-Biosys; <http://www.tsec-biosys.ac.uk/>). Here, we describe several relevant techniques and their integration using GIS. Outputs are exemplified using data for two English counties (NUTS 3 level), Somerset in the South West and Lincolnshire (Lincs.) in the East Midlands, both 'hotspots' for successful planting grant applications under the English Energy Crops Scheme (ECS). The integration of diverse information will enable decisions by farmers based on productivity to be balanced with views of other stakeholders concerned with impacts of landscape, biodiversity and other ecosystem functions.

### Methodology

**Modelling biomass yields of Miscanthus:** In TSEC-Biosys, crop models of different complexity are used to predict productivity for various biomass species. An empirical model combines local climate data to estimate the potential soil moisture deficit (*PSMD*) during the main season with the respective available water capacities ( $rPSMD(i) = PSMD(i)/AWC(i)$ ). Other climatic variables are aggregated as seasonal sums and averages. A multiple linear regression model derived from 66 experimental observations between 1993 and 2005 in 14 UK locations explained 63 % of the yield variance, mainly from *rPSMD(i)*. A process-based model including assimilate dynamics in rhizomes is being calibrated for Rothamsted Miscanthus data and used at the field and catchment scale.

**Constraint mapping:** Factors reflecting different concerns of stakeholders with respect to land use change were combined in a constraint mapping exercise using GIS. This analysis used 100 m resolution grid cells and involved seven criteria: landscape sensitivity (character), natural habitats, woodland, slope steepness, urban areas, designated areas and cultural heritage features. Data sources include the Ordnance Survey and the <http://www.magic.gov.uk> service. NATMAP data from the National Soil Resources Institute and the Agricultural Land Classification (ALC) (<http://www.defra.gov.uk/rds/lgmt/ALC.htm>) are used to assess land suitability for energy crops.

**GIS-Integration for sample areas:** Information on ALC and soil series characteristics (particularly AWC) was cross-tabulated for each 100 m grid cell. Results from the constraint mapping were then overlaid to exclude inappropriate land for planting. From the soil database relevant inputs were extracted to derive hydrological parameters (water at field capacity, wilting point and AWC). These were then linked to archived data from nearby weather stations (Table 1). Land use data (set aside, grassland, arable) from Agricultural Census and distributions of successful applications of Miscanthus planting from ECS (Natural England) were linked to productivity estimates.

**Case scenarios** of energy supply for a 1 MW power station (25 % efficiency, electricity only) are based on 18 MJ kg<sup>-1</sup> Miscanthus requiring 7000 t yr<sup>-1</sup> (odm); assuming an average UK yield of 12.5 t ha<sup>-1</sup> one would need about 560 ha/MW. The use of GIS allows us to combine the availability of different grades and types of land under a range of constraints and estimated production levels.

### Results

Almost 50 % of Somerset is under some constraint (<15 % in Lincs.) with respect to different stakeholder concerns. Agricultural land use and grade classification is significantly different in the selected counties. Over 60% of agricultural land in Somerset is grassland compared with 10 % in Lincolnshire where arable farming is much more important. Farmers tend to use ALC Grade 3 most

widely for BE crops and this dominates Somerset (Table 1), Grade 4/5 is mostly excluded due to any of the seven constraints. In Grade 3, more than 80 % of soils have an AWC between 100-180 mm, of which in Somerset about 1/3 is excluded due to constraints. Land of Grade 4 is more limited in Lincs., and in Somerset land with higher AWC, which may be ideal for BE crops, covers only about 4000 ha.

**Table 1:** Summary indicators for sample counties in the Southwest and East Midlands (1971-90)

County characteristic	Somerset	Lincolnshire
Location (s) for weather data	(Yeovilton) Lyneham	(Cranwell) Warsop
Average rainfall / evapotranspiration [ mm ]	705 / 598	610 / 440
Average <i>PSMD</i> [ mm ]	221 ±107	127 ± 92
Grassland / arable / set aside [ 1000 ha]	201 / 85 / 8	59 / 450 / 44
Unconstrained ALC Grade: All / 3 / 4 [1000 ha]	178 / 133 / 18	505 / 260 / 5
All average biomass yield [ t ha <sup>-1</sup> ]	9.1 ±3.7	10.9 ±3.1

In Somerset, *PSMD* is higher (Table 1) and estimated biomass yields using all soils varied greatly (**Figure 1**). Due to water stress BE yields are more variable in Somerset than in Lincs. and 30 instead of 15 % lower than the national average. Almost 20% were below 6 t ha<sup>-1</sup>, and frequent failure (< 2 t ha<sup>-1</sup>) occurred on soils with AWC ≤ 100 mm. Some 20 % of the area had yields above the UK average. 20-year averages estimated for the soils most likely to be used (80% @AWC 2&3) are smaller than the UK mean in both counties, Somerset (8.6 t ha<sup>-1</sup>) and Lincs. (10.5 t ha<sup>-1</sup>). Therefore, economic pressure may arise to assign more and better quality land to meet the demand.

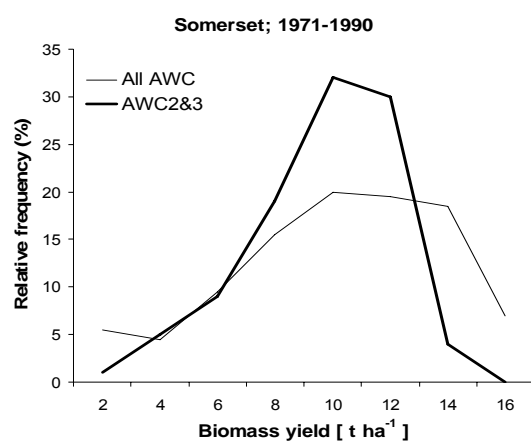

**Figure 1:** Yield distributions with and without soil quality constraints (AWC) and maps of ALC, yield and constraints in Somerset

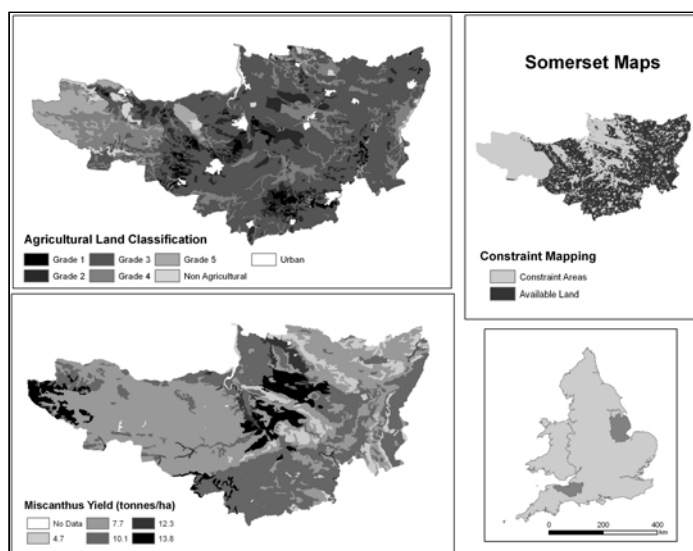

## Conclusions

- This innovative approach enables us to quantify different scenarios of BE production in relation to the ecological, economic and social concerns of various stakeholder groups (e.g. RSPB, Natural England, Environment Agency, and English Heritage).
- The economic farming constraint to exclude prime arable land, may raise the area needed to supply BE from 560 to 660 and 815 ha/MW in Lincs. and Somerset, respectively.
- Based on mean yields, land use and suitability maps farmers and energy producers can take decisions, which incorporate the concerns of other key stakeholders. For example, BE from former set aside in these counties could supply an additional 66 and 9 MW but needs to be balanced with other benefits (e.g. biodiversity).
- Future work using a terrain- and process-based soil-crop-atmosphere simulation model will enable better yield estimates and decisions on allocation at the catchment and farm scale.

## THE TREADMILL AND THE FUTURE OF WEST AFRICAN FARMING<sup>1</sup>

N. Röling, J. Jiggins

Dept. of Communication and Innovation Studies, Wageningen University, The Netherlands

[n.roling@inter.nl.net](mailto:n.roling@inter.nl.net) [janice.jiggins@inter.nl.net](mailto:janice.jiggins@inter.nl.net)

**Introduction.** The Agricultural Treadmill (AT) is an influential model of agricultural development. It is based on observed technological innovation and scale enlargement on farms in the Mid-Western US in the forties. When Cochrane (1958) first wrote it up, the AT *ex-post* explained the empirical reality around him. Then AT became the *ex ante* model of preference for agricultural development, also called the 'Transfer of Technology Model' (Chambers and Jiggins, 1987), or the 'Linear Model' (Kline & Rosenberg 1986). Say Bindraban & Rabbinge<sup>2</sup> (2005): 'In combination with close and remote sensing, geographical information systems and robots, the progressive precision in agriculture increases the efficiency and productivity of mono-crop cultivation. In an increasingly liberalised world, this far-reaching specialisation, accompanied by increases in scale, would appear to be the only economically feasible development trajectory'. The paper analyses the AT mechanism, describes the global AT, and outlines the consequences for West African farming. Both authors have careers in agricultural development (e.g., Jiggins et al. 1996). The paper draws on the results of the Convergence of Sciences (CoS) Research Programme in Benin and Ghana<sup>3</sup>.

**The AT Mechanism.** Some technologies diffuse rapidly after their release. The AT focuses on the economics of that phenomenon. Farmers who adopt early use a technology that is more productive (or less costly) when prevailing prices have not yet decreased as a result of efficiency gains in the sector as a whole. These forerunners capture a windfall profit. Soon others begin to adopt, total production increases and prices start to drop. Farmers who have not yet innovated experience price squeeze: their incomes decrease even if they work as hard as before. In the tail of the process, farmers who are too poor, too small, too old, too stupid, or too ill to adopt drop out. Their resources are absorbed by those who capture the windfall profits. This shakeout leads to economies of scale and increase in the number of people that one farmer can feed. The AT is based on the fact that none of the thousands of small firms who produce a commodity can control the price; all try to produce as much as possible against the going price (price takers). Given the low elasticity of demand of agricultural products, prices are under constant downward pressure. Evenson et al. (1979) have demonstrated that investing in agricultural research and extension to feed the AT has a high internal rate of return. The macro effects of relatively minor investments are major in terms of (a) reallocating labour from agriculture to other sectors, (b) improving a country's competitive position on the world market, and (c) reducing the cost of food. An advantage is that farmers do not complain. Their representatives tend to benefit from the process. The AT encourages farmers to externalize social and environmental costs. As an *ex ante* development model, the AT prescribes investment in technology development and in transfer to 'ultimate users'. Technology supply to increase farm-level productivity is seen as the driver of development.

---

<sup>1</sup> Paper for Farming System Design 2007, 10-12 September 2007, Catania, Sicily

<sup>2</sup> At the time of writing, the second author was Chairman of the Science Council of the Consultative Group of International Agricultural Research.

<sup>3</sup> *Internat. Journal of Ag. Sustainability JAS* 5 (2&3) 2007 is a special double issue on CoS.

**The global treadmill and its impact on West African agriculture.** Liberalisation of markets in countries that cannot resist the WTO is creating a global AT. Farmers in West Africa are now pitted against farmers who have been on the AT for 50 years or more and whose labour productivity therefore far outstrips that of the former. Moreover, in OECD countries, (exports of) a number of their key products are subsidised. Value Added per Agricultural Worker in 2003 (constant 2000 US\$) in developed market economies was 23,081 with a growth in 1992-2003 of 4.4%. For Sub-Saharan Africa, the figures are respectively 327 and 1.4% (FAO 2005). African farmers can compete nor catch up. Emergent urban markets are increasingly captured by food imports, not only because of the price differences but also because local farmers find it difficult to satisfy supermarket criteria (Reardon et al. 2003).

Far from being stagnant, during the past 30 years West African farmers have kept up with rapid population growth, notwithstanding lack of access to fertilisers, the invasion of herbaceous weeds under more permanent land use, reduced rainfall, disease pandemics, and wars (IAC 2004). The global AT condemns these farmers to continue production for largely non-monetary subsistence on increasingly degraded land, using farming systems that are increasingly less resilient given the climate change that will hit West Africa. Export commodity schemes (e.g., cocoa, cotton, organic vegetables) that were all but destroyed under structural adjustment are a rare source of cash. The desperate attempts to emigrate to Europe by Senegalese fishermen, and the wars in Sierra Leone, Liberia and Ivory Coast demonstrate what happens when the next generation cannot replicate the cultural repertoire.

**Conclusion.** The global AT inexorably seems to lead to a scenario of poverty, political instability and suffering. What more, it condemns West African human, land and water resources to degradation instead of helping them to be productive for global food security. 'If you don't want to end up where you are going, you have to change direction'. However, the mechanistic AT model and the relative advantage economics in which it is embedded seem to render agricultural scientists and economists incapable of thinking about, let alone supporting, the institutional change and market protection that have been a precursor to the take-off of the AT in developed market economies (North 2005). The AT is another case of an entrenched model that is a major cause of blindness.

- Bindraban, P. & R. Rabbinge (2005). Development perspectives for agriculture in Africa: technology on the shelf is inadequate. Wageningen: WUR, North-South Discussion Paper.
- Chambers, R. & J. Jiggins (1987). Agricultural Research for resource-poor farmers. Part I: Transfer-of-Technology and Farming Systems Research. Part II: A parsimonious paradigm. *Agric. Administration and Extension*, 27: 35-52 (Part I) and 27: 109-128 (Part II).
- Cochrane, W. (1958). *Farm Prices, Myth and Reality*. Minneapolis: Univ. of Minnesota Press. Chapter 5: The Agricultural Treadmill, pp 85-107.
- Evenson, R.E., P.E. Waggoner and V.W. Ruttan (1979). Economic Benefits from Research: An Example from Agriculture. *Science* 205: 1101-1107.
- FAO (2005). *The state of food and agriculture*. Rome: FAO
- IAC (2004). *Realising the Promise and Potential of African Agriculture*. Amsterdam: Inter-Academy Council.
- Jiggins, J. et al. 1996. Mobilising Science and Technology to Get Agriculture Moving in Africa: A Response to Borlaug and Dowsell, *Development Policy Review*, 13 (1): 89-103.
- Kline, S. & N. Rosenberg (1986). An Overview of Innovation. In: R. Landau and N. Rosenberg (Eds.). *The Positive Sum Strategy*. Washington (DC): National Academic Press, pp 275-306.
- North, D. (2005). *Understanding the Process of Economic Change*. Princeton: Princeton U. P.
- Reardon, T., C.P. Timmer, C.B. Barrett, and J. Berdegue (2003). The rise of supermarkets in Africa, Asia and Latin America. *Am. Journal of Ag. Econ.* 85 (5): 1140-1146(7).

## PARTICIPATORY APPROACHES TO REDUCING NITRATE POLLUTION IN GROUNDWATER: A CASE STUDY FROM MARCHE, ITALY.

Giovanna Seddaiu <sup>1</sup>, Janice Jiggins <sup>2</sup>, Pier Paolo Roggero <sup>1</sup>, Marco Toderi <sup>3</sup>

<sup>1</sup> Dip. Scienze Agronomiche e Genetica Vegetale Agraria, Univ. of Sassari, Sassari, Italy

<sup>2</sup> De Dellen 4, 6673MD, Andelst, The Netherlands

<sup>3</sup> Dip. Scienze Ambientali e delle Produzioni Vegetali, Polytechnic Univ. of the Marche, Ancona, Italy

### Introduction

Agro-ecological research on the nitrate issue is often produced assuming that the outcomes of the research will be used by intermediary bodies, such as extension services, and by policy makers responsible for designing and enforcing appropriate measures to prevent, control or solve the problem. Although researchers have found that a number of site-specific bio-physical and chemical factors influence the diffuse nitrate pollution of agricultural origin at the catchment scale, the regulatory processes implemented by EU since the early 1990s assume that the pollution is driven mainly by excessive use of nitrogen fertilisers and, thus, are based on prescriptions concerning the maximum application rates of manure and nitrogen fertiliser.

The case examined in this paper arose from the identification by a team of agronomy researchers of the main agro-ecological causes of diffuse nitrate pollution in an hilly agricultural area of clayey soil, located in central Italy. Understanding of the complexity of causal interactions was developed further through an assessment of the substantial ineffectiveness of the agro-environmental measures adopted to prevent nitrate leaching. The group's work subsequently evolved into efforts to integrate their research results into various participatory processes aimed at creating more favourable conditions for driving change through both individual and concerted actions.

### Methodology

The case study is based on two micro-catchments located in the communes of Serra de' Conti and Montecarotto (Marche Region, Italy), located upstream of a river catchment. In this area, nitrates were detected above legal thresholds in the water of town waterworks since 1993. In the period 1996-2001, the two communes adopted a special agro-environmental measure, named "action D3", within the agro-environmental scheme of Reg. EC 2078/1992, targeted to the "Protection of water resources". Agronomic surveys and continuous monitoring of the farming practices, water runoff, and water quality were carried out from 1997 in this area, in order to connect farming practices to downstream water runoff and quality, and to identify the most relevant site-specific bio-physical processes driving nitrate pollution of surface water (Roggero and Toderi, 2002). In 2001, researchers were involved in a multi-country study on Social Learning for the integrated management and sustainable use of water at the catchment scale, SLIM (Blackmore *et al.*, 2007). Within this project a series of participatory events were organized that engaged different categories of stakeholders (SHs) in joint reflections on the causes of nitrate pollution, the consequences for their own interests, and possible solutions. The participatory approach expanded to encompass different scales of interaction, from informal meetings with groups of SHs facilitated by the use of dialogical tools (Toderi *et al.*, 2007) such as GIS, aerial photographs, landscape photography, spreadsheet graphs and some simple diagrams, to the involvement of the wider public with a popular theatre event organized during a local festival in Serra de' Conti, witnessed by thousands of people.

### Results

The bio-physical monitoring at micro-catchment scale showed that the regulatory approaches were largely ineffective in the case study area, and that the polluting processes were mainly driven by agricultural practices, characterized by cropping systems with a long bare soil period between the autumn-spring crop (e.g. wheat) and the summer crop (e.g. sunflower), when nitrates released by organic matter mineralization was not balanced by plant nitrate absorption and soil water content was often above field capacity. Throughout the participatory events, the SHs developed a shared focus on the issue moving from a "simplistic" and single view, to a view based on the multiple perspectives of all the participants. Some indicators of the shift in SHs' perspectives were identified. For instance, some inhabitants of Serra de' Conti involved in the participatory sessions moved from the position "*show us how much farmers are polluting*" and "*farmers want just to gain the CAP incentives!*" to "*I was not aware that farming was so difficult*" and "*consumers' choices influence the farming system,*

*what can we do?*". Nitrate pollution became to be considered as an emerging problem of the interaction of a range of bio-physical factors and several other factors, including farmers' market constraints, farmers' choices grounded in their own history, local traditions and the role of farming in the local society. It became clear that there may exist a range of interventions that could be made to change practices and outcomes, beyond regulations and compensation payments. Researchers provided scientific evidences, transformed within participatory events into dialogical tools, in order to make visible any hidden interdependencies of bio-physical processes and, thus, enhance farmers' understanding opportunities and encourage a change toward sustainable practices. The SWOT analysis that emerged from the whole set of participatory events is reported in table 1.

Table 1 – SWOT analysis of the outcomes of the participatory research on the nitrate case study

<p><i>Strengths</i></p> <ul style="list-style-type: none"> <li>- Main criteria for choosing the applied farming practices emerged from interactive sessions with farmers</li> <li>- Roles of SHs and interdependencies emerged creating suitable conditions for change in attitudes and then in practices</li> <li>- Empowerment of SHs through a higher awareness of their role</li> <li>- Communication barriers between scientific community and SHs who directly manage a resource were mostly overcome</li> <li>- The process underlying SHs' and researchers' practices was more transparent than through conventional extension</li> </ul>	<p><i>Weaknesses</i></p> <ul style="list-style-type: none"> <li>- Participatory research was highly time-consuming, to efficiently plan, realize and analyse participatory events</li> <li>- High investments and efforts to guarantee the quality of the facilitation process were required</li> <li>- High investments and efforts to develop an interdisciplinary approach were required</li> </ul>
<p><i>Opportunities</i></p> <ul style="list-style-type: none"> <li>- creation of a SHs' network which opened opportunities for development of sustainable practices</li> <li>- Identification of the constraints hampering the change in practice and the possible strategies to overcome them</li> <li>- Identification of new challenging demand of scientific research</li> <li>- Better quality of the evaluation of the research findings ("internal validity")</li> <li>- Possible increasing of actual application of the research results ("external validity")</li> <li>- Development of research skills, concepts, and theoretical understanding related to multi-stakeholder participatory R&amp;D</li> </ul>	<p><i>Threats</i></p> <ul style="list-style-type: none"> <li>- Conflicts and contrasting stakes could have emerged which could hamper achievement of the objective of sustainable resource management</li> <li>- Biased and partial results if not all the possible perspectives are included throughout all the phases of the research</li> <li>- Seen by some Academic colleagues as irrelevant, or as detracting from good science</li> </ul>

## Conclusions

The failure of the implementation of the regulatory measures in the case study area suggests that insufficient scientific knowledge on site-specific ecological processes controlling the nitrate pollution of agricultural origin and, above all, the poor integration of scientific understanding in policy-making processes and farm-level decisions, could be recognised as main reasons for the failure of agro-environmental prescriptions in preventing nitrate leaching and in driving effective change towards a more sustainable land use and hydrological cycle. For instance, the prescriptions negotiated by the Region, the Farmers' Unions and some key local SHs assumed that mineral fertilisers and chemicals were the main source of pollution, while other causes of nitrates leaching such as mineralisation and lack of ground cover in the rainy season, were almost ignored. However, the development of site-specific scientific knowledge, even if necessary to interpret nitrate pollution causes and identify effects and possible technical solutions, was not sufficient to drive and support changes in practices towards effective water conservation in the specific local context. An effective, well designed interaction process between researchers and SHs, enriched the researchers' views of causation, for instance, on what kind of constraints were seen by SHs as influencing their practices and what sort of knowledge was relevant in their choices. So the SHs' experience and information served to expand considerably the boundaries of what the researchers – and policy makers – needed to take into account.

## References

- Blackmore C. et al., 2007. Social learning: an alternative policy instrument for managing in the context of Europe's water. *Environ. Sci. Policy*, 10, 6 (in press).
- P.P. Roggero and M. Toderi, 2002. Quaderni 5B, Assam, Ancona.
- M. Toderi et al., 2007. Combining social learning with agro-ecological research practice for more effective management of nitrate pollution. *Environ. Sci. Policy*, (in press).

## Perspectives for integrating trees into Swiss agricultural landscapes – farmer innovation and bio-economic modeling

F. Sereke, J. Palma, F. Herzog

Agroscope Research Station ART, Reckenholzstrasse 191, CH-8046 Zürich

[firesenai.sereke@art.admin.ch](mailto:firesenai.sereke@art.admin.ch)

### Introduction

Trees in Swiss agricultural landscapes were common and played an important role for producing various products like timber and fruits. High-stem trees are also important for sustainable agriculture with regard to biodiversity as well as soil and groundwater protection (Nair, 1993; Palma, et al., 2007, Reisner, et al. 2007). Moreover, tree based intercropping systems have the potential to sequester atmospheric carbon (C) in trees and soil (Montagnini and Nair, 2004; Peichel et al., 2006). Still, the number of trees in Swiss agricultural landscapes strongly declined during the 20th century (75% since 1951, BFS, 2001), mainly due to agricultural intensification and economic pressure. Currently, the massive outbreak of the fire blight disease is destroying numerous trees. If no measures to promote the sustainable integration of trees are introduced, original landscapes like the north-western Jura or parts of north-eastern Switzerland are threatened (Ferjani and Mann, 2007). The aim of the project is to explore perspectives for integrating trees into Swiss agricultural landscapes in close cooperation with local stakeholders and scientific experts. In this paper an overview of the transdisciplinary approach and preliminary results of the first project phase will be presented. Topics like farmer innovation, bio-economic modeling and synergistic learning in the context of participatory land use improvement shall be discussed.

### Methodology

The research is supported by an interdisciplinary team of farmers, scientific experts and public administration. Workshops are conducted on a regular basis to discuss relevant issues and to disseminate the results. We will combine bio-economic modeling with survey and networking activities, based on a transdisciplinary approach in three steps.

*(i) Survey and networking: Survey of farmers' innovation activities, yielding an inventory of alternative tree-crop or tree-grass approaches developed by farmers and practitioners.* The objective is to explore best practice for integrating trees into Swiss agriculture, based on case studies on farmer innovations and relevant expert knowledge. Important steps in establishing improved agroforestry systems like selecting site adapted tree species will be documented and used as input factors in the bio-economic modeling.

*(ii) Bio-economic modeling: Assessing the profitability and environmental benefits of alternative farming systems under contrasting soil and climate conditions.* Traditional and alternative agroforestry systems will be assessed using the biophysical model Yield-SAFE (Van der Werf et al., 2007) for a sixty year cycle. The simulated yields of trees and crops will then be used as input for the bio-economic model Farm-SAFE (Graves et al., 2007). Scenarios will be simulated and discussed with land users to find management strategies that achieve best production and profit levels.

*(iii) Target regions: Proposing viable tree-based farming systems for regions in Switzerland where they can potentially yield social, environmental and economic benefits.* Potential landscape sites will be identified using the results of a GIS based agroforestry suitability classification, developed under the current project. Land users' and policy makers' perceptions determine the adoption of alternative systems. With the Analytic Hierarchy Process (AHP) we can study the perceptions of individuals in a structured decision process (Saaty, 1990). The AHP decision tool uses both qualitative and quantitative data for applications to decision situations involving multiple-criteria. In order to select the best alternative, each land use option will be evaluated for the potential target regions and the alternative that scores highest will be recommended for implementation.



## Expected results

The anticipated output of the research project is a detailed information and evaluation platform on tree-based farming systems and their potential environmental and economical benefits for Swiss agriculture. The second expected output is a scientific approach for knowledge management and interdisciplinary synergistic learning through networking and exchange of know-how. Finally, we hope to understand the facilitation processes for agroforestry development in Swiss agriculture (Figure 1). The expected results should provide the basis for recommendations on collective action and agroforestry policy.

- The results will be published and factsheets on farmer innovations prepared in order to discuss and diffuse knowledge from best practice cases;
- Maps on potential target regions for tree integration will be produced;
- Scenarios on land use change will be developed and evaluated, integrating the perceptions of different actors;
- Recommendations for land users and policy makers shall be derived.

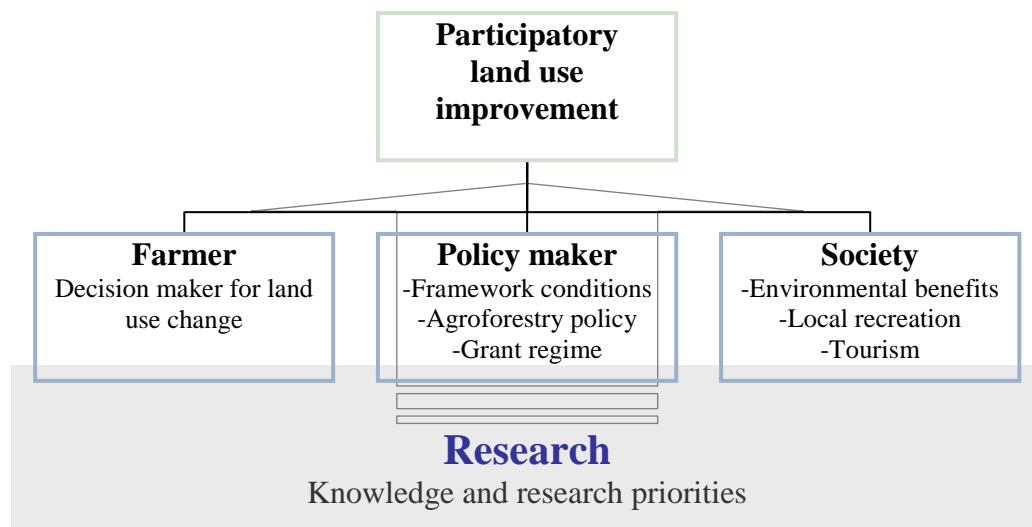

Figure 1: Actors and structures for collective action. Understanding knowledge systems and facilitation processes in agroforestry development.

## References

- BFS, Schweizerische Obstbaumzählung 1951, 1961, 1971, 1981, 1991 und 2001. Neuchatel, Bundesamt für Statistik.
- A. Ferjany and S. Mann, Abschaffung der Exportsubventionen für Kernobstsaftkonzentrat, 2007. *Agrar Forschung* 14 (5), 218-223.
- A. Graves et al., The development and application of bio-economic modelling for silvoarable systems in Europe, 2007. *Ecological Engineering* 29, 434-449.
- F. Montagnini and P. K. R. Nair, Carbon sequestration: An underexploited environmental benefit of agroforestry systems, 2004. *Agroforestry Systems* 61, 281–295.
- P.K.R. Nair, *An Introduction to Agroforestry*, 1993. Kluwer, The Netherlands, 499 pp.
- J. Palma et al., Modelling environmental benefits of silvoarable agroforestry in Europe, 2007. *Agriculture Ecosystems & Environment* 119, 320-334.
- M. Peichl, et al., Carbon sequestration potentials in temperate tree-based intercropping systems, southern Ontario, Canada, 2006. *Agroforestry Systems*, 66, 243-257.
- Y. Reisner et al., Target regions for silvoarable agroforestry in Europe, 2007. *Ecological Engineering* 29, 401-418.
- T.L. Saaty, *Multicriteria decision making - the analytic hierarchy process*. Planning, priority setting, resource allocation, 1990. RWS Publishing, Pittsburgh, 502pp.
- W. van der Werf et al., Yield-SAFE: a parameter-sparse process-based dynamic model for predicting resource capture, growth and production in agroforestry systems, 2007. *Ecological Engineering* 29, 419-433.

## HOW TO DESIGN A MODEL FOR PROTOTYPING CROPPING SYSTEMS? EXAMPLE OF SIMBA FOR BANANA-BASED SYSTEMS

P. Tixier<sup>1</sup>, E. Malézieux<sup>2</sup>, M. Dorel<sup>3</sup>, F.X. Cote<sup>4</sup>, J. Wery<sup>5</sup>

<sup>1</sup> CIRAD, UPR 26, PRAM, Lamentin, Martinique, French West Indies, France, [tixier@cirad.fr](mailto:tixier@cirad.fr)

<sup>2</sup> CIRAD, UMR 1230 SYSTEM, Montpellier, France, [malezieux@cirad.fr](mailto:malezieux@cirad.fr)

<sup>3</sup> CIRAD, UPR 26, Capesterre, Guadeloupe, French West Indies, France, [dorel@cirad.fr](mailto:dorel@cirad.fr)

<sup>4</sup> CIRAD, UPR 26, Montpellier, France, [cote@cirad.fr](mailto:cote@cirad.fr)

<sup>5</sup> Sup Agro, UMR 1230 SYSTEM, Montpellier, France, [wery@supagro.inra.fr](mailto:wery@supagro.inra.fr)

### Introduction

Using models to design cropping systems is of growing interest but it cannot rely only on existing crop models (Keating et al., 2003; Stöckle et al., 2003) because they do not necessarily cover the major limiting factors and the major externalities in a given context. It may be better to develop an *ad hoc* model, which captures the specificities of the cropping system, using generic knowledge, local data, and expert knowledge. The model should also produce the indicators, which are relevant to assess the sustainability of the system. The example of the SIMBA model, especially dedicated to banana-based cropping systems simulation and prototyping in French West Indies, illustrates our approach. Here, we present the methodology used to build the model and the indicators used to assess the simulated systems. We discuss the choices of modeling precision, we particularly focus on the trade-offs between high precision formalisms demanding in parameters and calibration, and simple formalisms that rise to easier calibration and use but with less accuracy or smaller ranges of validity.

### Model description

The SIMBA model, was developed in the Stella platform, it includes modules that account for the major processes. It simulates, at the week time-step, the effects of crop rotations and agromanagement on soil, water, nematode, yield, and economic outputs with a sound balance between representation of the major phenomena and keeping the model simple to reduce the parameterization costs. Instead of starting from an existing crop model, adapting it to the banana-nematodes system, and deriving some indicators from the output variables, we created a new model to produce the assessment indicators based on existing knowledge. The evaluation criteria of the simulated systems were profit margin and environmental risks. Consequently, the yield and the state variables of the system, and their dynamics, were taken into account in order to generate these outputs. Two types of formalism were developed to compute these variables. For processes that can be simulated biophysically, process-based modules were developed. These included plant growth, plant population structure, soil cover, physical soil properties, water balance, and plant-parasitic nematode population densities. For processes that cannot be simulated biophysically, semi-qualitative indicators based on expert systems and fuzzy logic were developed, using some of the outputs of the biophysical modules. The biophysical system is driven by a technical system (as defined by Lançon et al., 2007) that can be generated by decision rules or forced by the user. Contrary to the structure of traditional cropping system models, the core of SIMBA is the plant population module SIMBA-POP (Tixier et al. 2004). It allows simulating the evolution of the banana population over years. Indeed, the initially homogeneous plant population becomes heterogeneous after few cropping cycles, i.e. plants in the field can be at different phenological stages at the same time. This process has a central influence on crop yield and on water and nitrogen balances, soil cover, pest dynamics, and labour uses. Linked to the module, the growth module SIMBA-GROW is calculated separately for each cohort defined in SIMBA-POP. This module includes simulation of leaf area index (LAI), vegetative biomass (leaves, pseudo-stem, roots), and yield (number and weight of fruits per bunch). The nematode population dynamics are simulated with the SIMBA-NEM module (Tixier et al., 2006); it was calibrated for *Radopholus similis* and *Pratylenchus coffeae*, which are the plant-parasitic nematodes that generate the most extensive root lesions and that are considered among the most detrimental pathogens of banana. This module is based on a cohort chain structure and a logistic function to describe population growth in relation with i) an environmental carrying capacity depending on the available banana root biomass, ii) an intrinsic

growth rate, and iii) the interspecific competition. Soil water content and nematicide applications are considered the main variables influencing the intrinsic population growth rate of each species. This module illustrates how we integrated all the knowledge available to account for one major biological process that usual models cannot simulate. Expert knowledge was also used in the linkage of different module. For instance, the calculation of stresses for growth includes fuzzy logic rules to account for the effect of nematodes populations, drought, or soil compaction. Another specificity of the SIMBA framework is the necessity to assess the simulated system on the basis on their environmental risks. Thus, we developed a pollution risk indicator called Rpest (Tixier et al., 2007) using existing methods of evaluation (Girardin et al., 2000) that we adapted to the tropical context and to their application within a modeling framework. Rpest provides dynamic assessments through a linkage with the biophysical modules of SIMBA that simulate state variables of the system. We conducted an expert validation; it demonstrated that Rpest ranks cropping systems by risk as well as experts do. Using the same method, we built indicators to assess the soil fertility and the erosion risk (Rfert and Rero). To be able to simulate a generic cropping systems the model is driven by farmer's decision rules. These rules allow accounting for the decision process of the farmer in reaction to the system evolution and not only a scheduled calendar of task as most models do. The global structure of the SIMBA model (Figure 1) shows this comprehensive and specific approach of the cropping system simulation. These decision rules interact with the state variables of the systems. Finally, a multicriteria evaluation permits through a weighting procedure to rank all the simulated systems.

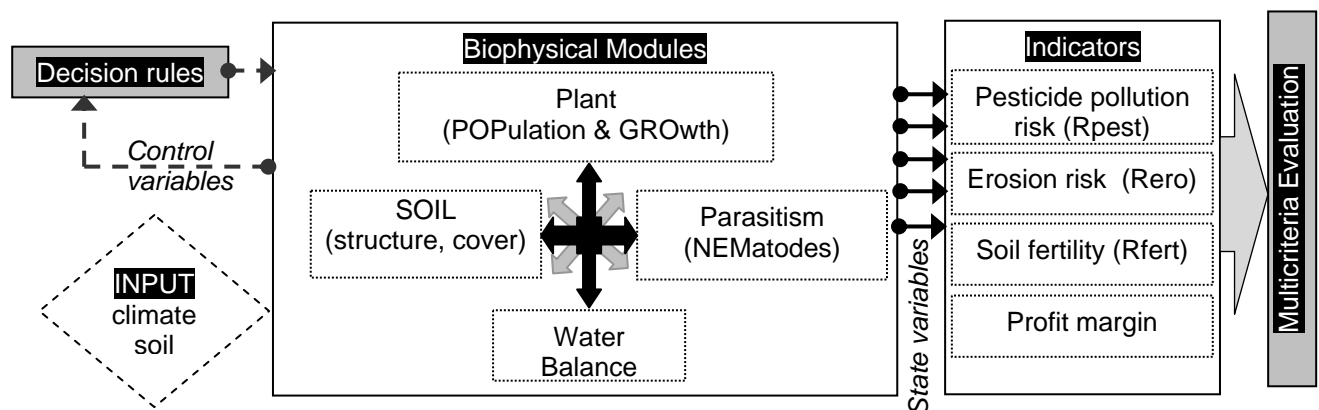

**Figure 1.** Simplified structure of the SIMBA framework

## Conclusions

This example provides evidence that an early integration of expected outputs needed for prototyping within the model allows a more efficient design and assessment of cropping systems. This methodology of prototyping sustainable cropping systems is generic and aims to be applied to other complex agro-ecosystems in other contexts, where sufficient knowledge and local data are available.

## References

- P.Girardin et al., Assessment of potential impacts of agricultural practices on the environment: the AGRO\*ECO method, 2000. Environmental Impact Assessment Review 20, 227-239
- B.A.Keating et al., An overview of APSIM, a model designed for farming systems simulation, 2003. Eur. J. Agron. 18, 267-288
- J.Lançon et al., An improved methodology for integrated crop management systems, 2007. Agron. Sustain. Dev. 27, 101-110
- C.O.Stöckle et al., CropSyst, a cropping systems simulation model, 2003. Eur. J. Agron. 18, 289-307
- P.Tixier et al., Rpest a dynamic indicator to assess pesticide water pollution risk. Application to banana-based cropping systems in FWI, 2007. Europ. J. Agron, 26, 71-81
- P.Tixier et al., Modelling populations of banana phytoparasitic nematodes: a contribution to the design of sustainable cropping systems, 2006. Ecol. Model. 198, 321-331
- P.Tixier et al., SIMBA-POP: a cohort population model for long-term simulation of banana crop harvest, 2004. Ecol. Model. 180, 407-417