



**HAL**  
open science

# A coherence theorem for pseudonatural transformations

Maxime Lucas

► **To cite this version:**

| Maxime Lucas. A coherence theorem for pseudonatural transformations. 2015. hal-01191867v1

**HAL Id: hal-01191867**

**<https://hal.science/hal-01191867v1>**

Preprint submitted on 3 Sep 2015 (v1), last revised 31 Aug 2016 (v2)

**HAL** is a multi-disciplinary open access archive for the deposit and dissemination of scientific research documents, whether they are published or not. The documents may come from teaching and research institutions in France or abroad, or from public or private research centers.

L'archive ouverte pluridisciplinaire **HAL**, est destinée au dépôt et à la diffusion de documents scientifiques de niveau recherche, publiés ou non, émanant des établissements d'enseignement et de recherche français ou étrangers, des laboratoires publics ou privés.

# A coherence theorem for pseudonatural transformations

Maxime LUCAS

August 5, 2015

## Abstract

We prove coherence theorems for bicategories, pseudofunctors and pseudonatural transformations. These theorems boil down to proving the coherence of some free  $(4, 2)$ -categories. In the case of bicategories and pseudofunctors, existing rewriting techniques based on Squier's Theorem allow us to conclude. In the case of pseudonatural transformations this approach only proves the coherence of part of the structure, and we use a new rewriting result to conclude.

## Contents

<b>1</b>	<b>Higher-dimensional rewriting</b>	<b>4</b>
1.1	Polygraphs . . . . .	4
1.2	Termination . . . . .	5
1.3	Branchings and Confluence . . . . .	5
1.4	Coherence . . . . .	6
<b>2</b>	<b>Application to the coherence of pseudonatural transformations</b>	<b>9</b>
2.1	Coherence for bicategories . . . . .	9
2.2	Coherence for pseudofunctors . . . . .	13
2.3	Coherence for pseudonatural transformations . . . . .	16
<b>3</b>	<b>Proof of the coherence for pseudonatural transformations</b>	<b>21</b>
3.1	A convergent sub-polygraph of $\mathbf{PNTrans}[\mathbf{f}, \mathbf{g}]$ . . . . .	21
3.2	A sub-polygraph of $\mathbf{PNTrans}[\mathbf{f}, \mathbf{g}]$ satisfying 2-Squier condition of rank 2 . . . . .	22
3.3	Adjunction of the units 2-cells . . . . .	26
3.4	Adjunction of the units 3-cells . . . . .	28
<b>4</b>	<b>Partial coherence and transformation of polygraphs</b>	<b>33</b>
4.1	White-categories and White-polygraphs . . . . .	33
4.2	Injective functors between white-categories . . . . .	36
4.3	Partial coherence in pointed $(4, 3)$ -white-categories . . . . .	41
<b>5</b>	<b>Transformation of a <math>(4, 2)</math>-polygraph into a <math>(4, 3)</math>-white-polygraph</b>	<b>44</b>
5.1	Weakening of the exchange law . . . . .	44
5.2	Weakening of the invertibility of 3-cells . . . . .	47
5.3	Adjunction of formal inverses to 2-cells . . . . .	48
5.4	Adjunction of connections between 2-cells . . . . .	49
5.5	Reversing the presentation of a $(4, 3)$ -white-category . . . . .	53
<b>6</b>	<b>Proof of Theorem 1.27</b>	<b>57</b>
6.1	Local coherence . . . . .	57
6.2	Orderings on the cells of $\mathcal{F}^{\mathbf{w}}$ . . . . .	59
6.3	Partial coherence of $\mathcal{F}^{\mathbf{w}(3)}$ . . . . .	62

## Introduction

A mathematical structure, such as the notion of monoid or algebra, is often defined in terms of some data satisfying relations. In the case of monoids, the data is a set and a binary application, and the relations are the associativity and the unit axioms. In category theory, one often considers relations that only hold *up to isomorphism*. One of the simplest example of such structure is that of monoidal categories, in which the product is not associative, but instead there exist isomorphisms  $\alpha_{A,B,C} : (A \otimes B) \otimes C \rightarrow A \otimes (B \otimes C)$ . This additional data must also satisfy some relation, known as Mac-Lane’s pentagon:

$$\begin{array}{ccc}
 (A \otimes (B \otimes C)) \otimes D & \xrightarrow{\alpha_{A,B \otimes C,D}} & A \otimes ((B \otimes C) \otimes D) \\
 \alpha_{A,B,C} \otimes D \nearrow & & \searrow A \otimes \alpha_{B,C,D} \\
 ((A \otimes B) \otimes C) \otimes D & = & A \otimes (B \otimes (C \otimes D)) \\
 \alpha_{A \otimes B,C,D} \searrow & & \nearrow \alpha_{A,B,C \otimes D} \\
 (A \otimes B) \otimes (C \otimes D) & & 
 \end{array}$$

The intended purpose of this relation is that, between any two bracketings of  $A_1 \otimes A_2 \otimes \dots \otimes A_{n-1} \otimes A_n$ , there exists an isomorphism constructed from the isomorphisms  $\alpha_{A,B,C}$ , and that any two such composites are equal. This statement was made precise and proved by MacLane in the case of monoidal categories [11]. In general a *coherence theorem* contains a description of a certain class of diagrams that are to commute. Coherence theorems exist for various other structures, e.g. bicategories [12], or  $V$ -natural transformations for a symmetric monoidal closed category  $V$  [10].

Coherence results are often a consequence of (arguably more essential [9]) *strictification theorems*. A strictification theorem states that a “weak” structure is equivalent to a “strict” (or at least “stricter”) one. For example any bicategory is biequivalent to a 2-category, and the same is true for pseudofunctors (this is a consequence of this general strictification result [14]). It does not hold however for pseudonatural transformations.

Rewriting techniques can also be applied in order to prove coherence theorems [7]. The link between coherence and rewriting goes back to Squier’s homotopical Theorem [15], and has since been expanded upon [6]. Squier’s theory is constructive, which means that the coherence conditions can be calculated from the relations, in a potentially automatic way. It can also be expanded to higher dimensions [8], a feature that may prove useful when studying weaker structures.

In this article, we prove coherence results for bicategories, pseudofunctors and pseudonatural transformations (see [2] for a definition of all these notions). Let us give an outline of the proof in the case of categories equipped with an associative tensor product. This proof follows closely that of [7] for monoidal categories.

The structure is encoded into a free  $(4, 2)$ -category  $\mathbf{Assoc}^{*(2)}$  generated by a  $(4, 3)$ -polygraph  $\mathbf{Assoc}$ . Polygraphs are presentations for higher-dimensional categories and were introduced by Burroni [3], and by Street under the name of computads [16] [17]. In this paper we use Burroni’s terminology, as is custom in rewriting. The  $(4, 3)$ -polygraph  $\mathbf{Assoc}$  contains one generating 2-cell  $\nabla$  coding for product, one generating 3-cell  $\triangleleft : \triangleleft \Rightarrow \triangleleft$  coding for associativity and one generating 4-cell  $\triangleleft$  corresponding to MacLane’s pentagon. The coherence result for categories equipped with an associative product is now reduced to showing that, between every parallel 3-cells  $A, B$  in  $\mathbf{Assoc}_3^{*(2)}$ , there exists a 4-cell  $\alpha : A \rightarrow B$  in  $\mathbf{Assoc}_4^{*(2)}$ . A 4-category satisfying this property is said to be *3-coherent*. We then use a result from Guiraud and Malbos [6], which states that for a 3-terminating and 3-confluent polygraph  $\Sigma$ , if the 4-cells correspond to the critical pairs then  $\Sigma^{*(2)}$  is 3-coherent. A critical pair is a minimal overlap of two distinct rewriting steps. The 4-polygraph  $\mathbf{Assoc}$  satisfies those hypotheses, the

only critical pair corresponding to MacLane’s pentagon:

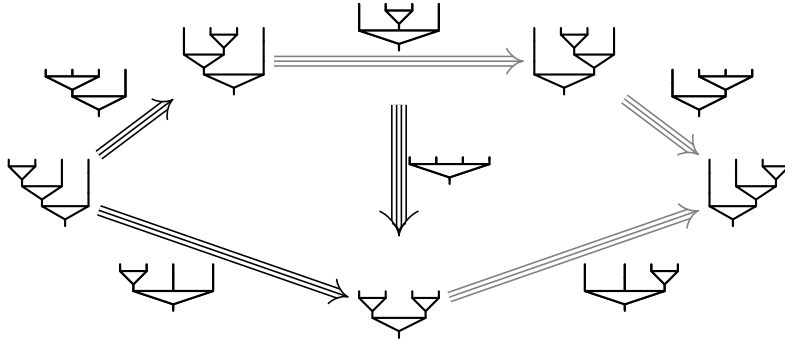

This reasoning can be applied to both bicategories and pseudofunctors, however it fails to work in the case of pseudonatural transformations, because the polygraph  $\mathbf{PNTrans}$  encoding the structure is not 3-confluent. In order to adapt the proof, we use Theorem 1.27.

This theorem relies on the property of the rewriting system generated by the 2-cells (instead of the 3-cells). For example in the case of  $\mathbf{Assoc}$ , the 2-cells form a 2-terminating and 2-confluent rewriting system. Moreover the only critical pair corresponds to the associativity 3-cell, and the only critical triple to MacLane’s pentagon:

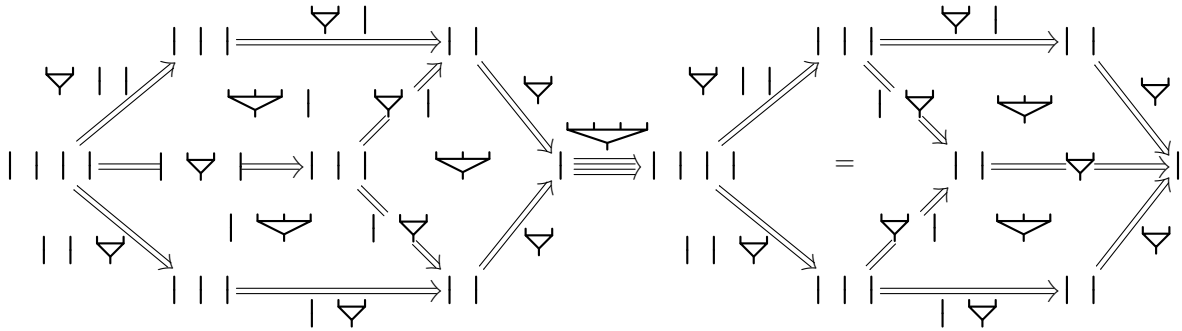

By Theorem 1.27, this implies that between any parallel 3-cells  $A, B$  in  $\mathbf{Assoc}_3^{*(2)}$ , if their 1-target is a normal form, then there exists a 4-cell  $\alpha : A \rightarrow B$  in  $\mathbf{Assoc}_4^{*(2)}$ . This result is slightly weaker than the previous one because of the additional hypothesis on  $A$  and  $B$ . However here the 3-cell whose target is a normal form are those whose target is  $\downarrow$ , that is those that correspond to one composite of coherence isomorphisms. Thus the coherence result on categories equipped with an associative tensor product still holds.

In Section 1, we recall some classical definitions and results from rewriting theory, and we enunciate (without proof) Theorem 1.27. In Section 2, we construct the free categories encoding the structures we want to study, and prove the coherence Theorems for bicategories (Theorem 2.6) and pseudofunctors (Theorem 2.13). The proof uses a lot of notions defined in the previous section and relies in particular on Squier’s Theorem to conclude. There remains to show the coherence of pseudonatural transformations (Theorem 2.21), which is done in Section 3. To prove Theorem 2.21, we show that a fragment of the structure of pseudonatural transformations satisfies the hypotheses of Squier’s theorem while an other satisfies the hypotheses of Theorem 1.27, which is temporarily admitted. The following sections contain the proof of Theorem 1.27. The first half of the proof consists in applying a series of transformations to a  $(4, 3)$ -polygraph satisfying the hypotheses of Theorem 1.27. In Section 4, we set up the theory behind these transformations, and the transformations themselves are performed in Section 5. The combinatorics of the result of these transformations is analysed in Section 6 where we conclude the proof.

# 1 Higher-dimensional rewriting

We recall definitions and results from rewriting theory. Section 1.1 is devoted to polygraphs, which are presentations of higher-dimensional categories. In Section 1.2, we define termination and enunciate Theorem 1.8 which we will use throughout Sections 2 and 3 in order to prove the 3-termination of polygraphs. In Section 1.3 we define the notion of branchings and classify them, which allows for a simple criterion to prove the  $n$ -confluence of a polygraph. Finally in Section 1.4, we define the  $n$ -Squier condition, and recall Squier's homotopical theorem, in a generalized form proven in [6]. We conclude this section by enunciating Theorem 1.27, whose proof will occupy Sections 4 to 6. Except for Theorem 1.27, the proof of every result in this section can be found in [6].

## 1.1 Polygraphs

We recall the definition of Polygraphs from [3]. Let  $\mathbf{Cat}_n$  be the category of  $n$ -categories, and  $\mathbf{Graph}_n$  the category of  $n$ -graphs. The category of  $n$ -categories equipped with a cellular extension, noted  $\mathbf{Cat}_n^+$ , is the limit of the following diagram:

$$\begin{array}{ccc} \mathbf{Cat}_n^+ & \longrightarrow & \mathbf{Graph}_{n+1} \\ \downarrow & \lrcorner & \downarrow \\ \mathbf{Cat}_n & \longrightarrow & \mathbf{Graph}_n \end{array}$$

where the functor  $\mathbf{Cat}_n \rightarrow \mathbf{Graph}_n$  forgets the categorical structure and the functor  $\mathbf{Graph}_{n+1} \rightarrow \mathbf{Graph}_n$  deletes the top-dimensional cells.

Hence an object of  $\mathbf{Cat}_n^+$  is a couple  $(\mathcal{C}, G)$  where  $\mathcal{C}$  is an  $n$ -category and  $G$  is a graph  $\mathcal{C}_n \xleftarrow[\mathbf{t}]{\mathbf{s}} \mathcal{S}_{n+1}$ , where  $\mathbf{s}$  and  $\mathbf{t}$  must satisfy some compatibility conditions with the source and target operations in  $\mathcal{C}$ .

Let  $\mathcal{R}_n$  be the functor from  $\mathbf{Cat}_{n+1}$  to  $\mathbf{Cat}_n^+$  that sends an  $(n+1)$ -category  $\mathcal{C}$  on the couple  $(\mathcal{C}_n, \mathcal{C}_n \xleftarrow{\quad} \mathcal{C}_{n+1})$ . This functor admits a left-adjoint  $\mathcal{L}_n : \mathbf{Cat}_n^+ \rightarrow \mathbf{Cat}_{n+1}$  (see [13]).

We now define by induction on  $n$  the category  $\mathbf{Pol}_n$  of  $n$ -polygraphs together with a functor  $\mathcal{Q}_n : \mathbf{Pol}_n \rightarrow \mathbf{Cat}_n$ .

- The category  $\mathbf{Pol}_0$  is the category of sets, and  $\mathcal{Q}_0$  is the identity functor.
- Assume  $\mathcal{Q}_n : \mathbf{Pol}_n \rightarrow \mathbf{Cat}_n$  is defined. Then  $\mathbf{Pol}_{n+1}$  is the limit of the following diagram:

$$\begin{array}{ccc} \mathbf{Pol}_{n+1} & \longrightarrow & \mathbf{Cat}_n^+ \\ \downarrow & \lrcorner & \downarrow \\ \mathbf{Pol}_n & \xrightarrow{\mathcal{Q}_n} & \mathbf{Cat}_n \end{array}$$

and  $\mathcal{Q}_{n+1}$  is the composite

$$\mathbf{Pol}_{n+1} \longrightarrow \mathbf{Cat}_n^+ \xrightarrow{\mathcal{L}_n} \mathbf{Cat}_{n+1}$$

**Definition 1.1.** Given an  $n$ -polygraph  $\Sigma$ , the  $n$ -category  $\mathcal{Q}_n(\Sigma)$  is noted  $\Sigma^*$  and is called *the free  $n$ -category generated by  $\Sigma$* .

**Definition 1.2.** An  $(n, k)$ -category is an  $n$ -category which has every  $(i+1)$ -cell invertible for the  $i$ -composition, for  $i \geq k$ . We note  $\mathbf{Cat}_n^{(k)}$  the full subcategory of  $\mathbf{Cat}_n$  whose objects are the  $(n, k)$ -categories.

In particular  $\mathbf{Cat}_n^{(0)}$  is the category of  $n$ -groupoids, and  $\mathbf{Cat}_n^{(n)} = \mathbf{Cat}_n$ .

The functor  $\mathcal{R}_n$  restricts to a functor  $\mathcal{R}_n^{(n)}$  from  $\mathbf{Cat}_{n+1}^{(n)}$  to  $\mathbf{Cat}_n^+$ . Once again this functor admits a left-adjoint  $\mathcal{L}_n^{(n)} : \mathbf{Cat}_n^+ \rightarrow \mathbf{Cat}_{n+1}^{(n)}$ . We define categories  $\mathbf{Pol}_n^{(k)}$  of  $(n, k)$ -polygraphs and functors  $\mathcal{Q}_n^{(k)} : \mathbf{Pol}_n^{(k)} \rightarrow \mathbf{Cat}_n^{(k)}$  in a similar way to  $\mathbf{Pol}_n$  and  $\mathcal{Q}_n$ .

**Definition 1.3.** Given an  $(n, k)$ -polygraph  $\Sigma$ , the  $(n, k)$ -category  $\mathcal{Q}_n^{(k)}(\Sigma)$  is noted  $\Sigma^{*(k)}$  and is called *the free  $(n, k)$ -category generated by  $\Sigma$* .

**Definition 1.4.** Let  $\mathcal{C}$  be an  $(n+1, k)$ -category. We note  $\bar{\mathcal{C}}$  the  $(n, k)$ -category  $\mathcal{C}_n/\mathcal{C}_{n+1}$ .

Let  $\Sigma$  be an  $(n+1, k)$ -polygraph. We note  $\bar{\Sigma}$  the  $(n, k)$ -category  $\overline{\Sigma^{*(k)}}$  and call it the  $(n, k)$ -category presented by  $\Sigma$ .

## 1.2 Termination

**Definition 1.5.** Let  $\Sigma$  be an  $n$ -polygraph, and  $k \leq n$ . The binary relation  $\rightarrow_k^*$  defined by  $u \rightarrow_k^* v$  if there exists  $f : u \rightarrow v$  in  $\Sigma_k^*$  is a preorder on  $\Sigma_{k-1}^*$  (transitivity is given by composition, and reflexivity by the units). We say that the  $n$ -polygraph  $\Sigma$  is  *$k$ -terminating* if  $\rightarrow_k^*$  is a well-founded ordering. We note  $\rightarrow_k^+$  the strict ordering associated to  $\rightarrow_k^*$ .

We recall Theorem 4.2.1 from [6], which we will use in order to show the 3-termination of some polygraphs.

**Definition 1.6.** Let **sOrd** be the 2-category with one object, whose 1-cells are partially ordered sets, whose 2-cells are monotonic functions and which 0-composition is the cartesian product.

**Definition 1.7.** Let  $\mathcal{C}$  be a 2-category,  $X : \mathcal{C}_2 \rightarrow \mathbf{sOrd}$  and  $Y : \mathcal{C}_2^{\text{co}} \rightarrow \mathbf{sOrd}$  two 2-functors, and  $M$  a commutative monoid. An  $(X, Y, M)$ -*derivation* on  $\mathcal{C}$  is given by, for every 2-cell  $f \in \mathcal{C}_2$ , an application

$$d(f) : X(\mathbf{s}(f)) \times Y(\mathbf{t}(f)) \rightarrow M,$$

such that for every 2-cells  $f_1, f_2 \in \mathcal{C}_2$ , every  $x, y, z$  and  $t$  respectively in  $X(\mathbf{s}(f_1)), Y(\mathbf{t}(f_1)), X(\mathbf{s}(f_2))$  and  $Y(\mathbf{t}(f_2))$ , the following equalities hold:

$$d(f_1 \star_1 f_2)[x, t] = d(f_1)[x, Y(f_2)[y]] + d(f_2)[X(f_1)[x], y]$$

$$d(f_1 \star_0 f_2)[(x, z), (y, t)] = d(f_1)[x, y] + d(f_2)[z, t].$$

In order to show the 3-termination of some polygraphs, we are going to use the following result (Theorem 4.2.1 from [6]).

**Theorem 1.8.** *Let  $\Sigma$  be an  $n$ -polygraph,  $X : \Sigma_2^* \rightarrow \mathbf{sOrd}$  and  $Y : (\Sigma_2^*)^{\text{co}} \rightarrow \mathbf{sOrd}$  two 2-functors, and  $M$  be a commutative monoid ordered by a terminating order  $\geq$ , and whose addition is strictly monotonous in both arguments.*

*Suppose that for every 3-cell  $A \in \Sigma_3$ , the following inequalities hold:*

$$X(\mathbf{s}(A)) \geq X(\mathbf{t}(A)) \quad Y(\mathbf{s}(A)) \geq Y(\mathbf{t}(A)) \quad d(\mathbf{s}(A)) > d(\mathbf{t}(A)).$$

*Then the  $n$ -polygraph  $\Sigma$  is 3-terminating.*

## 1.3 Branchings and Confluence

**Definition 1.9.** Let  $\Sigma$  be an  $n$ -polygraph. A  *$k$ -fold branching* of  $\Sigma$  is a  $k$ -tuple  $(f_1, f_2, \dots, f_k)$  of  $n$ -cells in  $\Sigma^*$  such that every  $f_i$  has the same source  $u$ , which is called *the source of the branching*.

The symmetric group  $S_k$  acts on the set of all  $k$ -fold branchings of  $\Sigma$ . The equivalence class of a branching  $(f_1, f_2, \dots, f_k)$  is noted  $[f_1, f_2, \dots, f_k]$ . Such an equivalence class is called a  *$k$ -fold symmetrical branching*.

**Definition 1.10.** Let  $\Sigma$  be an  $n$ -polygraph. We note  $\mathbb{N}$  the  $n$ -category with exactly one  $k$ -cell for every  $k < n$ , whose  $n$ -cells are the natural numbers and whose compositions are given by addition.

The *length* of an  $n$ -cell in  $\Sigma_n^*$  is given by the functor  $\ell : \Sigma^* \rightarrow \mathbb{N}$  defined by setting  $\ell(f) = 1$  for every  $f \in \Sigma_n$ .

An  $n$ -cell of length 1 in  $\Sigma_n^*$  is also called a *rewriting step*.

**Definition 1.11.** Let  $\Sigma$  be an  $n$ -polygraph. A  $k$ -fold local branching of  $\Sigma$  is a  $k$ -fold branching  $(f_1, f_2, \dots, f_k)$  of  $\Sigma$  where every  $f_i$  is a rewriting step.

A  $k$ -fold local branching  $(f_1, \dots, f_k)$  of source  $u$  is a *strict aspherical branching* if there exists an integer  $i$  such that  $f_i = f_{i+1}$ . We say that it is an *aspherical branching* if it is in the equivalence class of a strict aspherical branching.

A  $k$ -fold local branching  $(f_1, \dots, f_k)$  is a *strict Peiffer branching* if it is not aspherical and there exist  $v_1, v_2 \in \Sigma_{n-1}^*$  such that  $u = v_1 \star_i v_2$ , an integer  $m < n$  and  $f'_1, \dots, f'_n \in \Sigma_n^*$  such that for every  $j \leq m$ ,  $f_j = f'_j \star_i v_2$  and for every  $j > m$ ,  $f_j = v_1 \star_i f'_j$ . It is a *Peiffer branching* if it is in the equivalence class of a strict Peiffer branching.

A local branching that is neither aspherical nor Peiffer is *overlapping*.

Given an  $n$ -polygraph  $\Sigma$ , one defines an order  $\subseteq$  on  $k$ -fold local branchings by saying that  $(f_1, \dots, f_k) \subseteq (u \star_i f_1 \star_i v, \dots, u \star_i f_k \star_i v)$  for every  $u, v \in \Sigma_{n-1}^*$  and every  $k$ -fold local branching  $(f_1, \dots, f_k)$ .

**Definition 1.12.** An overlapping branching that is minimal for  $\subseteq$  is a *critical branching*.

A 2-fold (resp. 3-fold) critical branching is also called a *critical pair* (resp. *critical triple*).

**Definition 1.13.** Let  $\Sigma$  be an  $n$ -polygraph. A 2-fold branching  $(f, g)$  is *confluent* if there are  $f', g' \in \Sigma_n^*$  of the following shape:

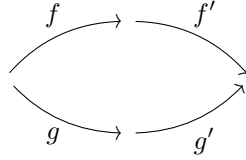

**Definition 1.14.** An  $n$ -polygraph  $\Sigma$  is  $k$ -confluent if every 2-fold branching of  $\Sigma_k$  is confluent.

**Definition 1.15.** An  $n$ -polygraph is  $k$ -convergent if its underlying  $k$ -polygraph is  $k$ -terminating and  $k$ -confluent.

The following two propositions are proven in [6].

**Proposition 1.16.** Let  $\Sigma$  be an  $n$ -terminating  $n$ -polygraph. It is  $n$ -confluent if and only if every 2-fold critical branching is confluent.

**Proposition 1.17.** Let  $\Sigma$  be a  $k$ -convergent  $n$ -polygraph. For every  $u \in \Sigma_{k-1}^*$ , there exists a unique  $v \in \Sigma_{k-1}^*$  such that  $u \rightarrow_k^* v$  and  $v$  is minimal for  $\rightarrow_k^*$ .

**Definition 1.18.** Let  $\Sigma$  be an  $n$ -polygraph. A *normal form* for  $\Sigma$  is an  $(n-1)$ -cell minimal for  $\rightarrow_n^*$ .

If  $\Sigma$  is  $n$ -convergent, for every  $u \in \Sigma_{n-1}^*$ , the unique normal form  $v$  such that  $u \rightarrow_n^* v$  is noted  $\hat{u}$  and is called *the normal form of  $u$* .

## 1.4 Coherence

**Definition 1.19.** Two  $k$ -cells are *parallel* if they have the same source and target.

An  $(n+1)$ -category  $\mathcal{C}$  is  $n$ -coherent if, for each pair  $(f, g)$  of parallel  $n$ -cells in  $\mathcal{C}_n$ , there exists an  $(n+1)$ -cell  $A : f \rightarrow g$  in  $\mathcal{C}_{n+1}$ .

**Definition 1.20.** Let  $\Sigma$  be an  $(n+1)$ -polygraph, and  $(f, g)$  be a local branching of  $\Sigma_n$ . A *filling* of  $(f, g)$  is an  $(n+1)$ -cell  $A \in \Sigma_{n+1}^{*(n)}$  of the shape:

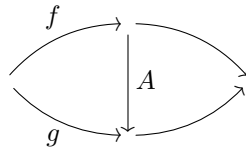

**Definition 1.21.** An  $(n+1)$ -polygraph  $\Sigma$  satisfies the  $n$ -Squier condition if:

- it is  $n$ -convergent,
- there is a bijective application from  $\Sigma_{n+1}$  to the set of all critical pairs of  $\Sigma_n$  that associates to every  $A \in \Sigma_{n+1}$ , a critical pair  $b$  of  $\Sigma_n$  such that  $A$  is a filling of one representative of  $b$ .

The following Theorem is due to Squier for  $n = 2$  [15] and was extended to any integer  $n \geq 2$  by Guiraud and Malbos [6].

**Theorem 1.22.** *Let  $\Sigma$  be an  $(n + 1)$ -polygraph satisfying the  $n$ -Squier condition. Then the free  $(n + 1, n - 1)$ -category  $\Sigma^{*(n-1)}$  is  $n$ -coherent.*

In the proof of this Theorem appears the following result (Lemma 4.3.3 in [6]), that we are going to extend when  $n = 2$ .

**Proposition 1.23.** *Let  $\Sigma$  be an  $(n + 1)$ -polygraph satisfying the  $n$ -Squier condition.*

*For every parallel  $n$ -cells  $f, g \in \Sigma_n^*$  whose target is a normal form, there exists an  $(n+1)$ -cell  $A : f \rightarrow g$  in  $\Sigma_{n+1}^{*(n)}$ .*

Let us compare those two last results. Let  $\Sigma$  be an  $(n + 1)$ -polygraph satisfying the  $n$ -Squier relation, and let  $f, g \in \Sigma_n^*$  be two parallel  $n$ -cells whose target is a normal form. According to Theorem 1.22, there exists an  $(n + 1)$ -cell  $A : f \rightarrow g$  in the free  $(n + 1, n - 1)$ -category  $\Sigma_{n+1}^{*(n-1)}$ . Proposition 1.23 shows that such an  $A$  can be chosen in the free  $(n + 1, n)$ -category  $\Sigma_{n+1}^{*(n)}$ , where the  $n$ -cells are not invertible. Hence for cells  $f, g \in \Sigma_n^*$  whose target is a normal form, Proposition 1.23 is more precise than Theorem 1.22.

**Definition 1.24.** Let  $\Sigma$  be an  $(n + 1)$ -polygraph, and  $(f, g)$  a local branching in  $\Sigma_n$ . Depending on the nature of  $(f, g)$ , we define the notion of *canonical filling* of  $(f, g)$ .

- If  $(f, g)$  is an aspherical branching, then its canonical filling is the identity  $1_f$ .
- If  $(f, g)$  is a Peiffer branching, if  $(f, g) = (f' \star_i v_1, v_2 \star_i g')$  (resp.  $(f, g) = (v_1 \star_i f', g' \star_i v_2)$ ), then its canonical filling is  $1_{f' \star_i g'}$  (resp.  $1_{g' \star_i f'}$ ).
- Assume  $\Sigma$  satisfies the  $n$ -Squier condition, and let  $(f, g)$  be a critical pair. Let  $A$  be the  $(n + 1)$ -cell associated to  $[f, g]$ . If  $A$  is a filling of  $(f, g)$  then the canonical filling of  $(f, g)$  is  $A$ . Otherwise,  $A$  is a filling of  $(g, f)$  and the canonical filling of  $(f, g)$  is  $A^{-1}$ .
- Assume the branching  $(f, g)$  admits a canonical filler  $A$ . Then the canonical filler of  $(u \star_i f \star_i v, u \star_i f \star_i v)$  is  $u \star_i A \star_i v$ .

**Definition 1.25.** Let  $\Sigma$  be an  $(n + 2, n)$ -polygraph satisfying the  $n$ -Squier condition, and  $(f, g, h)$  be a local branching of  $\Sigma_n$ . A *filling* of  $(f, g, h)$  is an  $(n + 2)$ -cell  $\alpha \in \Sigma_{n+2}^{*(n)}$  of the shape:

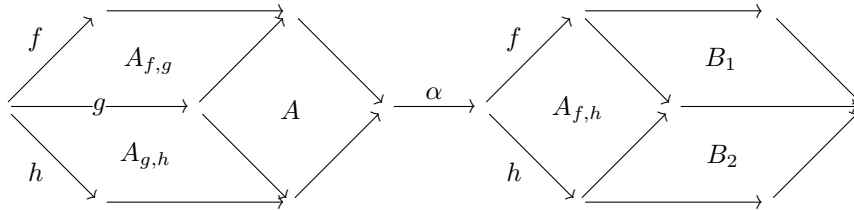

where  $A, A_{f,g}, A_{g,h}, A_{f,h}, B_1$  and  $B_2$  are  $(n + 1)$ -cells in  $\Sigma_{n+1}^{*(n)}$ , and  $A_{f,g}, A_{g,h}$  and  $A_{f,h}$  are the canonical fillings of respectively  $(f, g)$ ,  $(g, h)$  and  $(f, h)$ .

**Definition 1.26.** An  $(n + 2, n)$ -polygraph  $\Sigma$  satisfies the  *$n$ -Squier condition of rank 2* if:

- it satisfies the  $n$ -Squier condition,
- there is a bijective application from  $\Sigma_{n+2}$  to the set of all critical triples that associates to every  $\alpha \in \Sigma_{n+2}$  a critical triple  $b$  of  $\Sigma_n$  such that  $\alpha$  is a filling of a representative of  $b$ .



We now enunciate the theorem whose proof will occupy Sections 4 to 6.

**Theorem 1.27.** *Let  $\Sigma$  be a  $(4, 2)$ -polygraph satisfying the 2-Squier condition of rank 2.*

*For every parallel 3-cells  $A, B \in \Sigma_3^{*(2)}$  whose 1-target is a normal form, there exists a 4-cell  $\alpha : A \rightarrow B$  in the free  $(4, 2)$ -category  $\Sigma_4^{*(2)}$ .*

This Theorem is to be compared with Proposition 4.4.4 in [8]. There, for every parallel  $A, B \in \Sigma_3^{*(1)}$ , a 4-cell  $\alpha$  is constructed in the free  $(4, 1)$ -category  $\Sigma_4^{*(1)}$ . Hence Theorem 1.27 gives a more precise statement, at the cost of restricting the set of 3-cells allowed.

## 2 Application to the coherence of pseudonatural transformations

We now study the coherence problem successively for bicategories, pseudofunctors and pseudonatural transformations. In Section 2.1, we start by recalling the usual definition of bicategories (see [2]). We then give an alternative description of bicategories in terms of algebras over a certain  $(4, 3)$ -polygraph  $\mathbf{BiCat}[\mathbf{C}]$ , and show that the two definitions coincide. The coherence problem for bicategories is now reduced to showing the 3-coherence of  $\mathbf{BiCat}[\mathbf{C}]$ , and we use the techniques introduced in the previous section (especially Theorems 1.8 and 1.22) to conclude. In Section 2.2 and 2.3, we apply the same reasoning to pseudofunctors and pseudonatural transformations. However in the case of pseudonatural transformations, we get a  $(4, 3)$ -polygraph  $\mathbf{PNTrans}[\mathbf{f}, \mathbf{g}]$  which is not 3-confluent, and so we cannot directly apply Theorem 1.22. The proof of the coherence theorem for pseudonatural transformations will take place in Section 3 and will make use of Theorem 1.27.

### 2.1 Coherence for bicategories

Let  $\mathbf{Cat}$  be the category of (small) categories. We note  $\top$  the terminal category in  $\mathbf{Cat}$ . Let  $\mathbf{sCat}$  be the 3-category with one 0-cell, (small) categories as 1-cells, functors as 2-cells, and natural transformations as 3-cells, where 0-composition is given by the Cartesian product.

**Definition 2.1.** A bicategory  $\mathcal{B}$  is given by:

- A set  $\mathcal{B}_0$ .
- For every  $a, b \in \mathcal{B}_0$ , a category  $\mathcal{B}(a, b)$ .
- For every  $a, b, c \in \mathcal{B}_0$ , a functor  $\star_{a,b,c} : \mathcal{B}(a, b) \times \mathcal{B}(b, c) \rightarrow \mathcal{B}(a, c)$ .
- For every  $a \in \mathcal{B}_0$ , a functor  $I_a : \top \rightarrow \mathcal{B}(a, a)$ , that is to say a 1-cell  $I_a : a \rightarrow a$ .
- For every  $a, b, c, d \in \mathcal{B}_0$ , a natural isomorphism  $\alpha_{a,b,c,d}$ :

$$\begin{array}{ccc}
 \mathcal{B}(a, b) \times \mathcal{B}(b, c) \times \mathcal{B}(c, d) & \xrightarrow{\mathcal{B}(a, b) \times \star_{b,c,d}} & \mathcal{B}(a, b) \times \mathcal{B}(b, d) \\
 \star_{a,b,c} \times \mathcal{B}(c, d) \downarrow & \nearrow \alpha_{a,b,c,d} & \downarrow \star_{a,b,d} \\
 \mathcal{B}(a, c) \times \mathcal{B}(c, d) & \xrightarrow{\star_{a,c,d}} & \mathcal{B}(a, d)
 \end{array}$$

of components  $\alpha_{f,g,h} : (f \star g) \star h \Rightarrow f \star (g \star h)$ , for every triple  $(f, g, h) \in \mathcal{B}(a, b) \times \mathcal{B}(b, c) \times \mathcal{B}(c, d)$ .

- For every  $a, b \in \mathcal{B}_0$ , natural isomorphisms  $R_{a,b}$  and  $L_{a,b}$ :

$$\begin{array}{ccc}
 \mathcal{B}(a, b) & \xrightarrow{\mathcal{B}(a, b) \times I_b} & \mathcal{B}(a, b) \times \mathcal{B}(b, b) \\
 I_a \times \mathcal{B}(a, b) \downarrow & \nearrow L_{a,b} & \downarrow \star_{a,b,b} \\
 \mathcal{B}(a, a) \times \mathcal{B}(a, b) & \xrightarrow{\star_{a,a,b}} & \mathcal{B}(a, b)
 \end{array}$$

$\searrow R_{a,b}$

of components  $L_f : I_a \star f \Rightarrow f$  and  $R_f : f \star I_b \Rightarrow f$  for every 1-cell  $f \in \mathcal{B}(a, b)$ .

This data must also satisfy the following axioms:

- For every composable 2-cells  $f, g, h, i$  in  $\mathcal{B}$ :

$$\begin{array}{ccc}
& ((f \star g) \star h) \star i & \\
\alpha_{f \star g, h, i} \swarrow & & \searrow \alpha_{f, g, h \star i} \\
(f \star g) \star (h \star i) & = & (f \star (g \star h)) \star i \\
& & \downarrow \alpha_{f, g \star h, i} \\
& & f \star ((g \star h) \star i) \\
& & \swarrow f \star \alpha_{g, h, i} \\
& f \star (g \star (h \star i)) & \\
\alpha_{f, g, h \star i} \searrow & & \swarrow
\end{array} \tag{1}$$

- For every couple  $(f, g) \in \mathcal{B}(a, b) \times \mathcal{B}(b, c)$ :

$$\begin{array}{ccc}
& (f \star I_b) \star g & \\
\alpha_{f, I_b, g} \swarrow & & \searrow R_f \star g \\
f \star (I_b \star g) & = & f \star g \\
& \xrightarrow{f \star L_g} & \\
& f \star g & \\
& & \swarrow
\end{array} \tag{2}$$

**Definition 2.2.** Let  $\mathbf{C}$  be a set. Let us describe dimension by dimension a 4-polygraph  $\mathbf{BiCat}[\mathbf{C}]$ , so that bicategories correspond to algebras on  $\mathbf{BiCat}[\mathbf{C}]$ , that is to 4-functors from  $\mathbf{BiCat}[\mathbf{C}]$  to  $\mathbf{sCat}$  (see Proposition 2.4).

**Dimension 0:** Let  $\mathbf{BiCat}[\mathbf{C}]_0$  be the set  $\mathbf{C}$ .

**Dimension 1:** The set  $\mathbf{BiCat}[\mathbf{C}]_1$  contains, for every  $a, b \in \mathbf{C}$ , a 1-cell  $a|_b : a \rightarrow b$ .

**Dimension 2:** The set  $\mathbf{BiCat}[\mathbf{C}]_2$  contains the following 2-cells:

- For every  $a, b, c \in \mathbf{C}$ , a 2-cell  $\nabla_{a,b,c} : a|_b|_c \Rightarrow a|_c$ .
- For every  $a \in \mathbf{C}$ , a 2-cell  $\varphi_a : 1_a \Rightarrow a|_a$ .

One can recover a 2-cell in  $\mathbf{BiCat}[\mathbf{C}]_2^*$  from its shape and its 1-source. In what follows, we will therefore omit the indices when the context is clear.

For example, the 2-cell  $\nabla$  of source  $a|_b|_c|_d$  designates the composite  $(a|_b \nabla_{b,c,d}) \star_1 \nabla_{a,b,d}$ .

We will use the same notation for higher-dimensional cells.

**Dimension 3:** The set  $\mathbf{BiCat}[\mathbf{C}]_3$  contains the following 3-cells:

- For every  $a, b, c, d \in \mathbf{C}$ , a 3-cell  $\nabla_{a,b,c,d} : \nabla_{a,b,c} \Rightarrow \nabla_{a,b,d}$  of 1-source  $a|_b|_c|_d$ .
- For every  $a, b \in \mathbf{C}$ , 3-cells  $\mathfrak{d}_{a,b} : \varphi_a \Rightarrow |$  and  $\mathfrak{p}_{a,b} : | \Rightarrow \varphi_a$  of 1-source  $a|_b$ .

**Dimension 4:** The set  $\mathbf{BiCat}[\mathbf{C}]_4$  contains the following 4-cells:

- For every  $a, b, c, d, e \in \mathbf{C}$ , a 4-cell  $\nabla_{a,b,c,d,e}$  of 1-source  $a|b|c|d|e$ .

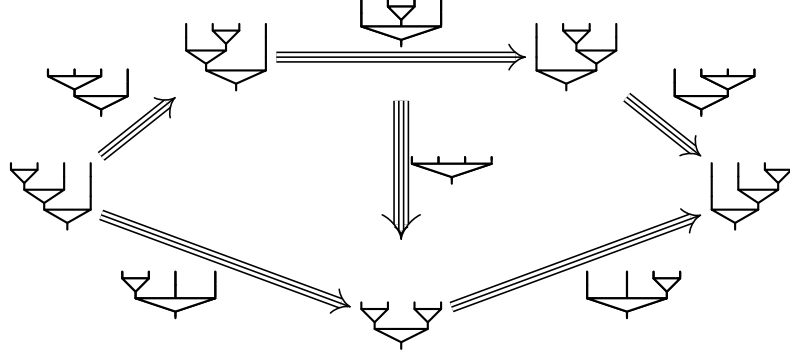

- For every  $a, b, c \in \mathbf{C}$ , a 4-cell  $\nabla_{a,b,c}$  of 1-source  $a|b|c$ .

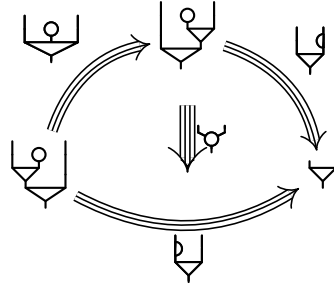

**Definition 2.3.** We note  $\text{Alg}(\mathbf{BiCat})$  the set of all couples  $(\mathbf{C}, \Phi)$ :

- where  $\mathbf{C}$  is a set,
- where  $\Phi$  is a functor from  $\overline{\mathbf{BiCat}[\mathbf{C}]}$  to  $\mathbf{sCat}$ .

**Proposition 2.4.** *There is a one-to-one correspondence between (small) bicategories and  $\text{Alg}(\mathbf{BiCat})$ .*

*Proof.* The correspondence between a bicategory  $\mathcal{B}$  and an algebra  $(\mathbf{C}, \Phi)$  over  $\mathbf{BiCat}$  is given by:

- At the level of sets:  $\mathbf{C} = \mathcal{B}_0$ .
- For every  $a, b \in \mathcal{B}_0$ ,  $\Phi(a|b) = \mathcal{B}(a, b)$ .
- For every  $a, b, c \in \mathcal{B}_0$ ,  $\Phi(\nabla_{a,b,c}) = \star_{a,b,c}$ .
- For every  $a \in \mathcal{B}_0$ ,  $\Phi(\nabla_a) = I_a$ .
- For every  $a, b, c, d \in \mathcal{B}_0$ ,  $\Phi(\nabla_{a,b,c,d}) = \alpha_{a,b,c,d}$ .
- For every  $a, b \in \mathcal{B}_0$ ,  $\Phi(\mathfrak{p}_{a,b}) = R_{a,b}$  and  $\Phi(\mathfrak{d}_{a,b}) = L_{a,b}$ .
- The axioms that a bicategory must satisfy correspond to the fact that  $\Phi$  is compatible with the quotient by the 4-cells  $\nabla_{a,b,c,d,e}$  and  $\nabla_{a,b,c}$ .

This correspondence between the structures of bicategory and of algebra over  $\mathbf{BiCat}$  is summed up by the following table:

Bicategory		$Alg(\mathbf{BiCat})$	
Sets	$\mathcal{B}_0$	$\mathbf{C}$	0-cells
Categories	$\mathcal{B}(\_, \_)$	$\downarrow$	1-cells
Functors	$\star, I$	$\nabla, \circ$	2-cells
Natural transformations	$\alpha, L, R$	$\nabla, \circ, \eta, \beta$	3-cells
Equalities	(1) (2)	$\nabla, \circ, \eta, \beta$	4-cells

Table 1: Correspondence for bicategories

□

We are going to show the coherence theorem for bicategories, using Theorem 1.22.

**Proposition 2.5.** *For every set  $\mathbf{C}$ , the 4-polygraph  $\mathbf{BiCat}[\mathbf{C}]$  3-terminates.*

*Proof.* In order to apply Theorem 1.8 we construct two functors  $X_{\mathbf{C}} : \mathbf{BiCat}[\mathbf{C}]_2^* \rightarrow \mathbf{sOrd}$  and  $Y_{\mathbf{C}} : (\mathbf{BiCat}[\mathbf{C}]_2^*)^{\text{co}} \rightarrow \mathbf{sOrd}$  by setting, for every  $a, b \in \mathbf{C}$ :

$$X_{\mathbf{C}}(ab) = Y_{\mathbf{C}}(ab) = \mathbb{N}^*$$

and, for every  $i, j \in \mathbb{N}^*$ :

$$X_{\mathbf{C}}(\nabla)[i, j] = i + j, \quad X_{\mathbf{C}}(\circ) = 1, \quad Y_{\mathbf{C}}(\nabla)[i] = (i, i).$$

We now define an  $(X_{\mathbf{C}}, Y_{\mathbf{C}}, \mathbb{N})$ -derivation  $d_{\mathbf{C}}$  on  $\mathbf{BiCat}[\mathbf{C}]_2^*$  by setting, for every  $i, j, k \in \mathbb{N}^*$ :

$$d_{\mathbf{C}}(\nabla)[i, j, k] = i + j + k + 1, \quad d_{\mathbf{C}}(\circ)[i] = i,$$

It remains to show that the required inequalities are satisfied. Concerning  $X_{\mathbf{C}}$  and  $Y_{\mathbf{C}}$ , we have for every  $i, j, k \in \mathbb{N}^*$ :

$$X_{\mathbf{C}}(\nabla \circ \nabla)[i, j, k] = i + j + k \geq i + j + k = X_{\mathbf{C}}(\nabla \circ \nabla)[i, j, k]$$

$$X_{\mathbf{C}}(\circ \nabla)[i] = i + 1 \geq i = X_{\mathbf{C}}(\circ \nabla)[i] \quad X_{\mathbf{C}}(\nabla \circ)[i] = i + 1 \geq i = X_{\mathbf{C}}(\nabla \circ)[i]$$

$$Y_{\mathbf{C}}(\nabla \circ \nabla)[i] = (i, i, i) \geq (i, i, i) = Y_{\mathbf{C}}(\nabla \circ \nabla)[i]$$

$$Y_{\mathbf{C}}(\circ \nabla)[i] = i \geq i = Y_{\mathbf{C}}(\circ \nabla)[i] \quad Y_{\mathbf{C}}(\nabla \circ)[i] = i \geq i = Y_{\mathbf{C}}(\nabla \circ)[i].$$

Concerning  $d_{\mathbf{C}}$ , we have for every  $i, j, k, l \in \mathbb{N}^*$ :

$$d_{\mathbf{C}}(\nabla \circ \nabla)[i, j, k, l] = 2i + j + 2l + 2 > i + j + 2l + 2 = d_{\mathbf{C}}(\nabla \circ \nabla)[i, j, k, l]$$

$$d_{\mathbf{C}}(\circ \nabla)[i, j] = 2j + 2 > 0 = d_{\mathbf{C}}(\circ \nabla)[i, j] \quad d_{\mathbf{C}}(\nabla \circ)[i, j] = i + 2j + 1 > 0 = d_{\mathbf{C}}(\nabla \circ)[i, j].$$

□

The following Theorem is a rephrasing of MacLane's coherence Theorem ([12]) in our setting.

**Theorem 2.6.** *Let  $\mathbf{C}$  be a set.*

*The 4-polygraph  $\mathbf{BiCat}[\mathbf{C}]$  is 3-convergent and the free  $(4, 2)$ -category  $\mathbf{BiCat}[\mathbf{C}]^{*(2)}$  is 3-coherent.*

*Proof.* We already know that  $\mathbf{BiCat}[\mathbf{C}]$  is 3-terminating. Using Proposition 1.16 and Theorem 1.22, it remains to show that every critical pair admits a filling.

There are five families of critical pairs, of sources:

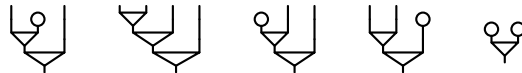

The first two families are filled by the 4-cells  $\nabla$  and  $\circ$ , whereas the last three are filled by 4-cells  $\omega_i \in \mathbf{BiCat}[\mathbf{C}]_4^{*(2)}$ , which are constructed in a similar fashion as in the case of monoidal categories (see [7]).

□

## 2.2 Coherence for pseudofunctors

**Definition 2.7.** A pseudofunctor  $F$  is given by:

- Two bicategories  $\mathcal{B}$  et  $\mathcal{B}'$ .
- A function  $F_0 : \mathcal{B}_0 \rightarrow \mathcal{B}'_0$ .
- For every  $a, b \in \mathcal{B}_0$ , a functor  $F_{a,b} : \mathcal{B}(a, b) \rightarrow \mathcal{B}'(F_0(a), F_0(b))$ .
- For every  $a, b, c \in \mathcal{B}_0$ , a natural isomorphism  $\phi_{a,b,c}$ :

$$\begin{array}{ccc}
 \mathcal{B}(a, b) \times \mathcal{B}(b, c) & \xrightarrow{\star_{a,b,c}} & \mathcal{B}(a, c) \\
 \downarrow F_{a,b} \times F_{b,c} & \swarrow \phi_{a,b,c} & \downarrow F_{a,c} \\
 \mathcal{B}'(F_0(a), F_0(b)) \times \mathcal{B}'(F_0(b), F_0(c)) & \xrightarrow{\star'_{F_0(a), F_0(b), F_0(c)}} & \mathcal{B}'(F_0(a), F_0(c))
 \end{array}$$

of components  $\phi_{f,g} : F(f \star g) \Rightarrow F(f) \star' F(g)$ , for every couple  $(f, g) \in \mathcal{B}(a, b) \times \mathcal{B}(b, c)$ .

- For every  $a \in \mathcal{B}_0$ , a natural isomorphism  $\psi_a$ :

$$\begin{array}{ccc}
 \top & \xrightarrow{I_a} & \mathcal{B}(a, a) \\
 \parallel & \swarrow \psi_a & \downarrow F_{a,a} \\
 \top & \xrightarrow{I'_{F_0(a), F_0(a)}} & \mathcal{B}'(F_0(a), F_0(a))
 \end{array}$$

of components  $\psi_a : F(I_a) \Rightarrow I'_{F_0(a)}$ , for every  $a \in \mathcal{B}_0$

This data must satisfy the following axioms:

- For every composable 1-cells  $f, g$  and  $h$  in  $\mathcal{B}$ :

$$\begin{array}{ccc}
 & F((f \star g) \star h) & \\
 F(\alpha_{f,g,h}) \swarrow & & \searrow \phi_{f \star g, h} \\
 F(f \star (g \star h)) & & F(f \star g) \star' F(h) \\
 \phi_{f, g \star h} \Downarrow & = & \Downarrow \phi_{f, g} \star' F(h) \\
 F(f) \star' F(g \star h) & & (F(f) \star' F(g)) \star' F(h) \\
 & \swarrow F(f) \star' \phi_{g, f} & \nwarrow \alpha'_{F(f), F(g), F(h)} \\
 & F(f) \star' (F(g) \star' F(h)) &
 \end{array} \tag{3}$$

- For every 1-cell  $f : a \rightarrow b$  in  $\mathcal{B}$ :

$$\begin{array}{ccc}
 & F(I_a) \star' F(f) & \xrightarrow{\psi_a \star' F(f)} I'_{F_0(a)} \star' F(f) \\
 \phi_{I_a, f} \nearrow & & \searrow L'_{F(f)} \\
 F(I_a \star f) & \xrightarrow{F(L_f)} & F(f)
 \end{array} \tag{4}$$

- For every 1-cell  $f : a \rightarrow b$  in  $\mathcal{B}$ :

$$\begin{array}{ccc}
 & F(f) \star' F(I_b) \xrightarrow{F(f) \star' \psi_b} F(f) \star' I'_{F_0(b)} & \\
 \phi_{f, I_b} \nearrow & & \searrow R'_{F(f)} \\
 F(f \star I_b) & \xrightarrow{F(R_f)} & F(f)
 \end{array}
 \quad (5)$$

**Definition 2.8.** Let  $\mathbf{C}$  and  $\mathbf{D}$  be sets, and  $\mathbf{f}$  an application from  $\mathbf{C}$  to  $\mathbf{D}$ . Let us describe dimension by dimension a  $(4, 2)$ -polygraph  $\mathbf{PFonct}[\mathbf{f}]$ . We will prove in Proposition 2.11 that pseudofunctors correspond to algebras over  $\mathbf{PFonct}[\mathbf{f}]$ .

The polygraph  $\mathbf{PFonct}[\mathbf{f}]$  contains the union of:

- the polygraph  $\mathbf{BiCat}[\mathbf{C}]$ , whose cells are noted  $\nabla, \circlearrowleft, \nabla, \flat, \natural, \nabla$  and  $\nabla$ ,
- the polygraph  $\mathbf{BiCat}[\mathbf{D}]$ , whose cells are noted  $\nabla, \bullet, \nabla, \flat, \natural, \nabla$  and  $\bullet$ ,

together with the following cells:

**Dimension 1:** For every  $a \in \mathbf{C}$ , the set  $\mathbf{PFonct}[\mathbf{f}]_1$  contains a 1-cell  $a|_{\mathbf{f}(a)} : a \rightarrow \mathbf{f}(a)$ .

**Dimension 2:** For every  $a, b \in \mathbf{C}$ , the set  $\mathbf{PFonct}[\mathbf{f}]_2$  contains a 2-cell  $\nabla_{a,b} : a|_{\mathbf{f}(b)} \Rightarrow a|_{\mathbf{f}(a)}|_{\mathbf{f}(b)}$ .

**Dimension 3:** The set  $\mathbf{PFonct}[\mathbf{f}]_3$  contains the following 3-cells:

- For every  $a, b, c \in \mathbf{C}$ , a 3-cell  $\nabla_{a,b,c} : \nabla_{a,b} \Rightarrow \nabla_{a,b} \circ \nabla_{b,c}$  of 1-source  $a|_{b|c|_{\mathbf{f}(c)}}$ .
- For every  $a \in \mathbf{C}$ , a 3-cell  $\nabla_a : \nabla_a \Rightarrow \nabla_a$  of 1-source  $a|_{\mathbf{f}(a)}$ .

**Dimension 4:** The  $\mathbf{PFonct}[\mathbf{f}]_4$  contains the following 4-cells:

- For every  $a, b, c, d \in \mathbf{C}$ , a 4-cell  $\nabla_{a,b,c,d}$  of 1-source  $a|_{b|c|d|_{\mathbf{f}(d)}}$

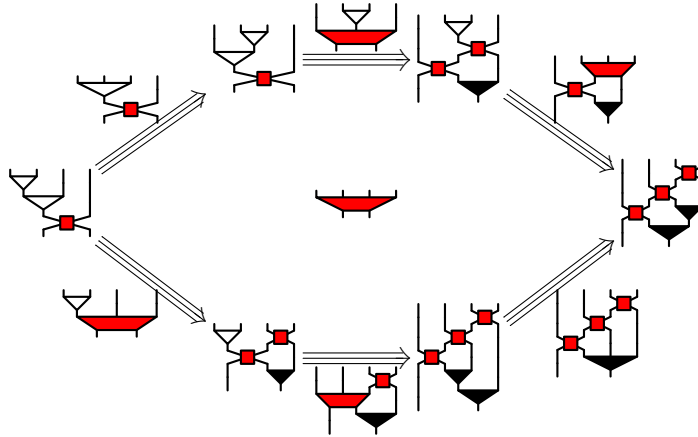

- For every  $a, b \in \mathbf{C}$ , 4-cells  $\nabla_{a,b}$  and  $\nabla_{a,b}$  of 1-source  $a|_{b|_{\mathbf{f}(b)}}$

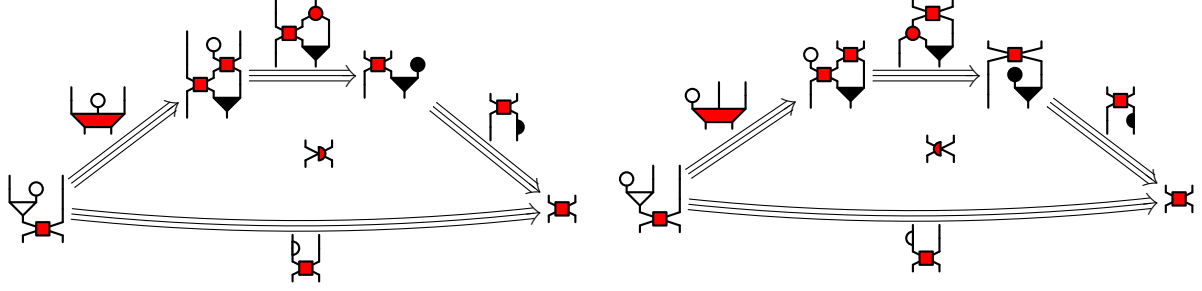

**Definition 2.9.** Let  $\text{Alg}(\mathbf{PFonct})$  be the set of all triples  $(\mathbf{C}, \mathbf{D}, \mathbf{f})$ :

- where  $\mathbf{C}$  and  $\mathbf{D}$  are sets,
- where  $\mathbf{f}$  is an application from  $\mathbf{C}$  to  $\mathbf{D}$ ,
- where  $\Phi$  is a functor from  $\overline{\mathbf{PFonct}[\mathbf{f}]}$  to  $\mathbf{sCat}$  such that, for every  $c \in \mathbf{C}$  the following equality holds:

$$\Phi(c|_{\mathbf{f}(c)}) = \top$$

This last condition stems from the fact that the 1-cells  $c|_{\mathbf{f}(c)}$  are just an artefact to keep track of the function  $\mathbf{f}$ , but that have no real computational meaning.

**Remark 2.10.** Let  $\mathbf{f} : \mathbf{C} \rightarrow \mathbf{D}$  be an application. Since  $\mathbf{BiCat}[\mathbf{C}]$  (resp.  $\mathbf{BiCat}[\mathbf{D}]$ ) is a sub-polygraph of  $\mathbf{PFonct}[\mathbf{f}]$ , every functor  $\Phi : \overline{\mathbf{PFonct}[\mathbf{f}]} \rightarrow \mathbf{sCat}$  induces by restriction two functors:

$$\Phi_{\circ} : \overline{\mathbf{BiCat}[\mathbf{C}]} \rightarrow \mathbf{sCat} \quad \Phi_{\bullet} : \overline{\mathbf{BiCat}[\mathbf{D}]} \rightarrow \mathbf{sCat}$$

**Proposition 2.11.** Pseudofunctors between (small) categories are in one to one correspondence with elements of  $\text{Alg}(\mathbf{PFonct})$ .

*Proof.* The proof is similar to the case of bicategories, using the following correspondence table:



Pseudofunctors		$\text{Alg}(\mathbf{PFonct})$	
Source and target	$\mathcal{B}$ and $\mathcal{B}'$	$\Phi_{\circ}$ and $\Phi_{\bullet}$	Restrictions
Function	$F_0$	$\mathbf{f}$	Function
Functors	$F$		2-cells
Natural transformations	$\psi, \phi$		3-cells
Equalities	(3) (4) (5)		4-cells

Table 2: Correspondence for pseudofunctors

□

**Proposition 2.12.** For every sets  $\mathbf{C}, \mathbf{D}$  and every application  $\mathbf{f} : \mathbf{C} \rightarrow \mathbf{D}$ , the polygraph  $\mathbf{PFonct}[\mathbf{f}]$  terminates.

*Proof.* In order to apply Theorem 1.8, we define functors  $X_{\mathbf{f}} : \mathbf{PFonct}[\mathbf{f}]_2^* \rightarrow \mathbf{sOrd}$  and  $Y_{\mathbf{f}} : (\mathbf{PFonct}[\mathbf{f}]_2^*)^{\text{co}} \rightarrow \mathbf{sOrd}$  as extensions of the functors  $X_{\mathbf{C}}, X_{\mathbf{D}}, Y_{\mathbf{C}}$  and  $Y_{\mathbf{D}}$  from Proposition 2.5, and by setting for every  $a \in \mathbf{C}$ :

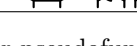
$$X_{\mathbf{f}}(a|_{\mathbf{f}(a)}) = Y_{\mathbf{f}}(a|_{\mathbf{f}(a)}) = \top,$$



where  $\top$  is the terminal ordered set, and for every  $i \in \mathbb{N}^*$ :

$$X_{\mathbf{f}}(\text{stick figure})[i] = i \quad Y_{\mathbf{f}}(\text{stick figure})[i] = 2i + 1.$$

We now define an  $(X_{\mathbf{f}}, Y_{\mathbf{f}}, \mathbb{N})$ -derivation  $d_{\mathbf{f}}$  on  $\mathbf{PFonct}[\mathbf{f}]_2^*$  as an extension of  $d_{\mathbf{C}}$ , by setting for every  $i, j, k \in \mathbb{N}^*$ :

$$d_{\mathbf{f}}(\text{red triangle})[i, j, k] = i + k \quad d_{\mathbf{f}}(\text{red circle})[i] = i \quad d_{\mathbf{f}}(\text{red square})[i, j] = i + j + 1$$



It remains to show that the inequalities required to apply Theorem 1.8 are satisfied. Since  $X_{\mathbf{f}}$  (resp.  $Y_{\mathbf{f}}$ ) extends  $X_{\mathbf{C}}$  and  $X_{\mathbf{D}}$  (resp.  $Y_{\mathbf{C}}$  and  $Y_{\mathbf{D}}$ ), the only inequalities that need to be checked are those corresponding to the 3-cells  and . Indeed for every  $i, j \in \mathbb{N}^*$ , we have:

$$\begin{aligned} X_{\mathbf{f}}(\text{red circle}) &= 1 \geq 1 = X_{\mathbf{f}}(\text{red circle}) \\ X_{\mathbf{f}}(\text{red triangle pointing down})[i, j] &= i + j \geq i + j = X_{\mathbf{f}}(\text{red triangle pointing down})[i, j] \\ Y_{\mathbf{f}}(\text{red triangle pointing down})[i] &= (2i + 1, 2i + 1) \geq (2i + 1, 2i + 1) = Y_{\mathbf{f}}(\text{red triangle pointing down})[i] \end{aligned}$$

Concerning  $d_{\mathbf{f}}$ , the 3-cells from  $\mathbf{BiCat}[\mathbf{C}]$  have already been checked in Proposition 2.5. For the other 3-cells, we have, for every  $i, j, k \in \mathbb{N}^*$ :

$$\begin{aligned} d_{\mathbf{f}}(\text{red circle})[i, j] &= 2j + 1 > 0 = d_{\mathbf{f}}(\text{red circle})[i, j] & d_{\mathbf{f}}(\text{red triangle pointing down})[i, j] &= i + 2j > 0 = d_{\mathbf{f}}(\text{red triangle pointing down})[i, j] \\ d_{\mathbf{f}}(\text{red circle})[i] &= 3i + 2 > i = d_{\mathbf{f}}(\text{red circle})[i] \\ d_{\mathbf{f}}(\text{red triangle pointing down})[i, j, k] &= 2i + j + 3k + 3 > 2i + j + 3k + 2 = d_{\mathbf{f}}(\text{red triangle pointing down})[i, j, k]. \end{aligned}$$

□



**Theorem 2.13.** *Let  $\mathbf{C}$  and  $\mathbf{D}$  be sets, and  $\mathbf{f} : \mathbf{C} \rightarrow \mathbf{D}$  an application.*

*The 4-polygraph  $\mathbf{PFonct}[\mathbf{f}]$  is 3-confluent and  $\mathbf{PFonct}[\mathbf{f}]^{*(2)}$  is 3-coherent.*

*Proof.* We have shown that it is 3-terminating, so using Proposition 1.16 and Theorem 1.22, it remains to show that every critical pair admits a filler in  $\mathbf{PFonct}[\mathbf{f}]_4$ .

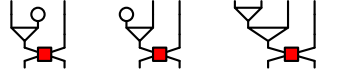
There are thirteen families of critical pairs. Among them, ten come from  $\mathbf{BiCat}[\mathbf{C}]$  or  $\mathbf{BiCat}[\mathbf{D}]$ , and were already dealt with in Theorem 2.6. The remaining three have the following sources:



and they are filled respectively by the 4-cells ,  and .

□

## 2.3 Coherence for pseudonatural transformations

**Definition 2.14.** A pseudonatural transformation  $\tau$  consists of the following data:

- Two pseudofunctors  $F, F' : \mathcal{B} \rightarrow \mathcal{B}'$ , where  $\mathcal{B}$  and  $\mathcal{B}'$  are bicategories.
- For every  $a \in \mathcal{B}_0$ , a functor  $\tau_a : \top \rightarrow \mathcal{B}'(F_0(a), F'_0(a))$ , that is a 1-cell  $\tau_a : F_0(a) \rightarrow F'_0(a)$  in  $\mathcal{B}'$ .
- For every  $a, b \in \mathcal{B}_0$ , a natural isomorphism  $\sigma_{a,b}$ :

$$\begin{array}{ccc} & \mathcal{B}(a, b) & \\ & \swarrow F_{a,b} \quad \searrow F'_{a,b} & \\ \mathcal{B}'(F_0(a), F_0(b)) & & \mathcal{B}'(F'_0(a), F'_0(b)) \\ \downarrow \tau_b & \xrightarrow{\sigma_{a,b}} & \downarrow \tau_a \times \mathcal{B}'(F'_0(a), F'_0(b)) \\ \mathcal{B}'(F_0(a), F_0(b)) \times \mathcal{B}'(F_0(b), F'_0(b)) & & \mathcal{B}'(F_0(a), F'_0(a)) \times \mathcal{B}'(F'_0(a), F'_0(b)) \\ & \searrow \star'_{F_0(a), F_0(b), F'_0(b)} \quad \swarrow \star'_{F_0(a), F'_0(a), F'_0(b)} & \\ & \mathcal{B}'(F_0(a), F'_0(b)) & \end{array}$$

of components  $\sigma_f : F(f) \star' \tau_b \Rightarrow \tau_a \star' F'(f)$ , for every  $f \in \mathcal{B}(a, b)$ .

This data must satisfy the following axioms:

- For every  $(f, g) \in \mathcal{B}(a, b) \times \mathcal{B}(b, c)$ :

$$\begin{array}{ccc}
& & \tau_a \star' F'(f \star g) \\
& \nearrow \sigma_{f \star g} & \\
F(f \star g) \star' \tau_c & & \tau_a \star' \phi'_{f,g} \\
\downarrow \phi_{f,g} \star' \tau_c & & \tau_a \star' (F'(f) \star' F'(g)) \\
(F(f) \star' F(g)) \star' \tau_c & = & (\tau_a \star' F'(f)) \star' F'(g) \\
\downarrow \alpha'_{F(f), F(g), \tau_c} & & \uparrow \alpha'_{\tau_a, F'(f), F'(g)} \\
F(f) \star' (F(g) \star' \tau_c) & & (\tau_a \star' F'(f)) \star' F'(g) \\
& & \uparrow \sigma_f \star' F'(g) \\
& & (F(f) \star' \tau_b) \star' F'(g) \\
& \searrow F(f) \star' \sigma_g & \swarrow \alpha'_{F(f), \tau_b, F(g)} \\
& & F(f) \star' (\tau_b \star' F'(g))
\end{array} \tag{6}$$

where we inverse the direction of an arrow in order to represent the inverse of the corresponding 2-cell.

- For every  $a \in \mathcal{B}_0$ :

$$\begin{array}{ccc}
& & F(I_a) \star' \tau_a \\
& \searrow \psi_a \star' \tau_a & \nearrow \sigma_{I_a} \\
I'_{F_0(a)} \star' \tau_a & = & \tau_a \star' F'(I_a) \\
& \searrow L'_{\tau_a} & \downarrow \tau_a \star' \psi'_a \\
& & \tau_a \star' I'_{F'_0(a)} \\
& & \swarrow R'_{\tau_a} \\
& & \tau_a
\end{array} \tag{7}$$

**Definition 2.15.** Let  $\mathbf{C}$  and  $\mathbf{D}$  be sets, and  $\mathbf{f}, \mathbf{g}$  be applications from  $\mathbf{C}$  to  $\mathbf{D}$ . Let us define dimension by dimension a  $(4, 2)$ -polygraph  $\mathbf{PNTrans}[\mathbf{f}, \mathbf{g}]$ . We will see in Proposition 2.18 that pseudonatural transformations correspond to algebras over  $\mathbf{PNTrans}[\mathbf{f}, \mathbf{g}]$ .

The polygraph  $\mathbf{PNTrans}[\mathbf{f}, \mathbf{g}]$  contains the union of the polygraphs  $\mathbf{PFonct}[\mathbf{f}]$  and  $\mathbf{PFonct}[\mathbf{g}]$ . In particular, the following cells are in  $\mathbf{PNTrans}[\mathbf{f}, \mathbf{g}]$ :

- the cells  $\nabla, \varphi, \triangleleft, \triangleright, \triangleleft', \triangleright'$  and  $\nabla'$  coming from  $\mathbf{BiCat}[\mathbf{C}]$ ,
- the cells  $\blacktriangledown, \bullet, \blacktriangledown', \triangleright, \triangleright', \blacktriangledown'$  and  $\blacktriangledown'$  coming from  $\mathbf{BiCat}[\mathbf{D}]$ ,
- the cells  $\color{red}{\blacktriangleright}, \color{red}{\blacktriangleright'}, \color{red}{\bullet}, \color{red}{\blacktriangleright}, \color{red}{\blacktriangleright}'$  and  $\color{red}{\blacktriangleright}'$  coming from  $\mathbf{PFonct}[\mathbf{f}]$ ,
- the cells  $\color{blue}{\blacktriangleright}, \color{blue}{\blacktriangleright'}, \color{blue}{\bullet}, \color{blue}{\blacktriangleright}, \color{blue}{\blacktriangleright}'$  and  $\color{blue}{\blacktriangleright}'$  coming from  $\mathbf{PFonct}[\mathbf{g}]$ .

Together with the union of  $\mathbf{PFonct}[\mathbf{f}]$  and  $\mathbf{PFonct}[\mathbf{g}]$ ,  $\mathbf{PNTrans}[\mathbf{f}, \mathbf{g}]$  contains the following cells:

**Dimension 2:** For every  $a \in \mathbf{C}$ , the set  $\mathbf{PNTrans}[\mathbf{f}, \mathbf{g}]_2$  contains a 2-cell  $\square_a : a|_{\mathbf{g}(a)} \Rightarrow a|_{\mathbf{f}(a)}|_{\mathbf{g}(a)}$ .

**Dimension 3:** For every  $a, b \in \mathbf{C}$ , the set  $\mathbf{PNTrans}[\mathbf{f}, \mathbf{g}]_3$  contains a 3-cell:  $\mathfrak{R}_{a,b} : \begin{array}{c} \text{[Diagram of 1-cell with red square]} \\ \text{[Diagram of 1-cell with blue square]} \end{array} \Rightarrow \begin{array}{c} \text{[Diagram of 1-cell with blue square]} \\ \text{[Diagram of 1-cell with red square]} \end{array}$  of 1-source  $a|_{\mathbf{g}(b)}$ .

**Dimension 4:** The set  $\mathbf{PNTrans}[\mathbf{f}, \mathbf{g}]_4$  contains the following 4-cells:

- For every  $a \in \mathbf{C}$ , a 4-cell  $\mathfrak{A}_a$  of 1-source  $a|_{\mathbf{g}(a)}$

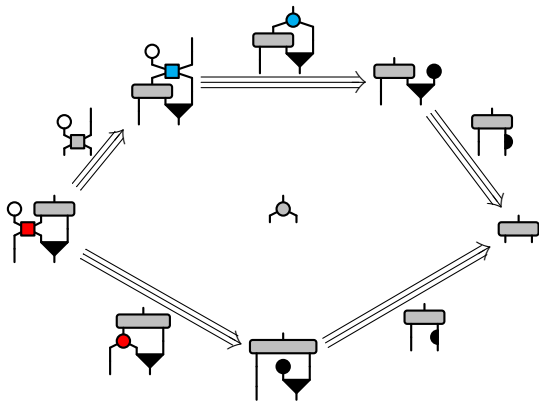

- For every  $a, b, c \in \mathbf{C}$ , a 4-cell  $\mathfrak{B}_{a,b,c}$  of 1-source  $a|_{\mathbf{g}(c)}$

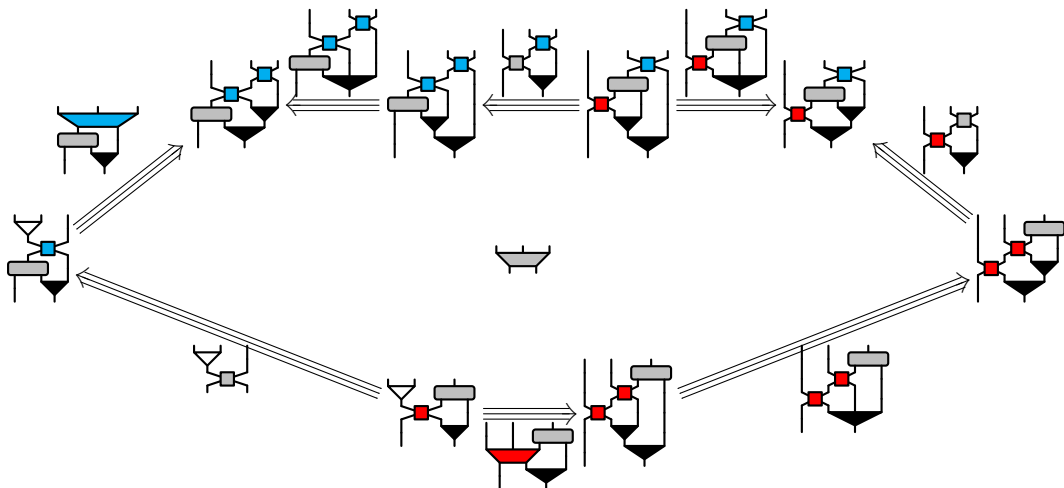

**Definition 2.16.** Let  $\text{Alg}(\mathbf{PNTrans})$  be the set of tuples  $(\mathbf{C}, \mathbf{D}, \mathbf{f}, \mathbf{g}, \Phi)$  :

- where  $\mathbf{C}$  and  $\mathbf{D}$  are sets,
- where  $\mathbf{f}, \mathbf{g} : \mathbf{C} \rightarrow \mathbf{D}$  are applications,
- where  $\Phi$  is a functor from  $\overline{\mathbf{PNTrans}[\mathbf{f}, \mathbf{g}]}$  to  $\mathbf{sCat}$ , such that for every  $c \in \mathbf{C}$ ,  $d \in \mathbf{D}$  and 1-cell  $| : c \rightarrow d$ :

$$\Phi(|_d) = \top$$

**Remark 2.17.** Since  $\mathbf{PFonct}[\mathbf{f}]$  (resp.  $\mathbf{PFonct}[\mathbf{g}]$ ) is a sub-polygraph of  $\mathbf{PNTrans}[\mathbf{f}, \mathbf{g}]$ , every functor  $\Phi : \mathbf{PNTrans}[\mathbf{f}, \mathbf{g}] \rightarrow \mathbf{sCat}$  induces by restriction two functors

$$\Phi_{\bullet} : \overline{\mathbf{PFonct}[\mathbf{f}]} \rightarrow \mathbf{sCat} \quad \Phi_{\circ} : \overline{\mathbf{PFonct}[\mathbf{g}]} \rightarrow \mathbf{sCat}$$

**Proposition 2.18.** Pseudonatural transformations between pseudofunctors are in one to one correspondence with elements of  $\text{Alg}(\mathbf{PNTrans})$ .

*Proof.* The proof is similar to that of bicategories, using the following correspondence table:



Pseudonatural transformations		$Alg(\mathbf{PNTrans})$	
Source and target Functors	$F$ and $F'$	$\Phi_{\bullet}$ and $\Phi_{\circ}$	Restrictions
Natural transformations	$\tau$		2-cells
Equalities	(6) (7)		3-cells
			4-cells

Table 3: Correspondence for pseudonatural transformations

□

This result induces the following classification of the cells of  $\mathbf{PNTrans}$ , depending on which structure they come from. Moreover, in the following table, every line corresponds to a dimension.



























Source bicategory	2-cells		
	3-cells		$b, d$
	4-cells		
Target bicategory	2-cells		
	3-cells		$b, d$
	4-cells		
Source pseudofunctor	2-cells		
	3-cells		
	4-cells		
Target pseudofunctor	2-cells		
	3-cells		
	4-cells		
Pseudonatural transformation	2-cells		
	3-cells		
	4-cells		

Table 4: Classification of the cells of  $\mathbf{PNTrans}$

**Proposition 2.19.** *Let  $\mathbf{f}, \mathbf{g} : \mathbf{C} \rightarrow \mathbf{D}$  be two applications. The  $(4, 3)$ -polygraph  $\mathbf{PNTrans}[\mathbf{f}, \mathbf{g}]$  3-terminates.*

*Proof.* We apply Theorem 1.8. To construct the functors  $X_{\mathbf{f}, \mathbf{g}} : \mathbf{PNTrans}[\mathbf{f}, \mathbf{g}]_2^* \rightarrow \mathbf{sOrd}$  and  $Y_{\mathbf{f}, \mathbf{g}} : (\mathbf{PNTrans}[\mathbf{f}, \mathbf{g}]_2^*)^{\text{co}} \rightarrow \mathbf{sOrd}$ , we extend the functors  $X_{\mathbf{f}}, X_{\mathbf{g}}, Y_{\mathbf{f}}$  and  $Y_{\mathbf{g}}$  from Proposition 2.12, by setting:

$$X_{\mathbf{f}, \mathbf{g}}(\text{restriction}) = 1$$

We now define an  $(X_{\mathbf{f}, \mathbf{g}}, Y_{\mathbf{f}, \mathbf{g}}, \mathbb{N})$ -derivation  $d_{\mathbf{f}, \mathbf{g}}$  of  $\mathbf{PNTrans}[\mathbf{f}, \mathbf{g}]_2^*$  as the extension of  $d_{\mathbf{f}}$  satisfying, for every  $i, j \in \mathbb{N}^*$ :

$$d_{\mathbf{f}, \mathbf{g}}(\text{restriction})[i, j] = i + j \quad d_{\mathbf{f}, \mathbf{g}}(\text{restriction})[i] = i$$

It remains to show that the required inequalities are satisfied. Since  $X_{\mathbf{f}, \mathbf{g}}$  (resp.  $Y_{\mathbf{f}, \mathbf{g}}$ ) is an extension  $X_{\mathbf{f}}$  and  $X_{\mathbf{g}}$  (resp.  $Y_{\mathbf{f}}$  and  $Y_{\mathbf{g}}$ ), it only remains to treat the case of the 3-cell  $\text{restriction}$ . For every  $i, j \in \mathbb{N}^*$ , we have:

$$X_{\mathbf{f}, \mathbf{g}}(\text{restriction})[i] = i + 1 \geq i + 1 = X_{\mathbf{f}, \mathbf{g}}(\text{restriction})[i] \quad Y_{\mathbf{f}, \mathbf{g}}(\text{restriction})[i] = 2i + 1 \geq 2i + 1 = Y_{\mathbf{f}, \mathbf{g}}(\text{restriction})[i]$$

Concerning  $d_{\mathbf{f}, \mathbf{g}}$ , the 3-cells from  $\mathbf{PFonct}[\mathbf{f}]$  were already treated in Proposition 2.5. For the others we have, for every  $i, j, k \in \mathbb{N}^*$ :

$$d_{\mathbf{f},\mathbf{g}}(\text{Diagram 1})[i, j, k] = 2i + j + 3k + 2 > 2i + j + 3k = d_{\mathbf{f},\mathbf{g}}(\text{Diagram 2})[i, j, k]$$

$$d_{\mathbf{f},\mathbf{g}}(\text{Diagram 3}) = 3i + 1 > i = d_{\mathbf{f},\mathbf{g}}(\text{Diagram 4}) \quad d_{\mathbf{f},\mathbf{g}}(\text{Diagram 5})[i, j] = 2i + 3j + 1 > i + 3j + 1 = d_{\mathbf{f},\mathbf{g}}(\text{Diagram 6})[i, j]$$

□

**Definition 2.20.** We define a *weight* application  $\mathbf{w}$  as the 1-functor from  $\mathbf{PNTrans}[\mathbf{f}, \mathbf{g}]_1^*$  to  $\mathbb{N}$ , defined as follows on  $\mathbf{PNTrans}[\mathbf{f}, \mathbf{g}]_1$ :

- for all  $a, b \in \mathbf{C}$ ,  $\mathbf{w}(ab) = 1$ ,
- for all  $a, b \in \mathbf{D}$ ,  $\mathbf{w}(ab) = 1$ ,
- for all  $a \in \mathbf{C}$  and  $b \in \mathbf{D}$ ,  $\mathbf{w}(ab) = 0$ .

**Theorem 2.21** (Coherence for pseudonatural transformations). *Let  $\mathbf{C}$  and  $\mathbf{D}$  be sets, and  $\mathbf{f}, \mathbf{g} : \mathbf{C} \rightarrow \mathbf{D}$  applications.*

*Let  $A, B \in \mathbf{PNTrans}[\mathbf{f}, \mathbf{g}]_3^{*(2)}$  be two parallel 3-cells whose 1-target is of weight 1.*

*There is a 4-cell  $\alpha : A \rightarrow B \in \mathbf{PNTrans}[\mathbf{f}, \mathbf{g}]_4^{*(2)}$ .*

Note that the theorem only holds for cells  $A, B \in \mathbf{PNTrans}[\mathbf{f}, \mathbf{g}]_3^{*(2)}$  whose 1-target is of weight 1. In the case of **Assoc**, it corresponds to only considering operations of coarity 1, which are the ones corresponding to terms. Here the 1-cells of weight 0 blur the picture, but since they have no computational meaning, the cells whose 1-target is of weight 1 are still those corresponding to terms.

This theorem will be proven in Section 3. Contrary to the case of bicategories and pseudofunctors, we cannot directly apply Theorem 1.22 to  $\mathbf{PNTrans}[\mathbf{f}, \mathbf{g}]$ , because the following critical pair is not confluent:

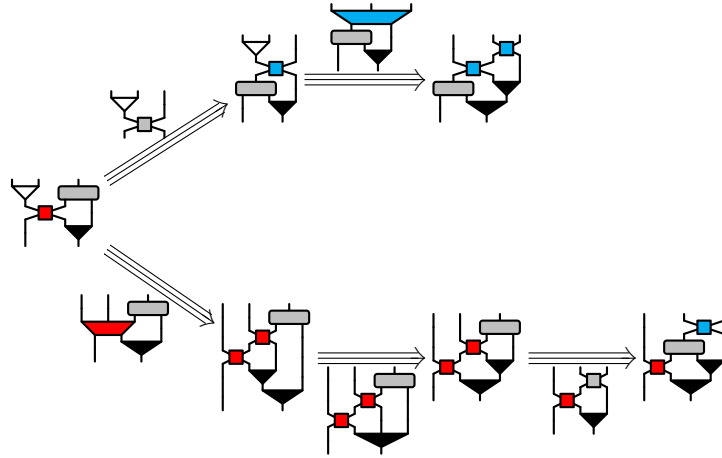

### 3 Proof of the coherence for pseudonatural transformations

In this section we prove Theorem 2.21. We fix for the rest of this section two sets  $\mathbf{C}$  and  $\mathbf{D}$ , together with two applications  $\mathbf{f}, \mathbf{g} : \mathbf{C} \rightarrow \mathbf{D}$ . Let  $A, B \in \mathbf{PNTrans}[\mathbf{f}, \mathbf{g}]^{*(2)}$  be 3-cells whose 1-target is of weight 1. We want to build a 4-cell  $\alpha : A \rightarrow B \in \mathbf{PNTrans}[\mathbf{f}, \mathbf{g}]^{*(2)}$ .

The 1-cells of weight 1 are of one of the following forms, with  $a, a' \in \mathbf{C}$  and  $b, b' \in \mathbf{D}$ :

$$a|a' \quad b|b' \quad a|a'|f(a') \quad a|a'|g(a') \quad a|a'|f(a') \quad a|g(a)|b \quad a|f(a)|b$$

In Section 3.1, we show that if the common 1-target of  $A$  and  $B$  is not of the last form, then they are generated by a sub-(4, 2)-polygraph  $\mathbf{PFonct}[\mathbf{f}, \mathbf{g}]$  of  $\mathbf{PNTrans}[\mathbf{f}, \mathbf{g}]$ . We then show using Theorem 1.22 that this polygraph is coherent.

There remains to treat the case where the 1-target of  $A$  and  $B$  is of the last form. We define two sub-(4, 2)-polygraphs of  $\mathbf{PNTrans}[\mathbf{f}, \mathbf{g}]$ :  $\mathbf{PNTrans}^{++}[\mathbf{f}, \mathbf{g}]$  and  $\mathbf{PNTrans}^+[\mathbf{f}, \mathbf{g}]$ . The polygraph  $\mathbf{PNTrans}^{++}[\mathbf{f}, \mathbf{g}]$  contains all the structure of pseudonatural transformations, except for the axioms concerning the units  $\circlearrowleft$  and  $\circlearrowright$ , while  $\mathbf{PNTrans}^+[\mathbf{f}, \mathbf{g}]$  is an intermediary between  $\mathbf{PNTrans}^{++}[\mathbf{f}, \mathbf{g}]$  and  $\mathbf{PNTrans}[\mathbf{f}, \mathbf{g}]$ , which contains the 2-cells  $\circlearrowleft$  and  $\circlearrowright$ . The inclusions between the polygraphs can be seen as follows:

$$\begin{aligned} \mathbf{PNTrans}^{++}[\mathbf{f}, \mathbf{g}]_2 &\subset \mathbf{PNTrans}^+[\mathbf{f}, \mathbf{g}]_2 = \mathbf{PNTrans}[\mathbf{f}, \mathbf{g}]_2 \\ \mathbf{PNTrans}^{++}[\mathbf{f}, \mathbf{g}]_3 &= \mathbf{PNTrans}^+[\mathbf{f}, \mathbf{g}]_3 \subset \mathbf{PNTrans}[\mathbf{f}, \mathbf{g}]_3 \end{aligned}$$

In Section 3.2 we show that  $\mathbf{PNTrans}^{++}[\mathbf{f}, \mathbf{g}]$  satisfies the 2-Squier condition of rank 2, which allows us to apply Theorem 1.27. Since 1-cells of the form  $a|f(a)|b$  are normal forms for  $\mathbf{PNTrans}^{++}[\mathbf{f}, \mathbf{g}]$ , this concludes the case where  $A$  and  $B$  are in  $\mathbf{PNTrans}^{++}[\mathbf{f}, \mathbf{g}]$ .

We then define a sub-polygraph  $\mathbf{PNTrans}^u[\mathbf{f}, \mathbf{g}]$  of  $\mathbf{PNTrans}[\mathbf{f}, \mathbf{g}]$ . The rewriting system induced by the 3-cells  $\mathbf{PNTrans}^u[\mathbf{f}, \mathbf{g}]$  corresponds to simplifying the units out.

Using the properties of this rewriting system, we extend the result of Section 3.2, first to 3-cells  $A$  and  $B$  in  $\mathbf{PNTrans}^+[\mathbf{f}, \mathbf{g}]$  in Section 3.3, and finally to general  $A$  and  $B$  whose 1-target is  $a|f(a)|b$  in Section 3.4, thereby concluding the proof.

#### 3.1 A convergent sub-polygraph of $\mathbf{PNTrans}[\mathbf{f}, \mathbf{g}]$

**Definition 3.1.** Let  $\mathbf{PFonct}[\mathbf{f}, \mathbf{g}]$  be the (4, 2)-polygraph containing every cell of  $\mathbf{PNTrans}[\mathbf{f}, \mathbf{g}]$ , except those corresponding to the pseudonatural transformation. Alternatively,  $\mathbf{PFonct}[\mathbf{f}, \mathbf{g}]$  is the union of  $\mathbf{PFonct}[\mathbf{f}]$  and  $\mathbf{PFonct}[\mathbf{g}]$ .

**Lemma 3.2.** For every  $h \in \mathbf{PNTrans}[\mathbf{f}, \mathbf{g}]_2^*$ , one of the following holds:

- The target of  $h$  is of the form

$$a_1 | \cdots | a_i | f(a_i) | b_1 | \cdots | b_j, \tag{8}$$

where  $i$  and  $j$  are non-zero integers, the  $a_k$  are in  $\mathbf{C}$  and the  $b_k$  in  $\mathbf{D}$ .

- The 2-cell  $h$  is in  $\mathbf{PFonct}[\mathbf{f}, \mathbf{g}]_2^*$ .

*Proof.* Let us show first that the set of all 1-cells of the form (8) is stable when rewritten by  $\mathbf{PFonct}[\mathbf{f}, \mathbf{g}]_2^*$ . To prove this, we examine the case of every cell of  $\mathbf{PFonct}[\mathbf{f}, \mathbf{g}]_2^*$  of length 1:

$$\begin{aligned} a_1 | \cdots | a_{k-1} | \nabla_{a_{k+1}} | \cdots | b_j &: a_1 | \cdots | b_j \Rightarrow a_1 | \cdots | a_{k-1} | a_{k+1} | \cdots | b_j \\ a_1 | \cdots | a_k | \circlearrowleft_{a_k} | \cdots | b_j &: a_1 | \cdots | b_j \Rightarrow a_1 | \cdots | a_k | a_k | \cdots | b_j \\ a_1 | \cdots | b_{k-1} | \nabla_{b_{k+1}} | \cdots | b_j &: a_1 | \cdots | b_j \Rightarrow a_1 | \cdots | b_{k-1} | b_{k+1} | \cdots | b_j \\ a_1 | \cdots | b_k | \circlearrowright_{b_k} | \cdots | b_j &: a_1 | \cdots | b_j \Rightarrow a_1 | \cdots | b_k | b_k | \cdots | b_j \\ a_1 | \cdots | a_{i-1} | \circlearrowleft_{f(a_i)} | \cdots | b_j &: a_1 | \cdots | b_j \Rightarrow a_1 | \cdots | a_{i-1} | f(a_{i-1}) | f(a_i) | \cdots | f(a_n) \end{aligned}$$

Let us now prove the lemma: we reason by induction on the length of  $h$ . If  $h$  is of length 0, it is an identity, so  $h$  is in  $\mathbf{PFonct}[\mathbf{f}, \mathbf{g}]_2^*$ .

If  $h$  is of length 1 and  $h$  is not in  $\mathbf{PFonct}[\mathbf{f}, \mathbf{g}]^*$ , then  $h$  has to be of the form  $|\cdots| \begin{array}{c} \longleftarrow \\ \longleftarrow \end{array} |\cdots|$ . So its target is of the form:

$$a_1|\cdots|a_k|\mathbf{f}(a_k)|\mathbf{g}(a_k)|b_2|\cdots|b_j$$



which is indeed of the form (8), with  $b_1 = \mathbf{g}(a_k)$ .

Let now  $h$  be of length  $n > 1$ . We can write  $h = h_1 \star_1 h_2$ , where  $h_2$  is of length 1, and  $h_1$  is strictly shorter than  $h$ . Let us apply the induction hypothesis to  $h_2$ . If the target of  $h_2$  is of the form (8), then so is the target of  $h$ , since  $\mathbf{t}(h_2) = \mathbf{t}(h)$ . Otherwise, then  $h_1 \in \mathbf{PFonct}[\mathbf{f}, \mathbf{g}]^*$ , and we can apply the induction hypothesis to  $h_2$ . If  $h_2$  also is in  $\mathbf{PFonct}[\mathbf{f}, \mathbf{g}]^*$ , then so is  $h$ .

It remains to treat the case where  $\mathbf{t}(h_1)$  is of the form (8), and  $h_2$  is in  $\mathbf{PFonct}[\mathbf{f}, \mathbf{g}]^*$ . But we have shown that the 1-cells of the form (8) are stable when rewritten by  $\mathbf{PFonct}[\mathbf{f}, \mathbf{g}]^*$ . Thus the target of  $h_2$  (which is the target of  $h$ ) is of the form (8), which concludes the proof.  $\square$

**Lemma 3.3.** *For every  $A \in \mathbf{PNTrans}[\mathbf{f}, \mathbf{g}]_3^{*(2)}$ , one of the following holds:*

- *The 1-target of  $A$  is of the form (8).*
- *The 3-cell  $A$  is in  $\mathbf{PFonct}[\mathbf{f}, \mathbf{g}]_3^{*(2)}$ .*

*Proof.* Let us start by the case where  $A$  is a 3-cell of length 1 in  $\mathbf{PNTrans}[\mathbf{f}, \mathbf{g}]_3^*$ . If the 1-target of  $A$  is not of the form (8) then, according to Lemma 3.2, the 2-source of  $A$  is in  $\mathbf{PFonct}[\mathbf{f}, \mathbf{g}]_2^*$ . The only 3-cell in  $\mathbf{PNTrans}[\mathbf{f}, \mathbf{g}]_3$  which is not in  $\mathbf{PFonct}[\mathbf{f}, \mathbf{g}]_3$  is the 3-cell , whose 2-source  is not in  $\mathbf{PFonct}[\mathbf{f}, \mathbf{g}]_2^*$ . Thus  $A$  is in  $\mathbf{PFonct}[\mathbf{f}, \mathbf{g}]_3^*$ .

Suppose now that  $A = B^{-1}$ , where  $B$  is a 3-cell of  $\mathbf{PNTrans}[\mathbf{f}, \mathbf{g}]_3^*$  of length 1. The 1-target of  $B$  is the same as the one of  $A$ . If it is not of the form (8),  $B$  is in  $\mathbf{PFonct}[\mathbf{f}, \mathbf{g}]_3^{*(2)}$ , and so is  $A$ .

In the general case,  $A$  is a composite of 3-cells of one of the two previous forms, and all of them have the same 1-target as  $A$ . Thus if the 1-target of  $A$  is not of the form (8), all those 3-cells are in  $\mathbf{PFonct}[\mathbf{f}, \mathbf{g}]_3^{*(2)}$ , and so is  $A$ .  $\square$

**Lemma 3.4.** *The 4-polygraph  $\mathbf{PFonct}[\mathbf{f}, \mathbf{g}]$  is 3-coherent.*

*Proof.* It is a sub-polygraph of  $\mathbf{PNTrans}[\mathbf{f}, \mathbf{g}]$  which is 3-terminating, therefore it is also 3-terminating. Moreover, every critical pair in  $\mathbf{PFonct}[\mathbf{f}, \mathbf{g}]$  arises from one either in  $\mathbf{PFonct}[\mathbf{f}]$  or  $\mathbf{PFonct}[\mathbf{g}]$ . Since those polygraphs are confluent and satisfy the Squier condition, so does  $\mathbf{PFonct}[\mathbf{f}, \mathbf{g}]$ .

Using Theorem 1.22, this means that  $\mathbf{PFonct}[\mathbf{f}, \mathbf{g}]$  is 3-coherent.  $\square$

**Proposition 3.5.** *Let  $\mathbf{f}, \mathbf{g} : \mathbf{C} \rightarrow \mathbf{D}$  be two applications.*

*For every parallel 3-cells  $A, B \in \mathbf{PNTrans}[\mathbf{f}, \mathbf{g}]_3^{*(2)}$  whose 1-target is not of the form (8), there exists a 4-cell  $\alpha : A \rightarrow B \in \mathbf{PNTrans}[\mathbf{f}, \mathbf{g}]_4^{*(2)}$ .*

*In particular, for every parallel 3-cells  $A, B \in \mathbf{PNTrans}[\mathbf{f}, \mathbf{g}]_3^{*(2)}$  whose 1-target is of weight 1 and is not of the form  $a|\mathbf{f}(a)|b$ , there exists a 4-cell  $\alpha : A \rightarrow B \in \mathbf{PNTrans}[\mathbf{f}, \mathbf{g}]_4^{*(2)}$ .*

*Proof.* Let  $A, B \in \mathbf{PNTrans}[\mathbf{f}, \mathbf{g}]_3^{*(2)}$  whose 1-target is not of the form (8). We want to build a 4-cell  $\alpha : A \rightarrow B \in \mathbf{PNTrans}[\mathbf{f}, \mathbf{g}]_4^{*(2)}$ . According to Lemma 3.3,  $A$  and  $B$  are actually 3-cells in  $\mathbf{PFonct}[\mathbf{f}, \mathbf{g}]_3^{*(2)}$ . In Lemma 3.4 we showed that  $\mathbf{PFonct}[\mathbf{f}, \mathbf{g}]$  is 3-coherent, hence there exists a 4-cell  $\alpha : A \rightarrow B \in \mathbf{PFonct}[\mathbf{f}, \mathbf{g}]_4^{*(2)} \subset \mathbf{PNTrans}[\mathbf{f}, \mathbf{g}]_4^{*(2)}$ .

Moreover, the only 1-cells of weight 1 and of the form (8) are the 1-cells  $a|\mathbf{f}(a)|b$ , which proves the second part of the Proposition.  $\square$

## 3.2 A sub-polygraph of $\mathbf{PNTrans}[\mathbf{f}, \mathbf{g}]$ satisfying 2-Squier condition of rank 2

**Definition 3.6.** Let  $\mathbf{PNTrans}^{++}[\mathbf{f}, \mathbf{g}]$  be the sub-(4, 2)-polygraph of  $\mathbf{PNTrans}[\mathbf{f}, \mathbf{g}]$  containing every cell from the first column of the table 4.

**Lemma 3.7.** *The (4, 2)-polygraph  $\mathbf{PNTrans}^{++}[\mathbf{f}, \mathbf{g}]$  satisfies the 2-Squier condition of rank 2.*

*Proof.* **The 2-Squier condition of rank 1**

Let us start by showing the 2-termination of  $\mathbf{PNTrans}^{++}[\mathbf{f}, \mathbf{g}]$ .

We define a functor  $\tau : \mathbf{PNTrans}[\mathbf{f}, \mathbf{g}]_1^* \rightarrow \mathbb{N}^3$ , where compositions in  $\mathbb{N}^3$  are given by component-wise addition, by defining:

- For all  $a, b \in \mathbf{C}$ ,  $\tau(a|b) = (1, 0, 0)$ .
- For all  $a \in \mathbf{C}$ ,  $\tau(a|_{\mathbf{f}(a)}) = (0, 1, 0)$
- For all  $a \in \mathbf{C}$ ,  $\tau(a|_{\mathbf{g}(a)}) = (0, 2, 0)$
- For all  $a, b \in \mathbf{D}$ ,  $\tau(a|b) = (0, 0, 1)$

The lexicographic order in  $\mathbb{N}^3$  induces a noetherian ordering on  $\mathbf{PNTrans}[\mathbf{f}, \mathbf{g}]_1^*$ . Moreover the 2-cells are indeed decreasing for this order:

$$\tau(\mathbf{s}(\nabla)) = (2, 0, 0) > (1, 0, 0) = \tau(\mathbf{t}(\nabla)) \quad \tau(\mathbf{s}(\blacktriangledown)) = (0, 0, 2) > (0, 0, 1) = \tau(\mathbf{t}(\blacktriangledown))$$

$$\tau(\mathbf{s}(\color{red}{\blacktriangleright})) = (1, 1, 0) > (0, 1, 1) = \tau(\mathbf{t}(\color{red}{\blacktriangleright})) \quad \tau(\mathbf{s}(\color{blue}{\blacktriangleright})) = (1, 2, 0) > (0, 2, 1) = \tau(\mathbf{t}(\color{blue}{\blacktriangleright}))$$

$$\tau(\mathbf{s}(\color{gray}{\blacktriangleright})) = (0, 2, 0) > (0, 1, 1) = \tau(\mathbf{t}(\color{gray}{\blacktriangleright}))$$

The following diagrams show both the 2-confluence of  $\mathbf{PNTrans}^{++}[\mathbf{f}, \mathbf{g}]$  and the correspondence between critical pairs and 3-cells:

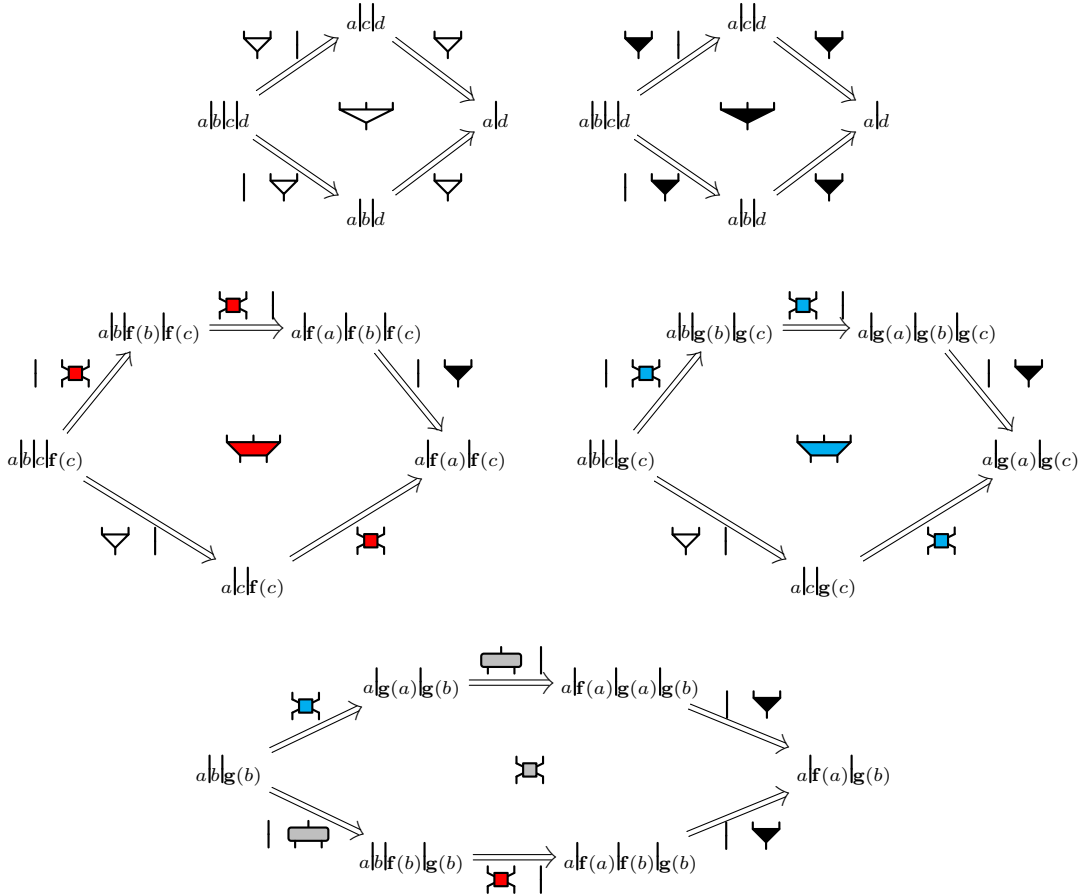



## The 2-Squier condition of rank 2

The following diagrams show the bijection between critical triples and 4-cells.

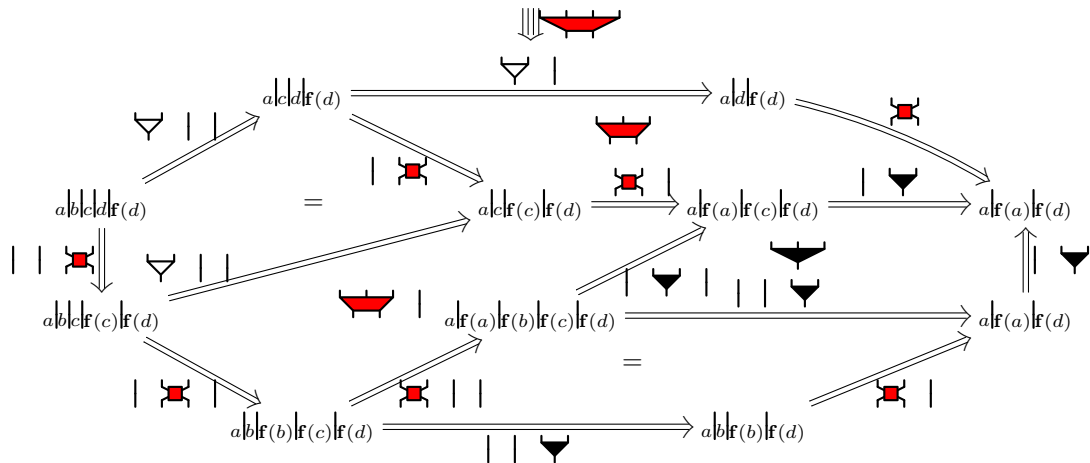
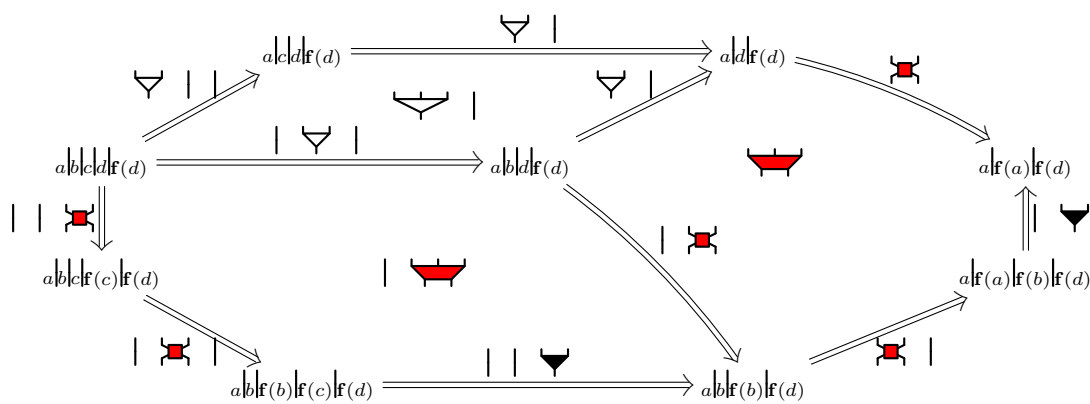
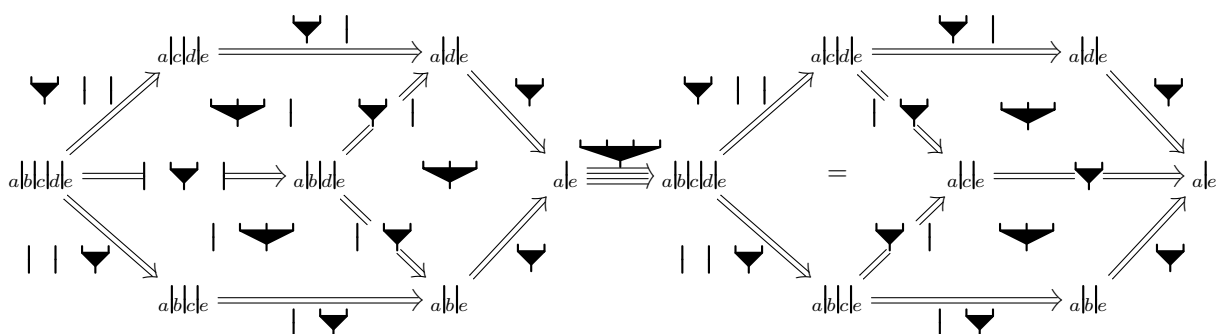
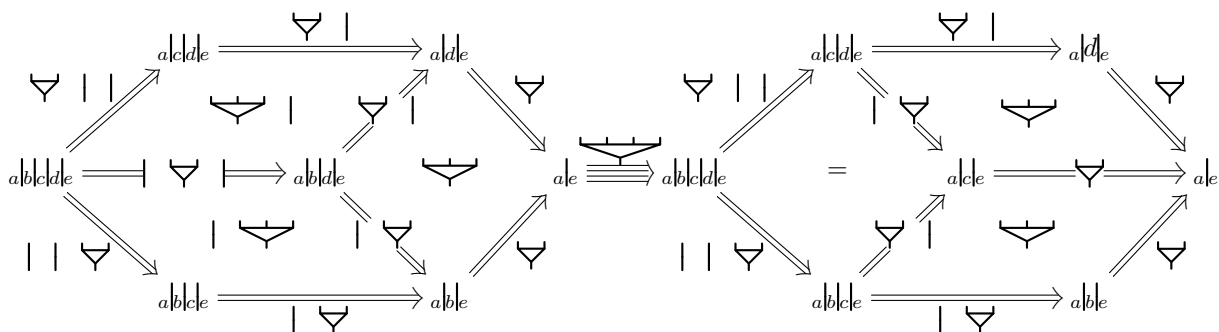

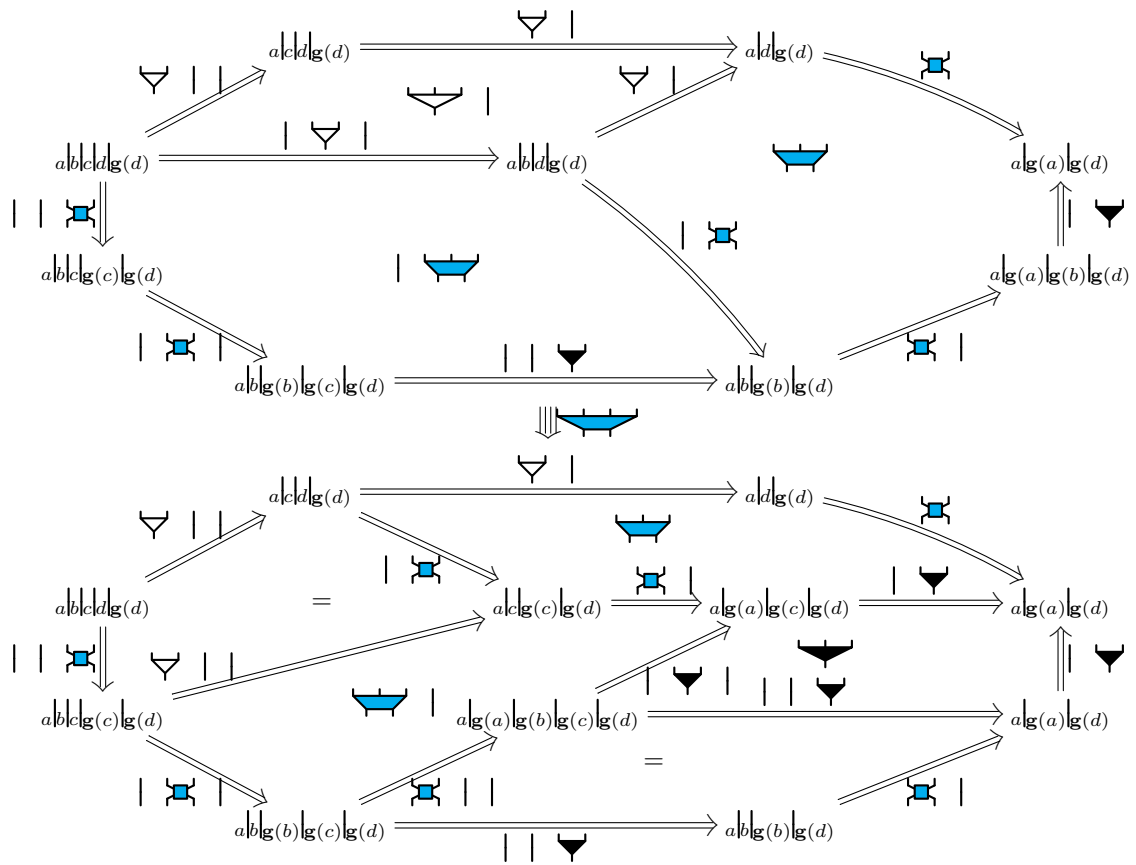

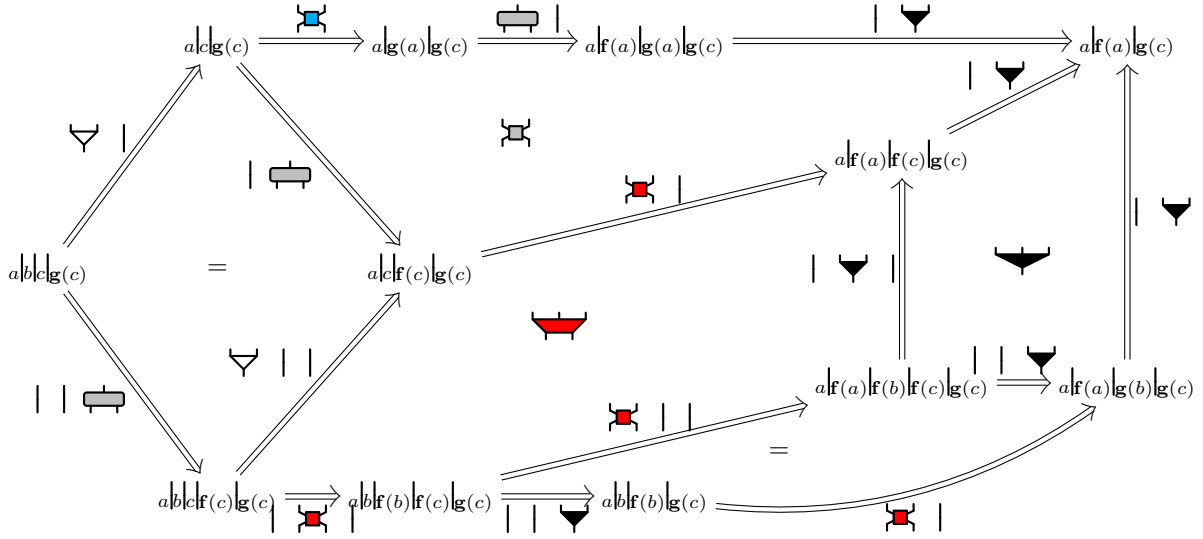
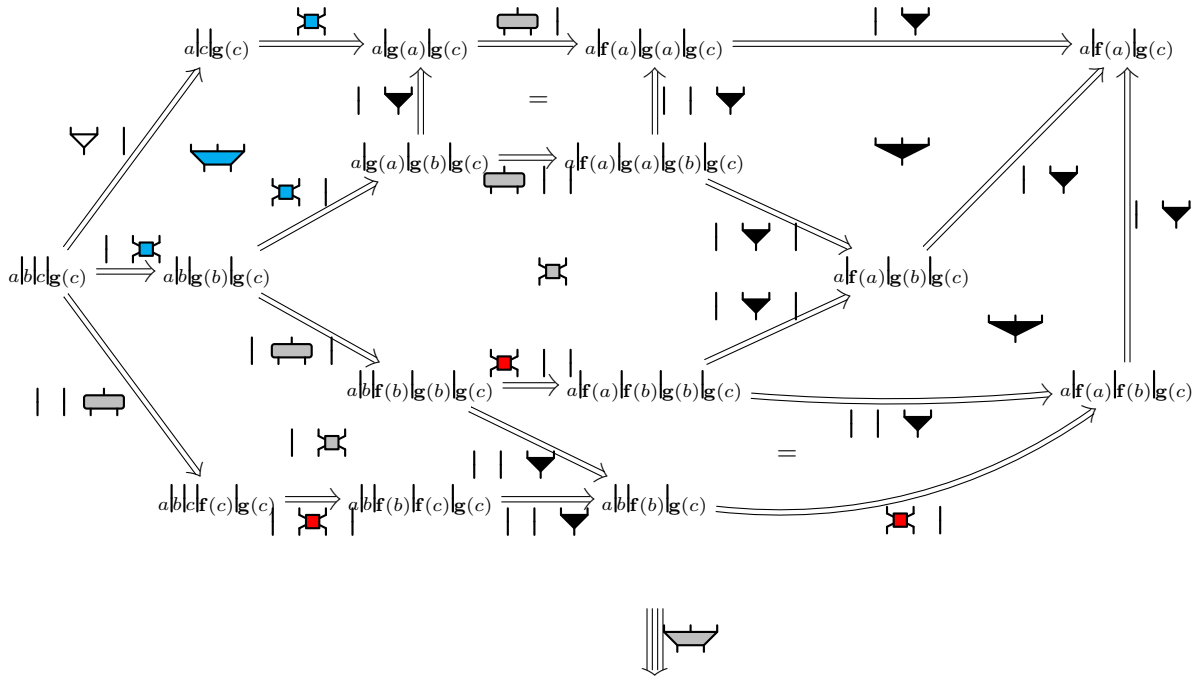

□

**Proposition 3.8.** For every 3-cells  $A, B \in \mathbf{PNTrans}^{++}[\mathbf{f}, \mathbf{g}]^{*(2)}$  whose 1-target is of the form  $a|_{\mathbf{f}(a)}|b$ , there exists a 4-cell  $\alpha : A \rightarrow B \in \mathbf{PNTrans}[\mathbf{f}, \mathbf{g}]^{*(2)}$ .

*Proof.* Thanks to Lemma 3.7, we can apply Theorem 1.27 to  $\mathbf{PNTrans}^{++}[\mathbf{f}, \mathbf{g}]^{*(2)}$ , and there exists a 4-cell  $\alpha : A \rightarrow B$  in  $\mathbf{PNTrans}^{++}[\mathbf{f}, \mathbf{g}]^{*(2)}$  for every 3-cells  $A, B \in \mathbf{PNTrans}^{++}[\mathbf{f}, \mathbf{g}]^{*(2)}$  whose 1-target is a normal form. In particular the 1-cells of the form  $a|_{\mathbf{f}(a)}|b$  are normal forms. □

### 3.3 Adjunction of the units 2-cells

**Definition 3.9.** Let  $\mathbf{PNTrans}^u[\mathbf{f}, \mathbf{g}]$  be the sub-3-polygraph of  $\mathbf{PNTrans}[\mathbf{f}, \mathbf{g}]$  containing the same 1- and 2-cells, and whose only 3-cells are the ones from the second column of table 4.

A 2-cell  $h \in \mathbf{PNTrans}[\mathbf{f}, \mathbf{g}]_2^*$  is said *unitary* if it is generated by the sub-polygraph of  $\mathbf{PNTrans}[\mathbf{f}, \mathbf{g}]$  whose only 2-cells are  $\circlearrowleft$  and  $\bullet$ .

**Lemma 3.10.** Let  $h \in \mathbf{PNTrans}[\mathbf{f}, \mathbf{g}]_2^*$  whose target is of the form  $a|_{\mathbf{f}(a)}|_b$ , where  $a \in \mathbf{C}$  and  $b \in \mathbf{D}$ .

If there is a decomposition  $h = h_1 \star_1 h_2$ , where  $h_1 \in \mathbf{PNTrans}^u[\mathbf{f}, \mathbf{g}]^*$  and  $h_2 \in \mathbf{PNTrans}[\mathbf{f}, \mathbf{g}]^*$  are not identities, and  $h_1$  is a unitary 2-cell, then there is a 3-cell  $A \in \mathbf{PNTrans}^u[\mathbf{f}, \mathbf{g}]_3^*$  of source  $h$  which is not an identity.

*Proof.* Let us start with the case where  $h_1$  is of length 1. We reason by induction on the length of  $h_2$ . If  $h_2$  is of length 1, since the target of  $h_2$  is of the form  $a|_{\mathbf{f}(a)}|_b$ ,  $h_2$  is one of the following 2-cells:



Hence  $h$  is one of the following 2-cells:



And all of these 2-cells are indeed the sources of 3-cells in  $\mathbf{PNTrans}^u[\mathbf{f}, \mathbf{g}]_3^*$ .

In the general case, let us write  $h_2 = h_0 \star_1 h_2'$ , where  $h_0$  is of length 1. Two cases can occur.

- If there exist 1-cells  $u, u', v$  and  $v'$  and 2-cells  $h_0' : u \Rightarrow u' \in \mathbf{PNTrans}^u[\mathbf{f}, \mathbf{g}]^*$  and  $h_1' : v \Rightarrow v' \in \mathbf{PNTrans}[\mathbf{f}, \mathbf{g}]^*$  such that  $h_1 = h_1' \star_0 u$  (resp.  $h_1 = u \star_0 h_1'$ ) and  $h_0 = v' \star_0 h_0'$  (resp.  $h_0 = h_0' \star_0 v'$ ). Then  $h = (h_1' \star_0 h_0') \star_1 h_2'$  (resp.  $h = (h_0' \star_0 h_1') \star_1 h_2'$ ), and we can apply the induction hypothesis to  $(h_1' \star_0 u) \star_1 h_2'$  (resp.  $(u' \star_0 h_1') \star_1 h_2'$ ).

- Otherwise,  $h_1 \star_1 h_0$  is one of the following 2-cells,

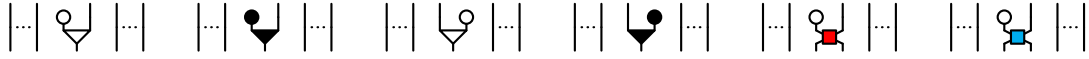

and all of them are sources of 3-cells in  $\mathbf{PNTrans}^u[\mathbf{f}, \mathbf{g}]^*$ .

In the case general case where  $h_1$  is of any length, let  $h_1', h_1'' \in \mathbf{PNTrans}[\mathbf{f}, \mathbf{g}]_2^*$  with  $h_1'$  of length 1 such that  $h_1 = h_1' \star_1 h_1''$ . Then there is a non-empty 3-cell  $A' \in \mathbf{PNTrans}^u[\mathbf{f}, \mathbf{g}]_3^*$  of source  $h_1' \star_1 h_2$ , and one can take the 3-cell  $h_1' \star_1 A'$ .  $\square$

**Lemma 3.11.** Let  $h$  be a 2-cell in  $\mathbf{PNTrans}[\mathbf{f}, \mathbf{g}]^*$  whose target is of the form  $a|_{\mathbf{f}(a)}|_b$ , with  $a \in \mathbf{C}$  and  $b \in \mathbf{D}$ .

If  $h$  is a normal form for  $\mathbf{PNTrans}^u[\mathbf{f}, \mathbf{g}]$ , then one of the following holds:

- The 2-cell  $h$  equals the composite  $| \blacklozenge$ .
- The 2-cell  $h$  is in  $\mathbf{PNTrans}^{++}[\mathbf{f}, \mathbf{g}]^*$ .

*Proof.* We reason by induction on the length of  $h$ . If  $h$  is of length 1, the cells of  $\mathbf{PNTrans}[\mathbf{f}, \mathbf{g}]_2^*$  of length 1 and of target  $a|_{\mathbf{f}(a)}|_b$  are:



Otherwise, let us write  $h = h_1 \star_1 h_2$ , where  $h_1$  is of length 1. We can apply the induction hypothesis to  $h_2$ , which leads us to distinguish three cases:

- If  $h_2 = | \blacklozenge$ , then  $h_1$  is a 2-cell in  $\mathbf{PNTrans}[\mathbf{f}, \mathbf{g}]_2^*$  whose target is of the form  $a|_{\mathbf{f}(a)}$ . The only such cell is the identity, and  $h = h_2 = | \blacklozenge$ .
- If  $h_1$  and  $h_2$  are in  $\mathbf{PNTrans}^{++}[\mathbf{f}, \mathbf{g}]^*$ , then  $h$  is in  $\mathbf{PNTrans}^{++}[\mathbf{f}, \mathbf{g}]^*$ .
- Lastly, if  $h_2$  is in  $\mathbf{PNTrans}^{++}[\mathbf{f}, \mathbf{g}]^*$  and  $h_1$  is in  $\mathbf{PNTrans}^u[\mathbf{f}, \mathbf{g}]^*$ , then because of Lemma 3.10,  $h$  is the source of a 3-cell in  $\mathbf{PNTrans}^u[\mathbf{f}, \mathbf{g}]^*$  of length 1, which is impossible since, by hypothesis,  $h$  is a normal form for  $\mathbf{PNTrans}^u[\mathbf{f}, \mathbf{g}]$ .  $\square$

**Definition 3.12.** Let  $\mathbf{PNTrans}^+[\mathbf{f}, \mathbf{g}]$  be the sub-3-polygraph of  $\mathbf{PNTrans}[\mathbf{f}, \mathbf{g}]$  containing  $\mathbf{PNTrans}^{++}[\mathbf{f}, \mathbf{g}]$ , together with the 2-cells  $\blacklozenge$  and  $\blacklozenge$ .

In particular a 3-cell in the free (3, 2)-category  $\mathbf{PNTrans}^+[\mathbf{f}, \mathbf{g}]^{*(2)}$  is in  $\mathbf{PNTrans}^{++}[\mathbf{f}, \mathbf{g}]^{*(2)}$  if and only if its 2-source is in  $\mathbf{PNTrans}^{++}[\mathbf{f}, \mathbf{g}]^{*(2)}$  too.

**Proposition 3.13.** *For every parallel 3-cells  $A, B \in \mathbf{PNTrans}^+[\mathbf{f}, \mathbf{g}]^{*(2)}$  whose 1-target is of the form  $a|_{\mathbf{f}(a)}|_b$  and whose 2-source is a normal form for  $\mathbf{PNTrans}^u[\mathbf{f}, \mathbf{g}]$ , there exists a 4-cell  $\alpha : A \rightarrow B \in \mathbf{PNTrans}[\mathbf{f}, \mathbf{g}]^{*(2)}$ .*

*Proof.* Given such 3-cells  $A$  and  $B$ , we use Lemma 3.11 to distinguish two cases:

If the source of  $A$  and  $B$  is  $| \blacklozenge$ , the only 3-cell in  $\mathbf{PNTrans}^+[\mathbf{f}, \mathbf{g}]^{*(2)}$  with source  $| \blacklozenge$  is the identity. So  $A = B$  and we can take  $\alpha = 1_A$ .

Otherwise, the source of  $A$  and  $B$  lies in  $\mathbf{PNTrans}^{++}[\mathbf{f}, \mathbf{g}]_2^*$ , so  $A$  and  $B$  lie in  $\mathbf{PNTrans}^{++}[\mathbf{f}, \mathbf{g}]_3^{*(2)}$ . Proposition 3.8 allows us to conclude.  $\square$

### 3.4 Adjunction of the units 3-cells

In this section, we consider the rewriting system formed by the 3-cells of  $\mathbf{PNTrans}^u[\mathbf{f}, \mathbf{g}]$ . Since it is a sub-polygraph of  $\mathbf{PNTrans}[\mathbf{f}, \mathbf{g}]$  (which 3-terminates by Proposition 2.19),  $\mathbf{PNTrans}^u[\mathbf{f}, \mathbf{g}]$  is 3-terminating. The fact that it is 3-confluent is a consequence of the following more general Lemma:

**Lemma 3.14.** *Let  $A \in \mathbf{PNTrans}[\mathbf{f}, \mathbf{g}]_3^*$  and  $B \in \mathbf{PNTrans}^u[\mathbf{f}, \mathbf{g}]_3^*$ . There exist 3-cells  $A' \in \mathbf{PNTrans}[\mathbf{f}, \mathbf{g}]_3^*$  and  $B' \in \mathbf{PNTrans}^u[\mathbf{f}, \mathbf{g}]^*$  and a 4-cell  $\alpha_{A,B} \in \mathbf{PNTrans}[\mathbf{f}, \mathbf{g}]_4^{*(2)}$  of the following shape:*

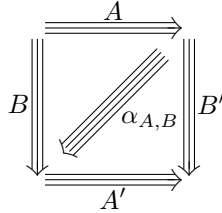

*Proof.* Let us start by the case where  $(A, B)$  is a critical pair of  $\mathbf{PNTrans}[\mathbf{f}, \mathbf{g}]_3$ . If  $A$  and  $B$  are in  $\mathbf{PFonct}[\mathbf{f}, \mathbf{g}]_3^*$ , the result holds because  $\mathbf{PFonct}[\mathbf{f}, \mathbf{g}]$  is 3-convergent. Otherwise, the only critical pair left is the following one:

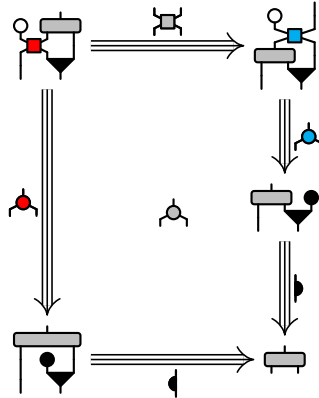

Let us now study the case where  $(A, B)$  is a local branching of  $\mathbf{PNTrans}[\mathbf{f}, \mathbf{g}]_3$ . We distinguish three cases depending on the shape of the branching:

- If  $(A, B)$  is an aspherical branching, then one can take identities for  $A'$  and  $B'$ , and  $\alpha = 1_A$ .
- If  $(A, B)$  is a Peiffer branching, let  $A'$  and  $B'$  be the canonical fillers of the confluence diagram of  $(A, B)$ , and  $\alpha$  be an identity.
- Lastly, if  $(A, B)$  is an overlapping branching, let us write  $(A, B) = (f \star_1 uA_1v \star_1 g, f \star_1 uB_1v \star_1 g)$ , where  $(A_1, B_1)$  is a critical pair. Let  $A'_1, B'_1$  and  $\alpha_1$  be the cells associated with  $(A_1, B_1)$ . We then define  $A' := f \star_1 uA'_1v \star_1 g$ ,  $B' := f \star_1 uB'_1v \star_1 g$  and  $\alpha_1 := f \star_1 u\alpha_1v \star_1 g$ .

In the general case, we reason by noetherian induction on  $h = \mathbf{s}(A) = \mathbf{s}(B)$ , using the 3-termination of  $\mathbf{PNTrans}[\mathbf{f}, \mathbf{g}]$ .

- If  $A$  or  $B$  is an identity, then the result holds immediately.
- Otherwise, we write  $A = A_1 \star_2 A_2$  and  $B = B_1 \star_2 B_2$ , where  $A_1$  and  $B_1$  are of length 1. We now build the following diagram:

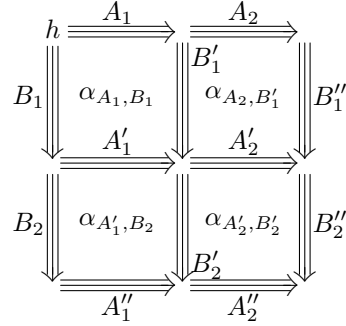

In this diagram,  $\alpha_{A_1, B_1}$  is obtained thanks to our study of the local branchings. The existence of  $\alpha_{A_2, B'_1}$  and  $\alpha_{A'_1, B_2}$  (followed by  $\alpha_{A'_2, B'_2}$ ) then follows from the induction hypothesis.  $\square$

**Lemma 3.15.** *Let  $f, g$  be 2-cells of  $\mathbf{PNTrans}[f, g]^*$ , and  $A : f \Rightarrow g$  a 3-cell of  $\mathbf{PNTrans}^+[f, g]^*$ . If  $f$  is a normal form for  $\mathbf{PNTrans}^u[f, g]$ , then so is  $g$ .*

*Proof.* We prove this result by contrapositive. We are going to show that for any  $A \in \mathbf{PNTrans}^+[f, g]^*$  and  $B \in \mathbf{PNTrans}^u[f, g]^*$  two 3-cells of length 1 such that  $\mathbf{t}(A) = \mathbf{s}(B)$ , there exists  $B' \in \mathbf{PNTrans}^u[f, g]^*$  of length 1 and of source  $\mathbf{s}(A)$ :

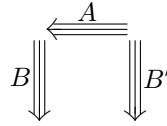

Two cases can occur depending on the shape of the branching  $(A^{-1}, B)$ :

- If it is a Peiffer branching, then the required cell is provided by the canonical filling.
- If it is an overlapping branching, then it is enough to check the underlying critical pair.

It remains to examine those critical pairs:

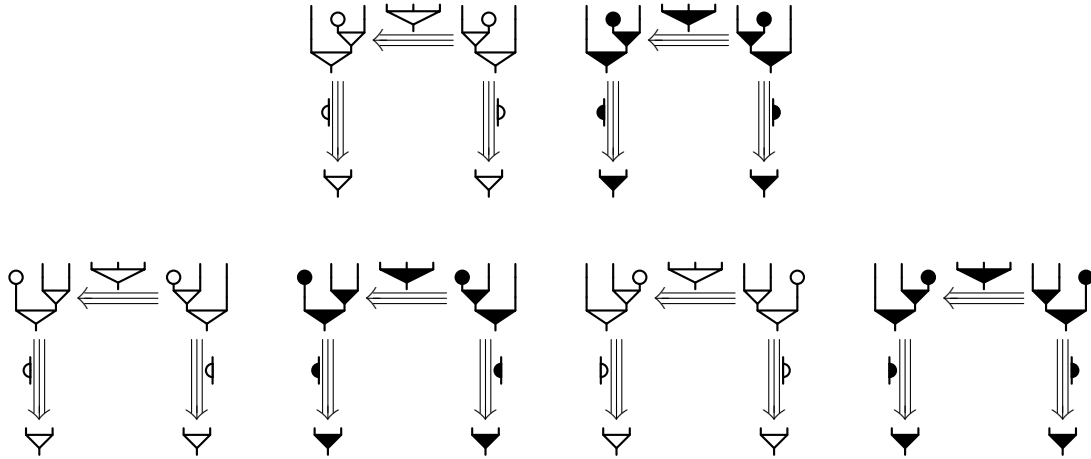

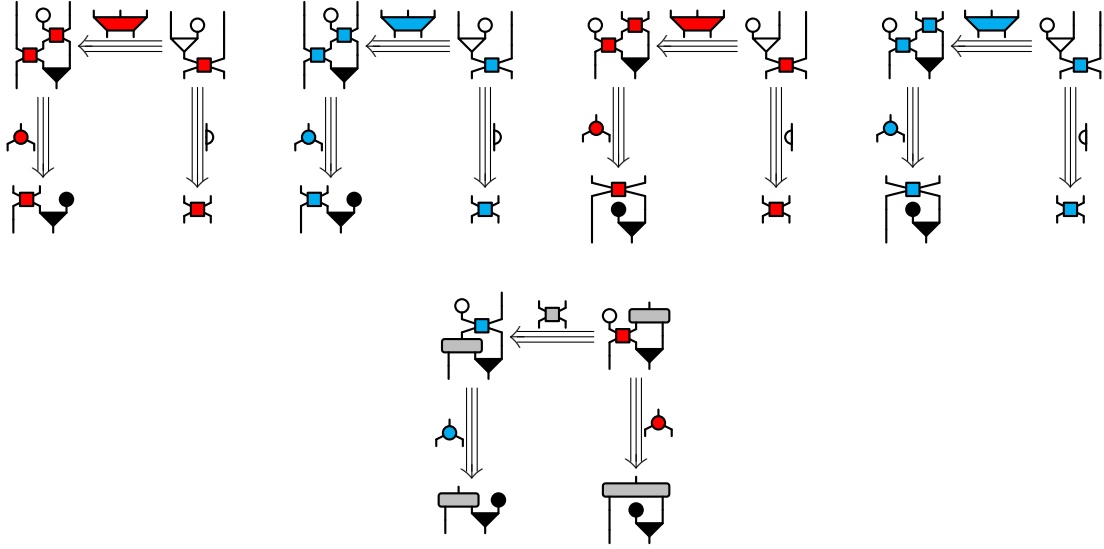

□

**Lemma 3.16.** *Let  $A \in \mathbf{PNTrans}[\mathbf{f}, \mathbf{g}]_3^*$ . If the source of  $A$  is a normal form for  $\mathbf{PNTrans}^u[\mathbf{f}, \mathbf{g}]$ , then  $A$  is in  $\mathbf{PNTrans}^+[\mathbf{f}, \mathbf{g}]$ .*

*Proof.* We reason by induction on the length of  $A$ :

- If  $A$  is an identity, then it is in  $\mathbf{PNTrans}^+[\mathbf{f}, \mathbf{g}]$ .
- Otherwise, let us write  $A = A_1 \star_2 A_2$ , where  $A_1$  is of length 1. Since the source of  $A$  is a normal form for  $\mathbf{PNTrans}^u[\mathbf{f}, \mathbf{g}]$ , the 3-cell  $A_1$  can only be in  $\mathbf{PNTrans}^+[\mathbf{f}, \mathbf{g}]^*$ .

According to Lemma 3.15, the normal forms for  $\mathbf{PNTrans}^u[\mathbf{f}, \mathbf{g}]$  are stable when rewritten by  $\mathbf{PNTrans}^+[\mathbf{f}, \mathbf{g}]^*$ . Hence the source  $A_2$  is a normal form for  $\mathbf{PNTrans}^u[\mathbf{f}, \mathbf{g}]$ , and by induction hypothesis,  $A_2$  is in  $\mathbf{PNTrans}^+[\mathbf{f}, \mathbf{g}]^*$ . By composition, so is  $A$ .

□

**Lemma 3.17.** *Let  $A$  be a 3-cell in  $\mathbf{PNTrans}[\mathbf{f}, \mathbf{g}]^{*(2)}$ . There exist  $C_1, C_2 \in \mathbf{PNTrans}^u[\mathbf{f}, \mathbf{g}]_3^*$  whose target is a normal form for  $\mathbf{PNTrans}^u[\mathbf{f}, \mathbf{g}]$ , a 3-cell  $A' \in \mathbf{PNTrans}^+[\mathbf{f}, \mathbf{g}]_3^{*(2)}$  and a 4-cell  $\alpha \in \mathbf{PNTrans}[\mathbf{f}, \mathbf{g}]_4^{*(2)}$  of the following shape:*

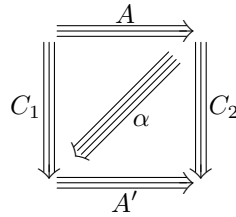

*Proof.* Let us write  $A = A_1^{-1} \star_2 B_1 \star_2 A_2^{-1} \dots \star_2 A_n^{-1} \star_2 B_n$ , where the  $A_i$  and  $B_i$  are in  $\mathbf{PNTrans}[\mathbf{f}, \mathbf{g}]_3^*$ . For every  $i \leq n$ , we chose a 3-cell  $D_i \in \mathbf{PNTrans}^u[\mathbf{f}, \mathbf{g}]_3^*$  of source  $s(A_i) = s(B_i)$  and of target a normal form for  $\mathbf{PNTrans}^u[\mathbf{f}, \mathbf{g}]$ .

According to Lemma 3.14, there exist for every  $i$  some 3-cells  $A'_i, B'_i$  in  $\mathbf{PNTrans}[\mathbf{f}, \mathbf{g}]^*$ ,  $D'_i \in \mathbf{PNTrans}^u[\mathbf{f}, \mathbf{g}]_3^*$  and  $D''_i \in \mathbf{PNTrans}^u[\mathbf{f}, \mathbf{g}]_3^*$  and some 4-cells  $\alpha_i$  and  $\beta_i$  in  $\mathbf{PNTrans}[\mathbf{f}, \mathbf{g}]^{*(2)}$  of the form:

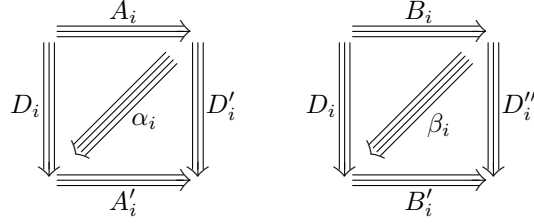

The following is a consequence of the target of  $D_i$  being a normal form for  $\mathbf{PNTrans}^u[\mathbf{f}, \mathbf{g}]$ :

- Using Lemma 3.16,  $A'_i$  and  $B'_i$  are in  $\mathbf{PNTrans}^+[\mathbf{f}, \mathbf{g}]^*$ ,
- Using Lemma 3.15, the target  $A'_i$  and  $B'_i$  (thus of  $D'_i$  and  $D''_i$ ) are normal forms for  $\mathbf{PNTrans}^u[\mathbf{f}, \mathbf{g}]$ .
- Since  $\mathbf{PNTrans}^u[\mathbf{f}, \mathbf{g}]$  is 3-convergent, for any  $i < n$ , the cells  $D''_i$  and  $D'_{i+1}$  are parallel.

Since  $\mathbf{PNTrans}^u[\mathbf{f}, \mathbf{g}]$  is a sub-polygraph of  $\mathbf{PFonct}[\mathbf{f}, \mathbf{g}]$  which is 3-coherent, there exists, for every  $i < n$ , a 4-cell  $\gamma_i : D''_i \rightarrow D'_i$  in  $\mathbf{PFonct}[\mathbf{f}, \mathbf{g}]_4^{*(2)}$ .

We can now conclude the proof of this Lemma by taking  $C_1 = D'_1$ ,  $C_2 = D''_n$  and  $A' = (A'_1)^{-1} \star_2 B'_2 \star_2 \dots \star_2 (A'_n)^{-1} \star_2 B'_n$ , and by defining  $\alpha$  as the following composite:

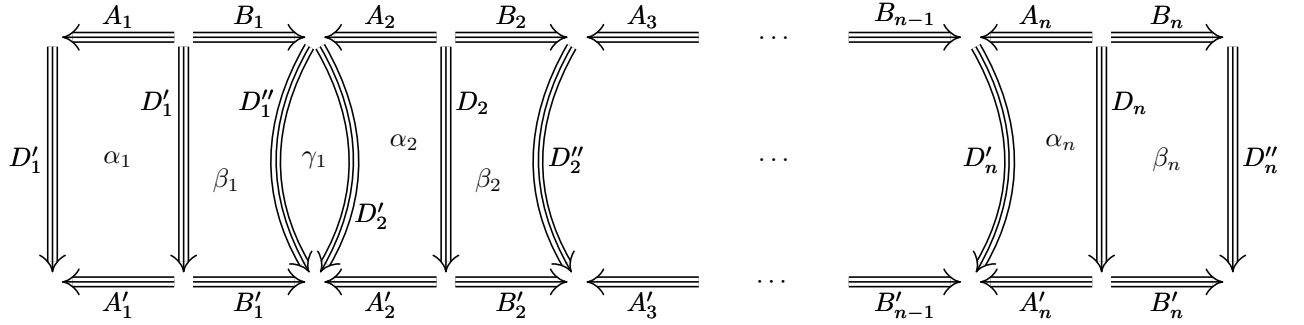

□

**Proposition 3.18.** For every 3-cells  $A, B \in \mathbf{PNTrans}[\mathbf{f}, \mathbf{g}]^{*(2)}$  whose 1-target is of the form  $a|_{\mathbf{f}(a)}|_b$ , there exists a 4-cell  $\alpha : A \rightarrow B \in \mathbf{PNTrans}[\mathbf{f}, \mathbf{g}]^{*(2)}$ .

Let  $\mathbf{f}, \mathbf{g} : \mathbf{C} \rightarrow \mathbf{D}$  be two applications.

Suppose that, for every 3-cells  $A, B \in \mathbf{PNTrans}^+[\mathbf{f}, \mathbf{g}]^{*(2)}$  such that:

- their 1-target is of the form  $a|_{\mathbf{f}(a)}|_b$ , with  $a \in \mathbf{C}$  and  $b \in \mathbf{D}$ ,
- their 2-source is a normal form for  $\mathbf{PNTrans}^u[\mathbf{f}, \mathbf{g}]$ ,

there exists a 4-cell  $\alpha : A \rightarrow B \in \mathbf{PNTrans}[\mathbf{f}, \mathbf{g}]^{*(2)}$ .

Then Theorem 2.21 holds.

*Proof.* Let  $A, B \in \mathbf{PNTrans}[\mathbf{f}, \mathbf{g}]_3^{*(2)}$  be two parallel 3-cells whose 1-target is  $a|_{\mathbf{f}(a)}|_b$ . We are going to build a 4-cell  $\alpha : A \rightarrow B \in \mathbf{PNTrans}[\mathbf{f}, \mathbf{g}]_4^{*(2)}$ .

According to Lemma 3.17, there exist  $C_1, C_2, C'_1, C'_2 \in \mathbf{PNTrans}^u[\mathbf{f}, \mathbf{g}]^*$  whose targets are normal forms for  $\mathbf{PNTrans}^u[\mathbf{f}, \mathbf{g}]$ ,  $A', B' \in \mathbf{PNTrans}^+[\mathbf{f}, \mathbf{g}]^{*(2)}$  and  $\alpha_1, \alpha_2 \in \mathbf{TPN}[\mathbf{f}, \mathbf{g}]_4^{*(2)}$  such that we have the diagrams:

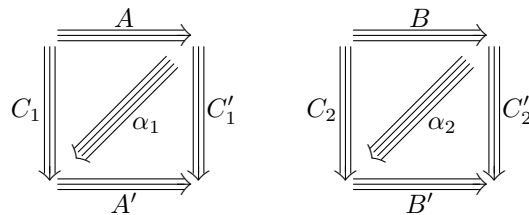



The 3-cells  $A$  and  $B$  are parallel, and the 3-cells  $C_1$  and  $C_2$  (resp.  $C'_1$  and  $C'_2$ ) have the same source and have a normal form for  $\mathbf{PNTrans}^u[\mathbf{f}, \mathbf{g}]$  as target. Since  $\mathbf{PNTrans}^u[\mathbf{f}, \mathbf{g}]$  is 3-convergent, this implies that the 3-cells  $C_1$  and  $C_2$  (resp.  $C'_1$  and  $C'_2$ ) are parallel. This has two consequences:

- The critical pairs of  $\mathbf{PNTrans}^u[\mathbf{f}, \mathbf{g}]$  already appeared in  $\mathbf{PFonct}[\mathbf{f}, \mathbf{g}]$ , and we showed that they admit fillers. Hence there exist cells  $\beta_1 : C_1 \rightarrow C_2$  and  $\beta_2 : C'_1 \rightarrow C'_2$  in  $\mathbf{PNTrans}[\mathbf{f}, \mathbf{g}]_4^{*(2)}$ .
- The 3-cells  $A'$  and  $B'$  are parallel, their 1-target is still  $a|_{\mathbf{f}(a)}b$ , and their 2-source is a normal form for  $\mathbf{PNTrans}^u[\mathbf{f}, \mathbf{g}]$ . So by Proposition 3.13 there exists a 4-cell  $\gamma : A' \rightarrow B'$ .

To conclude, we define  $\alpha$  as the following composite (where we omit the context of the 4-cells):

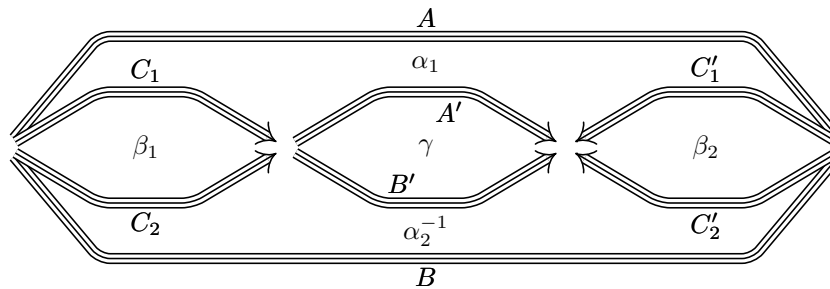

□

## 4 Partial coherence and transformation of polygraphs

We now go back to the proof of Theorem 1.27. In this Section we prove a series of results in preparation for Section 5. In order to have general enough results, we start in Section 4.1 by defining the notion of white-category, together with the associated notion of white-polygraph. The 2-white-categories are also known as *sesquicategories* (see [18]). White-categories are strict categories in which the interchange law between the compositions  $\star_0$  and  $\star_i$  need not hold, for every  $i > 0$ . That is, strict  $n$ -categories are exactly the  $n$ -white-categories satisfying the additional condition that for every  $i$ -cells  $f$  and  $g$  of 1-sources (resp. 1-targets)  $u$  and  $v$  (resp.  $u'$  and  $v'$ ):  $(f \star_0 v) \star_i (u' \star_0 g) = (u \star_0 g) \star_i (f \star_0 v)$ .

In Section 4.2, we study injective functors between free white-categories. In particular, we give a sufficient condition for a morphism of white-polygraphs to yield an injective functor between the white-categories they generate. This result will be used in Section 5.3.

In Section 4.3, we define a notion of partial coherence for  $(4, 3)$ -white-categories. We show a simple criterion in order to deduce the partial coherence of a  $(4, 3)$ -white-category from that of an other one. This criterion will be used throughout Section 5. We also adapt the notion of Tietze-transformation from [5] to our setting of partial coherence in white-categories, in preparation for Section 5.5.

### 4.1 White-categories and White-polygraphs

**Definition 4.1.** Let  $n \in \mathbb{N}$ . An  $(n + 1)$ -white-category is given by:

- a set  $\mathcal{C}_0$ ,
- for every  $x, y \in \mathcal{C}_0$ , an  $n$ -category  $\mathcal{C}(x, y)$ . We note  $\star_{k+1}$  the  $k$ -composition in this category,
- for every  $z \in \mathcal{C}_0$  and every  $u : x \rightarrow y \in \mathcal{C}_1$ , functors  $u \star_0 \_ : \mathcal{C}(y, z) \rightarrow \mathcal{C}(x, z)$  and  $\_ \star_0 u : \mathcal{C}(z, x) \rightarrow \mathcal{C}(z, y)$ , so that for every composable 1-cells  $u, v \in \mathcal{C}_1$ , their composite  $u \star_0 v$  is defined in a unique way,
- for every  $x \in \mathcal{C}_0$ , a 1-cell  $1_x \in \mathcal{C}(x, x)$ .

Moreover, this data must satisfy the following axioms:

- For every  $x \in \mathcal{C}_0$ , and every  $y \in \mathcal{C}_0$ , the functors  $1_x \star_0 \_ : \mathcal{C}(x, y) \rightarrow \mathcal{C}(x, y)$  and  $\_ \star_0 1_y : \mathcal{C}(x, y) \rightarrow \mathcal{C}(x, y)$  are identities.
- For every  $u, v \in \mathcal{C}_1$ , the following equalities hold:
  - $u \star_0 (v \star_0 \_) = (u \star_0 v) \star_0 \_$ ,
  - $u \star_0 (\_ \star_0 v) = (u \star_0 \_) \star_0 v$ ,
  - $\_ \star_0 (u \star_0 v) = (\_ \star_0 u) \star_0 v$ ,

An  $(n, k)$ -white-category is an  $n$ -white-category in which every  $(i + 1)$ -cell is invertible for the  $i$ -composition, for every  $i \geq k$ .

**Definition 4.2.** Let  $\mathcal{C}$  and  $\mathcal{D}$  be  $n$ -white-categories. An  $n$ -white-functor is given by:

- an application  $F_0 : \mathcal{C}_0 \rightarrow \mathcal{D}_0$ ,
- for every  $x, y \in \mathcal{C}_0$ , a functor  $F_{x,y} : \mathcal{C}(x, y) \rightarrow \mathcal{D}(F_0(x), F_0(y))$ .

Moreover, this data must satisfy the following axioms:

- for every  $x \in \mathcal{C}_0$ ,  $F(1_x) = 1_{F_0(x)}$ ,
- for every  $z \in \mathcal{C}_0$  and  $u : x \rightarrow y \in \mathcal{C}_1$ , the following equalities hold between functors:
  - $F(u) \star_0 F(\_) = F(u \star_0 \_) : \mathcal{C}(y, z) \rightarrow \mathcal{D}(F_0(x), F_0(z))$
  - $F(\_) \star_0 F(u) = F(\_ \star_0 u) : \mathcal{C}(z, x) \rightarrow \mathcal{D}(F_0(z), F_0(y))$

This makes  $n$ -white-categories into a category, that we note  $\mathbf{WCat}_n$ .

**Remark 4.3.** Let us define a structure of monoidal category  $\otimes$  on  $\mathbf{Cat}_n$ , in such a way that  $\mathbf{WCat}_{n+1}$  is the category of categories enriched over  $(\mathbf{Cat}_n, \otimes)$ .

Let  $\mathcal{C}, \mathcal{D}$  be two  $n$ -categories. The  $n$ -categories  $\mathcal{C} \times \mathcal{D}_0$  and  $\mathcal{C}_0 \times \mathcal{D}$  are defined as follows:

$$\mathcal{C} \times \mathcal{D}_0 := \bigsqcup_{y \in \mathcal{D}_0} \mathcal{C}, \quad \mathcal{C}_0 \times \mathcal{D} := \bigsqcup_{x \in \mathcal{C}_0} \mathcal{D}$$

Let  $\mathcal{C}_0 \times \mathcal{D}_0$  be the  $n$ -category whose 0-cells are couples  $(x, y) \in \mathcal{C}_0 \times \mathcal{D}_0$ , and whose  $i$ -cells are identities for every  $i > 0$ . Let  $F : \mathcal{C}_0 \times \mathcal{D}_0 \rightarrow \mathcal{C} \times \mathcal{D}_0$  (resp.  $G : \mathcal{C}_0 \times \mathcal{D}_0 \rightarrow \mathcal{C}_0 \times \mathcal{D}$ ) be the  $n$ -functor which is the identity on 0-cells.

Then  $\mathcal{C} \otimes \mathcal{D}$  is the pushout  $(\mathcal{C} \times \mathcal{D}_0) \oplus_{\mathcal{C}_0 \times \mathcal{D}_0} (\mathcal{C}_0 \times \mathcal{D})$ :

$$\begin{array}{ccc} \mathcal{C}_0 \times \mathcal{D}_0 & \xrightarrow{F} & \mathcal{C} \times \mathcal{D}_0 \\ G \downarrow & \lrcorner & \downarrow \\ \mathcal{C}_0 \times \mathcal{D} & \longrightarrow & \mathcal{C} \otimes \mathcal{D}. \end{array}$$

The category of  $n$ -white-categories equipped with a cellular extension, noted  $\mathbf{WCat}_n^+$ , is the limit of the following diagram:

$$\begin{array}{ccc} \mathbf{WCat}_n^+ & \longrightarrow & \mathbf{Graph}_{n+1} \\ \downarrow & \lrcorner & \downarrow \\ \mathbf{WCat}_n & \longrightarrow & \mathbf{Graph}_n \end{array}$$

where the functor  $\mathbf{WCat}_n \rightarrow \mathbf{Graph}_n$  forgets the white-categorical structure and the functor  $\mathbf{Graph}_{n+1} \rightarrow \mathbf{Graph}_n$  deletes the top-dimensional cells.

Let  $\mathcal{R}_n^w$  be the functor from  $\mathbf{WCat}_{n+1}$  to  $\mathbf{WCat}_n^+$  that sends an  $(n+1)$ -white-category  $\mathcal{C}$  on the couple  $(\mathcal{C}_n, \mathcal{C}_n \xleftarrow{\quad} \mathcal{C}_{n+1})$ .

**Proposition 4.4.** *The functor  $\mathcal{R}_n^w$  admits a left-adjoint  $\mathcal{L}_n^w : \mathbf{WCat}_n^+ \rightarrow \mathbf{WCat}_{n+1}$ .*

*Proof.* Let  $(\mathcal{C}, \Sigma) \in \mathbf{WCat}_n^+$  be an  $n$ -white-category equipped with a cellular extension. The construction of  $\mathcal{L}_n^w(\mathcal{C}, \Sigma)$  is split into three parts:

- First, we define a formal language  $E_\Sigma$ .
- Then, we define a typing system  $T_\mathcal{C}$  on  $E_\Sigma$ . We note  $E_\Sigma^T$  the set of all typable expressions of  $E_\Sigma$ .
- Finally, we define an equivalence relation  $\equiv_\Sigma^*$  on  $E_\Sigma^T$ . The set of  $(n+1)$ -cell of  $\mathcal{L}_n^w(\mathcal{C}, \Sigma)$  is then the quotient  $E_\Sigma^T / \equiv_\Sigma^*$ .

Let  $E_\Sigma$  be the formal language consisting of:

- For every 1-cells  $u, v \in \mathcal{C}_1$ , and every  $(n+1)$ -cell  $A \in \Sigma_{n+1}$ , such that  $\mathbf{t}_0(u) = \mathbf{s}_0(A)$  and  $\mathbf{t}_0(A) = \mathbf{s}_0(A)$ , a constant symbol  $c_{uAv}$ .
- For every  $n$ -cell  $f \in \mathcal{C}_n$ , a constant symbol  $i_f$ .
- For every  $0 < i \leq n$ , a binary function symbol  $\star_i$ .

Thus  $E_\Sigma$  is the smallest set of expressions containing the constant symbols and such that  $e \star_i f \in \Sigma$  whenever  $e, f \in E_\Sigma$ .

Let  $T_\mathcal{C}$  be the set of all  $n$ -spheres of  $\mathcal{C}$ . For  $e \in E_\Sigma$  and  $t \in T_\mathcal{C}$ , we define  $e : t$  (read as " $e$  is of type  $t$ ") as the smallest relation satisfying the following axioms:

- For every 1-cells  $u$  and  $v$  in  $\mathcal{C}_1$ , and every  $(n+1)$ -cell  $A \in \Sigma$ , such that  $\mathbf{t}_0(u) = \mathbf{s}_0(A)$  and  $\mathbf{t}_0(A) = \mathbf{s}_0(A)$

$$c_{uAv} : (us(A)v, ut(A)v)$$

- For every  $n$ -cell  $f \in \mathcal{C}_n$

$$i_f : (f, f)$$

- For every  $e_1, e_2 \in E_\Sigma$  and  $i < n$ , if  $e_1 : (s_1, t_1)$ ,  $e_2 : (s_2, t_2)$  and  $\mathbf{t}_i(t_1) = \mathbf{s}_i(s_2)$ , then

$$e_1 \star_i e_2 : (s_1 \star_i s_2, t_1 \star_i t_2)$$

- For every  $e_1, e_2 \in E_\Sigma$ , if  $e_1 : (s_1, t_1)$ ,  $e_2 : (s_2, t_2)$  and  $t_1 = s_2$ , then

$$e_1 \star_n e_2 : (s_1, t_2)$$

An expression  $e \in E_\Sigma$  is said to be *typable*  $e : (s, t)$  for some  $n$ -sphere  $(s, t) \in T_\mathcal{C}$ . Moreover there is only one such  $n$ -sphere, so the operations  $\mathbf{s}(e) := s$  and  $\mathbf{t}(e) := t$  are well defined. We note  $E_\Sigma^T$  be the set of all typable expressions.

Let  $\equiv_\Sigma$  be the symmetric relation generated by the following relations on  $E_\Sigma^T$ :

- For every  $A, B, C, D \in E_\Sigma^T$ , and every  $i_1, i_2 \leq n$  non-zero distinct natural numbers,

$$(A \star_{i_1} B) \star_{i_2} (C \star_{i_1} D) \equiv_\Sigma (A \star_{i_2} C) \star_{i_1} (B \star_{i_2} D)$$

- For every  $A, B, C \in E_\Sigma^T$ , and every  $0 < i \leq n$ ,

$$(A \star_i B) \star_i C \equiv_\Sigma A \star_i (B \star_i C)$$

- For every  $A \in E_\Sigma^T$  and  $f \in \mathcal{C}_n$ :

$$i_f \star_n A \equiv_\Sigma A \quad A \star_n i_f \equiv_\Sigma A$$

- For every  $f_1, f_2 \in \mathcal{C}_n$  and every  $i < n$ ,

$$i_{f_1} \star_i i_{f_2} \equiv_\Sigma i_{f_1 \star_i f_2}$$

- For every  $A, A', B \in E_\Sigma^T$  and every  $0 < i \leq n$ , if  $A \equiv_\Sigma A'$ , then

$$A \star_i B \equiv_\Sigma A' \star_i B$$

- For every  $A, B, B' \in E_\Sigma^T$  and every  $0 < i \leq n$ , if  $B \equiv_\Sigma B'$ , then

$$A \star_i B \equiv_\Sigma A \star_i B'$$

Let  $\equiv_\Sigma^*$  be the reflexive closure of  $\equiv_\Sigma$ . The  $(n+1)$ -cells of  $\mathcal{L}_n^w(\mathcal{C}, \Sigma)$  are given by the quotient  $E_\Sigma^T / \equiv_\Sigma^*$ . The  $i$ -composition is given by the one of  $E_\Sigma^T$ , and identities by  $i_f$ .  $\square$

**Definition 4.5.** We now define by induction on  $n$  the category  $\mathbf{WPol}_n$  of  $n$ -polygraphs together with a functor  $\mathcal{Q}_n^w : \mathbf{WPol}_n \rightarrow \mathbf{WCat}_n$ .

- The category  $\mathbf{WPol}_0$  is the category of sets, and  $\mathcal{Q}_0^w$  is the identity functor.
- Assume  $\mathcal{Q}_n^w : \mathbf{WPol}_n \rightarrow \mathbf{WCat}_n$  defined. Then  $\mathbf{WPol}_{n+1}$  is the limit of the following diagram:

$$\begin{array}{ccc} \mathbf{WPol}_{n+1} & \longrightarrow & \mathbf{WCat}_n^+ \\ \downarrow & \lrcorner & \downarrow \\ \mathbf{WPol}_n & \xrightarrow{\mathcal{Q}_n^w} & \mathbf{WCat}_n, \end{array}$$

and  $\mathcal{Q}_{n+1}^w$  is the composite

$$\mathbf{WPol}_{n+1} \longrightarrow \mathbf{WCat}_n^+ \xrightarrow{\mathcal{L}_n^w} \mathbf{WCat}_{n+1}$$

Given an  $n$ -white-polygraph  $\Sigma$ , the  $n$ -white-category  $\mathcal{Q}_n^{\mathbf{w}}(\Sigma)$  is noted  $\Sigma^{\mathbf{w}}$  and is called *the free  $n$ -white-category generated by  $\Sigma$* .

**Definition 4.6.** Let  $\mathbf{WCat}_{n+1}^{\mathbf{w}(n)}$  be the category of  $(n+1, n)$ -white-categories. Once again we have a functor  $\mathcal{R}_n^{\mathbf{w}(n)} : \mathbf{WCat}_{n+1}^{\mathbf{w}(n)} \rightarrow \mathbf{WCat}_n^+$ , and we are going to describe its left-adjoint  $\mathcal{L}_{n+1}^{\mathbf{w}(n)}$ . Let  $(\mathcal{C}, \Sigma)$  be an  $n$ -white-category together with a cellular extension. To construct  $\mathcal{L}_{n+1}^{\mathbf{w}(n)}(\mathcal{C}, \Sigma)$ , we adapt the construction of the free  $n$ -white-categories as follows:

- Let  $F_{\Sigma}$  be the formal language  $E_{\Sigma \cup \bar{\Sigma}}$ , where  $\bar{\Sigma}$  consists of formal inverses to the elements of  $\Sigma$  (that is their source and targets are reversed).
- The type system is extended by setting, for every 1-cells  $u, v$  in  $\mathcal{C}_1$  and every  $(n+1)$ -cell  $A \in \Sigma$  such that  $\mathbf{t}_0(u) = \mathbf{s}_0(A)$  and  $\mathbf{t}_0(A) = \mathbf{s}_0(v)$ :

$$c_{u\bar{A}v} : (ut(A)v, us(A)v).$$

We note  $F_{\Sigma}^T$  the set of all typable expressions for this new typing system.

- We extend  $\equiv_{\Sigma}$  into a relation noted  $\cong_{\Sigma}$  by adding the following relations:

$$c_{uAv} \star_n c_{u\bar{A}v} \cong_{\Sigma} i_{us(A)v} \quad c_{u\bar{A}v} \star_n c_{uAv} \cong_{\Sigma} i_{ut(A)v}$$

for every  $u, v$  in  $\mathcal{C}_1$  and every  $(n+1)$ -cell  $A \in \Sigma$ , such that  $\mathbf{t}_0(u) = \mathbf{s}_0(A)$  and  $\mathbf{t}_0(A) = \mathbf{s}_0(v)$ .

We define categories  $\mathbf{WPol}_n^{(k)}$  of  $(n, k)$ -white-polygraphs and functors  $\mathcal{Q}_n^{\mathbf{w}(k)} : \mathbf{WPol}_n^{(k)} \rightarrow \mathbf{WCat}_n^{(k)}$  in a similar way to  $\mathbf{Pol}_n^{(k)}$  and  $\mathcal{Q}_n^{(k)}$ .

**Definition 4.7.** Given an  $(n, k)$ -white-polygraph  $\Sigma$ , the  $(n, k)$ -white-category  $\mathcal{Q}_n^{\mathbf{w}(k)}(\Sigma)$  is noted  $\Sigma^{\mathbf{w}(k)}$  and is called *the free  $(n, k)$ -white-category generated by  $\Sigma$* .

## 4.2 Injective functors between white-categories

An injective morphism between  $(n, k)$ -polygraphs does not always induce an injective functor between the free  $(n, k)$ -categories they generate (see Example 4.8). In what follows, we prove some sufficient conditions so that it may be the case, in the setting of  $(n, k)$ -white-categories. This is achieved in Lemma 4.13. This result will be used in Section 5.3.

To prove this result, we start by studying the more general case of an injective morphism  $I$  between  $(n, k)$ -white-categories equipped with a cellular extension. When its image is *closed by divisors*, we show a simple sufficient condition so that  $I$  induces an injective  $(n+1)$ -white-functor. We also show that the image of the  $(n+1)$ -white-functor induced by  $I$  is then automatically closed by divisors. Hence this hypothesis disappears when we go back to morphisms of  $(n, k)$ -white-polygraphs. In particular we show that every injective morphism of  $n$ -white-polygraphs induces an injective  $n$ -white-functor.

**Example 4.8.** We are going to define two  $(2, 1)$ -polygraphs  $\Sigma$  and  $\Gamma$ , a morphism of polygraphs  $F : \Sigma \rightarrow \Gamma$  which is injective in every dimension, and two distinct 2-cells  $f, g \in \Sigma^{*(1)}$  such that  $F^{*(1)}(f) = F^{*(1)}(g)$ .

Let  $\Sigma$  be the following polygraph:

$$\Sigma_0 = \{*\} \quad \Sigma_1 = \{|\ : * \rightarrow *\} \quad \Sigma_2 := \{\phi, \bar{\phi} : | \Rightarrow |\}$$

and  $\Gamma$ :

$$\Gamma_0 = \{*\} \quad \Gamma_1 = \{|\ : * \rightarrow *\} \quad \Gamma_2 := \{\phi, \bar{\phi} : | \Rightarrow |, \bullet : | \rightarrow 1_*\}$$

Let  $F$  be the inclusion of  $\Sigma$  into  $\Gamma$ .

Let  $f = \begin{array}{c} \circ \\ | \\ \square \\ | \\ \circ \end{array}$  and  $g = \begin{array}{c} \square \\ | \\ \circ \\ | \\ \circ \end{array}$ . Using the exchange law, the following equality holds in  $\Gamma^{*(1)}$ , where  $\bullet$  denotes the inverse of  $\phi$ :

$$F(f) = \begin{array}{c} \circ \\ | \\ \square \\ | \\ \circ \end{array} = \begin{array}{c} \circ \\ | \\ \circ \\ | \\ \square \\ | \\ \circ \end{array} = \begin{array}{c} \circ \\ | \\ \circ \\ | \\ \bullet \\ | \\ \circ \end{array} = \begin{array}{c} \bullet \\ | \\ \square \\ | \\ \circ \end{array} = \begin{array}{c} \square \\ | \\ \circ \\ | \\ \circ \end{array} = F(g)$$

For the rest of this section, we fix two  $n$ -white-categories equipped with cellular extensions  $(\mathcal{C}, \Sigma), (\mathcal{C}', \Sigma') \in \mathbf{WCat}^+$ , and a morphism  $I : (\mathcal{C}, \Sigma) \rightarrow (\mathcal{C}', \Sigma') \in \mathbf{WCat}^+$ . That is,  $I$  is given by an  $n$ -white functor  $I : \mathcal{C} \rightarrow \mathcal{C}'$  together with an application  $I_{n+1} : \Sigma \rightarrow \Sigma'$  such that the following squares are commute:

$$\begin{array}{ccc} \Sigma & \xrightarrow{I_{n+1}} & \Sigma' \\ \mathbf{s} \downarrow & = & \downarrow \mathbf{s} \\ \mathcal{C} & \xrightarrow{I} & \mathcal{C}' \end{array} \quad \begin{array}{ccc} \Sigma & \xrightarrow{I_{n+1}} & \Sigma' \\ \mathbf{t} \downarrow & = & \downarrow \mathbf{t} \\ \mathcal{C} & \xrightarrow{I} & \mathcal{C}' \end{array}$$

We note  $I^{\mathbf{w}}$  (resp.  $I^{\mathbf{w}^{(n)}}$ ) the  $(n+1)$ -white-functor  $\mathcal{L}^{\mathbf{w}}(I)$  (resp.  $\mathcal{L}^{\mathbf{w}^{(n)}}(I)$ ). By definition,  $I^{\mathbf{w}}$  (resp.  $I^{\mathbf{w}^{(n)}}$ ) is induced by an application from  $E_{\Sigma}^T$  to  $E_{\Sigma'}^T$  (resp. from  $F_{\Sigma}^T$  to  $F_{\Sigma'}^T$ ), that we again denote by  $I^{\mathbf{w}}$  (resp.  $I^{\mathbf{w}^{(n)}}$ ).

Using their explicit definitions, the following properties of  $I^{\mathbf{w}}$  (resp.  $I^{\mathbf{w}^{(n)}}$ ) hold:

- Any element of  $E_{\Sigma}^T$  (resp.  $F_{\Sigma}^T$ ) whose image is an  $i$ -composite is an  $i$ -composite.
- Any element of  $E_{\Sigma}^T$  (resp.  $F_{\Sigma}^T$ ) whose image is a an identity is an identity.
- Any element of  $E_{\Sigma}^T$  (resp.  $F_{\Sigma}^T$ ) whose image is a  $c_{u'A'v'}$  is a  $c_{uAv}$ .
- Any element of  $F_{\Sigma}^T$  whose image by  $I^{\mathbf{w}^{(n)}}$  is a  $c_{u'\bar{A}'v'}$  is a  $c_{u\bar{A}v}$ .

**Lemma 4.9.** *Assume that the application  $I_{n+1}$  is injective, and that  $I$  induces an injection on  $\mathcal{C}$ .*

*Then the applications  $I^{\mathbf{w}} : E_{\Sigma}^T \rightarrow E_{\Sigma'}^T$ , and  $I^{\mathbf{w}^{(n)}} : F_{\Sigma}^T \rightarrow F_{\Sigma'}^T$  are injective.*

*Proof.* Let  $a_1, a_2 \in E_{\Sigma}^T$  such that  $I^{\mathbf{w}}(a_1) = I^{\mathbf{w}}(a_2)$ . We reason by induction on the structure of  $I^{\mathbf{w}}(a_1)$ .

If  $I^{\mathbf{w}}(a_1) = c_{u'A'v'}$ , with  $u', v' \in \mathcal{C}'_1$  and  $A' \in \Sigma'$ . Then there are  $u_1, v_1, u_2, v_2 \in \mathcal{C}_1$  and  $A_1, A_2 \in \Sigma$  such that  $a_1 = c_{u_1A_1v_1}$  and  $a_2 = c_{u_2A_2v_2}$ , and so:

$$I(u_1) = I(u_2) = u' \quad I_{n+1}(A_1) = I_{n+1}(A_2) = A' \quad I(v_1) = I(v_2) = v'.$$

Since  $I$  and  $I_{n+1}$  are injective, we get:

$$u_1 = u_2 \quad A_1 = A_2 \quad v_1 = v_2,$$

which proves that  $a = b$ .

If  $I^{\mathbf{w}}(a_1) = i_{f'}$ , with  $f' \in \mathcal{C}'_n$ . Then there exist  $f_1, f_2 \in \mathcal{C}_n$  such that:

$$a_1 = i_{f_1} \quad a_2 = i_{f_2} \quad I(f_1) = f' \quad I(f_2) = f'.$$

Since  $I$  is injective,  $f_1 = f_2$ , and so  $a_1 = a_2$ .

If  $I^{\mathbf{w}}(a_1) = A' \star_i B'$ , with  $i < n$ , and  $A', B' \in E_{\Sigma'}^T$ . Then there exist  $A_1, A_2, B_1, B_2 \in E_{\Sigma}^T$  such that:

$$a_1 = A_1 \star_i B_1 \quad a_2 = A_2 \star_i B_2 \quad I^{\mathbf{w}}(A_1) = I^{\mathbf{w}}(A_2) = A' \quad I^{\mathbf{w}}(B_1) = I^{\mathbf{w}}(B_2) = B'.$$

Using the induction hypothesis, we get that  $A_1 = A_2$  and  $B_1 = B_2$ , and so  $a_1 = a_2$ .

In the case of  $I^{\mathbf{w}^{(n)}}$ , we reason as previously, and we have one more case to check: if  $I^{\mathbf{w}^{(n)}}(a_1) = c_{u'\bar{A}'v'}$ , with  $u', v' \in \mathcal{C}'_1$  and  $A' \in \Sigma'$ . Then there are  $u_1, v_1, u_2, v_2 \in \mathcal{C}_1$  and  $A_1, A_2 \in \Sigma$  such that  $a_1 = c_{u_1\bar{A}_1v_1}$  and  $a_2 = c_{u_2\bar{A}_2v_2}$ , and so:

$$I(u_1) = I(u_2) = u' \quad I_{n+1}(A_1) = I_{n+1}(A_2) = A' \quad I(v_1) = I(v_2) = v'.$$

Using the injectivity of  $I$  and  $I_{n+1}$ , we get:

$$u_1 = u_2 \quad A_1 = A_2 \quad v_1 = v_2,$$

and finally  $a_1 = a_2$ . □

**Definition 4.10.** Let  $\mathcal{C}$  be an  $n$ -white-category, and  $E$  be a subset of  $\mathcal{C}_n$ . We say that  $E$  is *closed by divisors* if, for any  $f \in E$ , if  $f = f_1 \star_i f_2$ , then  $f_1$  and  $f_2$  are in  $E$ .

**Lemma 4.11.** Assume the image of  $I$  in  $\mathcal{C}_n$  is closed by divisors, and that  $I$  and  $I_{n+1}$  are injective.

Then, for every  $a', b' \in E_{\Sigma'}^T$  such that  $a' \equiv_{\Sigma'} b'$ , and for every  $a \in E_{\Sigma}^T$  such that  $I^{\mathbf{w}}(a) = a'$ , there exists  $b \in E_{\Sigma}^T$  such that

$$I^{\mathbf{w}}(b) = b' \quad a \equiv_{\Sigma} b.$$

Assume moreover that the application  $I_{n+1}$  is bijective and that  $I$  is bijective on the 1-cells of  $\mathcal{C}$ .

Then, for every  $a', b' \in F_{\Sigma'}^T$  such that  $a' \cong_{\Sigma'} b'$ , and for every  $a \in F_{\Sigma}^T$  such that  $I^{\mathbf{w}(n)}(a) = a'$ , there exists  $b \in F_{\Sigma}^T$  such that

$$I^{\mathbf{w}(n)}(b) = b' \quad a \cong_{\Sigma} b$$

*Proof.* To show the result on  $I^{\mathbf{w}}$  we reason by induction on the structure of  $a'$ .

If there exist  $A', B', C', D' \in E_{\Sigma'}^T$ ,  $0 < i_1 < i_2 \leq n$  and  $a \in E_{\Sigma}^T$  such that:

$$a' = (A' \star_{i_1} B') \star_{i_2} (C' \star_{i_1} D') \quad b' = (A' \star_{i_2} C') \star_{i_1} (B' \star_{i_2} D') \quad I^{\mathbf{w}}(a) = a',$$

then,  $a = (A \star_{i_1} B) \star_{i_2} (C \star_{i_1} D)$ , with  $A, B, C, D \in E_{\Sigma}^T$ . Let  $b := (A \star_{i_2} C) \star_{i_1} (B \star_{i_2} D)$ : by construction, we have  $I^{\mathbf{w}}(b) = b'$  and  $a \equiv_{\Sigma} b$ . The case where the roles of  $a'$  and  $b'$  are reversed is symmetrical.

If there exist  $A', B', C' \in E_{\Sigma'}^T$ ,  $0 < i \leq n$  and  $a \in E_{\Sigma}^T$  such that:

$$a' = (A' \star_i B') \star_i C' \quad b' = A' \star_i (B' \star_i C') \quad I^{\mathbf{w}}(a) = a',$$

then,  $a = (A \star_i B) \star_i C$ , with  $A, B, C \in E_{\Sigma}^T$ . Let  $b := A \star_i (B \star_i C)$ : By construction, we have  $I^{\mathbf{w}}(b) = b'$  and  $a \equiv_{\Sigma} b$ . The case where the roles of  $a'$  and  $b'$  are reversed is symmetrical.

If there exist  $A' \in E_{\Sigma}^T$ ,  $f' \in \mathcal{C}'_n$  and  $a \in E_{\Sigma}^T$  such that

$$a' = i_{f'} \star_n A' \quad b' = A' \quad I^{\mathbf{w}}(a) = a',$$

then  $a = i_f \star_n A$ , with  $f \in \mathcal{C}_n$  and  $A \in E_{\Sigma}^T$ . Let  $b := A'$ : by construction, we have  $I^{\mathbf{w}}(b) = b'$  and  $a \equiv_{\Sigma} b$ .

If there exist  $A' \in E_{\Sigma}^T$ ,  $f' \in \mathcal{C}'_n$  and  $a \in E_{\Sigma}^T$  such that

$$a' = A' \quad b' = i_{f'} \star_n A' \quad I^{\mathbf{w}}(a) = a',$$

let  $b := i_{\mathbf{s}(A)} \star_n a$ . Since  $b'$  is well typed, we have  $f' = \mathbf{s}(A')$ , hence  $I(\mathbf{s}(A)) = \mathbf{s}(I^{\mathbf{w}}(A)) = \mathbf{s}(A') = f'$ , and so  $I^{\mathbf{w}}(b) = b'$  and  $a \equiv_{\Sigma} b$ . The case of the right-unit is symmetrical.

If there are  $f'_1, f'_2 \in \mathcal{C}'_n$ ,  $i < n$  and  $a \in E_{\Sigma}^T$  such that:

$$a' = i_{f'_1} \star_i i_{f'_2} \quad b' = i_{f'_1 \star_i f'_2} \quad I^{\mathbf{w}}(a) = a',$$

then  $a = i_{f_1} \star_i i_{f_2}$ , with  $f_1, f_2 \in \mathcal{C}_n$ . Let  $b := i_{f_1 \star_i f_2}$ : by construction, we have  $I^{\mathbf{w}}(b) = b'$  and  $a \equiv_{\Sigma} b$ .

If there are  $f'_1, f'_2 \in \mathcal{C}'_n$ ,  $i < n$  and  $a \in E_{\Sigma}^T$  such that:

$$a' = i_{f'_1 \star_i f'_2} \quad b' = i_{f'_1} \star_i i_{f'_2} \quad I^{\mathbf{w}}(a) = a'$$

then  $a = i_f$ , with  $f \in \mathcal{C}_n$ . Since the image of  $I$  in  $\mathcal{C}_n$  is closed by divisors, there exist  $f_1, f_2 \in \mathcal{C}_n$  such that

$$I(f_1) = f'_1 \quad I(f_2) = f'_2 \quad f = f_1 \star_i f_2.$$

Let us define  $b' := i_{f_1} \star_i i_{f_2}$ : By construction, we have  $I^{\mathbf{w}}(b) = b'$  and  $a \equiv_{\Sigma} b$ .

If there are  $A'_1, A'_2, B' \in E_{\Sigma'}^T$ ,  $i \leq n$  and  $a \in E_{\Sigma}^T$  such that:

$$a' = A'_1 \star_i B' \quad A'_1 \equiv_{\Sigma'} A'_2 \quad b' = A'_2 \star_i B' \quad I^{\mathbf{w}}(a) = a'$$

then  $a = A_1 \star_i B$ , with  $A_1, B \in E_{\Sigma}^T$ . Using the induction hypothesis, there exist  $A_2 \in E_{\Sigma}^T$  such that  $I^{\mathbf{w}}(A_2) = A'_2$  and  $A_1 \equiv_{\Sigma} A_2$ . Let us define  $b := A_2 \star_i B$ : by construction, we have  $I^{\mathbf{w}}(b) = b'$  and  $a \equiv_{\Sigma} b$ . The last case is symmetric.

In the case of  $I^{\mathbf{w}(n)}$ , we reason as previously, and we have two more cases to check. If there exist  $u', v' \in \mathcal{C}'_1$ ,  $A \in \Sigma'$  and  $a \in E_{\Sigma}^T$  such that:

$$a' = c_{u'A'v'} \star_n c_{u'\bar{A}'v'} \quad b' = i_{u'\mathbf{s}(A')v'} \quad I^{\mathbf{w}(n)}(a) = a'$$

then  $a = c_{u_1A_1v_2} \star_n c_{u_2\bar{A}_2v_2}$ , with  $u_1, u_2, v_1, v_2 \in \mathcal{C}_1$  and  $A_1, A_2 \in \Sigma$  such that:

$$I(u_1) = I(u_2) = u' \quad I(v_1) = I(v_2) = v' \quad I_{n+1}(A_1) = I_{n+1}(A_2) = A.$$

Let  $b := i_{u_1\mathbf{s}(A_1)v_1}$ . Since  $I$  and  $I_{n+1}$  are injective, we have  $I^{\mathbf{w}}(b) = b'$  and  $a \cong_{\Sigma} b$ .

If there exist  $u', v' \in \mathcal{C}'_1$ ,  $A \in \Sigma'$  and  $a \in E_{\Sigma}^T$  such that

$$a' = i_{u'\mathbf{s}(A')v'} \quad b' = c_{u'A'v'} \star_n c_{u'\bar{A}'v'} \quad I^{\mathbf{w}(n)}(a) = a'$$

Then  $a = i_f$ , with  $f \in \mathcal{C}_n$ . Let  $b' := c_{uAv} \star_i c_{u\bar{A}v}$ , with  $u = I^{-1}(u')$ ,  $v = I^{-1}(v')$  and  $A = I_{n+1}^{-1}(A')$ : by construction, we have  $I^{\mathbf{w}}(b) = b'$  and  $a \cong_{\Sigma} b$ . The final case is symmetrical.  $\square$

**Lemma 4.12.** *Assume that  $I_{n+1}$  and  $I$  are injective, and that the image of  $I$  in  $\mathcal{C}_n$  is closed by divisors. Then the functor  $I^{\mathbf{w}} : L^{\mathbf{w}}(\mathcal{C}, \Sigma) \rightarrow L^{\mathbf{w}}(\mathcal{C}', \Sigma')$  is injective, and its image is closed by divisors.*

*Assume moreover that  $I_{n+1}$  is bijective, and that  $I$  is bijective on the 1-cells of  $\mathcal{C}$ . Then the functor  $I^{\mathbf{w}(n)} : L^{\mathbf{w}(n)}(\mathcal{C}, \Sigma) \rightarrow L^{\mathbf{w}(n)}(\mathcal{C}', \Sigma')$  is injective and its image is closed by divisors.*

*Proof.* Let  $f_1, f_2 \in L^{\mathbf{w}}(\mathcal{C}, \Sigma)$  and  $a_1, a_2 \in E_{\Sigma}^T$  such that:

$$I^{\mathbf{w}}(f_1) = I^{\mathbf{w}}(f_2) \quad [a_1] = f_1 \quad [a_2] = f_2.$$

Then  $[I^{\mathbf{w}}(a_1)] = [I^{\mathbf{w}}(a_2)]$ , that is  $I^{\mathbf{w}}(a_1) \equiv_{\Sigma'}^* I^{\mathbf{w}}(a_2)$ . Hence by definition, there exist  $n > 0$  and  $t'_1, \dots, t'_n \in E_{\Sigma'}^T$  such that:

$$t'_1 = I^{\mathbf{w}}(a_1) \quad t'_i \equiv_{\Sigma'} t'_{i+1} \quad t'_n = I^{\mathbf{w}}(a_2).$$

Applying Lemma 4.11 successively, we get  $t_1, \dots, t_n \in E_{\Sigma}^T$  such that:

$$t_1 = a_1 \quad t_i \equiv_{\Sigma} t_{i+1} \quad I^{\mathbf{w}}(t_i) = t'_i.$$

In particular  $a_1 \equiv_{\Sigma}^* t_n$  and  $I^{\mathbf{w}}(t_n) = t'_n = I^{\mathbf{w}}(a_2)$ . Using Lemma 4.9, this implies that  $t_n = a_2$ , and so  $a_1 \equiv_{\Sigma}^* a_2$ , which proves that  $f_1 = [a_1] = [a_2] = f_2$ .

It remains to show that the image of  $I^{\mathbf{w}}$  is closed by divisors. Let  $f', f'_1, f'_2 \in L^{\mathbf{w}}(\mathcal{C}', \Sigma')$  and  $i \leq n$  such that  $f' = f'_1 \star_i f'_2$ , and assume that there is an  $f \in L^{\mathbf{w}}(\mathcal{C}', \Sigma')$  such that  $I^{\mathbf{w}}(f) = f'$ . Let  $a \in E_{\Sigma}^T$  and  $b'_1, b'_2 \in E_{\Sigma'}^T$  such that:

$$[a] = f \quad [b'_1] = f'_1 \quad [b'_2] = f'_2.$$

In particular, we have  $I^{\mathbf{w}}(a) \equiv_{\Sigma'}^* b'_1 \star_i b'_2$ . Using both Lemmas 4.9 and 4.11 as before, we get an element  $b \in E_{\Sigma}^T$  such that:

$$a \equiv_{\Sigma}^* b \quad I^{\mathbf{w}}(b) = b'_1 \star_i b'_2.$$

Since the image of  $I^{\mathbf{w}}$  is closed by divisors, there exists  $b_1, b_2 \in E_{\Sigma}^T$  such that  $b = b_1 \star_i b_2$ . Let  $f_1 := [b_1]$  and  $f_2 := [b_2]$ : by construction we have:

$$I^{\mathbf{w}}(f_1) = f'_1 \quad I^{\mathbf{w}}(f_2) = f'_2 \quad f_1 \star_i f_2 = f.$$

The case of  $I^{\mathbf{w}(n)}$  is identical, the only difference lying in the hypothesis needed to apply Lemma 4.11.  $\square$

**Lemma 4.13.** *Let  $\Sigma$  and  $\Gamma$  be two  $(n, k)$ -white-polygraphs and  $I : \Sigma \rightarrow \Gamma$  be a morphism of  $(n, k)$ -polygraphs such that for every  $j \leq k$  the application  $I_j : \Sigma_j \rightarrow \Gamma_j$  is injective. Then for every  $j \leq k$  the functor  $I_j^{\mathbf{w}} : \Sigma_j^{\mathbf{w}} \rightarrow \Gamma_j^{\mathbf{w}}$  is injective, and its image is closed by divisors.*

*Assume moreover that  $I_0$  and  $I_1$  are bijections, and that for every  $j > k$  the application  $I_j : \Sigma_j \rightarrow \Gamma_j$  is bijective. Then for every  $j$  the functor  $I_j^{\mathbf{w}(k)} : \Sigma_j^{\mathbf{w}(k)} \rightarrow \Gamma_j^{\mathbf{w}(k)}$  is injective, and its image is closed by divisors.*



*Proof.* We reason by induction on  $j$ . The case  $j = 0$  is true by hypothesis.

Let  $1 \leq j \leq k$ . By hypothesis, the application  $I_j$  is injective, and by induction hypothesis, the functor  $I_{j-1}^{\mathbf{w}}$  is injective with image closed by divisors. Hence  $I_j$  satisfies the hypothesis of Lemma 4.12, and  $I_j^{\mathbf{w}}$  is injective with image closed by divisors.

Let  $j > k$ . Again, using the hypothesis and induction hypothesis, we get that  $I_j$  satisfies the hypotheses of Lemma 4.12. Hence  $I_j^{\mathbf{w}(k)}$  is injective and its image is closed by divisors.  $\square$

In what follows, we use the fact that the image of a functor generated by a morphism of polygraphs is closed by divisors in order to prove a characterisation of the image of such a functor.

**Definition 4.14.** Let  $\mathcal{C}, \mathcal{D}$  be two  $n$ -white-categories,  $F : \mathcal{C} \rightarrow \mathcal{D}$  be an  $n$ -functor and  $f$  be an  $n$ -cell of  $\mathcal{D}$ . We say that  $F$  *k-discriminates*  $f$  if the following are equivalent:

1. The  $k$ -source of  $f$  is in the image of  $F$ .
2. The  $k$ -target of  $f$  is in the image of  $F$ .
3. The  $n$ -cell  $f$  is in the image of  $F$ .

Given a subset  $D$  of  $\mathcal{D}_n$ , we say that  $F$  is *k-discriminating on  $D$*  if for every  $n$ -cell  $f$  in  $D$ ,  $F$  *k-discriminates*  $f$ .

**Lemma 4.15.** Assume that the image of  $I$  is closed by divisors, that  $I$  induces an injection on  $n$ -cells, and that  $I$  is *n-discriminating on  $\Sigma'$* .

Then,  $I^{\mathbf{w}}$  (resp.  $I^{\mathbf{w}(n)}$ ) is *n-discriminating on  $L^{\mathbf{w}}(\mathcal{C}', \Sigma')$*  (resp.  $L^{\mathbf{w}(n)}(\mathcal{C}', \Sigma')$ ).

*Proof.* Let us start with  $I^{\mathbf{w}}$ . Let  $E$  be the set all  $(n+1)$ -cells of  $L^{\mathbf{w}}(\mathcal{C}', \Sigma')$  which  $I^{\mathbf{w}}$  discriminates. Let us show that  $E = L^{\mathbf{w}}(\mathcal{C}', \Sigma')$ . Since  $I^{\mathbf{w}}$  commutes with the source and target applications, the implications (3)  $\Rightarrow$  (1) and (3)  $\Rightarrow$  (2) hold for any cell in  $L^{\mathbf{w}}(\mathcal{C}', \Sigma')$ . So in order to show that a cell is in  $E$ , it remains to show that it verifies the implications (1)  $\Rightarrow$  (3) and (2)  $\Rightarrow$  (3).

The set  $E$  contains all units. Indeed, let  $A' = 1_{f'}$ , with  $f' \in \mathcal{C}'$ . If  $\mathbf{s}(A') = f'$  is in the image of  $I^{\mathbf{w}}$ , there exists  $f \in \mathcal{C}$  such that  $I(f) = f'$ . Let us define  $A = 1_f \in L^{\mathbf{w}}(\mathcal{C}, \Sigma)$ : by construction we have  $I^{\mathbf{w}}(A) = 1_{I(f)} = 1_{f'} = A'$ , hence the implication (1)  $\Rightarrow$  (3) holds for  $A'$ . Moreover since  $\mathbf{t}(A') = \mathbf{s}(A')$ , the implication (2)  $\Rightarrow$  (3) also holds for  $A$ .

The set  $E$  contains all cells of length 1. Indeed, given such a cell  $A'$ , there exist  $f'_k, g'_k \in \mathcal{C}'_k$  and  $A'_0 \in \Sigma'$  such that

$$A' = f'_n \star_{n-1} (f'_{n-1} \star_{n-2} \dots \star_2 (f'_1 A'_0 g'_1) \star_2 \dots \star_{n-2} g'_{n-1}) \star_{n-1} g'_n.$$

Let  $A'_k := f'_k \star_{k-1} (f'_{k-1} \star_{k-2} \dots \star_2 (f'_1 A'_0 g'_1) \star_2 \dots \star_{k-2} g'_{k-1}) \star_{k-1} g'_k$ . Suppose that the source (resp. target) of  $A'$  is in the image of  $I$ , and let us show that  $A'$  is in the image of  $I^{\mathbf{w}}$ . Since the image of  $I$  is closed by divisors, we get first that  $f'_n, g'_n$  and  $\mathbf{s}(A'_{n-1})$  (resp.  $\mathbf{t}(A'_{n-1})$ ) are in the image of  $I$ . By iterating this reasoning, we get that, for all  $i$ ,  $f'_i, g'_i$  and  $\mathbf{s}(A'_{i-1})$  (resp.  $\mathbf{t}(A'_{i-1})$ ) are in the image of  $I$ . Since  $I^{\mathbf{w}}$  discriminates  $\Sigma'$ , there exist  $f_k, g_k \in \mathcal{C}_k$  and  $A_0 \in \Sigma$  such that:

$$I(f_k) = f'_k \quad I(g_k) = g'_k \quad I_{n+1}(A_0) = A'_0.$$

By induction on  $k$  we show that  $A_k := f_k \star_{k-1} A_{k-1} \star_{k-1} g_k$  is well defined and that  $I^{\mathbf{w}}(A_k) = A'_k$ . Indeed, assume that it is true at rank  $k-1$ . Then we have the equalities:

$$I(\mathbf{t}(f_k)) = \mathbf{t}(f'_k) = \mathbf{s}_{k-1}(A'_{k-1}) = I(\mathbf{s}_{k-1}(A_{k-1})) \quad I(\mathbf{t}_{k-1}(A_{k-1})) = \mathbf{t}_{k-1}(A'_{k-1}) = \mathbf{s}(g'_k) = I(\mathbf{s}(g_k))$$

Using the injectivity of  $I$  we get that  $\mathbf{t}(f_k) = \mathbf{s}_{k-1}(A_{k-1})$  and  $\mathbf{t}_{k-1}(A_{k-1}) = \mathbf{s}(g_k)$ , which shows that  $A_k$  is well defined, and finally:

$$I^{\mathbf{w}}(A_k) = f'_k \star_{k-1} A'_{k-1} \star_{k-1} g'_k = A'_k.$$

In particular, we have  $A'_n = I^{\mathbf{w}}(A_n)$ .

The set  $E$  is stable by  $n$ -composition. Indeed let  $A', B' \in E$ , and assume that the source of  $A' \star_n B'$  is in the image of  $I$ . Let us show that  $A' \star_n B'$  is in the image of  $I^{\mathbf{w}}$ . The source of  $A' \star_n B'$  is none other than the one of  $A'$ . Since  $A'$  is in  $E$ , there exists  $A \in L^{\mathbf{w}}(\mathcal{C}, \Sigma)$  such that  $I^{\mathbf{w}}(A) = A'$ . Hence the

source of  $B'$  is in the image of  $I$ , and since  $B' \in E$ , there exists  $B \in \mathcal{L}^{\mathbf{w}}(\mathcal{C}, \Sigma)$  such that  $I^{\mathbf{w}}(B) = B'$ . Moreover we have  $I(\mathbf{t}(A)) = \mathbf{t}(A') = \mathbf{s}(B') = I(\mathbf{s}(B))$ , so using the injectivity of  $I$  we get  $\mathbf{t}(A) = \mathbf{s}(B)$ . Hence the cell  $A \star_n B$  is well defined and satisfies:

$$I^{\mathbf{w}}(A \star_n B) = I^{\mathbf{w}}(A) \star_n I^{\mathbf{w}}(B) = A' \star_n B'.$$

The case where the target of  $A' \star_n B'$  is in the image of  $I$  is symmetrical.

This concludes the proof for  $I^{\mathbf{w}}$ . Concerning  $I^{\mathbf{w}(n)}$ , the reasoning is the same except that we also have to show that  $E$  is stable under inversion. Indeed let  $A' \in E$  and assume that the source (resp. target) of  $(A')^{-1}$  is in the image of  $I$ . Then the target (resp. source) of  $A'$  is in the image of  $I$  and since  $A' \in E$ , there exists  $A \in \mathcal{L}^{\mathbf{w}(n)}(\mathcal{C}, \Sigma)$  such that  $I^{\mathbf{w}(n)}(A) = A'$ , and so  $I^{\mathbf{w}(n)}(A^{-1}) = (A')^{-1}$ .  $\square$

**Lemma 4.16.** *Let  $\Sigma$  and  $\Gamma$  be two  $(n, k)$ -white-polygraphs, and  $I : \Sigma \rightarrow \Gamma$  be a morphism of polygraphs. Let  $k_0$  such that for every  $j > k_0$ ,  $I_j$  is a bijection.*

*Assume that  $I$  satisfies the hypothesis of Lemma 4.13, and that, for every  $j > k_0$ ,  $I_j$  is  $k_0$ -discriminating on  $\Gamma_j$ . Then for every  $j \geq k_0$ ,  $I_j^{\mathbf{w}(k)}$  is  $k_0$ -discriminating on  $\Gamma_j^{\mathbf{w}(k)}$ .*

*Proof.* Since  $I$  satisfies the hypotheses of Lemma 4.13, we know that for every  $j$ , the functor  $I_j^{\mathbf{w}(k)}$  is injective, and that its image is closed by divisors.

We reason by induction on  $j > k_0$ . For  $j = k_0 + 1$ , the result is a direct application of Lemma 4.15.

Let  $j > k_0 + 1$ : let us show that  $I_j^{\mathbf{w}(k)}$  is  $(j - 1)$ -discriminating on  $\Gamma_j$ . Let  $A \in \Gamma_j$ . If  $\mathbf{s}(A)$  (resp.  $\mathbf{t}(A)$ ) is in the image of  $I_{j-1}^{\mathbf{w}(k)}$  then in particular, the  $k_0$ -source (resp.  $k_0$ -target) of  $A$  is in the image of  $I_{k_0}^{\mathbf{w}(k)}$ . Since  $I_j^{\mathbf{w}(k)}$  is  $k_0$ -discriminating on  $\Gamma_j$ ,  $A$  is in the image of  $I_j^{\mathbf{w}(k)}$ . Hence we can use Lemma 4.15, and we get that  $I_j^{\mathbf{w}(k)}$  is  $(j - 1)$ -discriminating on  $\Gamma_j^{\mathbf{w}(k)}$ . Let  $A \in \Gamma_j^{\mathbf{w}(k)}$ . If its  $k_0$ -source (resp.  $k_0$ -target) is in the image of  $I_{k_0}^{\mathbf{w}(k)}$  then, by induction hypothesis, the source (resp. target) of  $A$  is in the image of  $I_{j-1}^{\mathbf{w}(k)}$ , and so  $A$  is in the image of  $I_j^{\mathbf{w}(k)}$ , which proves that  $I_j^{\mathbf{w}(k)}$  is  $k_0$ -discriminating.  $\square$

### 4.3 Partial coherence in pointed $(4, 3)$ -white-categories

**Definition 4.17.** A *pointed*  $(4, 3)$ -white-category is a couple  $(\mathcal{C}, S)$ , where  $\mathcal{C}$  is a 4-white-category, and  $S$  is a subset of  $\mathcal{C}_2$ .

**Definition 4.18.** Let  $(\mathcal{C}, S)$  be a pointed  $(4, 3)$ -white-category. The *restriction of  $\mathcal{C}$  to  $S$* , noted  $\mathcal{C} \upharpoonright S$ , is the following  $(2, 1)$ -category:

- its 0-cells are the 2-cells of  $\mathcal{C}_2$  that lie in  $S$ ,
- its 1-cells are the 3-cells of  $\mathcal{C}_3$  with source and target in  $S$ ,
- its 2-cells are the 4-cells of  $\mathcal{C}_4$  with 2-source and 2-target in  $S$ ,
- its compositions  $\star_0$  and  $\star_1$  are respectively induced by the compositions  $\star_2$  and  $\star_3$  of  $\mathcal{C}$ .

**Definition 4.19.** Let  $(\mathcal{C}, S)$  be a pointed  $(4, 3)$ -white-category. We say that  $\mathcal{C}$  is  *$S$ -coherent* if the  $(2, 1)$ -category  $\mathcal{C} \upharpoonright S$  is 1-coherent.

**Example 4.20.** Every  $(4, 3)$ -white-category is  $\emptyset$ -coherent. A  $(4, 3)$ -white-category  $\mathcal{C}$  is  $\mathcal{C}_2$ -coherent if and only if it is 3-coherent.

**Definition 4.21.** Let  $\mathcal{C}$  and  $\mathcal{D}$  be two 2-categories,  $F : \mathcal{C} \rightarrow \mathcal{D}$  a 2-functor.

We say that  $F$  is *0-surjective* if the application  $F : \mathcal{C}_0 \rightarrow \mathcal{D}_0$  is surjective.

Let  $0 < k < 2$ . We say that  $F$  is  *$k$ -surjective* if, for every  $(k - 1)$ -parallel cells  $s, t \in \mathcal{C}_{k-1}$ , the application  $F : \mathcal{C}_k(s, t) \rightarrow \mathcal{D}_k(F(s), F(t))$  is surjective.

**Definition 4.22.** Let  $(\mathcal{C}, S)$  and  $(\mathcal{C}', S')$  be two pointed  $(4, 3)$ -categories. We say that  $(\mathcal{C}', S')$  is *stronger* than  $(\mathcal{C}, S)$  if there is a functor  $F : \overline{\mathcal{C}' \upharpoonright S'} \rightarrow \overline{\mathcal{C} \upharpoonright S}$  which is 0-surjective and 1-surjective.

**Lemma 4.23.** *Let  $(\mathcal{C}, S)$ ,  $(\mathcal{C}', S')$  be two pointed  $(4, 3)$ -white-categories. If there exists a 2-functor  $F : \mathcal{C}' \upharpoonright S' \rightarrow \mathcal{C} \upharpoonright S$  which is 0-surjective and 1-surjective, then  $(\mathcal{C}', S')$  is stronger than  $(\mathcal{C}, S)$ .*

*Proof.* The functor  $F$  induces a functor  $\bar{F} : \overline{\mathcal{C}' \upharpoonright S'} \rightarrow \overline{\mathcal{C} \upharpoonright S}$ . Since it is equal to  $F$  on objects, it is 0-surjective. On 1-cells  $\bar{F}$  is the composition of  $F$  with the canonical projection associated to the quotient, hence it is 1-surjective, and so  $(\mathcal{C}', S')$  is stronger than  $(\mathcal{C}, S)$ .  $\square$

**Lemma 4.24.** *Let  $(\mathcal{C}, S)$ ,  $(\mathcal{C}', S')$  be two pointed  $(4, 3)$ -white-categories, and assume  $(\mathcal{C}', S')$  is stronger than  $(\mathcal{C}, S)$ .*

*If  $\mathcal{C}'$  is  $S'$ -coherent, then  $\mathcal{C}$  is  $S$ -coherent.*

*Proof.* Let  $F : \overline{\mathcal{C}' \upharpoonright S'} \rightarrow \overline{\mathcal{C} \upharpoonright S}$  be a functor that is 0- and 1-surjective. Let  $A, B : f \rightarrow g \in (\mathcal{C} \upharpoonright S)_1$  be parallel 1-cells, and  $\bar{A}, \bar{B}$  be their projections in  $\overline{\mathcal{C} \upharpoonright S}$ .

Since  $F$  is 0-surjective, there exists  $f', g' \in (\mathcal{C}' \upharpoonright S')_0$  in the preimage of  $f$  and  $g$  under  $F$ . Since  $F$  is 1-surjective, there exists  $A', B' \in (\mathcal{C}' \upharpoonright S')_1$  of source  $f'$  and of target  $g'$  such that  $F(\bar{A}') = \bar{A}$  and  $F(\bar{B}') = \bar{B}$ .

Since  $\mathcal{C}' \upharpoonright S'$  is 2-coherent, there exists  $\alpha' : A' \Rightarrow B' \in (\mathcal{C}' \upharpoonright S')_2$ . Thus  $\bar{A}' = \bar{B}'$  and  $\bar{A} = \bar{B}$ . Hence there exists  $\alpha : A \rightarrow B \in \mathcal{C} \upharpoonright S$ . This shows that  $\mathcal{C} \upharpoonright S$  is 1-coherent, and therefore that  $\mathcal{C}$  is  $S$ -coherent.  $\square$

We are going to define four families of Tietze-transformations on  $(4, 3)$ -white-polygraphs. Tietze transformations for  $(3, 1)$ -categories were introduced in [5], as a way to modify a  $(3, 1)$ -polygraph without modifying the 2-categories they present. In particular, they preserve the 2-coherence. Here we adapt these transformations to our setting of  $(4, 3)$ -white-polygraphs and show that they preserve the partial coherence. This will be used in Section 5.5. We fix a 4-white-polygraph  $\mathcal{A}$ .

**Definition 4.25.** Let  $A \in \mathcal{A}_3^{\mathbf{w}(3)}$ . We define a 4-polygraph  $\mathcal{A}(A)$  by adding to  $\mathcal{A}$  a 3-cell  $B$  and a 4-cell  $\alpha$ , whose sources and targets are given by:

- $\mathbf{s}(B) = \mathbf{s}(A)$ ,
- $\mathbf{t}(B) = \mathbf{t}(A)$ ,
- $\mathbf{s}(\alpha) = A$ ,
- $\mathbf{t}(\alpha) = B$ .

The inclusion induces a functor between  $(4, 3)$ -white-categories  $\iota_A : \mathcal{A}^{\mathbf{w}(3)} \rightarrow (\mathcal{A}(A))^{\mathbf{w}(3)}$ . We call this operation the *adjunction of a 3-cell with its defining 4-cell*.

**Definition 4.26.** Let  $\alpha \in \mathcal{A}_4$  and  $A \in \mathcal{A}_3$  such that:

- $\mathbf{t}(\alpha) = A$
- $\mathbf{s}(\alpha) \in (\mathcal{A} \setminus \{\mathbf{t}(\alpha)\})_3^{\mathbf{w}(3)}$ .

The 4-cell  $\alpha$  induces an application  $\mathcal{A}_3 \rightarrow (\mathcal{A}_3 \setminus \{\mathbf{t}(\alpha)\})^{\mathbf{w}(3)}$ , by sending  $\mathbf{t}(\alpha)$  on  $\mathbf{s}(\alpha)$  and and that is the identity on the rest of  $\mathcal{A}_3$ . This application extends into a 3-functor  $\pi_\alpha : \mathcal{A}_3^{\mathbf{w}} \rightarrow (\mathcal{A}_3 \setminus \{\mathbf{t}(\alpha)\})^{\mathbf{w}}$ .

Let  $\mathcal{A}/(A; \alpha)$  be the following  $(4, 3)$ -polygraph:

$$\mathcal{A}_0 \begin{array}{c} \xleftarrow{\mathbf{s}} \\ \xrightarrow{\mathbf{t}} \end{array} \mathcal{A}_1^{\mathbf{w}(3)} \begin{array}{c} \xleftarrow{\mathbf{s}} \\ \xrightarrow{\mathbf{t}} \end{array} \mathcal{A}_2^{\mathbf{w}(3)} \begin{array}{c} \xleftarrow{\mathbf{s}} \\ \xrightarrow{\mathbf{t}} \end{array} (\mathcal{A}_3 \setminus \{\mathbf{t}(\alpha)\})^{\mathbf{w}(3)} \begin{array}{c} \xleftarrow{\pi_\alpha \circ \mathbf{s}} \\ \xrightarrow{\pi_\alpha \circ \mathbf{t}} \end{array} \mathcal{A}_4 \setminus \{\alpha\}$$

Then  $\pi_\alpha$  induces a functor  $\mathcal{A}^{\mathbf{w}(3)} \rightarrow (\mathcal{A}/(A; \alpha))^{\mathbf{w}(3)}$ , which sends  $\alpha$  on the identity of  $\mathbf{s}(\alpha)$ , and which is the identity on the rest of  $\mathcal{A}_4$ . We call this operation the *suppression of a 3-cell with its defining 4-cell*.

**Definition 4.27.** Let  $\alpha$  be a 4-cell in  $\mathcal{A}_4^{\mathbf{w}(3)}$ . We define a  $(4, 3)$ -white-polygraph  $\mathcal{A}(\alpha)$  by adding to  $\mathcal{A}$  a 4-cell  $\beta : \mathbf{s}(\alpha) \rightarrow \mathbf{t}(\alpha)$ . The inclusion of  $\mathcal{A}$  into  $\mathcal{A}(\alpha)$  induces a functor  $\iota_\alpha : \mathcal{A}^{\mathbf{w}(3)} \rightarrow \mathcal{A}(\alpha)^{\mathbf{w}(3)}$ . We call this operation the *adjunction of a superfluous 4-cell*.

**Definition 4.28.** Let  $\beta \in \mathcal{A}_4$  such that there exists a 4-cell  $\alpha \in (\mathcal{A} \setminus \{\beta\})^{\mathbf{w}(3)}$  parallel to  $\beta$ . Let  $\mathcal{A}/\beta$  be the polygraph obtained by removing  $\beta$  from  $\mathcal{A}$ . There exists a functor  $\pi_\beta : \mathcal{A}^{\mathbf{w}(3)} \rightarrow (\mathcal{A}/\beta)^{\mathbf{w}(3)}$ , that sends  $\beta$  on  $\alpha$  and which is the identity on the rest of  $\mathcal{A}$ . We call this operation the *suppression of a superfluous 4-cell*.

In those four cases, the set of 2-cells is left untouched. In particular, if  $S$  is a sub-set of  $\mathcal{A}_2^{\mathfrak{w}}$ , and that  $\mathcal{B}$  is constructed from  $\mathcal{A}$  through a series of Tietze-transformations, then  $S$  still is a subset of  $\mathcal{B}_2^{\mathfrak{w}}$ .

**Proposition 4.29.** *Let  $\mathcal{A}$  be a 4-white-polygraph,  $S$  a sub-set of  $\mathcal{A}_2^{\mathfrak{w}}$ , and  $\mathcal{B}$  a 4-white-polygraph constructed from  $\mathcal{A}$  through a series of Tietze-transformation.*

*If  $\mathcal{B}^{\mathfrak{w}(3)}$  is  $S$ -coherent, then  $\mathcal{A}^{\mathfrak{w}(3)}$  is  $S$ -coherent.*

*Proof.* We check that if  $\mathcal{B}$  is constructed from  $\mathcal{A}$  through a Tietze-transformation, then the 3-white-categories presented by  $\mathcal{A}$  and  $\mathcal{B}$  are isomorphic.

Suppose now that  $\mathcal{B}$  is  $S$ -coherent, and let  $A, B \in \mathcal{A}_3^{\mathfrak{w}}$  be parallel 3-cells, whose source and target are in  $S$ . Since  $\mathcal{B}^{\mathfrak{w}(3)}$  is  $S$ -coherent, the images of  $A$  and  $B$  in the 3-white-category presented by  $\mathcal{B}$  are equal. Since it is isomorph to the 3-white-category presented by  $\mathcal{A}$ , there exists a 4-cell  $\alpha : A \rightarrow B \in \mathcal{A}_4^{\mathfrak{w}(3)}$ , which proves that  $\mathcal{A}$  is  $S$ -coherent.  $\square$

## 5 Transformation of a $(4, 2)$ -polygraph into a $(4, 3)$ -white-polygraph

The proof of Theorem 1.27 will occupy the rest of this article. We start with a  $(4, 2)$ -polygraph  $\mathcal{A}$  satisfying the hypotheses of Theorem 1.27. Let  $S_{\mathcal{A}}$  be the set of all 2-cells in  $\mathcal{A}_2^*$  whose target is a normal form. Then proving Theorem 1.27 consists in showing that  $\mathcal{A}$  is  $S_{\mathcal{A}}$ -coherent.

In this section we successively transform  $\mathcal{A}$  four times, leading to five pointed  $(4, 3)$ -white-categories, namely  $(\mathcal{A}^{*(2)}, S_{\mathcal{A}})$ ,  $(\mathcal{B}^{\mathbf{w}(2)}, S_{\mathcal{B}})$ ,  $(\mathcal{C}^{\mathbf{w}(3)}, S_{\mathcal{C}})$ ,  $(\mathcal{D}^{\mathbf{w}(3)}, S_{\mathcal{D}})$  and  $(\mathcal{E}^{\mathbf{w}(3)}, S_{\mathcal{E}})$ , and we show each time that the new pointed  $(4, 3)$ -white-category is stronger than the previous one. A brief description of each pointed  $(4, 3)$ -white-category can be seen in Table 5. Finally in Section 5.5, we perform a number of Tietze-transformations on the 4-white-polygraph  $\mathcal{E}$ , leading to a 4-white-polygraph  $\mathcal{F}$ .

Thanks to Lemma 4.24 and Proposition 4.29, we know that in order to show that  $\mathcal{A}^{*(2)}$  is  $S_{\mathcal{A}}$ -coherent, it is enough to show that  $\mathcal{F}^{\mathbf{w}(3)}$  is  $S_{\mathcal{E}}$ -coherent. This will be done in Section 6.

Name	Description	Commentary
$(\mathcal{A}^{*(2)}, S_{\mathcal{A}})$	$\mathcal{A}_2$ $\mathcal{A}_3$ $\mathcal{A}_4$	
$(\mathcal{B}^{\mathbf{w}(2)}, S_{\mathcal{B}})$	$\mathcal{A}_2$ $\mathcal{A}_3 \cup K$ $\mathcal{A}_4 \cup \Omega$	Weakening of the exchange law
$(\mathcal{C}^{\mathbf{w}(3)}, S_{\mathcal{C}})$	$\mathcal{A}_2$ $\mathcal{A}_3 \cup \mathcal{A}_3^{op} \cup K \cup K^{op}$ $\mathcal{A}_4 \cup \Omega \cup \{\rho_A, \lambda_A\}$	Weakening of the invertibility of 3-cells
$(\mathcal{D}^{\mathbf{w}(3)}, S_{\mathcal{D}})$	$\mathcal{A}_2 \cup \mathcal{A}_2^{op}$ $\mathcal{A}_3 \cup \mathcal{A}_3^{op} \cup K \cup K^{op}$ $\mathcal{A}_4 \cup \Omega \cup \{\rho_A, \lambda_A\}$	Adjunction of formal inverses to 2-cells
$(\mathcal{E}^{\mathbf{w}(3)}, S_{\mathcal{E}})$	$\mathcal{A}_2 \cup \mathcal{A}_2^{op}$ $\mathcal{A}_3 \cup \mathcal{A}_3^{op} \cup K \cup K^{op} \cup \{\eta_f, \epsilon_f\}$ $\mathcal{A}_4 \cup \Omega \cup \{\rho_A, \lambda_A\} \cup \{\tau_f, \sigma_f\}$	Adjunction of connections between 2-cells

Table 5: List of the successive transformations of  $\mathcal{A}$ .

**Example 5.1.** We have already shown in Section 2 that for every sets  $\mathbf{C}, \mathbf{D}$  and for every applications  $\mathbf{f}, \mathbf{g} : \mathbf{C} \rightarrow \mathbf{D}$ , the  $(4, 3)$ -polygraph  $\mathbf{PNTrans}^{++}[\mathbf{f}, \mathbf{g}]$  satisfies the hypothesis of Theorem 1.27.

In what follows, we will use as a running example the polygraph  $\mathcal{A} = \mathbf{Assoc}$  which consists of one 0-cell, one 1-cell  $|$ , one 2-cell  $\nabla : | \Rightarrow |$ , one 3-cell  $\nabla : \nabla \Rightarrow \nabla$ , and one 4-cell  $\nabla$ :

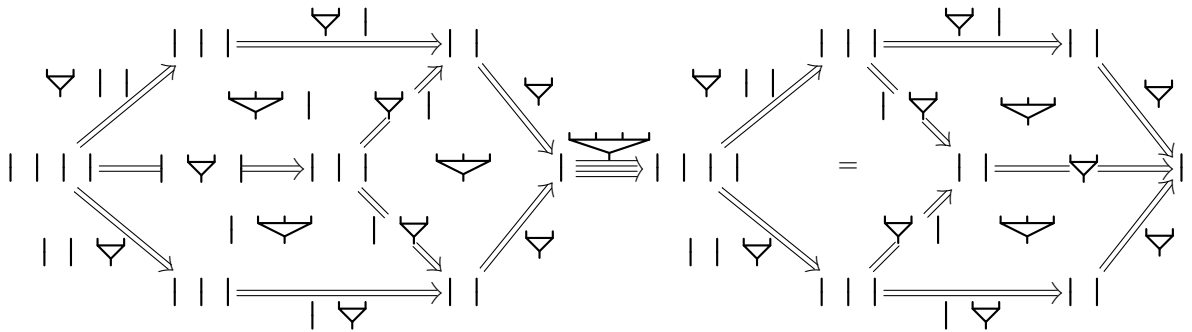

In particular,  $\mathbf{Assoc}$  satisfies the 2-Squier condition of rank 2. The 2-category  $\mathbf{Assoc}_2^*$  is 2-convergent and its only normal form is the 1-cell  $|$ .

The corresponding set  $S_{\mathcal{A}}$  is then the set of 2-cells in  $\mathbf{Assoc}_2^*$  from any 1-cell  $|\dots|$  to  $|$ .

### 5.1 Weakening of the exchange law

We construct dimension by dimension a  $(4, 2)$ -white-polygraph  $\mathcal{B}$ , together with a white-functor  $F : \mathcal{B}^{\mathbf{w}(2)} \rightarrow \mathcal{A}^{*(2)}$ . We then define a subset  $S_{\mathcal{B}}$  of  $\mathcal{B}^{\mathbf{w}(2)}$  and show (Proposition 5.5) using  $F$  that  $(\mathcal{B}^{\mathbf{w}(2)}, S_{\mathcal{B}})$

is stronger than  $(\mathcal{A}^{*(2)}, S_{\mathcal{A}})$ .

In low dimensions, we set  $\mathcal{B}_i = \mathcal{A}_i$ , for every  $i \leq 2$ , and the functor  $F$  is the identity on generators.

**Lemma 5.2.** *The functor  $F : \mathcal{B}^{\mathbf{w}} \rightarrow \mathcal{A}^*$  is 2-surjective.*

*Proof.* By construction,  $\mathcal{A}_2^*$  is the quotient of  $\mathcal{B}_2^{\mathbf{w}}$  by the equivalence relation generated by:

$$(f \star_0 v) \star_i (u' \star_0 g) = (u \star_0 g) \star_i (f \star_0 v').$$

And  $F$  is the canonical projection induced by the quotient.  $\square$

In what follows, we suppose chosen a section  $i : \mathcal{A}^* \rightarrow \mathcal{B}^{\mathbf{w}}$  of  $F$ , which is possible thanks to Lemma 5.2.

We extend  $\mathcal{B}$  into a 3-white-polygraph and  $F : \mathcal{B}^{\mathbf{w}} \rightarrow \mathcal{A}^*$  into a 3-white-functor by setting  $\mathcal{B}_3 := \mathcal{A}_3 \cup K$ :

- For every 3-cell  $A \in \mathcal{A}_3$ , the source and target of  $A$  in  $\mathcal{B}_2^{\mathbf{w}}$  are respectively  $\mathbf{s}^{\mathcal{B}}(A) := i(\mathbf{s}^{\mathcal{A}}(A))$  et  $\mathbf{t}^{\mathcal{B}}(A) := i(\mathbf{t}^{\mathcal{A}}(A))$ .
- The set  $K$  contains, for every strict Peiffer branching  $(fv, ug)$ , where  $f : u \Rightarrow u'$  and  $g : v \Rightarrow v'$  are rewriting steps, a 3-cell  $A_{fv,ug}$  of the shape:

The image of a cell of  $\mathcal{B}_3$  under  $F$  is defined as follows:

- For every strict Peiffer branching  $(fv, ug)$ ,  $F(A_{fv,ug}) := 1_{f \star_0 g}$
- For every 3-cell  $A$  in  $\mathcal{A}_3$ ,  $F(A) := A$ .

**Lemma 5.3.** *Let  $f, g \in \mathcal{B}_2^{\mathbf{w}}$ . There exists a 3-cell  $A : f \Rightarrow g$  in  $K_3^{\mathbf{w}(2)}$  if and only if the equality  $F(f) = F(g)$  hold in  $\mathcal{A}_2^*$ .*

*Proof.* Let  $f, g \in \mathcal{B}_2^{\mathbf{w}}$ . The image of any cell in  $K_3^{\mathbf{w}(2)}$  by  $F$  is an identity. So if there exists a 3-cell  $A : f \Rightarrow g$  in  $K_3^{\mathbf{w}(2)}$ , necessarily  $F(f) = F(g)$ .

Conversely, the set  $\mathcal{A}_2^*$  is the quotient of  $\mathcal{B}_2^{\mathbf{w}}$  by the equivalence relation generated by:

$$f \mathbf{s}(g) \star_1 \mathbf{t}(f)g = \mathbf{s}(f)g \star_1 f \mathbf{t}(g),$$

for  $f, g \in \mathcal{B}_2^{\mathbf{w}}$ . The 3-cells  $A_{fu,vg}$ , where  $(fu, vg)$  is a strict Peiffer branching, generate this relation, and they are in  $K$ . Hence the result.  $\square$

**Lemma 5.4.** *The functor  $F : \mathcal{B}^{\mathbf{w}(2)} \rightarrow \mathcal{A}^{\mathbf{w}(2)}$  is 3-surjective.*

*Proof.* Let  $E$  be the set of 3-cells  $A \in \mathcal{A}_3^{*(2)}$  such that, for every  $f, g \in \mathcal{B}_2^{\mathbf{w}}$  in the preimage of  $\mathbf{s}(A)$  and  $\mathbf{t}(A)$  under  $F$ , there exists a 3-cell  $B : f \Rightarrow g \in \mathcal{B}_3^{\mathbf{w}(2)}$  satisfying  $F(B) = A$ . Let us show that  $E = \mathcal{A}_3^*$ . We already know that  $E$  contains the identities thanks to Lemma 5.3.

The 3-cells of length 1 in  $\mathcal{A}_3^*$  are in  $E$ . Indeed, let  $A \in \mathcal{A}_3^*$  be a 3-cell of length 1, and  $f, g \in \mathcal{B}_2^{\mathbf{w}}$  such that  $F(f) = \mathbf{s}(A)$  et  $F(g) = \mathbf{t}(A)$ . There exist  $u, v \in \mathcal{A}_1^*$ ,  $f', g' \in \mathcal{A}_2^*$ , and  $A' \in \mathcal{A}_3$  such that

$$A = f' \star_1 (uA'v) \star_1 g'.$$

Let  $\tilde{u}, \tilde{v}, \tilde{f}, \tilde{g}$  be in the preimages respectively of  $u, v, f', g'$  under  $F$  (they exist thanks to Lemma 5.2), and let  $B_1 := \tilde{f} \star_1 (\tilde{u}A'\tilde{v}) \star_1 \tilde{g} \in \mathcal{B}_3^{\mathbf{w}(2)}$ . By construction,  $F(B_1) = A$ , which leads to the equalities:

$$F(\mathbf{s}(B_1)) = F(f) \quad F(\mathbf{t}(B_1)) = F(g).$$

Thus, according to Lemma 5.3, there exist 3-cells  $C_1 : f \Rightarrow \mathbf{s}(B_1) \in K_3^{\mathbf{w}(2)}$  and  $C_2 : \mathbf{t}(B_1) \Rightarrow g \in K_3^{\mathbf{w}(2)}$ . Let  $B := C_1 \star_2 B_1 \star_2 C_2$ : by construction,  $B$  has the required source and target, and moreover:

$$F(B) = F(C_1) \star_2 F(B_1) \star_2 F(C_2) = 1_{F(f)} \star_2 A \star_2 1_{F(g)} = A.$$

The set  $E$  is stable under composition. Indeed let  $A_1, A_2 \in E$  such that  $\mathbf{t}(A_1) = \mathbf{s}(A_2)$ , and  $f, g \in \mathcal{B}_2^{\mathbf{w}}$  satisfying  $F(f) = \mathbf{s}(A_1)$  and  $F(g) = \mathbf{t}(A_2)$ . Since  $F$  is 2-surjective, there exists  $h \in \mathcal{B}_2^{\mathbf{w}}$  in the inverse image of  $\mathbf{t}(A_1)$  under  $F$ . Since  $A_1$  (resp.  $A_2$ ) is in  $E$ , there exists a cell  $B_1$  (resp.  $B_2$ ) in  $\mathcal{B}_3^{\mathbf{w}(2)}$  such that  $F(B_1) = A_1$  (resp.  $F(B_2) = A_2$ ),  $\mathbf{s}(B_1) = f$  (resp.  $\mathbf{s}(B_2) = h$ ) and  $\mathbf{t}(B_1) = h$  (resp.  $\mathbf{t}(B_2) = g$ ). Let  $B := B_1 \star_2 B_2$ : we get:

$$\mathbf{s}(B) = f \quad F(B) = A_1 \star_2 A_2 \quad \mathbf{t}(B) = g$$

The set  $E$  is stable under 2-composition. Indeed let  $A \in E$  and  $f, g \in \mathcal{B}_2^{\mathbf{w}}$  such that  $F(f) = \mathbf{s}(A^{-1})$  and  $F(g) = \mathbf{t}(A^{-1})$ . There exists  $B \in \mathcal{B}^{\mathbf{w}(2)}$  such that:

$$\mathbf{s}(B) = g \quad F(B) = A \quad \mathbf{t}(B) = f.$$

Hence the cell  $B^{-1}$  satisfies the required property.  $\square$

We now extend  $\mathcal{B}$  into a  $(4, 2)$ -white-polygraph and  $F : \mathcal{B}^{\mathbf{w}(2)} \rightarrow \mathcal{A}^{*(2)}$  into a 4-white-functor by setting  $\mathcal{B}_4 = \mathcal{A}_4 \cup L$ :

- For every 3-cell  $A \in \mathcal{A}_4$ , the source and target of  $A$  in  $\mathcal{B}_3^{\mathbf{w}(2)}$  are respectively  $\mathbf{s}^{\mathcal{B}}(A) := i(\mathbf{s}^{\mathcal{A}}(A))$  and  $\mathbf{t}^{\mathcal{B}}(A) := i(\mathbf{t}^{\mathcal{A}}(A))$ , where  $i$  is a chosen section of the application  $F_3 : \mathcal{B}_3^{\mathbf{w}(2)} \rightarrow \mathcal{A}_3^{\mathbf{w}(2)}$  (which exists since  $F$  is 3-surjective). And we set  $F(A) := A$ .
- For every 3-fold strict Peiffer branching  $(f, g, h)$ , the set  $L$  contains a 4-cell  $A_{f,g,h}$ , whose shape depends on the form of the branching  $(f, g, h)$ . If  $(f, g, h) = (f'v, g'v, uh')$ , with  $(f', g')$  a critical pair, and  $h' : v \Rightarrow v'$  then  $A_{f,g,h}$  is of the following shape:

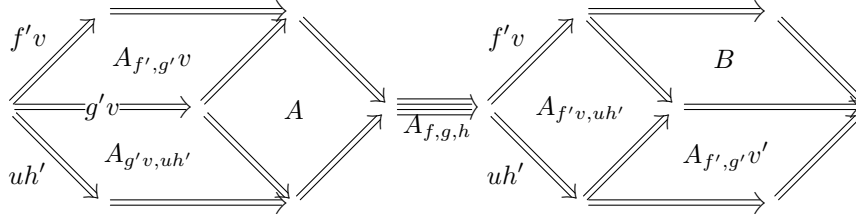

where  $A$  and  $B$  are in  $K_3^{\mathbf{w}(2)}$ . And we define  $F(A_{f,g,h}) := 1_{A_{f',g'v} \star_0 h'}$ .

If  $(f, g, h) = (f'v, ug', uh')$ , with  $(g, h)$  a critical pair, and  $f' : u \Rightarrow u'$  then  $A_{f,g,h}$  is of the following shape:

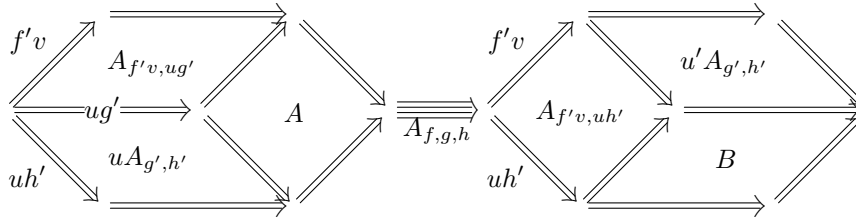

where  $A$  and  $B$  are in  $K_3^{\mathbf{w}(2)}$ . And we define  $F(A_{f,g,h}) := 1_{f' \star_0 A_{g',h'}}$ .

If  $(f, g, h) = (f'vw, ug'w, uh'w)$ , then  $A_{f,g,h}$  is of the following shape, where  $A$  and  $B$  are in  $K_3^{\mathbf{w}(2)}$ :

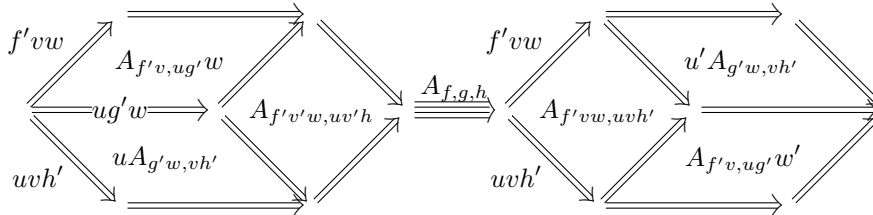

And we define  $F(A_{f,g,h}) := 1_{f' \star_0 g' \star_0 h'}$ .

Let now  $S_{\mathcal{B}}$  be the set of all 2-cells in  $\mathcal{B}^{\mathbf{w}}$  whose 1-target is a normal form.

**Proposition 5.5.** *The pointed (4,3)-white-category  $(\mathcal{B}^{\mathbf{w}(2)}, S_{\mathcal{B}})$  is stronger than  $(\mathcal{A}^{*(2)}, S_{\mathcal{A}})$ .*

*Proof.* The functor  $F$  sends normal forms on normal forms. Hence by restriction it induces a 2-functor  $F|_{S_{\mathcal{B}}} : \mathcal{B}^{\mathbf{w}(2)}|_{S_{\mathcal{B}}} \rightarrow \mathcal{A}^{*(2)}|_{S_{\mathcal{A}}}$ .

Lemmas 5.2 and 5.4 show that it is  $k$ -surjective for every  $k < 2$ . Hence we can conclude using Lemma 4.24.  $\square$

**Example 5.6.** In the case where  $\mathcal{A} = \mathbf{Assoc}$ , the set  $K$  contains in particular the following 3-cells, associated respectively to the strict Peiffer branchings  $(\nabla \mid \mid, \mid \mid \nabla)$  and  $(\nabla \mid \mid \mid, \mid \mid \mid \nabla)$ :



In  $L$ , the 4-cell associated to the strict Peiffer branching  $(\nabla \mid \mid \mid, \mid \nabla \mid \mid, \mid \mid \mid \nabla)$  is the following:

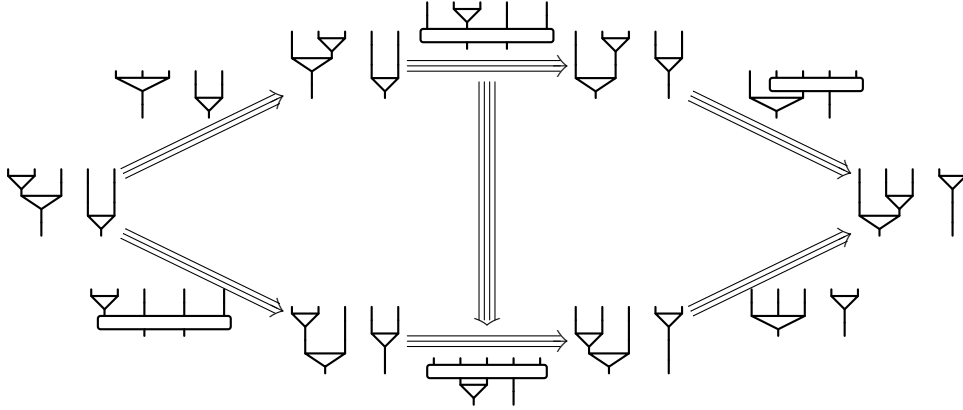

## 5.2 Weakening of the invertibility of 3-cells

We construct dimension by dimension a 4-white-polygraph  $\mathcal{C}$ , together with a 3-white-functor  $G : \mathcal{C}^{\mathbf{w}(3)} \rightarrow \mathcal{B}^{\mathbf{w}(2)}$ . We then define a subset  $S_{\mathcal{C}}$  of  $\mathcal{C}^{\mathbf{w}(3)}$  and show (Proposition 5.8) using  $G$  that  $(\mathcal{C}^{\mathbf{w}(3)}, S_{\mathcal{C}})$  is stronger than  $(\mathcal{B}^{\mathbf{w}(2)}, S_{\mathcal{B}})$ .

In low dimensions, we set  $\mathcal{C}_i = \mathcal{B}_i$  for  $i \leq 2$ , with the functor  $G$  being the identity.

We extend  $\mathcal{C}$  into a 3-white-polygraph by setting  $\mathcal{C}_3 := \mathcal{B}_3 \cup \mathcal{B}_3^{op}$ , where the set  $\mathcal{B}_3^{op}$  contains, for every  $A \in \mathcal{B}_3$ , a cell noted  $A^{op}$ , which source and target are given by the equalities:

$$\mathbf{s}(A^{op}) = \mathbf{t}(A) \quad \mathbf{t}(A^{op}) = \mathbf{s}(A)$$

And the functor  $G : \mathcal{C}^{\mathbf{w}} \rightarrow \mathcal{B}^{\mathbf{w}(2)}$  is defined as follows for every  $A \in \mathcal{B}_3$ :

$$G(A) = A \quad G(A^{op}) = A^{-1}.$$

**Lemma 5.7.** *The functor  $G : \mathcal{C}^{\mathbf{w}(3)} \rightarrow \mathcal{B}^{\mathbf{w}(2)}$  is 3-surjective.*

*Proof.* By definition,  $\mathcal{B}_3^{\mathbf{w}(2)}$  is the quotient of  $\mathcal{C}_3^{\mathbf{w}}$  by the relations  $A^{op} \star_2 A = 1$  and  $A \star_2 A^{op} = 1$ , and  $G$  is the corresponding canonical projection.  $\square$

We extend  $\mathcal{C}$  into a 4-white polygraph by setting  $\mathcal{C}_4 := \mathcal{B}_4 \cup \{\rho_A, \lambda_A | A \in \mathcal{B}_3\}$ , where the applications source and targets  $\mathbf{s}, \mathbf{t} : \mathcal{C}_4 \rightarrow \mathcal{C}_3^{\mathbf{w}}$  are defined as follows:

- For  $A \in \mathcal{B}_4$ , the cell  $\mathbf{s}^{\mathcal{C}}(A)$  (resp.  $\mathbf{t}^{\mathcal{C}}(A)$ ) is any cell in the inverse image of  $\mathbf{s}^{\mathcal{B}}(A)$  under  $G$ , which is non-empty thanks to Lemma 5.7. And we set  $G(A) := A$ .



- For every  $A \in \mathcal{B}_3$ , the cells  $\rho_A$  and  $\lambda_A$  have the following shape:

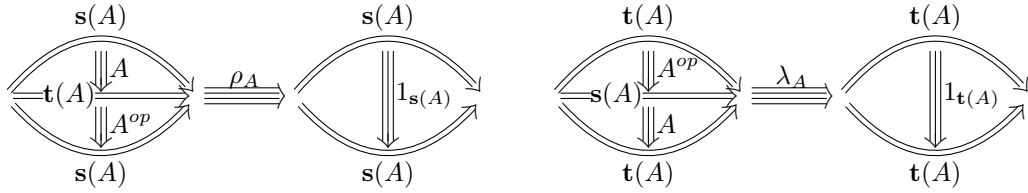

And we set  $G(\rho_A) := 1_{s(A)}$  and  $G(\lambda_A) := 1_{t(A)}$ .

Let  $S_C$  be the set of all 2-cells in  $\mathcal{C}^{\mathbf{w}}$  whose 2-target is a normal form.

**Proposition 5.8.** *The pointed (4,3)-white-category  $(\mathcal{C}^{\mathbf{w}(3)}, S_C)$  is stronger than  $(\mathcal{B}^{\mathbf{w}(2)}, S_B)$ .*

*Proof.* The functor  $G$  restricts into a functor  $G|_{S_C} : \mathcal{C}^{\mathbf{w}(3)}|_{S_C} \rightarrow \mathcal{B}^{\mathbf{w}(2)}|_{S_B}$ , which is  $i$ -surjective for  $i < 2$  thanks to Lemma 5.7. Hence we can conclude thanks to Lemma 4.24.  $\square$

**Example 5.9.** In the case where  $\mathcal{A} = \mathbf{Assoc}$ , let  $A = \nabla$ . The set  $\mathcal{C}_3$  contains the following 3-cell:

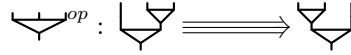

And the following cells lie in  $\mathcal{C}_4$ , where  $A = \nabla$ :

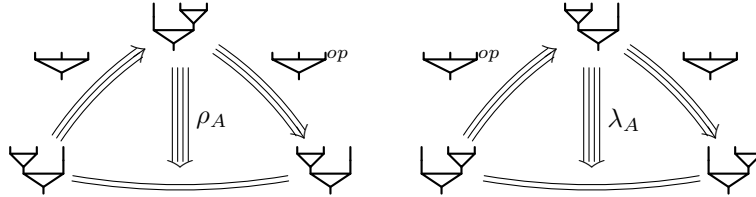

### 5.3 Adjunction of formal inverses to 2-cells

Let  $\mathcal{D}$  be the 4-white-polygraph defined as follows:

$$\text{for every } i \neq 2, \mathcal{D}_i := \mathcal{C}_i \quad \mathcal{D}_2 := \mathcal{C}_2 \cup \bar{\mathcal{C}}_2,$$

where for every  $f \in \mathcal{C}_2$ , the set  $\bar{\mathcal{C}}_2$  contains a cell  $\bar{f}$  with source  $\mathbf{t}(f)$  and with target  $\mathbf{s}(f)$ . Let  $S_{\mathcal{D}}$  be the set of all 2-cells of the sub-2-white-category  $\mathcal{C}_2^{\mathbf{w}}$  of  $\mathcal{D}_2^{\mathbf{w}}$  whose target is a normal form.

**Notation 5.10.** The application  $\mathcal{C}_2 \rightarrow \bar{\mathcal{C}}_2$  extends into an application  $\mathcal{C}_2^{\mathbf{w}} \rightarrow \bar{\mathcal{C}}_2^{\mathbf{w}}$  which exchanges the source and targets of the 2-cells.

For every cell  $f \in \mathcal{C}_2^{\mathbf{w}}$ , we note  $\xrightarrow{f}$  if  $f$  is in  $\mathcal{B}_2^{\mathbf{w}}$ ,  $\xleftarrow{f}$  if  $\bar{f}$  is in  $\mathcal{B}_2^{\mathbf{w}}$ , and  $\xleftrightarrow{f}$  for any cell in  $\mathcal{C}_2^{\mathbf{w}}$ .

**Proposition 5.11.** *The pointed (4,3)-white-category  $(\mathcal{D}^{\mathbf{w}(3)}, S_{\mathcal{D}})$  is stronger than  $(\mathcal{C}^{\mathbf{w}(3)}, S_C)$ .*

*Proof.* Let us show that  $\mathcal{D}^{\mathbf{w}(3)}|_{S_{\mathcal{D}}} = \mathcal{C}^{\mathbf{w}(3)}|_{S_C}$ . Let  $\iota : \mathcal{C}^{\mathbf{w}(3)} \rightarrow \mathcal{D}^{\mathbf{w}(3)}$  be the canonical inclusion functor. Since the only cells added are in dimension 2,  $\iota$  satisfies the hypotheses of Lemma 4.13, thus  $\mathcal{C}^{\mathbf{w}}$  is a sub-4-white-category of  $\mathcal{D}^{\mathbf{w}}$ , which gives us an inclusion  $\mathcal{C}^{\mathbf{w}(3)}|_{S_C} \subseteq \mathcal{D}^{\mathbf{w}(3)}|_{S_{\mathcal{D}}}$ .

Let us show the reverse inclusion. Let  $f \in \mathcal{D}^{\mathbf{w}(3)}$  be an  $i$ -cell ( $i \geq 2$ ), and suppose that  $f$  is in  $\mathcal{D}^{\mathbf{w}(3)}|_{S_{\mathcal{D}}}$ . In particular  $\mathbf{t}_2(f)$  and  $\mathbf{s}_2(f)$  are in  $\mathcal{C}_2^{\mathbf{w}}$ . Since  $\iota$  also satisfies the hypotheses of Lemma 4.16, with  $k_0 = 2$ , it is 2-discriminating on  $\mathcal{D}_i^{\mathbf{w}(3)}$ . Thus  $f$  is in  $\mathcal{C}^{\mathbf{w}(3)}$ , and in  $\mathcal{C}^{\mathbf{w}(3)}|_{S_C}$  since its 1-target is a normal form.  $\square$

**Example 5.12.** In the case where  $\mathcal{A} = \mathbf{Assoc}$ , the set  $\mathcal{D}_2$  contains one additional 2-cell:

$$\triangleleft := \overline{\triangleleft}$$

And the following cells are composites in  $\mathcal{D}^w$ :



Note that the equality  $\mathcal{D}^{w(3)} \upharpoonright_{S_{\mathcal{D}}} = \mathcal{C}^{w(3)} \upharpoonright_{S_{\mathcal{C}}}$  implies that none of these composites belongs to  $\mathcal{D}^{w(3)} \upharpoonright_{S_{\mathcal{D}}}$ .

## 5.4 Adjunction of connections between 2-cells

Let  $\mathcal{E}$  be the following 4-white-polygraph:

- For  $i = 0, 1, 2$ ,  $\mathcal{E}_i = \mathcal{D}_i$ ,
- For  $i = 3$ ,  $\mathcal{E}_3 = \mathcal{D}_3 \cup \{\eta_f, \epsilon_f | f \in \mathcal{C}_2\}$ .
- For  $i = 4$ ,  $\mathcal{E}_4 = \mathcal{D}_4 \cup \{\tau_f, \sigma_f | f \in \mathcal{C}_2\}$ .

The cells  $\eta_f$ ,  $\epsilon_f$ ,  $\tau_f$  and  $\sigma_f$  have the following shape:

- $\epsilon_f : \bar{f} \star_1 f \Rightarrow 1_{t(f)}$
- $\eta_f : 1_{s(f)} \Rightarrow f \star_1 \bar{f}$



- $\tau_f : (\bar{f} \star_1 \eta_f) \star_2 (\epsilon_f \star_1 \bar{f}) \rightarrow 1_{\bar{f}}$

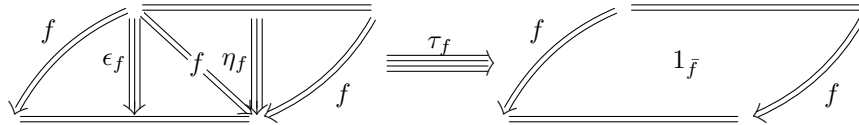

- $\sigma_f : (\eta_f \star_1 f) \star_2 (f \star_1 \epsilon_f) \rightarrow 1_f$ .

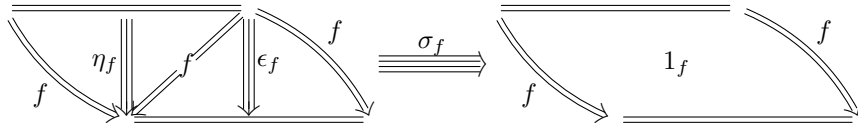

**Notation 5.13.** Let us note  $\cup$  the 3-cell  $\epsilon_f$  and  $\cap$  the 3-cell  $\eta_f$ . In a similar fashion, we note  $\boxplus$  for  $\sigma_f$  and  $\boxminus$  for  $\tau_f$ :



Let  $\mathcal{R} := \{\sigma_f, \tau_f\}$ , and  $\mathcal{R}^w$  (resp.  $\mathcal{R}^{w(3)}$ ) be the sub-4-white-category (resp. sub-(4,3)-white-category) of  $\mathcal{E}^{w(3)}$  generated by the cells in  $\mathcal{R}$ . A 4-cell of length 1 in  $\mathcal{R}^w$  is called an  $\mathcal{R}$ -rewriting step.

Let  $S_{\mathcal{E}}$  be the set of all 2-cells of the sub-2-white-category  $\mathcal{C}_2^{\mathbf{w}}$  of  $\mathcal{E}_2^{\mathbf{w}}$  whose target is a normal form. Using properties of the rewriting system induced by  $\mathcal{R}^{\mathbf{w}}$ , we are going to define a functor  $K : \mathcal{E}^{\mathbf{w}(3)} \downarrow S_{\mathcal{E}} \rightarrow \mathcal{D}^{\mathbf{w}(3)} \downarrow S_{\mathcal{D}}$ .

**Lemma 5.14.** *Let  $\alpha \in \mathcal{E}_4^{\mathbf{w}}$  and  $\beta \in \mathcal{R}^{\mathbf{w}}$  of length 1 with the same source. There exist  $\alpha' \in \mathcal{E}_4^{\mathbf{w}}$  and  $\beta' \in \mathcal{R}^{\mathbf{w}}$  of maximum length 1, such that:*

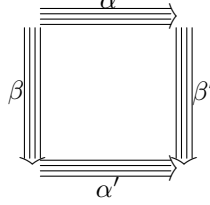

*Proof.* The result holds whenever  $(\alpha, \beta)$  is a Peiffer or aspherical branching.

If  $(\alpha, \beta)$  is an overlapping branching, then the source of  $\alpha$  must contain an  $\eta_f$  or an  $\epsilon_f$ . The only cells of length 1 in  $\mathcal{E}_4^{\mathbf{w}}$  that satisfy this property are those in  $\mathcal{R}^{\mathbf{w}}$ . Hence  $\alpha$  is in  $\mathcal{R}^{\mathbf{w}}$ . Thus the branching  $(\alpha, \beta)$  is one of the following two, and both of them satisfy the required property:

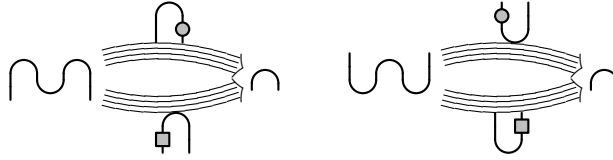

□

**Lemma 5.15.** *The rewriting system generated by  $\mathcal{R}$  is 4-convergent.*

*Proof.* Using Lemma 5.14, the rewriting system generated by  $\mathcal{R}$  is locally 4-confluent. Moreover, the cells  $\sigma_f$  and  $\tau_f$  decrease the length of the 3-cells, hence the 4-termination. □

Let  $A \in \mathcal{E}_3^{\mathbf{w}}$ : we note  $\hat{A} \in \mathcal{E}_3^{\mathbf{w}}$  its normal form for  $\mathcal{R}$ . Remark in particular that if  $A$  is in  $\mathcal{D}_3^{\mathbf{w}}$ , then  $\hat{A} = A$ .

**Lemma 5.16.** *Let  $A$  be a 3-cell of  $\mathcal{E}_3^{\mathbf{w}}$  whose target is in  $\mathcal{C}_2^{\mathbf{w}}$ .*

- *If the source of  $A$  is in  $\mathcal{C}_2^{\mathbf{w}}$ , then  $\hat{A}$  is in  $\mathcal{D}_3^{\mathbf{w}}$ .*
- *Otherwise, for every factorization of  $A$  into  $f_1 \star_1 \bar{f} \star_1 f_2$ , where  $f$  is a rewriting step, there exists a factorisation of  $A$  into:*

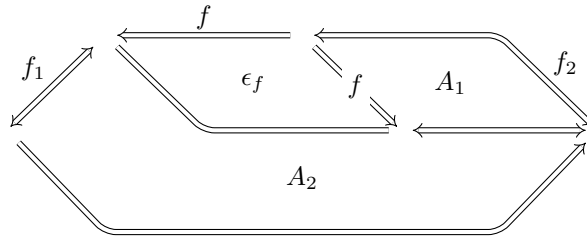

*Proof.* We reason by induction on the length of  $A$ . If  $A$  is of length 0, then the source of  $A$  is in  $\mathcal{C}_2^{\mathbf{w}}$ , and  $\hat{A} = A$  is in  $\mathcal{D}_3^{\mathbf{w}}$ .

If  $A$  is of length  $n > 0$ , let us write  $A = B_1 \star_1 B_2$ , where  $B_1$  is of length 1. We can then apply the induction hypothesis to  $B_2$ . We distinguish three cases:

- *If both the sources of  $A$  and  $B_2$  are in  $\mathcal{C}_2^{\mathbf{w}}$ , then  $B_1$  is in  $\mathcal{D}_3^{\mathbf{w}}$ , and so is  $\hat{A} = B_1 \star_2 \hat{B}_2$ .*

- If the source of  $A$  is in  $\mathcal{C}_2^{\mathbf{w}}$  but not that of  $B_2$ , then  $B_1$  is of the form  $g_1 \star_1 \eta_f \star_1 g_2$ . There hence exists a factorisation  $(g_1 \star_1 f) \star_1 \bar{f} \star_1 g_2$  of the source of  $B_2$ . Applying the induction hypothesis to  $B_2$ , we deduce the following factorisation of  $A$ :

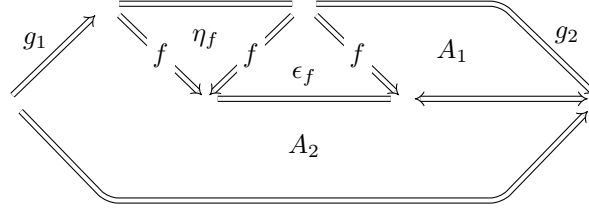

In particular,  $A$  is the source of an  $\mathcal{R}$ -rewriting step. Let  $A'$  be its target, which is thus of length smaller than  $A$ . Applying the induction hypothesis to  $A'$ , we get that  $\hat{A} = \hat{A}'$  is in  $\mathcal{D}_3^{\mathbf{w}}$ .

- There remains the case where the source of  $A$  is not an element of  $\mathcal{C}_2^{\mathbf{w}}$ .

In order to treat this last case, let us fix a factorisation  $f_1 \star_1 \bar{f} \star_1 f_2$  of the source of  $A$ , where  $f$  is of length 1. We distinguish three cases depending on the form of  $B_1$ .

- If  $B_1 = f_1 \star_1 \bar{f} \star_1 B'_1$ , where  $B'_1$  is a 3-cell of length 1 from  $f_2$  to  $g_2 \in \mathcal{D}_2^{\mathbf{w}}$ , then we get a factorisation of the source of  $B$  into  $f_1 \star_1 \bar{f} \star_1 g_2$ . Let us apply the induction hypothesis to  $B_2$ : there exist  $A'_1, A'_2 \in \mathcal{E}_3^{\mathbf{w}}$  and  $g'_2 \in \mathcal{D}_2^{\mathbf{w}}$  such that:

$$B_2 = (f_1 \star_1 \bar{f} \star_1 A'_1) \star_2 (f_1 \star_1 \epsilon_f \star_1 g'_2) \star_2 A'_2$$

Thus  $A$  factorises as follows, which is of the required form by setting  $A_1 = B'_1 \star_2 A'_1$  and  $A_2 = A'_2$ :

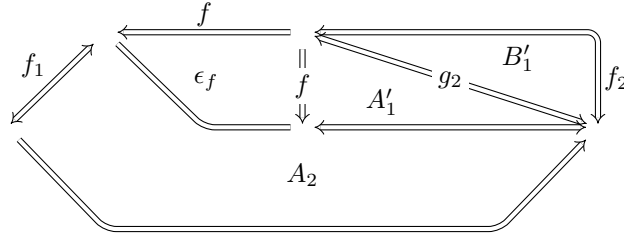

- If  $B_1 = B'_1 \star_1 \bar{f} \star_1 f_2$ , where  $B'_1$  is a 3-cell of length 1 from  $f_1$  to  $g_1 \in \mathcal{D}_2^{\mathbf{w}}$ . Then the source of  $B$  factorises into  $g_1 \star_1 \bar{f} \star_1 f_2$ . Applying the induction hypothesis to  $B_2$ , there exist  $A'_1, A'_2 \in \mathcal{E}_3^{\mathbf{w}}$  and  $f'_2 \in \mathcal{D}_2^{\mathbf{w}}$  such that:

$$B_2 = (g_1 \star_1 \bar{f} \star_1 A'_1) \star_2 (g_1 \star_1 \epsilon_f \star_1 f'_2) \star_2 A'_2$$

We get the required factorisation of  $A$  by setting  $A_1 = A'_1$  and  $A_2 = (B'_1 \star_1 f'_2) \star_2 A'_2$ .

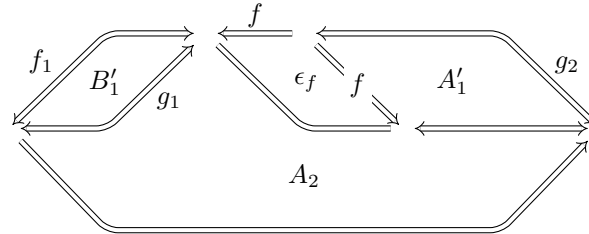

- Otherwise, we have  $B_1 = f_1 \star_1 \epsilon_f \star_1 f'_2$ , with  $f_2 = f \star_1 f'_2$ . We then get the required factorisation of  $A$  by setting  $A_1 = 1_{f'_2}$  and  $A_2 = B_2$ .

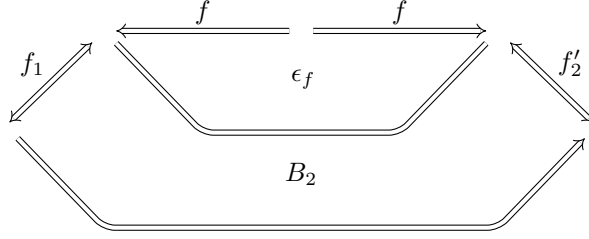

□

**Lemma 5.17.** *Let  $\beta \in \mathcal{R}^{\mathbf{w}}$ , and  $\alpha$  be a 4-cell  $\mathcal{E}_4^{\mathbf{w}}$  of same source. There exist  $\alpha' \in \mathcal{E}_4^{\mathbf{w}}$  and  $\beta' \in \mathcal{R}^{\mathbf{w}}$  of maximum length that of  $\beta$  such that we have the following square:*

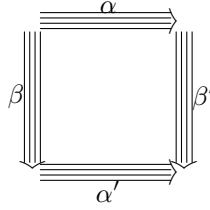

*Proof.* We reason using a double induction on the lengths of  $\beta$  and  $\alpha$ . If  $\beta$  (resp.  $\alpha$ ) is an identity, then the result holds by setting  $\alpha' = \alpha$  (resp.  $\beta' = \beta$ ).

Otherwise, let us write  $\alpha = \alpha_1 \star_3 \alpha_2$  and  $\beta = \beta_1 \star_3 \beta_2$ , where  $\alpha_1$  and  $\beta_1$  are of length 1. We can then construct the following diagram:

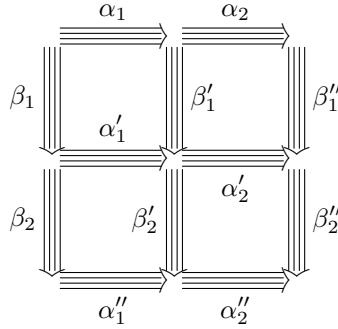

The 4-cells  $\alpha'_1$  and  $\beta'_1$  exist thanks to Lemma 5.14. We can then apply the induction hypothesis to the 4-cells  $\alpha_2$  and  $\beta'_1$  (resp.  $\alpha'_1$  and  $\beta_2$ ) and we construct this way the cells  $\alpha'_2$  and  $\beta''_1$  (resp.  $\alpha''_1$  and  $\beta'_2$ ). Lastly, we apply the induction hypothesis to  $\alpha'_2$  et  $\beta'_2$  in order to construct  $\alpha''_2$  and  $\beta''_2$ . □

**Lemma 5.18.** *The application  $A \mapsto \hat{A}$  extends into a 1-functor  $K : \mathcal{E}^{\mathbf{w}(3)} \downarrow S_{\mathcal{E}} \rightarrow \mathcal{D}^{\mathbf{w}(3)} \downarrow S_{\mathcal{D}}$ , which is the identity on objects.*

*Proof.* The application  $A \mapsto \hat{A}$  does not change the source or target. Moreover, given a 3-cell  $A \in \mathcal{E}^{\mathbf{w}(3)}$ , if  $A$  is in  $\mathcal{E}^{\mathbf{w}(3)} \downarrow S_{\mathcal{E}}$  then in particular the source and target of  $A$  are in  $\mathcal{C}_2^{\mathbf{w}}$ . Thus  $\hat{A}$  is in  $\mathcal{D}_3^{\mathbf{w}} \downarrow S_{\mathcal{D}}$  (Lemma 5.16).

Let  $A, B$  be 3-cells in  $\mathcal{E}^{\mathbf{w}(3)}$  which belong to  $\mathcal{E}^{\mathbf{w}(3)} \downarrow S_{\mathcal{E}}$ . We just showed that  $\hat{A}$  and  $\hat{B}$  are in  $\mathcal{D}_3^{\mathbf{w}} \downarrow S_{\mathcal{D}}$ , hence so is  $\hat{A} \star_2 \hat{B}$ . So  $\hat{A} \star_2 \hat{B}$  is a normal form for  $\mathcal{R}$  which is attainable from  $A \star_2 B$ . Since  $\mathcal{R}$  is 4-convergent, this means that  $\hat{A} \star_2 \hat{B} = \hat{A} \star_2 \hat{B}$ . So  $A \mapsto \hat{A}$  does indeed define a functor. □

**Proposition 5.19.** *The pointed (4, 3)-category  $(\mathcal{E}, S_{\mathcal{E}})$  is stronger than  $(\mathcal{D}, S_{\mathcal{D}})$ .*

*Proof.* Let us show that  $K$  induces a functor  $\bar{K} : \overline{\mathcal{E}^{\mathbf{w}(3)} \downarrow S_{\mathcal{E}}} \rightarrow \overline{\mathcal{D}^{\mathbf{w}(3)} \downarrow S_{\mathcal{D}}}$ . Let  $A, B$  be 1-cells in  $\mathcal{E}^{\mathbf{w}(3)} \downarrow S_{\mathcal{E}}$ , and suppose  $\hat{A} = \hat{B}$ . Let us show that  $\bar{K}(A) = \bar{K}(B)$ , that is that there exists a 4-cell  $\alpha' : \hat{A} \rightarrow \hat{B} \in \mathcal{D}_4^{\mathbf{w}(3)}$ .

Since  $\bar{A} = \bar{B}$  there exists a 4-cell  $\alpha : A \rightarrow B \in \mathcal{E}_4^{\mathbf{w}(3)}$ . Suppose that  $\alpha$  lies in  $\mathcal{E}_4^{\mathbf{w}}$ . Let  $\beta \in \mathcal{R}^{\mathbf{w}}$  be a cell from  $A$  to  $\hat{A}$ . Applying Lemma 5.17 to  $\alpha$  and  $\beta$ , we get cells  $\alpha'$  and  $\beta'$  of sources respectively  $\hat{A}$  and  $B$ . Let  $B'$  be their common target. By hypothesis  $\hat{A}$  is in  $\mathcal{D}_3^{\mathbf{w}}$ , and the only cells in  $\mathcal{E}_4^{\mathbf{w}}$  whose source is in  $\mathcal{D}_3^{\mathbf{w}}$  are the cells in  $\mathcal{D}_4^{\mathbf{w}}$ . Thus  $\alpha'$  is in  $\mathcal{D}_4^{\mathbf{w}}$ , and so is  $B'$ . So  $B'$  is a normal form for  $\mathcal{R}^{\mathbf{w}}$  which is attainable from  $B$ . By unicity of the  $\mathcal{R}^{\mathbf{w}}$ -normal-form,  $B' = \hat{B}$ , and so  $\alpha'$  is a cell in  $\mathcal{D}_4^{\mathbf{w}}$  of source  $K(A)$  and of target  $K(B)$ , hence  $\overline{K(A)} = \overline{K(B)}$ .

In general if  $\bar{A} = \bar{B}$ , there exist  $A_1, \dots, A_n \in \mathcal{E}_3^{\mathbf{w}}$  with  $A_1 = A$ ,  $B_n = B$  and for every  $i$  there exist cells  $\alpha_i : A_{2i} \rightarrow A_{2i-1}$  and  $\beta_i : A_{2i} \rightarrow A_{2i+1}$  in  $\mathcal{E}_4^{\mathbf{w}}$ . Hence using the previous case  $\overline{K(A_1)} = \dots = \overline{K(A_n)}$ , that is  $\overline{K(A_1)} = \overline{K(A_n)}$ .

So  $\bar{K} : \mathcal{E}^{\mathbf{w}(3)} \upharpoonright S_{\mathcal{E}} \rightarrow \mathcal{D}^{\mathbf{w}(3)} \upharpoonright S_{\mathcal{D}}$  is well defined, and it is 0 and 1-surjective because  $K$  is. Hence  $(\mathcal{E}, S_{\mathcal{E}})$  is stronger than  $(\mathcal{D}, S_{\mathcal{D}})$ .  $\square$

**Example 5.20.** In the case where  $\mathcal{A} = \mathbf{Assoc}$ , let  $A = \nabla$ . The set  $\mathcal{E}_3$  contains the following 3-cells:

$$\begin{array}{ccc} \begin{array}{c} \circlearrowleft \\ \circlearrowright \end{array} & \xRightarrow{\epsilon_A} & | \\ & & | \\ & & \xRightarrow{\eta_A} & \begin{array}{c} \circlearrowright \\ \circlearrowleft \end{array} \end{array}$$

And the set  $\mathcal{E}_4$  the following 4-cells:

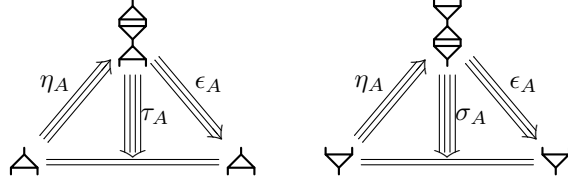

## 5.5 Reversing the presentation of a (4, 3)-white-category

We start by collecting some results on the cells of  $\mathcal{E}$ .

**Lemma 5.21.** *The set  $\mathcal{E}_3$  is composed exactly of the following cells:*

- For every  $f \in \mathcal{A}_2$ , 3-cells  $\eta_f$  and  $\epsilon_f$ .
- For every non-aspherical minimal branching  $(f, g)$ , a 3-cell  $A_{f,g}$  of shape:

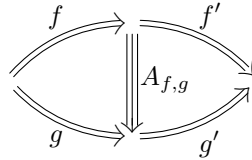

And in particular for every non-aspherical minimal branching  $(f, g)$ , we have  $A_{f,g}^{op} = A_{g,f}$ .

*Proof.* If  $(f, g)$  is a critical pair: if it was associated to a 3-cell in  $\mathcal{A}$  then  $A_{f,g}$  is this corresponding cell. Otherwise  $A_{f,g}$  is in fact the cell  $A_{g,f}^{op}$  from Section 5.2.

If  $(f, g)$  is a strict Peiffer branching, then  $A_{f,g}$  is the cell defined in Section 5.1. Otherwise,  $(g, f)$  is a strict Peiffer branching, and we set  $A_{f,g} := A_{g,f}^{op}$  from Section 5.2.  $\square$

**Lemma 5.22.** *For every minimal non-aspherical branching  $(f, g, h)$ , there exists a 4-cell  $A_{f,g,h} \in \mathcal{E}_4^{\mathbf{w}(3)}$  of the following shape:*

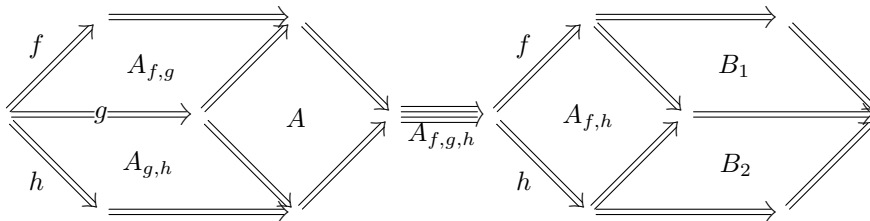

*Proof.* Let us first start by showing that, for every non-aspherical 3-fold minimal symmetrical branching  $b$ , there exists a representative  $(f, g, h)$  of  $b$  for which the property holds. If  $b$  is an overlapping branching then, using the fact that  $\mathcal{A}$  satisfies the 2-Squier condition of rank 2, the cell  $A_{f,g,h}$  exists for some representative  $(f, g, h)$  of  $b$ . Otherwise  $b$  is a Peiffer branching, and we conclude using the cells defined in Section 5.1.

It remains to show that the set of all branchings satisfying the property is closed under the action of the symmetric group.

- If  $(f_1, f_2, f_3)$  satisfies the property, then so does  $(f_3, f_2, f_1)$ . Indeed, let  $A := A_{f_1, f_2, f_3}$ , and let us note its source  $s$  and its target  $t$ , all we need to construct is a 4-cell from  $s^{op}$  to  $t^{op}$ . This is given by the following composite:

$$s^{op} \xRightarrow{s^{op} \star_2 \lambda_t^{-1}} t^{op} \star_2 t \star_2 s^{op} \xRightarrow{t^{op} \star_2 A^{-1} \star_2 s^{op}} t^{op} \star_2 s \star_2 s^{op} \xRightarrow{t^{op} \star_2 \rho_s} t^{op}$$

- If  $(f_1, f_2, f_3)$  satisfies the property, then so does  $(f_2, f_1, f_3)$ . Indeed, given a cell  $A_{f_1, f_2, f_3}$ , we can construct the following composite:

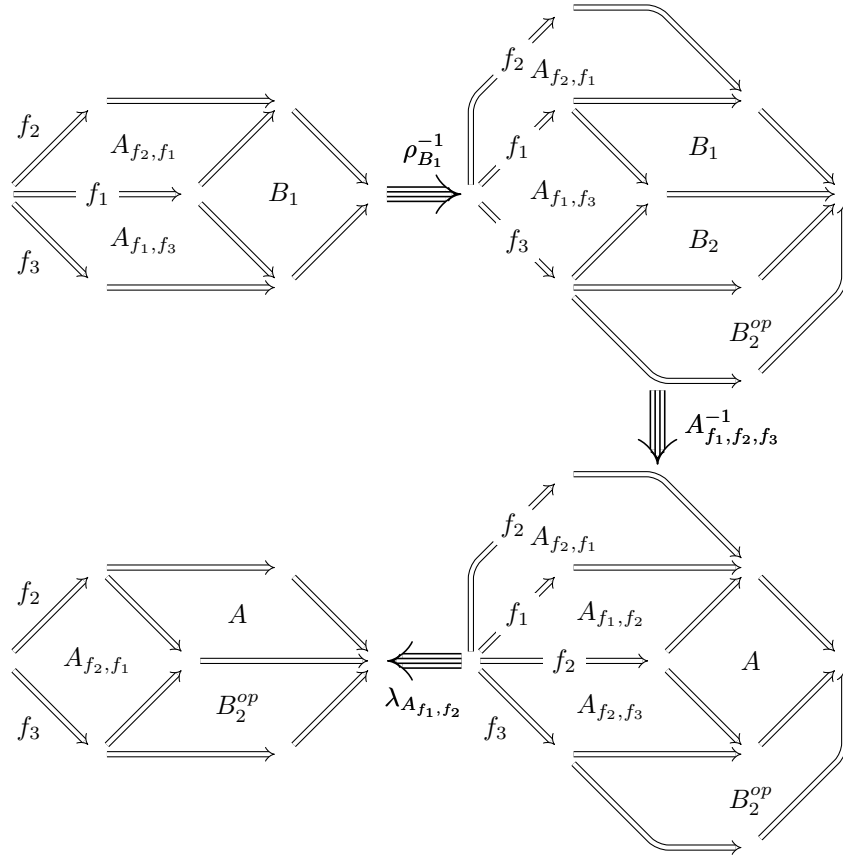

Since the transpositions (1 2) and (1 3) generate the symmetric group, the set of all branchings satisfying the property is closed under the action of the symmetric group.  $\square$

We are now going to apply a series of Tietze-transformations to  $\mathcal{E}$  in order to mimic a technique known as *reversing*. Reversing is a combinatorial tool to study presented monoids [4]. Reversing is particularly adapted to monoids whose presentation contains no relation of the form  $su = sv$ , where  $s$  is a generator and  $u$  and  $v$  words in the free monoid, and at most one relation of the form  $su = s'v$ , for  $s$  and  $s'$  generators. The  $(4, 2)$ -polygraph  $\mathcal{A}$  satisfies those properties, but only up to a dimensional shift: there are no 3-cell in  $\mathcal{A}_3$  of the form  $f \star_2 g \Rightarrow f \star_2 h$ , where  $f$  is of length 1 and  $g$  and  $h$  are in  $\mathcal{A}_2^w$ , and there is at most one 3-cell in  $\mathcal{A}_3$  of the form  $f \star_2 g \Rightarrow f' \star_2 h$ , where  $f$  and  $f'$  are of length 1. Hence we adapt this method to our higher-dimensional setting.

**Adjunction of 3-cells  $C_{f,g}$  with its defining 4-cell  $X_{f,g}$ .** For every non-aspherical branching  $(f, g)$ , we add a 3-cell  $C_{f,g}$  of the following shape:

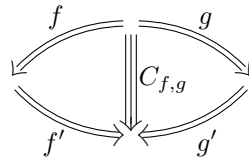

using as defining 4-cell a cell  $X_{f,g}$  whose target is  $C_{f,g}$  and whose source is the composite:

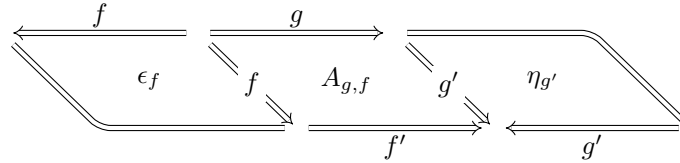

**Adjunction of a superfluous 4-cell  $Y_{f,g}$ .** We add a 4-cell  $Y_{f,g}$  of target  $A_{g,f}$ , parallel to the following 4-cell:

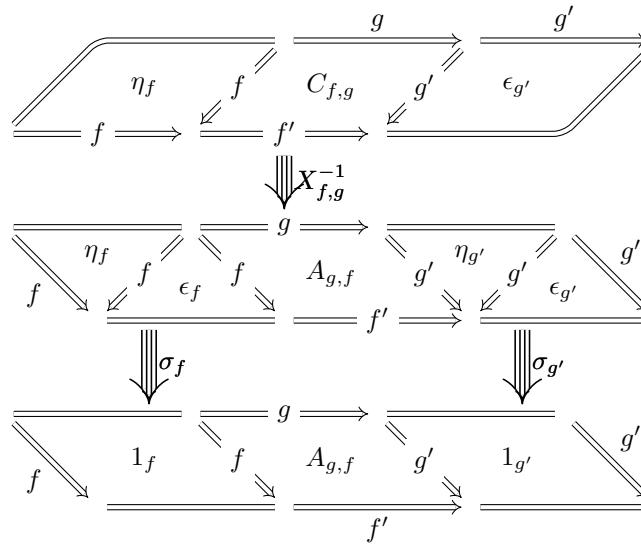

**Deletion of the superfluous 4-cell  $X_{f,g}$ .** We delete the 4-cell  $X_{f,g}$ , using the fact that it is parallel to the following composite:

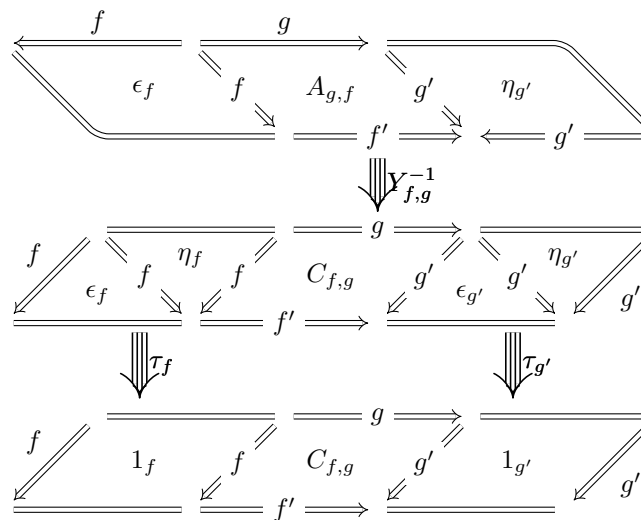



**Deleting of the 3-cell  $A_{g,f}$  with its defining 4-cell  $Y_{f,g}$ .** This last step is possible because  $A_{g,f}$  is the target of  $Y_{f,g}$  and does not appear in its source.

We note  $\mathcal{F}$  the 4-white-polygraph obtained after performing this series of Tietze-transformations for every non-aspherical branching  $(f, g)$ , and  $\Pi : \mathcal{E}^{\mathbf{w}(3)} \rightarrow \mathcal{F}^{\mathbf{w}(3)}$  the 3-white-functor induced by the Tietze-transformations. We still note  $A_{g,f}$  the composite in  $\mathcal{F}_4^{\mathbf{w}(3)}$ , image by  $\Pi$  of  $A_{f,g} \in \mathcal{E}_4$ .

**Example 5.23.** In the case where  $\mathcal{A} = \mathbf{Assoc}$ , the cells  $\nabla$  and  $\nabla^{op}$  respectively associated to the branchings  $(\nabla \mid , \mid \nabla)$  and  $(\mid \nabla , \nabla \mid)$  have been replaced by cells of the following shape:

$$\begin{array}{ccc} \begin{array}{c} \diagup \quad \diagdown \\ \diagdown \quad \diagup \end{array} & \Longrightarrow & \begin{array}{c} \diagdown \quad \diagup \\ \diagup \quad \diagdown \end{array} \end{array} \quad \begin{array}{ccc} \begin{array}{c} \diagdown \quad \diagup \\ \diagup \quad \diagdown \end{array} & \Longrightarrow & \begin{array}{c} \diagup \quad \diagdown \\ \diagdown \quad \diagup \end{array} \end{array}$$

## 6 Proof of Theorem 1.27

This Section concludes the proof of Theorem 1.27. In Section 6.1, we study the 4-cells of the  $(4, 3)$ -white-category  $\mathcal{F}^{\mathbf{w}(3)}$ , and in particular study the consequence of  $\mathcal{A}$  satisfying the 2-Squier condition of rank 2.

In Section 6.2, we define a well-founded ordering on  $\mathbb{N}[\mathcal{F}_1^{\mathbf{w}}]$ , the free commutative monoid on  $\mathcal{F}_1^{\mathbf{w}}$ . Using this ordering together with two applications  $\mathbf{p} : \mathcal{F}_2^{\mathbf{w}} \rightarrow \mathbb{N}[\mathcal{F}_1^{\mathbf{w}}]$  and  $\mathbf{w}_\eta : \mathcal{F}_3^{\mathbf{w}} \rightarrow \mathbb{N}[\mathcal{F}_1^{\mathbf{w}}]$ , we proceed to complete the proof by induction in Section 6.3.

### 6.1 Local coherence

**Definition 6.1.** We extend the notation  $C_{f,g}$  from Section 5.5 by defining, for every local branching  $(f, g)$  of  $\mathcal{B}_2^{\mathbf{w}}$ , a 3-cell of the form  $C_{f,g} : \bar{f} \star_1 g \Rrightarrow f' \star_1 \bar{g}' \in \mathcal{F}_3^{\mathbf{w}}$ , where  $f'$  and  $g'$  are in  $\mathcal{B}_2^{\mathbf{w}}$ .

- If  $(f, g)$  is a minimal overlapping or Peiffer branching, then  $C_{f,g}$  is already defined.
- If  $(f, g)$  is aspherical, that is  $f = g$ , then we set  $C_{f,f} = \epsilon_f$ .
- If  $(f, g)$  is not minimal, then let us write  $(f, g) = (u\tilde{f}v, u\tilde{g}v)$ , with  $(\tilde{f}, \tilde{g})$  a minimal branching, and we set  $C_{f,g} := uC_{\tilde{f},\tilde{g}}v$ .

**Definition 6.2.** We say that a 3-fold local branching  $(f, g, h)$  of  $\mathcal{A}_2$  is *coherent* if there exists a 4-cell  $C_{f,g,h} \in \mathcal{F}_4^{\mathbf{w}(3)}$  of the following shape, where  $A$  and  $B$  are 4-cells in  $\mathcal{F}_3^{\mathbf{w}}$ .

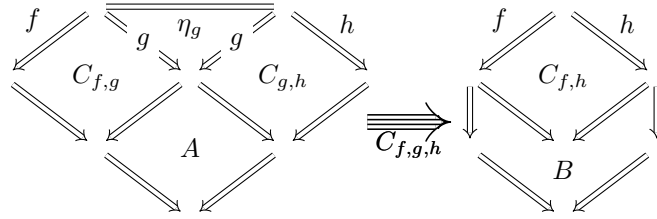

**Lemma 6.3.** Every 3-fold local branching of  $\mathcal{B}_2^{\mathbf{w}}$  is coherent.

*Proof.* Let  $(f, g, h)$  be a minimal local branching. We first treat the case where  $(f, g, h)$  is an aspherical branching. If  $f = g$ , then  $C_{f,g} = \epsilon_f$ , and the following cell shows that the branching is coherent:

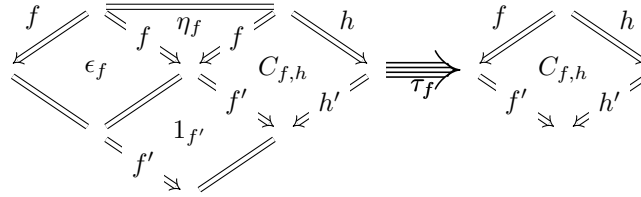

The case where  $g = h$  is symmetrical. Assume now  $g \neq f, h$  and  $f = h$ . Then  $(f, g)$  is either an overlapping or a Peiffer branching. In any case there exists either a cell  $A_{f,g}$  or  $A_{g,f}$  in  $\mathcal{E}_3^{\mathbf{w}}$ . In the former case, we can construct the following cell in  $\mathcal{F}_4^{\mathbf{w}(3)}$ .

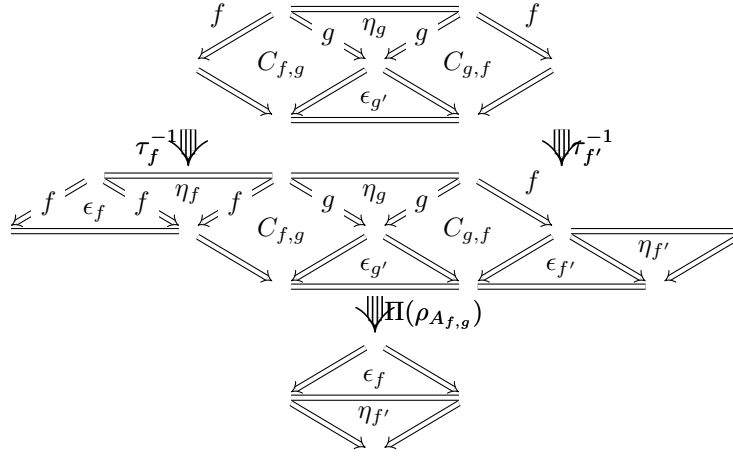

In the latter, we can construct the same cell, only replacing  $\Pi(\rho_{A_{f,g}})$  by  $\Pi(\lambda_{A_{f,g}})$ .

Suppose now that  $(f, g, h)$  is not aspherical. Using the cell  $A_{f,g,h}$  described in Lemma 5.22, we build the following composite in  $\mathcal{F}_4^{\mathbf{w}(3)}$ :

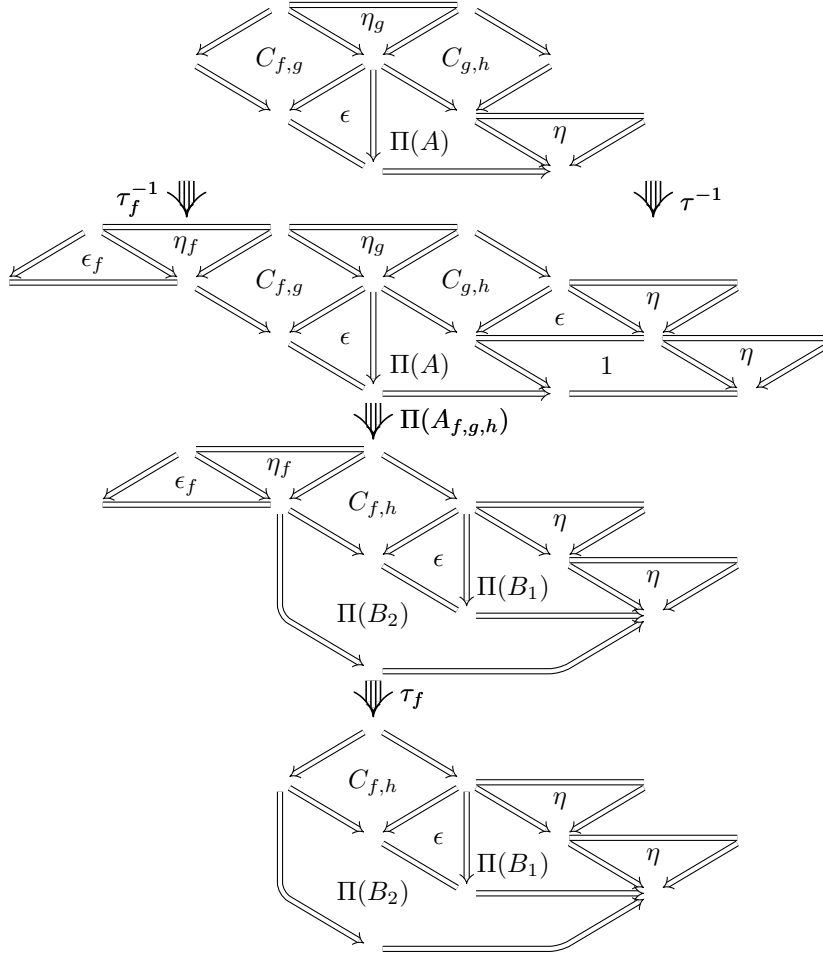

Finally, if  $(f, g, h)$  is not aspherical, then there exists a 3-fold minimal branching  $(\tilde{f}, \tilde{g}, \tilde{h})$  of  $\mathcal{B}_2^{\mathbf{w}}$  and 1-cells  $u, v \in \mathcal{B}_1^{\mathbf{w}}$  such that  $(f, g, h) = (u\tilde{f}v, u\tilde{g}v, u\tilde{h}v)$ . Then the cell  $uC_{\tilde{f},\tilde{g},\tilde{h}}v$  shows that  $(f, g, h)$  is coherent.  $\square$

## 6.2 Orderings on the cells of $\mathcal{F}^w$

**Definition 6.4.** Let  $E$  be a set. The set of all finite multi-sets on  $E$  is  $\mathbb{N}[E]$ , the free commutative monoid over  $E$ . For every  $e \in E$ , let  $\mathbf{v}_e : \mathbb{N}[E] \rightarrow \mathbb{N}$  be the morphism of monoids that sends  $e$  to 1 and every other elements of  $E$  to 0.

If  $E$  is equipped with a strict ordering  $>$ , we note  $>_m$  the strict ordering on  $\mathbb{N}[E]$  defined as follows: for every  $f, g \in \mathbb{N}[E]$ , one has  $f >_m g$  if

- $f \neq g$
- For every  $e \in E$ , if  $\mathbf{v}_e(f) < \mathbf{v}_e(g)$ , then there exists  $e' > e$  such that  $\mathbf{v}_{e'}(f) > \mathbf{v}_{e'}(g)$ .

**Lemma 6.5.** Let  $E$  be a set and  $a \in E$ . The set of all  $f \in \mathbb{N}[E]$  such that  $f < a$  is equal to the set of all  $f \in \mathbb{N}[E]$  satisfying the following implication for every  $b \in E$ :

$$\mathbf{v}_b(f) > 0 \Rightarrow b < a.$$

In particular, this set is a sub-monoid of  $\mathbb{N}[E]$ .

*Proof.* Let  $f \in \mathbb{N}[E]$  such that for every  $b \in E$  the implication  $\mathbf{v}_b(f) > 0 \Rightarrow b < a$  is verified. Let us prove that  $f <_m a$ . Necessarily  $\mathbf{v}_a(f) = 0$ , otherwise we would have  $a < a$ . Thus in particular  $f \neq a$ . Moreover, let  $b \in E$  such that  $\mathbf{v}_b(f) > \mathbf{v}_b(a) \geq 0$ . By definition of  $f$  this implies that  $b < a$ , and since  $0 = \mathbf{v}_a(f) < \mathbf{v}_a(a) = 1$  we get that  $f < m_a$ .

Conversely, let  $f <_m a$ . Let us show by contradiction that  $\mathbf{v}_a(f) = 0$ . If  $\mathbf{v}_a(f) \neq 0$ , we distinguish two cases:

- If  $\mathbf{v}_a(f) = 1$ , then since  $f \neq a$ , there exists  $b \neq a \in E$  such that  $\mathbf{v}_b(f) > 0$ . Thus because  $f < a$ , there exists  $c > b \in E$  such that  $\mathbf{v}_c(f) < \mathbf{v}_c(a)$ . So we necessarily have  $\mathbf{v}_c(a) \geq 1$ , which implies that  $c = a$ . The condition  $\mathbf{v}_c(f) < \mathbf{v}_c(a)$  thus becomes  $\mathbf{v}_a(f) < 1$ , which contradicts the hypothesis that  $\mathbf{v}_a(f) = 1$ .
- If  $\mathbf{v}_a(f) > 1$ , then there exists  $b > a$  such that  $\mathbf{v}_b(a) > \mathbf{v}_b(f)$ , which is impossible.

Hence necessarily  $\mathbf{v}_a(f) = 0$ .

Let  $b \in E$  such that  $\mathbf{v}_b(f) > 0$ , and let us show that  $b < a$ . We just showed that  $b \neq a$ , and so  $\mathbf{v}_b(f) > \mathbf{v}_b(a)$ . Thus there exists  $c > b$  such that  $\mathbf{v}_c(a) > \mathbf{v}_c(f)$ . In particular this implies  $\mathbf{v}_c(a) > 0$ . So  $c = a$  and finally  $a > b$ .  $\square$

**Lemma 6.6.** Let  $(E, <)$  be a set equipped with a strict ordering. The relation  $>_m$  is compatible with the monoidal structure on  $\mathbb{N}(E)$ , that is, for every  $f, f', g \in \mathbb{N}(E)$ , if  $f >_m f'$ , then  $f + g >_m f' + g$ .

*Proof.* Let  $f, f', g \in \mathbb{N}(E)$ , and suppose that  $f >_m f'$ . Let us show that  $f + g >_m f' + g$ . Firstly,  $f \neq f'$ , hence  $f + g \neq f' + g$ .

Let  $e \in E$  such that  $\mathbf{v}_e(f + g) < \mathbf{v}_e(f' + g)$ . Since  $\mathbf{v}_e$  is a morphism of monoids, this implies that  $\mathbf{v}_e(f) < \mathbf{v}_e(f')$ . Hence there exists  $e' > e$  such that  $\mathbf{v}_{e'}(f) > \mathbf{v}_{e'}(f')$ , and so  $\mathbf{v}_{e'}(f + g) > \mathbf{v}_{e'}(f' + g)$   $\square$

The proof of the following theorem can be found in [1].

**Theorem 6.7.** Let  $(E, >)$  be a set equipped with a strict ordering. Then  $>_m$  is a well-founded ordering if and only if  $>$  is.

Since  $\mathcal{A}$  is 2-terminating, the set  $\mathcal{A}_1^*$  is equipped with a well-founded ordering  $\Rightarrow$ . This induces a well founded ordering  $\Rightarrow_m$  on  $\mathbb{N}[\mathcal{A}_1^*]$ . We now define two applications  $\mathbf{p} : \mathcal{F}_2^w \rightarrow \mathbb{N}[\mathcal{A}_1^*]$  and  $\mathbf{w}_\eta : \mathcal{F}_3^w \rightarrow \mathbb{N}[\mathcal{A}_1^*]$ . Using  $\Rightarrow_m$ , those applications induce well-founded orderings on  $\mathcal{F}_2^w$  and  $\mathcal{F}_3^w$ . We then show a number of properties of these applications in preparation for Section 4.3.

**Definition 6.8.** We define an application  $\mathbf{p} : \mathcal{F}_2^w \rightarrow \mathbb{N}[\mathcal{A}_1^*]$ :

- for every  $f \in \mathcal{F}_2^w$  of length 1, we set  $\mathbf{p}(f) := \mathbf{s}(f) + \mathbf{t}(f)$ ,
- for every composable  $f_1, f_2 \in \mathcal{F}_2^w$ , we set  $\mathbf{p}(f_1 \star_1 f_2) := \mathbf{p}(f_1) + \mathbf{p}(f_2)$ .

For every  $f, g \in \mathcal{F}_2^w$ , we set  $f > g$  if  $\mathbf{p}(f) \Rightarrow_m \mathbf{p}(g)$ . The relation  $>$  is a well-founded ordering of  $\mathcal{F}_2^w$ .

**Definition 6.9.** We define an application  $\mathbf{w}_\eta : \mathcal{F}_3^{\mathbf{w}} \rightarrow \mathbb{N}[\mathcal{A}_1^*]$  by setting:

- For every  $f \in \mathcal{B}_2^{\mathbf{w}}$  of length 1,  $\mathbf{w}_\eta(\eta_f) = \mathbf{s}(f)$ .
- For every 3-cell  $A \in \mathcal{F}_3$  and  $u, v \in \mathcal{A}_1^*$ , if  $A$  is not an  $\eta_f$  then  $\mathbf{w}_\eta(uAv) = 0$ .
- For every  $f_1, f_2 \in \mathcal{F}_2^{\mathbf{w}}$  and  $A \in \mathcal{F}_3^{\mathbf{w}}$ ,  $\mathbf{w}_\eta(f_1 \star_1 A \star_1 f_2) = \mathbf{w}_\eta(A)$ .
- For every  $A_1, A_2 \in \mathcal{F}_3^{\mathbf{w}}$ ,  $\mathbf{w}_\eta(A_1 \star_2 A_2) = \mathbf{w}_\eta(A_1) + \mathbf{w}_\eta(A_2)$ .

**Definition 6.10.** A product of the form  $\bar{f} \star_1 g \in \mathcal{F}_2^{\mathbf{w}}$ , where  $f$  and  $g$  are nonempty cells in  $\mathcal{B}_2^{\mathbf{w}}$  is called a *cavity*. It is a *local cavity* if  $f$  and  $g$  are of length 1. Let  $C_{\mathcal{F}}$  be the set of all cavities.

**Lemma 6.11.** Let  $f, g \in \mathcal{B}_2^{\mathbf{w}}$ . Suppose  $f$  is not an identity and  $\mathbf{t}(f) = \mathbf{s}(g)$ . The following inequality holds:

$$\mathbf{s}(f) > \mathbf{p}(g)$$

*Proof.* We reason by induction on the length of  $g$ . If  $g$  is empty, then  $\mathbf{p}(g) = 0 < \mathbf{s}(f)$ .

Otherwise, let us write  $g = g_1 \star_1 g_2$ , with  $g_1$  of length 1. Then  $\mathbf{p}(g) = \mathbf{p}(g_1) + \mathbf{p}(g_2)$  and by induction hypothesis  $\mathbf{p}(g_2) < \mathbf{s}(f \star_1 g_1) = \mathbf{s}(f)$ . Moreover we have  $f : \mathbf{s}(f) \Rightarrow \mathbf{s}(g_1)$  and  $f \star_1 g_1 : \mathbf{s}(f) \Rightarrow \mathbf{t}(g_1)$ . Hence  $\mathbf{s}(f) > \mathbf{p}(g_1), \mathbf{s}(g_2), \mathbf{t}(g_2)$  and, by Lemma 6.5, we get  $\mathbf{s}(f) > \mathbf{p}(g_1) + \mathbf{s}(g_2) + \mathbf{t}(g_2) = \mathbf{p}(g)$ .  $\square$

**Lemma 6.12.** Let  $f_1, f_2, g_1, g_2 \in \mathcal{B}_2^{\mathbf{w}}$ , with  $f_1$  and  $f_2$  non-empty and of same source  $u$ . For every 3-cell  $A : \bar{f}_1 \star_1 f_2 \Rightarrow g_1 \star_1 \bar{g}_2 \in \mathcal{F}_3^{\mathbf{w}}$ , the following inequalities hold:

$$\mathbf{p}(\mathbf{s}(A)) > u > \mathbf{p}(\mathbf{t}(A)).$$

In particular for every cell  $C_{f,g}$ , we have  $\mathbf{s}(C_{f,g}) > \mathbf{t}(C_{f,g})$ .

*Proof.* Considering the first inequality, we have  $\mathbf{p}(\mathbf{s}(A)) = \mathbf{p}(f_1) + \mathbf{p}(g_2) \geq 2u > u$ .

Considering the second one, using Lemma 6.11, we have the inequalities  $u = \mathbf{s}(f_1) > \mathbf{p}(g_1)$  and  $u = \mathbf{s}(f_2) > \mathbf{p}(g_2)$ . By 6.5, we then have  $u > \mathbf{p}(g_1) + \mathbf{p}(g_2) = \mathbf{p}(\mathbf{t}(A))$ .  $\square$

**Definition 6.13.** Let  $h \in \mathcal{F}_2^{\mathbf{w}}$ . A factorisation  $h = h_1 \star_1 \bar{f}_1 \star_1 f_2 \star_1 h_2$  of  $h$ , with  $f_1, f_2 \in \mathcal{B}_2^{\mathbf{w}}$  of length 1 and  $h_1, h_2 \in \mathcal{F}_2^{\mathbf{w}}$  is called a *cavity-factorisation* of  $h$ . Thus a cavity-factorisation is represented as follows:

$$\begin{array}{c} \xleftrightarrow{h_1} \quad \begin{array}{c} \swarrow f_1 \\ \searrow f_2 \end{array} \quad \xleftrightarrow{h_2} \\ \xleftrightarrow{\hspace{1.5cm}} \end{array}$$

**Lemma 6.14.** Let  $h \in \mathcal{F}_2^{\mathbf{w}}$  be a 2-cell which is not an identity, and whose source and target are a normal form for  $\mathcal{A}_2$ . Then there exists a cavity-factorisation of  $h$ .

*Proof.* By definition of  $\mathcal{F}_2^{\mathbf{w}}$ , there exist  $n \in \mathbb{N}^*$  and  $g_1, \dots, g_{2n} \in \mathcal{B}_2^{\mathbf{w}}$  all not identities, except possibly  $g_1$  or  $g_{2n}$ , such that  $h = \bar{g}_1 \star_1 g_2 \star_1 \dots \star_1 \bar{g}_{2n-1} \star_1 g_{2n}$ .

Let us show that  $g_1$  and  $g_{2n}$  are not identities:

- If  $g_1$  is an identity, then since  $h$  isn't, either  $n \geq 2$  or  $n = 1$  and  $g_{2n}$  is not an identity. In both cases  $g_2$  is of length at least 1, and has  $\mathbf{s}(h)$  as target, which contradicts the fact that  $\mathbf{s}(h)$  is a normal form for  $\mathcal{A}_2$ .
- The case where  $g_{2n}$  is an identity is symmetric.

Therefore the 2-cells  $g_1$  and  $g_2$  are of length at least 1. So we can write  $g_1 = f_1 \star_1 g'_1$  and  $g_2 = f_2 \star_1 g'_2$ , with  $f_1, f_2 \in \mathcal{B}_2^{\mathbf{w}}$  of length 1. Let  $h_1 := \bar{g}'_1$  and  $h_2 := g'_2 \star_1 \bar{g}_3 \star_1 g_4 \star_1 \dots \star_1 \bar{g}_{2n-1} \star_1 g_{2n}$ . We finally get:  $h = h_1 \star_1 \bar{f}_1 \star_1 f_2 \star_1 h_2$ .  $\square$

**Lemma 6.15.** Let  $h \in \mathcal{F}_2^{\mathbf{w}}$  be a 2-cell of source and target  $\hat{u}$ , a normal form for  $\mathcal{A}_2$ . There exists a 3-cell  $A : h \Rightarrow 1_{\hat{u}}$  such that  $\mathbf{w}_\eta(A) = 0$ .

*Proof.* We reason by induction on  $h$  using the ordering  $>$ . If  $h$  is minimal, then  $h = 1_{\hat{u}}$  and we can set  $A := 1_h$ .

Otherwise by Lemma 6.14 there exists a cavity-factorisation  $h = h_1 \star_1 f_1 \star_1 f_2 \star_1 h_2$  of  $h$ . Let  $A_1 := C_{f_1, f_2}$ : we have  $\mathbf{w}_\eta(A_1) = 0$  and by Lemma 6.12,  $\mathbf{s}(A_1) > \mathbf{t}(A_1)$ . Since the ordering is compatible with composition, we get  $h > h_1 \star_1 \mathbf{t}(A_1) \star_1 h_2$ . By induction hypothesis, there exists a 3-cell  $A_2 : h_1 \star_1 \mathbf{t}(A_1) \star_1 h_2 \Rightarrow 1_{\hat{u}} \in \mathcal{F}_3^{\mathbf{w}}$  such that  $\mathbf{w}_\eta(A_2) = 0$ .

Let  $A := (h_1 \star_1 A_1 \star_1 h_2) \star_1 A_2$ . We have  $\mathbf{w}_\eta(A) = \mathbf{w}(h_1 \star_1 A_1 \star_1 h_2) + \mathbf{w}(A_2) = \mathbf{w}(A_1) + 0 = 0$ .  $\square$

**Lemma 6.16.** *Let  $h \in \mathcal{F}_2^{\mathbf{w}}$  of source and target  $\hat{u}$  a normal form for  $\mathcal{A}_2$ , and  $A : h \Rightarrow 1_{\hat{u}} \in \mathcal{F}_3^{\mathbf{w}}$ . For every cavity-factorisation  $h = h_1 \star_1 \bar{f}_1 \star_1 f_2 \star_1 h_2$ , there exists a factorisation of  $A = (h_1 \star_1 A_1 \star_1 h_2) \star_2 A_2$ , with  $A_1, A_2 \in \mathcal{F}_3^{\mathbf{w}}$ , and either  $A_1 = C_{f_1, f_2}$  or  $A_1 = \bar{f}_1 \star_1 \eta_{f_3} \star_1 f_2$ , with  $f_3 \in \mathcal{B}_2^{\mathbf{w}}$  of length 1.*

*Proof.* We reason by induction on the length of  $A$ . If  $A$  is of length 0, then there is no cavity-factorisation of  $h = 1_{\hat{u}}$  and the result holds.

If  $A$  is not of length 0, let  $h = h_1 \star_1 \bar{f}_1 \star_1 f_2 \star_1 h_2$  be a cavity-factorisation of  $h$ . Let us write  $A = B \star_1 C$ , where  $B$  is of length 1. If  $B$  is not of the required form, then either  $B = B' \star_1 \bar{f}_1 \star_1 f_2 \star_1 h_2$ , or  $B = h_1 \star_1 \bar{f}_1 \star_1 f_2 \star_1 B'$ . Let us treat the first case, the second being symmetrical. The source of  $C$  admits a cavity-factorisation  $\mathbf{s}(C) = \mathbf{t}(B') \star_1 \bar{f}_1 \star_1 f_2 \star_1 h_2$ . By induction hypothesis, we can factorise  $C$  as follows:

$$C = (h'_1 \star_1 A_1 \star_1 h_2) \star_2 C',$$

with  $A_1 = C_{f_1, f_2}$  or  $A_1 = \bar{f}_1 \star_1 \eta_{f_3} \star_1 f_2$ . Let  $A_2 := (B'_1 \star_1 \mathbf{t}(A_1) \star_1 h_2) \star_2 C_2$ : we then have  $A = (h_1 \star_1 A_1 \star_1 h_2) \star_2 A_2$ .

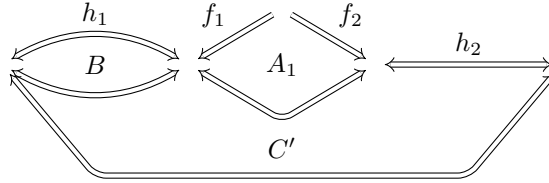

$\square$

**Lemma 6.17.** *Let  $h \in \mathcal{F}_2^{\mathbf{w}}$  and  $u \in \mathcal{A}_1^*$  such that  $u > \mathbf{p}(h)$ ,  $u > \mathbf{s}(h)$  and  $u > \mathbf{t}(h)$ . For every 3-cell  $A \in \mathcal{F}_3^{\mathbf{w}}$  of source  $h$ , the inequality  $u > \mathbf{w}_\eta(A)$  holds.*

*Proof.* We reason by induction on the length of  $A$ . If  $A$  is of length 0,  $\mathbf{w}_\eta(A) = 0$  and the result holds.

Otherwise, let us write  $A = A_1 \star_2 A_2$ , with  $A_1$  of length 1. We distinguish two cases depending on the shape of  $A_1$ .

- If  $A_1 = h_1 \star_1 \eta_f \star_1 h_2$ , with  $h_1, h_2 \in \mathcal{F}_2^{\mathbf{w}}$  and  $f \in \mathcal{B}_2^{\mathbf{w}}$  of length 1.

If  $h_1$  and  $h_2$  are empty, then  $\mathbf{s}(A_2) = f \star_1 \bar{f}$ . Thus  $\mathbf{p}(\mathbf{s}(A_2)) = 2\mathbf{s}(f) + 2\mathbf{t}(f) \leq 4\mathbf{s}(f) = 4\mathbf{s}(h)$ . Since  $\mathbf{s}(h) < u$ , using Lemma 6.5, we get that  $\mathbf{p}(\mathbf{s}(A_2)) < u$ . Applying the induction hypothesis to  $A_2$ , we get  $\mathbf{w}_\eta(A_2) < u$ . Moreover,  $\mathbf{w}_\eta(A) = \mathbf{w}_\eta(A_1) + \mathbf{w}_\eta(A_2) = \mathbf{s}(f) + \mathbf{w}(A_2)$ , and we showed that  $\mathbf{w}(A_2) < u$  and  $\mathbf{s}(f) = \mathbf{s}(h) < u$ . Thus according to Lemma 6.5, we get  $\mathbf{w}_\eta(A) < u$ .

Otherwise, suppose for example that  $h_1$  is not an identity (the case where  $h_2$  is not an identity being symmetrical). Then we have  $\mathbf{v}_{\mathbf{t}(h_1)}(\mathbf{p}(h_1)) > 0$ , so  $\mathbf{v}_{\mathbf{t}(h_1)}(\mathbf{p}(h)) > 0$ . Since  $\mathbf{p}(h) < u$ , we have by Lemma 6.5 that  $\mathbf{s}(f) = \mathbf{t}(h_1) < u$ . So  $\mathbf{p}(\mathbf{s}(A_2)) = \mathbf{p}(h_1) + \mathbf{p}(h_2) + 2\mathbf{s}(f) + 2\mathbf{t}(f) < \mathbf{p}(h) + 4\mathbf{s}(f) < u$ . By induction hypothesis, we thus have  $\mathbf{w}_\eta(A_2) < u$ , and finally  $\mathbf{w}_\eta(A) = \mathbf{s}(f) + \mathbf{w}_\eta(A_2) < u$ .

- Otherwise, we have on the one hand that  $\mathbf{w}_\eta(A_1) = 0$ , and on the other hand that  $\mathbf{s}(A_2) = \mathbf{t}(A_1) < \mathbf{s}(A_1) = h < u$  by Lemma 6.12. Thus  $\mathbf{w}_\eta(A) = \mathbf{w}_\eta(A_2) < u$ .

$\square$

**Lemma 6.18.** *Let  $(f_1, f_2, f_3)$  be a 3-fold local branching,  $u \in \mathcal{A}_1^*$ , and  $A, B \in \mathcal{F}_3^{\mathbf{w}}$  two 3-cells such that there exists a 4-cell:*

$$C_{f_1, f_3, f_2} : \bar{f}_1 \star_1 \eta_{f_3} \star_1 f_2 \star_2 (C_{f_1, f_3} \star_1 C_{f_3, f_2}) \star_2 A \rightarrow C_{f_1, f_2} \star_2 B.$$

Then  $\mathbf{w}_\eta(A), \mathbf{w}_\eta(B) < u$ .

*Proof.* Using Lemma 6.12, we have  $\mathbf{p}(\mathbf{t}(C_{f_1, f_2})), \mathbf{p}(\mathbf{t}(C_{f_2, f_3})), \mathbf{p}(\mathbf{t}(C_{f_1, f_3})) < u$ . So  $\mathbf{p}(\mathbf{s}(A)) = \mathbf{p}(\mathbf{t}(C_{f_1, f_2})) + \mathbf{p}(\mathbf{t}(C_{f_2, f_3})) < u$  et  $\mathbf{p}(\mathbf{s}(B)) = \mathbf{p}(\mathbf{t}(C_{f_1, f_3})) < u$ , and using 6.17, we get  $\mathbf{w}_\eta(A), \mathbf{w}_\eta(B) < u$   $\square$

### 6.3 Partial coherence of $\mathcal{F}^{\mathbf{w}(3)}$

**Proposition 6.19.** *For every 2-cell  $h \in \mathcal{F}_2^{\mathbf{w}}$  with source and target  $\hat{u}$  a normal form for  $A_2$ , and for every 3-cells  $A, B : h \Rightarrow 1_{\hat{u}} \in \mathcal{F}_3^{\mathbf{w}}$ , there exists a 4-cell  $\alpha : A \rightarrow B \in \mathcal{F}_4^{\mathbf{w}(3)}$ .*

*Proof.* We reason by induction on the couple  $(\mathbf{w}_\eta(A) + \mathbf{w}_\eta(B), \mathbf{p}(h))$ , using the lexicographic order. If  $h = 1_{\hat{u}}$ , then  $A = B = 1_h$ . Thus setting  $\alpha = 1_A = 1_B$  shows that the property is verified.

Suppose now that  $h$  is not an identity. Using Lemma 6.14, there exists a cavity-factorisation  $h = h_1 \star_1 \bar{f}_1 \star_1 f_2 \star_1 h_2$ . By Lemma 6.16, there exist  $A_1, A_2, B_1, B_2 \in \mathcal{F}_3^{\mathbf{w}}$ , such that  $A = (h_1 \star_1 A_1 \star_1 h_2) \star_2 A_2$  and  $B = (h_1 \star_1 B_1 \star_1 h_2) \star_2 B_2$ . Using this Lemma, we distinguish four case depending on the shape of  $A_1$  and  $A_2$ .

If  $A_1 = B_1 = C_{f_1, f_2}$ . Then in particular we have:

$$\mathbf{s}(A_2) = \mathbf{s}(B_2) \quad \mathbf{w}_\eta(A) = \mathbf{w}_\eta(A_2) \quad \mathbf{w}_\eta(B) = \mathbf{w}_\eta(B_2) \quad \mathbf{t}(A_1) < \mathbf{s}(A_1),$$

where the last inequality is a consequence of Lemma 6.12. Hence we get  $\mathbf{p}(\mathbf{s}(A_2)) = \mathbf{p}(h_1) + \mathbf{p}(\mathbf{t}(A_1)) + \mathbf{p}(h_2) < \mathbf{p}(h_1) + \mathbf{p}(\mathbf{s}(A_1)) + \mathbf{p}(h_2) = \mathbf{p}(h)$ , and finally  $(\mathbf{w}_\eta(A_2) + \mathbf{w}_\eta(B_2), \mathbf{p}(\mathbf{s}(A_2))) < (\mathbf{w}_\eta(A) + \mathbf{w}_\eta(B), \mathbf{p}(h))$ . Using the induction hypothesis there exists  $\alpha : A_2 \rightarrow B_2 \in \mathcal{F}_4^{\mathbf{w}(3)}$ , and by composition we construct  $A_1 \star_2 \alpha : A \rightarrow B$ .

If  $A_1 = \bar{f}_1 \star_1 \eta_{f_3} \star_1 f_2$  and  $B_1 = C_{f_1, f_2}$ . We are going to construct the following composite:

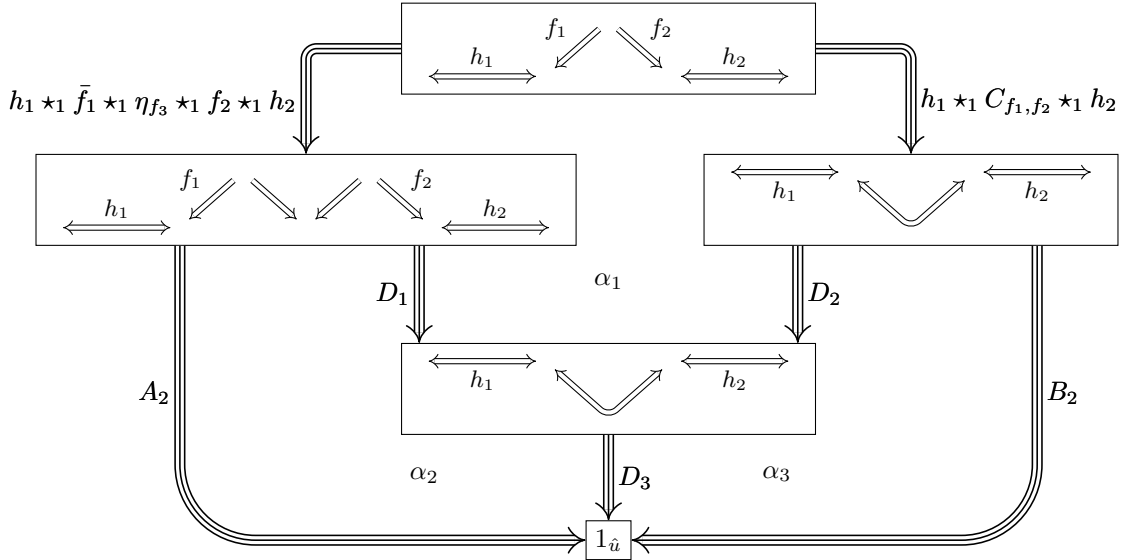

According to Lemma 6.3, there exists a 4-cell

$$C_{f_1, f_3, f_2} : \bar{f}_1 \star_1 \eta_{f_3} \star_1 f_2 \star_2 (C_{f_1, f_3} \star_1 C_{f_3, f_2}) \star_2 D'_1 \rightarrow C_{f_1, f_2} \star_2 D'_2,$$

with  $D'_1, D'_2 \in \mathcal{F}_4^{\mathbf{w}(3)}$ . Let us define  $D_1 := h_1 \star_1 (C_{f_1, f_3} \star_1 C_{f_3, f_2}) \star_2 D'_1 \star_1 h_2$ ,  $D_2 := h_1 \star_1 D'_2 \star_1 h_2$ , and  $\alpha_1 := h_1 \star_1 C_{f_1, f_3, f_2} \star_1 h_2$ . The existence of  $D_3$  is guaranteed by Lemma 6.15, which also proves that we can choose  $D_3$  such that  $\mathbf{w}_\eta(D_3) = 0$ .

In order to construct the 4-cells  $\alpha_1$  and  $\alpha_2$ , let us show that we can apply the induction hypothesis to the couples  $(A_2, D_1 \star_2 D_3)$  and  $(D_2 \star_2 D_3, B_2)$ . Let  $v$  be the common source of  $f_1$  and  $f_2$ .

- Using Lemma 6.18,  $\mathbf{w}_\eta(D_1 \star_2 D_3) = \mathbf{w}_\eta(D_1) = \mathbf{w}_\eta(D'_1) < v$ , and so:

$$\mathbf{w}_\eta(A_2) + \mathbf{w}_\eta(D_1 \star_2 D_3) < \mathbf{w}_\eta(A_2) + \mathbf{w}(\eta_3) = \mathbf{w}_\eta(A) \leq \mathbf{w}_\eta(A) + \mathbf{w}_\eta(B).$$

- As previously  $\mathbf{w}_\eta(D_2 \star_2 D_3) = \mathbf{w}_\eta(D_2) = \mathbf{w}_\eta(D'_2) < v$ , and so:

$$\mathbf{w}_\eta(B_2) + \mathbf{w}_\eta(D_2 \star_2 D_3) < \mathbf{w}_\eta(B_2) + \mathbf{w}_\eta(\eta_3) \leq \mathbf{w}_\eta(B) + \mathbf{w}_\eta(A).$$

If  $A_1 = C_{f_1, f_2}$  and  $B_1 = \bar{f}_1 \star_1 \eta_{f_3} \star_1 f_2$ . This case is similar to the previous one, only using  $C_{f_1, f_3, f_2}^{-1}$  rather than  $C_{f_1, f_3, f_2}$ .

If  $A_1 = \bar{f}_1 \star_1 \eta_{f_3} \star_1 f_2$  and  $B_1 = \bar{f}_1 \star_1 \eta_{f_4} \star_1 f_2$ . We are going to construct the following composite:

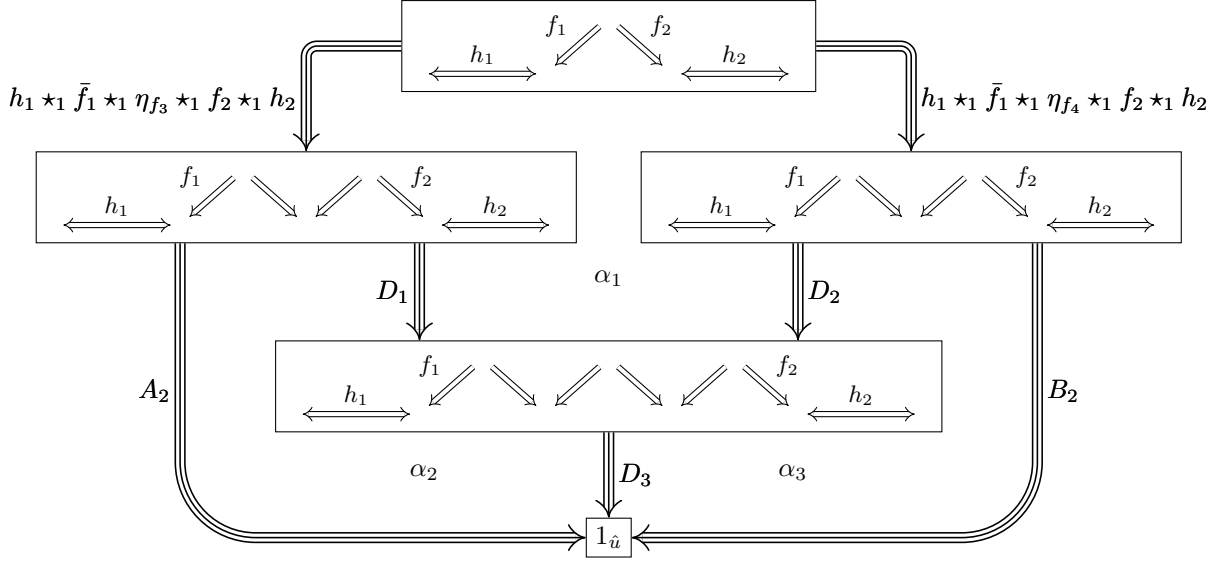

Let us set

$$D_1 := h_1 \star_1 \bar{f}_1 \star_1 f_3 \star_1 \bar{f}_3 \star_1 \eta_{f_4} \star_1 f_2 \star_1 h_2$$

$$D_2 := h_1 \star_1 \bar{f}_1 \star_1 \eta_{f_3} \star_1 f_4 \star_1 \bar{f}_4 \star_1 f_2 \star_1 h_2.$$

We then have

$$(h_1 \star_1 A_1 \star_1 h_2) \star_2 D_1 = h_1 \star_1 \bar{f}_1 \star_1 \eta_{f_3} \star_1 \eta_{f_4} \star_1 f_2 \star_1 h_2 = (h_1 \star_1 B_1 \star_1 h_2) \star_2 D_2.$$

Hence we define  $\alpha_1$  as an identity. Let now  $D_3$  be as in Lemma 6.15, with  $\mathbf{w}_\eta(D_3) = 0$ , and  $v$  be the common source of  $f_1, f_2, f_3$  and  $f_4$ . We then have the inequalities:

$$\mathbf{w}_\eta(A_2) + \mathbf{w}_\eta(D_1) + \mathbf{w}_\eta(D_3) = \mathbf{w}_\eta(A_2) + v < \mathbf{w}_\eta(A_2) + \mathbf{w}_\eta(B_2) + 2v = \mathbf{w}_\eta(A) + \mathbf{w}_\eta(B),$$

$$\mathbf{w}_\eta(B_2) + \mathbf{w}_\eta(D_2) + \mathbf{w}_\eta(D_3) = \mathbf{w}_\eta(B_2) + v < \mathbf{w}_\eta(B_2) + \mathbf{w}_\eta(A_2) + 2v = \mathbf{w}_\eta(A) + \mathbf{w}_\eta(B).$$

Hence we can apply the induction hypothesis to the couples  $(A_2, D_1 \star_2 D_3)$  and  $(D_2 \star_2 D_3, B_2)$ , which provides  $\alpha_2$  and  $\alpha_3$ .  $\square$

**Proposition 6.20.** *The  $(4, 3)$ -white-category  $\mathcal{F}^{\mathbf{w}(3)}$  is  $S_\mathcal{E}$ -coherent.*

*Proof.* Let  $A, B : f \rightrightarrows h \in \mathcal{F}_3^{\mathbf{w}}$  whose 1-target is a normal form  $\hat{u}$ , with  $f, g \in \mathcal{B}_2^{\mathbf{w}}$ .

The 3-cells  $(\bar{h} \star_1 A) \star_2 \epsilon_h$  and  $(\bar{h} \star_1 B) \star_2 \epsilon_h$  are parallel, and their target is  $1_{\hat{u}}$ . In particular they verify the hypothesis of Proposition 6.19. So there exists  $\alpha : (\bar{h} \star_1 A) \star_2 \epsilon_h \rightarrow (\bar{h} \star_1 B) \star_2 \epsilon_h$ . Then the following composite is the required cell from  $A$  to  $B$ :



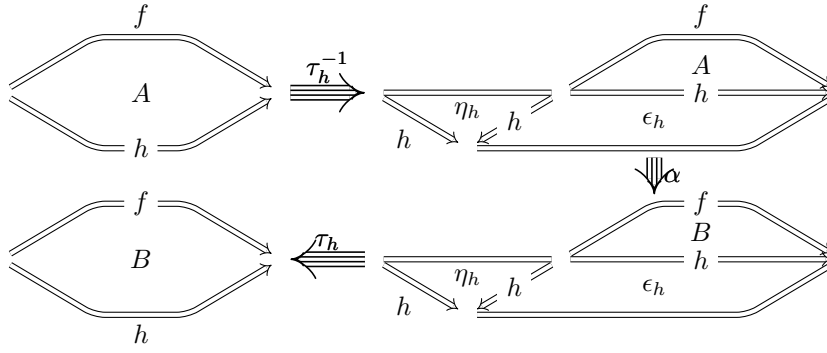

□

We can now complete the proof of Theorem 1.27. Indeed we showed that  $\mathcal{F}^{\mathbf{w}(3)}$  is  $S_{\mathcal{E}}$ -coherent. Using Proposition 4.29, that means that  $\mathcal{E}^{\mathbf{w}(3)}$  is  $S_{\mathcal{E}}$ -coherent, and finally using Lemma 4.23 that  $\mathcal{A}^{*(2)}$  is  $S_{\mathcal{A}}$ -coherent, that is that for every 3-cells  $A, B \in \mathcal{A}_3^{*(2)}$ , there exists a 4-cell  $\alpha : A \rightarrow B \in \mathcal{A}_4^{*(2)}$ .

## References

- [1] Franz Baader and Tobias Nipkow. *Term rewriting and all that*. Cambridge university press, 1999.
- [2] Jean Bénabou. Introduction to bicategories. In *Reports of the Midwest Category Seminar*, pages 1–77. Springer, 1967.
- [3] Albert Burroni. Higher-dimensional word problems with applications to equational logic. *Theoretical computer science*, 115(1):43–62, 1993.
- [4] Patrick Dehornoy. The subword reversing method. *International Journal of Algebra and Computation*, 21(1-2):71–118, 2011.
- [5] Stéphane Gaussent, Yves Guiraud, and Philippe Malbos. Coherent presentations of artin monoids. *Compositio Mathematica*, 151(05):957–998, 2015.
- [6] Yves Guiraud and Philippe Malbos. Higher-dimensional categories with finite derivation type. *Theory and Applications of Categories*, 22(18):420–478, 2009.
- [7] Yves Guiraud and Philippe Malbos. Coherence in monoidal track categories. *Mathematical Structures in Computer Science*, 22(06):931–969, 2012.
- [8] Yves Guiraud and Philippe Malbos. Higher-dimensional normalisation strategies for acyclicity. *Advances in Mathematics*, 231(3):2294–2351, 2012.
- [9] Gregory Maxwell. Kelly. Coherence theorems for lax algebras and for distributive laws. In *Category seminar*, pages 281–375. Springer, 1974.
- [10] Gregory Maxwell. Kelly and Saunders MacLane. Closed coherence for a natural transformation. In *Coherence in categories*, pages 1–28. Lecture Notes in Math., Vol. 281. Springer, Berlin, 1972.
- [11] Saunders Mac Lane. Natural associativity and commutativity. *Rice University Studies*, 49(4):28–46, 1963.
- [12] Saunders Mac Lane and Robert Paré. Coherence for bicategories and indexed categories. *Journal of Pure and Applied Algebra*, 37(1):59–80, 1985.
- [13] François Métayer. Cofibrant objects among higher-dimensional categories. *Homology, Homotopy and Applications*, 10(1):181–203, 2008.
- [14] Anthony Power. A general coherence result. *Journal of Pure and Applied Algebra*, 57(2):165–173, 1989.
- [15] Craig C. Squier, Friedrich Otto, and Yuji Kobayashi. A finiteness condition for rewriting systems. *Theoretical Computer Science*, 131(2):271–294, 1994.
- [16] Ross Street. Limits indexed by category-valued 2-functors. *Journal of Pure and Applied Algebra*, 8(2):149–181, 1976.
- [17] Ross Street. The algebra of oriented simplexes. *Journal of Pure and Applied Algebra*, 49(3):283–335, 1987.
- [18] Ross Street. Categorical structures. *Handbook of algebra*, 1:529–577, 1996.