



HAL
open science

Effective Limb Transduction and Phenotypic Correction after Injection of rAAV8-U7 snRNA in GRMD Dogs

Caroline Le Guiner, Marie Montus, Laurent Servais, Luis Garcia, Yves Fromes,
Jean-Yves Hogrel, Pierre Carlier, Yan Cherel, Philippe Moullier, Thomas Voit

► To cite this version:

Caroline Le Guiner, Marie Montus, Laurent Servais, Luis Garcia, Yves Fromes, et al.. Effective Limb Transduction and Phenotypic Correction after Injection of rAAV8-U7 snRNA in GRMD Dogs. ASGCT Translational Science Training Course, American Society of Cell and Gene Therapy (ASGCT). USA., Mar 2011, Seattle, United States. pp.332. hal-01191233

HAL Id: hal-01191233

<https://hal.science/hal-01191233>

Submitted on 3 Jun 2020

HAL is a multi-disciplinary open access archive for the deposit and dissemination of scientific research documents, whether they are published or not. The documents may come from teaching and research institutions in France or abroad, or from public or private research centers.

L'archive ouverte pluridisciplinaire **HAL**, est destinée au dépôt et à la diffusion de documents scientifiques de niveau recherche, publiés ou non, émanant des établissements d'enseignement et de recherche français ou étrangers, des laboratoires publics ou privés.

Adenovirus and Other DNA Virus Vectors I: Virus Entry

1. Retargeting Parvovirus B19 to HER2/neu-Positive Cells for Breast Cancer Treatment

Harald G. P. Messer,^{1,2} Yiwen Xiang,¹ Mavis Agbandje-McKenna,² Kirsten A. K. Weigel-Van Aken.¹

¹Pediatrics, University of Florida, Gainesville, FL; ²Biochemistry and Molecular Biology, University of Florida, Gainesville, FL.

Human epidermal growth factor receptor 2 (HER2), which is over-expressed in breast cancers, is associated with poor differentiation, high rates of proliferation, lymph node involvement, resistance to certain types of chemotherapy, and poor prognosis. A humanized anti-HER2 monoclonal antibody, rhu 4D5 (trastuzumab, Herceptin®), has been developed and tested in clinical trials for breast cancer treatment. It was shown to bind to cell surface-expressed HER2, inhibit HER2 kinase activity, down-modulate HER2, and sensitize tumor cells to apoptosis when used in conjunction with radiation or chemotherapy. Previously, an anti-HER2/neu-binding peptidomimetic (AHNP), derived from the structure of Herceptin's CDR-H3 loop has been developed to avoid side effects associated with whole antibody treatments and efficient HER2 interaction was demonstrated in vitro, albeit with reduced HER2 down-modulation. Parvovirus B19 (B19), a small ssDNA-containing virus, is restricted in its replication to erythroid progenitor cells in the human bone marrow. The virus binds to these cells through interactions with the blood group P antigen (globoside), and uses activated $\alpha 5 \beta 1$ integrin and Ku80 co-receptors for entry. We thus rationalized that due to its bone marrow tropism, B19 could be an attractive candidate for targeted gene delivery therapies to bone marrow-resident cells, such as metastatic HER2-positive, breast cancer cells, particularly if its primary cellular receptor binding site is replaced by the HER2 cancer cell-targeting peptide, AHNP. We have replaced the endogenous P antigen binding site on the capsid surface of B19 with the AHNP peptide and demonstrate retargeting of chimeric vectors to HER2-positive tumor cells. Structural modeling was used to aid the design of chimeric AHNP-B19 VP2 vectors based on the crystal structures of the B19 capsid VP2 and the CDR-H3 loop of rhu 4D5. Comparative transduction studies with the wt B19 VP2 (wt capsid-B19-scGFP) and AHNP-VP2 (AHNP-B19-scGFP) vectors in murine MMTV-HER2/neu mammary tumor epithelial and human medulloblastoma cells showed significant enhancement in transduction of HER2-overexpressing cells with the AHNP-B19-scGFP vector compared to wt capsid-B19-scGFP vector. This transduction improvement was significantly reduced following exposure to a HER2 kinase domain-derived peptide that interfered with tyrosine 1248 phosphorylation of the receptor, indicating that HER2 kinase activity is required for AHNP-B19-scGFP vector entry. On the contrary, preincubation of AHNP-B19-scGFP virions with P antigen had no effect on transduction efficiency, corroborating the successful replacement of the P antigen binding epitope on B19 capsids and introduction of binding to HER2 as the receptor. Importantly, HER2-binding AHNP-B19 vectors still used $\beta 1$ integrins as co-receptors for infection. This novel engineered vector serves as a promising vehicle for the targeted delivery of cytotoxic transgenes to HER2-positive metastatic cancer cells for the eradication of dormant breast cancer cells in niches, such as the bone marrow, which are highly intractable to most treatment strategies.

2. Identification of the Receptor for Adenovirus Serotypes 3, 7, 11, and 14: Structural Analysis of Adenovirus – Receptor Interaction

Hongjie Wang,¹ ZongYi Li,¹ Jonas Persson,¹ Ines Beyer,¹ Robert Strauss,¹ Akseli Hemminki,² Pascal Fender,³ Andre Lieber.¹

¹Division of Medical Genetics, University of Washington, Seattle, WA; ²Cancer Gene Therapy Group, University of Helsinki & Helsinki University Central Hospital, Helsinki, Finland; ³Unit of Virus Host Cell Interactions, EMBL, Grenoble, France.

Human adenoviruses (Ads) have been classified into six species (A to F) currently containing 55 serotypes. Most Ad serotypes utilize the coxsackie-adenovirus-receptor (CAR) as a primary attachment receptor. Group 1 of species B Ads (Ad16, 21, 35, 50) nearly exclusively utilize CD46 as a receptor; Group 2 (Ad3, Ad7, 14) share a common, unidentified receptor/s, which is not CD46 and which was tentatively named receptor X; Group 3 (Ad11) preferentially interacts with CD46, but also utilizes receptor X if CD46 is blocked. Recently, using Ad3 virions and recombinant Ad3 PtDds as a probe for receptor X, we identified Desmoglein 2 (DSG2) as a high-affinity receptor for AdB-2/3 serotypes. Loss- and gain-of function studies were then performed on cell lines to validate DSG2 as a crucial receptor for Ad binding and infection. First structural studies of Ad3-DSG2 interaction were performed. Ad3 binding involved the third and fourth extracellular domain of DSG2. Competition and surface plasmon resonance studies demonstrated that the DSG2 interacting domain(s) within Ad3 are formed by the fiber only in the spatial constellation that is present in viral particles. This clearly widens our understanding of Ad attachment mechanisms, which, so far, were thought to involve only a high affinity interaction between the fiber knob and the cellular receptor, i.e. CAR or CD46. Chimeric Ad5 vectors with Ad3 fibers also bound to DSG2 indicating that the only function of penton is to constrain Ad3 fibers as multimers. We then generated a series of N-terminal His-tagged Ad3 fiber knob protein containing different numbers of shaft repeats, and found that all these fiber proteins were unable to efficiently block Ad3 infection. However, cross-linking of fibers with anti-His antibodies increased the blocking efficiency significantly. To further investigate if dimerization is required, K-coil and E-coil heterodimerization domains were included into Ad3 fiber proteins. CryoEM and Biacore studies showed fiber dimerization/multimerization. Ad3 fiber dimers efficiently and specifically blocked Ad3 infection. Incubation of epithelial cells with Ad3 dimers triggered the same DSG2-mediated opening of epithelial junctions as seen with Ad3 particles.

3. Multi-Year Transgene Expression in Nonhuman Primates Following Hepatic Transduction with Helper-Dependent Adenoviral Vectors

Nicola Brunetti-Pierri,¹ Gary Stapleton,² Thomas Ng,³ David Iannitti,³ William Cioffi,³ Mark Law,² John Breinholt,² Donna Palmer,⁴ Nathan Grove,⁴ Milton Finegold,⁵ Arthur Beaudet,⁴ Charles Mullins,² Philip Ng.⁴

¹Telethon Institute of Genetics and Medicine, Naples, Italy; ²Cardiology, Baylor College of Medicine, Houston, TX; ³Surgery, Brown Medical School, Providence, RI; ⁴Molecular and Human Genetics, Baylor College of Medicine, Houston, TX; ⁵Pathology, Baylor College of Medicine, Houston, TX.

Helper-dependent adenoviral (HDAd) vectors hold tremendous potential for liver-directed gene therapy because they mediate long-term transgene expression without chronic toxicity. One obstacle to clinical application of HDAd is that high and thus potentially toxic doses are required to achieve efficient hepatocyte transduction due, in part, to extrahepatic vector uptake. We previously addressed this obstacle by developing 3 vector delivery methods in baboons to permit

preferential hepatocyte transduction by minimizing extrahepatic vector uptake. Method 1 involved HDAd injection directly into the surgically isolated liver via the portal vein (PMID16610927). Method 2 mimics hydrodynamic injection and was based on our observation that hydrodynamic injection in mice resulted in preferential hepatocyte transduction and reduced extrahepatic vector uptake (PMID17285138). Method 3 involved inflating a balloon occlusion catheter in the inferior vena cava to occlude hepatic venous outflow followed by vector injection directly into the occluded liver via the hepatic artery (PMID 19050700). These methods significantly improved hepatocyte transduction, up to 80-fold, compared to systemic injection, thus permitting high level transgene expression using low sub-toxic doses. Although achieving high level transgene expression using low vector doses is important, equally important for risk:benefit assessment and successful gene therapy is the duration of transgene expression. Thus, in this study, we provide an update on the duration of transgene expression following delivery of HDAd expressing the reporter alpha-fetoprotein (AFP) by the 3 aforementioned methods. Our results revealed that all 3 methods resulted in sustained transgene expression to date. Specifically, HDAd injected into baboons (n=3) by Method 1 resulted in up to 6.7 years of transgene expression. Method 2 (n=2) resulted in at least 6 years of transgene expression. Method 3 (n=7) resulted in up to 4.6 years of transgene expression. In all cases, transgene expression declines over time but with a very slow rate.

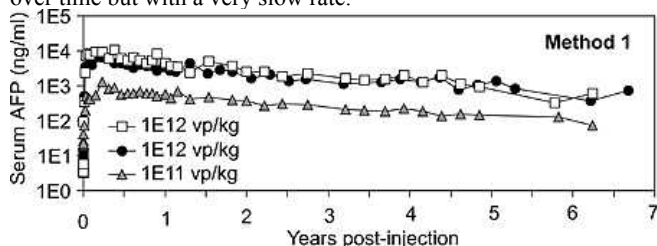

No chronic toxicity has been observed in any animal. These unprecedented results clearly demonstrate strong multi-year transgene expression in nonhuman primates following a single administration of HDAd and support their potential long-term efficacy in clinical trials.

4. The Refinement of the Molecular Model of Adenovirus Binding to Blood Coagulation Factors and the Role of This Interaction in Virus Recognition by the Host

Konstantin Doronin,¹ Justin Flatt,² Steffen Lindert,^{2,3} Dewight R. Williams,² Phoebe L. Stewart,² Dmitry M. Shayakhmetov.¹
¹Division of Medical Genetics, Department of Medicine, University of Washington, Seattle, WA; ²Department of Molecular Physiology and Biophysics, Vanderbilt University School of Medicine, Nashville, TN; ³Department of Molecular Physiology and Biophysics, Vanderbilt University School of Medicine, Nashville, TN.

Viral vectors based on human adenovirus serotype 5 (Ad5) are highly efficient tools in gene transfer studies both in vitro and in vivo. However, upon intravascular administration in mice, the bulk of the virus particles is trapped in the liver, leading to clinically significant hepatotoxicity. Ad5 hexon was recently shown to be the principal capsid protein mediating virus entry into hepatocytes via interaction with vitamin K-dependent blood coagulation factors, including FX, FVII, or FIX. These factors form the bridge between Ad virion surface and heparan sulfate proteoglycans at the hepatocyte plasma membrane. Using cryo-electron microscopy, in this study, we determined the structure of Ad5 in complex with human blood factors VII and X at a subnanometer (<10Å) resolution. Both Ad5/factor structures show density for the Gla domain of the factor interacting

with the surface loops of hexons in the virus capsid. Modeling of the interaction between the coagulation factor Gla domain and virus hexon indicates that the predicted TET amino acid sequence in the hexon hyper-variable loop 7 (HVR7) is an important site for this interaction. The structure and modeling results also offer a possible explanation for the lower affinity of factor VII (5nM) compared to that of factor X (200pM) for Ad5. Furthermore, we constructed a set of Ad5 vectors possessing single amino acid substitutions in the HVR7 of the hexon protein. The biological properties of hexon-mutated vectors are currently being analyzed both in vitro and in vivo. Our studies are critical for refining the molecular model of blood coagulation factor interaction with Ad5-based vectors and will aid in defining the functional role of this interaction for adenovirus recognition by the innate immunity of the host.

5. Suppression of Protein Phosphatase 2A Activity Enhances Ad5/F35 Adenovirus Transduction Efficiency in Human Normal B Lymphocytes and Cell Lines

Marie-Pierre Cayer,¹ Mélanie Samson,^{1,2} Claudia Bertrand,^{1,2} Nellie Dumont,¹ Mathieu Drouin,¹ Daniel Jung.^{1,2}
¹Department of Cell Engineering, Héma-Québec, Québec, QC, Canada; ²Department of Biochemistry and Microbiology, Laval University, Québec, QC, Canada.

Adenoviral vectors have the particularity of efficiently and rapidly transduce both proliferating and quiescent cells and do not integrate into the host genome, allowing a reproducible gene expression level. We previously demonstrated that adenoviral vector Ad5/F35, which utilizes the ubiquitous CD46 as cellular receptor, displays differences in transduction efficiency between normal human B lymphocytes and B lymphocytes cell lines as determined by EYFP expression. We have observed that normal B lymphocytes were poorly transduced compared to some B lymphocytes cell lines with less than 50% EYFP+ cells, despite the fact that these cells express a similar level of CD46. In contrast normal plasma cells or plasma cell lines were easily transduced by Ad5/F35 with a rate of up to 95% EYFP+ cells. Here to further investigate the differences in transduction efficiency we analyzed intracellular trafficking of Ad5/F35 labelled with CY3 and fluorescently tagged endocytic markers by confocal microscopy. We demonstrated that Ad5/F35 failed to escape early endosomes and were redirected to recycling vesicles or late endosomes and lysosomes in B lymphocytes whereas in plasma cell lines Ad5/F35 easily escaped early endosomes to migrate toward the nucleus. Since phosphatases are well known to influence endocytosis and intracellular trafficking, B lymphocytes were treated with phosphatase inhibitors specific for PP1 or PP2A, prior adenoviral infection. Inhibition of PP1 by Tautomycin or PP2B by cyclosporine A had no effects on adenoviral transduction efficiency whereas inhibition of PP2A with Cantharidin or PP1 and PP2A with Okadaic acid substantially increase transduction efficiency. Moreover, inhibition of PP2A results in a rapid increase of AKT, ERK1/2 and MEK1/2 phosphorylation. Importantly, confocal microscopy analyses revealed that inhibition of PP2A abolishes the recycling of adenovirus and enhances their escape from early endosome to the nucleus. Finally, no increase of adenoviral entry was observed following PP2A inhibition. Our results are in accord with reports indicating that PP2A is involved in the formation of recycling vesicles and may improve gene transfer in the context of gene therapy.

6. Basic Residues in the Heparin-Binding Exosite of the Factor X Serine Protease Domain Mediate Ad5/FX Complex Binding to Hepatocytes

Margaret R. Duffy,¹ Angela C. Bradshaw,¹ John H. McVey,² Alan L. Parker,¹ Andrew H. Baker.¹

¹BHF Glasgow Cardiovascular Research Centre, University of Glasgow, Glasgow, United Kingdom; ²Thrombosis Research Institute, Emmanuel Kaye Building, Manresa Road, London, United Kingdom.

Recent evidence shows that hepatocyte transduction by adenovirus 5 (Ad5) is mediated by a high affinity interaction between coagulation factor X (FX) and the Ad5 hexon proteins. Whilst the FX gamma-carboxylated glutamic acid (Gla) domain mediates binding with the Ad5 capsid, the FX serine protease (SP) domain bridges the Ad5/FX complex to the hepatocyte surface through an interaction with heparan sulfate proteoglycan receptors (HSPGs). Pharmacological blockade of the heparin-binding exosite in the serine protease domain of FX prevents cell binding and gene transfer mediated through FX¹. Previous studies have indicated that the residues Arg-93, Lys-96, Arg-125, Arg-165, Lys-169, Lys-236 and Arg-240 (chymotrypsin numbering system) of FX constitute this exosite². The aim of this study was to identify the specific residues in the SP domain of FX which mediate Ad5 attachment to HSPGs. We therefore generated a FX mutant construct (SP rFX) to assess the importance of this exosite. A human FX plasmid construct with a preprothrombin propeptide (to enhance gamma carboxylation³) was generated. Site directed mutagenesis was carried out at all seven basic residues in the FX SP domain and confirmed by sequence analysis. Stable cell lines were generated to constitutively produce the wildtype and mutant recombinant FX in the presence of vitamin K. The rFX generated was biologically active and had the predicted molecular weight. Enzyme-linked immunosorbent assay was used to quantify rFX production. Surface plasmon resonance analysis showed the SP mutations had no effect on rFX binding to the Ad5 hexon, as was expected, thus any effect on gene transfer was as a result of inefficient cell binding. *In vitro* assays in both low and high CAR expressing cell lines demonstrated that the exosite mutations blocked the ability of FX to enhance cell surface binding ($1.75 \pm 0.25 \times 10^4$ SP mutant rFX vs. $10.28 \pm 0.276 \times 10^4$ WT rFX vector genomes, $p < 0.01$) and transduction ($4.12 \pm 0.23 \times 10^4$ SP mutant rFX vs. $37.3 \pm 2.72 \times 10^4$ WT rFX RLU/mg of protein, $p < 0.01$) of Ad5 thus confirming the importance of this exosite in HSPG engagement. These results show that modification of the heparin-binding exosite of the FX serine protease domain ablates HSPG engagement by Ad5/FX complexes. [1] Waddington 2008 *Cell* **132**, 397-409. [2] Rezaie 2000 *JBC* **132**, 3320-3327. [3] Camire 2000 *Biochemistry* **39**, 14322-14329

7. GSK3beta-Mediated Regulation of the Coxsackie-Adenovirus Receptor Influences Adenovirus Infection

Priyanka Sharma,¹ Kathleen Frondorf,¹ Katherine J. D. A. Excoffon.¹

¹Biological Sciences, Wright State University, Dayton, OH.

Viruses strike a fine balance as both pathogens and important medical resources for genetic and immunological interventions. Adenovirus is both an emerging pathogen and a viral vector currently in clinical trials. One major limitation for adenovirus as a vector is that the coxsackievirus and adenovirus receptor (CAR) is primarily hidden on the basolateral surface of polarized epithelia. We have discovered an alternative CAR isoform (CAR-Ex8) that appears on the apical surface of human airway epithelia. This finding provides the opportunity to directly alter viral susceptibility by either increasing or decreasing CAR-Ex8 expression. Glycogen synthase kinase 3 beta (GSK3 β) is a central target of several signaling pathways, including the Wnt, Akt,

and MAPK pathways, and a gate-keeper to transcriptional changes that dictate numerous cellular pathways important for cell differentiation, proliferation, apoptosis, and development. Sequence analysis of CAR-Ex8 has revealed a series of potential GSK3 β consensus sites. Additionally, the promoter for the CAR gene (CXADR) is known to be regulated by transcription factors that are GSK3 β regulated. Thus, we hypothesize that CAR-Ex8 expression and localization are regulated by GSK3 β . Treatment of Madin-Darby canine kidney cells (MDCK) with GSK3 β inhibitors increased the expression of CAR-Ex8 specific mRNA, as measured by quantitative RT-PCR, protein levels, measured by Western blot, and altered the localization of CAR-Ex8, as observed by immunohistochemistry in polarized cells. Treatment with GSK3 β inhibitors also increased adenovirus infection of MDCK cells, suggesting that the levels of CAR are critical for adenovirus susceptibility. Therapeutic interventions that transiently augment or decrease CAR expression to enhance adenoviral-mediated gene therapy or protect susceptible populations from viral infections, respectively, will enhance our ability to treat or prevent a variety of diseases and may change our view of viral infections. Moreover, with GSK3 β modulating molecules in clinical trials for conditions such as Alzheimer's disease and diabetes mellitus, it is important to consider how these molecules may affect viral infection and the health of patients they are meant to treat.

8. Mining the Adeno-"Virome" for Effective Oncolytics Against Solid Tumors and Leukemias

Chris Y. Chen,¹ Julien S. Senac,² Eric A. Weaver,¹ Reeti Khare,³ Shannon M. May,¹ Michael A. Barry.⁴

¹Infectious Disease, Mayo Clinic, Rochester, MN; ²Organic Acid Research, National Human Genome Research Institute, Bethesda, MD; ³Virology and Gene Therapy, Mayo Clinic, Rochester, MN; ⁴Infectious Disease, Molecular Medicine, Mayo Clinic, Rochester, MN.

Adenovirus serotype 5 (Ad5) has demonstrated oncolytic potential in a number of human tumor xenografts. Unfortunately, 25-100% of people from various world populations have pre-existing immunity to Ad5 which would compromise the efficacy of Ad5 in the clinic. To look for a less seroprevalent alternative to Ad5, 12 other lower seroprevalence human adenoviruses from species B, C, D, and E were tested for efficacy against an array of solid tumor cell lines, B-cell cancer cell lines, and primary cells from cancer patients. These viruses were also tested *in vivo* in both immunodeficient mice and immunocompetent Syrian hamster tumor models. Against solid tumors, species C Ad6 and species B Ad11 performed similarly to Ad5. Because Ad6 and Ad11 are less seroprevalent than Ad5, these data suggest they may be more viable options against solid tumors. Species D adenoviruses consistently killed B-cell cancers more effectively than other Ad species while sparing non-malignant patient cells. When tested *in vivo* in mouse xenografts of human lymphoma RL, species D viruses also delayed tumor growth after single intratumoral injection. These data suggest species D adenoviruses may hold promise for clinical translation against B cell cancers.

DNA Vectorology

9. Chromatin Structure Effects on Integration of Gammaretroviruses MLV and XMRV

Shoshannah L. Roth,¹ Nirav Malani,¹ Troy Brady,¹ Charles Berry,² Frederic Bushman.¹

¹Microbiology, University of Pennsylvania, Philadelphia, PA;

²Department of Family/Preventive Medicine, University of California, San Diego School of Medicine, San Diego, CA.

The use of gammaretroviruses as vectors in gene therapy trials has led to adverse events, increasing interest in the mechanism

behind gammaretrovirus integration site selection. Early studies suggested that open chromatin might be favorable for integration by MLV, and recent deep sequencing experiments show that MLV favors integration near DNaseI hypersensitive sites in chromatin. For HIV, previous reports indicate that outward-facing major grooves of DNA in nucleosomes are a favored site of HIV integration in primary human T cells, suggesting that integration *in vivo* is taking place on nucleosome-wrapped target DNA. In this study we assessed nucleosome wrapping of target DNA during gammaretroviral integration. We infected primary human CD4⁺ T lymphocytes with two gammaretroviruses, an MLV-based retroviral vector or xenotropic murine leukemia virus-related virus (XMRV). Human T-cells were chosen for study because particularly deep annotation is available for epigenetic modifications and chromatin-bound proteins. We isolated integration sites with ligation-mediated PCR and analyzed the products with 454 pyrosequencing, yielding 47,758 unique integration sites. We correlated gammaretrovirus integration sites to mapped epigenetic features including histone modifications and chromatin bound proteins, and employed nucleosome prediction software to predict nucleosome positions surrounding the recovered gammaretrovirus integration sites. This analysis showed that gammaretroviruses integrate in a defined pattern on outward-facing major grooves on nucleosomes, similar to the integration pattern of HIV. This result is surprising, indicating that favored integration near DNaseI hypersensitive sites does not restrict integration to nucleosome free regions. Further, the pattern of favored integration near sites of bound proteins and histone modification implies that gammaretrovirus integration may be guided by tethering interactions with chromatin components.

10. Elimination of Gene Targeted Chromosome in Trisomic Cells

Li Li,¹ Kai-Hsin Chang,¹ Roli Hirata,¹ Gaoying Ren,¹ Andy Herman,¹ Thalia Papayannopoulou,¹ David Russell.¹

¹Hematology, University of Washington, Medical Center, Seattle, WA.

Trisomy, three copies of particular chromosomes, is caused by non-disjunction during cell division and causes genetic abnormalities, such as Down syndrome (trisomy 21). In cell culture, trisomy 12 and 17 exist among pluripotent stem cells and compromise the use of these stem cells in research and therapy. Yet, no method has been described to remove the extra chromosome from trisomic cells. We hypothesize that a spontaneous mitotic non-disjunction event that happens to a trisomic 21 chromosome during cell division will produce a tetrasomic and a disomic daughter cell. The disomic cells could be selected via negative selection, if one of the trisomic chromosomes is first engineered to contain a negative selection marker. Down syndrome fibroblasts were transduced with lentiviral vectors carrying *NANOG*, *SOX2*, *OCT4* and *LIN28* and several independent iPSC clones were generated. Karyotyping showed that 47, XX, +21 lines were established. A positive-negative selection marker was then introduced into one copy of chromosome 21 at the amyloid precursor protein (*APP*) locus in trisomic 21 iPSC cells by AAV-mediated gene targeting, a homologous recombination process that we have shown works efficiently in human pluripotent stem cells. The selection marker, a fusion of the herpesvirus thymidine kinase (TK) and neomycin resistance genes allowed us to use G418 resistance for positive selection and GCV (ganciclovir) resistance for negative selection. The AAV vector was a promoter trap design with an IRES element and the selection marker flanked by 5' and 3' homology arms respectively.

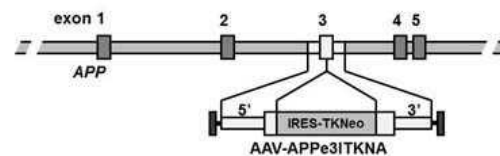

Figure 1. *APP* locus and AAV-APPE3ITKNA vector used for targeting experiments.

Three different trisomic 21 iPSC clones were infected with AAV to produce 0.11% to 0.24% G418-resistant cells, 80% of which were targeted at *APP* based on Southern blots. These targeted cells were then cultured in GCV to select for loss of the TK gene. Approximately $1-4 \times 10^{-4}$ of total cells became GCV-resistant, and 50% to 90% of these clones had lost the targeted chromosome 21. Cytogenetic analysis confirmed that these cells had reverted to a normal karyotype. A comparison of the hematopoietic differentiation of these iPSCs showed that the trisomic 21 iPSCs had the expected increased hematopoietic potential, which was lost upon conversion to disomy.

Table. Disomic 21 cells arising from trisomic 21 iPSCs

Targeted Tri21 iPSC	Total CFU plated	GCV ^R Foci	Frequency of GCV ^R colonies	Di21/GCV ^R colonies
C1-1	158,400	13	8×10^{-5}	50%
C2-1	15,000	5	3.3×10^{-4}	60%
C3-1	48,000	21	4.4×10^{-4}	90%

These corrected iPSC cells may prove useful for treating Down syndrome-related leukemias by autologous hematopoietic cell transplantation with the hematopoietic progeny of disomic iPSCs. Moreover, our method could be employed to repair other types of chromosome trisomy as well, and we will present the results of ongoing experiments to remove trisomy 17 from pluripotent stem cells.

11. Towards Eliciting the Mechanism of Plasmid DNA Silencing *In Vivo*

Jiamiao Lu,¹ Mark Kay.¹

¹Department of Pediatrics and Genetics, Stanford University, Stanford, CA.

A major disadvantage that holds up the usage of non-viral plasmid vectors for human gene therapy is the short duration of therapeutic transgene expression. Standard plasmid DNA transfection into mouse liver results in an initial high level of transgene expression but is slowly silenced beginning several days later. Our lab has demonstrated that minicircle DNA vectors devoid of the plasmid DNA backbone (BB) persistently expresses the therapeutic transgene at 10 to 1000 times that of the same expression cassette in routine plasmid *in vivo* even though the amount of transfected plasmid or minicircle DNA remaining in the liver is the same (Cheng et al. 2003 Journal). Furthermore our studies have shown that covalent attachment of the plasmid BB to the expression cassette is required for plasmid DNA silencing (Zhi-ying Cheng et al. 2003). While histone modifications are associated with the persistence of minicircle-directed transgene expression (Riu et al. 2007 Mol Therapy), the enriched CpG content in bacterial plasmid DNA and CpG methylation status of the BB DNA did not influence transgene silencing (Chen et al., Mol Therapy 2008). We hypothesized that perhaps the distance between the promoter and poly adenylation site and not the plasmid BB DNA itself was responsible for silencing. Thus, we replaced the bacterial plasmid DNA sequences with varied non-bacterial non-coding sequences and tested these new constructs for transgene expression in mice. Two minicircle expression systems were used in this study, human α 1-antitrypsin (hAAT) and human factor IX (hFIX) driven by the RSV-LTR and EF1 α promoter, respectively. Using random or fragmented DNA sequences of 500bp or less, these two transgenes were expressed similarly to standard minicircle DNA as they were not silenced. In contrast, with 1kb or longer spacers, the transgene

expression was silenced as with the standard plasmid vector. These results suggested that spacer DNA regardless of its source >1kb caused the minicircle constructs to be silenced even in the absence of plasmid BB. To further establish this idea, 500bp of plasmid BB was used as spacer to make new constructs. These constructs also showed persistent expression suggesting the size of the non-transcribed insert and not the source of the spacer DNA was the critical factor for DNA silencing. To better understand the mechanism of plasmid silencing, we attempted to determine if leaky transcriptional termination across the spacer sequences was an important parameter for silencing. To do this, we added a robust transcriptional terminator between the poly A site and DNA spacer. Even with an additional terminator, only spacers of > 1kb silenced the transgene. Our data suggest that the distance between the poly A site and promoter region influences DNA silencing. These results have important implications for designing DNA plasmid vectors for gene therapy.

12. Development of a High-Throughput Quantitative Method for Assessing Plasmid Nuclear Import

Holly M. Reynolds,¹ David A. Dean.¹

¹*Pediatrics, University of Rochester, Rochester, NY.*

One area of interest in gene therapy is designing strategies that can allow DNA to be delivered only to a specific cell type or tissue. Historically, these strategies have included: application of the agent directly to desired tissue, exploitation of receptor-ligand interactions, and using cell-specific promoters to drive transcription. Our lab has developed a novel and robust method for cell-specific delivery that allows for nuclear import in non-dividing cells by a sequence specific process that requires the cytoplasmic binding of transcription factors, and in some cases, when the Nuclear Localization Signal is oriented in the correct way, allow for taxiing across the nuclear membrane. Namely, this exploits the fact that promoter sequences bind transcription factors and in some cases, when the Nuclear Localization Signal is oriented in the correct way, allow for taxiing across the nuclear membrane. To date, we have discovered DNA sequences that provide cell-specific import in smooth muscle cells, osteoblasts, endothelial cells and alveolar type 2 epithelial cells. Identifying such plasmid sequences, however, is a tedious and time-consuming task, requiring cytoplasmic microinjection of individual plasmids containing potential sequences into hundreds to thousands of individual cells and determining nuclear localization of the plasmids by *in situ* hybridization and/or fluorescence microscopy. We have developed a simpler, higher-throughput assay that allows us to screen a large number of potential sequences for cell-specific nuclear entry in a large panel of cell types. Using a 96-well electroporator with optimized field strengths, we can induce cell uptake of pools of fluorescently-labeled plasmids containing various DNA sequences. After incubation, these cells are fixed and run, in a 96-well format, on an AMNIS Imagestream with a nuclear stain. This instrument is essentially a flow cytometer that images each cell in up to 8 fluorescent channels with a 40X or 60X objective as it moves through the stream. The instrument is capable of collecting data from up to 5000 cells per minute and images can then be analyzed with software to assess and quantify subcellular localization of the plasmids. Using this approach, we have shown that plasmids carrying the ubiquitously active SV40 DNA nuclear targeting sequence localize to the nuclei of multiple cell types while isogenic plasmids lacking this sequence remain in the cytoplasm unless incubation times are greatly increased to allow for cell division (and concomitant breakdown of the nuclear envelope). This approach should greatly enhance our ability to screen DNA sequence libraries in a wide variety of cell types to identify nuclear localizing DNA sequences for cell-specific gene therapy.

13. Robust Long-Term Gene Expression in Mouse Liver Via the Novel *hAT* Transposon *TcBuster*

Lauren E. Woodard,¹ Aparna Kaja,¹ Robert H. Hice,² Peter W. Atkinson,² Nancy L. Craig,³ Matthew H. Wilson.¹

¹*Department of Medicine, Division of Nephrology, Baylor College of Medicine, Houston, TX;* ²*Department of Entomology & Institute for Integrative Genome Biology, University of California, Riverside, Riverside, CA;* ³*Howard Hughes Medical Institute, Department of Molecular Biology and Genetics, Johns Hopkins School of Medicine, Baltimore, MD.*

TcBuster is a recently discovered mobile DNA element from the *hAT* superfamily. Colony count assays in HEK 293 cells using varying amounts of transposon and transposase indicate that maximal transposition occurred using 500 ng of pTCBNeo and 100 ng of pCMV-TCB. Out of 48 *TcBuster* integration sites sequenced from these cells, 62.5% were in genes and 4.2% were in exons, suggesting a preference for transcriptionally active areas. Comparing different transposons by colony count assay in HEK 293 cells, the transposition of *TcBuster* was approximately equivalent to *hAT* family member *Tol2* and about half that of *piggyBac*, depending on the ratio of transposon to transposase plasmids. When an equal amount of transposase and transposon plasmids were used, all three systems were approximately equal. However, when an excess of transposase (200 ng of transposon and 800 ng of transposase plasmids) or an excess of transposon (900 ng of transposon and 100 ng of transposase plasmids) were provided, *piggyBac* outperformed both *hAT* systems, indicating the significant flexibility of the *piggyBac* system. As for the *hAT* systems, when the amount of transposase plasmid was higher, the *Tol2* system was superior to *TcBuster*, whereas when the amount of transposase plasmid was low, the *TcBuster* system was superior to *Tol2*. After transfection with a construct carrying an HA-tagged version of the *TcBuster* transposase, staining revealed localization to unique intranuclear rodlets. We hypothesize that the rodlets may serve a protective role, limiting free transposase and thus DNA damage. In support of this hypothesis, as the amount of pCMV-HA-TCB is increased beyond 100 ng, the number of rodlets per nuclei increased exponentially as the number of colonies formed decreased. To compare *TcBuster* with *piggyBac* for integration into mammalian chromosomes *in vivo*, adult female FVB mice were given hydrodynamic injections containing luciferase transposon plasmids with or without the plasmid encoding the transposase. Mice were imaged using the IVIS system to determine the levels of liver-specific luciferase expression at timepoints out to 24 weeks. At the later timepoints, the normalized luciferase values for groups given either *TcBuster* or *piggyBac* transposase were both statistically significantly higher than groups given transposon alone ($p < 0.0005$ and $p < 0.01$, respectively, by two-tailed t-test). An equivalent t-test comparing *TcBuster* with *piggyBac* revealed that they were not significantly different from one another. Therefore, we conclude that *TcBuster* is an exciting new transposon that is highly capable of providing long-term gene expression *in vivo*.

14. Immunosuppression with Cyclophosphamide Significantly Prolongs High-Level Expression of IDUA Mediated by the *Sleeping Beauty* Transposon System

Elena L. Aronovich,¹ Jason B. Bell,¹ Kelly M. Podetz-Pedersen,¹ Brenda L. Koniar,² R. Scott McIvor,¹ Perry B. Hackett.¹

¹*Genetics, Cell Biology and Development, University of Minnesota, Minneapolis, MN;* ²*Research Animal Resources, University of Minnesota, Minneapolis, MN.*

Mucopolysaccharidosis type I (MPS I) is a systemic disease caused by deficiency of the lysosomal enzyme α -L-iduronidase (IDUA). The goal of gene therapy for MPS I is to achieve sustained expression

of an IDUA transgene. We have reported the effectiveness of the *Sleeping Beauty* (SB) transposon system for gene therapy of MPS I in adult immunodeficient mice. However, in immunocompetent mice IDUA expression is curtailed mainly by immune responses to the transgenic IDUA polypeptide. Although more than 99% of transgene expression comes from the liver following hydrodynamic delivery, restoration of deficient enzyme activity in other organs can be achieved through metabolic cross-correction whereby IDUA enters the circulation and is distributed to other tissues. The IDUA gene must therefore be regulated by a strong promoter that will drive high-level expression, i.e. ≥ 100 -fold the wild-type (WT) level. We have previously shown that a strong liver-specific promoter ApoEhAAT has several advantages over using the strong ubiquitously expressed CAGGS promoter to drive IDUA including: 1) increased IDUA expression level at 5-6 weeks post-infusion and 2) absence of a gender bias that we characterized using the CAGGS promoter for expression in MPS I mice. We hypothesized that a combination of immunosuppression and liver-specific expression would increase the levels of IDUA maintained in immunocompetent MPS I mice. We hydrodynamically injected 5 g pT2/ApoEhAAT-IDUA SB transposons into immunocompetent C57BL/6 mice with or without pCMV-SB100 transposase (+ or -SB). Preliminary comparison of transposition efficiency by real-time qPCR excision assay showed that SB100 was at least 30 times more effective than SB11 in mouse liver. For long-term studies, mice (n=10 mice /cohort) were treated with or without cyclophosphamide (50 mg/kg i.p. on -1 day, -5 h, +1 day, and +2 days with respect to hydrodynamic injection). IDUA activity in plasma was 200-300-fold greater than WT in all mice 1-day post-injection (p.i.). Without cyclophosphamide, plasma IDUA declined slightly over the first two weeks but thereafter deteriorated in most mice (+ and -SB) to background levels by six weeks p.i. In a few mice that were not immunosuppressed, IDUA activity remained consistent for 6 - 12 weeks before declining to background over a period of 2 weeks. In contrast, IDUA expression levels were maintained in all except 5 of the 19 cyclophosphamide-treated mice and at 12 weeks p.i. IDUA expression was 217 ± 159 -fold WT (+SB) and 75 ± 60 (-SB). Thus, the combination of transient immunosuppression and a liver-specific promoter resulted in sustained IDUA expression at levels that, with SB100, were therapeutically relevant for treating MPS I.

15. Evaluating the Safety of PiggyBac Mediated Gene Transfer in Human Cells

Sunandan Saha,^{1,2} Aparna Kaja,¹ Cliona M. Rooney,^{2,3} Matthew H. Wilson.^{1,2}

¹Department of Medicine- Nephrology Division, Baylor College of Medicine, Houston, TX; ²Program in Translational Biology and Molecular Medicine, Baylor College of Medicine, Houston, TX; ³Department of Pediatrics, Baylor College of Medicine, Houston, TX.

PiggyBac has been successfully used for modification of primary human cells and cell lines with transgene(s) of interest and holds promise as an effective non-viral gene delivery method. Currently, limited information exists about the safety of the piggyBac system for the modification and generation of clinical grade human cells. In this study we began to evaluate the safety of piggyBac for modification of human cells. PiggyBac works through a "cut and paste" mechanism thereby delivering a transgene of interest flanked by inverted repeat sequences into the genome. We found that piggyBac leads to stable transgene integration and transposase expression is undetectable after 7 days in a mixed population of human cells. Although there are no sequences in the human genome with complete similarity to the 17bp terminal repeat sequence (TRS) of the piggyBac transposon inverted repeats (IR), there are sequences with 16, 15 or 14 bp similarities all of which end in the tetranucleotide TTAA required for transposition. We subsequently tested the ability of piggyBac to mobilize these

genomic elements. The potential of these sequences mimicking the TRS was assessed by replacing the TRS of the 5' inverted repeat with these genomic sequences and looking at transposition efficiency using a colony count assay. None of the 14 tested sequences were able to effectively act as a terminal repeat sequence. Nor did they mediate excision of transposons in presence of the transposase. To assess the safety of delivering the transposase and transposon from a single vector, we isolated clones derived from transfections using the transposase and the transposon cassettes in cis (on the same plasmid vector) and found that all clones had residual transposase expression. In contrast, stable clones generated with transposase delivered in trans from a separate non-integrating plasmid showed no residual transposase expression. Studies are ongoing to further evaluate the potential genotoxicity of piggyBac in human cells. Thus, our data suggests that piggyBac transposase expression is short lived (7 days) in a mixed population of human cells, the piggyBac transposase appears incapable of mobilizing TRS-like-sequences in the human genome, and delivering transposase in trans should be safer than delivery in cis when modifying human cells. piggyBac appears to be a promising non-viral gene delivery system for therapeutic genetic modification of human cells.

16. Development of a Sleeping Beauty Transposon-Based Integration System for Gene Transfer in Human Epithelial Cells

Giandomenico Turchiano,¹ Maria Carmela Latella,¹ Zsuzsanna Izsvak,² Zoltan Ivics,² Fulvio Mavilio,¹ Alessandra Recchia.¹
¹Center for Regenerative Medicine, University of Modena and Reggio Emilia, Modena, Italy; ²Max Delbrück Center for Molecular Medicine, Berlin, Germany.

Transplantation of autologous, genetically corrected epidermal stem cells (EpSC) was successfully used to treat junctional epidermolysis bullosa (EB), a genetic skin adhesion disorder. The dystrophic forms of EB is caused by mutations in the type-VII collagen gene (COL7A1) Delivering the >9 kb COL7A1 cDNA by a retroviral vector is problematic, due to the large size and highly repeated nature of its sequence, which induce genetic rearrangements during reverse transcription and integration. We tested the feasibility of using a non-viral vector system based on Sleeping Beauty (SB)-derived transposons, taking advantages of the recently developed, high-capacity "sandwich" version of the SB transposon and the "hyperactive" SB 100X transposase, which showed high transposition efficiency in human stem cells. We tested the system in HeLa cells and in a keratinocyte cell line (HaCaT), which were co-transfected with the SB 100X transposase and either the normal or the sandwich version of the SB transposon containing a small-size reporter gene (Venus or GFP) expression cassette. In both cell lines, transposition was obtained in up to 80% of the transfected cells with the sandwich transposon, compared to ~50% obtained with the older version. Transposed HaCaT cells were cloned and analysed for integration events. Individual clones carried one to 14 copies of the integrated transposon of the predicted size. High-throughput sequencing is under way to analyze the sandwich SB transposon integration characteristics. We then tested a transposon carrying an 8.8-kb cassette, which again showed up to 80% transposition efficiency in transfected cells. Finally, we generated sandwich transposons containing an expression cassette for the COL7A1 cDNA under the control of a constitutive (PGK) or a keratinocyte-specific (K14) promoter, which are currently being tested for integration in HaCaT cells. The SB-based gene delivery system will finally be tested in human primary keratinocyte cultures.

Infectious Diseases and Vaccines

17. Induction of T Cell Dysfunction by AAV-Mediated Hepatitis B Virus Infection

Mi-Hua Tao,^{1,2} Ya-Hui Huang,^{1,2} Ho-Yuan Chou,^{1,3} Cheng-Chieh Fang.¹

¹*Institute of Biomedical Sciences, Academia Sinica, Taipei, Taiwan;*

²*Graduate Institute of Life Sciences, National Defense Medical Center, Taipei, Taiwan;* ³*Graduate Institute of Microbiology, National Taiwan University, Taipei, Taiwan.*

The complex virus-host interactions responsible for dysfunctions of hepatitis B virus (HBV)-specific T cells in the early phase and the subsequent development of severe liver diseases several decades later are poorly understood and have been difficult to study due to the absence of appropriate small animal models that are susceptible to infection. Mice are not naturally infected by HBV, presumably due to a lack of HBV receptors on mouse hepatocytes. To bypass this entry step of HBV infection, we used adeno-associated viral vectors to introduce the HBV genome (AAV/HBV) into the liver of immunocompetent mice. We confirmed the presence of HBV virions and proteins in the serum and liver of all AAV/HBV-transduced mice in all four mouse strains tested. The AAV/HBV-transduced mice were negative for HBV surface (HBs) and e protein (HBe)-specific antibodies, but positive for HBV core (HBc)-specific antibody, a profile similar to that observed in chronic HBV patients. AAV/HBV transduction induced HBs- but not HBe-specific IFN- γ -producing CD8⁺ T cells, preferentially enriched in the liver. The number of HBs-reacting CD8⁺ T cells decreased with time and their effector functions were severely impaired as suggested by their failure to respond to HBs immunization. Interestingly, PD1 expression on hepatic CD8⁺ T cells increased gradually after AAV/HBV transduction, suggesting an important role of PD-1 in constraining T cell activity and maintaining HBV chronicity. Nevertheless, six months after transduction these AAV/HBV-transduced mice manifested evidence of hepatic inflammation and regeneration. *Conclusion:* Our AAV/HBV-transduced murine model is a unique instrument for studying the immunological events in human chronic HBV and induction of PD1 expression is correlated with dysfunction of hepatic CD8⁺ T cells.

18. Desmoglein 2 Is a Receptor for Adenovirus Serotypes 3, 7, 11, and 14: Implications for Pathogenesis of Adenovirus Infections and Cancer Treatment

Hongjie Wang,¹ Zongyi Li,¹ Jonas Persson,¹ Ines Beyer,¹ Robert Strauss,¹ Akseli Hemminki,² Pascal Fender,³ Andre Lieber.¹

¹*Division of Medical Genetics, University of Washington, Seattle, WA;* ²*Cancer Gene Therapy Group, University of Helsinki & Helsinki University Central Hospital, Helsinki, Finland;* ³*Unit of Virus Host Cell Interaction, EMBL, Grenoble, France.*

We have identified desmoglein 2 (DSG2) - a calcium-binding transmembrane glycoprotein and component of the epithelial cell-cell adhesion structure - as the primary high-affinity receptor used by adenovirus (Ad) serotypes Ad3, Ad7, Ad11, and Ad14. These serotypes represent important human pathogens causing respiratory tract infections. Loss- and gain-of-function studies confirmed DSG-2 to be crucial for the binding, infection and spread of these serotypes. While Ad binding CAR and CD46 involves only a high affinity interaction between the fiber knob domain and the cellular receptor, binding of Ad3 to DSG2 requires multimerization of the fiber knob domain. We therefore designed two recombinant Ad3 fiber knob domains containing heterodimerization domains. Both proteins can be produced in *E. coli* and purified by affinity chromatography. Upon mixing they dimerize (Ad3K-K dimer). Ad3K-K efficiently and specifically blocked Ad3 infection. We also studied the consequences

of adenoviral-DSG-2 interaction, following exposure to Ad3 virions or Ad3K-K, using epithelial cancer cell lines. Pathways involved in epithelial-to-mesenchymal transition were found to be activated, leading to transient intercellular junction opening. This finding has implications for Ad spread in epithelial tissues and for cancer therapy as intercellular junctions represent physical obstacles for access and intratumoral dissemination of anti-cancer therapeutics. We demonstrated that pre-incubation of cancer cell lines with Ad3K-K increased the cytotoxicity of trastuzumab and cetuximab - monoclonal antibodies which bind to the Her2/neu receptor and EGFR respectively. In vivo, in mice carrying Her2/neu-positive breast cancer and EGFR1-positive lung cancer xenografts, pre-injection of Ad3K-K significantly increased the therapeutic efficacy of trastuzumab and cetuximab. Ad3-DSG2 interactions potentially have consequences beyond opening epithelial junctions as we also detected Ad3 binding to DSG2 on platelets and granulocytes. We are currently performing a systemic biodistribution study of DSG2 expression in humans and non-human primates and data will be presented. Together, these studies will likely contribute to the design of novel antiviral therapies and may also have important implications for cancer therapy.

19. Increased Mucosal CD4⁺ T Cell Activation Following Vaccination with a Species-Specific Adenovirus Vector in Rhesus Macaques

Roberto Calcedo,² Irene Bukh,¹ Soumitra Roy,² Diane G. Carnathan,¹ Rebecca Grant,² Sarah J. Rutcliffe,³ James M. Wilson,² Michael R. Betts.¹

¹*Department of Microbiology, University of Pennsylvania, Philadelphia;* ²*Department of Pathology & Laboratory Medicine, University of Pennsylvania, Philadelphia;* ³*Department of Biostatistics, University of Pennsylvania, Philadelphia.*

The possibility that vaccination with Adenoviral vectors increased mucosal T-cell activation remains a central hypothesis to explain the potential enhancement of HIV acquisition within the STEP trial. Modeling this within rhesus macaques is complicated because human Adenoviruses, including Adenovirus type 5 (HAd5), do not naturally infect macaques. Therefore, we created a vector based upon a naturally occurring rhesus macaque Adenovirus (SAAdV7) to test whether vaccination with a species-specific Adenoviral vector enhances mucosal T-cell activation within the natural host. Twelve rhesus macaques were vaccinated 3x intramuscularly with the SAAdV7 vector, and PBMC and rectal biopsies were obtained at baseline, multiple times post-prime and post-17 week boost (8x/animal), and post-31 week second boost (1x/animal). Five HAd5-vaccinated animals were included as controls. We assessed rectal mucosal lamina propria and blood for frequency changes of Ad-specific T-cell responses and T-cell activation levels by measuring IFN γ , TNF α , IL2, CD25, Ki67, CD69, and HLA-DR. Naturally acquired pre-existing SAAdV7-specific CD4⁺ T-cells were detectable in 9/12 macaques within blood (0.05-0.256%) and/or rectal mucosa (0.3-1.11%). Following SAAdV7 vaccination, rectal SAAdV7-specific CD4⁺ T-cell responses increased above baseline in 9/12 animals (0.3-8.6%) 2-5 weeks post-prime, reaching as high as 10.75% following homologous SAAdV7 boost (11/12 animals, 0.16-10.75%). SAAdV7-specific CD4⁺ T-cells in the rectal mucosa exhibited increased activation levels relative to those found in blood. Importantly, the SAAdV7 vaccination resulted in a dramatic perturbation of total memory CD4⁺ T cells, characterized by heightened expression of the CD25, CD69, and HLA-DR activation markers (up to 80% of memory CD4 cells) and a proportional decrease in naïve CD4⁺ T cells, which peaked at 16 weeks after the prime. No such effect occurred in HAd5-vaccinated animals. These results indicate that peripheral vaccination with a species-specific Adenovirus vector can increase the activation state of mucosal CD4⁺ T-cells providing a potential mechanism for the increased transmission of HIV following HAd-5 vaccination in the Merck STEP trial.

20. Most Closely HLA-Matched Allogeneic Virus Specific Cytotoxic T-Lymphocytes (CTL) To Treat Persistent Reactivation or Infection with Adenovirus, CMV and EBV after Hemopoietic Stem Cell Transplantation (HSCT)

Ann M. Leen,¹ Catherine M. Bollard,¹ Adam M. Mendizabal,² Elizabeth J. Shpall,³ Paul Szabolcs,⁴ Joseph Antin,⁵ Neena Kapoor,⁶ Sung-Yun Pai,⁷ Bambi Grilley,¹ Adrian P. Gee,¹ Malcolm K. Brenner,¹ Cliona M. Rooney,¹ Helen E. Heslop.¹

¹Baylor College of Medicine, Texas Childrens Hospital, The Methodist Hospital, Houston; ²The EMMES Corporation, Rockville; ³MD Anderson Cancer Center, Houston; ⁴Duke University Medical Center, Durham; ⁵Dana Faber Cancer Institute, Boston, MA; ⁶Children's Hospital of Los Angeles, Los Angeles; ⁷Dana Faber Cancer Institute, Children's Hospital Boston, Boston, MA.

Adoptive transfer of CTLs can reconstitute antiviral immunity to EBV, CMV and adenovirus in allogeneic hemopoietic stem cell transplant (HSCT) recipients. However, the time taken to prepare patient-specific products and the lack of virus-specific T-cells in cord blood and seronegative donors restricts application. As part of the NHLBI Specialized Centers for Cell-Based Therapy, we are evaluating in a multicenter setting whether infusion of “off the shelf” closely HLA-matched allogeneic CTLs (CHM-CTLs) will overcome this limitation and prove feasible, safe and effective in HSCT recipients with infection refractory to standard therapy. Using the NHLBI Production Assistance for Cellular Therapies (PACT) program, we manufactured and tested >30 multivirus lines, which were polyclonal, comprising CD4+ (median 10%) and CD8+ (median 83%) T-cells with specificity for CMV, EBV and adenovirus (mean 1463, 101, and 227 SFC/1x10⁵ cells, respectively). A dose of 2x10⁷CHM-CTL/m² was available to subjects with persistent infection matching at least one HLA antigen. We selected the most suitable line based on target virus specificity through a shared allele and on overall HLA match. To date 61 patients have been screened. A potential line was identified for 56, of whom 35 received 1-3 infusions with lines matched at 1-3 HLA antigens. Seven subjects received CHM-CTLs for refractory EBV-PTLD, 15 for persistent CMV, 12 for persistent adenovirus and one for both CMV and adenovirus. There were no immediate adverse effects, and the GVHD incidence was low, with two patients reactivating previous acute skin or chronic GVHD, and two developing transient skin rashes. Two patients developed thrombotic microangiopathy but had other risk factors including sirolimus treatment. Response, defined as the overall cumulative incidence of first CR/PR in the first 30 patients by day 42 is 85.7% overall; (92% for CMV, 80% for EBV and 80% for adenovirus). Of note, we obtained complete antiviral responses in 16 patients overall, and even in recipients of lines matching at a single HLA antigen. Despite this objective antiviral activity, immune monitoring studies using IFN-g ELISpot assays showed little or no rise in peripheral blood virus-reactive T cells after infusion. Nevertheless these preliminary results show the feasibility and safety of immunotherapy using banked CHM-CTLs. The antiviral responses we observe are encouraging and suggest that an “off-the-shelf” CTL cell line may be a practical strategy for allogeneic stem cell transplant recipients.

21. Modeling Genetic Protection Against AIDS: Viral Restriction Factor Transgenesis in the Domestic Cat

Pimprapar Wongsrikeao,¹ Dyana T. Saenz,¹ Tommy Rinkoski,¹ Takeshige Otoi,² Eric M. Poeschla.^{1,3}

¹Department of Molecular Medicine, Mayo Clinic College of Medicine, Rochester, MN; ²Department of Veterinary Medicine, Yamaguchi University, Yamaguchi, Japan; ³Division of Infectious Diseases, Mayo Clinic College of Medicine, Rochester, MN.

The genome of the domestic cat was recently sequenced at 1.9X coverage and a 10X assembly is imminent. This neurobehaviorally complex, accessible species is valuable in research situations where rodents are unsuited. For example, humans and cats each suffer from pandemic AIDS-causing lentiviruses and the feline eye and nervous system are important model systems. A capability for feline transgenesis is needed to realize the inherent potential. Here we generated multi-gene transgenic domestic cats without nuclear transfer, thus establishing transgenesis by gamete genetic modification for the first time in a carnivore. The process was highly efficient, with uniformly transgenic outcomes, 5-15 insertions per animal, widespread organ-pervasive gene expression, germline transmission and no mosaicism. Lymphocytes from cats transgenic for rhesus macaque TRIMCyp, a retroviral restriction factor, had decreased susceptibility to feline immunodeficiency virus replication. Feline transgenesis can now be used to investigate fundamentals of lentiviral restriction factor biology at the whole animal level, gauge the potential of these factors in gene therapy for HIV-1/AIDS and create animal models for other diseases, and potentially to protect extremely endangered feline species.

22. Induction of Strong Cellular and Humoral Immune Responses Following Immunotherapy of Post-LEEP CIN 2/3 with HPV 16 & 18 E6/E7 DNA Vaccines

Jian Yan,¹ Xuefei Shen,¹ Mary Giffear,¹ Jessica Lee,¹ Amir S. Khan,¹ Dawn Harris,² Panyupa Pankhong,² Devon Shedlock,² Jean Boyer,² David B. Weiner,² Mark Bagarazzi,¹ Niranjan Y. Sardesai.¹

¹Inovio Pharmaceuticals, Inc., Blue Bell, PA; ²Pathology and Laboratory Medicine, University of Pennsylvania School of Medicine, Philadelphia, PA.

Background: Cervical cancer due to human papillomavirus (HPV) infection is responsible for 270,000 deaths every year necessitating the development of new therapies. DNA vaccines have potential advantages for cancer immunotherapy although human immunogenicity has disappointed. Codon/RNA optimization, high efficiency IgE leader sequences, and electroporation (EP) were all employed to enhance the potency of the vaccines in this study. **Methods:** VGX-3100 is a combination of 2 plasmids, pCon16E6E7 & pCon18E6E7 that encode HPV16 & 18 consensus E6/E7 fusion genes, respectively. HPV-001 is a phase I study evaluating 3 IM doses (0.6, 2, 6 mg) of VGX-3100 using CELLECTRA® EP device. Six post-LEEP CIN2/3 patients were immunized at weeks 0, 4 & 12 in each cohort. Immune responses were measured by ELISA with epitope mapping, Western blot, T-cell ELISpot, and flow cytometry. **Results:** VGX-3100 and the vaccination procedure were safe and generally well tolerated. All subjects completed the three dose vaccination regimen and no SAEs or vaccine-related Grade 3 or 4 AEs have been reported. **Cellular responses:** Overall, in all three doses combined, 13 out of 18 vaccinated subjects (72%) developed significant CTL responses, with positive responses ranging from under 100 to over 5000 SFU per million cells. Significantly, CTL responses were observed to all four vaccine antigens. In the high dose cohort, five of six vaccinated subjects (83%) developed significant CTL responses, with average responses of 1362 SFU per million cells after three immunizations.

This was a 118% increase compared to the intermediate dose cohort average of 626 SFU per million cells (four responders out of six) and a 174% increase compared to the low dose cohort average of 497 SFU per million cells (four responders out of six) indicating a vaccine dose effect. **Humoral responses:** Fifteen out of 18 vaccinated subjects (83%) developed antibody responses to at least one antigen with most subjects developing responses to two or more antigens. Western blot confirmed reactivity to HPV16 & 18 E7. Epitope mapping shows broad responses to E6 & E7 epitopes. **Conclusions:** Antibodies and ELISpots are higher than previous reports from prior studies of HPV poxviral, peptide or DNA vaccines. Highly optimized HPV vaccines delivered by EP induced robust cellular and humoral responses in humans with as little as 0.3 mg/plasmid. These preliminary results support the further development of immunotherapeutic HPV DNA vaccine strategies in Phase II clinical studies to assess impact on clinical efficacy.

23. Enhanced Immunogenicity of Measles Virus Constructs Encoding *Helicobacter pylori* Neutrophil-Activating Protein as Vaccine Platforms

Iankov D, Iankov, ¹ Mark J. Federspiel, ¹ Evanthia Galanis. ¹

¹Mayo Clinic College of Medicine, Rochester, MN.

Background: *Helicobacter pylori* neutrophil-activating protein (NAP) is a crucial virulence factor and promising candidate for vaccine development. NAP is TLR2 agonist and potent immunomodulator inducing Th1-biased inflammatory response. Recently, we generated and evaluated the immunogenicity of a panel of attenuated measles virus (MV) strains encoding different forms of NAP antigen. Immunization experiments demonstrated that MV vector engineered to express secretory forms of the antigen induced strong and long-lasting antibody and cellular immunity against NAP. Here we present data on the characterization of the humoral immune response against NAP-expressing MV strains in MV infection permissive type I interferon receptor knockout human CD46 transgenic (Ifnarko-CD46Ge) mice. **Results:** MV-lambda-NAP and MV-s-NAP encode secretory NAP antigen replacing the variable domain of human lambda immunoglobulin chain with (MV-lambda-NAP) or without (MV-s-NAP) the constant lambda domain. We developed a monoclonal antibody based immunoassay for detection of NAP expression in culture supernatants and biological fluids. Vero cells infected with both strains expressed high level (> 1 µg/ml per 10⁶ infected cells) of the secretory NAP transgene. On day 28 post-immunization of Ifnarko-CD46Ge mice, all animals developed antibody titers against NAP above 1:10,000 in ELISA. Characterization of the isotype specificity revealed that the humoral anti-NAP immunity is dominated by the IgG2a and IgG1 subtypes. IgG2b titers were lower and NAP-specific IgG3 is barely detectable. All mice developed highly protective MV neutralization immunity with an average titer above 1:4,000 in plaque reduction microneutralization test (PNT). Further, we evaluated the NAP-mediated immunostimulatory effect in MV-lambda-NAP immunized mice compared to the immune response in the animal group immunized with the MV-lambda (MV expressing full length unmodified human lambda immunoglobulin) control strain (7-9 animals per group). On day 18 all MV-lambda-NAP injected animals had anti-lambda ELISA titers of 1:25,600, significantly higher than those of the MV-lambda-immunized control mice, where only less than a half of the group developed titers above 1:1,600. These results demonstrated that "NAP-tagged" chimeric lambda is highly immunogenic compared to the unmodified protein. This strategy can be applied in vaccination against poor immunogens, such as tumor-associated antigens or poorly immunogenic protective antigens of infectious pathogens. **Conclusions:** These data demonstrated the strong immunogenicity of attenuated MV vaccine strains encoding a single *H. pylori* protective antigen. MV vector-expressed chimeric NAP constructs can enhance

the immune response to poor immunogens with application in vaccine development, cancer immunotherapy and virotherapy. * This work was supported by Atwater grant, P50CA116201 and Paul Leibson Memorial Fund.

24. In Vivo Safety and Efficacy of a Combination Anti-HIV Lentiviral Vector in RAG1 Mice for HIV Gene Therapy

Jon Walker, ¹ Brian Fury, ¹ Jeannine McGee, ¹ Gerhard Bauer, ¹ Jan A. Nolte, ¹ Joseph S. Anderson. ¹

¹Internal Medicine, University of California Davis, Sacramento, CA.

HIV gene therapy offers a potential alternative to current small molecule antiretroviral treatments which, after prolonged use, can become toxic and allow the generation of escape mutants. A recent hematopoietic stem cell transplant for acute myeloid leukemia in an HIV infected patient was performed utilizing allogeneic cells from an individual homozygous for the delta-32 CCR5 deletion. HIV-1 suppression has been observed in the recipient, to date, even after this individual discontinued antiretroviral therapy. Therefore, HIV gene therapy has the potential to mimic the results of this transplant by inserting anti-HIV genes into hematopoietic progenitor cells for constitutive expression and lifelong protection from further HIV replication. For preclinical analysis of anti-HIV gene therapeutic vectors, it is necessary to utilize an appropriate in vivo animal model capable of demonstrating safety and efficacy of the novel therapy. The RAG1-IL2r-γ knockout mouse model offers the potential to evaluate multi-lineage human hematopoiesis from intrahepatic injection of transduced human CD34+ hematopoietic progenitor cells (HPCs) into newborn mice. In the current study, preclinical evaluation of a combination anti-HIV lentiviral vector was performed, in vivo, in a humanized RAG1-IL2r-γ knockout mouse model. This combination vector contains a human/rhesus macaque TRIM5α isoform, a CCR5 shRNA, and a TAR decoy and has previously displayed strong pre-integration inhibition of HIV-1 infection, in vitro. Here we demonstrate multi-lineage human hematopoiesis from combination lentiviral vector transduced CD34+ HPCs in the peripheral blood and in various lymphoid organs including the thymus, spleen, and bone marrow. Anti-HIV vector transduced cells displayed a normal distribution of immune cells including T cells, B cells, and macrophages compared to control nontransduced and EGFP-alone vector transduced cells. The anti-HIV vector transduced cells also displayed knockdown of cell surface CCR5 due to the expression of the CCR5 shRNA. After in vivo challenge with either an R5-tropic BaL-1 or X4-tropic NL4-3, a selective survival advantage of anti-HIV transduced cells was observed. The total percent of anti-HIV transduced cells (based on CD45+ human cells) increased from the initial engraftment of ~20% to >50% in the peripheral blood from pre-infection to week 10 post infection. This was in comparison to control EGFP-alone vector transduced cell engrafted mice where the total percent of CD45+ human cells in the peripheral blood remained constant ~20% from pre-infection engraftment levels to week 10 post-infection. A decrease in the levels of plasma viremia in anti-HIV transduced cell engrafted mice was also observed over the course of infection compared to control cell engrafted mice where the human cells remained unprotected. The data provided here confirm the utility of this combination anti-HIV lentiviral vector and suggests its application in a future human clinical setting.

Cancer-Targeted Gene & Cell Therapy I

25. Genetically Modified T Cells Directed to Glioblastoma Suppress Tumor Growth in a Rodent Glioma Model

Seogkyoung Kong,¹ Betty Tyler,² Jinyuan Zhou,³ Bob S. Carter,⁴ Henry Brem,² Richard P. Junghans,⁵ Prakash Sampath.¹

¹Department of Neurosurgery, Brain Tumor Laboratory, Boston University School of Medicine, Roger Williams Hospital, Providence, RI; ²Department of Neurosurgery, Hunterian Neurosurgical Research Laboratory, Johns Hopkins University School of Medicine, Baltimore, MD; ³Department of Radiology, Johns Hopkins University School of Medicine, Baltimore, MD; ⁴Department of Surgery, Neurosurgical Service, Harvard Medical School, Massachusetts General Hospital, Boston, MA; ⁵Department of Surgery, Division of Surgical Research, Boston University School of Medicine, Roger Williams Hospital, Providence, RI.

Glioblastoma multiforme (GBM) is the most challenging brain tumor due to tumor recurrence. There is currently no effective treatment. Here, we describe the development and preclinical tests of IL13Ra2-specific T cells for clinical trials. We exploited interleukin (IL) 13 receptor $\alpha 2$ (IL13Ra2) as a GBM-specific tumor antigen due to its frequent overexpression on a majority of GBM but not expressed on normal brain tissues. We constructed a chimeric antigen receptor (CAR) specific to IL13Ra2. We modified T cells using retroviral gene transfer to express a CAR comprising an extracellular IL13.E11K.R107K molecule linked to intracellular signaling components from the CD28 co-stimulatory molecule and the CD3 zeta molecule, redirecting T cells' killing specificity. We created IL13.E11K.R107K for selectively enhanced recognition and killing of GBM-associated IL13Ra2, discriminating from IL13Ra1. We developed monomeric CAR for killing IL13Ra2 expressing GBM more efficiently through effective clustering of receptor-ligand pairs since the monomeric IL13Ra2 chain is overexpressed on a majority of GBM. CD28 costimulation and monomeric CAR can be synergistic for productive IL13Ra2-specific T cell recognition. After *in vitro* expansion, genetically modified primary human IL13Ra2-specific T cells show specifically enhanced recognition of IL13Ra2+ glioblastoma cells as demonstrated by efficient tumor cell killing, IL-2 & IFN- γ secretion, proliferation, and expansion. A single injection of IL13Ra2-specific T cells into the tumor-bearing rats resulted in prolonged survival. These data demonstrate a significant increase in survival in a rat glioma xenograft model, providing evidence for an effective therapy of the treatment of GBM.

U251 IC Treated with IL13Ra2 Specific T cells

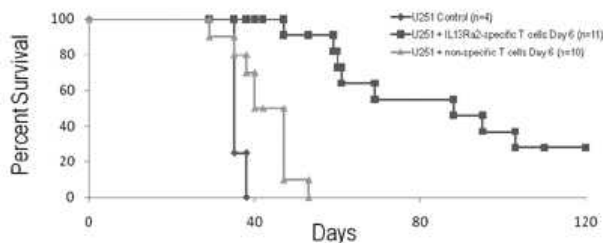

Group	Median survival, days (Range)	Long Term Survivors (%)	P value
U251 Control (n=4)	35 (15-54)	0	
U251 + IL13Ra2-specific T cells (n=11)	40 (27-53)	0	0.0249 vs. Control; <0.0001 vs. IL13Ra2-specific T cells
U251 + non-specific T cells (n=10)	55 (47-120)	28	<0.0001 vs. Control; <0.0001 vs. U251 + IL13Ra2-specific T cells

T₂-weighted MR images of U251 tumors at different stages of tumor growth

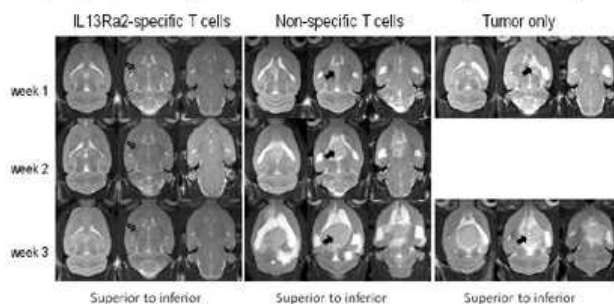

Treatment was performed at day 6 following 1×10^6 U251 implantation. MR images were acquired on week 1 (top row), week 2 (middle row), and week 3 (bottom row) following treatment. For each rat, three of acquired 5 slices are displayed at each time point. No visual tumor (open arrow) was observed treated with IL13Ra2-specific T cells. In contrast, large tumors (solid arrow) were observed treated with non-specific T cells or in untreated. Tumors grew progressively in untreated or treated with non-specific T cells.

26. Disruption of HLA Expression To Enable Allogeneic Cells To Escape Immune Recognition

Hiroki Torikai,¹ Andreas Reik,⁴ Frank Soldner,⁵ Carrie Yuen,¹ Yuanyue Zhou,⁴ Denise Kellar,¹ Helen Huls,¹ Edus H. Warren,³ Scott S. Tykodi,³ Michael C. Holmes,⁴ Edward J. Rebar,⁴ Dean A. Lee,¹ Richard E. Champlin,² Philip D. Gregory,⁴ Rudolf Jaenisch,⁵ Laurence J. N. Cooper.^{1,2}

¹Division of Pediatrics, MD Anderson Cancer Center, Houston; ²Cancer Medicine, MD Anderson Cancer Center, Houston; ³Program in Immunology, Fred Hutchinson Cancer Research Center, Seattle; ⁴Sangamo BioSciences, Inc., Richmond; ⁵Whitehead Institute, Cambridge.

Allogeneic cell therapy has the potential to reconstitute cellular function in patients. However, due to the limited availability of donor cells, it is difficult to find an HLA-matched cell product. A solution to improving the availability of cells and tissue for transplantation would be to infuse donor-derived cells that avoid immune-mediated rejection caused by host T cells recognizing disparate HLAs on the infused product. To broaden the application of allogeneic cell-based therapies, we investigated whether HLA expression can be permanently and completely disrupted by designer zinc-finger nucleases (ZFNs). ZFNs comprise a zinc finger DNA binding domain designed to bind a specific DNA sequence fused to the cleavage domain of *Fok I* endonuclease. Since *Fok I* dimerization is required to introduce a double strand break (DSB), we generated ZFN pairs flanking DNA target sequences in the required spatial conformation. Cellular repair of the DSB by error-prone non-homologous end joining leads to desired disruption of HLA gene expression. As initial proof-of-concept, ZFN pairs targeting exon 3 of the HLA-A locus resulted in 10% genetic modification of the HLA-A loci in the human kidney cell line HEK293. We isolated clones of HEK293 cells with the expected deletions/insertions within the ZFN-binding site on one or both HLA-A alleles which lead to early termination of translation. Significantly, HLA-A^{null} HEK293 clones evaded HLA-A-restricted lysis by T-cell clones, even after interferon- γ and TNF- α treatment was used to upregulate HLA expression. Next, we tested these ZFNs in primary T cells and demonstrated that transient expression of *in vitro* transcribed mRNA generated 40% HLA-A^{null} primary T cells, which could be readily enriched by paramagnetic bead separation. An attractive clinical application for allogeneic HLA^{null}[sup] T cells is to redirect their specificity independent of HLA via expression of a chimeric antigen receptor (CAR) targeting CD19. Thus, we eliminated HLA-A expression from CD19-specific CAR⁺ T cells and demonstrated that they (i) evade HLA-A-restricted lysis by T-cell clones, and (ii) specifically lysed CD19⁺ tumor targets. To further expand the biologic potential of our ZFNs, we disrupted HLA expression in human embryonic stem cell (hESC) by introducing HLA-A-specific ZFN. To analyze HLA-A expression,

we differentiated hESC clones to fibroblasts and cultured them with interferon- γ and TNF- α . Fibroblasts derived from hESC clones which carried insertions/deletions within the ZFN target site lost HLA-A expression while parental hESC-derived fibroblast expressed HLA-A. These data support the concept of the development of “off-the-shelf” allogeneic cells that can be transplanted across HLA barriers on demand.

27. A Chimeric Antigen Receptor Molecule Mediates Bispecific Activation and Targeting of T Lymphocytes

Zakaria Grada,¹ Meenakshi Hegde,¹ Donald R. Shaffer,¹ Alexia Ghazi,¹ Tiara Byrd,¹ Gianpietro Dotti,¹ Winfried Wels,³ Matthew Baker,² Helen E. Heslop,¹ Stephen Gottschalk,¹ Nabil Ahmed.¹
¹Center for Cell and Gene Therapy, Baylor College of Medicine, Houston, TX; ²Biochemistry, Baylor College of Medicine, Houston, TX; ³Chemotherapeutisches Forschungsinstitut, Georg-Speyer-Haus, Frankfurt, Germany.

BACKGROUND: The downregulation or mutation of target antigens is a common tactic creating antigen loss escape variants. Targeting multiple antigens on tumor cells, simultaneously, could offset this escape mechanism and possibly allow for simultaneous targeting of the tumor and elements of its microenvironment. **METHODS:** We used protein structure prediction and docking to construct a chimeric antigen receptor (CAR) molecule exodomain by joining two single chain variable fragments (scFv) molecules specific for CD19 and HER2. While CD19 and HER2 are not naturally coexpressed on normal or malignant mammalian cells, using them allowed us to distinctly test the bispecific functionality of this CAR and its ability to activate T cells by binding to either or both target molecules. This exodomain was tethered to a hinge and transmembrane and signaling endodomain of the costimulatory molecule, CD28, and the ζ chain of T cell receptor. This “chimeric” CAR molecule (C-CAR) was force-expressed on CD3/CD28 activated T lymphoblasts using a retroviral system. The functionality of C-CAR expressing bispecific T cells was tested in cytotoxicity and cytokine release assays. **RESULTS:** Modeled structures and docking produced complexes with favorable interaction of the C-CAR and the published CD19 and HER2 sequences. The sequence of the C-CAR exodomain was confirmed using restriction enzyme digestion and single nucleotide sequencing. T cells expressed both the CD19 as well as the HER2 scFv. In cytotoxicity assays, C-CAR transduced T cells recognized and killed both CD19 as well as HER2 positive tumor cell targets. Using soluble HER2 protein blocked tumor cell lysis in a HER2 protein-dependent manner. Similarly, using CD19 blocking antibodies blocked the CD19 killing in an antibody concentration dependent manner. C-CAR grafted T cells secreted both IFN- γ and IL-2 in coculture with CD19 and HER2 positive tumor cells. CD19 negative, HER2 negative, target cells were not lysed and induced no cytokine release. **CONCLUSION:** This novel chimeric antigen receptor confers bispecific effector functions on T cells. This could have substantial therapeutic implications by allowing for targeting of multiple antigens expressed by the tumor or its microenvironment.

28. Drug Resistant $\gamma\delta$ T Cells Are Required to Efficiently Kill Drug Resistant Glioblastoma Multiforme during a Chemotherapy Challenge

Anindya Dasgupta,¹ Harold T. Spencer,¹ George Y. Gillespie,² Yun Su,² Joscelyn E. Bowersock,² Lawrence S. Lamb.²
¹Department of Pediatrics, Emory University School of Medicine, Atlanta, GA; ²Departments of Medicine and Surgery, University of Alabama at Birmingham, Birmingham, AL.

We previously showed that expanded/activated $\gamma\delta$ T cells from healthy donors recognize NKG2D ligands expressed on malignant

glioma and are cytotoxic to glioma cell lines, primary glioblastoma multiforme (GBM) explants, and human glioma intracranial cell line xenografts. We now show that standard therapies for glioblastoma multiforme (GBM) based on temozolomide (TMZ) increase the expression of stress-associated NKG2D ligands on TMZ-resistant glioma cells, potentially rendering them vulnerable to attack by $\gamma\delta$ T cells. However, temozolomide is also cytotoxic to $\gamma\delta$ T cells. Therefore, we investigated 1) the functional properties of expanded/activated $\gamma\delta$ T cells, (prepared under therapeutic grade conditions) that were bioengineered with a lentiviral-based strategy to confer resistance to temozolomide and, 2) the potential use of these cells in combination with a TMZ regimen for the purpose of treating drug-resistant GBM. The $\gamma\delta$ T cells were genetically modified using a lentiviral vector encoding P140KMGMT, which confers resistance to TMZ. TMZ-resistant clones of the GBM cell line SNB-19 were generated by incubation in increasing concentrations of TMZ over 60 days. P140KMGMT modified and unmodified $\gamma\delta$ T cells were expanded in Zoledronate (Zol) and IL-2 for 14 days. Cytotoxicity of both non-modified or gene-modified $\gamma\delta$ T cells was assessed against both SNB-19 parental cells and TMZ-resistant SNB-19 cells in the presence and absence 400 μ M TMZ. Medium containing ZOL and IL-2 expanded $\gamma\delta$ T cells between 200 – 500-fold, resulting in a product containing 65-80% $\gamma\delta$ T cells. These cells are efficiently transduced at an MOI of 15 with lentiviral vectors encoding a codon optimized P140KMGMT variant. The engineered cells have an effector/memory phenotype and expressed Th1 cytokines TNF- α and IFN- γ but not IL-2, IL-6, Fox-P3, or IL-17. P140KMGMT-modified $\gamma\delta$ T cells were shown to be resistant to increasing concentrations of TMZ up to 400 μ M. Genetic modification of $\gamma\delta$ T cells i) did not alter their phenotype or their ability to kill targets, as both non-modified and gene-modified $\gamma\delta$ T cells were highly cytotoxic to SNB-19 cells, ii) did not alter their ability to kill TMZ-resistant SNB-19 cells, and iii) resulted in efficient killing of TMZ-resistant SNB19 cells in the presence of 400 μ M TMZ, but non-modified cells failed to kill TMZ-resistant SNB-19 cells when TMZ was present. These findings demonstrate that genetically-modified and expanded/activated $\gamma\delta$ T cells can be produced using clinical-grade materials. Furthermore, drug resistant $\gamma\delta$ T cells can be generated without impairing cellular functions, and the genetically modified cells efficiently kill a TMZ-resistant human GBM cell line in the presence of high concentrations of TMZ. These results provide a mechanistic basis for combining, and timing, chemotherapy and drug resistant immunotherapy to treat GBM.

29. Redirected Allogeneic T Cells for Adoptive Cell Therapy of Cancer

Assaf Marcus,¹ Tova Waks,¹ Zelig Eshhar.¹
¹Immunology, Weizmann Institute of Science, Rehovot, Israel.

Based on our vast experience in using genetically engineered T cells whose specificity is redirected with antibody-based chimeric receptor (T-bodies) we hypothesized that combining together the specificity of anti-tumor T-bodies and the allo-reactivity of mismatched T cells can provide a powerful tool for adoptive cell therapy of cancer. To establish the conditions to allow allogeneic donor T cells to function in a cancer-bearing host without causing graft versus host disease (GVHD) on the one hand or be rejected by the host (host versus graft (HvG) we partially lymphodepleted the host and tuned the dose of the grafted allogeneic T-bodies. In a murine model for experimental systemic metastases using Renca-Her2/neu tumor we compared the anti-tumor effect of allogeneic and syngeneic T-bodies expressing Her2/neu specific chimeric receptor. We transferred Her2/neu T-bodies after sublethal lymphodepletion to mice with systemic metastatic disease. A single treatment with allo-T-bodies extended the survival of tumor-bearing mice to a similar (or larger) extent compared to syngeneic ‘T-bodies’ and remarkably more than

unspecific allogeneic T cells. Blocking lymphocyte egress from the lymph nodes by sphingosine-1-phosphate analog, significantly extended persistence of fully mismatched T cells, and dramatically extended the survival of tumor free mice treated with allogeneic but not syngeneic 'T-bodies. Therefore we suggest that ex-vivo generated MHC-mismatched 'T-bodies' can be universally applied for 'off-the-shelf' immuno-gene-therapy, and that their graft versus host reactivity can be safely harnessed to potentiate allogeneic adoptive therapy.

30. Optimization of a Gamma-Retroviral Vector Co-Expressing a Prostate-Specific Membrane Antigen-Targeted Chimeric Antigen Receptor (PSMA-CAR) and HSVTK for the Treatment of Metastatic Prostate Cancer

Xiuyan Wang,¹ Oriana Borquez-Ojeda,¹ Jolanta Stefansk,¹ Jason Plotkin,³ Steven Poon,³ Jinrong Qu,¹ Teresa Wasielewska,¹ Larrisa Shenker,⁵ Vladimi Ponomarev,⁵ Susan Slovin,² Michel Sadelain,^{1,2,3,4} Isabelle Rivière.^{1,2,3,4}

¹Gene Transfer and Somatic Cell Engineering Laboratory, Memorial Sloan-Kettering Cancer Center, New York; ²Department of Medicine, Memorial Sloan-Kettering Cancer Center, New York; ³Center for Cell Engineering, Memorial Sloan-Kettering Cancer Center, New York; ⁴Molecular Pharmacology and Chemistry Program, Memorial Sloan-Kettering Cancer Center, New York; ⁵Department of Radiology, Memorial Sloan-Kettering Cancer Center, New York.

Prostate cancer is the most common non-skin malignant cancer in men and is the second leading cause of death following lung cancer. For subjects with overt metastatic disease, treatment options following androgen ablation remain limited. Tumor specific immunotherapies are attractive alternatives to the conventional chemotherapy. PSMA (prostate-specific membrane antigen) is a prognostic marker for prostate cancer, which is expressed at 1000-fold higher levels in tumors than in normal prostate epithelium. This makes PSMA an attractive target for T cells that are redirected by a non MHC-restricted antigen receptor. To enhance the anti-tumor functions of genetically targeted T cells, we have developed a second generation chimeric antigen receptor (CAR) generated from a single chain fragment, derived from a murine PSMA specific monoclonal antibody variable region, fused to the transmembrane and intracellular signaling domains of the co-stimulatory receptor CD28 and the cytoplasmic signaling domain of the T cell receptor associated CD3 zeta chain. To facilitate the in vivo imaging of adoptively transferred T cells and ensure the safety of this approach, the Herpes simplex virus-1 thymidine kinase (hsvtk) gene is coexpressed with the PSMA specific CAR. Here we compare the expression of the PSMA specific CAR (P28z) using either the EMCV internal ribosomal entry site (IRES) or the picornavirus 2A proteinase. We observe that T cells transduced with TK-2A-P28z vector were more effective than T cells transduced with TK-IRES-P28z vector to eradicate pre-established metastatic lung cancer caused by murine prostate cancer cell line RM1 in SCID/Beige mice. This was in part due to the higher level of expression of the P28z CAR conferred by the 2A element. Hence, adoptive transfer of autologous T cells transduced with the TK-2A-P28z vector may provide a promising therapeutic approach for the treatment of metastatic prostate cancer.

31. Specific Targeting of Interleukin-13 (IL-13) Receptor $\alpha 2$ -Positive Tumor Cells with Lentiviral Vectors Displaying IL-13

Wu Ou,¹ Michael P. Marino,¹ Bharat Joshi,¹ Andrea Maisner,² Evanthia Galanis,³ Raj K. Puri,¹ Jakob Reiser.¹

¹Division of Cellular and Gene Therapies, FDA/CBER, Bethesda, MD; ²Institute of Virology, Philipps University of Marburg, Marburg, Germany; ³Mayo Clinic, Rochester, MN.

The ability to efficiently and selectively target gene delivery to specific cell types *in vitro* and *in vivo* remains as one of the formidable challenges in gene therapy. Lentiviral vectors (LV) have many advantages that make them attractive as gene therapy vectors and their tropism can be altered through pseudotyping, allowing transgene delivery to specific populations of cells. The human IL-13 receptor $\alpha 2$ (hIL-13R $\alpha 2$) is overexpressed in many different human tumors, making it an attractive target for tumor therapy. In this study, we examined whether hIL-13R $\alpha 2$ -positive tumor cells can be specifically targeted with LV that are pseudotyped with a truncated fusion (F) protein (F_{ca30}) derived from measles virus (MV) and a tail-truncated and receptor-blind MV hemagglutinin (H) protein bearing IL-13 at the C-terminus (H_{ca18-Y481A/R533A}-hIL-13). We found that LV pseudotyped with the MV F_{ca30} and H_{ca18-Y481A/R533A}-hIL-13 proteins efficiently transduced HOS (human osteosarcoma) cells that were engineered to overexpress hIL-13R $\alpha 2$, but not parental HOS cells. More importantly, such vectors efficiently transduced human U251 glioma cells which naturally express high levels of hIL-13R $\alpha 2$, but not T98G glioma cells expressing low levels of hIL-13R $\alpha 2$. Transduction was highly specific as it could be blocked by using anti-hIL-13R $\alpha 2$ antibody or a recombinant human IL-13 R $\alpha 2$ Fc chimera. Currently, we are testing whether such vectors can specifically target IL-13R $\alpha 2$ human tumors in immunodeficient mice.

32. Serial Transplantation of MGMP140K-Transduced Bone Marrow and Dose-Intense Chemotherapy Selects for Clones with Distinct Insertions

Frank A. Giordano,¹ Ursula R. Sorg,² Jens-Uwe Appelt,¹ Nico Lachmann,³ Stephanie Bleier,⁴ Ingo Roeder,⁵ Veronika Kleff,⁶ W. Jens Zeller,⁴ Heike Allgayer,⁴ Christof von Kalle,¹ Stefan Fruehauf,⁷ Thomas Moritz,³ Stephanie Laufs.¹

¹Translational Oncology, National Center for Tumor Diseases (NCT), Heidelberg, Germany; ²Institute for Medical Microbiology and Hospital Hygiene, University of Dusseldorf, Dusseldorf, Germany; ³REBIRTH Center-of-Excellence, Reprogramming Group, Hannover Medical School, Hannover, Germany; ⁴Clinical Cooperation Unit Molecular Oncology of Solid Tumors, German Cancer Research Center (DKFZ), Heidelberg, Germany; ⁵Institute for Medical Informatics, Statistics and Epidemiology (IMISE), University of Leipzig, Leipzig, Germany; ⁶Institute of Anatomy, University of Duisburg-Essen Medical School, Essen, Germany; ⁷Center for Tumor Diagnostics and Therapy, Paracelsus Hospital, Osnabrueck, Germany.

Retroviral O6-methylguanine-DNA-methyltransferase (MGMP140K) gene therapy protects hematopoiesis from alkylating drugs and allows efficient in vivo selection of transduced hematopoietic stem cells (HSC). Insertional mutagenesis, and genotoxic alkylator therapy display considerable risk factors for future clinical applications of this approach. We used the gammaretroviral, MSCV-based vector MGMP140K-IRES-EGFP for transduction of HSC, which were then serially transplanted into female C57Bl/6 mice. Following repetitive, dose-intensive therapy with alkylating agents, we investigated the long-term clonality using ligation-mediated PCR (LM-PCR) and 454 sequencing. We identified 110 (1° recipients), 156 (2° recipients) and 197 (3° recipients) clones. 53 clones were

identified in all three cohorts. Several repopulating clones carried vector insertions in common integration sites (CIS) in or near genes playing roles in DNA damage response or cell death control such as G-protein-coupled receptor kinase 5 (Grk5), nuclear localized protein-1 / transcription factor 25 (Nulp1/Tef25) and β -tubulin class III (Tubb3), pointing to a vector-induced selection for distinct clones. Beside polyclonal reconstitution in the majority of mice, we also detected monoclonal repopulation patterns of a HSC clone showing a vector insertion in the Ubiquitin specific peptidase 10 (Usp10) gene which encodes a protein that upon DNA damage activates p53. Although neither Usp10, nor any of the genes that were seen to be located in CIS had been linked to clonal imbalance in previous studies, the monoclonal outgrowth of the Usp10 clone and the considerable number of hits in/near genes involved in DNA damage response and cell fate decision pathways point to vector-induced skewing of the clonal inventory. However, a confounding role of the intensive chemotherapy applied has to be considered since none of these integration sites appear to cause mono- or oligoclonality on their own and even in tertiary transplants, the vast majority of clones detected with insertions in and near these genes were detected in the context of polyclonal repopulation.

Novel Approaches for Gene Regulation & Genome Modification

33. Identification and Characterization of New Chromatin Insulators for Gene Therapy Vectors

David W. Emery,¹ Amy C. Groth,¹ Mingdong Liu,¹ Hao Wang,¹ John Stamatoyannopoulos,¹ George Stamatoyannopoulos.¹

¹*Departments of Medicine and Genome Sciences, and Institute for Stem Cell and Regenerative Medicine, University of Washington, Seattle.*

The prototypic chromatin insulator cHS4 has proven effective at reducing both the rate of vector-mediated genotoxicity and vector silencing for both gammaretroviral and lentiviral vectors. These attributes arise from the ability of this element to block the interaction of vector enhancers with (onco)genes surrounding sites of vector integration (enhancer-blocking insulation), and the spread of silencing heterochromatin into the vector provirus (barrier insulation). However, optimal enhancer-blocking activity has only been associated with use of an extended 1.2kb element that can reduce vector titers, and both activities are only partially effective. Towards the goal of developing alternative insulator elements with improved properties, we identified 25 elements from the erythroid human cell line K562 which exhibit properties of suspected chromatin insulators, including: i) DNase hypersensitivity; ii) ChIP binding by CTCF (associated with all enhancer-blocking insulators identified to date); and iii) in one case, co-binding by USF1/2 (associated with barrier insulator function of cHS4). All elements were initially screened using a novel lentiviral vector-based enhancer-blocking assay. These studies identified 23 of 25 elements as having at least some enhancer-blocking activity in at least one orientation, compared to 0 of 4 neutral controls. Of these, three elements exhibited stronger activity than the 1.2 kb cHS4 element (2.4 to 3.2-fold reduction in enhancer activity, compared to 2.1 \pm 0.4-fold for the cHS4 element). Subsequent analysis of these top three candidates by plasmid-based colony assays confirmed this high degree of enhancer-blocking activity (7.2 to 11.2-fold reduction in enhancer activity, compared to 6.0 \pm 0.8-fold for the cHS4 element). These elements were introduced into a gammaretroviral reporter vector, and the vectors were assessed in a genotoxicity assay based on tumor formation in mice transplanted with the factor-dependent cell line 32D. All three elements were found to reduce the rate of vector-mediated tumor formation (3.9 to 11.9-fold, compared to 5.6-fold for the cHS4 element), although the compound CTCF/USF candidate did reduce vector titers significantly. These gammaretroviral

vectors were also assessed in a mouse bone marrow transduction assay for barrier insulator activity. Two of the candidates improved the likelihood of vector GFP expression in transduced progenitor colonies nearly two-fold, from 27 \pm 26% for the uninsulated control, to 48 \pm 28% and 53 \pm 34%. Although this is below the 64 \pm 23% achieved with the cHS4 insulator, the improvement was nonetheless significant ($p=$.001). Surprisingly, the compound CTCF/USF candidate actually decreased the likelihood of vector expression by half, indicating that USF1/2 binding alone is not sufficient for barrier insulator activity. The top two new insulator candidates are smaller than the 1.2kb cHS4 insulator (1.0kb and 237bp), and actually increased vector titers. Taken together, we have identified at least two new insulator elements that can improve both the safety and expression of retroviral vectors.

34. TALE-Based Designer Nucleases: A Novel Platform To Edit the Human Genome

Claudio Mussolino,¹ Fabienne Luetge,¹ Robert Morbitzer,² Thomas Lahaye,² Toni Cathomen.¹

¹*Experimental Hematology, Hannover Medical School, Hannover, Germany;* ²*Institute of Genetics, University of Munich, Martinsried, Germany.*

Sequence-specific designer nucleases have evolved into a valuable gene therapy tool to induce targeted genome modifications. Traditionally, zinc-finger nucleases (ZFNs) have been widely used to specifically modify genomes of different complexity. Here, we have developed a novel platform of designer nucleases based on the highly specific DNA binding domains of transcription activator-like effectors (TALEs) from *Xanthomonas* plant pathogens. In order to identify the minimal requirements for DNA binding, a panel of N- and C-terminal deletion variants from the TALEs AvrBs3 and AvrBs4 were generated and fused to a VP16 transcriptional activation domain to activate expression of an inducible reporter gene. Then, TALE-based nucleases (TALENs) were generated by combining the TALE deletion variants with the catalytic domain of the FokI endonuclease. The most favorable parameters for efficient DNA target site cleavage by TALEN with regard to protein architecture and DNA spacer requirement were determined by *in vitro* cleavage assays. Finally, the most optimal TALEN architectures were used to disrupt the EGFP gene in a human reporter cell line. A side-by-side comparison with ZFNs showed for both nuclease types a significant reduction in EGFP expressing cells of >20%, but as compared to ZFNs, no TALEN-associated toxicity could be determined. Taken together these results show that TALENs combine high nuclease activity with minimal cytotoxicity, revealing the great potential of this novel platform for targeted modifications of the human genome.

35. Engineering XID(Btk) Site Specific I-Anil Homing Endonuclease for Gene Repair in Hematopoietic Stem Cells

Yupeng Wang,¹ Jordan Jarjour,^{1,2} James Havranek,³ Summer Thyme,³ David Baker,³ Andrew M. Scharenberg,^{1,2} David J. Rawlings.^{1,2}

¹*Center for Immunity and Immunotherapies, Seattle Children's Research Institute, Seattle, WA;* ²*Departments of Pediatrics and Immunology, University of Washington, Seattle, WA;* ³*Department of Biochemistry, University of Washington, Seattle, WA.*

X-linked agammaglobulinemia (XLA), a human immunodeficiency caused by mutations in Bruton tyrosine kinase (Btk), represents an ideal candidate disease for hematopoietic stem cell (HSC) gene therapy. However, current gene replacement methods including viral vectors carry risks of insertional mutagenesis as well as gene silencing. In contrast, gene repair induced by site specific DNA double strand breaks offers a novel means to treat genetic disease

with potentially less risk and the potential to utilize endogenous control elements for gene expression. LAGLIDADG Homing Endonucleases (LHEs) have been shown to efficiently induce site specific double strand breaks and markerless modification of genes without toxicity. However, the limited number of site specific LHEs currently available limits their application in gene therapy. Thus, engineering site specific LHEs represents a critical step for enabling technology for double strand break-induced gene modification. In the current study we have combined rational computational design with flow cytometry-based high throughput selection using yeast surface display system to engineer a site specific variant of the LHE I-AniI, targeted to recognize a unique mutation in the mouse BTK gene in the XID model of human XLA. Using these combinatorial methods we have successfully generated a panel of I-AniI variants with novel DNA cleavage specificity towards partial XID sites with multiple base changes. The cleavage activity of selected variants was further improved by directed evolution after introducing random mutations by error-prone PCR. Based on partial target sites designs, I-AniI variants targeted to full XID site will be engineered by either combinatorial or progressive approaches. The information from characterizing I-AniI designs will be utilized to refine the rational computational design model. Ultimately, the new I-AniI variant (for induction of site specific double strand breaks) and donor DNA repair template will be delivered into lin- HSC (or B cell progenitors) derived from XID/ Tec-/- mice using non-integrating lentiviral vectors; and evaluated for capacity to re-engraft and reconstitute B lineage development and function *in vivo*.

36. Human Cardiac Troponin T Regulatory Cassettes Facilitate High-Level Transient Expression in Differentiating Skeletal Muscle and Continuous Expression in Cardiac Muscle

Xiaolan Chen,¹ Quynh V. Nguyen,¹ Guy L. Odom,¹ Eric E. Finn,¹ Robert E. Welikson,¹ John C. Angello,¹ Jeffrey S. Chamberlain,¹ Stephen D. Hauschka.¹

¹Biochemistry & Neurology, University of Washington, Seattle, WA.

Recombinant adeno-associated viral vectors (rAAV) represent an attractive tool for efficient delivery of therapeutic proteins or RNAs throughout the body. However, in the case of diseases that affect specialized cell types, tissue-specific expression is beneficial for decreasing potentially harmful immune responses against ectopic transgene expression. Here we describe a novel regulatory cassette based upon human cardiac troponin T (cTnT) enhancer/promoter regions. Sequence alignment among six mammalian species showed significant blocks of sequence conservation within these regions. Sequential deletions of non-conserved portions as well as several conserved regions lead to a more compact and yet active human cTnT cassette. Further improvement of transcriptional activity was achieved by ligating two tandem cTnT enhancers to the cTnT promoter. In vitro dual luciferase assays showed that a modified human cTnT cassette (455bp, cTnT455) exhibited remarkably high transcriptional activity in rat neonatal cardiomyocytes and was inactive in non-muscle cell lines. Following rAAV-6 retro-orbital delivery in mice, cTnT455 directed high level expression in heart exclusively, while expression in skeletal muscles and non-muscle tissues was extremely low (>300-fold higher in the heart than in the gastrocnemius muscle and liver). Interestingly though, cTnT455 was also active in differentiating mouse skeletal muscle cell cultures (MM14 and C2C12). This transient expression in differentiating skeletal muscle fibers mimics that of the endogenous cTnT gene during normal mammalian myogenesis. cTnT455's *in vivo* cardiac muscle-specificity was further confirmed by immunostaining cryo-sectioned heart and skeletal muscle samples; only cardiac muscle was immuno-positive for the reporter. cTnT455 is thus a highly compact, active and tissue-specific cassette suitable for rAAV-mediated gene therapy of cardiac muscle,

and for transient expression in regenerating skeletal muscle fibers during their initial differentiation. Research supported by the NIH and MDA. Additional studies analyzed regulatory cassettes containing a single cTnT enhancer combined with the muscle creatine kinase-based cassette CK7. The combinatorial cassette has transcriptional activity equivalent to that of CK7 in some skeletal muscles (e.g. quadriceps), and higher activity in others (e.g. extensor digitorum longus). The combinatorial cassette also had twice the transcriptional activity of the CK7 cassette in cardiac muscle. Therefore, the cTnT-CK7 regulatory cassette would be particularly useful for systemic expression in both skeletal and cardiac muscle. Research supported by the NIH and MDA.

37. Modifying Target Structure Greatly Improves the Efficiency of microRNA-Regulated Vectors

Alessia Baccarini,¹ Hemangina Chauhan,¹ Thomas Gardner,¹ Albert Ruzo,¹ Ravi Sachidanandam,¹ Brian Brown.¹

¹Genetics and Genomic Sciences, Mount Sinai School of Medicine, New York, NY.

Recently, we and others have begun to exploit endogenous microRNA regulation for targeting the expression of exogenously delivered genes and viruses. By incorporating target sites for a specific microRNA into a transgene or the open reading frame of a virus, expression becomes susceptible to regulation in cells where that microRNA is expressed. This approach has been used to improve the efficacy and safety of various gene and stem cell therapies, viral oncolytics, and pathogen vaccines. While this technology can be an effective means to re-target expression of a transgene, overexpression of synthetic microRNA target sites can potentially saturate the cognate microRNA and lead to dysregulation of endogenous targets. To understand the factors that contribute to this phenomenon, we carried out studies to look at the impact of target concentration and structure on the associated microRNA. By quantitating the number of molecules of the microRNA and its target in steady-state, and in the course of its decay, we found that each microRNA molecule was able to regulate multiple transcripts, providing *in vivo* evidence that the microRNA is multiple-turnover. Using deep-sequencing, we further show that microRNA recycling is limited by target regulation, which promotes post-transcriptional modifications to the 3' end of the microRNA, and accelerates the microRNA's rate of decay. Specifically, we found that the microRNA's half-life went from 25 hours in cells expressing a low level of target to 15 hours when the target was expressed at saturating levels, and the frequency of extra-uridylylated miRNA isoforms increased to nearly 50% during the course of the miRNA's decay. Thus, while our results indicate that microRNA regulation is multiple-turnover, target regulation can increase the microRNA's rate of decay, and alter the microRNA's steady-state concentration. Because we found that target regulation promoted 3' uridylylation of the microRNA, we modified the structure of the target site in the vector to abrogate pairing with the 3' end of the microRNA. Using this design we were able to extend the half-life of the microRNA to nearly 25 hours, even at supraphysiological target concentration, and this led to more sustained target regulation. These results reveal one of the mechanisms that impact microRNA expression levels, and have important implications for the development of microRNA-regulated vectors for gene therapy, as well as microRNA sponges and decoys for inhibiting microRNA activity. Studies are now underway to evaluate the use of this approach on a panel of microRNA-regulated vectors for targeting transgene expression to a variety of cell lineages.

38. A Transgene Encoded Cell Surface EGFR Polypeptide for Selection, In Vivo Tracking and Ablation of Engineered Cells

Xiuli Wang,¹ Wen-Chung Chang,¹ ChingLam W. Wong,¹ David Colcher,¹ Mark Sherman,¹ Julie R. Ostberg,¹ Stanley R. Riddell,² Stephen J. Forman,¹ Michael C. Jensen.^{1,3}

¹Dept of Cancer Immunotherapeutics & Tumor Immunology, Beckman Research Institute, City of Hope, Duarte, CA; ²Program in Immunology, Fred Hutchinson Cancer Research Center, University of Washington School of Medicine, Seattle, WA; ³Center for Immunity and Immunotherapies, Division of Hematology and Oncology, Seattle Children's Research Institute, Seattle, WA.

In the field of cellular therapy, genetic engineering approaches are being studied to endow cells with novel attributes, either to increase their therapeutic potency or safety. A variety of human cell surface polypeptides have been previously described for cell marking; however, none of these candidates simultaneously satisfy the criteria of being unique to the genetically modified hematopoietic/lymphoid cell, of lacking functionality, and of having a commercially available pharmaceutical-grade monoclonal antibody specific for an epitope present in the extracellular portion of the polypeptide. Here we describe a truncated human EGFR polypeptide (huEGFRt) that is devoid of extracellular N-terminal ligand binding domains and intracellular receptor tyrosine kinase activity, but retains the native amino acid sequence, type I transmembrane cell surface localization, and a conformationally intact binding epitope for the pharmaceutical-grade anti-EGFR mAb, cetuximab (ErbixTM). Following lentiviral transduction of human T cells with vectors that coordinately express tumor specific chimeric antigen receptors (CARs) and huEGFRt, we demonstrate that biotinylated-cetuximab mediated immunomagnetic selection results in coordinate enrichment of CAR⁺-cells from 2% to over 90%. The huEGFRt-mediated selection did not affect the phenotype (i.e., TCR, CD3, CD4, CD8, CD28, and granzyme A expression), the in vitro expansion potential, nor the in vivo engraftment fitness (upon transfer into immunodeficient mice) of the T cells. Direct examination of EGF-binding and phosphotyrosine analysis confirmed that this selection marker is functionally inert and has no negative effect on the T cell product. In addition, cytotoxicity against B cell malignancies and IFN- γ /TNF- α production through the CD19-specific CAR was dramatically enhanced in the huEGFRt-selected population. The utility of huEGFRt in tracking the gene modified, transferred cells in vivo within easily obtained human tissues such as blood, bone marrow and tissue biopsies was then also proven via detection of huEGFRt using multiparameter flow cytometric analysis or FDA approved immunohistochemical techniques/reagents. In addition, we were able to demonstrate that ErbixTM could mediate ADCC of huEGFRt⁺ T cells in vitro and inhibit the growth of huEGFRt⁺ CTLL2 cells in NOD/Scid mice, supporting the use of huEGFRt as a suicide gene via cetuximab-mediated ADCC after adoptive transfer. Together these data suggest that the versatility of huEGFRt and the availability of pharmaceutical-grade reagents for clinical applications denote huEGFRt as a significant new tool for cellular engineering.

39. Evaluation of an AAV2-Based Rapamycin-Regulated Glial Cell-Derived Neurotrophic Factor (GDNF) Expression Vector System

Piotr Hadaczek,¹ Janine Beyer,¹ Wade Narrow,² William Bowers,² Howard J. Federoff,³ John Forsayeth,¹ Krystof S. Bankiewicz.¹

¹Neurological Surgery, University of California San Francisco, San Francisco, CA; ²Neurology, University of Rochester Medical Center, Rochester, NY; ³Neurology and Neuroscience, Georgetown University Medical Center, Washington, DC.

Effective regulation of transgene product in anatomically circumscribed brain tissue is dependent on the pharmacokinetics of the regulating agent, the kinetics of transcriptional activation and of the transgene product. We evaluated rapamycin-regulated AAV2-GDNF expression in the rat striatum. Regulated and constitutive expression vectors were compared. Constitutively active AAV2-GDNF directed stable GDNF expression in a dose-dependent manner and it increased for the first month, thereafter reaching a plateau that was maintained over a further 3 months. This system drives permanent GDNF expression with no means to regulate GDNF level within the targeted brain structure. For the AAV2-regGDNF, rapamycin was administered in a 3-days on/4-days off cycle (based on the kinetics of GDNF induction from the AAV2-regGDNF in presence of rapamycin). Intraperitoneal and oral delivery (CED) of rapamycin was evaluated. Two cycles of rapamycin at an intraperitoneal dose of 10 mg/kg, gave the highest GDNF level (2.75 ± 0.01 ng/mg protein). However, 10 mg/kg is not a tolerable clinical dose. We therefore investigated chronic dosing with more clinically compatible regimens. Three cycles of 1 or 3 mg/kg gave GDNF levels lower than with 10 mg/kg. However, 3 mg/kg provided GDNF levels of 0.80 ± 0.42 ng/mg protein comparable to levels reported to be neuroprotective against MPTP in marmosets. This level was further enhanced by 6 cycles of 3×3 mg/kg to 1.36 ± 0.3 ng GDNF/mg protein, approximately 50% of the level obtained after a single cycle of 10 mg/kg of rapamycin. These data suggest that high steady-state levels of GDNF in brain tissue can be achieved by chronic dosing. Our studies demonstrate the effectiveness of rapamycin regulation in the brain. If GDNF gene therapy is to become a truly practical mode of treatment of PD, the therapeutic gene will need to be expressed at controlled levels. As we have shown, these levels will depend on the dose of the administered vector and, in case of regulated vectors, the precise dosing regimes of the inducing agents. No research team has yet been able to advance a regulated gene therapy vector into clinical study. Clinical validation of the rapamycin-regulated expression system would be a major innovation in gene therapy, and would likely trigger renewed interest in applications of this approach.

40. Targeted Delivery of IDUA across the Blood-Brain Barrier for Treatment of MPS Type I

Daren Wang,¹ Alex Kuan,² David Hui,³ Dao Pan.^{1,4}

¹Division of Experimental Hematology and Cancer Biology, Cincinnati Children's Hospital Medical Center, Cincinnati; ²Division of Developmental Biology, Cincinnati Children's Hospital Medical Center, Cincinnati; ³Department of Pathology, University of Cincinnati, Cincinnati; ⁴Department of Pediatrics, University of Cincinnati, Cincinnati.

Mucopolysaccharidosis (MPS) type I, resulting from the deficiency of the enzyme α -L-iduronidase (IDUA), is one of the most common lysosomal storage disorders affecting the CNS that cannot be cured by current treatments. Systemic delivery of IDUA via circulation can be an ideal noninvasive method for CNS treatment if they can cross the blood-brain barrier (BBB). We investigate in this study if the fusion of receptor binding domain (Rb) of Apolipoproteins to IDUA can enable the modified protein to bind members of low-density lipoprotein receptor family (LDLRf) on BBB and transcytose to the CNS. To

determine the accessibility of IDUA protein for genetic modification, we first engineered a myc-tag in-frame fused at 5' or 3' of human IDUA coding sequence. We observed that IDUA3'Myc not only retained normal biological function, lysosomal enzyme trafficking, and endogenous receptor-mediated uptake pathway, but also acquired additional myc-antibody binding ability. We then constructed seven fusion IDUA-Rb candidates containing various amino acid residues within the receptor-binding regions of apolipoproteins. Medium containing each of the IDUA-Rb fusion proteins were exposed to CHO^{LDLR^{-/-}}-LRP1 cells that overexpressed LDLR-associated protein 1 (LRP1) (highly expressed on BBB) but was knockout for LDLR. Two fusion protein candidates introduced protein uptake that could not only be partially inhibited by M6P, but also be significantly blocked by RAP for LRP1 inhibition. The specific binding of fusion IDUA-Rb to LRP1 was further confirmed by a pause-chase assay. These two candidates were then evaluated with an *in vitro* BBB model using collagen-coated transwells. Both IDUA-Rb candidates introduced IDUA levels significantly higher than IDUA3'Myc control in the lower chambers after pause-chase with the same amounts of IDUA activities on the top chambers. Finally, we evaluated the potential brain delivery of IDUA-Rb *in vivo* by hydrodynamic injection into MPS I mice with plasmids introducing liver-specific expression of fusion proteins. Elevated IDUA activities (22-120 fold of normal levels) were found in plasma of all MPS I mice 2 days after injection. These *in vivo* secreted fusion proteins could be captured by immunoprecipitation assay and were catalytically active. Moreover, capillary-depleted brain tissues from well-perfused animals injected with IDUA-Rb exhibited significant IDUA activities (3-5% of heterozygous levels), while only background levels of IDUA were detected in those from IDUA3'Myc controls. Immunofluorescent analyses have identified IDUA-Rb positive cells mostly in non-endothelium perivascular cells, neurons, and less so in astrocytes. In summary, we have identified two Rb candidates by *in vitro* and *in vivo* evaluation that could mediate efficient IDUA delivery across the BBB. This study would open a door for novel, non-invasive approaches in treating neurological lysosomal storage diseases.

Genetic and Metabolic Diseases Gene & Cell Therapy I

41. Correction of Murine Rag Deficiencies by Self-Inactivating Lentiviral Vector-Mediated Gene Transfer

Karin Pike-Overzet,^{1,2} Mark Rodijk,^{1,2} Yuk-Yin Ng,^{1,2} Miranda R. M. Baert,^{1,2} Chantal Lagresle,³ Axel Schambach,⁴ Rob C. Hoeben,¹ Salima Hacein-Bey-Abina,³ Arjen C. Lankester,¹ Robbert G. M. Bredius,¹ Gertjan J. A. Driessen,² Christopher Baum,⁴ Marina Cavazzana-Calvo,³ Jacques J. M. van Dongen,² Frank J. T. Staal.^{1,2}
¹LUMC, Leiden, Netherlands; ²ErasmusMC, Rotterdam, Netherlands; ³INSERM, Hôpital Necker-Enfants Malades, Paris, France; ⁴Hannover Medical School, Hannover, Germany.

Severe combined immunodeficiency (SCID) patients with an inactivating mutation in recombination activation gene (RAG) 1 or 2 lack B- and T lymphocytes due to the inability to rearrange immunoglobulin (Ig) and T-cell receptor (TCR) genes. Gene therapy is a valid treatment option for RAG-SCID, especially for patients lacking a suitable bone marrow (BM) donor, but developing such therapy has proven challenging. As a preclinical model for RAG-SCID gene therapy we used *Rag1*^{-/-} or *Rag2*^{-/-} mice and lentiviral (LV) SIN vectors harboring different internal elements (EFS, SFFV or A2UCOE) to deliver native or codon-optimized human *RAG1* or *RAG2* sequences. Treatment with select vectors resulted in appearance of B- and T cells in peripheral blood and developing B- and T cells were found in BM and thymus. Serum Ig levels, Ig and TCR V β gene-segment usage was similar to wild-type (WT) controls, demonstrating

RAG-mediated rearrangements. Remarkably, WT levels of serum Ig in treated *Rag1*^{-/-} and *Rag2*^{-/-} mice were produced by relatively low numbers of B cells, whereas T-cell numbers often came close to WT levels. Upon stimulation of the TCR, corrected spleen cells divided and produced IL-2 and IFN γ . *In vivo* elicitation of a T-cell dependent B-cell response by injecting TNP-KLH resulted in production of TNP-specific antibodies, confirming proper cooperation of B and T cells. Toxicity related to ectopic RAG1 or RAG2 expression was not seen. Comparing native and codon-optimized *RAG1*-vectors *in vivo*, the VCN found in BM 19 weeks after transplantation is 3 to 13-fold higher in recipients of cells transduced with the native *RAG1* vector. In contrast, *RAG1* expression in SFFV.*RAG1*-treated mice was 2.5-fold lower than SFFV.co*RAG1*-treated mice. On a per-copy basis, this resulted in an 18-fold higher *RAG1* expression in SFFV.co*RAG1*-treated mice. Comparable benefits were not found for codon-optimized *RAG2* vectors. Evaluating transgene expression in BM, thymus and spleen cells for UCOE.co*RAG1* and SFFV.co*RAG1*-treated mice 20 weeks after transplantation, the UCOE.co*RAG1* vector gave a 5 to 20-fold higher expression per integrated vector. These properties allowed for correction of the *Rag1*^{-/-} phenotype, while limiting the VCN. In that respect, the UCOE.co*RAG1* SIN lentiviral vector looks promising for clinical application. Functional reconstitution of the B- and T-cell compartment provides proof-of-principle for therapeutic *RAG* gene-transfer in *Rag*-deficient mice using LV SIN vectors. Codon-optimization seems of critical importance to obtain sufficient *RAG1* expression levels at the low VCNs desired for gene therapy. In conclusion, fine-tuning the use of promoters or promoter-like elements combined with post-transcriptional improvements, such as codon-optimizing the *RAG1* coding sequence, has brought us closer to clinical application of LV-based gene therapy for RAG-SCID patients.

42. Distribution of Lentiviral Vectors in Gene Therapy for X-Adrenoleukodystrophy

Cynthia C. Bartholomae,¹ Nathalie Cartier,^{2,3} Salima Hacein-Bey Abina,^{2,4} Ina Kutschera,¹ Maximilian Schliesser,¹ Bruno l'Homme,² Alain Fischer,^{2,4} Marina Cavazzana-Calvo,^{2,4} Patrick Aubourg,^{2,3} Manfred Schmidt,¹ Christof von Kalle.¹
¹Department of Translational Oncology, German Cancer Research Center and National Center for Tumor Diseases, Heidelberg, Germany; ²University Paris-Descartes, Paris, France; ³Hopital Saint-Vincent de Paul, Paris, France; ⁴Hopital Necker-Enfants Malades, Paris, France.

Gene therapy using retroviral vectors has been successful in treating monogenic diseases, but insertion of functional retrovirus LTRs can lead to severe side effects. Lentiviral vectors with self-inactivating (SIN) configuration are a promising alternative showing a reduced genotoxic risk. Here, we report on the first clinical trial using HIV-1 lentiviral SIN-vector to treat monogenetic diseases. The treatment of the genetic defect in cerebral adrenoleukodystrophy (X-ALD) showed stable and sustained restoration, and is so far not accompanied by signs of clonal dominance or even premalignant disproportional distribution of cellular contributions. We performed a large scale vector integration sites (IS) analysis on *ex vivo* transduced cells prior to reinfusion and on engrafted cells (P1: 6-36 months (M); P2: 6-28 M; P3: 2-24 M) by LAM-PCR and subsequent pyrosequencing on samples from the first three patients treated by now (unique mappable IS: P1: 2979; P2: 2123, P3: 4373). Our results revealed the expected insertion profiles for lentiviral vectors, showing gene coding regions as preferred targets for lentiviral vector integration (P1: 74%; P2: 76%; P3: 72%), in line with a favored integration on chromosomes harboring gene dense regions. Identical IS identified in myeloid and lymphoid lineages in P1, P2 and in P3, respectively, are indicating a successful *ex vivo* transduction of early hematopoietic progenitors. Interestingly, insertion of the lentiviral vector as common integration

sites in the same genes or genomic regions have been observed in all three patients, likely reflecting a preference of lentiviral vector insertion for particular genes. Among others, the following genes were hit: KDM2A, SMG6, HLA, PACS1, ASH1L. High throughput distribution analysis of the IS repertoire indicates that lentivirus vectors offer great promise for safe and effective correction of human stem and progenitor cells.

43. Integration Site Analysis in a Benign Hemangioma That Developed in the Spleen at 8 Years after Neonatal IV Injection of a gamma Retroviral Vector into a Mucopolysaccharidosis VII Dog

Katherine P. Ponder,¹ Thomas O'Malley,² Anna Paruzynski,³ Christina Lulay,³ Manfred Schmidt,³ Christof von Kalle,³ Patricia O'Donnell,² Mark E. Haskins.²

¹Internal Medicine, Washington University School of Medicine, St. Louis, MO; ²Pathobiology, University of Pennsylvania School of Veterinary Medicine, Philadelphia, PA; ³Department of Translational Oncology, National Center for Tumor Diseases and German Cancer Research Center, Heidelberg, Germany.

Mucopolysaccharidosis (MPS) VII is due to deficient activity of the lysosomal enzyme β -glucuronidase (GUSB) and results in the accumulation of glycosaminoglycans. Clinical manifestations include reduced mobility, cardiac abnormalities, skeletal dysplasia, and mental retardation. We previously reported that neonatal gene therapy markedly reduced the clinical manifestations, and now report that it increases the average survival from 3 months in untreated MPS VII dogs to 9 years in RV-treated dogs. We also now report integration site analysis in a benign splenic hemangioma that developed at 8 years in M1328 (Roy Rogers). M1328 received an IV injection at 3 days after birth of 4×10^9 transducing units of an amphotropic Moloney murine leukemia-based RV with the human $\alpha 1$ -antitrypsin promoter (liver-specific), the canine GUSB cDNA, and the WPRE in the same orientation as an intact LTR. Serum GUSB activity was stable for 5 years at 508 units (U)/ml (1.9-fold normal). Thereafter, serum GUSB activity increased progressively to reach 4710 U/ml at 8.7 years (9-fold baseline), which prompted evaluation for an RV-expressing tumor. Ultrasound demonstrated an 8-cm splenic mass, which led to euthanasia. The mass was a hemangioma, a benign tumor of endothelial cell origin that occurs frequently in dogs. The tumor lacked histochemical markers of a malignant hemangiosarcoma, and no metastases were present. The estimated doubling time was 1 year based upon the rate of increase of the serum GUSB activity. Cells from the tumor adhered to plastic and could be passaged, and resembled endothelial cells. The cultured cells had high GUSB activity and RNA, and contained ~ 10 copies per cell of RV. Sequence analysis on genomic DNA using LAM-PCR identified 6 integrations sites present in both the crude tumor and cultured cells. These included integrations within intron 2 of HMGA2 (high mobility group protein AT hook 2), intron 2 of VAV2 (guanine nucleotide exchange factor), and intron 6 of SMG6 (nonsense-mediated mRNA decay factor; also called Evi108). Two and nine integrations have been observed in the mouse retrovirus tagged cancer gene database for HMGA2 and SMG6, respectively, while homologs of VAV2 are known to have oncogenic properties. In addition, clonal expansion of cells with an integration of a lentiviral vector within the HMGA2 locus was noted in humans with thalassemia. None of 19 other RV-treated dogs have developed tumors, and there was no clonal expansion of hepatocytes found with histochemical staining. We conclude that IV injection of an LTR-intact gamma RV can result in transduction of endothelial cells in the spleen, and that integration within one of the genes noted above may have contributed to the development of a benign hemangioma.

44. Repeated Lentivirus-Mediated G-CSF Delivery To Treat Canine Cyclic Neutropenia

Ofer Yanay,¹ Cheryl Adler,¹ David C. Dale,² William R. Osborne.¹
¹Pediatrics, University of Washington, Seattle, WA; ²Medicine, University of Washington, Seattle, WA.

Cyclic neutropenia occurs in humans and grey collie dogs, is characterized by recurrent neutropenia and is treated by daily injections of recombinant granulocyte colony stimulating factor (rG-CSF). We have previously shown that grey collie dogs can be treated by single administration of G-CSF-lentivirus. As dose escalation of lentivirus may be clinically necessary we monitored the outcome of four sequential G-CSF-lentivirus administrations to Buster, a normal dog and Sugar, a grey collie. Subcutaneous injection of rG-CSF (2 μ g/Kg) to Buster gave significantly increased neutrophil counts of 25,750 \pm 1,380 cells/ μ l over the pretreatment level of 3,280 \pm 1,600 cells/ μ l ($p < 0.001$). We then serially administered intramuscularly four doses of 3×10^7 infectious units per Kg of body weight of a lentivirus vector encoding canine G-CSF cDNA pseudotyped with VSV-G envelope. Absolute neutrophil counts were significantly increased after each dose of virus with mean levels of 27,750 \pm 3,000; 31,500 \pm 1,400; 35,050 \pm 1,680, 43,880 \pm 2,940 cells/ μ l respectfully ($p < 0.001$). Buster was adopted from our institution and has mean elevated neutrophil counts of 31,180 \pm 7,810 cells/ μ l for over 6 years and is healthy with no adverse effects. Sugar showed neutrophil cycling with a mean count of 1,940 \pm 1,480 cells/ μ l and was treated with rG-CSF administered subcutaneously at escalating doses of 0.5, 1.0, 2.0 μ g/Kg each weekday for two weeks. Although neutrophil counts continued to cycle they were significantly increased with mean values of 7,130 \pm 4,790; 11,210 \pm 5,160 and 15,850 \pm 6,140 cells/ μ l respectively ($p < 0.05$). After demonstrating that rG-CSF produced dose dependent neutrophil production, cytokine administration was stopped and we serially administered intramuscularly four doses of 3×10^7 infectious units of G-CSF-lentivirus per Kg of body weight. After the first virus administration we observed sustained elevations in neutrophil levels for over 5 months with a mean of 26,000 \pm 11,000 cells/ μ l that was significantly increased over the highest level of rG-CSF ($p < 0.05$). Following the second and third virus administration mean neutrophil counts of 15,800 \pm 6,140 and 11,520 \pm 4,900 cells/ μ l were monitored over a 5 and 3 month period respectively that were significantly reduced over cell counts following the first virus administration ($p < 0.001$). However, following the 4th virus administration mean neutrophil counts of 15,210 \pm 4,500 cells/ μ l were observed that were significantly increased over the previous two viruses ($p < 0.05$). Throughout these virus administrations Sugar gained weight, was healthy and showed neutrophil counts significantly higher than pretreatment levels ($p < 0.001$). Sugar was adopted from our institution and was healthy and free of infections for 55 months after the first virus administration. These studies show a normal dog and a grey collie responded to repeat administration of G-CSF lentivirus by sustained increases in neutrophils, suggesting the absence of lentivirus-mediated immune responses to repeated lentivirus injections. Thus, a desired level of neutrophil production to treat patients with cyclic and other neutropenias may be achieved by escalating doses of lentivirus.

45. Balloon Delivery of Helper-Dependent Adenoviral Vector Results in Sustained hFIX Expression in Rhesus Macaques

Nicola Brunetti-Pierri,¹ Amiee Liou,² Priti Patel,² Donna Palmer,³ Nathan Grove,³ Karen Rice,⁴ Milton Finegold,⁵ Arthur Beaudet,³ Charles Mullins,² Philip Ng.³

¹Telethon Institute of Genetics and Medicine, Naples, Italy;

²Cardiology, Baylor College of Medicine, Houston, TX; ³Molecular and Human Genetics, Baylor College of Medicine, Houston, TX;

⁴Southwest Foundation for Biomedical Research, San Antonio, TX;

⁵Pathology, Baylor College of Medicine, Houston, TX.

Hemophilia B is an excellent candidate for gene therapy because $\geq 1\%$ of factor IX results in clinical improvement of bleeding diathesis. Helper-dependent adenoviral (HDAd) vectors hold tremendous potential because they mediate long-term transgene expression without chronic toxicity. We investigated HDAd for hemophilia B gene therapy in the rhesus macaque model. To accomplish this, four animals were infused weekly with recombinant human FIX (hFIX) protein prior to HDAd to mimic the clinical scenario of hemophilia B patients. Then, 1E12, 1E11, 3E10, or 1E10 vp/kg of a HDAd expressing hFIX was administered using a balloon catheter-based method we had previously shown to enhance hepatocyte transduction efficiency up to 80-fold (PMID19050700). In this minimally invasive approach, a balloon catheter is percutaneously positioned in the inferior vena cava to occlude hepatic venous outflow and the HDAd is injected into the liver via a percutaneously placed hepatic artery catheter. The animals injected with 1E12 and 1E11 vp/kg achieved sustained therapeutic levels of hFIX (~28% for up to 590 days and ~10% for up to 566 days, respectively). For 3E10 and 1E10 vp/kg, hFIX could be detected for up to 336 days, but levels were sub-therapeutic (<1%).

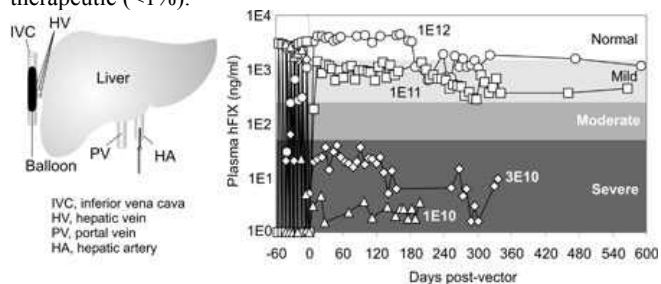

Therefore, the minimum therapeutic dose appears to be between 3E10 and 1E11 vp/kg, at least in this particular model. All HDAd doses resulted in negligible AST and ALT elevations and no clinical manifestation of toxicity. At 1E12 vp/kg transient anti-hFIX antibodies (Ab), but not neutralizing anti-hFIX Ab, were observed. Anti-hFIX Ab (neutralizing or not) were not observed with 1E11 vp/kg. Sustained low titer (up to 2 BU/ml) and high titer (up to 91 BU/ml) neutralizing anti-hFIX Ab were observed with 3E10 and 1E10 vp/kg, respectively. Development of neutralizing, but not necessarily non-neutralizing Ab is a serious concern. Thus, it is interesting that development of neutralizing Ab against hFIX appeared inversely correlated to hFIX levels suggesting that high hFIX levels may be tolerizing. Thus, development of more potent HDAds and/or improved delivery strategies to achieve higher hFIX levels with lower vector doses is warranted. Nevertheless, these results indicate that a single administration of HDAd at a clinically relevant dose of 1E11 vp/kg by a minimally invasive delivery method results in long-term therapeutic levels of hFIX in a nonhuman primate and may represent a first step towards potential clinical application.

46. Outcomes of AAV8 and AAV5-Mediated Fetal Gene Transfer at 0.9G in Non-Human Primates

Citra N. Mattar,¹ Amit Nathwani,² Simon Waddington,³ Niraja Dighe,¹ Christine Kaeppl,⁴ Ali Nowrouzi,⁴ Jenny McIntosh,² Nuryanti Johana,¹ Nicholas Fisk,⁵ Andrew Davidoff,⁶ Jens-Uwe Appelt,⁴ Christof von Kalle,⁴ Manfred Schmidt,⁴ Arijit Biswas,¹ Mahesh Choolani,¹ Jerry K. Y. Chan.^{1,7,8}

¹Experimental Fetal Medicine Group, National University of Singapore, Singapore, Singapore; ²University College London, London, United Kingdom; ³Institute for Women's Health, UCL, London, United Kingdom; ⁴German Cancer Research Center and National Center for Tumor Diseases, Heidelberg, Germany; ⁵University of Queensland Centre for Clinical Research, Brisbane, Australia; ⁶St Jude Children's Research Hospital, Memphis; ⁷KK Women's and Children's Hospital, Singapore, Singapore; ⁸Duke-NUS Graduate Medical School, Singapore, Singapore.

Fetal gene transfer (FGT) is a useful strategy for lethal monogenic diseases. Important considerations are vector efficiency, effects of gender and growth on expression, and germ-line or oncogenic mutations. We analyse long-term outcomes in macaques prenatally treated with scAAV2/8- or 2/5-LP1-hFIXco that address these concerns. Seronegative macaque fetuses were injected with 4E+12 vector genomes (vg) of the appropriate construct at 0.9G (140 days) via the intrahepatic vein under ultrasound guidance (US). Levels and tissue-specificity of human Factor IX (hFIX) expression, humoral response and vector bio-distribution were monitored. Integration analysis was performed by LAM-PCR. Maternal ovarian stimulation, oocyte harvest and purification were done to assess germline transmission. Six of 12 macaques in total who received 1-2E+13vg/kg birthweight were monitored long-term. hFIX expression at birth was significantly higher with AAV8 (n=5) than with AAV5 (n=7; median 15.0 vs. 1.1 $\mu\text{g/mL}$, $p=0.005$). Expression peaked at 15 days postnatal and declined to a plateau by 30 days. Steady-state hFIX was higher in long-term animals treated with AAV8 (n=2) than with AAV5 (n=4; 5.0 vs 0.6 $\mu\text{g/mL}$, $p<0.0001$). Males (n=3) expressed hFIX at higher levels compared to female (n=3) offspring (20.4 vs 1.7 $\mu\text{g/mL}$ at the peak and 3.1 vs 0.4 $\mu\text{g/mL}$ in steady-state, $p=0.0002$). With both vectors hFIX expression was liver-specific and remained at therapeutic levels for up to 22 months (duration of follow up). Hepatic vector copy number (VCN) decreased with time from FGT and was stable between 6 and 12 months in 4 animals monitored for more than one year, with no difference in median hepatic VCN between AAV8 and AAV5. To address the stability of hFIX levels and hepatic VCN, integration analysis was performed. The majority of AAV persisted as episomes although random integration accounted for 10% of readouts with no hotspots identified. There was no occurrence of tumours. Harvested maternal oocytes were purified of follicular cells. No evidence of proviral DNA was found in pure oocytes. A single IV injection of AAV8 or AAV5 achieves stable therapeutic expression of hFIX in our non-human primate model of FGT. Serotype and gender are influential as AAV8 and males demonstrated higher hFIX expression. Random vector integration was observed at low frequency, and there was no evidence of maternal germline transmission. Designing a FGT strategy requires consideration of these factors which will potentially affect clinical outcomes.

47. Longterm and Sustained Knockdown of Mutant AAT along with Simultaneous Augmentation of Wildtype AAT with a Single Dual Function Vector Has Minimal Effect on Global Liver miRNA Profiles

Christian Muller,¹ Qiushi Tang,¹ Lina Song,¹ Phillip D. Zamore,² Terence R. Flotte.¹

¹Pediatrics and Gene Therapy Center, UMass Medical School, Worcester, MA; ²Biochemistry and Molecular Pharmacology, UMass Medical School, Worcester, MA.

Alpha-1 antitrypsin (AAT) is one of the primary circulating serum anti-proteases in humans. AAT is normally produced within hepatocytes and macrophages, where hepatocyte-derived AAT forms the bulk of the physiologic reserve of AAT. Approximately 4% of the North Americans possess at least one copy of a mutant allele, known as PiZ which results from a single amino acid substitution of lysine for glutamate at position 342. This mutation leads to severe deficiency of AAT, and can result in two distinct pathologic states: a lung disease which is primarily due to the loss of antiprotease function, and a liver disease due to a toxic gain of function of the PiZ-AAT mutant protein. Since mutant AAT-PiZ exhibits a gain-of-function hepatocellular toxicity accumulating in the endoplasmic reticulum, decreasing AAT-PiZ mRNA levels (and therefore the protein) may ameliorate or even reverse the liver pathology. In addition, increased secretion of functional AAT protein will theoretically protect the lungs from neutrophil elastase and associated proteolytic enzymes. We have developed several rAAV vectors that allows us to deliver MicroRNAs (miRNAs) within a similar proviral cassette expressing AAT as used in our rAAV-AAT clinical trials. The vectors incorporate miRNA sequences targeting the AAT gene while driving the expression of hardened wildtype AAT gene, thus achieving concomitant mutant AAT knockdown in the liver with increased expression of wildtype AAT. Transgenic mice expressing the human PiZ allele were injected with control or dual function rAAV9 vectors expressing both miRNAs and a hardened AAT gene with a cMyc tag at a dose of 1x10E12 particles. Serum PiZ levels were consistently knocked down by an average of 80% from baseline levels with the knockdown being stable and persistent throughout the 13 week experiment. Cohorts receiving dual function vectors showed knockdown of PiZ AAT while secreting increased serum levels of wildtype AAT as determined by a cMyc ELISA. Liver histology in treated mice revealed significant decreased globular accumulation of misfolded PiZ AAT in hepatocytes along with a reduction in inflammatory infiltrates when compared to controls. To determine if rAAV delivered miRNAs would have an effect on global miRNA expression profiles of the liver, samples from controls and treated mice were compared using a miRNA microarray. Results from the microarray studies showed that miRNA profiles were minimally affected by artificial miRNA delivered by rAAV, with only 3 miRNAs showing statistically significant differences. The largest difference was seen in mir-1 which was actually reduced in PiZ transgenic mice receiving rAAV to normal levels seen in wildtype B6 mice. The levels of miR-122 were unaffected in all mice receiving rAAVs expressing miRNA targeting the AAT gene. In conclusion dual function rAAV vectors are effective at knocking down PIZ AAT while simultaneously augmenting wildtype AAT without disturbing endogenous miRNA liver profiles.

48. In Vivo AAV-Mediated Gene Repair Is Enhanced by the DNA-PK Inhibitor Vanillin

Nicole K. Paulk,¹ Milton Finegold,² Markus Grompe.¹

¹Oregon Stem Cell Center, Oregon Health & Science University, Portland, OR; ²Department of Pathology, Texas Children's Hospital, Houston, TX.

Gene therapy is a promising treatment to cure many monogenic diseases; however, traditional gene therapy is best suited to treat diseases of deficient or absent gene products rather than those caused by aberrantly functioning proteins. A potential solution would be manipulating genomes *in vivo* using site-specific recombination to modify genetic information. Gene repair by vector-mediated homologous recombination is an attractive concept, in that it restores gene function within the context of endogenous regulatory elements, thus eliminating problems of inadequate or inappropriate expression. However, the low frequency of correction *in vivo* has been prohibitive. To date, the best frequency of targeted integration *in vivo* for any cell type is only 1%. Many diseases necessitate a higher rate of stable integration (>10%) than is currently possible to achieve. Methods to increase correction to therapeutic levels are needed. One approach to enhancing targeting is a transient block of undesired repair pathways like non-homologous end-joining (NHEJ) to promote the sole use of the homologous recombination pathway. NHEJ is the primary pathway of double strand break repair in post-embryonic human cells. The natural product vanillin (3-methoxy-4-hydroxybenzaldehyde), acts as a potent inhibitor of NHEJ by binding to and selectively inhibiting DNA-PK. Vanillin is a known antimutagen, anticlastogen, antioxidant, antimicrobial and displays antineoplastic activity. Vanillin's action is highly selective to DNA-PK and has no effect on other steps of NHEJ or on unrelated protein kinases. Additionally, vanillin is an FDA-approved food additive for human consumption, thus an off-label use for gene therapy is feasible. Previous work from our lab has shown conventional rAAV capable of *in vivo* correction of the model metabolic liver disease hereditary tyrosinemia type I (HTI). The vector contained a 4.5Kb insert containing a portion of the fumarylacetoacetate hydrolase (*Fah*) gene mutated in HTI. Hepatic correction frequencies of up to 1% were achieved in mice with a point mutation in *Fah* using normal AAV dose ranges. To increase correction frequencies to more therapeutic levels, we have administered daily vanillin IP injections at 100mg/kg for 5-7 days following one time IV AAV injection. Preliminary results show an at least 6-fold increase in gene repair with vanillin administration over AAV alone. Further studies examining varying doses and days of administration are ongoing in adult and neonatal mice to determine optimal administration protocols. Importantly, *in vivo* genetic confirmation that NHEJ inhibition is the responsible factor and not a reaction to vanillin itself, are ongoing in mice doubly mutant for *Fah* and *Ku70*.

Presidential Symposium

49. In Vivo Delivery of Zinc Finger Nucleases Mediates Genome Editing To Correct Genetic Disease

Michael Holmes,² Hojun Li,¹ Virginia Haurigot,¹ Yannick Doyon,²

James Li,² Anand Bhagwat,¹ Sunnie Wong,² Xavier Anguela,¹

Rajiv Sharma,¹ Sam Murphy,¹ Fayaz Khazi,¹ Shangzhen Zhou,¹

David Paschon,² Ed Rebar,² Philip Gregory,² Katherine High.^{1,3}

¹CHOP, Philadelphia, PA; ²Sangamo Biosc, Richmond, CA;

³HHMI, Philadelphia, PA.

Disease-causing gene mutations can potentially be corrected *in situ* within the genome through genome editing and targeted gene replacement. The development of zinc finger nucleases (ZFNs) to create targeted double-strand breaks (DSBs) has permitted efficient

genome editing in cultured cells. As ZFN-mediated genome editing has yet to be assessed *in vivo*, we sought to determine if *in vivo* delivery of ZFNs can stimulate genome editing to correct a genetic disease. We made human factor IX gene (F9)-specific ZFNs with the goal of correcting Hemophilia B (HB). One ZFN pair, targeting F9 intron 1, induced a DSB in 45% of F9 alleles in K562 cells, and when coupled with a targeting (donor) vector, mediated targeted gene insertion in 18% of alleles. For *in vivo* ZFN testing, we made a ROSA26 knock-in mouse with liver-specific expression of a catalytic-domain deleted human F9 mini-gene (hF9mut). Targeted insertion of w.t. F9 exons 2-8 into intron 1 would allow for splicing with the genomic exon 1 to produce w.t. factor IX (F.IX). AAV8(1e11vg) delivery of ZFNs to adult hF9mut mouse liver induced a DSB in 34-47% of alleles, as assayed by detection of repaired DSBs. As homology-directed repair is predicted to be most efficient in S/G2 of the cell cycle, we next performed targeting experiments in neonatal mice (whose rapidly dividing hepatocytes contrast with non-dividing adult hepatocytes). Although neonatal delivery (5e10vg) resulted in ZFN expression loss over time and 60% less DSB induction efficiency than in adult mice, combining ZFN and AAV8-donor vector (2.5e11vg) resulted in targeted insertion of exons 2-8 into intron 1. No targeted insertion was detected in mice receiving Mock+donor, or ZFN-alone controls. ZFN+donor mice (n=16) averaged 120-350ng/mL circulating F.IX (2-7% of normal) up to 8 months post-treatment, while ZFN-alone (n=17) and Mock+donor (n=15) mice had <25ng/mL F.IX. Stable genomic insertion was confirmed as no loss of F.IX expression occurred in ZFN+donor mice following partial hepatectomy, which causes loss of expression from non-integrated episomes. Moreover, w.t. mice lacking the hF9mut knock-in (i.e. no ZFN target site) had F.IX levels <30ng/mL despite receiving both ZFN+donor vectors, suggesting the majority of F.IX expression resulted from targeted insertion at the intended locus rather than random integration. To assess the effect of ZFN-mediated gene correction on an HB impaired clotting phenotype, we crossed mouse F.IX-deficient mice with hF9mut mice. HB/hF9mut mice receiving ZFN+donor had a significantly (p=0.001) shortened clotting time (44 sec avg) in the aPTT assay compared to Mock+donor mice (60 sec avg). Importantly, this degree of phenotypic correction resulted in aPTTs which were not significantly different (p=0.09) compared to w.t. mice with normal levels of F.IX. These data are the first demonstration that *in vivo* ZFN delivery mediates genome editing to correct genetic disease, opening a novel paradigm of *in vivo* gene therapy.

50. Demonstration of Safety and Antitumoral Activity of JX-594, a Targeted Multi-Mechanistic Oncolytic Poxvirus, Following Intravenous Infusion and/or Intratumoral Injections in Patients with Refractory Metastatic Cancers

Caroline Breitbach,¹ James Burke,¹ Anne Moon,¹ Tae-Ho Hwang,² John C. Bell,^{1,3} David H. Kim.¹
¹Jennerex Inc, San Francisco; ²Pusan National University, Busan, Republic of Korea; ³Center for Cancer Therapeutics, Ottawa Hospital Research Institute, Ottawa, ON, Canada.

JX-594 is a first-in-class targeted oncolytic poxvirus engineered to selectively replicate in and destroy cancer cells with cell cycle abnormalities and epidermal growth factor receptor (EGFR)/ras pathway activation. Direct oncolysis plus granulocyte macrophage – colony stimulating factor (GM-CSF) expression also stimulates tumor vascular shutdown and anti-tumoral immunity. Expression of the β -galactosidase marker transgene allows for monitoring of JX-594 replication in patients. Over 95 cancer patients have been treated by intravenous (IV) and/or intratumoral (IT) injections on one of eight Phase 1 or Phase 2 trials to date, including two ongoing Phase 2 trials in patients with primary liver cancer. Treatment with JX-594 by either route of administration was well-tolerated at the 1×10^9

plaque forming units (pfu) dose level, representing the maximum tolerated dose (MTD) following IT JX-594 injection; the MTD was not reached following IV JX-594 infusion. The most common adverse events were dose-related flu-like symptoms generally resolving within 24 hours following JX-594 administration. JX-594 was detected acutely in the serum following either IT or IV treatment. Delayed JX-594 reappearance (day 3-15) in the bloodstream after initial clearance was observed in a subset of patients and is consistent with replication at the tumor sites and release into the blood. Expression of JX-594 transgenes was observed in patients treated by IT or IV administration; GM-CSF could be detected in post-treatment serum and correlated with induction of white blood cells. Furthermore, induction of antibodies to the β -galactosidase marker protein was observed in patients treated with JX-594 IV or IT, demonstrating gene expression *in vivo*. Objective radiographic tumor responses (RECIST and Choi criteria) and tumor vascular disruption have been observed in patients with metastatic cancers following JX-594 treatment IT (injected and non-injected tumors) or IV; Choi (necrotic) responses have been observed in approximately two-thirds of patients treated on Phase 2 trials. Finally, multiple long-term survivors (>= 12 months in treatment-refractory patients) have been reported on JX-594 trials; in a randomized liver cancer study, patients treated with high dose JX-594 exhibited a survival advantage when compared to the low dose group. A randomized, placebo-controlled trial of JX-594 in patients with refractory primary liver cancer is planned to be initiated in 2011.

51. A Phase I Dose-Escalating Study of AAV1 – γ -Sarcoglycan Gene Therapy for Limb Girdle Muscular Dystrophy Type 2C

Serge Herson,¹ Fayçal Hentati,² Aude Rigolet,¹ Norma B. Romero,³ Anthony Behin,³ France Leturcq,⁴ Pascal Laforet,³ Thierry Maisonobe,³ Rim Amouri,² Hafedh Haddad,⁵ Muriel Audit,⁶ Marie-Françoise Rosier-Montus,⁵ Bernard Gjata,⁵ Carole Masurier,⁵ François M. Lemoine,⁷ Pierre Carlier,⁴ Jean-Yves Hogrel,⁴ Bruno Eymard,⁴ Lee Sweeney,⁸ Richard Mulligan,⁹ David Klatzmann,⁷ Mustapha Cheraï,⁷ Didier Caizergues,⁵ Thomas Voit,⁴ Olivier Benveniste.¹

¹Internal Medicine, Université Pierre et Marie Curie, Assistance Publique-Hôpitaux de Paris, Hôpital Pitié-Salpêtrière, Paris, France; ²Department of Molecular Neurobiology and Neuropathology, National Institute of Neurology, Tunis, Tunisia; ³Institute of Myology, Université Pierre et Marie Curie, Assistance Publique-Hôpitaux de Paris, Hôpital Pitié-Salpêtrière, Paris, France; ⁴Laboratoire de Biochimie Génétique, Assistance Publique-Hôpitaux de Paris, Hôpital Cochin, Paris, France; ⁵Généthon, Evry, France; ⁶GenoSafe, Evry, France; ⁷UMR 7211, CNRS, Université Pierre et Marie Curie, Assistance Publique-Hôpitaux de Paris, Hôpital Pitié-Salpêtrière, Paris, France; ⁸Department of Physiology, School of Medicine, University of Pennsylvania, Philadelphia, PA; ⁹Harvard Gene Therapy Initiative, Department of Genetics, Harvard Medical School, Boston, MA.

OBJECTIVE: Safety of dose-escalating AAV1 – γ -sarcoglycan gene therapy (Phase I) for Limb Girdle Muscular Dystrophy type 2C. **BACKGROUND:** Gamma-sarcoglycanopathy or limb girdle muscular dystrophy type 2C (LGMD 2C) is an as yet untreatable disease caused by autosomal recessively inherited mutations of the γ -sarcoglycan gene (γ SGC). **DESIGN/METHODS:** Nine non-ambulant LGMD2C patients (2 M, 7 F, age 27 y [16 to 38]), with a del525T homozygous mutation on the γ SGC gene and absence of γ SGC immunostaining in muscle biopsy were enrolled. They were divided into 3 groups to receive 3 escalating doses of an AAV1 vector expressing human γ SGC gene under the control of the desmin promoter, by local intramuscular injection into the extensor carpi radialis muscle. The first group received a single injection of $3e+9$ viral genome (vg) in 100 μ l, the

second a single injection of 1.5×10^{10} vg in 100 μ l and the third group received 3 concomitant 100 μ l injections at the same site (a total of 4.5×10^{10} vg). RESULTS: No serious side effects were observed. All patients became seropositive for AAV1 and one developed a cytotoxic response against AAV1 capsid. In biopsy specimens taken 30 days after the injections, immunohistochemistry showed γ SGC expression in 5/9 patients, with 4.7 to 10.5% of positively stained fibers and detection of γ SGC mRNA by RT-PCR in the 3 patients who received the highest dose. The γ SGC protein became also detectable by Western blot in one patient. CONCLUSIONS: Exogenous γ SGC expression can be obtained in LGMD2C patients following AAV1 gene transfer, without adverse effects, paving the way for future developments in gene therapy of hereditary muscle diseases.

52. Efficient Long-Term Bodywide Expression of an AAV9-Minidystrophin in the Muscle and Heart of Young Adult GRMD Dogs after Intravascular Injection without Immune Suppression

Juan Li,¹ Chunping Qiao,¹ Janet Bogan,² Dan Bogan,² Ruhang Tang,¹ JianBin Li,¹ Chunlian Chen,¹ Hui Zheng,¹ Jennifer Dow,² Joe N. Kornegay,² Xiao Xiao.²

¹Division of Molecular Pharmaceutics, Eshelman School of Pharmacy, University of North Carolina, Chapel Hill, NC;

²Department of Pathology, School of Medicine, University of North Carolina at Chapel Hill, Chapel Hill, NC.

Previously we reported that AAV9 rendered long-term bodywide expression of a human minidystrophin after intravenous injection in neonatal golden retriever muscular dystrophy (GRMD) dogs; and that AAV8 achieved long-term expression of a canine minidys in the limb muscles after isolated limb vein perfusion in young adult GRMD. Here we report that long-term (≥ 2 years) and bodywide AAV9-minidys expression was also achieved without any immune intervention in young adult GRMD dogs, either by isolated limb vein perfusion or by simple intravenous (i.v.) injection. Methods: 1) Isolated limb perfusion. Three GRMD dogs received 1×10^{13} v.g./kg vector. Dog Jelly (2 mon old; 6.3 kg) was given AAV9-CMV-opti-hMinidys (codon-optimized human minidys); while Jasper and Peridot (4 mon old; 12.2 kg and 12.5 kg) were given AAV9-CMV-cMinidys (canine minidys). The vectors were injected via leg vein with a tourniquet placed at hindlimb proximal extremity for 10 minutes. Muscle biopsies were taken at 2, 7, 12 & 24 months and analyzed. 2) Intra-venous injection. Dog Duncan (2.5 mon old; 6.5 kg) was given a simple i.v. injection of AAV9-MS-opti-hMinidys (muscle-specific promoter) at the dose of 4×10^{13} v.g./kg. Biopsy and necropsy were done at 4 and 12 months. Results: 1) In the limb perfusion study, all 3 dogs had long-term, widespread minidys expression in all muscle biopsies with improved histology. The most important finding was that both injected and non-injected limb had minidys expression. Up to 70% of myofibers were minidys positive in certain muscle groups without discernable T-cell infiltration. Both legs showed similar degree of expression. The human minidys persisted for ≥ 2 years (last biopsy) in Jelly, now 4 years of age. But in Jasper and Peridot, injected with a canine minidys gene without codon-optimization, stronger expression was always seen in the vector-injected legs in the 22 months time course. No minidys was detected in the heart. 2) In the intravenous injection study, dog Duncan showed robust and uniform minidys expression in the majority of the skeletal muscles for 1 year (duration of the study). The most important finding is the efficient, MS promoter-mediated cardiac expression, which was previously found very weak or undetectable in the heart with the CMV promoter. Conclusions: 1) AAV9 achieved systemic minidys gene delivery after isolated limb perfusion, possibly due to incomplete tourniquet blockade; 2) A simple i.v. injection of AAV9-MS-opti-hMinidys achieved robust and long-term bodywide expression; 3) Efficient cardiac expression after i.v. injection is most likely due to

the use of muscle-specific promoter; 4) Long-term expression of both human or canine minidys under the control of different promoters suggest the lack of or minimal cellular immunity. The mechanisms remain elusive and warrant further studies.

Adenovirus and Other DNA Virus Vectors II: Response to Vectors

53. An HSV Based Selection Method for Isolation of Negative Regulators of TRPV1

Bonnie Reinhart,¹ Asaff Harel,¹ Justus B. Cohen,¹ Joseph C. Glorioso.¹

¹Department of Microbiology and Molecular Genetics, University of Pittsburgh School of Medicine, Pittsburgh, PA.

Chronic pain occurs when normal control of acute pain signaling is lost, resulting in reduced stimuli thresholds and hypersensitive sensory neurons. The transient receptor potential vanilloid channel (TRPV1) is a pro-nociceptive cation channel that is activated in response to noxious stimuli such as capsaicin, heat, or low pH. TRPV1 is functionally up-regulated in pathophysiological states such as painful diabetic neuropathy, cystopathy and chronic inflammation. TRPV1 function is modulated by several known cellular factors including calmodulin, PKC, PKA and CAMKII. We have developed an HSV replication-based selection strategy to identify novel proteins that negatively regulate TRPV1. Briefly, in the presence of capsaicin, over-expression of TRPV1 from a replication-competent HSV vector causes calcium influx and cell death, thereby inhibiting virus growth. Expression of a cDNA library from this backbone should allow replication of only those vectors expressing factors that negatively modulate TRPV1 activity. We created a replication-competent Gateway vector that expresses two copies of TRPV1 from an early gene promoter to reduce the possibility of isolating TRPV1 mutants that fail to mediate calcium uptake and to ensure that selected inhibitory genes actually affect TRPV1 activity. The percentage of false positives obtained when this vector was grown in the presence of capsaicin was dramatically reduced when compared to a vector expressing only one copy of TRPV1. Moreover, a vector expressing TRPV1-poreless, a dominant-negative mutant that co-assembles with wild type receptors and creates defective channels, significantly improved virus yield in the presence of capsaicin. We next created a cDNA library derived from undifferentiated and NGF-differentiated PC12 cells and screened more than 400,000 clones for TRPV1 antagonists. Viruses that escaped capsaicin-induced cell death were isolated, the corresponding candidate cDNAs were introduced into a fresh selection vector backbone and retested for TRPV1 inhibition compared to a vector expressing TRPV1-poreless. One candidate rescued virus growth in the presence of capsaicin to a level similar to that observed for poreless-TRPV1 and is being further tested for its ability to block calcium uptake in primary neurons in response to capsaicin. The discovery of novel cellular factors that modulate TRPV1 function should provide insights into the role of TRPV1 in peripheral pain signaling and by extension, suggest novel approaches for their application to the control of primary hyperalgesia.

54. Interaction of Adenoviral Particles with Scavenger Receptors on Kupffer Cells Stimulates an Early, MyD88 Dependent Innate Immune Response In Vivo

Masataka Suzuki,¹ Terry K. Bertin,¹ Donna J. Palmer,¹ Racel G. Cela,¹ Margaretha Guenther,¹ Ming-Ming Jiang,¹ Kilian Guse,¹ Phil Ng,¹ Brendan H. I. Lee.^{1,2}

¹Molecular and Human Genetics, Baylor College of Medicine, Houston, TX; ²Howard Hughes Medical Institute, Houston, TX.

The host immune response includes many cellular and humoral factors and no single pathway accounts for the overall response to Ad-based vectors. The development of helper-dependent adenoviral vectors (HDAd), devoid of all functional viral genes, has largely overcome cell mediated host immune responses associated with viral proteins expressed by first-generation adenoviral vector (FGAd). However, the major obstacle for clinical translation in humans has been the dose-related acute toxicity associated with systemic delivery of therapeutic levels of Ad-based vectors. We have previously dissected cellular components of the innate response to HDAd utilizing genetic models, and have demonstrated that Toll-like receptors (i.e. TLR2 and TLR9) and Nod-like receptor, NOD2 contribute to the innate response to HDAds at 6 hours after systemic administration. However, a recent report showed that host animals/cells induce the innate responses independently of intracellular pathogen recognition receptors (PRRs) in spleens of mice within 1 hour, suggesting that exclusive focus upon the classic pathogen sensing pathway (e.g. TLRs) is insufficient to reveal the complete mechanism of the acute response to HDAd in gene therapy. In the present study, we have identified that an acute response to HDAd at 1 hour is dependent on viral dose and is independent of transgene/promoter sequences of vector DNA. We found that the host innate response to a human sub-lethal therapeutic dose (5x10¹¹ vp/kg) of HDAd at 1 hour is mainly regulated by the MyD88 signaling, but does not require TLR2, TLR9 nor IFN α R. PEGylation of HDAd attenuates the interaction with kupffer cells (KCs) and showed over 90% reduction of innate response compared to unmodified HDAd, demonstrating that the innate response at 1 hour is due to interaction of HDAd particles with KCs. Although coagulation factor FIX (but not FX) increases the transduction of HDAd to macrophages in vitro, coagulation factors minimally contribute to induction of the innate response to HDAd at 1 hour in vivo, because the negatively charged HDAd particle interacts with scavenger receptors (SRs) on KCs. Coagulation factors are also negatively charged proteins, suggesting that interaction of coagulation factors with HDAd in blood may increase not only the interaction with heparan sulfate proteoglycans on the cell surface but also the negative charge of HDAd thereby facilitating capture by SRs on KCs after systemic administration of HDAd.

55. Arming Adenovirus with CpG Motifs To Stimulate Innate and Adaptive Immune Response To Enhance Anti-Tumor Efficacy

Vincenzo Cerullo,¹ Valentina Romano,¹ Iulia Diaconu,¹ Matteo Ugolini,¹ Noora Rouvinen-Lagerström,¹ Akseli Hemminki.¹

¹Molecular and Cancer Biology, University of Helsinki, Helsinki, Finland.

Oncolytic viruses represent a novel tool for cancer treatment. In addition to specifically kill cancer cells (oncolysis), these agents also provide danger signals prompting the immune system to stimulate a anti-tumor immune response. As consequence of oncolysis, the innate and the adaptive arms of the immune system gain access to tumor antigens that results in cross-priming and vaccination effect. Here the aim was to study whether we could enhance this adjuvant capacity by incorporating immunostimulatory CpG motifs into the

genome of Adenovirus. Firstly we showed that a combination of oncolytic adenovirus with CpG-stimulating oligos had an increased anti-tumor activity compared with virus or CpG oligos alone in a xenograph model of lung cancer. This augmented anti-tumor activity was supported by an increased IL12p70 and interferon gamma (IFN- γ) production by the splenocytes harvested from the treated animals. Encouraged by these results, we engineered the genome of one of our oncolytic adenovirus (Ad5D24) inserting 12 immunostimulatory islands (Ad5D24-CpG). This newly generated virus was tested for its capacity to kill tumor cells in vitro in different human tumor cell line (PC3MM2, SKOV3, A549 and HeLa). In any of these cells line the CpG-rich virus showed increased tumor cell killing activity compared with the controls. Because TLR9 stimulation directly leads to the activation of NF κ B, we investigated whether this virus is able to stimulate human Toll-like receptor 9 (TLR9) more efficiently than Ad5D24 using NF κ B activation as endpoint. To this end we used genetically engineered HEK-293 cell line that only express TLR9. Cells were infected with Ad5D24 and Ad5D24-CpG and NF κ B activation was assessed over time. We found that cells infected with Ad5D24-CpG showed a significantly increased NF κ B activation compared with cells infected with Ad5D24 at different time points and different concentration of virus. Finally we wanted to investigate whether or not the CpG-rich adenovirus showed an enhanced anti-tumor activity compared with Ad5D24 in an in vivo model of lung cancer. To this end nude mice were implanted with subcutaneous model of lung cancer and treated as follow: Mock, Ad5D24, Ad5D24-CpG, Ad5D24 + Oligos CpG. Interestingly we observed that the group of mice treated with Ad5D24-CpG showed a significantly increased anti-tumor efficacy compared not only with Ad5D24 but also when compared with the combination of Ad5D24 and oligos CpG. To further investigate this phenomena, splenocytes from the treated mice were harvested, stimulated with UV inactivated virus or tumor cell lysate and co-cultured with tumor cell line. Interestingly, we find that, splenocytes harvested from the group of mice treated with the CpG-rich adenovirus were capable to kill tumor cells in vitro with significant increased efficiency compared with splenocytes harvested from control groups. In conclusion, we have generated the first genetically modified adenovirus able to enhance TLR9-stimulation and consequently its anti-tumor activity.

56. MicroRNA Control of HSV-1 Replication for the Treatment of Glioblastoma Multiforme

Lucia Mazzacurati,^{1,2} Marco Marzulli,¹ Bonnie Reinhart,¹ Justus B. Cohen,¹ Joseph C. Glorioso,¹ Paola Grandi.^{1,3}

¹Department of Microbiology and Molecular Genetics, University of Pittsburgh School of Medicine, Pittsburgh, PA; ²Department of Human Genetics, University of Pittsburgh, Pittsburgh, PA; ³Department of Neurological Surgery, University of Pittsburgh School of Medicine, Pittsburgh, PA.

Glioblastoma Multiforme (GBM) is an aggressive brain cancer for which there is no effective treatment. Oncolytic vectors (OVs) are attenuated lytic viruses that depend on characteristic defects in the anti-viral response of cancer cells to preferentially replicate and spread in tumors. OVs derived from herpes simplex virus type 1 (oHSV) have shown promise in the clinic, but their efficacy is limited due to poor replication in tumor cells. We have sought to develop a new class of OVs that can replicate essentially as unattenuated viruses in glioma cells, but are blocked for replication in normal cells of the brain. The design takes advantage of consistent differences in the expression of certain micro (mi)RNAs between normal brain tissue and tumor cells as a means to control the highly hierarchical progression of HSV lytic gene expression. MiRNAs are small non-coding RNAs involved in the regulation of a wide range of cellular functions, including cell growth, differentiation and the response to viral infections. They recognize their target mRNAs by base-pairing in the 3'UTR resulting

in either degradation or translational repression of their targets. Several miRNAs are abundantly expressed in cells of the CNS but are dramatically downregulated in glioblastoma cells, including mir-124, mir-128 and mir-137. We have introduced four tandem copies of the mir-124 recognition sequence into the 3'UTR of the viral ICP4 gene and found that replication in tumor cells was unaltered, but was greatly impaired by induction of mir-124 expression. Likewise, we have engineered vectors in which the 3'UTR of ICP27 mRNA is recognized by mir-128, mir-137, or both, and observed that these vectors as well replicate efficiently only in cancer cells. These results indicate that it is possible to maximize oHSV virulence in tumor cells without compromising their safety by taking advantage of signature differences in miRNA levels between glioblastoma and surrounding normal brain cells.

57. High-Capacity Adenoviral Vectors Induce Multispecific CD8 T Cell Responses and Show Improved Properties over 1st-Generation Vectors as Genetic Vaccines

Matthias W. Kron,¹ Tatjana Engler,¹ Schmidt Erika,¹ Reinhold Schirmbeck,² Stefan Kochanek,¹ Florian Kreppel.¹

¹University of Ulm, Department of Gene Therapy, Ulm, Germany;

²University of Ulm, Internal Medicine I, Ulm, Germany.

The high intrinsic immunogenicity of adenovirus vectors renders them one of the most potent genetic vaccines available. Capsid components and residual viral gene expression in transduced cells activate the innate immune system and create an inflammatory environment that favours the adaptive immune response against transgenic antigens. However, we could recently show that the multispecificity of the CD8 T cell responses against the transgenic antigen can be limited by leaky expression of adenoviral gene products as it occurs for 1st-generation Ad vectors (Schirmbeck et al., 2008). Overcoming this limitation and achieving a broad T cell specificity against many pathogenic epitopes could thus greatly improve the protective capacity of adenovirus-based genetic vaccines. We analyzed and compared the adaptive immune responses against the hepatitis B small surface antigen (HBsAg) delivered by either high-capacity Ad vectors which are devoid of all viral coding sequences or 1st-generation Ad vectors. These HC-Ad vectors are generally characterized by a much lower intrinsic immunogenicity compared to 1st-generation Ad vectors but hold great promise to avoid interference between transgenic and vector-derived epitopes. Analysis of CD8 T cell responses against the immunodominant Ld-restricted HBsAg-epitope in BALB/c mice over a period of 100 days revealed that HC-Ad vectors induced as strong CD8 T cell frequencies as 1st-generation Ad vectors did. Importantly, CD8 T cell responses against a subdominant Kb-restricted HBsAg-epitope in C57BL/6 mice were even 14-fold higher after vaccination with HC-Ad vectors suggesting that abrogation of residual viral gene expression could overcome vector-mediated suppression of T cell responses to subdominant epitopes. To further analyze the induction of specific CD8 T cell against subdominant HBsAg-epitopes we vaccinated Ld-deficient BALB/cdm2 mice to analyze responses to a Dd-restricted HBsAg-epitope. Specific CD8 T cells against this Dd-restricted epitope are not induced in Ld-positive BALB/c mice but can be primed in Ld-negative BALB/cdm2 mice. In these Ld-deficient BALB/cdm2 mice HC-Ad vectors induced up to 6-fold higher CD8 T cell responses than 1st-generation vectors. In contrast, 1st-generation Ad vectors showed no responses to the Dd-epitope in backcrossed F1dxb (BALB/cdm2 x B6) mice whereas HC-Ad vectors still induced sustained frequencies of Dd-specific CD8 T cells. Remarkably, anti-HBsAg antibody responses induced by HC-Ad were 4-14fold higher with an earlier onset already after 3 weeks when compared to 1st-generation vectors. Finally, we observed that a homologous prime-boost regimen with a late boost after 180 days is possible with

both types of Ad vectors but was much more efficient with the HC-Ad vector. Our data demonstrate superior properties of HC-Ad vectors as genetic vaccines regarding CD8 T cell multispecificity, magnitude of antibody responses and repeated delivery for booster injections in comparison to 1st-generation Ad vectors.

58. Oncolytic Adenovirus Expressing a Dual-Function Gene To Diagnose and Treat Pancreatic Cancer

Julia Davydova,¹ Miguel Trujillo,² Samantha McDonough,² Michael Oneal,² Eric Brown,¹ Joohee Han,¹ Selwyn Vickers,¹ John Morris,² Masato Yamamoto.¹

¹Surgery, University of Minnesota, Minneapolis, MN;

²Endocrinology, Mayo Clinic, Rochester, MN.

More than 90% of pancreatic cancer patients develop metastases which are often missed by existing imaging modalities. Even as imaging technologies for pancreatic cancer continue to improve none of them can provide definitive staging as contiguous tumor spread and vascular involvement affect the accuracy of tumor detection. As adjuvant chemotherapy and radiotherapy remain ineffective, it is clear that new interventions for pancreatic cancer are required. Improvements in diagnostic tools to facilitate more accurate staging will be expected to advance the progress of treatment. Oncolytic adenovirus (Ad) therapy represents a novel cancer treatment platform. In this research, we develop a novel dual-function Conditionally-Replicative Adenovirus (CRAd) expressing the sodium-iodide symporter (NIS) for combined radionuclide-based imaging and treatment of pancreatic cancer. NIS induces uptake of radioactive iodine by tumor cells and can be directly imaged using noninvasive scanning. NIS-based imaging will allow noninvasive staging of the disease, and more importantly, will allow therapy with ¹³¹I, enhancing the effect of viral therapy. First, we evaluated the *in vitro* cytotoxic effect of non-selective NIS expressing vectors in pancreatic cancer cell lines known to cause aggressive peritoneal dissemination. We observed high oncolytic potential of our vectors and confirmed the significant benefit of 5/3 modification and adenoviral death protein overexpression over the wild type Ad in killing S2VP10, S2013, AsPC1 and MiaPaca2 pancreatic cancer cells. Radioiodine uptake was shown to be time- and dose-dependent. To study *in vivo* NIS uptake and the effect of combination therapy with ¹³¹I, we established A549 subcutaneous tumors in nude mice. Oncolytic Ad-treated mice showed significantly improved radiotracer uptake than mice injected with a replication-defective NIS-Ad. Quantitative analysis of the images confirmed that the NIS-mediated ^{99m}TcO₄ accumulation with a replication-competent Ade3ADP-NIS increased with time as signals peaked 5-18 days post treatment compared to 1-4 days with a non-replicative NIS-Ad. Importantly, survival rate was improved when it was combined with radioiodine. These data confirmed the efficient *in vivo* NIS expression from the oncolytic adenovirus and feasibility of combination of enhanced adenovirus efficacy with radiotherapy. Next, we propagated and analyzed the 5/3 fiber-modified cyclooxygenase-2 (Cox2) promoter-selective vectors with the NIS transgene. Cox2 promoter was active in established pancreatic cancer cells and human pancreatic cancer specimens while exhibiting low activity in normal tissues including liver, the organ of most concern involving ectopic Ad gene expression. *In vitro*, our new CRAd could successfully drive virus replication in pancreatic cancer cells without hampering its selectivity and produce NIS uptake. Thus, our work provides proof-of-concept that by combining CRAd's enhanced antitumor effect with radiotherapy and NIS-based imaging we can create a new generation of theranostics to diagnose and treat pancreatic cancer.

59. Gene Therapy-Mediated Delivery of Targeted Cytotoxins for Glioma Therapeutics: Efficacy in the Absence of Neurotoxicity

Marianela Candolfi,¹ Weidong Xiong,¹ Kader Yagiz,¹ Chunyan Liu,¹ A. K. M. G. Muhammad,¹ Mariana Puntel,¹ David Foulad,¹ Ali Zadmehr,¹ Gabrielle Alzadeh,¹ Kurt M. Kroeger,¹ Matthew Tesarfreund,¹ Sharon Lee,¹ Waldemar Debinski,² Dhruv Sareen,³ Clive Svendsen,³ Ron Rodriguez,⁴ Pedro R. Lowenstein,¹ Maria G. Castro.¹

¹Gene Therapy Research Institute, Cedars Sinai Medical Center, Los Angeles, CA; ²Comprehensive Cancer Center of Wake Forest University, Winston-Salem, NC; ³Regenerative Medicine Institute at the Cedars-Sinai Medical Center, Los Angeles, CA; ⁴Johns Hopkins University School of Medicine, Baltimore, MD.

Restricting the cytotoxicity of anticancer agents by targeting receptors exclusively expressed on tumor cells is critical when treating infiltrative brain tumors, like glioblastoma multiforme (GBM). GBMs express an IL-13 receptor (IL13R α 2) that differs from the physiological IL4R/IL13R receptor. We developed a regulatable adenoviral vector (Ad.mhIL-4.TRE.mhIL-13-PE) encoding a mutated human IL-13 fused to *Pseudomonas* exotoxin (mhIL-13-PE) that specifically binds to IL13R α 2, to provide sustained expression, effective anti-GBM cytotoxicity and minimal neurotoxicity. The therapeutic Ad also encodes mutated human IL-4 that binds to the physiological IL4R/IL13R without interacting with IL-13R α 2, thus inhibiting potential binding of mhIL-13-PE to normal brain cells. Using intracranial GBM xenografts and syngeneic mouse models, we tested the Ad.mhIL-4.TRE.mhIL-13-PE and two protein formulations, i.e., hIL-13-PE used in clinical trials (Cintredekin Besudotox) and a second generation mhIL-13-PE. Cintredekin Besudotox doubled median survival, without eliciting long-term survival and caused severe neurotoxicity; mhIL-13-PE led to ~40% long term survival, eliciting severe neurological toxicity at the high dose tested. In contrast, Ad-mediated delivery of mhIL-13-PE led to tumor regression and long term survival in over 70% of the animals without causing apparent neurotoxicity. Although Cintredekin Besudotox was originally developed to target GBM, when tested in a Phase III trial, it failed to achieve clinical endpoints and revealed neurotoxicity. Limitations of Cintredekin Besudotox include its short half life, which demanded frequent or continued administration, and binding to IL4R/IL13R, present in normal brain cells. These shortcomings were overcome by our therapeutic Ad, thus representing a significant advance in the development of targeted therapeutics for GBM. Supported by grants from NIH/NINDS.

60. Kupffer Cell Evasion by a Hypervariable Region-Modified Adenovirus Vector

Reeti Khare,¹ Michael A. Barry.¹

¹Molecular Medicine, Mayo Clinic, Rochester, MN.

It is thought that up to 99% of systemically delivered adenovirus serotype 5 (Ad5) vector is depleted by liver Kupffer cells (KC) after intravenous injection. This loss necessitates that much larger doses of virus be used for liver-directed or systemic therapy. The use of large doses can also cause severe hepatotoxicity and exacerbate innate and adaptive immune responses against the virus. To avoid macrophage sequestration and necrosis, we generated Ad5/6GL, a hexon-chimeric Ad5 vector in which the hypervariable regions (HVRs) of species C Ad6 have been genetically introduced into Ad5. When injected into BALB/c mice, this chimeric virus mediates up to 50-fold increases in liver expression after i.v. injection. This effect appears to be due at least in part to evasion of Kupffer cells, since the Ad5/6 vector is not responsive to predosing and is taken up less efficiently by macrophages. This increased transduction was observed in hamsters, but was not always observed in other strains of mice, suggesting

strain-specific differences in interactions with the viruses. These data suggest that genetic modification of the Ad capsid can fundamentally alter its pharmacology and may indicate important differences in adenoviral uptake between animal models.

Chemical and Molecular Conjugates

61. Combinatorial Use of Block- and Homopolycation To Form DNA Polyplex Enhances Transgene Expressions in Mouse Lung with Minimal Toxicity

Satoshi Uchida,¹ Keiji Itaka,¹ Qixian Chen,² Kensuke Osada,² Takehiko Ishii,² Mariko Harada-Shiba,³ Masa-Aki Shibata,⁴ Kazunori Kataoka.^{1,2}

¹Division of Clinical Biotechnology, Center for Disease Biology and Integrative Medicine, Graduate School of Medicine, The University of Tokyo, Tokyo, Japan; ²Department of Materials Science and Engineering, Graduate School of Engineering, The University of Tokyo, Tokyo, Japan; ³Department of Molecular Pharmacology, National Cerebral and Cardiovascular Center Research Institute, Osaka, Japan; ⁴Department of Anatomy and Cell Biology, Division of Basic Medicine I, Osaka Medical College, Osaka, Japan.

Polycation-based gene carriers are potential candidates for successful gene therapy. PEGylation of carriers is a promising strategy to achieve effective gene expressions, especially for in vivo introduction. PEG shielding increases stability of carriers in the physiological conditions, and reduced toxicity by preventing non-specific interactions with surrounding molecules. However, PEG tends to reduce gene expression activity within the target cells by hampering the intracellular processing of carriers. In this study, we evaluated a new methodology to solve the dilemma of PEG. Using our original polycation, poly{N-[N-(2-aminoethyl)-2-aminoethyl]aspartamide} (PAsp(DET)) [1,2], in two forms of PEG-block-PAsp(DET) (B) and homo PAsp(DET) (H), we prepared DNA polyplexes by the combinatorial use of B and H with changing their mixing ratios, then evaluated the properties of polyplexes. In the physicochemical evaluation, the surface charge of DNA polyplexes remained almost neutral up to the equal ratio of B/H. In the meanwhile, the B/H polyplexes showed high transfection efficiencies comparable with H polyplexes in in vitro transfection. Then, we applied this system to in vivo intratracheal administration toward lung, because lung is a sensitive organ for pathogen and foreign materials, thus the harmless carriers are strongly needed to obtain sufficient gene expression. Indeed, in our previous study of gene transfer to lung by intratracheal administration, the B polyplexes showed higher expression in lung compared with PEI/DNA polyplexes [3]. The B/H polyplexes yielded one-order higher luciferase expressions than B polyplexes. To note is that the toxicity induced by B/H polyplexes in lung tissue appeared equal to that of B polyplexes. In the histopathological examination, the infiltration of inflammatory cells into alveolar space was rarely observed after administration of B/H polyplexes. The induction of inflammatory cytokine was minimal in B/H and B polyplexes, while H polyplexes evoked remarkable cytokine induction. Thus, it is strongly suggested that B/H polyplexes take each advantage of B and H, being a highly practical system to achieve high transfection efficiency with minimal toxicity. This system are promising for pulmonary gene therapy. 1. Kanayama et al. (2006). *ChemMedChem* 1: 439-44. 2. Itaka et al. (2010). *Biomaterials* 31: 3707-14. 3. Harada-Shiba et al. (2009). *Mol Ther* 17: 1180-6.

62. Polymeric Delivery of siRNA for P-Glycoprotein Down-Regulation in a Xenograft Tumor Model in NOD-SCID Mice

Meysam Abbasi,¹ Hamid M. Aliabadi,¹ Elaine Moase,¹ Kamaljit Kaur,¹ Charles Doillon,² Raymond Lai,¹ Afsaneh Lavasanifar,¹ Hasan Uludag.¹

¹University of Alberta, Edmonton, AB, Canada; ²Laval University, Quebec City, QC, Canada.

PURPOSE. Among the treatment options developed for cancer, the leading approach for a wide range of cancers is the chemotherapy. The efficacy of chemotherapy in many cancers is decreased due to over-expression of the drug transporter P-glycoprotein (P-gp), which actively efflux administered drugs from the cell interior and reduce their therapeutic impact. RNAi is a potential approach to reduce the P-gp activity on tumors and non-viral methods to achieve RNAi is needed to facilitate clinical entry. This study was conducted to determine the feasibility of down-regulating tumor P-gp levels with non-viral (polymeric) siRNA delivery in order to sensitize the tumors to drug therapy. **EXPERIMENTAL DESIGN.** P-gp over-expressing MDA435/LCC6 MDR1 cells were used to establish xenografts in NOD-SCID mouse. Cationic polymers polyethylenimine (PEI) and stearic acid-substituted poly-L-lysine (PLL-StA) were formulated with FAM-labeled siRNAs and delivered intratumorally to investigate local retention of the siRNA. The lipid-substituted PLL was previously developed for a higher intracellular delivery of siRNA as a result of improved membrane compatibility of this carrier. P-gp specific siRNAs (Ambion) were formulated and delivered similarly to explore the feasibility of P-gp down-regulation in tumors. Intravenous DoxilTM was subsequently administered to investigate tumor growth after P-gp down-regulation. **RESULTS.** The PEI and PLL-StA effectively delivered siRNA delivery to MDA435/LCC6 MDR1 cells in vitro to reduce P-gp expression for 3 days. Intratumoral injection of siRNA with the polymeric carriers resulted in 60-80% and 20-32% of siRNA retention in tumors after 24 and 96 hr, respectively. The presence of intact siRNA in tumors were shown up to 4 days after injection. This led to ~29.0% and ~61.5% P-gp down-regulation with PEI and PLL-StA mediated siRNA delivery, respectively. The P-gp down-regulation by intratumoral injection of specific siRNA led to better tumor response to systemic DoxilTM treatment (Figure 1), resulting in effective slowing of tumor growth in originally doxorubicin-resistant tumors. **CONCLUSION.** We conclude that effective P-gp down-regulation is feasible with polymeric siRNA delivery systems in a xenograft model, resulting in an enhanced response to the drug therapy. Delivering siRNA with non-viral vectors should facilitate clinical entry of this promising approach in order to reverse the multidrug resistance seen in several types of cancers.

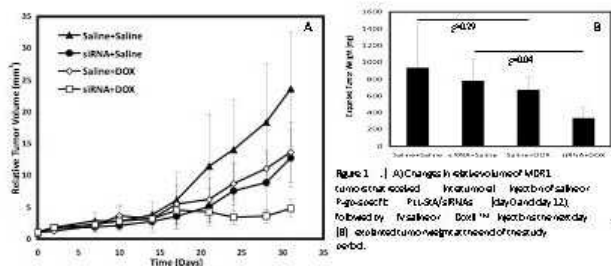

63. Gene Therapy with Antibody Targeted Immunoliposome Rescue Experimental Parkinson's Disease

Qinghui Zhou,¹ Ailing Fu,¹ Boado Ruben,¹ William M. Pardridge.¹
¹UCLA, Los Angeles, CA.

Background: Gene therapy with transferrin receptor monoclonal antibody (TfRMab) targeted pegylated immunoliposome (PILs) has been shown to be effective in central nerves system by crossing the blood brain barrier. However efficient DNA encapsulation into the liposomes used for this purpose is very low and not reproducible. In the research, the formulation of antibody targeted PIL is improved by using ethanol-mediated DNA condensation process. Non-viral gene therapy of rats with experimental Parkinson's disease (PD) is performed with intravenous injection of glial-derived neurotrophic factor (GDNF) plasmid DNA PILs targeted with TfRMab. **Methods:** Parkinson's model rats were treated with single and double injections of GDNF TfRMab-PIL. The dose of the GDNF was 10 ug/rat/injection. Rats were tested with drug-induced rotation experiment as well as whisker-induced forelimb placement, and terminal striatal tyrosine hydroxylase (TH) enzyme activity was measured at the end of the study. **Results:** The modified PIL formulation increases the DNA encapsulation from 20% to 80%. Apomorphine-induced contralateral rotation, amphetamine -induced ipsilateral rotation and whisker-induced forelimb placement abnormalities were reduced about 80% with gene therapy using single injection of GDNF TfRMab-PIL relative to saline treated rats. Gene therapy using double injections demonstrates more therapeutic effect than single injection with almost completely rescue of experimental Parkinson's disease. The neurobehavioral improvement correlates with an increase in striatal TH enzyme activity relative to saline treated rats.

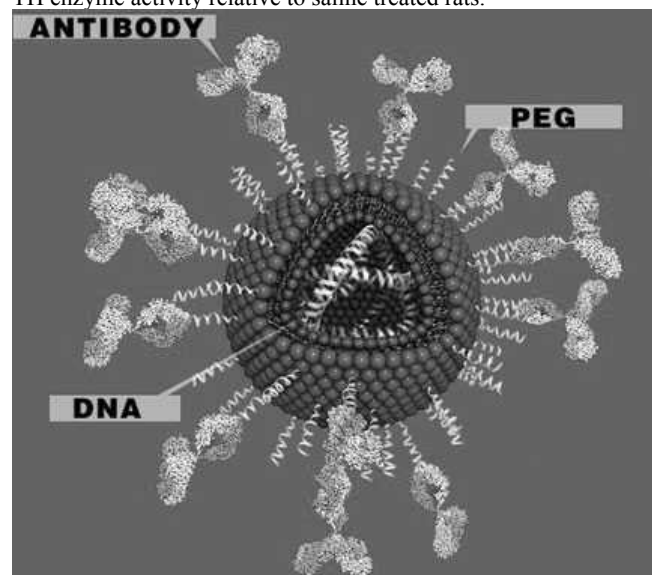

64. Subcellular Trafficking and Transfection Efficacy of PEI-PEG Polyplex Nanoparticles with a Ligand to Melanocortin-1 Receptors

Alexey V. Ulasov,¹ Yuri V. Khramtsov,¹ Elena A. Beletkaia,² Nikita S. Rodichenko,² Georgiy A. Trusov,² Mikhail O. Durymanov,² Andrey A. Rosenkranz,^{1,2} Eugene D. Sverdlov,³ Alexander S. Sobolev.^{1,2}

¹Institute of Gene Biology, Moscow, Russian Federation; ²Moscow State University, Moscow, Russian Federation; ³Shemiakin-Ovchinnikov Institute of Bioorganic Chemistry, Moscow, Russian Federation.

One of the most often used polymers for formation of polyplex nanoparticles for gene therapy is polyethylenimine (PEI) or its block-copolymer with polyethylene glycol (PEG). Quite often different (poly)peptides are included into non-cell-specific PEI-PEG-containing polyplexes in order to enhance their efficacy (e.g., TAT peptide) or to impart cell selectivity to them (e.g., receptor ligands). Earlier, we [1] found optimal ratios between components of PEI-PEG-TAT block-copolymers as well as between the block-copolymers and plasmid DNA. We also demonstrated positive correlation of transfection efficacy with the cellular uptake rate of the nanoparticles and negative correlation with the rate constant of their unpacking within endo/lysosomal compartments. Here we report our results about synthesis and properties of new PEG-PEI-based polyplexes containing ligand peptide specific for melanocortin receptors-1 over-expressed on the cells of many melanomas. These polyplexes demonstrated receptor-mediated transfection of murine melanoma cells (Cloudman S91 clone M3, and B16-F1): 1) the transfection of the melanoma cells with over-expressed melanocortin-1 receptors was significantly inhibited with a free ligand to these receptors; 2) this inhibition was not observed on HEK-293 cells lacking melanocortin receptors-1. We investigated subcellular transport kinetics and unpacking of the polyplex nanoparticles labeled with quantum dots (plasmid DNA) and AlexaFluor647 (block-copolymer part) using Foerster Resonance Energy Transfer approach. In order to semi-automatically attribute the quantum dots to specific subcellular compartments, to check whether the polyplexes are packed/unpacked, and to process the obtained data, a special computer program has been developed. We found that packed liganded polyplexes appeared and accumulated in the Cloudman S91 clone M3 melanoma cells 6 hr earlier than non-liganded control polyplexes. Analysis of kinetics of intracellular transport of polyplexes suggested that liganded polyplexes enter into the nuclei of the melanoma cells more rapidly than non-liganded ones and this difference may be attributed to processes linked to receptor-mediated endocytosis. We investigated expression of firefly luciferase using RT real-time PCR after laser dissection and catapulting of either the Cloudman S91 clone M3 melanoma cells permanently transformed with *EGFP* gene or surrounding normal cells in tumors of DBA/2y mice 6 hr after intratumoral injection of polyplexes carrying the luciferase gene. Liganded polyplexes more efficiently transfected melanoma tumors than non-liganded ones. Finally, liganded polyplexes carrying *Herpes simplex* virus thymidine kinase gene - after ganciclovir administration - more efficiently inhibited melanoma tumor growth and prolonged lifespan of DBA/2y tumor-bearing mice than non-liganded polyplexes. Reference: 1. A.V. Ulasov et al. *Mol. Ther.*, 2010, DOI: 10.1038/mt.2010.233, Epub before print.

65. Cathepsin B-Labile Polymers for Endosome/Lysosome-Specific Degradation and Nucleic Acid Release

David S. Chu,¹ Russell N. Johnson,¹ Suzie H. Pun.¹

¹Bioengineering, University of Washington, Seattle, WA.

Degradable cationic polymers are desirable for *in vivo* nucleic acid delivery because they offer significantly decreased toxicity over their non-degradable counterparts. Most methods employed for degradable polymers involve reducible or hydrolysable bonds that provide only partial control over the *in vivo* site of degradation. Peptide linkers provide chemical stability and high specificity for particular endopeptides but have not been extensively studied for nucleic acid delivery applications. In this work, methacrylated peptides composed of a peptide linker designed to be a substrate of the endosomal/lysosomal endopeptidase cathepsin B connected to oligo-L-lysine were synthesized. For controls, peptides expected to be stable against peptidase activity (oligo-D-lysine) or to undergo only exonuclease activity were also synthesized (oligo-L-lysine without linker). Peptides were copolymerized with hydroxypropyl(methacrylamide) (HPMA) via reverse addition-fragmentation chain transfer (RAFT) polymerization. The resulting HPMA-peptide copolymers showed low polydispersity and near quantitative incorporation of peptides. The enzymatic stability of the copolymers was tested by treatment with cathepsin B with analysis by GPC. Copolymers synthesized with the cathepsin B recognition sequence showed complete cleavage of the oligolysine chains within one hour. In contrast, copolymers synthesized with oligo-D-lysine were stable for the entire experiment and copolymers synthesized with oligo-L-lysine alone were only slightly degraded by exonuclease activity over **4 hours**. Polyplexes formed with cathepsin B-sensitive copolymers show release of DNA within 2 hours of treatment with cathepsin B; comparatively, polyplexes formed with peptidase-resistant polymers show no DNA release within 8 hours. Transfection efficiency and toxicity of HPMA-peptide copolymers were compared to polyethylenimine (PEI) and poly-L-lysine (PLL) in HeLa and 3T3 cells. This work demonstrates the successful application of peptide linkers for degradable cationic polymers and DNA release.

66. A Modified HK Carrier of siRNA Enhances Silencing of Tumor Targets In Vivo

Szu-Ting Chou,^{1,2} Qixin Leng,¹ Puthuppampal Scari,³ Archibald J. Mixson.¹

¹Pathology, University of Maryland Baltimore, Baltimore, MD; ²Chemical and Biomolecular Engineering, University of Maryland College Park, College Park, MD; ³Aparna Biosciences, Rockville, MD.

RNAi is a promising research and therapeutic strategy, utilized to down-regulate aberrant disease-causing genes and to study genes important for signal transduction pathways. To deliver RNAi systemically, an effective delivery system is essential to facilitate specific targeting and cellular uptake in the target tissue, particularly for diseases such as cancer. Consequently, our laboratory has developed a branched HK peptide for systemic delivery of small interference RNA (siRNA). While lysines are essential for binding siRNA, histidines are important for buffering and releasing siRNA from endosomes. Based on screening of several HK peptides, one four-branched polymer, H3K4b, whose predominant repeating patterns is -HHHK-, has been determined to be an effective carrier of siRNA. Although the unmodified H3K4b carrier of siRNA targeting an oncogene was previously shown to have promise in an *in vivo* mouse model, we sought to develop a more effective HK carrier of siRNA in the current study. To this end, our primary goal was to determine whether different targeting ligand (cyclic RGD) and pegylation patterns on the H3K4b peptide improved siRNA

delivery in vivo. As a result, we compared the unmodified H3K4b polymer with two modified H3K4b polymers for their ability to deliver siRNA to luciferase-expressing MDA-MB-435 cells, both in vitro and in a tumor-bearing mouse model; one modified HK polymer, (RGD-PEG)₄-H3K4b, had four RGD-PEGs conjugated to each molecule, while the other polymer, (RGD-PEG)-H3K4b, had one RGD-PEG per molecule. For in vitro experiments, the H3K4b siRNA nanoparticle targeting luciferase decreased its activity by 90% compared with negligible down-regulation by the modified H3K4b carriers. In contrast, the two RGD-PEG modified H3K4b peptides administered intravenously were significantly more effective than H3K4b in silencing luciferase in a tumor-bearing animal model. Specifically, H3K4b, (RGD-PEG)-H3K4b, and (RGD-PEG)₄-H3K4b carriers of Luc siRNA decreased luciferase activity in the lysates of tumor xenografts by 10%, 35%, and 80%, respectively. Furthermore, this result was validated by a real time bioluminescence imaging system. Thus, (RGD-PEG)₄-H3K4b carrier with the greatest number of modifications was the most effective carrier of siRNA in vivo. These studies demonstrate that selected modified HK polymers are promising candidates to target oncogenes with siRNA.

67. Subcutaneous Delivery of Plasmid DNA to Hepatocytes by Ligand-Targeted Sub-50 nm Capsules

B. T. Kren,¹ V. L. Korman,² D. Tolbot,² G. M. Unger.²

¹University of Minnesota, Minneapolis, MN; ²GeneSegues, Inc., Chaska, MN.

Gene augmentation for hepatocyte based metabolic disease has been a long-term goal of gene therapy. Subcutaneous (sq) administration of plasmid DNA is a desirable goal for patient-friendly genetic manipulation of target cells in chronic disease. However, two major delivery challenges that have impeded its development are avoiding sequestration at the injection site and in the target cells endosomes with subsequent degradation. A novel nonviral delivery technology developed by GeneSegues utilizes sub-50 nm crystalized capsules for intact delivery of nucleic acids (NA) from 19 bp to 15 kb. The capsule's crystalized shell formulated from any appropriate targeting protein, peptide or carbohydrate ligand specifies the uptake of the capsule by the specific cell-type in vivo via the receptor targeted by the capsule ligand shell. The nanocapsule's size, structure and charge mediates efficient in vivo penetration of tissues and cellular uptake via the non-endosomal lipid rafts pathway, delivering the NA cargo intact to the nucleus and cytoplasm of the target cell. We have previously demonstrated that asialoorasomucoid (ASOR) s50 capsules mediate hepatocyte specific delivery of transgenes in vivo following intravenous (iv) administration (J Clin Inv 119:2086, 2009). Here we show data comparing various sq regimens to iv administration for delivery of a secreted alkaline phosphatase (SEAP, pCpgSEAP) reporter packaged into ~ 10-15 nm ASOR s50 capsules. We found that RNA production at 48 hrs after final dose was approximately 15 – 25% of that produced by a maximum volume iv regimen. Target RNA production levels were similar between equivalent dose sq regimens with different schedules. Importantly for clinically relevant delivery, fluorescence microscopy showed similar uniform gene expression only in hepatocytes for both iv and sq liver sections. In contrast, higher expression levels were observed with a second reporter pcDNA3.1/LacZ in sq liver sections potentially reflecting differences in gene regulation between the plasmids. To study sq administration of s50 capsules independently of cargo transgene expression we used ASOR capsules carrying Dysprosium (Dy)-chelated dextran. Dy is a large nuclei, fluorescent lanthanide enabling sensitive isotopic measurements of tissues by neutron activation analysis of Dy content. A cohort of mice were injected sq over a 5 day period held in metabolism cages for the final 24 hrs. Over 5 days, ~ 4.3% of the injected dose accumulated in the liver (based

on summation of 24-hr collection points for the 5 days) peaking at 3 days postinjection. Of note, no uptake was observed in spleen, kidney, lung, heart or testes. These data support the view that sq delivery of ASOR targeted s50 capsules to hepatocytes provides a depot effect, with prolonged availability of cargo and possible avoidance of duration-adverse effects such as saturation of cellular uptake, intracellular enzymatic degradation of cargo, etc. In conclusion, these studies provide a solid framework for further development of the nonviral ASOR s50-mediated sq nucleic acid based gene therapies for hepatocyte-based liver disease.

68. Methods To Observe Intracellular Trafficking of Non-Viral Delivery Vehicles in 3D

Nilesh P. Ingle,¹ Theresa M. Reineke.¹

¹Chemistry, Virginia Polytechnic Institute and State University, Blacksburg, VA.

In this study, we present methods that our lab has developed to quantitatively examine the intracellular trafficking of polyplexes in 3D. We have studied the trafficking of four carbohydrate-based polymeric delivery vehicles that have been previously developed in our lab that consists of trehalose and pentaethylenetetramine subunits along with two commercial controls Glycofect™ and JetPEI™. Two lengths of the trehalose polymer vehicles were examined with degrees of polymerization of 55 (Tr4-55) and 77 (Tr4-77). **Cell culture and Transfection:** HeLa cells were cultured (15,000 cells/well) on acid washed glass coverslips coated with poly L-Lysine, 24-hours prior to transfection. The polyplexes were formulated in DNase/RNase-free H₂O, 1 hour prior to transfection at the following formulation ratios: 5, 20, 7 and 7 N/P for JetPEI™, Glycofect™, Tr4-55, and Tr4-77 respectively. The polymer solution (50 µl/well) was added to FITC-pDNA solution (50 µl/well at 0.02 µg/µl) to make a 100µl polyplex solution. The transfections were done in OptiMEM. Four hours after transfection, cells were washed with PBS at pH 7.4 and supplemented with 1 ml DMEM. **Confocal Preparation, Image Acquisition, and Analysis:** The cells were fixed at 4, 8, 12 and 24 hours post transfection. The nuclei were stained with DAPI. Zeiss LSM Meta 510 confocal microscope containing an Argon laser (488 nm) to excite FITC and UV laser (364 nm) to excite DAPI was used for imaging. The scaling was X: 0.070 µm, Y: 0.070 µm and Z: 0.140 µm. The raw Z-stack images were first deconvoluted based on theoretical point spread function and the Classical Maximum Likelihood Estimation algorithm using proprietary software and then volume rendered. **Results and Discussion:** The 3D images were analyzed for three parameters: (1) polyplex volume, (2) distance between polyplexes and (3) distance of polyplexes from the surface of nucleus. The volumetric images revealed that these intracellular polyplexes may exhibit non-specific globular shapes as they approach the nucleus. The distance distribution plots suggested that after endocytosis the polyplexes appeared to traffic in groups (and not as single polyplexes), which move with the transport machinery of a cell along both actin and microtubules. After uptake, the polyplexes have similar 3D-positions in the cell, which lasts for about 4 hours. The onset of this dormant period varies with polymer type. In general all the polyplexes appear to traffic toward the nucleus with similar kinetics. However, after this dormant period, some of the polyplexes appear to traffic away from the surface of the nucleus, while others do not; this apparent exocytosis-like behavior is seen at an earlier time point of 4 to 8 hours for Tr4-55 and Tr4-77 than the commercial controls. We also observed that as the average volume of all the polyplexes within the cell increased, the surface area of these complexes increased within the cell suggesting that the complexes appear to undergo fission within the cell (increasing surface area) and the complexes that are divided appear to increase in volume (possibly swelling). This affect was noticed with all of the polymer-vehicles. We thus propose a method to visualize & quantify intracellular polyplexes in 3D.

Musculo-skeletal Gene & Cell Therapy

69. Exploring the Potential of Plasma Pheresis To Circumvent Pre-Existing Antibodies to AAV8 on Transgene Expression Following Targeted Vascular Delivery

Louis G. Chicoine,^{1,2} Louise R. Rodino-Klapac,^{1,2} K. Reed Clark,^{1,2} Chrystal L. Montgomery,^{1,2} Thomas J. Preston,¹ William G. Bremer,^{1,3} Katherine J. Campbell,^{1,3} Zarife Sahenk,^{1,2,4} Paul T. Martin,^{1,2} Christopher M. Walker,^{1,3} Jerry R. Mendell.^{1,2,4}

¹*Pediatrics, The Ohio State University/Nationwide Children's Hospital, Columbus, OH;* ²*Center for Gene Therapy, Research Institute at Nationwide Children's Hospital, Columbus, OH;*

³*Center for Vaccines and Immunity, Research Institute at Nationwide Children's Hospital, Columbus, OH;* ⁴*Neurology, The Ohio State University/Nationwide Children's Hospital, Columbus, OH.*

Gene therapy for muscle disease has taken several positive steps forward. We recently reported sustained AAV mediated alpha-sarcoglycan (SGCA) gene expression for as long as 6 months in 5 of 6 limb girdle muscular dystrophy (LGMD2D) treated patients (Mendell et al. 2010). The one patient that did not express SGCA was found to have high AAV neutralizing antibodies prior to gene transfer. With vascular gene therapy to treat multiple muscles as the next logical step clinically, impediments may lie with the immune response and the presence of pre-existing antibodies to various AAV serotypes. We tested the hypothesis that pre-existing antibodies to AAV8 would attenuate transgene expression following vascular delivery of two potentially therapeutic transgenes AAV8.MCK.micro-dystrophin.Flag and AAV8.MCK.Galgt2 in a large study of 72 non-human primates. Prior to gene transfer, all animals were pre-screened for binding antibodies to AAV8. Those animals with a titer of <1:100 were considered negative, while others (>1:100) were considered positive. Animals were stratified into positive and negative groups with scheduled sacrifice times at 3 and 6 months (n=9 per group). Vascular delivery to the gastrocnemius muscle of an isolated limb (Rodino-Klapac et al. 2010) was performed on each animal where 2×10^{12} vg/kg of the appropriate vector was given. None of the animals suffered noticeable edema or adverse effects from the procedure. Three or six months after transfer, the macaques were euthanized, and the gastrocnemius muscle was harvested. Samples of the proximal, central and distal muscle were stained with anti-FLAG or CT2 antibody. The contralateral gastrocnemius served as a negative control. Gene expression was visualized in all subjects and subjects without pre-existing AAV8 antibodies demonstrated significantly higher transgene expression than subjects with pre-existing antibodies (62% vs 33% muscle fibers transduced, $P \leq 0.001$). Regression analysis confirmed a direct inverse correlation between the AAV8 antibody titer and the percent gene expression. From these data we conclude that the presence of pre-existing antibodies to the vector will attenuate transgene expression. Plasma pheresis studies appeared to optimize transgene expression and this procedure would potentially be used to increase the number of patients amenable to gene therapy and make some patients candidates for retreatment when necessary.

70. Acceleration and Augmentation of Femoral Segmental Bone Healing by Adipose-Derived Stem Cells Engineered with Hybrid Baculovirus Vectors Conferring Sustained Transgene Expression

Chin-Yu Lin,¹ Kun-Ju Lin,² Chun-Yu Kao,¹ Tzu-Chen Yen,² Yu-Han Chang,³ Yu-Chen Hu.¹

¹*Chemical Engineering, National Tsing Hua University, Hsinchu, Taiwan;* ²*Nuclear Medicine and Molecular Imaging Center, Chang Gung Memorial Hospital, Taoyuan, Taiwan;* ³*Orthopaedic, Chang Gung Memorial Hospital, Taoyuan, Taiwan.*

Massive segmental defects arising from trauma or tumor resection remain a challenging clinical problem. To heal massive, segmental bone defects using adipose-derived stem cells (ASCs), which alone cannot heal large defects, we hypothesized that sustained expression of factors promoting bone regeneration (BMP2) and angiogenesis (VEGF) provides continuous stimuli to augment the healing. Insect baculovirus (BV) holds promise for gene therapy and efficiently transduces stem cells, but it only mediates transient transgene expression. Therefore we developed a dual BV system whereby one BV expressed FLP recombinase (BacFLP) while the other hybrid BV harbored an Frt-flanking transgene cassette. The New Zealand White (NZW) rabbit ASCs were transduced with the BacFLP and hybrid BV or conventional BV, seeded to scaffolds and transplanted into critical-sized (10 mm) femoral segmental defects in NZW rabbits. The bone regeneration was assessed by radiography, Positron Emission Tomography/Computer Tomography (PET/CT) at 2, 4, 8 and 12 weeks post-transplantation (wpt), and CT, histological staining, biomechanical torsional testing at 12 wpt, respectively. Within the ASCs transduced with BacFLP and the hybrid BV, the transduction efficiency reached 98% while the FLP/Frt-mediated recombination efficiency approached 46%, leading to cassette excision off the BV genome, enabling transgene persistence in episomal form and prolonging the expression to >28 days. Transduction of ASCs with the BMP2-encoding hybrid BV led to prolonged BMP2 expression and augmented ASCs osteogenesis even without other osteogenic supplements. ASCs engineered by conventional BV transiently expressing BMP2/VEGF (S group) only healed the critical-sized femoral bone defects in 40% of NZW rabbits at 12 wpt, but ASCs engineered by the hybrid vectors persistently expressing BMP2/VEGF (L group) healed the critical-sized defects in 12 out of 12 animals in 8 weeks. Compared with the S group, the L group not only accelerated the healing, but also ameliorated the bone metabolism, bone volume, bone density, angiogenesis and mechanical properties. These data confirmed our hypothesis that persistent BMP2/VEGF expression is essential. Use of the hybrid BV vector for ASCs engineering represents a novel approach to treating massive segmental bone defects necessitating concerted ossification and vascularization.

71. Restoration of Dystrophin Expression in the mdx Mouse Model for Duchenne Muscular Dystrophy (DMD) Induced by RTC13

Refik Kayali,¹ Liutao Du,² Jin-Mo Ku,³ Gladys Completo,³ Olga Prikhodko,¹ Yosuf Subat,¹ Hailiang Hu,² Michael Jung,³ Richard A. Gatti,² Carmen Bertoni.¹

¹*Department of Neurology, David Geffen School of Medicine University of California Los Angeles, Los Angeles, CA;*

²*Department of Pathology and Laboratory Medicine, David Geffen School of Medicine University of California Los Angeles, Los Angeles, CA;* ³*Department of Chemistry and Biochemistry, University of California Los Angeles, Los Angeles, CA.*

Molecules that induce ribosomal read-through of nonsense mutations in mRNA and allow production of a full-length functional protein hold great therapeutic potential for the treatment of many genetic disorders. Two such read-through compounds, RTC13

and RTC14, were recently identified by a luciferase-independent high-throughput screening assay and were shown to have potential therapeutic functions in the treatment of nonsense mutations. We have tested the ability of RTC13 and RTC14 to restore dystrophin expression into skeletal muscles of the *mdx* mouse model for Duchenne muscular dystrophy (DMD). Intramuscular injections of RTC13, promoted read-through of the *mdx* UAA stop codon more efficiently than gentamicin, PTC124 or RTC14 making it our lead drug candidate. When administered systemically, RTC13 was shown to restore dystrophin protein in different muscle groups, including diaphragm and heart. Improved muscle strength was detected in all treated animals and was accompanied by a significant decrease in creatine kinase (CK) levels demonstrating that the compound was able to slow down muscle degeneration and turnover. No signs of toxicity were detected in *mdx* after prolonged administration of RTC13 demonstrating that the compound was well tolerated in mice. The levels of direct bilirubin (DBIL), blood urea nitrogen (BUN), creatinine, alkaline phosphatase (ALP) and alanine aminotransferase (ALT) were significantly decreased in RTC13-treated mice as compared to *untreated mdx* or *mdx* mice that received vehicle alone confirming that restoration of dystrophin expression in muscles was able to ameliorate some of the secondary pathology associated with the disease in *mdx*. Structure activity relationship (SAR) studies were used to optimize the molecular structure of RTC13 and to identify a derivative that meets optimal safety profiles while still maintaining maximal read-through activity. These results advance the development of RTC13 as an effective drug candidate for DMD. They also offer hope for the treatment of numerous other genetic disorders due to nonsense mutations and premature termination of protein synthesis.

72. Effective Limb Transduction and Phenotypic Correction after Injection of rAAV8-U7 snRNA in GRMD Dogs

Caroline Le Guiner,^{1,2} Marie Montus,¹ Laurent Servais,³ Luis Garcia,³ Yves Fromes,^{1,3} Jean-Yves Hogrel,³ Pierre Carlier,³ Yan Cherel,⁴ Philippe Moullier,^{1,2} Thomas Voit,³ The AFM-Sponsored Duchenne Consortium.^{1,2,3,4}

¹Genethon, Evry, France; ²INSERM UMR 649, Nantes, France;

³Institut de Myologie, Paris, France; ⁴INRA UMR 703, Nantes, France.

In Duchenne Muscular Dystrophy (DMD) the selective removal by exon skipping of exons flanking an out-of frame mutation in the dystrophin messenger can result in in-frame mRNA transcripts that are translated into shorter but functionally active dystrophin. The goal of our project was to determine in GRMD, the effective dose of our therapeutic product defined as a recombinant Adeno-Associated Virus serotype 8 (rAAV8) expressing a modified U7 snRNA specific for the skipping of exons 5 to 10 of the GRMD dystrophin transcript. The mode of delivery was the locoregional high-pressure intravenous (IV) injection of a forelimb. Several groups of GRMD dogs were exposed to different rAAV8-U7snRNA doses. Each dog was followed ~3 months after injection. The primary outcomes were the restoration of dystrophin expression and the improvement of the tissue pathology in the injected limb compared to the controlateral limb. The secondary outcomes were the muscle strength correction, the biodistribution and shedding patterns as well as the immune response against rAAV8 capsid and dystrophin. Our preliminary results suggest a dose effect of our therapeutic rAAV. Injection of 2.5E13vg/kg and of 5E12vg/kg of our vector was able to restore 50 to 80% of Dystrophin expression in the injected limb. This expression of a semi-functional dystrophin resulted in improvement of tissue morphology as well as of several functional and MRI parameters. No tissue inflammation occurred following the procedure. We built a unique network of laboratories with complementary skills to deliver a

GLP-compliant set of preclinical data to further define the regulatory toxicology studies. The organization of our network and the results obtained in our GRMD dogs study will be presented. This project is supported by AFM (Association Française contre les Myopathies) and by ADNA (Advanced Diagnostics for New Therapeutic Approaches), a program dedicated to personalized medicine, coordinated by Institut Mérieux and supported by research and innovation aid from the French public agency, OSEO.

73. Inhibition of CD26 Activity Enhances Engraftment of Donor Cells to Regenerating and Dystrophic Skeletal Muscle

Maura H. Parker,¹ Carol Loretz,¹ Rainer Storb,^{1,3} Stephen J. Tapscott.^{2,4}

¹Clinical Research Division, Fred Hutchinson Cancer Research Center, Seattle, WA; ²Human Biology Division, Fred Hutchinson Cancer Research Center, Seattle, WA; ³Department of Medicine, University of Washington, Seattle, WA; ⁴Department of Neurology, University of Washington, Seattle, WA.

Muscle-derived cell transplantation has the potential to effectively treat many human diseases, including muscular dystrophy. A variety of cell populations engraft into skeletal muscle of *mdx* mice, effectively restore dystrophin expression and reconstitute the satellite cell pool. Yet, a direct and quantitative comparison of engraftment to determine the most effective cell population is lacking. We have developed a canine-to-mouse xenotransplantation model to rapidly and quantitatively compare canine muscle cell engraftment. Specifically, we demonstrate that canine muscle derived cells engraft into regenerating mouse muscle, and engraftment is quantifiable and consistent. The canine-to-mouse model allows us to quantitatively compare cell populations and modulating factors, and establish priority for transplantation experiments using a clinically relevant immune tolerant *cxmd* canine model of muscular dystrophy. We used the xenotransplant model to show that canine muscle derived cells sorted for expression of CXCR4 do not display a greater level of engraftment when compared to a mixed cell population. However, pre-treating a mixed cell population with diprotin A, a positive modulator of CXCR4-SDF-1 binding, significantly enhances engraftment of donor cells to the mouse satellite cell niche. Translating these results to the immune tolerant canine, we demonstrate that injection of diprotin treated donor cells results in a significantly increased number of muscle fibers expressing dystrophin as compared to untreated cells. Temporal regulation of CXCR4/SDF-1 binding may be an important means of expanding the effective range of engraftment after transplantation.

74. Addition of Peptide Therapy To Inhibit NF-κB Activation to AAV Serotype 9 Mini-Dystrophin Gene Transfer To Treat Muscular Dystrophy in *mdx* Mice

Daniel P. Reay,¹ Gabriela A. Niizawa,¹ Jon F. Watchko,² Molly Daood,² Eugene Raggi,¹ Paula R. Clemens.^{1,3}

¹Neurology, University of Pittsburgh, Pittsburgh, PA; ²Pediatrics, Magee-Women's Research Institute, Pittsburgh, PA; ³Neurology Service, Department of Veteran's Affairs Medical Center, Pittsburgh, PA.

Systemic gene transfer using serotype 9 adeno-associated vectors (AAV9) is promising for treatment of preclinical models of Duchenne muscular dystrophy (DMD). The ability to achieve systemic vector delivery circumvents a significant hurdle presented by the widespread distribution of skeletal muscle that is best accessed through the circulation. However, a limitation of systemic gene vector delivery is that gene transduction levels vary among muscle groups. The addition of complementary therapy could provide 1) a treatment effect

independent of gene transfer and 2) facilitation of successful gene transfer. Pathological activation of the nuclear factor κ B (NF- κ B) signaling pathway has emerged as an important cause of dystrophic muscle changes in muscular dystrophy. Furthermore, activation of NF- κ B may also inhibit gene transfer by promoting inflammation in response to the transgene or vector. Therefore, we hypothesized that the addition of NF- κ B inhibition in muscle would complement the therapeutic benefits of dystrophin gene transfer in the *mdx* mouse model of DMD. The NF- κ B Essential Modulator (NEMO) binding domain (NBD) peptide, which is utilized in this study to inhibit NF- κ B, is synthesized as a fusion peptide with a protein transduction domain of 8 lysines (8K) to facilitate intra-cellular delivery. An AAV9 vector carrying a human codon-optimized mini-dystrophin gene under control of the cytomegalovirus promoter was given as a single intraperitoneal injection (1×10^{11} gc/pup) at age 2-3 days to 16 *mdx* mice (experimental mice). Starting at age 4 weeks, 8 of the experimental mice were given intraperitoneal injections of 8K-NBD peptide dosed at 10mg/kg, 3 times per week for 5 weeks. The second group of 8 experimental mice received sham intraperitoneal saline injections. Control groups (n=8/group) included normal C57BL10 and disease control untreated *mdx* mice. At sacrifice, *ex vivo* physiological studies of diaphragm force production were performed prior to histological and biochemical assays of diaphragm and limb muscle tissue. In *mdx* mice treated with the combination of 8K-NBD peptide and AAV9 mini-dystrophin gene delivery, the quadriceps muscle demonstrated increased levels of recombinant dystrophin expression (84% of fibers expressing, as compared to 56% with AAV9 mini-dystrophin gene delivery alone) suggesting that 8K-NBD treatment promoted an environment in muscle tissue conducive to higher levels of recombinant dystrophin expression. Indices of necrosis and regeneration were diminished with either AAV9 gene delivery alone or in combination with 8K-NBD treatment. In diaphragm muscle, transgene expression was sufficiently high (>95% of muscle fibers expressed dystrophin) that marked improvements in histological and physiological indices were comparable in the 2 treatment groups. The data support benefit from 8K-NBD treatment to complement gene transfer therapy for DMD in muscle tissue that receives incomplete levels of transduction by gene transfer.

75. RNA Interference Improves Myopathic Phenotypes in Mice Over-Expressing Facioscapulohumeral Muscular Dystrophy Region Gene 1 (FRG1)

Lindsay M. Wallace,^{1,2} Sara E. Garwick-Coppens,¹ Scott Q. Harper.^{1,2,3}

¹Center for Gene Therapy, The Research Institute at Nationwide Children's Hospital, Columbus, OH; ²Molecular, Cellular and Developmental Graduate Program, The Ohio State University, Columbus, OH; ³Pediatrics, The Ohio State University, Columbus, OH.

Muscular dystrophies, and other diseases of muscle, arise from recessive and dominant gene mutations. Gene replacement strategies may be beneficial for the former, while gene silencing approaches may provide treatment for the latter. In the last two decades, muscle-directed gene therapies were primarily focused on treating recessive disorders. This disparity at least partly arose because feasible mechanisms to silence dominant disease genes lagged behind gene replacement strategies. With the discovery of RNA interference (RNAi) and its subsequent development as a promising new gene silencing tool, the landscape has changed. In this study, our objective was to demonstrate proof-of-principle for RNAi therapy of a dominant myopathy *in vivo*. We tested the potential of AAV-delivered therapeutic microRNAs, targeting the human Facioscapulohumeral muscular dystrophy (FSHD) Region Gene 1 (FRG1), to correct myopathic features in mice expressing toxic levels

of human FRG1 (FRG1^{-high} mice). We found that FRG1 gene silencing improved muscle mass, strength, and histopathological abnormalities associated with muscular dystrophy in FRG1^{-high} mice. Specifically, muscles transduced with FRG1-targeted microRNAs (miFRG1) were normal in size, showed no fibrosis or fat deposition, and had no evidence of myofiber degeneration or regeneration. Moreover, grip strength testing showed that miFRG1-treated animals were as strong as wild-type mice, while control-treated or untreated animals remained significantly weaker. Our results support the feasibility of using RNAi to target other FSHD candidate genes, including DUX4, which has recently emerged as the leading pathogenic insult underlying FSHD. Moreover, this approach potentially applies to as many as 37 different gene mutations responsible for myopathies inherited as autosomal dominant disorders.

76. Sustained Expression of Canine Micro-Dystrophin and Amelioration of Muscle Function in Dystrophic Dogs Following Large Scale AAV-Mediated Treatment

Zejing Wang,^{1,2} Rainer Storb,^{1,2} Donghoon Lee,³ Christine Halbert,⁴ Martine K. Childers,⁵ Glen Banks,⁶ James Allen,⁶ Eric Finn,⁶ Martin Kushmeric,³ Dusty Miller,⁴ Jeffery S. Chamberlain,⁶ Stephen J. Tapscott.^{1,4,6}

¹Transplantation Biology, Fred Hutchinson Cancer Research Center, Seattle, WA; ²Medicine, University of Washington, Seattle, WA; ³Radiology, University of Washington, Seattle, WA; ⁴Human Biology, Fred Hutchinson Cancer Research Center, Seattle, WA; ⁵Neurology and Regenerative Medicine, Wake Forest University, Charlotte, NC; ⁶Neurology, University of Washington, Seattle, WA.

Adeno-associated viral (AAV) vectors as gene delivery vehicles have shown promise both in preclinical studies and clinical trials for a number of acquired and inherited diseases, including Duchenne Muscular Dystrophy (DMD). We and others have shown that dogs and humans mount immune responses against all tested AAV serotypes, which compromised vector delivery and prevented sustained therapeutical gene expression. We have developed a transient immunosuppressive regimen consisting of anti-thymocyte globulin (ATG), cyclosporine (CSP), and mycophenolate mofetil (MMF), which was effective in preventing immune responses to AAV and enhanced AAV6-mediated gene delivery to canine skeletal muscle. Here, we demonstrate that long term expression for 2 years of a species – specific, functional canine-micro-dys can be achieved in large scale in skeletal muscles of DMD dogs with ATG/CSP/MMF. Moreover, for the first time we achieved amelioration of muscle histology and function as a result of sustained expression of the therapeutic gene as demonstrated both by non invasive magnetic resonance imaging (MRI) and kinematic gait analysis. In order to identify an even more effective and less toxic immunosuppressive regimen, we have begun studies using molecules that block T-cell costimulation. Further, we are also examining AAV vectors made by a modified production method that minimizes aberrant packaging of the capsid gene to further reduce immunogenicity in dogs. In conclusion, the finding of long term dystrophin expression in DMD dogs given a short course of standard immunosuppression opens the possibility of translating these strategies to a human DMD trial.

Cancer Immunotherapy - Emphasis on Vaccines and Adjuvants

77. Serial Treatment of Refractory Cancer Patients with GM-CSF Expressing Oncolytic Adenovirus Enhances Immunological Response and Survival without Compromising Safety

Petri Nokisalmi,¹ Anniina Koski,¹ Anna Kanerva,¹ Lotta Kangasniemi,² Iulia Diaconu,¹ Sari Pesonen,¹ Vincenzo Cerullo,¹ Timo Joensuu,³ Akseli Hemminki.¹

¹Cancer Gene Therapy Group, Transplantation Laboratory, Haartman Institute and Finnish Institute of Molecular Medicine, Helsinki, Finland; ²Oncos Therapeutics Inc, Helsinki, Finland;

³International Comprehensive Cancer Center Docrates, Helsinki, Finland.

Redirecting and augmenting the anti-tumor response of the immune system is a promising way to enhance the anti-tumor effects of oncolytic adenoviral therapy. We constructed Ad5/3-D24-GMCSF (CGTG-102), a 5/3 capsid modified oncolytic adenovirus coding for GM-CSF. CGTG-102 was used to treat patients with advanced solid tumors, refractory to standard therapies in the context of a Finnish Medicines Agency approved Advanced Therapy Access Program. In patients receiving a single injection, evidence of biological activity of the virus was seen in 62% patients. 67% showed objective disease control as evaluated with CT scans. Virus replication was seen in 80% of patients for up to 58 days. Low-dose metronomic cyclophosphamide was included in the treatment schema to reduce regulatory T cells. Since it is well established that immune response can be boosted by multiple dosing, we compared a single injection to administration of three doses 3-4 weeks apart (N = 109). Serial treatment did not increase frequency or grade of adverse events. Overall, all patients experienced grade 1-2 adverse events including fever, fatigue and flu-like symptoms. Grade 3-4 non-hematological adverse events were seen in 11% of single treatment receiving patients vs 12% or 7% (after 2nd and 3rd treatment) of serial treated ones. Median overall survival increased from 112 days in patients receiving single treatment to 277 days in patients receiving serial treatment, while 300 day survival increased from 33% to 48%. Although the inclusion and exclusion criteria are identical in these patient series, it should be noted that randomization was not performed. Both CGTG-102 patient series seem to compare favorably to a historical control series of patients with similar baseline characteristics but not treated with oncolytic virus (median survival 59 days and 300d survival 6%). In addition, both CGTG-102 patient series compare favorably to patients treated with an unarmed 5/3 modified virus (median survival 109 days and 300d survival 7%). Induction of anti-tumor T-cells was seen more frequently in serial treated patients. In conclusion, more immunological effects and longer survival are seen in patients receiving serial treatment, while adverse events are not increased. Further, frequent injection can help with intratumoral complexity. Thus, we plan to use multiple injections in an upcoming phase 1-2 clinical trial.

78. Preclinical Efficacy and Safety Studies of a Monoclonal Antibody Co-Therapy for Cancer

Roma Yumul,¹ Hongjie Wang,¹ Ines Beyer,¹ Jonas Persson,¹ Andre Lieber.¹

¹Division of Medical Genetics, University of Washington, Seattle, WA.

Monoclonal antibodies have been developed and commercialized to treat a variety of cancers. Unfortunately, they are only active in a minority of patients due to resistance of the cancer to the anti-tumor effects of the antibodies. One of the major mechanisms in which tumor cells protect themselves from antibody-mediated destruction

is by overexpressing the receptor, CD46, which protects cells from killing by one of the major elements of the immune system, complement. We have developed a therapeutic protein (Ad35K++), which is derived from species B adenovirus 35 and which targets and downregulates CD46 and thus overcomes the resistance of tumor cells to antibody-mediated killing. We have demonstrated the anti-tumor effects of Ad35K++ with a wide range of commercial monoclonal antibodies and cancers, including both solid tumors and hematological malignancies. For example, Ad35K++ sensitized CD20 positive lymphoma cells that are normally resistant to treatment with rituximab and Ad35K++ plus rituximab treatment achieved superior anti-tumor effects and animal survival compared to animals treated with rituximab alone. While in humans, CD46 is expressed on all nucleated cells, in mice the CD46 orthologue is only expressed in the testis. We therefore created a double transgenic huCD46/huCD20 mouse model and syngeneic huCD46/huCD20 lymphoma cells to study the safety and efficacy of Ad35K++/rituximab treatment. Upon intravenous Ad35K++ injection, fluorescent label analysis of organ sections revealed significant Ad35K++ accumulation in tumors, liver parenchyma, and splenic macrophages at 30 min after intravenous injection. The half-life of Ad35K++ in blood was ~6 hours. In therapy studies, a single round of Ad35K++/rituximab treatment significantly increased the average survival compared to rituximab treatment only. A second round of Ad35K++/rituximab treatment, given one week after the first cycle, further prolonged the survival. Toward a clinical trial we are also preparing a safety study in non-human primates (NHP). We demonstrated *in vitro* that rituximab depletes CD20⁺ B-cells of all tested NHP species (*Macaca fascicularis*, *Macaca nemestrina*, and *Papio anubis*) and that Ad35K++ significantly enhances this process. In contrast to humans, NHP have CD46 on erythrocytes. In this context, we found that Ad35K++ hemagglutinates erythrocytes from baboons (*P. Anubis*), but not erythrocytes from humans and from macaque species, including *M. fascicularis* and *M. nemestrina*. Taken together, our results suggest that *M. fascicularis* and *M. nemestrina* are adequate models to study both the efficacy and safety of the Ad35K++/rituximab approach.

79. Phase I Trial of Gene Mediated Cytotoxic Immunotherapy in Combination with Chemoradiation for Locally Advanced Pancreatic Cancer

Mark Bloomston,¹ Christopher Marsh,² Jon Walker,¹ Walter Coyle,² Howard Marx,³ Sanaa Tahiri,¹ Claudia Moran Cruz,⁴ Laura K. Aguilar,⁴ Estuardo Aguilar-Cordova,⁴ Vincent Chung.³

¹The Ohio State University Medical Center, Columbus, OH;

²Scripps Green Hospital, La Jolla, CA; ³City of Hope National

Medical Center, Duarte, CA; ⁴Advantagene, Inc., Auburndale, MA.

Background: More than 80% of patients with pancreatic cancer present with locally advanced or metastatic disease and have a median survival of only 6 months. Immunotherapy approaches may improve outcomes. Gene Mediated Cytotoxic Immunotherapy (GMCI™) is an approach that generates a systemic anti-tumor vaccine effect through intra-tumoral delivery of an adenoviral vector expressing the HSV-thymidine kinase gene (AdV-tk) followed by anti-herpetic prodrug and synergy with chemoradiation. The mechanisms of action involve tumor cytotoxicity, activation of antigen presenting cells and stimulation of systemic anti-tumor T-cell immunity. Safety with potential efficacy has been demonstrated in multiple clinical studies. This is the first application of GMCI™ in pancreatic cancer. **Methods:** This study evaluated 4 dose levels of AdV-tk (3x10¹⁰ to 1x10¹² vector particles) injected into locally advanced tumors via EUS or CT-guidance before and during week 3 of standard 5-FU-chemoradiation. Valacyclovir (Valtrex®, GSK) prodrug was given for 14 days after each of 2 AdV-tk injections. **Results:** The study completed accrual with 13 patients enrolled and 12 completing therapy with 3 at each

of the 4 dose levels. One patient refused further participation during course 1 after recovering from azotemia. Median age was 65 years (range 55-81) and median baseline CA19-9 was 1995 U/ml. No dose limiting toxicities and no injection related complications occurred. The only possibly related grade 3-4 toxicity was transient grade 3 dehydration and azotemia in 1 patient. Kaplan-Meier estimated median survival is 11.7 months with 3 patients still alive at 11-22 months. Two patients achieved a partial response by RECIST criteria. One occurred in week 6 despite discontinuing 5-FU/radiation during week 1. The other had gradual decrease of a 7 cm tumor over 11 months. Serum CA19-9 levels decreased in 8/8 evaluable patients by 32-91% at 3 months after treatment initiation. **Conclusions:** AdV-tk can be safely injected into pancreatic tumors and combined with standard chemoradiation. Early results are highly encouraging and justify further evaluation in a Phase 2 study.

80. How To Improve Adoptive T Cell Immune-Gene Therapy: The Importance of Be(ginn)ing Naïve

Nicoletta Cieri,¹ Barbara Camisa,¹ Elena Provasi,¹ Zulma Magnani,¹ Anna Mondino,² Attilio Bondanza,¹ Chiara Bonini.¹
¹Experimental Hematology Unit, San Raffaele Scientific Institute, Milan, Italy; ²Lymphocyte Activation Unit, San Raffaele Scientific Institute, Milan, Italy.

Immunotherapy with engineered T cells is attractive for the ability to generate lymphocytes of high affinity and appropriate specificity, which are generally lacking in patients with cancer or chronic infections. Nonetheless, current protocols of ex vivo T cell manipulation often induce T cell terminal differentiation, resulting in poor persistence and therefore limited activity of the transferred gene-modified cells. We previously showed that costimulation and culture with g-chain cytokines generates gene-modified T cells with a functional central memory (TCM) phenotype superior to effector/effector memory (TEM) counterparts for expansion potential and antitumor activity. Here we investigated the consequence of initial targeting of selected T cell subpopulations. We activated and efficiently transduced FACS-sorted T Naïve (TN), TCM and TEM cells by both lenti and retroviral vectors (Mean RV transduction efficiencies \pm SD: TN 35.6% \pm 6.58; TCM 33.21% \pm 4.98; TEM 28.75% \pm 4.5. Mean LV transduction efficiencies \pm SD: TN 71.85% \pm 4.31; TCM 81.75% \pm 0.07; TEM 52.85% \pm 16.61). Manipulated TN showed higher expansion potential compared to the other subsets. Strikingly, activation of TN resulted in a predominant population of CD45RA+CD62L+CCR7+ lymphocytes. This cell population did not produce IFN γ nor cytotoxic molecules, and required IL7 and IL15 for its generation and maintenance. In contrast to current knowledge on naturally occurring unmanipulated counterparts, CD45RA+CD62L+CCR7+ manipulated-TN were post-mitotic, expressed CD45RO and other markers of memory cells (IL2-R β , CXCR3 and CD95). When compared to manipulated-TCM and -TEM, naïve-derived T cells expressed higher levels of IL7-R α , c-Kit and CXCR4 and lower levels of CCR5, HLA-DR and PD-1. To verify their differentiation potential upon antigen stimulation, TN, TCM and TEM were transduced to express a WT1-specific TCR and then stimulated in an antigen-specific fashion in presence of low dose IL2. In this context, TN expanded at higher numbers, differentiated into both CD45RA-CD62L+(TCM) cells and CD45RA-CD62L-(TEM) cells and were unique in the ability to generate a mixed population of CD127 \pm lymphocytes. When infused in immunodeficient mice, manipulated TN proved higher engraftment and persistence than memory counterparts, reconstituted a mixed CD45RA \pm CD62L \pm phenotype and displayed a degree of xenoreactivity comparable to that of unmanipulated lymphocytes. To test the self-renewal ability, we performed a serial transplantation assay and found that only manipulated TN cells engrafted in secondary and tertiary recipients

and expressed IL7-R α . Our results indicate that gene transfer into TN lymphocytes, when manipulated according to our protocol, might increase the therapeutic effect of immune-gene therapy by combining target specificity with the most extensive self renewal.

81. IL15-VAX: A Prostate Cancer Cellular Vaccine Expressing IL-15 and IL-15R α

Jason C. Steel,¹ Charmaine A. Ramlogan,¹ Ping Yu,² Thomas A. Waldmann,² John C. Morris.¹

¹Hematology/Oncology, Internal Medicine, University of Cincinnati College of Medicine, Cincinnati, OH; ²Metabolism Branch, National Cancer Institute, Bethesda, MD.

Interleukin-15 (IL-15) is a pleiotropic cytokine that induces the differentiation and proliferation of T, B and NK cells, enhances activity of CD8+ cytolytic T cells, helps maintain CD44hiCD8+ memory T cells, and stimulates immunoglobulin synthesis by B cells. There has been increasing interest in using IL-15 for immunotherapy of cancer. The majority of IL-15 is membrane bound by the alpha chain of its receptor (IL-15R α). IL-15R α then *trans*-presents IL-15 to the β , γ -receptor to initiate signaling. This *trans*-presentation occurs between antigen presenting cells and immune effector cells. In creating IL15-VAX we genetically engineered tumor cells to express both IL-15 and IL-15R α so that they can directly activate effector cells. To do this we constructed two E1, E3 deleted adenoviruses expressing murine IL-15 (Ad.mIL-15) or IL-15R α (Ad.mIL-15R α) and ex-vivo transduced murine TRAMP-C2 prostate cancer cells at an MOI of 100 PFU/cell. We demonstrated that these cells were able to express functional IL-15. When these cells were subcutaneously implanted into C57BL/6 mice we found that expression of IL-15 and IL-15R α significantly impaired or prevented tumor growth at 30 days when compared to Ad.null modified TRAMP-C2 cells (mean volume- 160 \pm 160 mm³ vs. 1179 \pm 183 mm³, p < 0.05). Next we looked at whether vaccination with IL-15 and IL-15R α expressing TRAMP-C2 cells (IL15-VAX) could induce tumor specific immune responses against distant tumor. TRAMP-C2 cells were transduced with Ad.IL-15 and Ad.IL-15R α as before, and then treated with mitomycin C to prevent proliferation. TRAMP-C2 cells transduced with Ad.null (null-VAX) was used as a control. C57BL/6 mice were vaccinated with a single subcutaneous injection of 1 x 10⁶ cells into their hind limb. Fifteen days later the mice were challenged on the opposite flank with 1 x 10⁶ unmodified TRAMP-C2 cells and evaluated for tumor growth. Animals vaccinated with IL15-VAX had significantly reduced tumor growth compared to those vaccinated with Ad.null resulting in a prolongation of survival. At 25 days post-tumor implantation, null-VAX tumors had a mean volume of 1611 \pm 235 mm³ while those treated with IL15-VAX were 751 \pm 274 mm³ (p < 0.05). IL15-VAX induced TRAMP-C2 specific CTL killing and γ -IFN release in ex-vivo assays. TRAMP tetramer positive CD8+ cells were also detected in animals vaccinated with IL15-VAX whereas they were not detected in animals treated with null-VAX. We also showed that the vaccine effect was tumor specific with IL15-VAX with no anti-tumor effect in a non-related MC38 colon cell line. **Conclusion:** IL15-VAX successfully inhibited the growth of prostate TRAMP-C2 cells and improved survival by inducing tumor specific cell-mediated immune responses.

82. A Phase 1-2 Clinical Study of MGN1601, a Tumor Vaccine Comprising Allogeneic, Gene-Modified and Irradiated Tumor Cells in Combination with an Immunomodulator, in Patients with Metastatic Renal Cell Carcinoma (ASET Study) – Preliminary Results

S. Weikert,¹ M. Tschaike,² E. Weith,² V. Grünwald,³ M. Schroff,² B. Wittig,⁴ M. Schmidt.²

¹Clinic for Urology, Charité University Medicine, Berlin, Germany; ²Mologen AG, Berlin, Germany; ³Department Hematology and Oncology, Medical University Hannover, Hannover, Germany; ⁴Foundation Institute Molecular Biology and Bioinformatics, Freie Universität Berlin, Berlin, Germany.

Background. The cell-based RCC tumor vaccine MGN1601 consists of two active pharmaceutical ingredients: genetically modified allogeneic (human) cells transfected with four different MIDGE vectors encoding IL-7, GM-CSF, CD80 and CD154 combined with a synthetic DNA-based immunomodulator dSLIM-30L1, a TLR9 agonist. The vaccine has been developed for treatment of patients with advanced RCC. Several *in-vivo* models showed its prophylactic and therapeutic anti-tumor activity. A good safety profile of MGN1601 was shown in an extensive program of acute and chronic toxicity studies. Based on these promising data, this phase 1-2 study was started in patients with advanced RCC. **Method.** This is a multi-centric open Phase 1-2 clinical study to assess safety and efficacy of MGN1601 in patients with advanced RCC. The patient accrual started in December 2010. A total of 24 patients will be recruited into the study. The treatment consists of eight intradermal treatments with MGN1601 administered as follows: the first three treatments are administered weekly, and the consecutive five treatments on every other week. One dose of MGN1703 contains 10⁷ transfected tumor cells and 5 mg dSLIM-30L1 per administration. This dose has been proven to be safe with a high safety margin in repeated toxicity studies. The efficacy and safety of the study drug in the clinical setting will be evaluated based on extensive immunological tests, radiological assessment, safety laboratory results and assessments of quality of life. Here, the first safety and immunological efficacy data are presented. **Results.** To this date three patients have been included into the study and received the first administrations of the vaccine MGN1601. From two adverse events reported so far, one was judged as possible study drug-related by the investigator: moderate skin lesion. Local reactions in terms of mild redness were reported in one of these three patients. The therapy was well tolerated – no treatment-limiting toxicities (TLT) or grade 2 toxicities occurred in these patients. **Conclusions.** Based on these preliminary data treatment with MGN1601 is well tolerated and safe.

83. DC-NILV: Dendritic Cell Targeting Non-Integrating Lentiviral Vector Platform for Direct Administration in Immunotherapeutic Clinical Settings

N. Van Hoven,¹ J. Odegard,¹ C. Nicolai,¹ P. McGowan,¹ M. Slough,¹ D. Campbell,¹ C. Vin,¹ S. Tareen,¹ S. Robbins,¹ P. Wang,² D. Baltimore,³ S. Reed,¹ V. Slepshkin,¹ T. Dubensky.¹
¹Immune Design, Seattle; ²Univ. So. California, Los Angeles; ³California Inst. Tech., Pasadena.

While multiple platforms based on recombinant strains of viruses and bacteria are in various stages of development and evaluation in human clinical trials, there is yet to be a single vector platform which is a component of an FDA-licensed vaccine or therapy. To address this need, we are developing a lentivirus-based vector platform termed DC-NILV (Dendritic Cell targeting Non-Integrating Lentiviral Vector). Dendritic cells (DCs) are essential antigen presenting cells for the initiation and control of immune responses. Vaccine

platforms that deliver encoded antigens directly to DCs and within this context co-express immune modulators to shape the induced immune response are conceptually attractive. DC targeting via the DC-SIGN receptor was achieved by pseudotyping with Sindbis virus (SV) glycoprotein. SV is an arthropod-borne virus that infects dermal DCs following a bite from an infected mosquito. Infection of human DCs was highly efficient (MOI=10) using DC-NILV produced with deoxymannojirimycin (DMNJ). DMNJ is an inhibitor of host cell mannosidase I that promotes N-glycan envelope glycoproteins with terminal mannose residues, similar to SV propagated in mosquitoes. Integration-defective lentiviral vectors will facilitate regulatory approval for clinical evaluation of vaccine candidates given by direct administration. We utilized a redundant approach to render DC-NILV integration defective by combining a *pol* gene encoding a mutant Integrase (D64V) for vector production with a self-inactivating (SIN) vector backbone deleted in the 3' LTR U3 region and the 3' LTR-proximal polypurine tract. This composition favors formation of single-LTR reverse transcribed episomal dsDNA circles in infected DCs, which are not a template for chromosomal integration. Unprocessed titers of DC-NILV produced by transient transfection were >10⁶ infectious units (IU)/mL. We developed chromatography-based methods for large scale (>10¹¹ IU) production, together with release assays suitable for evaluation of vector in humans. A homologous prime-boost immunization regimen with 10⁷ IU of DC-NILV encoding LCMV gp33 induced robust polyfunctional primary and secondary CD8 T cell immunity. A single vaccination with 10⁷ IU of DC-NILV encoding OVA induced a stable CD8 T cell memory population of ca. 2% that expanded more than 3-fold and provided 6 logs of protective immunity against challenge at 28 days post immunization with vaccinia virus encoding OVA. DC-NILV encoding AH1-A5, an altered peptide ligand derived from the endogenous rejection Ag AH1 in CT26 tumor cells, induced 4% primary CD8 immunity, and a single vaccination conferred 60% long-term survival in BALB/c mice bearing CT26 tumors. Combination therapy of DC-NILV immunization with CD40 receptor antibody conferred 100% long-term survival. Based on these results and methods for efficient large-scale production and purification, we are developing a DC-NILV vaccine candidate for a first-in-human evaluation in the setting of cancer.

84. T Cells Modified To Express Tumor Associated Antigens and Dendritic Cell-Activating Molecules for Cancer Vaccination

Adham S. Bear,¹ Meghan E. Turnis,¹ Xiao-Tong Song,¹ Conrad R. Cruz,¹ An Lu,¹ Gottschalk M. Stephen,¹ Cliona M. Rooney,¹ Aaron E. Foster.¹

¹Center for Cell and Gene Therapy, Baylor College of Medicine, Texas Children's Hospital, and The Methodist Hospital, Houston, TX.

Introduction: Cancer vaccines have shown promise in small animal models of cancer, but have thus far been disappointing in clinical settings. Cancer vaccine success is dependent on the delivery of tumor-associated antigens (TAA) within lymphoid tissue in the context of costimulatory molecules and immune stimulatory cytokines. T cells expanded *ex vivo* readily migrate to lymphoid tissue following infusion. T cells may also be genetically modified to express both TAA and dendritic cell (DC)-activating molecules. These properties make T cells ideal candidates as cellular vehicles for TAA delivery to lymph node-resident DC *in vivo*. We hypothesize that T cells modified to express DC-activating molecules may efficiently target TAA to lymphoid tissue and prime anti-tumor T cell responses via the induction of DC maturation. **Methods:** T cells were harvested from spleens of wt C57BL/6J mice and activated with ConA and IL-2. T cells were subsequently transduced with a bicistronic retroviral vector encoding firefly luciferase, tyrosinase-related

protein 2 (Trp2), flagellin, or CD40 ligand (CD40L), in combination with a Thy1.1 reporter gene. T cells pulsed with CD8-restricted epitopes for ovalbumin (Ova 257-264) or Trp2 (Trp2 180-188) were administered i.v. alone or in combination with lipopolysaccharide (LPS), anti-CD40 monoclonal antibody, or T cells expressing flagellin or CD40L. Immunologic responses to vaccination were measured using pentamer staining and IFN- γ ELISPOT assays. Vaccine efficacy was assessed using B16-Ova and B16-F10 melanoma cell lines. Results: Luciferase-expressing T cells rapidly migrate to lymphoid organs such as the spleen as well as the cervical and inguinal lymph nodes. Administration of Ova-pulsed T cells primes peptide-specific CD8+ T cells, and leads to decreased tumor growth and increased survival in mice subsequently challenged with B16-Ova ($p < 0.05$). Vaccination with Ova- or Trp2-pulsed T cells in combination with LPS or anti-CD40 results in decreased tumor growth and increased survival in mice with pre-established B16-Ova or B16-F10 tumors ($p < 0.05$). Vaccination with Ova- or Trp2-pulsed T cells alone did not inhibit tumor growth. Vaccination with TAA-bearing T cells genetically modified to express the DC activating molecules flagellin or CD40L inhibited tumor growth and increased survival ($p < 0.05$) in mice with pre-established B16 melanoma tumors. Conclusions: The efficient delivery of TAA to lymphoid tissues by T cells overcomes a major limitation of other vaccine strategies. Vaccination with TAA-bearing T cells primes antigen-specific T cell responses with anti-tumor capability. Vaccination in combination with endogenous DC maturation enhances antigen-specific T cell responses and leads to inhibition of established B16-Ova and B16-F10 tumors, which highlights the role of endogenous DC as mediators of the vaccine response. Genetic modification of T cells with the DC activating molecules flagellin or CD40L enhances anti-tumor effects.

Small RNA and Oligonucleotide Based Therapeutics

85. Systemic Delivery of RNase H-Active Antisense Oligos in a Transgenic Mouse Model of Myotonic Dystrophy Type 1

Thurman M. Wheeler,¹ Andrew J. Leger,² Sanjay K. Pandey,³ A. Robert MacLeod,³ Masayuki Nakamori,¹ Seng H. Cheng,² C. Frank Bennett,³ Bruce M. Wentworth,² Charles A. Thornton.¹

¹Department of Neurology, University of Rochester, Rochester, NY;

²Genzyme Corporation, Framingham, MA; ³Isis Pharmaceuticals, Carlsbad, CA.

Objective: To test whether systemic delivery of RNase H-active antisense oligos (ASOs) can reduce or eliminate RNA toxicity in a transgenic mouse model of myotonic dystrophy type 1 (DM1). **Background:** DM1 is a dominantly inherited degenerative disease caused by expression of an expanded CUG repeat (CUGexp) in the 3' UTR of the DMPK transcript. CUGexp RNA accumulates in the nucleus, sequesters poly(CUG) binding proteins, and forms nuclear inclusions. Trans-dominant effects of the mutant transcript include aberrant pre-mRNA splicing, dysregulated gene expression, myotonia, and muscular dystrophy. Human skeletal actin-long repeat (HSA-LR) transgenic mice express CUGexp RNA in the 3' UTR of an hACTA1 transgene. In this model, the toxic RNA is retained in the nucleus and induces splicing changes similar to DM1. Antisense knockdown of pathogenic RNA would be expected to mitigate clinical features of DM1. However, skeletal muscle is less sensitive to ASO effects because distribution of ASOs to muscle tissue is low. In previous studies in rodents ($n = 10$), systemic ASOs failed to produce target knockdown in muscle, despite strong effects in liver. **Design/methods:** ASOs were 2' methoxyethyl gapmers that were designed to work by recruiting the nuclear enzyme RNase H to the ASO-RNA heteroduplex. ASOs targeting the hACTA1 mRNA were screened in cell culture. Active ASOs then were tested by subcutaneous injection

in mice (25 mg/kg biweekly for 4 weeks). Control mice were treated with saline. Treatment assignments were randomized and analysis was blinded. Control ASOs targeted Malat1, Pten, and Srb1. Results: Two hACTA1-targeting ASOs reduced transgene levels by up to 80%. Control ASOs had no effect. Serum chemistries and histopathology showed no evidence of toxicity. Knockdown of toxic RNA was associated with elimination of myotonia and correction of RNA mis-splicing in all muscles examined. These effects persisted at least 15 weeks after the final dose. By microarray analysis, > 85% of changes in gene expression were normalized or improved. Another nuclear-retained non-coding RNA, Malat1, was also sensitive to knockdown in muscle (up to 80%) using similar RNase H ASO designs. However, ASOs targeting endogenous mRNAs (Pten, Srb1) did not produce knockdown in muscle, and the distribution of ASOs to skeletal muscle in the DM1 model was not higher than in WT mice. **Conclusions:** Systemic delivery of RNase H-active ASOs was surprisingly effective at reducing RNA toxicity in a transgenic mouse model of DM1. Nuclear-retained transcripts may display increased sensitivity to RNase H-active ASOs and enable RNA knockdown in muscle tissue where biodistribution is low. The mechanism may relate to residence time of transcripts in the nucleus, the cellular compartment in which RNase H1 is also located. ASOs that act through the RNase H pathway may exploit the nuclear retention phenomenon to gain a therapeutic advantage in DM1.

86. Role of Ago2 and microRNAs in Mammalian Development

Paul N. Valdmann,¹ Hakkyun Kim,¹ Yannick Pouliot,¹ Mark A. Kay.¹

¹Pediatrics, Stanford University, Stanford, CA.

RNA interference occurs by two broad processes: mRNA site-specific cleavage and non-cleavage mRNA degradation and/or translational repression. Mammals have four argonaute genes; however, only argonaute-2 (Ago-2) is able to perform site-specific cleavage, while all four mammalian argonaute proteins (Ago-1 to Ago-4) can carry out non-cleavage-mediated inhibition. The role of Ago-2 in mediating site-specific mRNA cleavage is essential in mammals, in particular during embryonic development, as Ago2^{-/-} mice suffer severe developmental abnormalities after embryonic day 10.5 (E10.5) and are lethal soon thereafter. To identify the cause of this Ago2-dependent embryonic event, we performed small RNA high throughput sequencing of mouse embryonic fibroblast (MEF) cell lines both before (E10.5) and after (E13.5) this critical time point as well as Ago2^{-/-} cells at E10.5 and the other three mouse Ago genes (Ago1,3,4^{-/-}) triple knockout. MirVana-extracted small RNAs were cloned in a 5' phosphate dependent manner, aligned to linkers and sequenced on an Illumina GAII machine. Reads (17-28bp) were aligned to mirBase (release 15) using the Bowtie alignment program allowing for two mismatches as well as manually curated lists of ribosomal RNAs, transfer RNAs, small nucleolar RNAs and overall to the mm9 mouse genome. Normalization of microRNA reads revealed a cluster of ~50 microRNAs in a ~800 kilobase pair region on mouse chromosome 12 that are dramatically upregulated in E13.5-derived MEFs relative to E10.5 wildtype and Ago2^{-/-} MEFs. The expression of representative microRNAs in the locus including mir-127 and mir-376 were validated by northern blot analysis. Interestingly, mir-127 is expressed from a transcript antisense to the Rtl1 gene and has been shown to cleave Rtl1 in an Ago-2 dependent manner. RT-PCR analysis revealed that the expression of nearby non-coding RNAs including Gtl2, Dlk1 and an antisense Rtl1 transcript were also exclusively expressed at the E13.5 time point. This switch between reciprocal expression and repression of chromosome 12qF1 genes and microRNAs is one that we believe is critically dependent on Ago2 for development.

87. First Results of a Phase 2-3 Clinical Study with the Immunomodulator MGN1703 in Patients with Advanced Colorectal Carcinoma (IMPACT Study)

M. Schmidt,¹ H. J. Schmoll,² F. Mayer,³ J. Riera-Knorrenschild,⁴ G. Hapke,⁵ B. Hildebrandt,⁶ W. Eisterer,⁷ J. Andel,⁸ R. Ziebermayr,⁹ E. Weith,¹ M. Schroff,¹ B. Wittig,¹ M. Tschalka.¹

¹Mologen AG, Berlin, Germany; ²Martin-Luther-University Halle-Wittenberg, Halle, Germany; ³University of Tuebingen, Tuebingen, Germany; ⁴Universitätsklinikum Giessen und Marburg, Marburg, Germany; ⁵Kath. Marienkrankenhaus GmbH, Hamburg, Germany; ⁶Gesundheitszentrum der Charité CVK, Charité Universitätsmedizin Berlin, Berlin, Germany; ⁷Medizinische Universität Innsbruck, Innsbruck, Austria; ⁸Landeskrankenhaus Steyr, Steyr, Austria; ⁹Elisabethinen Linz, Linz, Austria; ¹⁰Foundation Institute Molecular Biology and Bioinformatics, Freie Universität Berlin, Berlin, Germany.

Background. The synthetic DNA-based immunomodulator MGN1703 acts as an agonist of toll-like receptor 9 (TLR9). A good safety profile and promising efficacy results were already shown in the currently finished phase 1 study in patients with metastatic solid tumors including those with CRC. Based on these promising data, a phase 2-3 study was initiated in patients with advanced CRC who have disease control after first-line induction therapy. **Methods.** This is an international multicentric randomized double-blinded placebo-controlled phase 2-3 clinical study in patients with advanced CRC with disease control after first-line induction therapy with standard chemotherapy regimen in combination with bevacizumab. It is planned to recruit 129 patients to the study. They are randomized to be treated either with MGN1703 or with placebo (with a ratio of 2:1, respectively). The recruited patients are treated subcutaneously with MGN1703 or placebo twice a week. The administered dose of 60 mg MGN1703 has been proven to be safe in the phase 1 clinical study. The efficacy and safety of the study treatment will be evaluated based on extensive immunological tests, radiological assessment, safety laboratory results and assessments of the quality of life. The study treatment will be continued up to occurrence of tumor progression, intolerable toxicity, exclusion criteria, and withdrawal of consent or death. **Results.** Currently, only two kinds of AEs have been reported that were judged as study related by the investigator: mild fever (at three occasions) and mild arthralgia reported in one patient, each. Local reactions in terms of mild redness were reported only in single patients. No dose-limiting toxicities were reported. **Conclusions.** These preliminary results show clearly that treatment with MGN1703 at the dosage of 60 mg is well tolerated and safe.

88. ShRNA-Mediated Gene Silencing in Primates with AAV8

Takayuki Kubodera,¹ Shinga Ohira,¹ Yuko Katakai,² Hiroaki Mizukami,³ Yukihiko Hirai,⁴ Michio Imamura,⁵ Kazuaki Chayama,⁵ Takashi Shimada,⁴ Keiyo Ozawa,³ Hidehiro Mizusawa,¹ Takanori Yokota.¹

¹Department of Neurology and Neurological Science, Tokyo Medical and Dental University, Tokyo, Japan; ²Tsukuba Primate Research Center, National Institute of Biomedical Innovation, Ibaraki, Japan; ³Division of Genetic Therapeutics, Center for Molecular Medicine, Jichi Medical University, Tochigi, Japan; ⁴Department of Biochemistry and Molecular Biology, Nippon Medical School, Tokyo, Japan; ⁵Department of Medicine and Molecular Science, Hiroshima University, Hiroshima, Japan.

Studies in rodent models have been indicated that AAV vectors expressing short hairpin RNA (shRNA) showed promise for the silencing of target genes in the liver by systemic administration, but these vectors remain largely untested in primate models towards

preclinical evaluation of shRNA-based gene therapy. We therefore evaluated the efficacy and toxicity following liver-directed delivery with AAV8/shRNA vectors using nonhuman primates (NHPs) and human hepatocyte chimeric mice. We made AAV8 vectors which express shRNA targeting Cu/Zn superoxide dismutase (SOD1) under pol III promoter. SOD1 is ubiquitously expressed in the liver. 1×10^{12} and 1×10^{13} v.g./kg of AAV8-SOD1 shRNA vectors were intravenously injected into two species of NHPs, respectively cynomolgus macaques (Old World monkeys) and Tamarins (New world monkeys). Unexpectedly, the expression of SOD1 in the liver was not suppressed in tamarins. On the other hand, it was efficiently suppressed in cynomolgus macaques without any toxicity and the efficacy in cynomolgus macaques was almost equally to that in mice. The efficacy was correlated with the expression level of shRNA, and the expression of shRNA in cynomolgus macaques was over ten times higher than that in tamarins. As transgene copy number in each liver of cynomolgus macaques and tamarins was dependent on viral vector dose, the efficiency of shRNA transcription may differ in the two species of NHPs. To further investigate the potential AAV8 /shRNA vectors, we made AAV8 vectors which express shRNA targeting transthyretin (TTR). TTR is a serum protein synthesized primarily in hepatocytes and its gene mutation cause familial amyloidotic polyneuropathy which is characterized by extracellular deposition of amyloid fibrils in various organs. We injected 1×10^{12} to 6.25×10^{12} v.g./kg of AAV8-TTR shRNA vectors into cynomolgus macaques and evaluated its long-term effect. With low-dose of AAV8-TTR shRNA vectors, significant serum TTR suppression sustained for 15 weeks after injection. Finally, to examine the effect of AAV8/shRNA vectors in human that is our goal species, AAV8-TTR shRNA vectors were intravenously injected into human hepatocyte chimeric mice which are generated by transplantation of human hepatocytes and the replacement index is over 70%. In these mice, although more viral dose was needed than cynomolgus macaques, the expression of human TTR was suppressed by more than 90%. In conclusion, we first succeeded in the persistent gene silencing of NHPs by liver-directed delivery with AAV8/shRNA vectors and furthermore demonstrated its efficacy in human hepatocytes. These results represent important implications towards clinical application in human gene therapy.

89. Dual Functional BAFF Receptor Aptamers Inhibit Ligand Induced Proliferation and Deliver siRNAs to NHL Cells

Katrin Tiemann,¹ Piotr Swiderski,² Stephen Forman,³ John Rossi,^{1,4} Jiehua Zhou.¹

¹Division of Molecular and Cellular Biology, Beckman Research Institute of City of Hope, Duarte, CA; ²Shared Resource-DNA/RNA Peptide, Beckman Research Institute of City of Hope, Duarte, CA; ³Department of Hematology and Bone Marrow Transplantation, Beckman Research Institute of City of Hope, Duarte, CA; ⁴Irell and Manella Graduate School of Biological Sciences, Beckman Research Institute of City of Hope, Duarte, CA.

The BAFF-receptor is restrictedly expressed on B-cells and is often over-expressed in B-cell malignancies such as Non-Hodgkin's Lymphoma. Upon binding to its ligand BAFF (B-cell activating factor), proliferation and cell survival are increased enabling cancer cells to proliferate faster than normal B-cells. Attempts have been made to block this pathway by the use of antibodies and chemical molecules as treatment for autoimmune disease and B-cell malignancies. To date, no one has attempted to identify aptamers that recognize the BAFF receptor. Aptamers could potentially be used to compete for BAFF ligand binding and for delivery of siRNAs into B-cells. We therefore used SELEX to isolate several 2'-F modified RNA aptamers targeting the B-cell specific BAFF-receptor. The aptamers we evolved bind to the BAFF-R with nano-molar affinity. The aptamers can efficiently bind and be specifically internalized to B-cells (such as, Jeko-1 and

Z138 cells) and unlike the BAFF ligand, they do not trigger cell proliferation. Importantly the aptamers are able to block BAFF ligand mediated cell proliferation and compete effectively with BAFF ligand for receptor binding, blocking. In an effort to enhance the functional utility of the aptamers, we created aptamer-STAT3 siRNA chimeras for cell-type specific siRNA delivery. The aptamer-siRNA chimera showed similar receptor binding profiles as the aptamer alone, and binding resulted in internalization of the aptamer and siRNA. The siRNA was processed by Dicer and incorporated in RISC where it triggered potent knockdown of the STAT3 mRNA and protein in Jeko-1 and Z138 B-cell lines. We also evaluated the aptamer delivered siRNA functional activity by carrying out RACE PCR analyses. The results showed that the target cleavage sites correlated with Dicer produced siRNAs as revealed by Illumina sequencing. Hence our results demonstrate that the dual-functional BAFF-R aptamer chimeras are able to deliver siRNAs and block ligand mediated processes. Our next step is to test the efficacy of the aptamer and aptamer chimeras *in vivo* in a humanized mouse model.

90. Nanoparticle Delivery of PNA and Donor DNA for Genomic Modification and Inactivation of the CCR5 Gene

Erica B. Schleifman,¹ Nicole Ali McNeer,¹ Andrew Jackson,¹ Jean Leif,² Christopher Cheng,¹ Ranjit S. Bindra,¹ Leonard D. Shultz,³ Dale L. Greiner,² Priti Kumar,¹ W. Mark Saltzman,¹ Peter M. Glazer.¹

¹Yale University, New Haven, CT; ²University of Massachusetts Medical School, Worcester, MA; ³The Jackson Laboratory, Bar Harbor, ME.

CCR5, chemokine receptor 5, encodes a major co-receptor for R5-tropic human immunodeficiency virus-1 (HIV-1) and must be present at the cell surface for R5-viral entry. Individuals who are homozygous for a 32 bp deletion mutation (delta32) in CCR5 are almost completely resistant to HIV-1 infection and show no significant adverse phenotypes. One therapeutic strategy for individuals with HIV infection is to use peptide nucleic acid (PNA)-induced homologous recombination to introduce mutations into the CCR5 gene in hematopoietic cells to mimic the effect of the naturally occurring delta32 mutation, thereby creating blood cells resistant to HIV. These triplex-forming PNAs bind sequence specifically to duplex DNA and, when combined with donor DNA molecules, stimulate recombination in mammalian cells. We have found that triplex-forming PNAs can enhance recombination in the CCR5 gene in a human cell line at a targeting frequency of 2.45%. To further enhance the efficiency and reduce the toxicity of gene targeting in primary human primary cells, we have tested the use of biodegradable poly (lactide-co-glycolide) (PLGA) nanoparticles (PLGA-NPs) that can encapsulate both the triplex-forming PNAs and the donor DNAs for delivery into various cell types. CCR5-targeted PLGA-NPs were formulated by a double-emulsion solvent evaporation technique and evaluated for their ability to enter CD34⁺ hematopoietic stem cells (HSCs) or peripheral blood mononuclear cells (PBMCs) and deliver PNA and donors for gene targeting. Efficient cellular uptake of the PLGA-NPs in both cell types was verified by FACS analysis, and targeted modification was observed at levels equal to or greater than after conventional nucleofection of the same molecules. Treatment of these cell types with NPs also led to a reduction in cellular toxicity compared to conventional nucleofection techniques. The addition of cell-penetrating peptides to the surface of the NPs led to an increase in targeted genomic modification in both PBMCs and CD34⁺ HSCs. PBMCs treated with CCR5-targeted NPs were injected into NOD-*scid* IL2r^γ^{null} adult mice and were able to engraft at levels equal to untreated cells and the presence of the targeted CCR5 modification was detected in the spleen of the engrafted mice four weeks post-transplantation. This work suggests a potential therapeutic strategy for permanently

inactivating the CCR5 co-receptor in human HSCs or PBMCs from HIV-1 infected individuals to create a reservoir of cells, which are virus-resistant, thus preserving immune system function.

91. In Vivo HIV Inhibition by CCR5 Knock-Down by RNA Interference through Stem Cell Based Gene Therapy Approach in the Humanized NSG BLT Mouse Model

Saki Shimizu,^{1,2} Ruth Cortado,^{1,2} Emily Lowe,^{1,2} Anna Sahakyan,^{1,2} Joshua Boyer,^{1,2} Tom Suree,^{1,2} Dong Sung An.^{1,2}
¹School of Nursing, University of California, Los Angeles, Los Angeles, CA; ²Department of Medicine, Division of Hematology-Oncology, David Geffen School of Medicine, University of California, Los Angeles, Los Angeles, CA.

Inhibiting the expression of the HIV-1 co-receptor CCR5 holds great promise for controlling HIV-1 infection in patients. Here we report HIV inhibition by stable knockdown of human-CCR5 by a short hairpin RNA (shRNA) in a humanized bone marrow/liver/thymus (BLT) mouse model. To achieve stable knockdown of human-CCR5 by a short hairpin RNA (shRNA), we delivered a potent shRNA against CCR5 into human CD34⁺ hematopoietic progenitor/stem cells (HPSCs) by lentiviral vector transduction. We transplanted vector-transduced CD34⁺ cells and a thymus segment under the mouse kidney capsule to produce human T cells in the transplanted human thymus tissue. Vector-transduced autologous CD34⁺ cells were subsequently injected in the irradiated mouse intended to create systemic reconstitution. CCR5 expression was down-regulated in human T cells and monocytes/macrophages in systemic lymphoid tissues. The shRNA-mediated CCR5 knockdown had no apparent adverse effects on T cell development as assessed by polyclonal T cell receptor Vβ family development and naive/memory T cell differentiation. We next examined HIV inhibition *ex vivo* and *in vivo*. CCR5 tropic HIV-1 infection was effectively inhibited in isolated human splenocytes *ex vivo*. When mice were challenged with CCR5 tropic HIV-1, we observed selective maintenance of the CD4/CD8 ratio in CCR5-shRNA expressing mouse PBMCs. This phenomenon was also confirmed in various mouse tissues, including gut associated lymphoid tissue (GALT) which is the major site of HIV-1 replication. Furthermore, CCR5 down-regulated memory CD4⁺ T cells were protected from depletion by HIV-1 infection. We measured the amount of HIV-1 DNA in isolated human splenocytes by Real time PCR. We confirmed the amount of HIV-1 DNA was low in CCR5 down-regulated cells compared to control cells. These results demonstrated that lentiviral vector delivery of shRNA into human HPSCs could stably down-regulate CCR5 and prevent CD4⁺ T cell and memory CD4⁺ T cell depletion by HIV-1 infection. Our current results provide further evidence that it may be possible to use of this technology in HIV-1 treatment.

92. Efficient In Vivo Delivery of Vitamin E-Conjugated siRNA from Colorectum to Liver

Kazutaka Nishina,¹ Masahiro Murakami,² Kie Yoshida,¹ Hiroya Kuwahara,¹ Hidehiro Mizusawa,¹ Takanori Yokota.¹
¹Graduate School, Tokyo Medical and Dental University, Tokyo, Japan; ²Osaka Ohtani University, Osaka, Japan.

RNA interference (RNAi) is a powerful tool of target-specific knockdown of gene expression. For a therapeutic approach, however, efficient and safe *in vivo* delivery of short interfering RNA (siRNA) to the target organ has not been established. Here, as a carrier molecule of siRNA to the liver, we use vitamin E (α -tocopherol) and its own physiological transport system. Orally intaken α -tocopherol is absorbed, assembled in chylomicron (CM) in enterocytes and excreted into the lymph duct. CM is metabolized into chylomicron remnant by lipoprotein lipase (LPL) which enters hepatocytes by remnant

receptor-mediated endocytosis. The α -tocopherol was covalently bound to antisense strand of 27/29 mer siRNA at the 5' end with the special linker (Toc-siRNA). The 27/29 mer Toc-siRNA was chemically modified and designed to be cleaved by Dicer, producing a mature form of 21/21 mer siRNA after releasing α -tocopherol. When Cy3-labeled Toc-siRNA assembled with absorption-promoting agents was applied inside the colorectum of mouse, Cy3 signal is detected CM in the lymph duct by Fluorescence Correlation Spectroscopy analysis. In hepatocytes, Cy3 signal was robustly observed in the cytoplasm, and the target molecule of siRNA, *apoB* mRNA, was efficiently suppressed. This delivery of siRNA from the intestine to the liver was disappeared without α -tocopherol conjugation to siRNA. Moreover, this delivery to hepatocytes was much reduced in fasting mouse, and blocked by applying LPL inhibitor. These results clearly indicated that Toc-siRNA applied inside colorectum is delivered to liver by CM in lymph duct and remnant receptors of hepatocytes. There was no abnormality in pathology of colorectum. No remarkable toxic or immune-stimulatory side effects were observed through blood biochemical analyses and histopathological investigation. These findings suggest that Toc-siRNA is a promising *in vivo* delivery system of siRNA from colorectum to liver.

Stem Cell Therapies I

93. Generation of Gene-Corrected, Vector- and Reprogramming Factor-Free iPSC Cells from SCID-X1 Patients

Angelo Lombardo,^{1,2} Pietro Lo Riso,^{1,2} Bruno Di Stefano,³ Mario Amendola,¹ Michael C. Holmes,⁴ Philip D. Gregory,⁴ Andrew R. Gennery,⁵ Vania Broccoli,³ Luigi Naldini.^{1,2}

¹San Raffaele Telethon Institute for Gene Therapy, San Raffaele Institute, Milan, Italy; ²Vita-Salute San Raffaele University, Milan, Italy; ³Stem Cell and Neurogenesis Unit, San Raffaele Institute, Milan, Italy; ⁴Sangamo BioSciences Inc., Richmond, CA; ⁵Newcastle Upon Tyne Hospital, Newcastle upon Tyne, United Kingdom.

Gene-corrected induced Pluripotent Stem Cells (iPSC) derived from patients have great potential for the treatment of human genetic diseases for which isolation, *ex vivo* expansion and/or genetic correction of autologous cells for therapy is technically challenging. To date the most efficient approach to derive and correct iPSC exploits randomly integrating vectors. However, such non-targeted methods have the following limitations: i) uncontrolled expression of the therapeutic transgene; ii) stable transfer of the oncogenic transcription factors used for reprogramming and their potential re-activation in the iPSC progeny; iii) the potential for insertional mutagenesis. Here, we have addressed these issues using a combined strategy that allows for targeted correction of the endogenous mutated, disease-causing gene and safe reprogramming of patient cells. SCID-X1 (caused by mutations in the *IL2RG* gene) was chosen as a model to assess the feasibility of this approach, as HSC-based gene therapy trials showed major clinical benefits but also unacceptable rate of leukemia due to insertional mutagenesis and uncontrolled transgene expression. Using Zinc Finger Nucleases (ZFNs) targeting the *IL2RG* gene we knocked-in a functional *IL2RG* cDNA downstream of its endogenous promoter in B-lymphoblastoid cells and fibroblasts from normal male donor and SCID-X1 patients. To select for the corrected fibroblasts, which do not express *IL2RG*, we included downstream of the *IL2RG* cDNA a loxP-flanked GFP expression cassette driven by the SFFV promoter. Molecular analyses performed on the GFP+ sorted cell pools and 30 single cell-derived clones confirmed targeted integration into *IL2RG*. Importantly, FACS and RT-PCR analyses performed on the B-lymphoblastoid cells showed physiologic expression of the edited *IL2RG* gene. For fibroblast reprogramming to iPSC, we developed a novel lentiviral vector (LV) containing loxP sites in the

LTR and expressing the human OCT4, KLF4 and SOX2 genes from a mono-cistron that was recoded for robust expression, allowing for single-copy LV reprogramming. Unedited and gene-corrected SCID-X1 fibroblasts transduced at single-copy with this LV were reprogrammed at efficiencies (up to 0.03%) comparable to those obtained with standard multiple-copies RVs. Derived iPSC clones homogeneously expressed pluripotency markers and contained on average 1.2 LV copies *per cell*. Upon transient Cre delivery, the reprogramming LV and the GFP cassette were excised from ~95% of the iPSC clones. In conclusion, these data show the feasibility of generating gene-corrected, vector- and reprogramming factor-free iPSC cells from SCID-X1 patients, thus replacing the risks related to the use of randomly integrating vectors with the predictability of ZFN-driven targeted insertion, paving the way toward the development of safer iPSC for regenerative medicine.

94. microRNA-126 Modulates the Sensitivity of Hematopoietic Stem and Progenitor Cells to Environmental Signals

Bernhard Gentner,¹ Alice Giustacchini,¹ Francesco Boccalatte,¹ Massimo Saini,¹ Eric Lechman,² John E. Dick,² Luigi Naldini.¹
¹San Raffaele Telethon Institute for Gene Therapy HSR-TIGET, Milano, Italy; ²UHN, Toronto, Canada.

We recently identified miR-126 as a hematopoietic stem cell (HSC) microRNA (Gentner et al, *Sci Transl Med.* 2010 Nov 17;2(58):58ra84). Yet, little is known about its function in hematopoietic stem and progenitor cells (HSPC). We generated a stable miR-126 knockdown (kd) or forced its expression (knock-in, ki) in mouse HSPC using lentiviral vectors. Kd or ki cells were competitively transplanted with congenic, control vector-transduced cells, and hematopoietic chimerism was followed for >1 year in primary and secondary recipients. Forced expression of miR-126 resulted in a higher myeloid and B cell contribution compared to control cells at week 2-4 after transplant. However, this was followed by a progressively decreasing contribution of miR-126 ki cells to all hematopoietic lineages and a nearly complete depletion of Kit+Sca+Lin- (KSL) BM cells by 6 weeks after transplant. At 3 weeks post-transplant, when miR-126 ki KSL cells could still be detected, we found an increased proliferative index in these cells as judged by *in vivo* EdU incorporation. These data suggest that miR-126 ki might favor HSC commitment at the cost of self-renewal. This phenotype was specific for miR-126 and not due to vector toxicity, as we demonstrate stable, long term overexpression of several control miRNAs *in vivo*. Moreover, miR-126 ki cells showed normal clonogenic activity *in vitro*. On the contrary, miR-126 kd HSPC engrafted long-term in competitive transplantation assays, and miR-126kd cell chimerism was >2 fold above control specifically in the HSC-enriched Lin-Kit+Sca+CD150+CD48- bone marrow (BM) compartment. We furthermore noted enhanced myeloid and/or lymphoid contribution during the early phases of reconstitution which was reproducible upon serial transplantation, suggesting that miR-126 kd enhances hematopoiesis particularly under stress conditions, possibly by modulating HSC responses to environmental signals. We then optimized a protocol to stably knock down miR-126 in human cord blood (huCB) HSPC, and validated this approach by demonstrating upregulation of previously described miR-126 targets including the beta subunit of phosphoinositide-3-kinase (Pi3K). Importantly, we provide evidence for increased activation of the Pi3K-Akt pathway in miR-126 kd huCB cells upon cytokine stimulation, and these cells show enhanced growth and increased CFU-C content when cultured in the presence of early acting cytokines. Identification of additional miR-126 targets is ongoing using unbiased proteomic and transcriptomic approaches. In summary, these data identify miR-126 as a novel HSC regulator, possibly modulating the responsiveness of HSPC to growth/survival & differentiation signals. Further study of miR-126 will provide new insights into hematopoietic stem cell

biology which might facilitate the usage of these clinically relevant cells for novel gene therapy approaches.

95. Highly Efficient Hematopoietic Reconstitution by *In Vivo* Chemoselection of HPRT-Deficient Bone Marrow with 6-Thioguanine

Katrin Hacke,¹ Akos Szakmary,² Andrew R. Cuddihy,² Janet A. Treger,¹ Brooke T. Bogan,¹ Nora Rozengurt,² Nathan A. Lemp,¹ Jiri Aubrecht,³ Gregory W. Lawson,⁴ Nagesh P. Rao,² Gay M. Crooks,² Robert H. Schiestl,² Noriyuki Kasahara.¹
¹Medicine, University of California, Los Angeles, Los Angeles;
²Pathology and Laboratory Medicine, University of California, Los Angeles, Los Angeles;
³Drug Safety Research and Development, Pfizer Global Research and Development, Croton, CT;
⁴Department of Laboratory Animal Medicine, University of California, Los Angeles, Los Angeles.

Hematopoietic stem cell transplantation (HSCT) is a mainstay of treatment for many hereditary disorders and lymphohematopoietic malignancies, and is the most commonly employed modality for *ex vivo* gene therapy. This procedure often entails myeloablative conditioning by irradiation and/or cytotoxic drugs which incur significant morbidity, and low engraftment rates frequently limit efficacy in the absence of a selective advantage that amplifies donor cells. Here we have tested a novel and highly efficient strategy for combined conditioning and chemoselection based on the fact that 6-thioguanine (6TG) myelotoxicity is dependent on its conversion to thioguanine nucleotide by hypoxanthine-guanine phosphoribosyltransferase (HPRT), and that HPRT-deficiency *per se* does not impair hematopoietic cell development or function. In a murine model of bone marrow (BM) transplantation, our initial results demonstrated that, at appropriate doses, 6TG efficiently induces selective myeloablation in HPRT-wild type (wt) recipients, without any detectable adverse effects on extra-hematopoietic tissues. In contrast, HPRT-deficient donor mice were highly resistant to its cytotoxic effects, and transplantation of HPRT-deficient BM consistently achieved rescue of syngeneic HPRT-wt recipients from lethal hematopoietic failure. Hence, using an optimized protocol, we then tested the use of 6TG as a single agent, both for myeloablative conditioning of 6TG-sensitive HPRT-wt recipients, and for on-going *in vivo* chemoselection of 6TG-resistant HPRT-deficient donor BM after transplantation. Combined 6TG conditioning and chemoselection achieved highly efficient engraftment and progressive expansion of HPRT-deficient donor BM without significant toxicity, consistently achieving ~95% engraftment in the absence of irradiation or any other cytotoxic conditioning regimen. Long-term reconstitution of histologically and immunophenotypically normal BM was achieved in primary and secondary recipients, indicating that 6TG chemoselection amplified the self-renewing, pluripotent HSC population from HPRT-deficient donor BM. In current studies, we are testing lentiviral vector-mediated expression of siRNA for knockdown of HPRT expression, in order to apply this combined 6TG conditioning and chemoselection procedure to transplantation of HPRT-wt donor-derived BM after genetic modification. Our results suggest that this protocol for highly efficient and overall non-toxic conditioning and *in vivo* chemoselection may be generally applicable as a strategy to improve HSCT engraftment efficiency and transplantation outcome, and to confer a selective advantage to genetically modified cells after *ex vivo* gene therapy.

96. Stem Cells Isolated from p65 Deficient Mice Improved the Histopathology of Skeletal Muscle in Dystrophic Mice

Aiping Lu,¹ Ying Tang,¹ Minakshi Poddar,¹ Bing Wang,¹ Denis C. Guttridge,² Paul D. Robbins,³ Johnny Huard.¹
¹Orthopaedic Surgery, University of Pittsburgh, Pittsburgh, PA;
²Molecular Virology, Immunology and Medical Genetics, Ohio State University, Columbus, OH;
³Microbiology and Molecular Genetics, University of Pittsburgh, Pittsburgh, PA.

Duchenne muscular dystrophy (DMD) is a deadly genetic disease mainly characterized by progressive weakening of the skeletal, cardiac and diaphragmatic muscles. It is critical to find a successful therapy that will improve the histopathology of the muscles of DMD patients and restore their normal function. Recent studies have demonstrated that blocking p65, a subunit of NF- κ B, enhances muscle regeneration in injured and diseased skeletal muscle which suggests that the NF- κ B signaling pathway is a contributing factor to the dystrophic pathology in DMD patients. Previously we demonstrated that muscle derived stem cells (MDSCs) isolated from the skeletal muscles of heterozygote P65 knock-out (P65^{+/-}) mice showed better muscle regeneration *in vitro* and *in vivo* compared to the MDSCs isolated from wild-type (WT) mice. We also demonstrated that the transplantation of P65^{+/-} MDSCs could reduce inflammation. Based on these results we performed a set of experiments to determine if these P65^{+/-} MDSCs could alleviate the pathology associated with DMD more efficiently than wild-type MDSCs. When the p65^{+/-} MDSCs were injected intraperitoneally (IP) into dystrophin/utrophin deficient (*dys*^{-/-}:*utro*^{-/-}, dKO) mice, a reliable mouse model of DMD, we found that the histopathology improvement in various skeletal muscles including the gastrocnemius, diaphragm, gluteus maximus and tibialis anterior muscles by H&E staining. Many centrally nucleated muscle fibers (new regenerated fibers) were found in the p65^{+/-} MDSC injection group. Mouse IgG staining showed that there were less necrotic muscle fibers in the mice injected with p65^{+/-} MDSCs compared to the PBS treated and un-treated muscle. An antibody against embryonic muscle heavy chain (E-MyHC) was used to evaluate newly regenerated and pathological muscle fibers and another antibody against F4/80 (a macrophage marker) was used to analyze the extent of inflammation in the muscle tissues. Those results showed less inflammation and pathological muscle fibers within the muscle injected with p65^{+/-} MDSCs compared to untreated and PBS treated muscles. Trichrome staining showed there were less fibrosis and fewer necrotic muscle fibers in the mice injected with p65^{+/-} MDSCs compared to PBS treated and the untreated muscles. Our findings indicated that IP transplantation of p65^{+/-} MDSCs can decrease macrophage infiltration, fibrosis formation, and necrosis, while improving muscle regeneration in 4 to 6 week old dKO mice. We also attempted to inject WT MDSCs isolated from normal animals; however, the results did not show a similar benefit in the histopathology of the dKO mice. These results suggest that combining stem cell therapy with anti-NF- κ B therapy is a potential therapeutic approach for the treatment of DMD. Additional experiments are required to determine whether the benefit observed with NF- κ B inhibition via stem cell therapy is superior than anti-NF- κ B gene therapy.

97. LYL1, a Basic Helix-Loop-Helix Transcription Factor, Promotes Hematopoietic Differentiation of Common Marmoset Embryonic Stem Cells

Hirota Kawano,¹ Tomotoshi Marumoto,^{1,2} Michiyo Okada,¹ Tomoko Inoue,¹ Takenobu Nii,¹ Jiyuan Liao,¹ Saori Yamaguchi,¹ Yoko Nagai,¹ Hiroyuki Inoue,^{1,2} Atsushi Takahashi,^{1,2} Erika Sasaki,³ Yoshie Miura,¹ Kenzaburo Tani.^{1,2}

¹Department of Molecular Genetics, Medical Institute of Bioregulation, Kyushu University, Fukuoka, Japan; ²Department of Advanced Molecular and Cell Therapy, Kyushu University Hospital, Fukuoka, Japan; ³Central Institute for Experimental Animals, KEIO University, Kawasaki, Japan.

Since the successful establishment of human embryonic stem cell (ESC) lines by James Thomson in 1998, transplantation of differentiated ES cells to the specific impaired organ has been expected to cure its defective function. For the establishment of the regenerative medicine, the preclinical studies using animal model systems including non-human primates are essential. We have recently demonstrated that non-human primate of common marmoset (CM) is suitable for the preclinical studies of hematopoietic stem cells (HSCs) therapy [Hibino H et al., *Blood* 93: 2839-48, 2009]. Since then we have continuously investigated the *in vitro* and *in vivo* differentiation of CM ESCs to hematopoietic cells by the exogenous hematopoietic gene transfer. In earlier study, we showed that the induction of CD34+ cells having a blood colony forming capacity from CM ESCs is promoted by the ectopic expression of TAL1/SCL. However those CD34+ cells did not have a bone marrow reconstituting ability in irradiated NOG (NOD/Shi-scid/IL-2R^γ null) mice, suggesting that transduction of TAL1/SCL gene is not enough to induce functional HSCs which have self-renewal capability and multipotency. Thus we tried to find other hematopoietic genes being able to promote hematopoietic differentiation more efficiently than Tal1/SCL when they are expressed in CM ESCs. We found that lentiviral transduction of LYL1, a basic helix-loop-helix transcription factor, in embryoid bodies (EBs) derived from Cj11, one of CM ESC lines, dramatically increased the number of cells positive for CD34, a marker for hematopoietic stem/progenitors. We also found that LYL1-overexpressing EBs showed the formation of multi-lineage blood cells consisting of erythroid cells, granulocytes and macrophages by CFU (colony-forming unit) assay. These results indicate that the ectopic expression of LYL1 can promote the differentiation of CM ESCs to HSCs *in vitro*. Furthermore we found that the combined activation of TAL1/SCL and LYL1 can enhance the emergence of CD34+ cells from CM ESCs than the activation of TAL1/SCL or LYL1 alone. This technology to induce hematopoietic differentiation of ESCs by the transduction of specific transcription factors are novel, and might be applicable for human regenerative medicine to cure human blood diseases.

98. Genome-Wide Definition of Transcriptionally Active Regulatory Elements in Human Stem Cells by Retroviral Scanning

Valentina Poletti,¹ Alessia Cavazza,² Annarita Miccio,² Danilo Pellin,³ Ermanno Rizzi,⁴ Giorgio Corti,⁴ Clelia Di Serio,³ Gianluca De Bellis,⁴ Fulvio Mavilio.^{1,2}

¹Gene Expression Unit, H.San Raffaele Scientific Institute, Milano, Italy; ²Center for Regenerative Medicine, University of Modena and Reggio Emilia, Modena, Italy; ³CUSSB, Vita-Salute San Raffaele University, Milano, Italy; ⁴Institute of Biomedical Technologies, CNR, Milano, Italy.

The rapidly expanding information on the structural and functional characteristics of the human genome allows the development of genome-wide approaches to the understanding of the molecular

circuitry wiring the genetic and epigenetic programs of somatic stem cells. High-throughput approaches are essential to study transcriptomes, chromatin dynamics and the use of regulatory elements in the genome. Very few studies exist for somatic stem cells, due to the absence of unambiguous markers for their prospective isolation. We have recently developed a tool to map functional regions of chromatin in stem and progenitor cells, based on the integration properties of the Moloney murine leukemia virus (MLV). By using a deep sequencing technology, we mapped >32,000 MLV integration sites in the genome of human CD34+ hematopoietic stem/progenitor cells (HPCs), and designed a detailed integration map throughout the genome. MLV integrations cluster in regions that co-map with transcriptionally active, cell-specific promoters and regulatory regions bearing epigenetic marks of active or poised transcription (H3K4me1, H3K4me2, H3K4me3, H3K9Ac, Pol II) and specialized chromatin configurations (H2A.Z). Single locus analysis showed association of MLV clusters with known enhancers and promoters, and allow the identifications of new regions with putative regulatory function (Cattoglio et al., *Blood* 2010). Functional genome mapping through retroviral “scanning” may be used as a tool to identify regulatory regions involved in the execution of stem cell genetic programs, providing a substantial contribution to a comprehensive description of the molecular circuitry associated with stem cell functions. We are exploiting this technique to identify regulatory elements associated with stemness, commitment and differentiation of prospectively isolated or retrospectively defined human stem cells and their progeny, such as HPCs and erythroid and myeloid committed precursors, embryonic stem (ES) cells and ES-derived neural precursors, epidermal stem/progenitor cells (EpSCs) cells and EpSC-derived keratinocytes. “Integromes” of at least 30,000 independent integrations are correlated to gene expression profiles and epigenetic genome annotations, and compared by rigorous statistical analysis to discover shared or lineage-specific regulatory regions.

99. Zinc Finger Nuclease Mediated Genomic Editing of CCR5 in Human Hematopoietic Stem Cells for Clinical Application in HIV Gene Therapy

Lijing Li,¹ Anitha Rao,¹ Lan-Feng Cao,¹ Kenneth Kim,³ Ursula Hofer,² Paula Cannon,² Philip D. Gregory,³ Michael C. Holmes,³ John Zaia,¹ Qing Liu,¹ John Rossi,¹ David DiGiusto.¹

¹Virology, City of Hope National Medical Center, Duarte, CA; ²University of Southern California, Los Angeles, CA; ³Sangamo BioScience, Richmond, CA.

The HIV co-receptor CCR5 is a validated target for HIV/AIDS therapy. We are currently developing methodologies for *ex vivo* treatment of hematopoietic stem cells (HSC) with Zinc Finger Nucleases (ZFN) designed to disrupt CCR5 expression with the intent of using these cells for autologous transplantation into patients with AIDS. Adenoviral vectors have been developed to deliver and express Green Fluorescence Protein (Ad5/F35-GFP) or a CCR5-specific ZFN (Ad5/F35-SB728) for these studies. We compared several compounds (interferon α , pleiotrophin and phorbol 12-myristate 13-acetate - PMA) known to have an effect on HSC activation, proliferation and differentiation for their ability to enhance adenoviral transduction, expression and (ultimately) ZFN activity at the CCR5 locus in HSCs. CD34+ HSC were isolated from G-CSF mobilized peripheral blood and prestimulated with SCF, Flt-3L and Tpo and then transduced with various amounts of adenovirus or prestimulated (as above) plus either IFN α , PTN, or PMA prior to viral transduction. Cells were assayed for viability, GFP expression, ZFN activity and *in vitro* hematopoietic potential over a 4 week period. Our results demonstrate that while as much as 50% of the cells are transduced and express GFP (from Ad5/F35-GFP) when exposed to vector alone, only PMA treatment resulted in both increased frequency of transduction (>98%), protein expression and ZFN activity (using Ad5/F35 vector expressing the

CCR5 ZFNs) with up to 45% of the genomic CCR5 target sites modified. We have established doses of PMA and virus that support high levels of ZFN activity with minimal impact on hematopoietic potential as measured in *in vitro* assays. We also tested endosomal disruption agents (chloroquine and oakadecic acid) for their ability to enhance ZFN expression in this system. Both compounds enhanced ZFN activity alone and Chloroquine also enhanced PMA-mediated ZFN activity. These results demonstrate that ZFN activity is enhanced in CD34+ cells following PMA treatment at least in part due to induction of very high levels of protein expression and that endosomal disruption further enhances ZFN activity in this system. We are currently comparing these conditions *in vivo* in an immunodeficient mouse model (NSG) to determine the effect of low dose PMA on engraftment and lymphoid lineage potential.

100. Human Neural Stem Cells of Parthenogenetic Origin

Ruslan Semechkin,¹ Dmitry Isaev,¹ Tatiana Abramihina,¹ Nikolay Turovets,¹ Richard A. West,² Tatjana Zogovic-Kapsalis,¹ Andrey Semechkin.¹

¹International Stem Cell Corporation, Oceanside, CA; ²Western Michigan University, Kalamazoo, MI.

The use of multipotent neural stem cells (NSC) in regenerative medicine may provide a potential treatment for Alzheimer's and Parkinson's diseases, amyotrophic lateral sclerosis and other neurodegenerative diseases, with human pluripotent stem cells providing a potentially unlimited source of NSC. In this study, we demonstrated for the first time that human multipotent NSC stable to long-term passaging can be derived from pluripotent human parthenogenetic stem cells, followed by differentiation into neurons and glial cells. Human parthenogenetic stem cells (hpSC) are derived from the inner cell mass of blastocysts obtained from unfertilized oocytes that have been activated using parthenogenesis. These cells demonstrate characteristics typical for human embryonic stem cells (hESC), including extensive self-renewal and *in vivo* as well as *in vitro* differentiation into cells of all three germ layers. Differentiated derivatives of HLA homozygous hpSC with common haplotypes may reduce the risk of immune rejection after transplantation; thus offering significant advantages for application in cell-based therapies due to their enhanced ability to be immune-matched over hESC lines that carry HLA genes in heterozygous form. Moreover, derivation of hpSC overcomes ethical hurdles associated with the derivation of hESC from fertilized human embryos. For NSC derivation we use an approach based on the adherent model with modifications. Rosettes of neuroepithelial cells were formed in the colonies of hpSC grown in the absence of feeder cells. The generated rosettes expressed specific neuroepithelial markers such as PAX6, SOX1, NES (Nestin), MS11 (Musashi-1), and did not express pluripotency marker OCT4. The rosettes were isolated, disaggregated into single cell suspension and then propagated as an adhesion culture. The human parthenogenetic NSC (hpNSC) were passaged every 4-5 days enzymatically with a 1:2 split rate for more than 15 passages. Reverse transcriptase real-time quantitative PCR (qRT-PCR) revealed the expression of specific neural markers NES (Nestin), SOX2 and MS11 (Musashi-1) in the hpNSC which was also confirmed by immunocytochemical staining of corresponding proteins. At the same time, the expression of OCT4 was not detected at RNA and protein levels. The cells keep uniform morphology up to at least 15 passages and do not show constantly increasing levels of ectomesenchymal markers SNAI1 and FOXD3 as detected by qRT-PCR. To demonstrate the ability to produce neurons and glia, we allowed spontaneous differentiation for three weeks. After this time most of the differentiated cells have acquired specific neuron morphology and were positive for anti-Tuj1 (Tubulin beta III) labeled antibodies. The expression of neuronal markers TUBB3 (Tubulin beta III) and MAP2 as well as glial markers FOXO4 and

GFAP was detected in these differentiated cells by qRT-PCR. The ethical and immunomatching advantages make hpSC a very promising source of multipotent NSC for cell-based transplantation therapy. On this basis, we derived for a first time hpNSC that can be maintained in culture and expanded for clinical usage.

Cardiovascular Gene & Cell Therapy

101. Initial Results from a First-in-Man Study Delivering Non-Viral Gene Therapy JVS-100 To Treat Ischemic Heart Failure

Marc S. Penn,¹ Joseph Pastore,² Rahul Aras,² Didier Rouy,³ Gary Schaefer,⁴ MaryJane Farr,⁵ Warren Sherman,⁵ Farrell Mendelsohn,⁶ Douglas Losordo.⁷

¹Cleveland Clinic Foundation, Cleveland, OH; ²Juventus Therapeutics, Cleveland, OH; ³BioCardia, San Carlos, CA; ⁴Rush University Medical Center, Chicago, IL; ⁵Columbia University, New York, NY; ⁶Cardiology PC, Birmingham, AL; ⁷Northwestern University, Chicago, IL.

Stromal cell-derived factor-1 (SDF-1) has been shown to have significant effects in wound healing in multiple organ systems in a variety of animal models, including heart failure (HF). SDF-1 has been shown to recruit bone marrow derived stem cells, cardiac stem cells and to reduce cardiac myocyte cell death. JVS-100 is a non-viral plasmid encoding human SDF-1 under control of the CMV promoter. We previously demonstrated that JVS-100 was safe at doses up to 100 mg and improved cardiac function and angiogenesis at doses up to 30 mg in a GLP study delivering JVS-100 via the BioCardia Helical Infusion Catheter (HIC) to pigs with ischemic HF. We propose to present 4 month results for all cohorts of a Phase 1 open-label study to test safety and bioactivity of JVS-100 in patients (pts) with class III HF due to prior myocardial infarction (MI). **Methods and Results:** 17 NYHA Class III pts with prior MI (mean time from MI > 5 years) and ejection fraction ≤ 40% were enrolled. 3 doses of JVS-100: 5 mg (n=4 pts), 15 mg (n=6 pts), and 30 mg (n=7 pts), were delivered to the peri-MI region via 15 endomyocardial injections with the BioCardia HIC. Pts are being followed at 1, 4, and 12 months post-injection. Safety is being evaluated by tracking adverse events with the primary safety endpoint being the number of major adverse cardiac events at 30 days. Bioactivity is assessed by measuring changes from baseline in: echocardiographic parameters including left ventricular volume and ejection fraction, cardiac perfusion via SPECT imaging at baseline and 4 months after treatment and clinical parameters including NYHA class, 6 minute walk distance and quality of life. All pts received 15 injections of JVS-100. To date, pts have been followed for a total of 64 months. Follow-up at 1 and 4 months in the 5 mg cohort and 1 month in the 15 mg cohort has been completed. There have been no adverse events likely related to the drug at 1 month in the 15 pts who have reached their 1 month follow-up visit. At 4 months post-injection, all 4 pts in the 5 mg group improved resting perfusion compared to baseline, demonstrating bioactivity of JVS-100. Using a composite endpoint of clinically significant changes in combining echocardiographic and clinical endpoints, 3 of 4 pts improved in the 5 mg cohort at 4 months and 4 of 6 pts improved at 1 month in the 15 mg cohort. 4 month safety and efficacy data will be available for all pts in April 2011. **Conclusions:** The initial first-in-man data suggests delivery of a non-viral SDF-1 gene therapy, JVS-100, via endomyocardial injection to post-MI heart failure patients is safe. JVS-100 demonstrates bioactivity at the 5 mg dose level by improving resting perfusion. Follow-up at all dose levels is ongoing and will provide further insight into JVS-100 safety and bioactivity at higher dose levels.

102. AAV8 Gene Therapy Leads to Significant Lowering of Plasma Cholesterol Levels in Humanized Mouse Models of Homozygous and Heterozygous Familial Hypercholesterolemia

Sadik H. Kassim,¹ Hui Li,² Dawn Marchadier,² Peter Bell,¹ Scott Kobner,¹ James M. Wilson,¹ Daniel J. Rader.²

¹Gene Therapy Program, Department of Pathology & Laboratory Medicine, University of Pennsylvania, Philadelphia; ²Center for Experimental Therapeutics, University of Pennsylvania, Philadelphia.

Familial hypercholesterolemia (FH) is a life-threatening genetic disease caused by mutations in the LDL receptor (LDLR) gene. Patients with loss-of-function mutations in both LDLR alleles (homozygous FH—hoFH) develop atherosclerosis before age 20 and, if not treated, rarely survive past age 30. HoFH patients are refractory to traditional pharmacologic therapy. Heterozygous FH (heFH) affects about 1 in 500 people and leads to severe atherosclerosis. Traditional pharmacologic therapy is effective in many heFH patients, yet there remains a significant heFH patient population that is relatively refractory and remains at very high risk for development and progression of atherosclerotic vascular disease. Numerous studies suggest the liver to be an ideal target for somatic gene transfer in the treatment of FH. In our previous studies, we have demonstrated that AAV8 mediated gene transfer of mouse LDLR can effectively correct hoFH and leads to marked regression of well-established atherosclerotic plaques in hoFH mice. As a bridge to clinical trials, we generated a mouse model that would allow more authentic simulation of *in vivo* interactions between the clinical transgene candidate, human LDLR (hLDLR), and its endogenous ligand, apolipoprotein B-100 (APOB). Mice expressing the human apolipoprotein B-100 transgene (APOB) were crossed onto FH mice (LDLR^{-/-}-APOBEC1^{-/-}). On a chow diet, these mice (LDLR^{-/-}-APOBEC1^{-/-}-APOB^{+/+}, LAhB) have higher cholesterol levels and a lipoprotein phenotype more closely resembling human hoFH than all previous mouse models of FH published to date. LAhB mice were injected with doses of AAV8.hLDLR ranging from 1x10¹⁰ to 1x10⁹ GC/animal. Significant cholesterol and non-HDL correction was realized at doses as low as 3x10⁹ GC/animal. Specifically, treatment with 3x10⁹ GC caused cholesterol levels to drop from 808 ± 94 to 353 ± 76 mg/dl by day 35 after treatment. Likewise, non-HDL levels dropped from 675 ± 87 to 255 ± 75 mg/dl. Importantly, no evidence of toxicity was found, as measured by elevations in serum transaminases and examination of liver pathology. Moreover, no transgene or capsid specific T cells were detectable, as measured by ELISPOT. Given the positive results of this gene therapeutic strategy in hoFH mice, we extended our studies to heterozygous FH. We generated LAhB mice that are heterozygous for LDLR expression (LDLR^{+/-}-APOBEC1^{-/-}-APOB^{+/+}, heLAhB). A single intravenous injection of AAV8.hLDLR led to significant reduction in total cholesterol from 325 ± 95 to 200 ± 80 mg/dl by day 30 after treatment at doses as low as 1x10¹⁰ GC/animal. Collectively, these data demonstrate the safety and potential benefits of the liver-specific AAV8 vector in the treatment of hoFH and, for the first time, heFH using direct intravenous liver gene therapy in humanized mice that faithfully model FH disease pathology.

103. Phase I/IIa, Open-Labeled, Dose Escalation Clinical Study Using DVC1-0101 (F-Gene-Deleted Non-Transmissible Recombinant Sendai Virus Vector Expressing Human FGF-2) To Treat Peripheral Arterial Disease

Yoshikazu Yonemitsu,¹ Takuya Matsumoto,² Hiroyuki Itoh,² Jin Okazaki,² Makiko Uchiyama,³ Kumi Yoshida,¹ Toshihiro Onohara,² Hiroyuki Inoguchi,² Ryoichi Kyuragi,² Atsushi Guntani,² Mototsugu Shimokawa,³ Mitsuho Onimaru,⁴ Hiroshi Ban,⁵ Makoto Inoue,⁵ Tsugumine Zhu,⁵ Mamoru Hasegawa,⁵ Yoichi Nakanishi,³ Yoshihiko Maehara.²

¹R&D Laboratory for Innovative Biotherapeutics, Kyushu University Graduate School of Pharmaceutical Sciences, Fukuoka, Japan; ²Department of Surgery and Science, Kyushu University Graduate School of Medical Sciences, Fukuoka, Japan; ³Clinical and Translational Research Center, Kyushu University Hospital, Fukuoka, Japan; ⁴Department of Pathology, Kyushu University Graduate School of Medical Sciences, Fukuoka, Japan; ⁵DNAVEC Corporation, Tsukuba, Ibaraki, Japan.

Objective: ‘Therapeutic angiogenesis’ to treat limb ischemia has been investigated intensively in the last decade; however, information regarding the clinical proof of concept has been relatively sparse. We here report the result of phase I/IIa open-label 4-dose escalation (5x10⁷, 2x10⁸, 1x10⁹, and 5x10⁹ ciu/60kg for each 3 patients) clinical study assessing the safety, tolerability, and possible efficacy of single intramuscular administration of DVC1-0101, a new clinical grade gene transfer vector based on non-transmissible recombinant Sendai virus expressing human FGF-2 gene (rSeV/df-hFGF2) to treat patients with critical limb ischemia (CLI). **Methods:** The study design, protocols and informed consent forms were approved by the local ethics committees, the Health Sciences Council of Japanese Ministry of Health, Labor, and Welfare (MHLW), and Biosafety Committees according to national regulations. A data safety and monitoring board provided an independent review of safety data and of accordance of defined inclusion criteria of each patient. This study was conducted, recorded, and reported in accordance with the principles of good clinical practice regulations. **Results:** Gene transfer was done in 12 limbs with rest pain and/or ischemic ulcer (3 patients) of 12 patients. Although one patient (stage 1) was lost due to acute-on-chronic progression of preexisting interstitial pneumonitis 2-years after treatment, no serious adverse event caused by gene transfer, including any cardiovascular event, was detected in all cohorts over 1-year follow-up. Three patients exhibited significant RNA genome of DVC1-0101 transiently in blood stream, but no infectious particle assessed by hemagglutination activity was detected during observation course in all patients. No significant elevation of proinflammatory cytokines, including IL-6, as well as of plasma FGF-2 was seen. Improvements of Rutherford category, of absolute claudication distance and claudication onset distance, and of rest pain were observed constantly and significantly ($P < 0.05$ to 0.01). **Conclusion:** To our best knowledge, this is the first clinical trial in use of gene transfer vector based on rSeV all over the world. Single intramuscular administration of DVC1-0101 to CLI patients was safe and well tolerated, and demonstrated significant improvement of limb function. Larger studies, therefore, to determine whether DVC1-0101 can improve limb function are warranted.

104. Intrathoracic Administration of AAV9 Reverses Neural and Cardiorespiratory Dysfunction in Pompe Disease

Darin J. Falk,¹ Cathryn S. Mah,¹ Meghan S. Soustek,¹ Kun-Ze Lee,² Denise A. Cloutier,¹ Mai K. Elmallah,¹ Kirsten E. Erger,¹ Thomas J. Conlon,¹ David D. Fuller,² Barry J. Byrne.¹
¹*Pediatrics & Powell Gene Therapy Center, University of Florida, Gainesville, FL;* ²*Physical Therapy, University of Florida, Gainesville, FL.*

Pompe disease is an autosomal recessive disorder resulting from deficiency in acid alpha glucosidase (GAA). Deficiency of lysosomal GAA results in cardiac, skeletal muscle and central nervous system (CNS) pathology. Enzyme replacement therapy (ERT) is the current standard of care and has been shown to partially correct cardiac and skeletal muscle dysfunction. However, recombinant enzyme is unable to penetrate the blood brain barrier to target CNS pathology. Here we tested the hypothesis that intrathoracic administration of AAV9-GAA driven by either a viral promoter (CMV) or a unique tissue specific promoter (Desmin; DES), will express the GAA gene in both striated muscle and the CNS in adult *Gaa*^{-/-} mice, thereby enhancing both cardiac and respiratory function. Mice were studied 6 months after intrathoracic delivery of GAA via AAV9-DES or AAV9-CMV. Cardiac MRI revealed significant improvement in ejection fraction (AAV9-DES: 13.2±5.5% and AAV9-CMV: 11.0±5.2%, p<0.05) and stroke volume (AAV9-DES: 25.2±10.2% and AAV9-CMV: 35.0±8.6%, p<0.05) when compared to *Gaa*^{-/-} animals. Inspiratory phrenic and diaphragm activity was examined in anesthetized spontaneously breathing mice during normocapnic baseline and hypercapnic respiratory challenge. Mice treated with AAV9 had greater phrenic inspiratory burst amplitude during the baseline condition (AAV9-DES: 83±15, AAV9-CMV: 79±7.0) as compared to untreated *Gaa*^{-/-} mice (65±11; % hypercapnia, p<0.05). Phrenic output was correlated with diaphragm activity in AAV9-DES (r² = 0.67) and AAV9-CMV groups (r² = 0.60) but not in untreated *Gaa*^{-/-} mice (r² = 0.00). This is the first study to show improvement in cardiac, skeletal muscle and CNS function after a single administration of AAV in Pompe disease. These results further implicate a role for the CNS in Pompe disease pathology and the critical need to target the neurologic aspects in developing improved therapeutic strategies.

Lung and Respiratory Disease Gene & Cell Therapy

105. Human Multipotent Stromal Cells Attenuate LPS-Induced Acute Lung Injury in Mice Via Secretion of TNF-alpha-Induced Protein 6

Svitlana Danchuk,¹ Joni H. Ylostalo,² Fokhrul M. Hossain,³ Randy Sorge,¹ Austin Ramsey,¹ Joseph A. Laskey,¹ Bruce A. Bunnell,¹ David A. Welsh,³ Darwin J. Prockop,² Deborah E. Sullivan.¹
¹*Center for Stem Cell Research and Regenerative Medicine, Tulane University School of Medicine, New Orleans, LA;* ²*Institute for Regenerative Medicine at Scott & White, Texas A&M Health Science Center, Temple, TX;* ³*Department of Medicine, Section of Pulmonary/Critical Care Medicine, Louisiana State University Health Science Center, New Orleans, LA.*

Background: Multipotent stromal cells (MSCs) are currently in clinical trials for a number of inflammatory diseases. Recent studies have demonstrated the ability of MSCs to attenuate inflammation in rodent models of acute lung injury (ALI) suggesting that MSCs may also be beneficial in treating ALI. **Methods:** To better understand how human MSCs (hMSCs) may act in ALI, the lungs of immunocompetent mice were exposed to lipopolysaccharide (LPS) and 4 hr later bone marrow derived hMSCs were delivered by oropharyngeal aspiration (OA). The effect of hMSCs on lung injury was assessed by measuring the lung wet/dry weight ratio and total

protein in bronchoalveolar lavage (BAL) fluid 24 or 48 hr after LPS. BAL fluid was also analyzed for presence of inflammatory cells and cytokine expression by multiplex immunoassay. Microarray analysis of total RNA isolated from treated and untreated lungs was performed to begin to elucidate the mechanism(s) involved in hMSC modulation of lung inflammation. **Results:** Administration of hMSCs significantly reduced the expression of pro-inflammatory cytokines, neutrophil counts and total protein in bronchoalveolar lavage. There was a concomitant reduction in pulmonary edema. The anti-inflammatory effects of hMSCs were not dependent on localization to the lung, as intraperitoneal administration of hMSCs also attenuated LPS-induced inflammation in the lung. Microarray analysis revealed significant induction of TNF- α -induced protein 6 (TSG-6) expression by hMSCs 12 hr after OA delivery to LPS-exposed lungs. Knockdown of TSG-6 expression in hMSCs by RNA interference abrogated most of their anti-inflammatory effects. In addition, intra-pulmonary delivery of recombinant human TSG-6 reduced LPS-induced inflammation in the lung. **Conclusions:** These results show that hMSCs recapitulate the observed beneficial effects of rodent MSCs in animal models of ALI and suggest that the anti-inflammatory properties of hMSCs in the lung are explained, at least in part, by activation of hMSCs to secrete TSG-6.

106. In Vivo Site-Specific Delivery of Nanoparticles to Airway Epithelium Monitored by Scintigraphy

Maria Manunta,¹ Robin McAnulty,² Aristides Tagalakakis,¹ Amy McDowell,³ John Fleming,⁴ Livia Bolt,⁴ Lorenzo Biassoni,³ Christopher O'Callaghan,⁵ Stephen Hart.¹
¹*Molecular Immunology Unit, UCL Institute of Child Health, London, United Kingdom;* ²*Centre for Respiratory Research, UCL, London, United Kingdom;* ³*Radiology, Great Ormond Street Hospital for Children, London, United Kingdom;* ⁴*Nuclear Medicine, Southampton General Hospital, Southampton, United Kingdom;* ⁵*Infection, Immunity and Inflammation, University of Leicester, Leicester, United Kingdom.*

Cystic fibrosis (CF) is a disorder caused by defects in the gene encoding for the cystic fibrosis transmembrane conductance regulator, which affects the exocrine epithelium. In the respiratory tree, the ionic imbalance determines reduced volume of the airway surface liquid, mucus dehydration and reduced mucus clearance, leading to a progressive decline in lung function. We have previously developed a gene delivery strategy to airway epithelium, using receptor-targeted nanoparticles (RTN), consisting of a receptor-targeting peptide, cationic liposomes and plasmid DNA. For therapeutic interventions, aerosol delivery provides a practical means of administration for targeting the respiratory tract. The present study aimed to nebulize the nanoparticles *in vivo* and to develop a strategy to monitor the deposition of nebulized radio-vectors in the airways. Mice (C57BL6 or CD1) were exposed to aerosolized RTNs carrying either pCI-*luc* or pCpG-free *lacZ* plasmid. The enzymatic activity and/or the amount of the protein were measured. Expression of the luciferase gene was detected in 5/7 lungs of C57BL6 mice whereas β -galactosidase was expressed in the tracheas and in the lungs of all 6 CD1 mice, thus indicating that the nanoparticles were able to deliver the gene to the airway epithelium of trachea and lungs. Having shown nebulized delivery and expression in mice, the nanoparticles were mixed with ^{99m}technetium-labeled agents, to monitor the distribution in a large animal model. RTNs with or without radioactive labels were nebulized to different cohorts of Large White weaner pigs. Following the aerosolization, the distribution pattern of radio-vectors was monitored by scintigraphy. Samples collected from euthanized animals were analyzed by immunohistochemistry and the amount of plasmid delivered was also quantified. The presence of inflammation markers was assessed in the bronchoalveolar lavage (BAL) from the accessory

lobe. Scintigraphy data suggest that the biodistribution of the radio-vectors occurs mainly in the trachea and in the middle lobes which also include the main bronchi and their ramifications. The biodistribution data showed the highest plasmid copy numbers in the bronchial area, although the lung tissue proximal to the main bronchi junction also showed some positivity. Immunohistochemical analysis demonstrated expressed protein localized to the surface epithelium of trachea and bronchi. No inflammation was found by histology or inflammatory cells in the BAL, and no IL-6 or TNF- α was detected in the BAL fluid. Our data strongly indicate that these nanoparticles can be safely used to deliver genes to the airway epithelium and that their distribution can be monitored in a clinical setting by nuclear medicine isotopes. Such approaches may be useful for CF gene therapy.

107. Gene Transfer of the Epithelial Sodium Channel (ENaC) α 1 Subunit Using Electroporation Protects from Lipopolysaccharide (LPS)-Induced Acute Lung Injury

Xin Lin,¹ David A. Dean.¹

¹Department of Pediatrics, School of Medicine and Dentistry, University of Rochester, Rochester, NY.

Acute lung injury (ALI) and acute respiratory distress syndrome (ARDS) are characterized by acute respiratory failure and associated with diverse disorders, including pulmonary edema. Gene therapy is a potentially powerful approach to treat ALI and ARDS. Recent research from our laboratory and others has demonstrated that electroporation can be used to efficiently deliver naked DNA to various tissues, including the living lung, with high-level gene expression and without damage. To determine whether electroporation-mediated transfer of genes is an effective strategy to protect or treat acute lung injury, a plasmid encoding the α 1-epithelial sodium channel (α 1-ENaC) with or without plasmids encoding β 1-Na,K-ATPase or IL-10 was delivered to mouse lungs by aspiration and then eight, 10 msec square wave pulses at a field strength of 200 V/cm were immediately applied using cutaneous electrophysiology electrodes placed on the mouse chest. Lung injury was induced by administration of LPS (5 mg/kg) and detected by histology, bronchoalveolar lavage protein levels and cellularity, cytokines measurement, and wet-to-dry ratios. Gene expression was determined by western blot, real-time PCR, and immunohistochemistry staining and is in, or very close to alveoli. Delivery of a control plasmid had no effect on lung injury. By contrast, delivery of a plasmid expressing α 1-ENaC with or without β 1-Na,K-ATPase or IL-10 protected from subsequent LPS-mediated lung injury by these measures. Combinations of the plasmids further improved outcome in these animals. These results provide evidence that electroporation can be used effectively in healthy and injured lungs to effect gene expression, and demonstrate the potential of using membrane channels to treat acute lung injury.

108. Self-Reactive T Cells to CFTR in Cystic Fibrosis (CF) and Non-CF Humans: Implications for Gene Therapy

Maria P. Limberis,¹ Roberto Calcedo,¹ Uta Griesenbach,^{2,3} Eric W. Alton,^{2,3} James M. Wilson.¹

¹Gene Therapy Program, Department of Pathology & Laboratory Medicine, University of Pennsylvania, Philadelphia; ²Department of Gene Therapy, Imperial College, London, United Kingdom;

³UK Cystic Fibrosis Gene Therapy Consortium, London, United Kingdom.

A potential challenge in gene replacement therapy for recessive diseases is the generation of antigen-specific immune responses to transgene products. One strategy to mitigate this risk is to restrict participation in the trial to subjects with missense mutations where the number of likely antigenic epitopes is low. This rationale is based

on the principle of central tolerance that prevents the formation of T cells reactive to self antigens by virtue of deletion in the thymus due to high affinity interactions of T cell precursors and MHC/peptide complexes from thymic epithelial cells. In preparation for a gene therapy trial for cystic fibrosis (CF) conducted by the UK CF Gene Therapy Consortium, we established baseline levels of CFTR-specific T cells in 162 patients using a validated IFN- γ ELISPOT assay with a peptide library (15aa with 10aa overlaps divided in 6 pools; A-F) that spans the wild type CFTR. Surprisingly, we found positive results in peripheral blood mononuclear cells (PBMCs) from ~15% of CF subjects before vector treatment. The positive samples demonstrated CFTR T cell frequencies that ranged from 93 spot forming units (SFU)/10⁶ PBMCs (low positive group) to 541 SFU/10⁶ PBMCs (highly positive group). Positive responses were generally found to a single peptide pool for each subject; however the pools that stimulated IFN γ were spread across the CFTR protein when the whole subject group was analyzed (4/Pool A; 10/Pool C; 4/Pool D; 1/Pool E; 2/Pool F). There was no correlation between peptides that stimulated T cell responses and underlying CFTR mutations; most CF patients had at least one Δ F508 mutation and 80% of these showed T cell responses to peptides distinct from those spanning Δ F508. Analysis of PMBCs from 2 subjects harvested two years apart revealed the same ELISPOT profile indicating these self reactive T cells are indeed stable and specific to individual CF subjects. These samples were subjected to intracellular cytokine staining to characterize the nature of the T cell responses. We found both CD4 and CD8 T cells to CFTR although frequencies were low. Similar IFN- γ ELISPOT studies in PBMCs from 24 normal human subjects revealed CFTR-specific T cells in 3 subjects although the frequencies tended to be lower than what was seen in CF subjects. T cells to dystrophin protein were recently described in PBMCs of patients with Duchenne's Muscular Dystrophy which were ascribed to exon skipping in revertant fibers exposing self-reactive epitopes. Our studies demonstrate the presence of relatively high levels of self-reactive T cells to epitopes of CFTR without having to invoke somatic reversion. These T cells are not anergic since they express IFN- γ in response to CFTR peptides however, we do not know if they possess effector activities that could contribute to the underlying disease in CF or that can modulate immunotoxicity in trials of molecular therapies like gene replacement and nonsense suppression.

RNA Virus Vectors I

109. DNA-Recognizing Integrase Fusion Protein Alters Integration Pattern of HIV-1 Based Vector

Vesa Turkki,^{1,2} Diana Schenkwein,^{1,2} Mervi Ahlroth,³ Seppo Ylä-Herttua.¹

¹Molecular Medicine and Biotechnology, A. I. Virtanen Institute for Molecular Sciences, University of Eastern Finland, Kuopio, Finland; ²Ark Therapeutics Group Plc, Kuopio, Finland; ³Finnish Rheumatism Association, Helsinki, Finland.

Upon infection lentiviruses, such as HIV-1, integrate their genomes into host cell chromatin. This mechanism is being utilized in viral vectors to carry transgenes into target cells. However lentiviruses, and lentiviral vectors (LVVs) derived from them, integrate into genome in a non-specific manner favoring active gene-rich loci in the target chromatin. Integration itself raises the possibility of genotoxic adverse effects when vectors are used for therapeutic purposes. To overcome this risk, LVVs can be modified with the aim of directing integration into predetermined areas. We first proved the feasibility of a direct cis-packaging method, which can be used to incorporate various molecules into LVVs or virus-like particles in LVV production. We then investigated the effects of new DNA-modifying integrase (IN) fusion proteins, and their different mutants, on vector packaging, infectivity and integration site selection. Here

we present a bioinformatic analysis of an altered integration pattern achieved with IN-endonuclease fusion protein. The fusion protein was constructed by fusing an intron-encoded endonuclease I-PpoI C-terminal to HIV-1 IN. According to our data, the fusion binds and cuts at its cellular target sequences. For integration site studies we tested a non-cutting version, harboring a point mutation N119A, which abolishes the DNA-cutting properties while retaining the DNA-binding activity. Third generation self-inactivating LVVs, containing fusion proteins either with wild-type IN or its catalysis deprived mutant D64V, were then produced in 293T cells by standard cotransfection of four plasmids, resulting in $\sim 10^9$ and $\sim 10^8$ TU/ml titers, respectively, with GFP-transgenes. With these and control vectors, HeLa, HEK 293 and MRC-5 cells were transduced, and genomic DNA-areas flanking the integration sites were sequenced by both traditional Sanger sequencing and high-throughput methods. Comparing with wtIN vectors and published integration site data, our IN-fusion protein containing LVVs were found to have a reduced tendency to integrate into gene-dense chromosomes and disparities with regard to genotoxicity-related as well as certain other genetic elements, suggesting safer target site profile in terms of integration derived genotoxicity.

110. Development and Characterization of Targeted Lentiviral Vectors Pseudotyped with the *Tupaia paramyxovirus* Glycoproteins

Theresa Enkirch,¹ Sabrina Kneissl,² Birgit Hoyler,¹ Wolfgang Stremmel,¹ Christian J. Buchholz,² Christoph Springfeld.¹

¹Department of Internal Medicine IV, University of Heidelberg, Heidelberg, Germany; ²Division of Medical Biotechnology, Paul Ehrlich-Institute, Langen, Germany.

Background. Lentiviral vectors are vectors of choice for many gene therapy applications. Recently, efficiently targeted lentiviral vectors pseudotyped with the glycoproteins of the paramyxovirus *measles virus* (MV) have been reported. However, MV antibodies in the general population might limit the clinical use of these vectors. As an alternative, we propose to generate lentiviral vectors pseudotyped with the glycoproteins of *Tupaia paramyxovirus* (TPMV), an animal paramyxovirus with no known close relatives in humans. These glycoproteins can be targeted by single-chain antibodies similar to the MV glycoproteins, but have so far not been incorporated in lentiviral vectors. The *Tupaia paramyxovirus* does not infect human cells, so that there are probably no pre-existing antibodies against TPMV in humans. **Methods.** For optimal incorporation into lentiviral vectors, the TPMV glycoproteins were modified by truncation of their cytoplasmic tails and targeted by displaying a single-chain antibody against CD20 on the H protein. These cytoplasmic tail variants were characterized by Western Blot analysis and tested for their ability to induce syncytia in CD20-positive cells. Lentiviral vectors were generated by transfection of 293T cells with a transfer vector, a packaging plasmid and expression plasmids encoding the TPMV glycoproteins. Transduction of target cells by these vectors was analyzed by FACS. **Results.** The modified glycoproteins were expressed to similar levels as the unmodified proteins and were able to mediate specific fusion of CD20-positive cells. Cytoplasmic tail variants that were most efficiently incorporated into lentiviral vectors were identified and with these glycoproteins, titers similar to those obtained with MV-pseudotyped vectors were reached (10^6 t.u./ml). The resulting vectors selectively transduced CD-20-positive cells and are able to mediate specific gene transfer to primary human B-cells. **Conclusions.** We conclude that targeted lentiviral vectors pseudotyped with TPMV glycoproteins can be generated to high titers and targeted to CD20-positive cells. We are currently investigating if these vectors are neutralized by human antibodies and will test their ability to mediate gene transfer *in vivo*.

111. Reliability Metrics for LM/LAM/nrLAM-PCR Coupled with High Throughput Sequencing

Troy B. Hawkins,¹ Aparna Jasti,¹ Aaron Ernstberger,¹ Keithanne Mockaitis,² Kenneth Cornetta.¹

¹Indiana University School of Medicine, Indianapolis, IN; ²Indiana University, Bloomington, IN.

The first step in understanding the potential impact of insertional mutagenesis in the context of retroviral gene therapy is identifying a comprehensive array of integration sites (ISs) from transduced cells. Advances in sequencing technology have spurred the development of techniques to assess vector integration in high throughput. Vector-genome junction fragments produced by ligase-mediated (LM)PCR and derivative protocols (linear-amplification-mediated (LAM)PCR and non-restrictive (nr)LAM-PCR) are now routinely sequenced in parallel using DNA bar codes and 454 pyrosequencing. Although this methodology is widely used, there is a lack of a comprehensive benchmark to validate the reliability of the resulting data. We set out to define a series of metrics for assessing large integration datasets produced by coupling next generation sequencing to traditional capture and amplification protocols, designed to answer fundamental questions of quality and utility of these high throughput data. **Specificity:** Utilizing filters on a large sequence dataset can identify high quality sequences that represent genomic integrations, but these represent only a fraction of the data. Specificity metrics take into account the remaining sequence data: theoretical yield (TY) is a measure of expected true positives in the data; vector specificity (SV), genomic specificity (SG), and integration specificity (SI) are measures of sequence product mapping to vector LTR, any genomic sequence, and definable ISs in the host genome, respectively. Stepped specificity metrics help to identify the impact of variability in sample preparation and IS distribution. **Sensitivity:** Increasing sequencing capabilities several orders of magnitude above traditional Sanger methods also increases the probability that fragments captured in the pre-sequencing phase of integration analysis will be sequenced. This assumption allows us to assess the lower limit of sensitivity of the traditional protocols for capturing and identifying ISs and utilize parallel or multiplexed internal controls in integration analysis methodologies. Sensitivity metrics are imperative to understanding identification of integration events relative to the controls. **Results:** To evaluate these metrics, we developed lentiviral-transduced K562 clones with verified ISs. Clones were mixed pairwise in serial dilutions to simulate polyclonal samples. We sequenced LM, LAM, and nrLAM-PCR products by parallel 454 sequencing in three separate runs and assessed specificity and sensitivity using the metrics described here. We found that SV was consistently high ($99.82 \pm 0.17\%$, $n=216$), but SG and SI were highly variable between individual clones ($21.42 \pm 16.80\%$ and $14.91 \pm 14.94\%$, respectively, $n=216$). In addition, we were able to directly compare performance and lower-limit sensitivity of the three protocols and identify steps in each that may introduce errors that lead to decreased reliability. We believe that these standardized metrics will be key to fully understanding large sequence datasets that are now the norm, and represent a significant step towards validated controls in IS analysis protocols applied to clinical samples.

112. Assessing Potency in Lentiviral Vectors Pseudotyped with VSV-G, RD114 or FV Envelope Glycoproteins

Anna C. Pulliam-Leath,¹ Aparna Jasti,¹ Helmut Hanenberg,² Dirk Lindemann,³ Kenneth Cornetta.¹

¹Medical & Molecular Genetics, Indiana University School of Medicine, Indianapolis, IN; ²Herman B Wells Center for Pediatric Research, Indiana University School of Medicine, Indianapolis, IN; ³Medizinische Fakultät Carl Gustav Carus, Technische Universität Dresden, Institut für Virologie, Dresden, Germany.

Viral vectors are frequently pseudotyped in order to alter viral tropism. The change in potency of the resulting pseudotypes requires that infectious titer is estimated very carefully. Many promising pseudotypes are reported in the literature; however, direct comparison between pseudotypes has been difficult due to the lack of standardized studies. This work focuses on standardizing and comparing production methods, titer methodology and virus yield for three promising envelope glycoproteins: VSV-G, feline endogenous retrovirus glycoprotein (RD114) and a modified foamy virus glycoprotein, pcoPE01 (FV), envelopes. For this study, the CSCGW SIN-lentiviral vector containing CMV-GFP (6 μ g/T25 flask) was packaged using the pMDLg containing GAG/POL (2.2 μ g/T25 flask) and pRSV/REV (1.1 μ g/T25 flask) plasmids. Physical titer was assessed using a commercial ELISA for p24. Infectious titer was assessed by dilutional titer on HT1080 cells with the number of vector expressing cells determined by flow cytometric analysis for GFP. The optimal envelope plasmid concentration for VSV-G was previously determined to be (1.5 μ g/T25 flask). Using the concentration of CSCGW and packaging plasmids determined to be optimal for VSV-G, infectious titer of the other envelope pseudotypes was optimized by varying the envelope plasmid concentration. For RD114 a range of 0.1-5.0 μ g/T25 flask was evaluated and the optimal titer was produced at 1.8-2.8 μ g/T25 flask. For FV, a range of 0.1-5.0 μ g/T25 flask was evaluated and the optimal titer was produced at 0.1-1.0 μ g/T25 flask. In this initial evaluation, titers were performed with polybrene (8 μ g/mL) for VSV-G and RD114 and without for the foamy envelope, since investigators using the foamy envelope have titrated without this polycation previously. However, as the use of polycations varies among laboratories, this variable was evaluated in titer assays. After a 24 hour incubation with vector (either with or without polybrene), the titer for VSV-G was determined to be 4.6 $\times 10^7$ with versus 2.4 $\times 10^6$ without polybrene and for RD114 5.2 $\times 10^6$ with versus 2.2 $\times 10^6$ without polybrene. Interestingly, for FV polybrene inhibited vector transduction with the estimated titer without polybrene being significantly higher than with this agent (4.1 $\times 10^7$ versus 7.9 $\times 10^6$ respectively). As laboratories also vary the time of vector exposure, 4 versus 24 hour transduction times were compared. For transduction on HT1080 cells we found significant decreases in calculated titer for 4 hour versus 24 hour vector exposure for all envelopes. Our results consistently show that when producing maximal titer levels using the optimized conditions only the FV envelope is capable of providing a yield comparable to VSV-G, with RD114 yielding only 22% of VSV-G post-filtration and pre-concentration. This finding has important implications when looking to scale up vector production for clinical applications.

113. Tracking Retroviral-Integrated Clones with Modified Non-Restriction Enzyme LAM-PCR Technology

Chuanfeng Wu,¹ Alexander Jares,¹ Thomas Winkler,¹ Jianjun Xie,¹ Andre Larochelle,¹ Cynthia E. Dunbar.¹

¹Hematology Branch, National Heart, Lung, and Blood Institute, NIH, Bethesda, MD.

Retroviral vectors are an efficient and widely employed means of introducing an expression cassette into target cells. These vectors have been shown to integrate semi-randomly into the genome, often with associated genotoxicity. Consequently, the ability to characterize flanking genomic DNA of individual integration sites is critical for assessing the risk of insertional mutagenesis and for tracking individual clones to answer biologic questions. Linear amplification-mediated PCR (LAM-PCR) is the best established technique for isolating proviral/host genomic DNA junctions. However, LAM-PCR is subject to selection bias inherent to the assay's use of restriction enzymes, and is further limited by an inability to discriminate between flanking genomic DNA of interest and uninformative internal vector DNA. We have designed and tested for efficiency and reliability a modified

LAM-PCR (RE-free LAM-PCR) approach, based on a similar published technique (FLEA-PCR), which does not use restriction enzymes and that effectively selects against internal sequences. Linear PCR priming does not discriminate between the transgene's 5' and 3' long terminal repeats (LTRs), leading to external and internal linear PCR products. In RE-free LAM-PCR, the use of restriction enzymes is circumvented by employing a mixture of oligonucleotides with a known 5' sequence and then six random bases at the 3' end. These random hexamer-containing primers can anneal to the 3' end of the linear PCR product, allowing for subsequent complementary strand synthesis up to and including the LTR at the 5' end of the linear PCR product. Blocking oligonucleotides anneal specifically to internal vector linear PCR products, and prevent complementary strand synthesis from progressing fully to the LTR. Therefore, in the subsequent exponential PCR, vector sequences lack the LTR and do not undergo amplification. Ten different HIV-GFP transduced K562 clones were isolated by FACS. Southern Blot analysis revealed that each clone contained a single integration site (single-copy); the site was confirmed by sequencing. All 10 single-copy clones were mixed in equal cell ratios. Using 100ng/reaction of starting DNA from the cell mixture, we found that one reaction of RE-free LAM-PCR retrieved 9 vector integration sites out of 10, corresponding to 90% efficiency. No internal and only 15% uninformative sequences were found using RE-free LAM-PCR, whereas internal and uninformative sequences accounted for respectively 14% and 23% using LAM-PCR. The absence of internal vector sequences in RE-free LAM-PCR allows for subsequent high-throughput sequencing; detection of integration sites independently of restriction sites allows for more uniform detection with increased reaction replicates. Current efforts are focused on detecting integration sites from different types of vectors, including HIV, SIV, and γ -retrovirus, as well as determining parameters for RE-free LAM-PCR sensitivity in both low and high-marking Rhesus macaque samples, followed by 454 high-throughput sequencing. RE-free LAM-PCR constitutes a significant improvement towards more reliable and quantitative detection of retroviral integration sites.

114. GP64 Pseudotyped Feline Immunodeficiency Virus-Based Vector Transduces Murine Primary Nasal Epithelial Cells with Greater Efficacy Than Primary Tracheal Epithelial Cells

Mayumi Oakland,¹ Paul B. McCray,^{1,2} Patrick L. Sinn.²

¹Department of Microbiology, The University of Iowa, Iowa City, IA; ²Department of Pediatrics, The University of Iowa, Iowa City, IA.

Persistent viral vector mediated transgene expression in the airways requires delivery to cells with progenitor capacity and avoidance of immune responses to the vector or vector encoded proteins. In previous studies in mouse nasal epithelia we demonstrated that repeated daily or weekly applications of GP64 pseudotyped feline immunodeficiency virus (FIV)-based vector did not elicit inhibitory adaptive immune responses. Further, we observed that in vivo GP64-FIV mediated gene transfer was more efficient in the nasal airways than the large airways of the mouse lung. We hypothesized that in vivo gene transfer was limited, in part, by anatomical and immunological barriers in the mouse airways. Here we show that a GP64-FIV vector transduced primary cultures of well-differentiated mouse nasal epithelia with greater efficacy than primary cultures of mouse tracheal epithelia. Both types of well differentiated epithelia were morphologically similar and were confirmed to contain ciliated, non-ciliated, and basal cells. We further demonstrate that vector delivered to the in vivo mouse airways recruited macrophages and neutrophils; however the levels of recruitment were similar to the vehicle control. Depletion of macrophages modestly improved transduction efficiency; however, the lower airway transduction efficiency was not improved in mice deficient for T and B cells or

mice deficient in the type 1 interferon receptor. Our data suggest that the increased surface area of the lower airways and mucociliary clearance are both barriers to lentiviral gene transfer in the lung. In addition, while the viral vector can cause inflammation, cytokines and immune effector cells fail to negatively affect transduction efficiency of GP64-FIV in mice airways *in vivo*. Ongoing studies will address the transduction efficacy of GP64-FIV in porcine primary nasal and tracheal epithelial cells. The results from these studies will help guide future experiments in large animal models of cystic fibrosis.

115. Safety Evaluation of Gene Transfer Vectors for Gene Therapy of Wiskott-Aldrich Syndrome

Yasuhiro Ikawa,¹ Toru Uchiyama,¹ Fabio Candotti.¹

¹*Genetics and Molecular Biology Branch, National Human Genome Research Institute/NIH, Bethesda, MD.*

Therapeutic gene transfer has been used successfully to treat a variety of human genetic diseases. Although protocols have shown positive clinical outcomes, the success of clinical trials were tempered by adverse events, in which integration of the viral vectors increased transcription of cancer-related genes and thereby contributed to development of leukemia. In all documented cases of insertional mutagenesis, the viral vectors used contained full-length long terminal repeats (LTRs), which are able to exert strong promoter and enhancer activity driving not only the expression of the transgene carried by the vector, but also that of genes neighboring the insertional site. Assessing safety of integrating viral vectors for future clinical use is therefore of paramount importance. In preparation for gene therapy approaches for the Wiskott-Aldrich syndrome (WAS), we used an *in vitro* assay of murine bone marrow (BM) cell immortalization to compare the consequences of transduction by four different kinds of viral vectors, including a full-length LTRs Moloney leukemia virus (MLV), a self-inactivating MLV carrying a 3' LTR deleted of the viral enhancer region (SIN), a lentivirus (LV), and a foamy virus (FV) construct. All vectors carried EGFP under the control of a UCOE (ubiquitously acting chromatin opening element) or WAS endogenous promoter (WASp). In this assay, BM cells are harvested from C57BL/6 mice, exposed to retroviral supernatants and cultured long-term. Derived lines are considered immortalized based on their ability to continue to grow *in vitro* for more than 6 weeks in Iscove's modified Dulbecco's medium supplemented with horse serum, interleukin-3 and stem cell factor. To date, MLV transduction of 40 cultures gave rise to 5 immortalized lines (12.5% immortalization rate). As expected, immortalized cells were negative/low for IgER, cKit and Sca1 expression, and positive to different degrees for expression of the myeloid markers CD11b/Mac1 and Ly6g/Gr1. Transduction of 26 and 18 cultures with LV and FV vectors, respectively, resulted in no immortalized lines thus far. These preliminary results confirm that MLV vectors are prone to immortalization in this system, which will prove useful to compare safety features of the other virus vectors under study.

116. Retrovirus with the Bioorthogonally Functionalized Envelope for Efficient, Convenient, and Versatile Labeling, Purification, and Targeted Delivery

Shirley Wong,¹ Haley Phan,² Min Suk Shim,³ Young Jik Kwon.^{1,3,4,5}

¹*Medicinal Chemistry and Pharmacology Program, University of California, Irvine, Irvine, CA;* ²*Chemistry, University of California, Irvine, Irvine, CA;* ³*Chemical Engineering and Materials Science, University of California, Irvine, Irvine;* ⁴*Pharmaceutical Sciences, University of California, Irvine, Irvine, CA;* ⁵*Biomedical Engineering, University of California, Irvine, Irvine, CA.*

Retroviruses are key vectors in clinical gene therapy due to their relatively low immunogenicity and the ability to achieve sustained

transgene expression. However, low viral titer in supernatants collected from producer cell culture, cumbersome purification methods to meet standards for clinical applications, and difficult surface modifications to achieve imaging and targeted delivery are significant challenges for employing retroviral vectors for gene therapy. Therefore, facile introduction of desired functional molecules onto retroviral surfaces (envelope) to enable easy purification, labeling, and targeted transduction is highly demanded. Yet, chemical and genetic functionalization of the retroviral envelope induced low transduction, mainly due to impaired virus/cell interactions, and is also time-consuming, cost-ineffective, and labor-intensive. Therefore, in this study, we have developed a novel, efficient, convenient, and versatile method of functionalizing retroviral surface by applying bioorthogonal chemistry at both viral and cellular levels for direct and indirect modifications, respectively. The glycoproteins on the surface of retroviral envelope were oxidized with sodium periodate and further bioorthogonally labeled with aminoxy-functionalized molecules. Most excitingly, the bioorthogonally modified glycoproteins in the virus-producing cell's plasma membrane, under normal culture conditions, were successfully equipped in the envelope of the budding retroviral particles. It was confirmed that the retroviral envelope was able to be conjugated with a fluorescent dye for molecular imaging. Additionally, centrifugation-free, continuous, scale-independent preparations of retroviral purification are feasible using this cellular modification approach to produce semi-synthetic retroviral particles. For example, magnetic particles were conjugated onto retroviral surfaces after bioorthogonal activation of glycoproteins on the virus-producing cells, and further concentrated and purified using a magnetic column. Applying an external magnetic field to magnetic particle-conjugated viruses resulted in enhanced transduction to the areas directed by the magnet. The bioorthogonally modified retroviruses can be easily tethered with various ligands for targeted delivery. In conclusion, this facile method of molecularly tuning retroviral surface at both viral and cellular levels offers wide potential applicability and convenient preparation, which addresses important technical obstacles in utilizing retroviruses as key therapeutics for gene delivery.

117. Decitabine Effects on Lentiviral Transduction for Human CD34+ Cells

Naoya Uchida,¹ Matthew M. Hsieh,¹ John F. Tisdale.¹

¹*National Institutes of Health, Bethesda, MD.*

The drug decitabine inhibits DNA methyltransferase, a key modulator of euchromatin and heterochromatin, thus modulating cell proliferation and differentiation events. We hypothesized decitabine may block cell differentiation of transduced CD34+ cells under cytokine stimulation and may affect transgene expression by altering the viral integration pattern. In this study, we evaluated decitabine effects on human CD34+ cell transduction. Human CD34+ cells were cultured in cytokine-containing media supplemented with decitabine. After 24 or 48 hours of prestimulation with decitabine, the cells were transduced with GFP-expressing HIV1-based lentiviral vectors without decitabine for 24 hours. After 48 hour prestimulation, decitabine treatment led to equivalent %GFP and higher CD34+ rates ($p < 0.05$). However, when prestimulation was carried out for only 24 hours %GFP was reduced ($p < 0.01$). Moreover, decitabine exposure was associated with lower coefficient of variation (CV, $p < 0.01$). These data suggested decitabine could block cell differentiation and reduce variation of transgene expression. Moreover, the duration of decitabine exposure appears to be important for achieving efficient transduction. We next evaluated individual variation of transduction using CD34+ cells obtained from six healthy donors. Averaged data revealed similar trends of equivalent %GFP, higher CD34+ rates, and lower CV after 48 hour decitabine exposure. In addition, decitabine was associated with reduced standard deviations of GFP intensity

($p < 0.01$) among the CD34+ cells from six individuals. This data indicated that decitabine can reduce individual variation of transgene expression levels. If decitabine was capable of facilitating random integration events, we presumed it would induce less insertional mutagenesis. Therefore, we performed limiting dilution of human CD34+ cells which were transduced with lentiviral vectors after 48 hour decitabine exposure, and these cells were cultured in 96 well plates for 3-4 weeks to assay the expansion ability of transduced cells. We detected subclonal expansion of GFP+ cells that had originated from the CD34+ cells. Decitabine was able to reduce the expansion rates under two prestimulation conditions of standard cytokines (2.1% vs. 9.4%) and with IL3 (0.0% vs. 7.3%). To evaluate decitabine effects on long-term progenitor cells *in vivo*, we transduced human CD34+ cells after 48 hour prestimulation with and without decitabine. These cells were then injected into sublethally-conditioned immunodeficient mice. Decitabine exposure was associated with equivalent %GFP and a tendency towards higher human chimerism and lower CV of GFP expression at 20-28 weeks after transplantation. However, the differences were not statistically significant. In summary, decitabine can block cell differentiation and reduce CV in transduced human CD34+ cells *in vitro*, but it has little effect on stemness and CV in transduced long-term progenitor cells *in vivo*. Decitabine exposure for 48 hours leads to equivalent transduction efficiency, while 24 hour exposure reduces transduction efficiency.

118. A New Lentiviral Based RNAi Platform Used in Gene Validation in Tuberculosis Research and Effects of Modifications in the Transgene 3' UTR

Ulrike Jung,^{1,2} Kellen C. Fae,¹ Juan P. Patron,¹ John J. Rossi,² Stefan H. E. Kaufmann.¹

¹Immunology, Max Planck Institute of Infection Biology, Berlin, Germany; ²Molecular & Cell Biology, City of Hope Beckman Research Institute, Duarte, CA.

RNAi (RNA interference) has become a widely accepted tool for gene knockdowns and thus gene validation in all kinds of conditions and circumstances. In *M. tuberculosis* infection models several unique features and limitations due to the bacteria used (bacteria division time of 24-30 hours) and the relevant cell types in infection models (primary dendritic cells and macrophages, the monocytotic cell line THP-1 which can be differentiated into macrophages) play a role. Since a) the RNAi effect needs to be long term, b) the cells are highly susceptible to activation, c) incubation with nucleic acids and most methods of delivery are inefficient or highly toxic for those cells a lentiviral platform needed to be established. A lentiviral platform that employs a combination of siRNAs derived from intron expressed artificial microRNAs (amiRNAs) and exon derived transduction reporter/selection marker (GFP or optimized Puromycin resistance) has been constructed for gene validation in tuberculosis research. Despite use of a polyA signal in the construct the packaging titers were good (average 3×10^7 TU/ml with maximum 1×10^8 TU/ml). The efficacy of the system in human CD34+ derived dendritic cells infected with *M. tuberculosis* or the vaccine strain BCG has been demonstrated. Knockdown of miRNA derived shRNAs as well as endogenous miRNAs could be detected and reached levels of up to 80% on mRNA levels in several cell lines. We tested for potential RNAi competition if two amiRNA were expressed, compared construct expressed endogenous miRNA effects with pre-synthesized miRNAs, measured the processing efficacy and miRNA expression, and tested control constructs without any miRNA or non-targeting sequences. All results are promising. Additionally transgene cassette 3' UTR modification were tested for expression activity and impact on virus titer. In conclusion the developed platform seems well usable for expression of small non-coding RNAs without a competition between RNA processing and exon export and translation. As the expression

platform is – due to the combination of polII promoter for minimized toxicity, intron derived shRNAs, loop-optimized miR30 based pre-miRNA, exon based transduction marker, polyA signal for minimal downstream effects, 3rd generation SIN lentiviral vector - state of the art, it should outperform commercially available systems.

119. Reducing Immune Response to Lentiviral Vectors by the Display of Human Self' Marker, CD47 on Vector Envelope

Nisha Sosale,¹ Richard K. Tsai,¹ Irena Ivanovska,¹ Philip W. Zoltick,² Dennis E. Discher.¹

¹Biophysical Engineering Lab, University of Pennsylvania, Philadelphia, PA; ²Department of Surgery, The Children's Hospital of Philadelphia, Philadelphia, PA.

Viruses that bud from the plasma membrane of host cells are enveloped by host cell membrane lipids and - probably - proteins as well. Among these proteins is CD47, which is a ubiquitous 'Marker of Self' that can in principle decrease particle clearance (and destruction) by the monocytic phagocyte system. To examine whether viral presentation of CD47 reduces phagocytosis by macrophages, CD47 was displayed at high levels on HIV 1 derived lentiviral vectors. The human-derived 293T packaging cell line was transduced and a stable line created that expressed CD47-GFP, and then these cells were transfected to produce the lentiviral vectors. We use sucrose ultracentrifugation gradient to separate lentiviruses from cell debris. Preliminary data suggests viral display of CD47 by single particle GFP fluorescence. Transduction studies of macrophages - which express the counter receptor for CD47 - and other cell types are ongoing, but we expect decreased transduction only of macrophages. Additional motivation for the effort is based on the fact that immune responses to gene therapy vectors and their transgene products is a major problem in the field of gene therapy. Understanding whether 'Self' Marker CD47 on viral envelopes decreases immune uptake is thus of both basic and applied significance.

AAV Genome & Host Interactions

120. Hepatocellular Carcinoma Due to Targeted Promoter Insertion by AAV Vectors

Mei Xu,¹ Peirong Wang,¹ Yi Li,¹ David W. Russell.^{1,2}

¹Department of Hematology, University of Washington, Seattle, WA; ²Department of Biochemistry, University of Washington, Seattle, WA.

Recombinant adeno-associated virus (rAAV) vectors are promising gene therapy vectors, and have been used in several clinical trials, including liver-directed gene therapy. Questions have been raised about the safety of AAV vectors based on the development of hepatocellular carcinoma in AAV-treated mice. In four out of six liver tumor samples present in mice that received an intravenous AAV vector injection, specific chromosome-AAV vector junctions were localized within a six kilobase (kb) region of the *Rian* locus in mouse distal chromosome 12, which remains a unique example of AAV-induced genotoxicity. To further examine this genotoxicity, we initiated a follow-up study and delivered a CMV enhancer/ β -actin promoter to the same region of the *Rian* locus by AAV-mediated gene targeting *in vivo*. As predicted, liver tumors were detected in most AAV-treated mice by six months after neonatal intravenous vector injection (6 of 8 mice analyzed), and all the treated mice examined after ten months developed multifocal hepatocellular carcinoma (15 of 15 mice analyzed). In comparison, we did not detect any tumor formation in control mice. Tumors were found to be larger and develop earlier in male mice as compared to female mice. Mice with tumors eventually developed elevated liver enzymes in their blood, and died prematurely. Early stage tumorigenesis could be detected

by the presence of alpha-feto protein positive hepatocytes in injected mice, even before malignant transformation was apparent. Insertion of the AAV vector-encoded CMV enhancer/ β -actin promoter was detected at the *Rian* locus in 63 out of 64 tumor samples analyzed based on qPCR and Southern blot analysis. Adjacent downstream chromosomal transcripts were found to be up-regulated in these tumors, in particular *Rian* and *Mirg*, which encode multiple snoRNAs and microRNAs, respectively. A comprehensive microRNA array analysis further demonstrated that all 17 up-regulated microRNAs were located at the *Rian* and *Mirg* loci, and quantitative RT-PCR showed five out of six tested snoRNAs in the *Rian* gene were up-regulated. All these data suggest that these tumors were caused by targeted integration of the vector-encoded CMV enhancer/ β -actin promoter at the *Rian* locus with increased transcription of nearby genes. Transcriptional profiling is being used in an attempt to identify the targets of these microRNAs and possibly the snoRNAs that may contribute to malignant transformation. These studies confirm the prior study showing that promoter insertion in the mouse *Rian* locus can cause liver tumors, and they raise concerns for the use of AAV vectors in liver-directed gene therapy, albeit with unclear significance for other species. Our experiments also develop a new model for liver cancer based on *in vivo* gene targeting that will allow us to study the roles of novel microRNAs and snoRNAs not previously implicated in cancer.

121. Regulation of AAV Mediated Transgene Expression by a Host Cell Transcriptional Repressor PARP-1

Sangeetha Hareendran,¹ Nishanth Gabriel,^{1,2} Arun Srivastava,³ Alok Srivastava,^{1,2} Giridhara Rao Jayandharan.^{1,2}
¹Centre for Stem Cell Research, Christian Medical College, Vellore, India; ²Hematology, Christian Medical College, Vellore, India; ³Division of Cellular and Molecular Therapy, Pediatrics, University of Florida, Gainesville, India.

Inducible transcription factors in response to an active adeno-associated virus (AAV) infection may regulate cellular responses necessary for the survival of the host cell as well as regulate the infectious life cycle of AAV which are targeted to these cells for gene transfer. Identification of such processes will therefore help design better strategies to improve AAV-mediated gene transfer. The basis for the present study was our finding that the host cellular Poly (ADP-ribose) polymerase – (PARP)1 can bind to the 20-bp D-sequence present in the AAV inverted terminal repeats (ITRs), which was identified by electrophoretic mobility-shift assays followed by mass-spectrometry. PARP-1 is a ubiquitously expressed, abundant nuclear protein with significant DNA processing activities such as DNA damage recognition and repair, transcription and chromatin remodelling with documented roles in regulating the replication of other viruses such as Epstein Barr virus. In the present studies, we hypothesized that PARP-1, by virtue of its function and its binding to AAV-ITR, may transcriptionally repress AAV-mediated gene expression. To test this, we employed PJ-34, a small molecule inhibitor of PARP-1 or short hairpin RNA against PARP-1 in HeLa cells *in vitro*. The pharmacologic inhibition of PARP-1 led to ~10% increase in EGFP expression with either single-stranded (ss) AAV2 or self-complementary (sc) AAV2 vectors. However, a near complete inhibition of PARP-1 activity by RNA interference, significantly (>75%) increased the transgene expression from AAV vectors (Figs 1A, 1B). Western blot analysis of cell-free extracts transduced with either ssAAV or scAAV vectors compared to mock-treated cells at 48 hrs showed >60% depletion of nuclear PARP-1 and concomitant to EGFP expression from these vectors (Fig 1C). These data strongly suggest that PARP-1 may transcriptionally repress AAV mediated gene expression. We therefore hypothesize that the use of PARP-1 inhibitors will improve the efficacy of AAV-mediated gene transfer

in vivo as well, which is being currently evaluated.

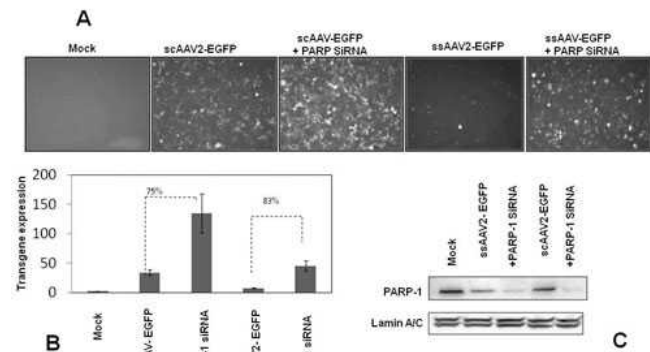

Fig. 1. (A) Transgene expression in HeLa cells 48 hrs post-infection with scAAV2-EGFP or ssAAV2-EGFP vectors alone, or in the presence of PARP-1 siRNA (B) Quantitative analyses of the data from (A) by fluorescence microscopy (C) Western blot analysis of HeLa cell nuclear extracts following mock-infection, or infection with AAV vectors, with and without PARP-1 siRNA. The samples were analyzed by using anti-PARP-1 antibody for detection of PARP signalling in response to AAV transduction. Anti-Lamin antibody was used as a loading control.

122. AAV-Mediated Gene Delivery and Gene Targeting in Human Embryonic Stem Cells

Prashanth Asuri,^{1,2,3} Melissa A. Bartel,^{1,2,3} Jae-Hyung Jang,⁴ David V. Schaffer.^{1,2,3}

¹Department of Chemical and Biomolecular Engineering, University of California, Berkeley, Berkeley, CA; ²Department of Bioengineering, University of California, Berkeley, Berkeley, CA; ³The Helen Wills Neuroscience Institute, University of California, Berkeley, Berkeley, CA; ⁴Department of Chemical and Biomolecular Engineering, Yonsei University, Seoul, Korea.

Precise genetic manipulation of human pluripotent stem cells via homologous recombination has broad implications and applications. While recent reports have demonstrated successful gene targeting in embryonic stem cells using adeno-associated virus (AAV) vectors at rates higher than that of plasmid-mediated homologous recombination (<10⁻⁴ vs. <10⁻⁶), overcoming the limited efficiency by which the naturally occurring AAV serotypes transduce human embryonic stem cells (hESCs) has the potential to significantly improve targeting frequencies. Directed evolution has proven to be a powerful approach to generate and select for AAV vectors with novel capabilities, and our results demonstrate that under appropriate selective pressures, AAV can evolve to significantly overcome the relatively low transduction and gene targeting efficiencies in human embryonic stem cells. Using a novel evolved AAV variant, EP 1.9, we observed higher gene delivery to hESCs and gene-targeting frequencies of up to 0.1%, approximately 10-fold higher than the targeting frequencies obtained using naturally occurring AAV serotypes. We also show the first use of zinc finger nucleases in conjunction with AAV-mediated gene targeting. In presence of a local DSB mediated by ZFNs, we observe gene-targeting frequencies of 1.2%, a >10-fold increase in the already efficient AAV-mediated gene targeting in hESCs. This successful gene targeting via homologous recombination was confirmed through restriction enzyme digestion and sequencing of the corrected GFP locus. Our findings show that the combination of zinc-finger nuclease technology and AAV-mediated gene delivery is a highly efficient method for gene targeting in hESCs. In addition, directed evolution of AAV can provide novel variants capable of providing high frequencies of homologous recombination, even in the absence of double-stranded breaks in the targeted DNA. This work has implications for biology and medicine, as highly efficient genetic control of hESCs and in the future hiPSCs will enable *in vitro* studies of disease mechanisms, developmental processes, and drug discovery and drug toxicity, and therapeutic gene correction for cell replacement therapies.

123. Absence of Integration Hotspots in Mice after Intramuscular Injection of AAV1-LPL^{S447X}

C. Kaepfel,¹ S. Beattie,² A. Nowrouzi,¹ U. Appelt,¹ R. Kirsten,¹ H. Glimm,¹ J. Snapper,² C. von Kalle,¹ H. Petry,² M. Schmidt.¹

¹German Cancer Research Center (DKFZ) and National Center for Tumor Diseases (NCT), Heidelberg, Germany; ²Amsterdam Molecular Therapeutics (AMT), Amsterdam, Netherlands.

Since recombinant AAV vectors are considered to integrate into host chromosomes at a very low frequency (<1%), we sought to analyse the persistence and integration frequency of AAV1-LPL^{S447X} in mice after intramuscular injection. In the first study, 1E13 gc/kg were injected intramuscularly into 4 or 13 week old mice and adductors from the hind limb were collected 4 weeks post-injection. In a second approach, 7-8 week old mice received 6E13 gc/kg intramuscularly and hind limb muscles and livers were collected 4 or 12 weeks post-injection. LAM-PCR was performed on the 3-prime end of the vector using the two different restriction endonucleases MseI and Tsp509I. >16000 (study 1) and >25000 (study 2) AAV derived LAM-amplicons were 454 pyrosequenced, revealing 401 and 856 unique integration sites (IS), respectively. The chromosomal distribution and the distribution in respect to gene coding regions showed that the integration of the AAV vector is random in the host genome. Evaluation of integration hotspots by common integration sites (CIS) analysis revealed no CIS of higher order than 2nd in study 1 and no CIS of higher order than 6th in study 2 indicating the absence of clonal skewing. Furthermore, the calculated relative sequence count of each unique IS was low, indicating the absence of dominating clones. Despite a high number of IS being detected, the presence of a high frequency of concatemers (up to 97%) was demonstrated in each sample. The feasibility of complete inverted terminal repeat (ITR) sequencing could be shown (0,018% of all sequences in study 1). As expected, partially deleted ITRs with preferred breakpoints within the first half of the ITR (starting from the sequencing initiating site) were detected in our settings. Taken together, these findings are unique in their context showing random AAV vector integration and are of clinical relevance for ongoing and upcoming clinical trials.

124. Adeno-Associated Viral Vector DNA Is Insensitive to De Novo CpG Methylation but Rapidly Associates with Histone Modifications in Liver and Skeletal Muscle

Adrien Léger,¹ Caroline Le Guiner,^{1,2} Michael L. Nickerson,³ Nicolas Ferry,⁴ Philippe Moullier,^{1,2,5} Richard O. Snyder,^{1,5,6} Magalie Penaud-Budloo.^{1,5}

¹INSERM UMR649, Nantes, France; ²Genethon, Evry, France;

³Cancer and Inflammation Program, National Cancer Institute - NIH, Frederick, MD; ⁴INSERM UMR948, Nantes, France;

⁵Department of Molecular Genetics and Microbiology, University of Florida, College of Medicine, Gainesville, FL; ⁶Center of Excellence for Regenerative Health Biotechnology, University of Florida, Alachua, FL.

Recombinant Adeno-Associated Virus (rAAV) vector-mediated gene transfer allows long-term transgene expression in quiescent tissues. We previously showed in nonhuman primate (NHP) skeletal muscle that rAAV genomes are assembled in nucleosomes and form a stable chromatin structure. In the mammalian nucleus, chromatin remodeling *via* epigenetic modifications plays a key role in transcriptional regulation. In order to assess the impact of such regulation on the expression of a therapeutic protein, we injected mice and NHP *via* the intramuscular (IM) or the intravenous (IV) route with a rAAV2/1 or rAAV2/8 vector carrying a reporter transgene under the control of the constitutive Rous Sarcoma Virus promoter (RSVp). To correlate the transcriptional activity with the epigenetic regulation, we determined the vector copy number and the transgene mRNA level

from skeletal muscle and liver samples at early and late time-points by quantitative PCR and RT-PCR respectively. DNA methylation analysis was carried out by pyrosequencing after sodium bisulfite treatment and histone post-transcriptional modifications (PTM) associated with the rAAV chromatin were analyzed by chromatin immunoprecipitation (ChIP). No significant CpG methylation was found along the RSVp sequence of rAAV genomes either in the virions or following transduction of murine and nonhuman primate tissues. This finding is consistent with the long-term expression of the transgene and suggests a resilience of rAAV episomes to DNA methylation. Furthermore, we demonstrated that the RSV promoter drives a much higher level of transgene transcription in skeletal muscle than in the liver. As direct *de novo* DNA methylation is not responsible for this tissue-differential/specific expression, we looked for evidence of other regulatory mechanisms. Indeed, our preliminary ChIP experiments showed that some rAAV genomes are rapidly marked with either repressive or active histone PTM after vector administration.

125. AAV-Mediated Gene Correction for the Treatment of Recessive Dystrophic Epidermolysis Bullosa

Rowan Flynn,¹ Lisa M. Petek,¹ Andrew P. South,² Daniel G. Miller.¹

¹Department of Pediatrics, University of Washington, Seattle, WA; ²Centre for Oncology and Molecular Medicine, University of Dundee, Dundee, United Kingdom.

Epidermolysis Bullosa (EB) encompasses a group of inherited skin diseases characterized by severe trauma-induced blistering, skin denudation, and in the case of dystrophic EB, an increased risk of squamous cell carcinoma. Dystrophic EB is caused by dominant or recessive mutations in the gene encoding for collagen VII, COL7A1. Collagen VII is a major structural component of anchoring fibrils and is secreted by both keratinocytes and fibroblasts. Recessive dystrophic EB (RDEB) is an excellent candidate for gene therapy due to easy target tissue accessibility. Keratinocytes can be isolated from patient biopsies and transduced *ex vivo*, circumventing a potential immune response to the delivery vector and improving efficiency. Skin equivalents derived from these cells can then be transplanted back to the patient. Our lab has previously demonstrated the efficacy of AAV-mediated gene targeting as a treatment approach for the dominantly inherited simplex form of epidermolysis bullosa. Transcription of a mutated gene encoding dominantly active keratin was disrupted using an AAV gene knock-out strategy. Here, we demonstrate for the first time, that this technique can also be applied to gene correction by targeting COL7A1 mutations that cause RDEB. Gene correction would offer several advantages over gene addition; large coding regions make it difficult to produce high titer retrovirus vector preparations and the dominantly inherited form cannot be effectively treated with addition strategies. However, random vector integration events associated with AAV can make it difficult to distinguish successfully targeted clones from vector integration at random genomic sites. To address this issue, we designed a vector containing a synthetic exon promoter trap (SEPT) targeting an intron close to the site of an RDEB-causing mutation, Q251X. This promoterless cassette utilizes the COL7A1 promoter for reporter gene expression, preventing detection of random integrants. Attempts at using a SEPT containing an internal ribosomal entry site (IRES) and GFP reporter resulted in weak fluorescence and reduced our ability to detect homologous recombination. We overcame this by using a brighter reporter, DSRred, and replacing the IRES with a 2A sequence. Southern blot confirmed presence of the of this expression cassette in the target intron. Inclusion of loxP sites in our cassette facilitates Cre-mediated removal of the SEPT, leaving behind corrected COL7A1. By specifically targeting pre-sorted keratinocyte stem cells for

transduction, it should be possible to provide corrected cells of high growth potential suitable for therapeutic use. This is the first study where AAV-targeting has been used for the purpose of gene correction in EB and it demonstrates a technique that can be applied to other disease-causing mutations.

126. A Distinctive Fate of rAAV Vector Genomes in the Liver Transduced with Very Low Doses of rAAV8 in Mice

Kei Adachi,¹ Hiroyuki Nakai.¹

¹Department of Microbiology and Molecular Genetics, University of Pittsburgh School of Medicine, Pittsburgh, PA.

Recombinant AAV (rAAV) vectors mediate persistent transgene expression *in vivo* primarily from extrachromosomal vector genomes. Although rAAV vectors are usually viewed as non-integrating vectors, we and others have demonstrated that rAAV genomes could integrate into the cellular genomes of somatic cells in mice, including hepatocytes in the liver. The liver is one of the major target organs for therapeutic gene delivery and is often inadvertently transduced with vector particles leaked from remote tissues. On the other hand, rAAV vector integration in the liver has raised a concern due to the demonstration of potential genotoxicity leading to hepatocarcinogenesis in a mouse study. Therefore, the elucidation of the rAAV vector genome fate in the liver is crucial for understanding the vector biology in gene therapy and assessing the risk of potential genotoxicity. Here we report our experimental results indicating that, when rAAV serotype 8 (rAAV8) vectors are intravenously injected into adult mice at doses substantially lower than the standard doses (i.e., 1.0×10^7 – 1.0×10^9 vector genomes (vg) per mouse as opposed to the standard doses of 10^{10} to 10^{12} vg/mouse), rAAV vector genomes more preferably integrate into chromosomes rather than remaining as non-integrated forms. In our study, we established a very sensitive quantitative PCR (qPCR) assay system by which we could quantitatively and accurately assess rAAV vector genome copy numbers in the liver. The assay system we employed uses 5 micrograms of genomic DNA as qPCR templates, which showed linearity over a 5-log dynamic range down to 0.000034 double-stranded vector genome (ds-vg) per diploid genomic equivalent (ds-vg/dge). Adult C57BL/6 mice were injected via the tail vein with a rAAV8 vector at doses ranging from 5.0×10^{10} down to 1.0×10^7 vg/mouse, and relative vector genome integration efficiencies were indirectly assessed by comparing vector genome copy numbers before and after two-thirds partial hepatectomy (PHx) using Southern blot analysis (when applicable) and the qPCR assay. In wild type mice injected with 5.0×10^{10} vg/mouse, PHx resulted in 80–85% loss of vector genomes in the liver, demonstrating primarily the extrachromosomal nature of rAAV genomes in the liver. The substantial decrease of copy numbers in this range has been reproducibly demonstrated by us and others in the previous experiments. In contrast and unexpectedly, we found that the effect of PHx on the decrease in vector genome copy numbers was significantly blunted when the mice were injected at doses of 1.0×10^9 vg/mouse or lower. For example, in the mice injected with rAAV8 at a dose of 1.0×10^8 vg/mouse ($n=4$), vector genome copy numbers before and after PHx were 0.0013 ± 0.0001 and 0.0008 ± 0.0001 (mean \pm SEM) ds-vg/dge, respectively (38 \pm 11% decrease). Although this represents indirect evidence, these results indicate that a lesser viral genome load in cells causes activation of cellular DNA repair machinery that mediates genomic integration more preferably than intra- and/or inter-molecular viral genome recombination. In addition, this observation may have implication in the risk assessment of vector spillover into the liver.

127. AAV-Mediated shRNA Integration into an Endogenous miRNA Locus as a New Strategy for Safe, Specific and Persistent Therapeutic RNAi

Stefan Mockenhaupt,¹ Dirk Grimm.¹

¹Infectious Diseases, Heidelberg University, Cluster of Excellence CellNetworks, Heidelberg, Baden-Wuerttemberg, Germany.

The use of viral vector-delivered small hairpin RNAs (shRNAs) to induce RNAi-mediated gene silencing has started to revolutionize human gene therapy due to its efficiency, specificity and versatility. Yet, a critical prerequisite towards clinical translation remains the implementation of potent and safe means to prevent loss of the shRNA vector in proliferating infected cells. Ideally, this will be achieved via stable integration of the shRNA vector DNA into the human genome at a position tolerating insertions while providing sustained and regulated RNAi expression. Here, we accordingly propose site-specific shRNA integration into an endogenous mi(cro)RNA locus as a novel strategy. For proof-of-concept, we engineered a plasmid to carry the authentic human miR-122 stem-loop structure along with 2.5 or 2 kb of flanking 5' or 3' genomic sequences, respectively. We next inserted a potent shRNA targeting human- α -1-antitrypsin (hAAT, a liver-borne enzyme) whose stem-loop mimics the miR-122 structure into a position located about 100 bp upstream of miR-122 itself. Our hope and rationale were that following eventual integration into the genomic miR-122 locus, the endogenous miR-122 promoter will permanently and efficiently co-transcribe the shRNA in a tissue-restricted fashion. Therefore, we first had to validate correct expression and functionality of both hairpin RNAs - ectopic shRNA and genuine miR-122 - encoded by our bicistronic sequence. We thus cloned the entire fragment under a strong viral RNA polymerase II promoter and measured knockdown of luciferase reporters tagged with binding sites for either small RNA. Indeed, we found that both target sequences were efficiently and specifically silenced upon expression of our chimeric plasmid, comparable to extents observed with individual sh or miRNA-encoding constructs. Encouraged by this, we have now transferred the entire fragment into an Adeno-associated viral (AAV) vector context and pseudotyped it with a new synthetic AAV capsid that we have recently engineered to mediate highly potent transduction of cultured cells. At present, we are using this vector in homologous recombination-based attempts to site-specifically integrate our chimeric sh/miRNA sequence into the endogenous miR-122 locus in a human liver cell line. Resulting clones will next be thoroughly characterized and scored positive based on a set of critical parameters, in particular unperturbed cell viability and correct concurrent sh/miRNA expression. Concomitantly, we will assess the potency and longevity of hAAT target gene silencing upon extended culture of single cellular clones. If successful, our approach opens up a wealth of novel avenues to safely integrate ectopic therapeutic shRNAs into human cells and to guarantee tissue-specific and persistent RNAi. We predict that by using tailored and potent viral capsids, and by targeting selected cell-specific miRNA loci, it will be feasible to expand our strategy to numerous clinically relevant organs and to apply the entire approach *in vivo*. Moreover, while we currently co-express a single shRNA, our construct can be readily modified to harbor multiple hairpins to permit combinatorial RNAi therapies.

128. Naturally Occurring Non-Functional Mutations of the AAV ITR

Cameron Mroske,¹ Hector Rivera,² Taihra Ul-Hasan,³ Saswati Chatterjee,³ K. K. Wong, Jr.¹

¹Hematology & Stem Cell Transplantation, City of Hope National Medical Center, Duarte, CA; ²DNA Seq/Solexa, City of Hope National Medical Center, Duarte, CA; ³Virology, City of Hope National Medical Center, Duarte, CA.

Recombinant Adeno-Associated Virus (rAAV), a promising vector for gene therapy, possesses inverted terminal repeats (ITRs) whose integrity is critical for vector replication, packaging, and transduction. Since AAV ITRs possess 70% GC content and are palindromic, they frequently undergo spontaneous deletion during plasmid or vector replication, and are notoriously difficult to sequence. To develop a consistent and reliable sequencing protocol, the ITRs of our in-house molecular clone of AAV₂ (pTZA₂), and the parental AAV₂ construct, pAV₂, obtained from ATCC (American Type Culture Collection), were A) sequenced directly from plasmid DNA in the presence of denaturant (direct sequencing method, DSM), or B) first amplified in a reaction where 7-deaza dGTP was substituted for dGTP and the resultant amplification product sequenced (amplification sequencing method, ASM). We report that the DSM and ASM revealed consistent mutations in the ITRs of cloned AAV₂. Each technique yielded clear chromatograms and revealed that pTZA₂ and pAV₂ possess identical mutations at the upstream Msc I site of the 5' ITR (T>G, nt 2), as well as a newly reported mutation in the downstream Msc I site of the 3' ITR (del. nt 4672-4679). The chromatograms for pAV₂ also revealed an additional rearrangement in its 5' ITR, whereby the BC motif is inverted such that the 5' and 3' ITRs adopt a FLOP/FLOP orientation. Additionally, these mutations did not affect vector titer or transduction. The potential effects of these mutations on AAV₂ replication will be discussed, in addition to potential applications. Because the DSM and ASM offer a way to verify ITR integrity, they constitute a powerful tool for the process development of rAAV vectors for gene therapy.

129. Establishment and Use of a Configuration-Specific Method to Determine the Structure of AAV-ITRs Recombined by DNA Repair Pathways

Baocheng Huang,¹ Hiroyuki Nakai.¹

¹Department of Microbiology and Molecular Genetics, University of Pittsburgh School of Medicine, Pittsburgh, PA.

Recombinant adeno-associated virus (rAAV) is among the most promising vectors for human gene therapy. In the meantime, it has been demonstrated that the unusual structure of AAV viral genome triggers DNA damage responses, which subsequently mediate viral genome recombination through the AAV-inverted terminal repeats (ITRs). The consequence of the recombination is the formation of AAV-ITRs joined in head-to-head (H-H), head-to-tail (H-T) or tail-to-tail (T-T) configuration. Analysis of the recombined AAV-ITR structures would provide clues to how and what DNA repair pathways process the viral genome; however, challenges remain in conducting such an analysis due to the structural instability of AAV-ITRs in cloning and the difficulty in faithfully amplifying AAV-ITR junctions by PCR. Here, to overcome the challenges, we establish a new PCR-based method that amplifies each of H-H, H-T and T-T AAV-ITR junction sequences precisely, and therefore allows to determine how two AAV-ITRs recombine at sequence levels. The method takes advantage of bisulfite chemical modification of the sample DNA followed by PCR using H-H, H-T or T-T configuration specific primer sets. In the study, we synthesized the theoretical H-H, H-T and T-T AAV-ITR junctions with no deletions, together with ITR-adjacent sequences, based on the chemically modified sequence of double-stranded (ds) AAV-CMV-GFP vector. Using

these synthesized DNAs as templates, we identified the primer sets that could specifically amplify each types of ITR-ITR junctions. C57BL/6 mice and DNA-dependent protein kinase catalytic subunit (DNA-PKcs)-deficient SCID mice were injected with dsAAV8-CMV-GFP through the tail vein at 5.0 x10¹⁰ vector genomes/mouse, and livers were harvested after stable transduction was established. In dsAAV vector genome recombination, each of the three configurations (i.e., T-T, H-H and H-T) represents a different type of recombination (i.e., open (O) end recombination, closed (C) end recombination, and C-O recombination, respectively). To analyze the recombined AAV-ITR structures in the liver, the DNA samples were treated with Exonuclease III followed by bisulfite chemical modification, the configuration-specific PCR, TA cloning, and sequencing. The results showed that, in wild type animals, C-end recombination events occurred in a relatively uniform and simple fashion with the proximal arm of the T-shaped hairpins being the recombination hot spot, while O-end recombination occurred throughout the AAV-ITR with occasional complexity. This indicates that cleavage at the tip of T-shaped hairpins by DNA repair factor(s) is essential for the C-end recombination but not necessarily so in the O-end recombination. In the absence of DNA-PKcs, homologous recombination of AAV-ITRs were frequently observed, while the trend observed in the O-end recombination in wild-type mice was attenuated, making more extensive deletions in SCID mice. Thus, our new system provides a powerful tool to study rAAV genome recombination and DNA repair pathways and will significantly help understand the biology of rAAV vectors.

130. AAV Vectors Copurify with Microvesicles in Producer Cell Media: Implications for Gene Transfer and Vector Purification

Casey A. Maguire,¹ Leonora Balaj,¹ Sara Sivaraman,¹ Johan Skog,¹ Miguel Sena-Esteves,² Xandra O. Breakefield,¹ Bakhos A. Tannous.¹

¹Neurology, Massachusetts General Hospital, Charlestown, MA; ²Neurology, University of Massachusetts Medical School, Worcester, MA.

Recently it has been shown that certain serotypes of AAV are efficiently shed into the media during vector production. The mechanism by which this occurs is currently not known. As exosomes and microvesicles are efficiently shed/secreted from cells for the transport of various cellular proteins and nucleic acid, we investigated whether AAV vectors could be found within or associated with microvesicles. Centrifuging media from AAV producer cells (both AAV1 and AAV2 serotypes tested) at a g-force which efficiently pelleted microvesicles but not standard, cell lysate purified AAV, resulted in the co-purification of AAV vector. The microvesicles size distribution was determined using nanoparticle tracking analysis. Interestingly microvesicles isolated from AAV producing cells displayed a large (>200nm) subpopulation of microvesicles not observed in nontransfected cells. Furthermore GAPDH mRNA and AAV capsid proteins were detected in the microvesicle/AAV pellet. Finally, microvesicle-associated AAV was approximately 3-fold more efficient at transducing human 293T and U87 cells compared to standard purified AAV when used at equal genome copy numbers. Currently we are examining the localization of the AAV capsid in relation to the surface and/or interior of associated microvesicles using transmission electron microscopy and gold labeled antibodies. These data may be important for the development of a unique AAV/microvesicle gene delivery system and also for AAV purification protocols.

131. A Simple Strategy To Increase the Transduction Efficiency of Single-Stranded AAV Vectors *In Vitro* and *In Vivo*

Wenqin Ma,¹ Baozheng Li,¹ Chen Ling,¹ Giridhara R. Jayandharan,^{1,2} Arun Srivastava,¹ Barry J. Byrne.¹

¹Department of Pediatrics, University of Florida College of Medicine, Gainesville, FL; ²Department of Haematology, Christian Medical College, Vellore, Tamil Nadu, India.

The conventional AAV vectors contain a single-stranded (ss) DNA genome, which is transcriptionally-inactive. Our group and others have documented that viral second-strand synthesis is a major rate-limiting step in AAV vector-mediated transgene expression. Although double-stranded DNA-containing AAV vectors, termed self-complementary AAV (scAAV), have been developed that bypass the requirement for viral second-strand DNA synthesis, their packaging capacity is reduced by approximately one-half. Thus, scAAV vectors containing large genes, such as the human coagulation factor VIII (hF. VIII) for the potential gene therapy for hemophilia A, are unlikely to be generated, and strategies to improve the transduction efficiency of conventional ssAAV vectors need to be developed. In pursuit of one such strategy, we have described the development of scAAV-PP5 vectors, and demonstrated that co-infection or co-administration with these scAAV vectors leads to a significant increase in the transduction efficiency of ssAAV vectors in human cells *in vitro* as well as in murine hepatocytes *in vivo* [*Gene Ther.*, 15: 1287-1293, 2008; *Hum. Gene Ther.*, 21: 271-283, 2010]. In an attempt to further reduce the labor and production costs associated with packaging both ssAAV and scAAV vectors separately, we reasoned that the two steps could be combined to generate a mixed-population of the two vectors. Here we describe a quadruple-plasmid transfection protocol that results in the production of ssAAV vectors that transduce cells at ~5-10-fold higher efficiency, both human cells *in vitro* (Fig. 1A,B) and murine hepatocytes *in vivo* (Fig. 1C,D), than in the absence of PP5 co-expression. This simple strategy should be applicable for generating more efficient ssAAV vector containing large genes that exceed the packaging capacity of scAAV vectors.

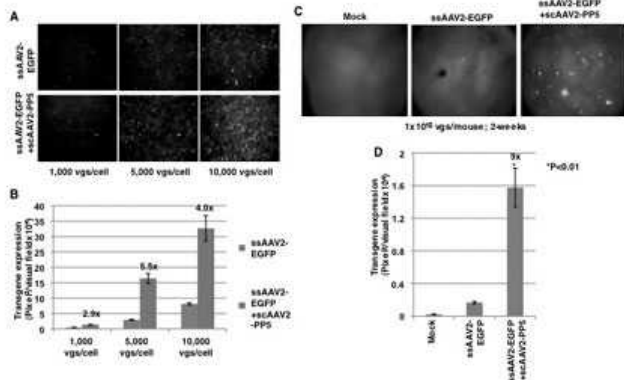

Fig. 1: (A) ssAAV vector-mediated transduction of human 293 cells. Vector stocks generated by the triple-plasmid and the quadruple-plasmid transfection protocols, respectively, were used to transduce cells at various indicated multiplicities-of-infection (m.o.i.), and transgene expression was detected by fluorescence microscopy 72-hrs post-transduction. (B) Quantitative analyses of the data from (A). (C) Comparative analysis of ssAAV2-EGFP vector-mediated transduction efficiency in hepatocytes of normal C57BL/6 mice injected with vector stocks generated by the two protocols. Transgene expression was detected by fluorescence microscopy 2-weeks post-injection of 1×10^{10} ssAAV2-EGFP vector particles/animal via tail-vein. (D) Quantitative analyses of the data from (C). Transgene expression was assessed by the NIH ImageJ analysis software. * $P < 0.01$.

132. Site-Specific Modification of AAV2 Vector by Using the Genetically Encoded Aldehyde Tag

Yarong Liu,¹ Kye-Il Joo,¹ Pin Wang.¹

¹Chemical Engineering, University of Southern California, Los Angeles, CA.

Adeno-associated virus (AAV) vectors are becoming increasingly popular for human gene therapy due to their non-pathogenicity and diverse tissue tropisms with different AAV serotypes. AAV-2 vectors have attracted considerable interest because of the widespread expression of their receptors heparan sulfate proteoglycan (HSPG) on many tissues. Thus targeted transduction *in vivo* appears to be limited with the application of AAV-2 vectors. And the insertion of targeting peptide sequence into viral capsid protein usually causes a significant loss of titer or DNA packaging efficiency. Moreover, covalent conjugation of fluorescent dye or ligands by using a random lysine modification sometimes alters important protein function. To overcome these limitations, we have developed a new method for site-specifically labeling AAV2 with either biophysical probes or targeting ligands without loss of viral titer. Our approach involves the insertion of a genetically encoded aldehyde tag (13-residues: LCTPSRAALLTGR) onto AAV2 capsids, which can be metabolically modified to generate an aldehyde group as a unique chemical handle for further intracellular trafficking of virus particles. We demonstrated this modified AAV2 allows its chemical conjugation with hydrazide-functionalized dyes for intracellular study of AAV2. Also, site-specifically conjugated antibodies to AAV2 can significantly enhance the transduction in non-permissive cells expressing targeting receptors. These results suggest that this new approach holds significant promise for future studies of understanding virus trafficking pathways, and establishes a new platform for a wide range of AAV applications, especially for targeting to non-permissive cells.

133. Construction of (Multi) Monomeric Duplex Adeno-Associated Vectors for Human Gene Therapy

Jacek Lubelski,¹ Yvet Noordman,¹ Bas Bosma,¹ Larbi Afia,¹ Harald Petry,¹ Andrew Bakker.¹

¹Amsterdam Molecular Therapeutics, Amsterdam, Netherlands.

Recombinant adeno-associated (rAAV) vectors contain linear single stranded DNA genome which is flanked by inverted terminal repeats (ITRs). This DNA needs to be converted into double stranded form in order to be transcriptionally active in the host cell, which seems to be a rate limiting step leading to low transduction efficiency in some cell types. This critical step can be efficiently bypassed through the use of self complementary AAV vectors (1-4). The need of ssDNA to dsDNA conversion via either self pairing of plus and minus strands or DNA synthesis can be circumvented by packaging of both complementary strands as one covalently linked molecule. This can be achieved by enhancing the production and encapsidation of dimeric genomes. The currently existing technologies for generation of self complementary rAAV vectors which are based on deletion of *terminal resolution site* (trs) in one of the ITRs can result in tandem repeats at best (1). It has been shown before that upon encapsidation of genomes smaller than a maximum capacity of AAV a mixed population of vectors is generated (5). This observation suggested that during the encapsidation process, a trs site might be naturally skipped by Rep enzyme(s) which in turns results in encapsidation of DNA until the maximum packaging capacity of AAV capsid is reached. Here we have investigated if by altering Replicase enzymes this natural trs skipping during packaging process can be enhanced. Furthermore, we hypothesized that conditions under which multiple trs sequences are skipped and multimeric covalently linked genomes are encapsidated might exist. The final size of the genome would be than limited by the physical maximum capacity of the capsid and

not by the two flanking ITRs. This would allow for encapsidation of multiple consecutive covalently linked copies of small genomes. Reference list: 1. Samulski, R. J. and McCarty, D. M. (2008) Duplexed parvovirus vectors. 2. McCarty, D. M. (2008) *Mol. Ther.* **16**, 1648-1656. 3. McCarty, D. M., Monahan, P. E., and Samulski, R. J. (2001) *Gene Ther.* **8**, 1248-1254. 4. McCarty, D. M., Fu, H., Monahan, P. E., Toulson, C. E., Naik, P., and Samulski, R. J. (2003) *Gene Ther.* **10**, 2112-2118. 5. Urabe, M., Nakakura, T., Xin, K. Q., Obara, Y., Mizukami, H., Kume, A., Kotin, R. M., and Ozawa, K. (2006) *J. Virol.* **80**, 1874-1885

134. Targeted Integration of an rAAV Vector into the AAVS1 Site: Measurement of the Integration Rate without Selection

Peter Ward,¹ Christopher E. Walsh.¹

¹Department of Medicine/Tisch Cancer Institute, Mount Sinai School of Medicine, New York, NY.

Recently several problems have become apparent in the use of AAV as an in vivo gene delivery vehicle such as random viral integration and an immune response to the viral capsid. These problems suggests the usefulness of an ex vivo method of AAV gene delivery for some applications. AAV has the capacity to integrate in a site-specific manner into chromosome 19 (a site designated AAVS1). The only virally encoded protein necessary for integration into AAVS1 is the AAV Rep protein. We chose to evaluate the feasibility of using a targeted integration approach that may be useful for eventual ex vivo gene transfer. Cells from the liver cell line, Hep G2, were co-infected with rAAV2-GFP and wt AAV2 that was used to supply Rep in trans. The percent of transduced cells was determined by FACS analysis at each passage. After several passages, the percentage of positive cells decreased to a constant level. Cells were sorted and individual green fluorescent cells from this sorted population were cloned and grown. DNA was extracted and AAV-genomic junctions were determined by LM-PCR. In cells co-infected with AAV2-GFP and wild type AAV2, 27% were transduced. This fell to a constant level of 1.2 % after several weeks of growth, prior to sorting and cloning. This contrasts with 18% and 0.3 % respectively, in the cells infected with rAAV2-GFP alone. Of the co-infected clones, 22 out of 26 sorted clones remained fluorescent. Integration analysis of 10 co-infected clones revealed that the transgene was located in the AAVS1 region of chromosome 19- in 3 clones. We also found integration in a non AAVS1 region of chromosome 19. Of interest, we found rAAV integration within an integrated wt AAV genome. To enhance cell transduction and possibly integration, co-infected cells were incubated with doxorubicin, hydroxyurea, or camptothecin. Although transduction values were 53, 31, and 146- fold higher respectively, compared with non-drug treated cells, we found no significant enhancement in the rate of integration. A failure to achieve higher integration in these populations suggests that the efficiency of site specific integration is not limited by the number of virus genomes available for episomally based transduction. In conclusion, these results suggest that by using this co-infection technique, an rAAV transgene can efficiently integrate into the AAVS1 locus and suggests that site-specific rAAV integration as an ex vivo approach is feasible.

Adenovirus and Other DNA Virus Vectors I

135. Microscopy Analysis of Adenovirus Serotype 3 Interaction with its Receptor Desmoglein 2

Zong-Yi Li,¹ Hongjie Wang,¹ Ines Beyer,¹ Pascal Fender,² Andre Lieber.¹

¹Division of Medical Genetics, University of Washington, Seattle, WA; ²EMBL, Grenoble, France.

We identified Desmoglein 2 (DSG2) as the primary receptor for adenovirus (Ad) serotype 3 as well as for (Ad) serotypes 7, 11, and 14. These serotypes are important human pathogens causing respiratory and urinary tract infections. So far, the mechanism of Ad3 entrance and spread in epithelial tissues has been unknown. Using confocal immunofluorescence microscopy on a series of polarized human epithelial cells, including colon cancer lines T84 and CaCo as well as primary small airway epithelial cells, we found that DSG2 is localized to epithelial junctions. The tight junction protein ZO-1 is localized on apical of DSG2. Other junction proteins (claudin 7 and E-cadherin) were beneath DSG2 along the lateral cell membrane. We visualized binding of Ad3 virions and subviral Ad3 penton-dodecahedra (PtDd) particles to DSG2 on polarized epithelial cells. These studies suggest that Ad3 interacts with several DSG2 molecules and that Ad3-DSG2 complexes are internalized within 15 minutes. Importantly, interaction of Ad3 virions or PtDds with DSG2 triggered partial dissolution of epithelial junctions, reflected in decreased staining for claudin 7 and E-cadherin in junctions (in confocal microscopy images) and disappearance of apical desmosomes (in electron-microscopy images). A similar effect was seen with recombinant dimeric Ad3 fiber proteins (AD3K-K). Ad3, PtDd, or Ad3K-K mediated opening of junctions increased access to proteins that are trapped in junctions or localized on the basolateral membrane of epithelial cells (such as CD46 or Her2/neu-the receptor for the therapeutic monoclonal antibody Herceptin). This has practical implications. Ad3K-K pretreatment of Her2/neu positive xenograft tumors in mice significantly improved the efficiency of Herceptin therapy. We also hypothesize that, during Ad infection, Ad3/PtDd- triggered epithelial junction opening further increases access to DSG2 molecules that are more embedded in tight junctions thereby facilitating lateral viral spread. We are currently attempting to prove this hypothesis. While DSG2 is not expressed in mouse cells, its expression pattern in non-human primates appears to be similar to that in humans. For studies on Ad3 pathology, we are creating human DSG2 transgenic mice and tumor cell lines. So far, we have verified that Ad3 and PtDd bind to human DSG2 in transgenic cell lines. Studies on the consequences of Ad3 PtDd-huDSG2 interaction on the integrity of epithelial junctions are ongoing and results will be reported. Overall, our studies shed light on how the widely distributed Ad serotype 3 infects epithelial cells.

136. The Role of Endosomal Escape and Mitogen Activated Protein Kinases in Adenoviral Activation of the Innate Immune Response

Jeffrey S. Smith,¹ Zhili Xu,¹ Jie Tian,¹ Donna J. Palmer,² Philip Ng,² Andrew P. Byrnes.¹

¹Division of Cellular and Gene Therapies, Food and Drug Administration, Bethesda, MD; ²Molecular and Human Genetics, Baylor College of Medicine, Houston, TX.

Capsid proteins induce a strong innate immune response following systemic administration of adenovirus, and this creates a major obstacle to the therapeutic use of adenoviral vectors. We investigated the role of endosomal escape and mitogen activated protein kinases (MAPKs) in the innate immune response following intravenous injection of adenoviral vectors into mice. To determine the role of

endosomal escape, we evaluated the innate immune response to ts1, a temperature sensitive Ad2 mutant that is defective in endosomal escape due to a mutation in the viral protease. This was compared to the innate response produced by a replication defective helper-dependent adenoviral vector (HDAd2) that is devoid of all viral genes but possesses a wt Ad2 capsid. We found that ts1 was significantly deficient in stimulating the innate cytokine response compared to HDAd2. Because MAPKs are involved in intracellular pathways of cytokine induction, we investigated the role of the MAPKs ERK and p38 in the innate response to adenovirus. MAPKs are activated by phosphorylation, and therefore we evaluated changes in the relative phosphorylation of these MAPKs after injection of HDAd2 and ts1. We found that the relative phosphorylation of ERK was elevated in both the liver and spleen 30 minutes after i.v. administration of HDAd2, but not by ts1. Likewise, we found that HDAd2 elevated the phosphorylation of p38 in the liver, but ts1 did not. To determine whether MAPKs play a role in the innate immune response to adenovirus *in vivo*, we treated mice with inhibitors of ERK or p38 pathways prior to injection of HDAd2 and evaluated the serum level of seven proinflammatory cytokines/chemokines (IL-12, IFN-gamma, KC, IL-6, IL1-beta, TNF-alpha and IL-10) 6 hours after HDAd2. As a control, we examined how MAPK inhibitors affected the cytokine response to LPS. Both LPS and HDAd2 produced increases in all 7 of these cytokines/chemokines relative to buffer control animals. We found that inhibition of ERK did not alter LPS-induced cytokines; however, inhibition of p38 reduced the response to LPS for all cytokines/chemokines tested except for KC. In contrast, inhibition of ERK altered the level of five of the HDAd2-induced cytokines, increasing the level of IL-12, IFN-gamma and IL-6, while decreasing the level of KC and TNF-alpha. Additionally, administering the p38 inhibitor prior to HDAd2 lowered the levels of only 3 cytokines: IFN-gamma, IL1-beta and IL-10. These data indicate that the involvement of MAPKs in adenovirus-induced cytokine responses is more complex than the role of MAPKs in LPS-induced responses. We conclude that endosomal escape plays a critical role in triggering the innate response to systemically administered adenoviral vectors and that MAPKs play a role in this stimulation.

137. The Sequential Proteolysis and Liberation of the Intracellular Domain of CD44 Modulates Adenoviral Vector Transgene Expression and Replication of Adenovirus

Wesley S. Bond,^{1,4} Cristhian J. Ildefonso,^{1,4} Mary Y. Hurwitz,^{2,4} Richard L. Hurwitz,^{1,4}

¹Interdepartmental Program in Translational Biology & Molecular Medicine, Baylor College of Medicine, Houston, TX; ²Center for Cell and Gene Therapy, Baylor College of Medicine, Houston, TX; ³Department of Pediatrics, Baylor College of Medicine, Houston, TX; ⁴Texas Children's Cancer Center, Houston, TX.

There have been recent reports of successful applications of gene therapy to treat ocular oncologic and degenerative diseases which suggest that the intraocular environment can influence the efficiency of gene therapy viral vectors. Expression of adenoviral vector-delivered transgenes has been shown to be enhanced by exposing transduced cells to bovine vitreous humor. The interaction of high-molecular-weight hyaluronan (HA), an abundant component of vitreous, and its receptor CD44 plays a critical role in this enhancement effect. Small oligosaccharides of HA, which have been shown to interfere with high-molecular-weight HA binding, diminish CD44:HA-mediated enhancement of transgene expression. CD44 undergoes a process of sequential proteolysis in the ectodomain and the transmembrane region, liberating the intracellular domain (ICD) that subsequently traffics to the nucleus. Both the proteolysis of the ectodomain of CD44 by matrix metalloproteases and the subsequent intramembraneous proteolysis of CD44 by the γ -secretase complex and liberation of

the ICD are required for the CD44:HA-mediated enhancement of transgene expression. Expression of mutant CD44 constructs lacking the protease cleavage sites as well as inhibition of metalloprotease or γ -secretase by small molecule inhibitors significantly attenuated CD44:HA-mediated enhancement of gene expression in cultured cells. Expression of a CD44 ICD construct has also been shown to significantly increase transgene expression in the absence of HA. Both the inhibition of HA:CD44 interaction by a CD44 blocking antibody and the inhibition of metalloprotease and γ -secretase by small molecule inhibitors was shown to significantly decrease adenoviral vector transgene expression in human conjunctiva explants. In addition to expression of vector transgenes, the replication of wild-type adenovirus was decreased in the presence of metalloprotease or γ -secretase inhibitors in cultured cells. These observations suggest that the CD44 signaling pathway could provide an important mechanism for controlling the expression of adenoviral vector-delivered genes in gene therapy applications as well as provide a potential therapeutic target for treatment of adenovirus infection.

138. Enhanced Transduction of Fiber Modified Ad in Canine Lymphoma Cell Lines

Ann Marie O'Neill,¹ David T. Curiel,² Bruce F. Smith.^{1,3}

¹Scott Ritchey Research Center, Auburn University, Auburn, AL;

²Department of Radiation Oncology, Washington University School of Medicine, St. Louis, MO; ³Department of Pathobiology, Auburn University, Auburn, AL.

Canine lymphoma represents an excellent model of human non-Hodgkin's Lymphoma - it has a similar etiology and presentation to the human disease, the model has an intact immune system, and the size of the model allows for extrapolation to humans. The use of this model is further strengthened by the high similarity between dog and human genomes and the presence of evolutionarily conserved cytogenetic changes in hematological malignancies. Recombinant Adenoviral (Ad) vectors derived from serotypes 2 and 5 are among the most promising vehicles for *in vivo* gene delivery, based on previously demonstrated efficiency in a number of cancer gene therapy applications. Entry of Ad into cells is a multi-step process, requiring binding of the native Coxsackie and Adenovirus receptor (CAR) by viral fiber knob, followed by interaction of an RGD motif in the penton base of Ad with $\alpha_v\beta_3$ integrins on the cell surface. However, our analysis of canine lymphoma cell lines and primary lymphoma cells indicates that they are refractory to infection by Ad vectors due to the lack of the CAR and low-level expression of $\alpha_v\beta_3$. Ad5 vectors with chimeric fibers derived from non-human adenovirus serotypes were used to transfect canine lymphoma cell lines. Ad5.CK1 was modified to include the canine adenovirus 1 (CAV1) knob domain, Ad5.PK contained the porcine (Ad4) knob domain. In the human context, the use of these xeno-adenoviruses may have advantages in that no previous immunity to these viruses is likely to exist and the alternative entry pathways may circumvent the CAR-integrin entry pathway in those cells that are normally refractive to Ad5 infection. The vector Ad5.CK1 has been shown to alter Ad5 tropism through a CAR-independent pathway in CAR-deficient human ovarian cancer cell lines and primary tissue samples. The vector Ad5.PK knob domain has not yet been described but it is believed to target specific carbohydrates. Canine lymphoma cell lines OSW and 17-71 were used to test the efficacy of these vectors to achieve CAR-independent transduction. In OSW cells, low-level transduction was achieved with both vectors. These cells were then stimulated with PMA plus ionomycin and transduction by both vectors was enhanced. Following incubation with an anti-integrin antibody, transduction efficiency was reduced to or below the level seen in unstimulated cells. In 17-71 cells, transduction was achieved only with Ad5.CK1. Following stimulation transduction efficiency did increase, although modestly - less than 2 fold - with a concurrent reduction seen

with the addition of antibody. This cell line has lower levels of $\alpha_v\beta_3$ than OSW. This data suggests that, while these vectors may be able to utilize alternative receptors with the potential to bypass the normal Ad entry mechanisms, they may continue to utilize integrin binding as at least a portion of their entry mechanism. Additionally, stimulation of canine lymphoma cells with appropriate mitogens may enhance transduction by retargeted virus in a CAR-independent manner. Thus, integrin expression remains critical to this process.

139. Simultaneous Genetic Peptide Targeting of Adenovirus Subtype 5 towards Two Different Receptors

Michael Behr,^{1,2} Maximilian Richter,^{1,2} Martin A. Häusl,³ Philipp Fieger,^{1,2} Sarah Engelhardt,^{1,2} Carolin Stegmüller,^{1,2} Alexander H. Enk,² Anja Ehrhardt,³ Dirk M. Nettelbeck.^{1,2}

¹Helmholtz-University Group Oncolytic Adenoviruses, German Cancer Research Center, Heidelberg, Germany; ²Dept. of Dermatology, Heidelberg University Hospital, Heidelberg, Germany; ³Max von Pettenkofer-Institute, München, Germany.

Adenoviral oncolysis is a promising new modality for the treatment of cancer. Safety and proof-of-principle of oncolytic adenoviruses were shown in clinical trials, but lack until now therapeutic efficiency. Perhaps one of the most important limitations is the poor efficiency and specificity of cell entry. We genetically incorporated small peptide ligands with specificity towards receptors which are preferentially overexpressed on cancer cells into different loops of a chimeric fiber, containing knob- and shaft-domains of the Ad41 small fiber gene fused to the Ad5 fiber tail-domain. We have previously shown that this fiber format is receptor blind and serves as a detargeted scaffold for the insertion of targeting ligands. The retargeted chimeric fibers were incorporated in a genomically fiberless Ad5 reporter virus using an established transient transfection/infection system. De- and retargeting capacity of the chimeric fibers were analysed *in vitro*. We found, that the published YSA-peptide, incorporated in our chimeric fiber, is capable to mediate specific transduction of cells expressing the receptor tyrosine kinase EphA2, which is present on tumor endothelium and overexpressed on a large panel of cancer cells. However, not all tumor cells within a tumor have the same expression profile of individual receptors. In consequence tumor cells lacking the targeting receptor cannot be efficiently transduced. To overcome this possible limitation we incorporated simultaneously besides the YSA-peptide further ligands into other positions of the Ad41 short fiber knob. On the one hand we combined the YSA-peptide with the well characterized RGD-peptide that targets integrins. On the other hand we combined the YSA-peptide with a transferrin receptor targeting ligand successfully. Resulting fibers were able to trimerize and were incorporated into the genomically fiberless Ad5 reporter viruses. Due to the presence of the additional ligand, these viruses were able to transduce EphA2-negative cancer cells *in vitro* efficiently. Currently we are generating Ad5 based reporter viruses with genomically modified chimeric fiber genes carrying the most promising ligand combinations. Towards this end we are using a versatile cloning strategy based on a BAC-recombineering system that allows for rapid modifications of the Ad genome. In conclusion, our data indicate that targeting towards two different receptors with a single agent is possible via genetic insertion of peptide ligands, opening new avenues for therapeutic applications.

140. Augmentation of Rat Skin Flap Viability by Relaxin-Expressing Adenovirus

Il-Kyu Choi,^{1,3} Won Jai Lee,² In Sik Yun,² Yong-Oock Kim,² Tae Jin Yun,¹ Dong Kyun Rah,² Chae-Ok Yun.^{1,3}

¹Brain Korea 21 Project for Medical Sciences, Institute for Cancer Research, Severance Biomedical Science Institute, Seoul, Republic of Korea; ²Institute for Human Tissue Restoration, Department of Plastic & Reconstructive Surgery, Seoul, Republic of Korea; ³KOSEF through National Core Research Center for Nanomedical Technology, Seoul, Republic of Korea.

Relaxin (RLX) has multiple vascular actions such as vasodilatation, angiogenesis, and production of a vascular endothelial growth factor (VEGF). We have generated a RLX-expressing (dE1-RGD/lacZ/RLX) adenovirus, and investigated whether or not it enhances the skin flap survival. A total of 30 Sprague-Dawley rats were divided into three groups: RLX-expressing adenovirus group, control virus group, and PBS group. On the distally based flap of 3×9 cm in size, it was subdermally injected with the dE1-RGD/lacZ/RLX (107 PFU), dE1-RGD/lacZ virus, and PBS, which were administered 48 hours prior and immediately before flap elevation. A survival area of a flap and the amount of blood flow were measured. On postoperative day 10, the CD31 positively stained vessels and VEGF protein expression were examined. There was a significant increase in the survival area of the flap in the RLX group. The Doppler measurement also showed significantly increased blood flow immediately after the operation and on postoperative days (day 7 and 10). The CD31 (the number of the CD31) positively stained vessels and VEGF protein expression were significantly larger (increased) in the RLX group. Administered RLX-expressing adenovirus into the elevated skin flaps increased VEGF expression, number of capillaries, and blood flow to the flap, thereby improving the skin flap survival.

141. A Rapid, PCR-Based Method for Direct In-Vitro Cloning into Recombinant Adenoviral Vectors

Thomas P. Quinn,¹ Lily Lee,¹ Mei Fong,¹ Michael Haugwitz,¹ Hiroaki Sagawa.¹

¹Clontech Laboratories Inc., A Takara Bio Company, Mountain View, CA.

Adenoviral vectors are widely accepted for gene delivery because they can be cultured to high titers and efficiently transduce a wide variety of cell types *in vitro* and *in vivo*. Previous methods of construction have been troubled by inefficient recombination efficiencies, the need for shuttle vectors, plaque purifications, and labor intensive methods. Here, we present a simple and more streamlined method to produce recombinant adenoviral constructs using a 30 minute, ligation-independent and sequence-independent reaction to seamlessly and directionally clone PCR fragments directly into a linearized adenoviral vector. Moreover, no additional treatment of the PCR fragment is required, such as restriction enzyme digestion, phosphorylation, or blunt-end polishing. This rapid approach requires only 3 days to generate a transfectable adenoviral vector compared to the 6 to 8 days needed by other cloning methods that use a donor or shuttle vector. Using an I-Ceu I and PI-Sce I linearized adenoviral backbone with numerous PCR amplimers, we observed >80% cloning efficiency and nearly 100% cloning success with little or no background as measured by colony PCR screening and endonuclease restriction analysis. We also observed strong correlation between PCR positive clones and intact adenoviral DNA suggesting that the vectors remained stable throughout the cloning process, showing minimal rearrangements. Additionally, we sequenced clones to confirm both the insert orientation and the integrity of cloning junctions and found that 100% were in proper orientation with no sequence changes at the junctions. The flexibility of the method was confirmed by cloning into numerous vector formats including constitutive and promoterless types both with and without fluorescent proteins expressed from

the E3 region. To demonstrate complete functionality, we cloned several cDNAs into an adenoviral vector containing the complete 3rd generation tetracycline-inducible expression system that was optimized for low basal and high maximal expression. These Pac I linearized recombinant adenoviral vectors were efficiently transfected into 293 cells using a biodegradable polymer and an optimized 4hr protocol. Rescue was deemed complete when cytopathic effect was observed 7 days following transfection. Adenoviral stocks produced from these vectors, were able to produce high titer virus (1e9 IFU/ml) and achieve induced expression levels that were >1300 fold over the uninduced state in HeLa cells. We believe this cloning system will ultimately increase the utility of adenoviral vectors by allowing rapid, accurate, and directional high-throughput cloning, further facilitating the production of functional adenoviral stocks for gene therapy development and gene function studies.

142. Differential Effects of Murine and Human Factor X on Adenovirus Transduction Via Cell Surface Heparan Sulfate

Anne K. Zaïss,^{1,2} Roger Lawrence,³ David Elashoff,⁴ Jeffrey D. Esko,³ Harvey R. Herschman.^{1,2}

¹Department of Biological Chemistry, David Geffen School of Medicine, University of California Los Angeles, Los Angeles, CA; ²Department of Medical and Molecular Pharmacology, David Geffen School of Medicine, University of California Los Angeles, Los Angeles, CA; ³Department of Cellular and Molecular Medicine, Glycobiology Research and Training Center, University of California San Diego, La Jolla, CA; ⁴Department of Medicine, David Geffen School of Medicine, University of California Los Angeles, Los Angeles, CA.

Serum factor X (FX) is proposed to play a major role in Adenovirus tropism, binding to the virus hexon protein and promoting transduction by bridging the virus to cell surface heparan sulfate proteoglycans (HSPGs). Both murine FX and human FX increased transduction of an Adenovirus vector 2-4 fold in murine hepatocyte-like cells and human hepatocarcinoma cells. In contrast, only hFX increased transduction of several non-hepatic cancer cell lines and Chinese hamster ovary cells. mFX was not only unable to promote transduction in these cells; mFX competitively blocked hFX-enhanced transduction. Competition and HSPG digestion experiments suggest increased transduction by both mFX and hFX in hepatocyte-derived cells and increased transduction mediated by hFX in epithelial cells were dependent on HSPGs. Hepatocyte-derived cell lines express substantially more HSPGs than the cancer cell lines studied. Dose response curves suggest that Ad:hFX has a greater affinity for HSPGs than does Ad:mFX. In coagulation factor-depleted mice, hFX showed a similar enhanced ability, compared to mFX, to reconstitute hepatic Adenovirus transduction. These results suggest that differences in Ad:hFX and Ad:mFX affinity to HSPGs might result in differences in their ability to enhance Adenovirus transduction of many cell types. These findings may have implications for murine models of adenovirus vector targeting.

143. Improved Tropism of Adenoviral Vectors for Muscle Cells Using an IGF-1R Targeted Bispecific Ligand

Maxime Pinard,^{1,2} Birgit Kastberger,¹ Yue Zeng,¹ Nancy Larochelle,³ Josephine Nalbantoglu,³ Bernard Massie,^{1,2} Régnald Gilbert.^{1,3}

¹Biotechnology Research Institute, Montreal, Canada; ²University of Montreal, Montreal, Canada; ³Montreal Neurological Institute, Montreal, Canada.

Adenoviral vector (AdV) is being intensively investigated as a tool to deliver exogenous sequences to different tissues in order to correct

multiple genetic disorders. Limited expression of the Coxsackie and Adenovirus Receptor (CAR), the primary receptor for AdV, has been a major drawback in gene transfer approaches. To compensate for the paucity of CAR, multiple strategies have been proposed. Some of them consist to alter the AdV fiber to enable recognition of new receptors at the cellular surface, such as PEGylation or using fibers derived from other serotypes. Our group has developed a bispecific ligand approach coupled with Ad5 fiber modification. The interaction between the Ad5 and the ligand is generated by using an artificial interaction domain, the E-Coil/K-Coil. The K-Coil is inserted within the HI loop domain of the Ad5 fiber and its counter part, the E-Coil, is fused with a ligand of interest. The insulin-like growth factor-1, (IGF-1) recognizes the IGF-1 receptor (IGF-1R) expressed on many cell lines such as muscle. Indeed, we demonstrated expression of IGF-1R by western blot in C2C12 myoblasts and in myotubes. We also showed that it was expressed on normal and dystrophin deficient (mdx) mice by immunochemistry and by western blot. Therefore, to increase the transduction efficacy of AdV for muscle we constructed a bispecific ligand (IGF-E5) made of IGF-1 fused to five repeats of the E-Coil and to a His-Tag for protein purification. Binding of IGF-E5 to the fiber of an AdV encoding GFP and containing the K-Coil within the HI-loop (Ad5HIK5cDm/GFP) was shown by ELISA. Using flow cytometry we also demonstrated that IGF-E5 could increase the transduction efficacy of Ad5HIK5cDm/GFP by 16-fold in myoblasts. In the absence of ligand, the transduction efficacy of Ad5HIK5cDm/GFP was comparable to an AdV with wild type fiber. Importantly, incubation with recombinant IGF-1 did not increase the transduction of Ad5HIK5cDm/GFP in myoblasts. A 6-fold increase of GFP expression was also measured by western blot when myotubes were transduced at a MOI of 300 with Ad5HIK5cDm/GFP associated with IGF-E5.

144. An Alternate Method for Efficient Delivery of Catalyzing Enzymes

Andrew D. Fontes,¹ Rene Quintanilla,¹ Michael Poderycki,² Jon Chesnut,² Uma Lakshminpathy.¹

¹Primary and Stem Cell Systems, Life Technologies, Carlsbad, CA; ²Global Science and Innovation Office, Life Technologies, Carlsbad, CA.

We had earlier reported the development of integrase-based JumpIn platform for site-specific integration and stable expression of transgenes in human embryonic stem cells. This method utilizes vectors with special integrase recognizing sequences that facilitate the insertion of the construct carrying the transgene into the host genome catalyzed by the expression of the appropriate enzyme. Current methods utilize cotransfection of the integrational plasmid carrying the transgene of interest with the appropriate catalyzing enzyme expression vector. To overcome any adverse effect resulting from random integration of the catalyzing enzyme expression vectors into the host genome, we utilized a non-integrating transient expression system for delivery. BacMam, a baculovirus based gene delivery method is known to facilitate high efficiency gene transfer into hard-to-transfect cell types such as primary and stem cells. PhiC31 Integrase, R4 Integrase and NLS-Cre Recombinase were cloned into the BacMam vector and high titer virus generated. Expression of the Integrases and Recombinase was confirmed by qRT-PCR or immunochemical analysis of BacMam transduced HEK293 cells. Functionality was evaluated by the emergence of cells expressing a visual marker signifying successful reaction by the introduced enzymes. Our results indicate that catalyzing enzymes can be delivered at high efficiency via BacMam and the frequency of obtaining genetically modified cells is comparable or better than reaction catalyzed with plasmid DNA. Given the efficiency of BacMam to facilitate high efficiency gene transfer into adult stem cells such as mesenchymal stem cells and neural stem cells that are

refractory to prolonged genetic manipulation methods, this platform provides an option for extending the use of integrational methods of cells modification to cells with limited proliferation for rapid creation of labeled cells.

145. A Hypoxia and α -Fetoprotein-Dependent Oncolytic Adenovirus Exhibits Specific Killing of Hepatocellular Carcinomas

Oh-Joon Kwon,¹ Pyung-Hwan Kim,¹ Steven Huyn,² Lily Wu,² Minjung Kim,¹ Chae-Ok Yun.¹

¹Brain Korea 21 Project for Medical Sciences, Institute for Cancer Research, Yonsei Cancer Center, Severance Biomedical Science Institute, Yonsei University College of Medicine, Seoul, Republic of Korea; ²Molecular & Medical Pharmacology, School of Medicine, University of California, Los Angeles, Los Angeles, CA.

Purpose: Oncolytic adenoviruses (Ad) constitute a new promising modality of cancer gene therapy that displays improved efficacy over nonreplicating Ads. We have previously shown that an E1B 19-kDa-deleted oncolytic Ad exhibits a strong cell-killing effect but lacks tumor selectivity. To achieve hepatoma-restricted cytotoxicity and enhance replication of Ad within the context of tumor microenvironment, we used a modified human α -fetoprotein (hAFP) promoter to control the replication of Ad with a hypoxia response element (HRE). **Experimental Design:** We constructed Ad-HRE₆/hAFPD19 and Ad-HRE₁₂/hAFPD19 that incorporated either 6 or 12 copies of HRE upstream of promoter. The promoter activity and specificity to hepatoma were examined by luciferase assay and fluorescence-activated cell sorting analysis. In addition, the AFP expression- and hypoxia-dependent in vitro cytotoxicity of Ad-HRE₆/hAFPD19 and Ad-HRE₁₂/hAFPD19 was determined by 3-(4,5-dimethylthiazol-2-yl)-2,5-diphenyltetrazolium bromide assay and cytopathic effect assay. In vivo tumoricidal activity on subcutaneous and liver orthotopic model was monitored by noninvasive molecular imaging. **Results:** Ad-HRE₁₂/hAFPD19 exhibited enhanced tumor selectivity and cell-killing activity when compared with Ad-hAFPD19. The tumoricidal activity of Ad-HRE₁₂/hAFPD19 resulted in significant inhibition of tumor growth in both subcutaneous and orthotopic models. Histologic examination of the primary tumor after treatment confirmed accumulation of viral particles near hypoxic areas. Furthermore, Ad-HRE₁₂/hAFPD19 did not cause severe inflammatory immune response and toxicity after systemic injection. **Conclusions:** The results presented here show the advantages of incorporating HREs into a hAFP promoter-driven oncolytic virus. This system is unique in that it acts in both a tissue-specific and tumor environment-selective manner. The greatly enhanced selectivity and tumoricidal activity of Ad-HRE₁₂/hAFPD19 make it a promising therapeutic agent in the treatment of liver cancers.

146. Quantification of Wild Type Replicative Adenovirus Contamination That Results from Amplification of Conditionally Replicative Adenovirus

Eric J. Brown,¹ Julia Davydova,¹ Masato Yamamoto,¹ Selwyn M. Vickers.¹

¹Surgery, Basic and Translational Research, University of Minnesota, Minneapolis, MN.

Conditionally replicative adenoviruses (CRAd) are prized for their ability to selectively replicate within a target population of cells. However, a rare but unavoidable homologous recombination event during amplification of a vector in HEK 293 cells can reintroduce the native E1 sequence, thereby conferring non-specific replication to the virus. To ensure the safety of these viruses for clinical application, the level of contaminating wild type adenovirus (Wt) needs to be limited to a harmless level. Thus, the amount of contaminating Wt

in CRAd needs to be quantified. In the past, quantification methods have been predominantly biological in nature, resulting in tests that are less accurate and reproducible, and more costly and time consuming than physical measurement methods. The difficulty in specifically detecting contaminating Wt among a vast amount of CRAds stems from the need for primers that can detect the native E1 sequence of Wt, but not the promoter controlled E1 sequence of CRAds. Our goal is to develop a low-limit quantitative PCR method (qPCR) by which we may physically quantify the amount of Wt that results from the production of promoter-controlled CRAds. In order to detect contaminating Wt in cyclooxygenase-2 promoter (Cox2p)-driven E1 CRAds, 2 designs for each of 2 primer sets were constructed and tested to detect the presence of Wt E1 and Cox2p sequences, respectively. To test the limit of these primers, standards were created for the first design of each primer set and found to encode fragments too large (485bp Wt and 405bp Cox2p) for the cycling conditions of the qPCR assay. These sets did not show good linearity at lower copy numbers. A second design for each primer set was constructed, encoding shorter fragments (125bp Wt and 135bp Cox2p) and reproducibly detected a range of 10 to 10¹⁰ fragment copies. We wanted to ensure that our primers could detect Wt sequence in the presence of a high copy number of CRAd sequence, so we performed a "plasmid mixture test" by adding increasing copies of Wt encoding plasmid (0, 10, 100, 1000) to various amounts of Cox2p plasmid (10⁷, 10⁸, 10⁹, 10¹⁰). Wt sequence was undetected in the zero copy samples, while 10 copies were reproducibly detected in the 10 Wt / 1e10 CRAd samples, indicating sensitivity of at least 1 Wt in 10⁹ CRAd. To mimic the real-life scenario encountered after vector amplification, a similar test was performed by mixing Wt viral particles (VP) with CRAd VP at set ratios (virus mixture test). Wt was successfully and accurately detected at the ratio 175 VP Wt / 1.75x10⁹ copies COX2 CRAd, indicating an overall assay detection sensitivity of 1 Wt VP in 10⁷ CRAd VP or a 10⁻⁷ rate of contamination. The result of this work provides researchers with a less costly and more efficient manner to accurately detect Wt contamination that naturally occurs during promoter-controlled CRAd amplification.

147. Specific Modification of Hexon with 5KDa PEG Improves the Therapeutic Index of Helper-Dependent Ad Vector for Liver-Directed Gene Therapy

Francesco Vetrini,¹ Donna J. Palmer,¹ Nathan C. Grove,¹ Amanda Rosewell,¹ Florian Kreppel,² Philip Ng.¹

¹Molecular and Human Genetics, Baylor College of Medicine, Houston, TX; ²Gene Therapy, University of Ulm, Ulm, Germany.

Helper-dependent adenoviral vectors (HDAd) are effective for liver-directed gene therapy because they can mediate long-term transgene expression in the absence of chronic toxicity. However, high and thus potentially toxic doses are required to achieve efficient hepatocyte transduction due, in part, to vector uptake by Kupffer cells (KC). We have recently shown that specific modification of the Ad hexon with 5 KDa PEG results in significant improvement in hepatocyte transduction, which appeared to be mediated by evasion of KC uptake (PMID20959811). Given this encouraging result, further evaluation of the clinical potential of this technology is warranted. Thus, in this study, we investigated the duration of transgene expression and toxicity of 5 KDa PEG-HDAd following intravascular injection into mice. Our results revealed that 5 KDa PEG HDAd yielded 6-fold higher levels of transgene (AFP) expression compared to unmodified HDAd, and that transgene expression was sustained for at least 3 weeks.

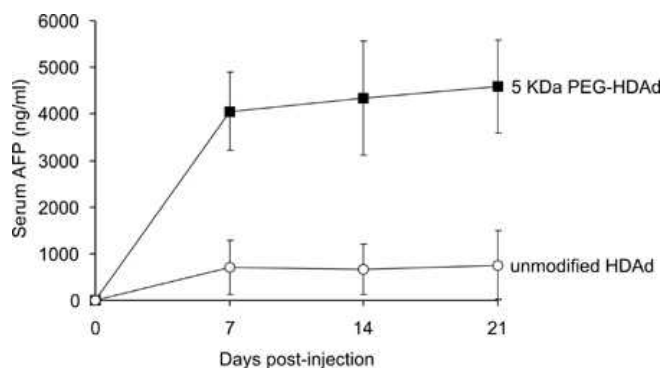

No differences in ALT, AST and IL-6 were observed between mice injected with 5 KDa PEG-HDAd or unmodified HDAd. However, 5 KDa-PEG HDAd resulted in reduced serum LDH elevation compared to unmodified HDAd, consistent with evasion of Kupffer cells. These results indicate that the therapeutic index of HDAd for liver-directed gene therapy can be improved by specific coupling of 5 KDa PEG to hexon.

148. Multi-Modal Imaging Reveals Sites of Cellular Reprogramming in Treatment of Type-1 Diabetes

Neil Phillips,¹ Mark Kay.¹

¹Departments of Pediatrics and Genetics, Stanford University, Stanford, CA.

Type 1 diabetes results from the autoimmune destruction of pancreatic β -cells. Traditional β -islet transplantation is severely hampered by the low availability of viable human islet cells and possibility of rejection. Currently, there are a number of strategies being pursued as therapies, including the expansion of β -cells from pluripotent stem cells and the induced pancreatic endocrine cell reprogramming of somatic cells. This work focuses on the latter approach, using an adenoviral (Ad) based therapy in a streptozotocin diabetes mouse model. We and others have used various pancreatic transcription factors (PTF), including Neurogenin-3 (Ngn-3), for delivery into the liver or pancreas to successfully treat STZ-induced diabetes in mice. A central issue that needs to be addressed in using cellular reprogramming to treat diabetes is that the new therapeutic cells must be different enough from normal β -islets that they escape autoimmune destruction. Following Ad-Ngn3 treatment, mice were partially resistant to a secondary round of STZ- diabetes, suggesting that it is possible to produce an Insulin-expressing, STZ resistant cell population. Subsequently, time-course studies indicate that reprogrammed cell populations undergo maturation, becoming more resistant to STZ toxicity as time progresses. Secondary exposure to STZ 25-weeks after the initial treatment round resulted in a delayed onset and reduced severity of diabetes (6 weeks to reach maximal blood glucose level of 449 mg/dL compared to 2 weeks to reach >600 mg/dL for controls). Although modest, we believe changes to the reprogramming treatment regime might enhance this effect. This data suggests that the reprogrammed cells are not identical to β -cells. We are currently attempting to recapitulate this effect in a genetic autoimmune model of diabetes allowing insight into whether reprogrammed cells could persist in diabetic patients. Further insights into the value of this approach await identification of the origin of the reprogrammed cells. To do this, we are using MIP (Mouse Insulin Promoter) -GFP and fLuc mice to track populations of reprogrammed cells over time using multiple imaging modalities. Coregistration of optical and X-ray data is allowing fine resolution mapping of cell populations actively expressing luciferase under conditions of normal health, induced diabetes and after Adv-PTF treatment. A parallel population of similarly treated MIP-GFP mice

allows for direct visual localization of these populations and for their sampling via micro-dissection. Microarray profiling of GFP positive, GFP-negative and control pancreatic tissue may reveal a number of important transcriptional similarities and differences between the groups. Use of confocal microscopy on thick tissue samples has allowed for the visualization of intact islets and their associated microvasculature in three dimensions, enabling the direct comparison of the micro-environment immediately around 'healthy wild-type' and 'induced/reprogrammed' islet structures. It is hoped that these findings will allow us to further refine our approach to using pancreatic transcription factors as an effective Type-1 diabetes gene therapy.

Chemical and Molecular Conjugates

149. T1 α Promoter-Mediated Gene Delivery into Alveolar Epithelial Type I Cells

Lynn F. Gottfried,¹ David A. Dean.¹

¹Pediatrics, University of Rochester Medical Center, Rochester, NY.

Nonviral gene delivery to the lung is a promising approach for the treatment of a various number of devastating diseases. However, its use has been limited, in part, by the lack of cell specific targeting of DNA. The alveolar epithelial type I (ATI) cell, in particular, is an attractive cell type to target, as it comprises 95% of the internal surface area of the lung. However, ATI-specific gene delivery studies have been limited due to a lack of understanding of the true transcriptional properties of these cells. We have developed a method for ATI-specific targeting of plasmid DNA through utilization of cell-specific DNA nuclear import sequences. We have previously shown that cell-specific nuclear import of plasmids in non-dividing cells is mediated by precise sequences of DNA that bind to cell-specific transcription factors in the cytoplasm and traffic the bound plasmid into the nucleus. We screened the promoters from several genes previously identified in the literature to be specific for or enriched in ATI cells for the ability to mediate DNA nuclear import in this specific cell type after cytoplasmic microinjection. The promoters of these genes were inserted into a plasmid lacking any other DNA nuclear targeting sequence, and the plasmids were labeled with a triplex-forming Cy3-PNA. Of the sequences examined, we demonstrate that only a DNA sequence within the rat T1 α promoter was able to mediate plasmid DNA nuclear import in primary rat ATI cells. When microinjected into other cell types, the T1 α promoter displayed no DNA nuclear import activity, suggesting that this sequence acts in a type I cell-specific manner. Promoter deletion analysis has further revealed the +101 to -200bp region as sufficient for nuclear import in ATI, and, surprisingly, in ATII cells. Promoter lengths beyond -200bp, however, exhibit no nuclear import activity in alveolar epithelial type I (ATII) cells, the transcriptionally distinct progenitors of ATI cells. Preliminary studies using site-directed mutagenesis of specific transcription factor binding sites within the promoter have revealed the potential significance of HNF3 binding in nuclear import in ATI cells and TTF-1 in ATII cells. Our data further demonstrates the presence of both of these transcription factors in ATI and ATII cells. This highlights a new property of the T1 α promoter as well as the ability to directly target the ATI cell over other cell types of the lung.

150. New Gene Regulation Delivery System Using Peptide-Pendant Polyethyleneimine for Cancer Cell-Specific Therapy and Imaging

Yoshiki Katayama,^{1,2,3} Riki Toita,¹ Leong-Hun Kang,¹ Takeshi Mori,^{1,2} Takuro Niidome.^{1,2}

¹Department of Applied Chemistry, Faculty of Engineering, Kyushu University, Fukuoka, Japan; ²Center for Future Chemistry, Kyushu University, Fukuoka, Japan; ³Innovative Center for Advanced Medicine, Kyushu University, Fukuoka, Japan.

Present gene therapy has a serious issue with its cell-specificity, since almost all the gene delivery methods have insufficient ability to specifically recognize the target diseased cells and distinguish them from normal cells. Recently, we proposed a novel concept for the target cell-specific gene therapy (drug or gene delivery system based on responses to cellular signals: D-RECS). In this concept, an intracellular signal that is specifically and abnormally activated in the target disease cells is used for the activation of transgene expression. We actually succeeded to create various gene regulator carriers consisting of polyacrylamide backbone and substrate peptide side chains. They can activate transgene in response to target intracellular signal such as PKA, PKC α , I-k-kinase, Src, Rho kinase, HIV protease, or Caspase-3. They all showed target cell specific gene expression *in vitro* or *in vivo*. Especially, PKC α -responsive system showed good performance for cancer specific therapy and imaging, because PKC α plays key roles in tumor cell differentiation and proliferation. However, it still required an improvement of signal responsibility and expression ability in cancer cells for practical use. Here we developed an improved PKC α -responsive gene regulator polymer as cancer-specific gene regulator by using polyethyleneimine (PEI) as the polymer backbone instead of polyacrylamide. The artificial gene regulator polymer enhanced 20 folds the level of gene expression in cancer cell. Signal (PKC α) responsibility was also increased 50-1000 times compared with that of conventional regulator in various cancer cell lines. Ability of gene suppression of this system was much stronger than that of ordinary system to improve the signal responsibility. This is very important for practical use, because complete suppression of therapeutic gene in non-target normal cells is crucial in our strategy. On the other hand, treatment of tumor cell with Nigericin which block endosomal escape of the gene complex dramatically suppressed the expression level in this system, while that in ordinary regulator system wasn't affected. This result indicated that the improved expression level in our new system was mainly caused by increased efficiency of endosomal escape of the gene complex probably due to the polyethyleneimine moiety. Newly synthesized our improved gene regulation carrier system will be useful for cell-specific gene therapy and imaging in practical use. We are going to apply this system to cancer gene therapy and functional imaging of tumor progression. References: 1) T. Tomiyama *et al.*, *J. Control. Release*, **148**, 101-105 (2010), 2) Y. Sato *et al.*, *J. Control. Release*, **143**, 344-349 (2010), 3) D. Asai *et al.*, *J. Control. Release*, **141**, 52-61 (2010), 4) R. Toita *et al.*, *J. Control. Release*, **139**, 133-139 (2009), 5) J-H. Kang *et al.*, *J. Am. Chem. Soc.*, **130**, 14906-14907 (2008), 6) J-H. Kang *et al.*, *Proteomics*, **8**, 2006-2011 (2008).

151. Gene Delivery to Oral Cancer Cells by Transferrin-Polyplexes and Tat-Peptide-Lipoplexes

Senait Gebremedhin,¹ Stephen Koons,¹ Krystyna Konopka,¹ Nejat Duzgunes.¹

¹Department of Biomedical Sciences, University of the Pacific School of Dentistry, San Francisco, CA.

Objective: Many oral squamous cell carcinoma (OSCC) cells are resistant to lipid-mediated transfection. We examined whether complexation of transferrin (Tf) with the cationic polyethyleneimine, JetPEI, or the combined use of the HIV-Tat cell penetrating peptide

and the cationic lipopolyamine liposome, Metafectene, enhances transfection of OSCC cells. Methods: HSC-3, H357 and H376 cells were maintained in DME, and H413 cells in DME/F12, both with 10% FBS. Cells were seeded in 48-well plates the day before transfection and used at approx. 70% confluency. Tf-polyplexes were prepared in two ways: (1) Tf and JetPEI were incubated for 30 min, and DNA (pCMV.luc plasmid) was added; (2) JetPEI and DNA were complexed for 30 min, and Tf was added. Tat-peptide-Metafectene complexes were prepared in different sequences. The condensation of DNA by the complexes was determined by PicoGreen fluorescence. The Alamar blue assay was used to determine cytotoxicity. The cells were treated with these complexes for 4 h and gene expression was measured 48 h later, using the Luciferase Assay System (Promega) and a Turner Designs 20/20 Luminometer. Results: Tf-polyplexes prepared by method (1), but not method (2), increased transfection in both H376 and HSC-3 cells. Tf-polyplexes enhanced gene expression by about 3-fold in HSC-3 cells lipofection-resistant H376 cells. Tf-polyplexes were slightly less toxic than plain polyplexes, despite the enhancement of transfection. Tat-peptide-lipoplexes produced variable enhancement of gene expression in HSC-3, H357 and H376 cells, but not in H413 cells. Tat-peptide-DNA complexes without Metafectene were ineffective in gene delivery. Conclusions: Tf-JetPEI polyplexes and HIV-Tat-Metafectene lipoplexes enhanced gene transfer to a number of OSCC cells, and may be useful in suicide gene therapy oral cancer.

152. Highly Effective Non-Viral Antitumor Gene Therapy System Comprising Biocompatible Small Plasmid Complex Particles

Chieko Yoshihara,¹ Tomoko Ito,^{1,2} Yoshiyuki Koyama.¹

¹Otsu Women's University, Tokyo, Japan; ²Musashino University, Tokyo, Japan.

Great efforts have been focused on developing the non-viral vector systems as safer alternatives to viruses. But the *in vivo* gene expression by those artificial vectors is strictly limited by the low delivery efficiency to the target cells. One of the major obstacles should be the adverse interaction of the complex with biocomponents. We developed an anionic polymer-coating on the complex particles, which re-charged the particles to negative, and effectively diminished the non-specific interactions. The other serious problem to the *in vivo* delivery would be too large size of the complex particles. We found that polyanion-coating stabilized the dispersion of the DNA/polycation complexes, and certain DNA/polycation/polyanion ternary complexes could be freeze-dried without aggregation or loss of gene transfection activity. It enabled the preparation of concentrated very small DNA complex suspension by preparing the complexes at highly diluted conditions, followed by concentration through the lyophilization-and-rehydration procedure. However, for the complex of plasmid with completely deacylated polyethyleneimine (PEI), which is known as a good transfection agent, loss of transfection activity could not be completely avoided by the polyanion-coating. Complex-preparation methods were then investigated in detail, and the small plasmid complex which can be lyophilized maintaining the size and activity was achieved under the precise conditions. Small plasmid complexes were then prepared with the PEI and the plasmids encoding cytokines or virus specific proteins, and explored for anticancer therapeutic potential with tumor-bearing mice. They showed significant therapeutic effect in mice after intratumoral injection, and complete disappearance of the tumor was achieved in 8 out of 8 mice without apparent toxic effect. Clinical study on primary tumor-bearing dogs and cats was then carried out, and evident suppression of the tumor growth was observed.

153. Characterization of Lipoplex Properties and Gene Transfer Efficiency of a Novel Family of Cationic Carotenoid Lipids

Natalia Bilchuk,¹ Matthew S. Adams,¹ Rachel Jones,² Alexandra M. Liberski,^{2,3} Christer L. Øpstad,³ Vassilia Partali,³ Hans-Richard Sliwka,³ Howard H. Lou,¹ Michael D. Pungente,² Philip L. Leopold.¹

¹Stevens Institute of Technology, Hoboken, NJ; ²Weill-Cornell Medical College-Qatar, Doha, Qatar; ³Norwegian University of Science and Technology, Trondheim, Norway.

Delivery of nucleic acids to cells can be facilitated by formation of complexes composed of negatively charged nucleic acids with a combination of cationic and zwitterionic lipids (lipoplexes). To help facilitate delivery of the DNA across the plasma membrane with release of the DNA in the cytoplasm, new cationic lipid structures are of ongoing interest. A novel family of carotenoid lipids composed of a positively charged head group with a rigid, 30 carbon polyene carotenoid tail and a flexible, fully saturated aliphatic tail ranging from 2 to 14 carbons in length (C30-2, -6, -12, or -14) were developed. Lipoplexes prepared from cationic carotenoid lipids at 0.5:1 to 5:1 charge ratios (positive to negative) were compared with well-characterized cationic lipids including the flexible 1,2-dioleoyl-sn-glycero-3-ethylphosphocholine (EPC) and the rigid, heterocyclic 3β[N-(N,N'-dimethylaminoethane) carbamoyl] cholesterol (DC-Chol) for complex formation, DNase protection, particle size, particle charge, gene transfer, and cytotoxicity. Cationic carotenoid family members C30-2 and C30-6 failed to produce consistent plasmid complexes. Nevertheless, C30-12 and C30-14 efficiently complexed DNA and protected it from DNase incubation at 5:1 molar ratios, yielding lipoplexes <400 nm in diameter and > 40 mV zeta potentials. At a dose of 0.38 - 0.61 μg lipid per 4 × 10⁵ cells (5 hour incubation in serum free medium during transfection), cells treated with lipoplexes exhibited a reduced mitochondrial reductase activity as assayed by conversion of tetrazole to formazan (MTT assay). Remaining mitochondrial reductase activity, which ranged 60 to 95% of the value in control cells 24 hours post-transfection, achieved levels comparable to that of EPC and DC-Chol (70 to 100% compared to controls). These lipoplexes yielded gene transfer levels 10 to 30% of that achieved by EPC and DC-Chol at the same time point. Notably, the C30 family of cationic carotenoid lipids formed lipoplexes and transferred genes with greater efficiency as the aliphatic tail length increased. Therefore, the characterization of new C30 carotenoid lipids with longer aliphatic tails will be of great interest. At present, cationic carotenoid family members C30-12 and C30-14 exhibit gene transfer characteristics that are comparable to the well-established EPC and DC-Chol reagents confirming that optimization of this family of cationic lipids is warranted.

154. Preparation of Hydroxyapatite Nanocapsule Including DNA/PEI/Hyaluronic Acid Ternary Complex for Durable Gene Delivery

Tomoko Ito,¹ Makoto Otsuka.¹

¹Research Institute of Pharmaceutical Sciences, Musashino University, Tokyo, Japan.

Gene therapy has been proposed as a novel strategy for the treatment of refractory disease. Viral vectors have been widely used as carriers to deliver the therapeutic nucleic acids efficiently to the target cells. However, viral vectors have risks such as random recombination and immunogenicity. As safer alternatives, non-viral vectors such as polycations or cationic lipids have been developed to mediate the gene transfection. The DNA molecules can electrostatically associate with those cationic reagents and form small particles. The complexes usually have positive charge on their surface, which invites an adverse interaction with blood components

or cells. We found that hyaluronic acid (HA) could deposit onto the DNA/polycation (or cationic lipid) complexes to recharge their surface to negative. DNA/polycation/HA ternary complex was highly biocompatible, and could be targeted to the malignant cells. HA-coating also improved the transcription efficiency of the DNA complex. Moreover, we found that the DNA/PEI/HA ternary complex could be freeze-dried without any cryoprotectant maintaining their gene transfection activity. It enabled the preparation of very small DNA complex particles with relatively high concentration. Injection of those finely dispersed suspension of the small DNA/polycation/HA complexes strongly suppressed the tumor growth in mice, and the small tumors completely disappeared. However, multiple injections of the complexes were required to achieve the satisfactory therapeutic effect, probably owing to the short duration of gene expression by such artificial vectors. On the other hand, a hydroxyapatite (HAp), which has similar inorganic components to bone and teeth, has been explored as a biodegradable and biocompatible drug-releasing devices. In this study, we developed a novel HAp nanocapsules including DNA/PEI/HA ternary complexes, and their durable gene expression was examined. Small DNA/PEI/HA complexes were prepared as reported before (Biomaterials, 31 (2010) 2912). They were added to a 1.5 times concentrated simulated body fluid (SBF). A SBF has a similar inorganic ion concentration to that of human blood plasma, and is supersaturated against hydroxyapatite. A thin apatite layer was then formed on the surface of the DNA complexes, being confirmed by X-ray diffraction and SEM-EDS analysis. The HAp nanocapsule including DNA/PEI/HA ternary complex showed evidently durable gene expression in B16 cells, and thus seems promising as a sustained-gene expression device.

155. Lipopolymer Mediated siRNA Delivery Strategy for Acute Myeloid Leukemia Cells

Breanne Landry,¹ Hamidreza Montazeri Aliabadi,¹ Hasan Uludag.^{1,2,3}

¹Chemical and Materials Engineering, University of Alberta, Edmonton, Canada; ²Pharmacy and Pharmaceutical Sciences, University of Alberta, Edmonton, Canada; ³Biomedical Engineering, University of Alberta, Edmonton, Canada.

Small interfering RNA (siRNA) therapy is a viable treatment strategy for patients with acute myeloid leukemia (AML). With current drug treatments, patients often suffer relapses, are unable to handle repeat treatments due to toxic side effects and are at risk of late-effects that occur years later. siRNA can be used to specifically target aberrant protein expression in transformed cells, to reduce proliferation and induce apoptosis. However, an efficient means to deliver siRNA must be developed, as they cannot transverse cellular membranes, due to their large molecular weight and negative charge, and are biologically unstable. Carriers to facilitate intracellular delivery of siRNA were developed in this study and delivered to AML cell lines (THP-1, KG-1 and HL-60) *in vitro*. Polyethyleneimine 2 kDa (PEI2) was substituted with the lipids caprylic acid (CA), palmitic acid (PA), oleic acid (OA), and linoleic acid (LA). Polymer:scrambled siRNA complexes were prepared at various polymer:siRNA ratios, and incubated for 30min/RT. Binding and dissociation of the complexes were determined by semi-quantitative EMSA. Increasing the polymer:siRNA ratio during complex formation resulted in increased siRNA binding for all polymers. In the presence of serum, no apparent dissociation was observed, however dissociation of complexes was observed as a function of heparin concentration; the PEI2/PEI2-lipids displayed more dissociation as compared to PEI25, in most cases. Morphology of complexes were visualized by TEM, where distinct, rounded complexes were observed (~100 nm). Cytotoxicity of the complexes on leukemia cell lines was determined after 24h treatment. As expected, PEI25 displayed high cytotoxicity, which increased with concentration. PEI2 displayed very low cytotoxicity

on the cell lines and lipid-modification did not increase cytotoxicity significantly. Carrier delivery ability was measured by flow cytometry/fluorescence plate reader after treatment with FAM-siRNA (Figure). PEI-lipid delivery in the leukemia cell lines was significantly higher than PEI25, considered the gold standard in non-viral nucleic acid delivery. Delivery varied depending on the type of lipid substituted, the level of substitution as well as cell type. PEI2-LA demonstrated the highest delivery in most cases and was most consistent between the different cell lines. Efficiency of complex delivery was determined by detection of delivered FAM-siRNA in cell lysates by plate reader, where PEI2-LA demonstrated the highest delivery concentration. Overall, the LA lipopolymers appear to be the most effective for siRNA delivery to AML cells. Future studies will focus on silencing efficiency with lipopolymers to probe a correlation between the efficacy and molecular features of the carriers.

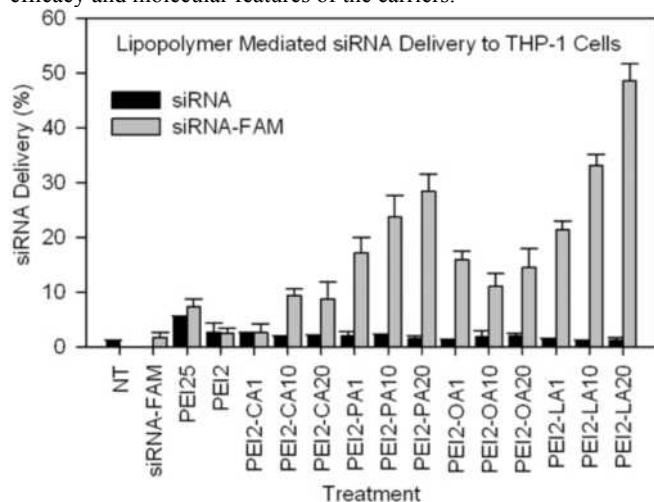

156. Development of Nanocomplexes for Targeted siRNA Delivery

Aristides D. Tagalakis,¹ Luisa Saraiva,¹ Stephen L. Hart.¹

¹Wolfson Centre for Gene Therapy of Childhood Disease, UCL Institute of Child Health, University College London, London, United Kingdom.

RNA interference induced by double-stranded small interfering RNA (siRNA) has attracted great attention as a genetic therapeutic approach for many diseases. Despite the major advances, systemic delivery of siRNA remains problematic. Non-viral, nanoparticle formulations, as developed over many years for plasmid delivery, offer opportunities for tissue-specific delivery of therapeutic siRNA reagents. Although plasmid DNA and siRNA delivery face many of the same challenges, there are important differences between them. Firstly, in electrostatic packaging, where siRNA is far smaller than plasmids, and secondly in the intracellular site of deposition where plasmids are required in the nucleus for gene expression and siRNA in the cytoplasm where the silencing machinery and mRNAs are localised. We are developing and optimising formulations for siRNA delivery and comparing them to gene delivery formulations. The formulations consist of a liposome DOTMA/DOPE (L) and a targeting peptide (K16GACYGLPHKFCG) (P) which self-assemble on mixing at optimal ratios with siRNA (R) into LPR nanocomplexes. Biophysical measurements indicated that LPR nanocomplexes were strongly cationic, spherical particles of less than 100 nm. These formulations packaged and protected siRNA on incubation with RNase with >90% intact siRNA recovery. LPRs with siRNAs against endogenous luciferase and GAPDH were successful in silencing these genes in 3 cell lines (1HAE0- airway epithelial, B104 rat neuroblastoma, Neuro2A-Luc Mouse neuroblastoma) in vitro with 80% efficiency at 100 nM siRNA, similar to Lipofectamine 2000

(L2K). LPRs containing liposomes with DOTMA, with an 18-carbon (C18) alkyl tail, were significantly better in silencing than its C14 and C16 homologues. A critical synergy was observed between the lipid and peptide components in terms of LPR particle stability and transfection efficiency. To evaluate targeting, transfections were compared with non-targeted LPRs containing K16 only (no ligand). Targeted formulations were more than 2-fold higher in all cell lines tested ($p < 0.05$). Fluorescently-labelled siRNA (Cy3) was incorporated into LPRs for fluorescence microscopy analysis. Confocal images at 30 minutes and 4 hours showed that the siRNA delivered within a LPR nanocomplex was located in the perinuclear region of the cytoplasm, where the RNA-induced silencing complex (RISC) is likely to be found, similar to results observed with L2K-transfected cells at 4h. The LPR formulations may have applications in vivo for the further development of siRNA-based therapeutics.

157. Designing DNA-Doped Biomineral Nanocomposites for Effective and Safe Gene Delivery

Bingbing Sun,¹ Hong Shen.¹

¹University of Washington, Seattle, WA.

Biomineral nanocomposites are capable of efficiently delivering DNA into a variety of cells. The efficiency of gene transfer is correlated with both the properties of cells and composition of nanocomposites. DNA delivered by either viral or non-viral delivery systems can potentially engage with intracellular DNA sensors and induce innate immunity. The induction of innate immunity results in unwanted inflammatory responses and/or shape adaptive immune responses against transgene products or DNA themselves. Towards the development of safe non-viral DNA delivery systems, it is critical to understand how the compositional and structural properties of non-viral DNA delivery systems affect the stimulation of intracellular DNA sensors. In this study, we first examined the stimulation of intracellular DNA sensors, including toll-like receptor 9 (TLR9), DNA-dependent activator of IFN-regulatory factors (DAI) and inflammasomes, by DNA doped in biomineral nanocomposites formed from a library of mineral solutions. We then correlated the degree of stimulation intracellular DNA sensors, with the composition and crystallinity of nanocomposites. Our results demonstrate that DNA doped in nanocomposites did not trigger TLR9 but stimulate both DAI and inflammasome in a composition-dependent manner. The degree of stimulation of DAI and inflammasome by DNA delivered by nanocomposites is highly correlated with ratio of cationic ions in nanocomposites. Together with our previous results, we demonstrate that both the efficiency and immunogenicity can be bioengineered through the rational design of materials.

158. Tumor-Directed Small Interfering RNA Delivery by Anti-EGFR Immunonanoplexes

Jung Seol Kim,¹ Yeon Kyung Lee,¹ Hwa Yeon Jeong,¹ Young Eun Shin,¹ Keun Sik Kim,² Yong Serk Park.¹

¹Biomedical Laboratory Science, Yonsei University, Wonju, Gangwon, Republic of Korea; ²Biomedical Laboratory Science, Konyang University, Daejeon, Republic of Korea.

RNA interference provides a powerful technology for silencing any functionally active protein within a target cell. Recently, small interfering RNAs as an anti-cancer reagent have been widely applied to treat varied types of cancers. However, efficient delivery of therapeutic siRNA molecules to cancer cells is a major obstacle unresolved yet. A great deal of effort has been spent to develop efficient transfection systems directed to tumor-associated antigens, such as epidermal growth factor receptor (EGFR). We prepared four different anti-EGFR antibody-conjugated nanoparticles (immunoliposomes, cationic immunolipoplexes, immunovirosomes

and cationic immunoviroplexes) for EGFR-specific siRNA delivery. Transfection efficiencies of the anti-EGFR immunonanoparticles were compared to each other and also to conventional cationic lipoplexes in varied cancer cells. Most of anti-EGFR immunonanoplexes exhibited efficient siRNA transfer to EGFR-positive tumor cells (A549 and SK-OV-3) and effective reduction of target gene expression in the target cells. Meanwhile, the same systems showed far less siRNA transfection to EGFR-negative cells (MCF-7 and B16BL6). We have undertaken a systematic anti-cancer therapy using the anti-EGFR immunonanoparticles containing two different types of anticancer siRNA in a mouse model carrying EGFR-positive A549 tumors. This study would provide an experimental proof for whether these types of EGFR-directed siRNA delivery system can be applicable for further preclinical and clinical studies.

159. Reducible Poly(Amido Ethyleneimine)s Affect Cellular Redox Potentials through Copper Mediated Enzymes

James W. Yockman,¹ Young Won Lee,¹ Jonathan H. Brumbach,¹ Katherine S. Blevins,¹ Zachary J. Robbins,¹ Sung Wan Kim.¹
¹Pharmaceutics, University of Utah, Salt Lake City, UT.

The generation of large molecular weight degradable polycationic polymers has been employed to circumvent toxicity while retaining superior transfection. Intracellular pH and reduction-oxidation potentials have been employed to such ends, but little has been demonstrated of their effects upon cellular processes. Here we demonstrate the effects of one group of reducible polymers, reducible poly(amido ethyleneimine)s (SS-PAEI's), upon reductive enzymes, toxicity, and transfection upon multiple cell lines. The SS-PAEI's were generated by Michael addition using cystamine bisacrylamide (CBA) and either boc-protected diaminohexane (DAH) or triethylenetetramine (TETA) to create CBA/DAH and TETA/CBA, respectively. Transfection efficiency of CBA/DAH and TETA/CBA was demonstrated to be comparable, if not superior, to bPEI25k in human A549 lung adenocarcinoma and HEPG2 with minimal toxicity. However, in human mesenchymal stem cells and Jurkat cell line the transfection and viability (analyzed via flow cytometry, alamar blue, and Mito-ID) were both significantly decreased in the SS-PAEI treated cells. In comparison, bPEI25kDa treated cells maintained transfection efficiency but demonstrated little toxicity even at high N/P ratios. Cellular viability was returned with addition of 125 nM N-acetyl cysteine or supra-normal levels of copper sulfate (2ug/ml), but only cells treated with copper sulfate increased transfection efficiency indicating changes in intracellular reductive/oxidative pathways. Reactive oxygen species were measured within the cells at 2.5 and 4.5 hours with significant increases ($p < 0.0001$ ANOVA) in ROS were shown at 2.5hrs and plateaued at 4.5hrs in all cell lines treated with SS-PAEI's compared to negative controls and copper treated cells. Cells treated with 2ug/ml copper sulfate did not see appreciable increases in ROS until 4.5hrs. The lower ratios of SS-PAEI's showed significant increases ($p < 0.0006$ ANOVA) in ROS early following transfection and peaked at 2.5hrs with increasing ratios peaking at 4.5hrs. The bPEI25kDa treated cells had slight increases in ROS across all time-points, albeit at levels lower than those of SS-PAEI's. This indicates that ROS generation may provide an intracellular kinetic analysis of polymer degradation and that the polyplexes are less stable at lower ratios, thereby contributing to its accelerated degradation and earlier ROS generation. Initial studies analyzing glutathione levels demonstrated a significant increase ($p < 0.0001$ ANOVA) in higher weight ratios of SS-PAEI's and all bPEI25kDa ratios tested that was abrogated by the addition of 2ug/ml copper sulfate. Superoxide dismutase (SOD) and catalase activity was assessed and significant increases in catalase were detected in increased weight ratios of SS-PAEI's with a concomitant decrease in SOD indicating that H₂O₂ may be responsible for increases in ROS

and its subsequent reduction upon copper sulfate addition. Here we have demonstrated that the use of bioresponsive polymers may alter the redox potential of cells upon treatment and their use should be approached cautiously.

160. EGFR-Mediated Gene Delivery Using Anti-EGFR Immunonanoparticles

Jung Seok Kim,¹ Yeon Kyung Lee,¹ Wha Yeon Jeong,¹ Young Eun Shin,¹ Keun Sik Kim,² Yong Serk Park.¹
¹Biomedical Laboratory Science, Yonsei University, Wonju, Gangwon, Republic of Korea; ²Biomedical Laboratory Science, Konyang University, Daejeon, Republic of Korea.

The epidermal growth factor receptor (EGFR) is a well known stable tumor-associated antigen widely expressed in various cancer cells. Therefore, it has been recognized as a therapeutic target molecule for cancer treatment. Various types of anti-EGFR antibodies (e.g. Cetuximab) have been developed to inhibit activation of the receptor, rendering tumor growth inhibition. Target-specific delivery of therapeutic genes has been always a primary concern in cancer gene therapy. In this study, we developed four different types of EGFR-targeted gene delivery system (immunoliposomes, immunovirosomes, cationic immunolipoplexes and cationic immunoviroplexes) for tumor-specific gene delivery. The anti-EGFR antibody-coupled nanoparticles showed selective binding and efficient pDNA transfection to EGFR-expressing tumor cells (A549 and SK-OV-3), but not to EGFR-negative tumor cells (MCF-7 and B16BL6). Their EGFR-mediated transfection efficiencies were further enhanced by pDNA condensation by protamine sulfate, a cationic polypeptide. Among the four systems, anti-EGFR immunoviroplexes exhibited the most efficient transfection to tumor cells over-expressing EGFR. Based on these in vitro studies, anti-EGFR immunoviroplexes and immunovirosomes containing two different anticancer genes (IL-12 and salmosine) were prepared and intravenously injected to mice carrying A549 tumors. The combined in vivo expression of IL-12 and salmosine genes mediated by the EGFR-directed transfection systems was able to effectively inhibit A549 tumor growth in mice.

161. Bioreducible Polymer Conjugated Cell Penetrating Peptides for siRNA Delivery

Hye Yeong Nam,¹ Sung Wan Kim,¹ David A. Bull.²
¹Department of Pharmaceutical and Biomedical Chemistry, University of Utah, Salt Lake City; ²Division of Cardiothoracic Surgery, University of Utah, Salt Lake City.

Primary cardiomyocyte specific peptide, PCM conjugated bioreducible polymer showed highly cardiomyocyte targeting ability in our previous report. For more enhanced transfection efficiency with targeting, we designed and synthesized new bioreducible polymer conjugated with both PCM peptide and Tat peptide. Tat sequence which is a cell penetrating peptide (CPP) known as key player for the cellular uptake of HIV-1 Tat peptide, was introduced to the PCM-CD to enhance the cellular uptake of siRNA. In order to investigate cardiomyocyte-targeted siRNA delivery into cardiomyocyte with better penetration, siRNA targeting SHP-1 or Fas gene was used. Recently, the Src homology domain 2 (SH2)-containing tyrosine phosphatase-1 (SHP-1) has attracted great attention because it plays an important role in apoptosis and a negative regulatory role in phosphorylation of Akt along with TNF- α and Fas. Therefore, silencing of SHP-1 or Fas expression with siRNA delivery may be expected to lead a reduced level of apoptosis under in vitro or in vivo ischemic condition. In our studies, we evaluated the potential of synthetic siRNA targeting SHP-1 or Fas to inhibit apoptosis of cardiomyocyte under in vitro hypoxic and serum-deprived conditions, using newly synthesized PCM-CD-Tat for siRNA delivery to the myocardium. The treatment of SHP-1 or Fas siRNA complex resulted in the increase of cell

viability and the reduction of LDH-cytotoxicity. In addition, the cells transfected with siRNA polyplexes demonstrated significantly lower percentage of apoptosis using Annexin V-FITC/PI staining. Because inherent toxicity from the immune stimulation of certain duplex siRNAs like the siRNA-induced interferon response, prior to *in vivo* application, the immunogenicity of new siRNA delivery systems was measured. Potential immune-stimulant, synthetic double poly(I:C) strongly induced IFN- α in PBMCs with polyplex system, but there was no detectable IFN- α stimulation with SHP-1 or Fas siRNA polyplex system. Based on these results, Fas or SHP-1 siRNA polyplexes may be safely used for cardiomyocyte-targeting delivery system without immune response. From these results, we proposed the Fas or SHP-1 siRNA/PCM-poly(CBA-DAH)-Tat polyplex can be a potential candidate for cardiomyocyte-targeted siRNA delivery system in the treatment of cardiovascular disease.

162. Polymeric Delivery of a Bone Morphogenetic Protein-2 Plasmid at Rat Subcutaneous Site

Laura Rose,¹ Cezary Kucharski,² Hasan Uludag.²
¹Biomedical Engineering, University of Alberta, Edmonton, AB, Canada; ²Chemical & Materials Engineering, University of Alberta, Edmonton, AB, Canada.

Introduction: Bone morphogenetic protein-2 is clinically used in fracture repair; however, large amounts of protein are needed due to fast clearance and short half-life *in vivo*. Gene delivery can circumvent these problems, and polymeric delivery vehicles are investigated for their potentially safer profile over viral systems. Specifically, 2 kDa polyethylenimine (PEI) modified with linoleic acid (LA; PEI-LA) or polyethyleneglycol (PEG; PEI-PEG) have been shown to be effective delivery vehicles *in vitro* and, in this study, we aim to show BMP-2 expression in an *in vivo* model after delivery of a BMP-2 expression plasmid. **Methods:** Complexes for physical characterization were prepared by mixing polymers with blank gWiz plasmid at a weight ratio of 5:2 (polymer:plasmid). Where indicated, polymer mixtures (PEI-LA and PEI-PEG) were used at a 1:1 ratio. Complexes were tested in the 293T cell line and primary skin fibroblasts grown in media with 10% serum and 1% penicillin/streptomycin. Cells were exposed to gWiz or gWiz-GFP complexes for 24 hours at 2 μ g of DNA/mL and trypsinized on day 2 for flow cytometry where untreated cells were set to 1% GFP positive. For *in vivo* studies, complexes with 50 μ g of BMP2-IRES-AcGFP or gWiz plasmid were soaked into gelatin sponges (1 cm x 1 cm) and implanted subcutaneously bi-laterally. Plasmid with no polymer served as a control. After 7 days, rats were sacrificed and sponges were harvested and transferred to a 24-well plate with media (10% serum, 1% P/S) for *ex vivo* culture. An enzyme-linked immunosorbent assay was used to detect BMP-2 in media from Day 3 and 5. **Results:** Plasmid complexes with PEI-LA or PEI-LA/PEI increased in size from ~380 nm 5 minutes after formation to 1200 nm after 60 minutes. Adding PEI-PEG to complexes gave a constant size of ~200 nm for 60 minutes. PEI-LA+gWiz-GFP complexes gave ~25% GFP positive in 293T cells while combinations of PEI-LA/PEI+gWiz-GFP and PEI-LA/PEI-PEG+gWiz-GFP gave ~40% and ~12% respectively. No GFP expression was found in groups with the gWiz complexes. In skin fibroblasts, there was no increase in the average fluorescence of the cells in groups with the gWiz plasmids, unlike cells treated with gWiz-GFP complexes that all showed an increase in the average fluorescence. BMP-2 secretion from sponges was detected when BMP-2 plasmid was delivered with PEI-LA and PEI-LA/PEI-PEG (1.3-2.5 ng/implant) on Day 3 but not afterwards.

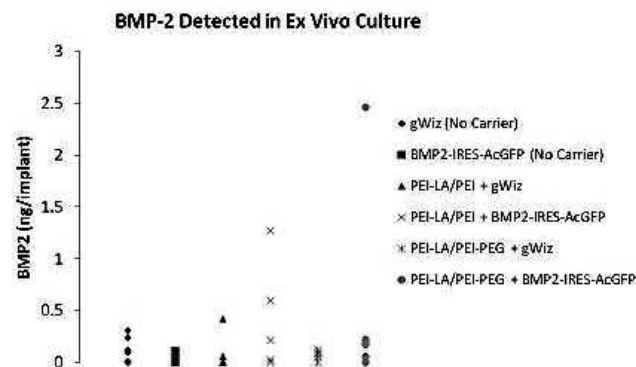

Figure 1: BMP-2 detected in media on day 3 of *ex vivo* culture of sponges.

Discussion: The inclusion of PEI-PEG in PEI-LA complexes led to particle size stabilization. Both PEI-LA/PEI and PEI-LA/PEI-PEG carrier combinations led to GFP expression in 293T and skin cells. Recombinant BMP-2 was detected following culture of the sponges following a 7 day subcutaneous implantation, albeit the level of secretion was relatively low. This study shows the feasibility of polymeric delivery of plasmid DNA to a subcutaneous site.

163. Developing Magnetic Nanoparticles for Targeted Nucleic Acid Delivery and Detection

Andrew M. Prantner,¹ Jun Chen,¹ Christopher B. Murray,¹ Nathalie Scholler.¹

¹University of Pennsylvania, Philadelphia.

Nonviral gene delivery using cationic polymers relies on the electrostatic condensation of nucleic acids to form polyplexes. The resulting polyplexes have a high positive charge density and interact with erythrocytes and intravascular macromolecules, which leads to rapid blood clearance and liver accumulation. The polymers can be modified with PEG to minimize interactions with blood components or specifically targeted using an affinity reagent to increase the local concentration at a particular site. However, modifying the polymers for immune evasion, molecular targeting, or imaging applications frequently reduces the ability to bind nucleic acids. We hypothesize that the large surface area of nanoparticles can be used to separate the targeting and nucleic acid binding domains and preserve the function of the cationic polymers. We further hypothesize that using superparamagnetic iron oxide nanoparticles (SPION) as a gene therapy vector will permit the *in vivo* distribution to be noninvasively monitored using magnetic resonance imaging (MRI). To test the *in vitro* targeting feasibility, we modified commercially available streptavidin-coated SPION, SA-SPION (MagCelect, 150nm diameter, R&D Systems), with site-specifically biotinylated antibody fragments, biobodies (Bb), to permit molecular targeting. The SA-SPION were functionalized with Bb that recognize either TEM-1 or mesothelin, two antigens that are upregulated in human ovarian cancer. *In vitro* validation of Bb-SA-SPION targeting, using antigen negative or antigen positive cell lines, was performed by flow cytometry and fluorescence microscopy. Targeted SPION specifically recognized the antigen positive cell lines with minimal or no nonspecific binding. The MRI detection of nanoparticles was demonstrated *in vitro* using a human ovarian cancer cell line, Ovar5, that expresses both TEM-1 and mesothelin. The MRI signal change, which is proportional to the amount of iron associated with the cells, correlated with cellular antigen levels measured by flow cytometry and RT-PCR. Although, the commercially available SA-SPION have been effective for method development and demonstrating *in vitro* targeting of tumor antigens, their relatively large size facilitates clearance by the reticuloendothelial system, which may hinder access

to extravascular tumor antigens and reduce the effectiveness of gene therapy. To address this issue, we next synthesized 10nm SPION and SPION containing either cobalt or manganese that lower the MRI detection limit compared with SPION. These smaller particles were successfully coated with a PEGylated phospholipid monolayer to provide a water soluble surface for attaching streptavidin for subsequent functionalization with biotinylated antibodies and nucleic acids using monobiotinylated polymers. Our findings indicate that SA-SPION can be specifically targeted using biotinylated antibody fragments and detected with MRI. In addition, small superparamagnetic nanoparticles, more suitable for intratumoral delivery *in vivo*, were successfully synthesized and optimized for solubility and functionalization. We propose that adding a nucleic acid binding function to the targeted SPION, will allow both targeted *in vivo* gene delivery and localization by MRI.

164. Acid-Transforming Polypeptide for Efficient, Targeted, and Molecularly Tunable Nonviral Gene Delivery

Min Suk Shim,¹ Young Jik Kwon.^{1,2,3}

¹Chemical Engineering and Materials Science, University of California, Irvine, Irvine, CA; ²Pharmaceutical Sciences, University of California, Irvine, Irvine, CA;

³Biomedical Engineering, University of California, Irvine, Irvine, CA.

Polypeptide-based nonviral gene carriers have attracted great attention due to their superior biocompatibility and facile functionalization by modulating amino acid sequences. However, gene delivery using poly-L-lysine (poly[Lys]), the most popularly utilized polypeptide-based nonviral carrier, has been hampered by limited buffering capacity, often necessitating co-administration of additional endosomolytic agents (e.g., chloroquine or fusogenic peptide). In this study, poly(Lys)-mimicking poly(ketalized serine) [poly(kSer)], where the hydroxyl group of serine was conjugated with an acid-cleavable amine-bearing ketal branch, was synthesized. The resulting poly[kSer] is designed to 1) enhance endosomal escape upon rapid hydrolysis of ketal linkages, 2) improve cytoplasmic release of nucleic acids via transformation of cationic poly(kSer) to neutral poly(Ser), 3) significantly lower cytotoxicity via reduced molecular interactions with endogenous genes. The PEG-poly(kSer) self-assembled with DNA formed acid-transforming micelles and significantly enhanced DNA release in the cytoplasm, resulting in much higher transfection efficiency than PEG-poly(Lys)/DNA micelles that exhibited limited intracellular DNA release. Cross-linking PEG-poly(kSer)/DNA micelles greatly improved serum-resistant DNA transfection, and cancer cell-targeted DNA transfection was also achieved after the acid-transforming micelles were tethered with folic acids. Additionally, effects of acid-degradability over DNA complexation on transfection efficiency were investigated by systemically varying the ratios of kSer and Lys residues. It was found that higher Lys to kSer ratios resulted in higher DNA complexation but DNA transfection efficiency was simultaneously reduced when the ratio was higher than 2. The results indicate that both acid-degradability and DNA complexation are required at a certain molecular balance for efficient transfection. This talk will demonstrate the high potentials of molecularly tailored acid-transforming polypeptides for efficient, biocompatible, targeted, and tunable nonviral gene delivery.

165. The Nuclear Pore Dilating Agent TCHD Increases Gene Transfer into Differentiated Airway Epithelium *Ex Vivo*, But Has No Effect *In Vivo*

Uta Griesenbach,^{1,2} Katherine M. Wilson,^{1,2} Raymond Farley,^{1,2} Cuixiang Meng,^{1,2} Ronald K. Scheule,³ Seng H. Cheng,³ Eric W. F. W. Alton.^{1,2}

¹Department of Gene Therapy, Imperial College, London, United Kingdom; ²The UK Cystic Fibrosis Gene Therapy Consortium, London, Oxford & Edinburgh, United Kingdom; ³Genzyme Corporation, Framingham, MA.

The nuclear membrane is a significant barrier to non-viral gene transfer into non-dividing differentiated airway epithelial cells. Trans-cyclohexane 1,2 diol (TCHD) is an amphipathic alcohol which has been shown to collapse the hydrophobic nuclear pore core and allow nuclear localization of macromolecules that would otherwise be too large for nuclear entry. Previous studies have shown that TCHD can increase lipid-mediated transfection *in vitro*. Here, we aimed to reproduce these *in vitro* studies using the cationic lipid GL67A which we are currently assessing in cystic fibrosis gene therapy trials and, more importantly, to assess the effects of TCHD on transfection efficiency in fully differentiated airway epithelium *ex vivo* and *in vivo*. TCHD (0.5-2%) dose-dependently increased Lipofectamine 2000 and GL67A-mediated transfection of 293T cells up to 2 logs. Encouragingly exposure to 8% TCHD, but not 0.5 or 2.0%, increased gene expression in fully differentiated human air liquid interface (ALI) cultures approximately 20-fold, although this was accompanied by significant cell damage. We then assessed the effects of TCHD *in vivo*. GL67A/pCIKLux complexes were administered to the lungs of mice by nebulisation and various concentrations of TCHD (0.4 to 10 %) were administered by nasal sniffing immediately pre-and post-nebulisation to ensure maximal exposure of the mice (n=8/group). In a separate set of experiments mice (n=8/group) were nebulised with GL67A/pCIKLux complexes followed immediately by nebulisation of 10% TCHD (maximum concentration that could be dissolved) for 1 hr. In a third set of experiments GL67A/pCIKLux was administered to the nasal epithelium by nasal perfusion over 15 min followed by nasal perfusion of 100 ml of 10% TCHD over 15 min (n=8 mice/group). This protocol ensured prolonged contact time between the airway epithelium and the compounds. None of the TCHD treated mice had higher gene expression when compared to no TCHD controls. In conclusion, although TCHD significantly increases gene transfer in cell lines and differentiated airway epithelium *ex vivo*, this effect is lost *in vivo* and further highlights, that promising *in vitro* findings often cannot be translated into *in vivo* applications.

166. Stimuli-Sensitive Copolymer Nanocapsules for Nontoxic and Efficient Non-Viral Gene Delivery

Min Sang Lee,¹ Yeon Lim Jang,¹ Myung Goo Kim,¹ Dai Phu Huynh,² Cong Truc Huynh,² Yuhan Lee,³ Su Young Chae,¹ Sun Hwa Kim,⁴ Tae Gwan Park,³ Doo Sung Lee,² Ji Hoon Jeong.¹

¹School of Pharmacy, Sungkyunkwan University, Suwon, Korea; ²Department of Polymer Science and Engineering, Sungkyunkwan University, Suwon, Korea; ³Department of Biological Sciences, Korea Advanced Institute of Science and Technology, Daejeon, Korea; ⁴Yonsei Integrative Research Institute for Cerebral & Cardiovascular Diseases, Yonsei University Health System, Seoul, Korea.

The majority of non-viral gene carriers have addressed these problems by forming nano-sized polyelectrolyte complexes via ionic interactions between a cationic carrier and a negatively charged genetic material. Since these complexes are usually generated as cationic nanoparticles, they often require further surface modification with hydrophilic polymers such as PEG for *in vivo* applications. The modification not only prevents non-specific adsorption of serum-

derived components to the complexes, but also increases the solubility and stability of the complexes in aqueous medium. However, the tightly-packed and stabilized complexes cannot be readily disassembled inside the cells, which may seriously affect the efficient access of plasmid DNA to cellular transcription machinery, resulting in limited gene expression. Gene carriers with additional mechanisms that facilitate the dissociation of the complexes exhibit significantly enhanced transfection. Nanogels, physically or chemically crosslinked hydrogel particles with a nanoscale size, have characteristics of both nanoparticles and hydrogels. The unique properties of nanogels, such as high loading capacity for various bioactive agents, thermodynamic stability favorable to systemic circulation, rapid responsiveness to external stimuli such as pH and temperature, and enhanced cellular uptake, provide advantages for pharmaceutical nanocarriers. In this study, a new biodegradable pentablock copolymer with a pH-responsive unit was synthesized and used as a nontoxic gene carrier. The pentablock copolymer (PAE-PCL-PEG-PCL-PAE) consists of a triblock copolymer (PCL-PEG-PCL) and pH-sensitive PAE blocks at both ends of the triblock core. At low pH (pH<6.0), the copolymer is protonated and able to interact with negatively charged plasmid DNA to form polyelectrolyte complexes. The hydrophobic PCL block provides the complexes with additional stability. Transition to neutral pH causes the deprotonation of the PAE blocks, leading to the formation of water-insoluble shells consisting of the PCL and PAE blocks. At the same time, the plasmid DNA can be localized in free form within the nano-sized capsule-like structure. The surface of the physically crosslinked nanocapsules is surrounded by the hydrophilic PEG segment, which may greatly improve the solubility and blood-serum compatibility of the nanocapsules. In addition, the unprotonated tertiary amines of the PAE blocks can absorb hydrogen ions in the endosome, which may facilitate the endosomal escape of the nanocapsules. This study assessed the possibility of using nanocapsules as a safe and efficient gene carrier for systemic gene therapy.

167. Non-Viral Gene Delivery with 25-kD PEI and G4 PAMAM Are Dependent on Active Clathrin and Caveolar Trafficking Pathways

Mark E. Hwang,¹ Rahul K. Keswani,² Daniel W. Pack.²

¹Bioengineering, University of Illinois, Urbana-Champaign, Urbana, IL; ²Chemical and Biomolecular Engineering, University of Illinois, Urbana-Champaign, Urbana, IL.

Polymer-DNA complexes present a non-immunogenic and inexpensive alternative to viral gene delivery. However, polyplex internalization and subsequent intracellular trafficking are key barriers to successful *in vitro* gene delivery. Clathrin- and caveolar-mediated endocytosis are two classes of pathway trafficking in eukaryotic cells that have been extensively researched in the past decade. We report the dependence of PEI and PAMAM plasmid gene delivery on clathrin- and caveolar- 1) uptake mechanisms, and 2) intracellular trafficking, using well-characterized endocytic inhibitors at various concentrations and polymer/DNA ratios in HeLa cells. Clathrin trafficking was inhibited with amantadine and chlorpromazine, and caveolar trafficking with genistein and methyl-beta-cyclo-dextrin. Supporting confocal microscopy experiments were performed to illustrate colocalization of polymer-DNA polyplexes with clathrin- or caveolin-tagged endocytic vesicles. Our polyplex uptake and gene delivery data elucidated polymer utilization of these two pathways at different degrees of endocytic inhibition, a parameter that has not been explored and accounts for seemingly inconsistent reports on the roles of clathrin and caveolar pathways in non-viral gene delivery. Results show that while 25 kD PEI and G4 PAMAM share similar biophysical properties, they exhibit different mechanisms of uptake and gene delivery. Most significantly, clathrin and caveolar trafficking are not mutually exclusive gene delivery pathways. They

demonstrate strong interdependence for successful trafficking to the nucleus, and polyplexes internalized by one pathway may be subsequently sorted into the other for successful gene delivery. Our data indicates that PEI-mediated gene delivery is dependent on both active clathrin and caveolar pathways. In contrast, G4 PAMAM uptake is heavily clathrin dependent, while gene delivery is caveolae dependent. Further, compensatory uptake mechanisms also exist that are activated when one mechanism is inhibited, potentially increasing cellular internalization of extracellular material even in the presence of an uptake inhibitor. We conclude that rather than relying on a single pathway for successful gene delivery, PEI and PAMAM polyplexes depend on a constant interplay between the clathrin and caveolar pathways in HeLa cells.

168. RhoGTPases Modulate Non-Viral Gene Delivery

Anandika Dhaliwal,¹ Maricela Maldonado,² Clayton Lin,² Tatiana Segura.^{1,2}

¹Biomedical Engineering Interdepartmental Program, University of California, Los Angeles, Los Angeles, CA; ²Chemical and Biomolecular Engineering, University of California, Los Angeles, Los Angeles, CA.

The main factor limiting the application of non-viral gene delivery systems in clinical therapies is efficiency. While recent studies indicate that the constituents of the cellular microenvironment influence non-viral gene transfer by modulating cell morphology, cytoskeletal dynamics and uptake pathways, the underlying mechanistic pathways that alter non-viral gene transfer have not been fully elucidated. Our previous research shows that transgene expression is increased on fibronectin (Fn) coated surfaces and inhibited on collagen I (CI I) coated surfaces. The actin cell cytoskeleton and clathrin-mediated endocytosis were found to play a role in the enhancement of gene transfer observed on Fn. RhoGTPases play an important regulatory role in cellular processes involving filamentous actin. To further elucidate the cellular mechanisms involved in gene transfer to mouse mesenchymal stem (mMSCs) and fibroblast (NIH/3T3) specifically on Fn, the role of RhoGTPases on gene transfer was investigated. The RhoGTPases were specifically inhibited using chemical inhibitors and dominant negative gene products, as well as activated to determine their role in gene transfer and internalization of DNA-polyethyleneimine (PEI) complexes. Inactivation of RhoGTPases significantly reduced the transgene expression in cells plated on Fn. Specific activation of Rac1 and Cdc42 did not influence the transgene expression in mMSCs, and increased the transgene expression by 4.3 and 2.1 fold respectively in NIH/3T3 cells plated on Fn. Furthermore, activation of RhoGTPases was able to rescue the transfection ability of mMSCs plated on CI I non-viral gene transfer. The specific activation of Rac1 and Cdc42 for mMSCs plated on CI I increased the transgene expression by 4.1 and 6.7 fold respectively. In conclusion, our study indicates that RhoGTPases play a significant role in the modulation of efficient delivery of non-viral vectors to mMSCs and NIH/3T3 cells.

169. Tailorable PNA-Based siRNA Nanoconjugates for Cell-Responsive Gene Silencing

Abbygail A. Palmer,¹ Millicent O. Sullivan.¹

¹Chemical Engineering, University of Delaware, Newark, DE.

The development of a small interfering RNA (siRNA) delivery vehicle designed to address the hierarchical nature of the gene delivery pathway may overcome the limitations in delivering siRNA therapeutics. The current study presents a modular system designed for site-directed delivery by introducing components for protection and targeting in a step-wise fashion. A multi-arm poly (ethylene

glycol) (PEG) serves as a scaffold for incorporating both siRNA and targeting molecules. SiRNA is tethered to this PEG scaffold via a peptide nucleic acid (PNA) clamp and a cathepsin L-cleavable linker peptide sequence. Cathepsin L is known to be upregulated in tumor cells and activated upon endosomal acidification, allowing for cell-responsive release of the siRNA payload. Further attachment of targeting/internalization peptides to the remaining unmodified arms of the multi-arm PEG allows for incorporation of additional functionalities into the siRNA-PNA-peptide (siRP) conjugates. This work focuses on the assembly and characterization of these scaffolds and investigates the effect of the cathepsin L-cleavable sequence on siRNA activity, as the siRPs are prepared using either the cathepsin L-cleavable sequence or a non-cleavable linker peptide. The assembly of the siRPs has been verified by matrix-assisted laser desorption ionization time-of-flight (MALDI-TOF) mass spectrometry and gel electrophoresis. We are currently exploring the activity of our siRP structures through *in vitro* cell transfection studies and Western blotting. This system will present a useful framework for exploring the activity and intracellular fate of siRNA.

170. Disrupted Adenovirus-Based Nicotine Conjugate Vaccine To Treat Nicotine Addiction

Bishnu P. De,¹ Martin L. Hicks,¹ Jonathan B. Rosenberg,¹ Amira Y. Moreno,² Kim Janda,² Stephen M. Kaminsky,¹ Ronald G. Crystal.¹
¹Weill Cornell Medical College, New York, NY; ²The Scripps Research Institute, La Jolla, CA.

Cigarette smoking is a common addiction with significant societal impact and current strategies to help smokers quit are ineffective with an 80% recidivism rate. Approximately 23% of all adults in the US smoke cigarettes, accounting for 1 of every 5 deaths in the USA. With the knowledge that nicotine is the principal addictive compound of cigarettes, we have developed a strategy for an anti-smoking vaccine based on adenovirus (Ad) gene transfer vectors. Based on the concept that Ad elicits robust humoral immunity, we hypothesized that an immune response could be targeted to nicotine via an Ad/nicotine-analog conjugate vaccine to evoke anti-nicotine antibodies that could sequester administered nicotine in the blood, preventing access to target receptors in the brain. To assess this hypothesis, the nicotine haptent AM1 was conjugated to a disrupted (56°C, 45 sec in 0.5% SDS) serotype 5 Ad gene transfer vector at Ad capsomere to AM1 conjugation ratios 1:100 or 1:300 to produce dAd5AM1-100 and dAd5AM1-300 conjugates, respectively. Western analysis showed effective conjugation of AM1 to the capsid proteins hexon, penton and fiber with higher AM1 incorporation in dAd5AM1-300, hence, the dAd5AM1-300 vaccine candidate was selected for further study. BALB/c mice immunized intramuscularly with non-conjugated Ad5 had no detectable serum anti-nicotine antibody ELISA titers whereas mice vaccinated with 4 µg dAd5AM1-300 elicited serum anti-nicotine antibody titers of $8.3 \times 10^5 \pm 1.4 \times 10^5$ at 11 wk post-vaccination. Competitive ELISA against BSA conjugated AM1 showed highest specificity to AM1, the vaccine analog, followed by nicotine, norm nicotine and cotinine. Antibodies in the serum of dAd5AM1-300 vaccinated mice had nicotine binding affinity of 74 nM. Intravenous ³H-nicotine challenge of vaccinated mice had a 57% reduction ($p < 0.001$) of nicotine to the brain with a 3.5-fold increase of nicotine sequestered in the serum ($p < 0.002$) compared to non-immunized controls. Of the ³H-nicotine retained in the serum, 60% was bound to serum IgG. dAd5AM1-300 vaccinated mice were evaluated for nicotine-induced behavior by open-field activity chambers. Daily nicotine challenges (0.5 mg/kg, subcutaneous) in Balb/c mice suppressed the locomotor behavior (naive + nicotine, 660 ± 190 cm compared to naive plus PBS, 1300 ± 70 cm, 97% reduction, $p < 0.007$), but in dAd5AM1-300 vaccinated mice, activity increased by day 3 and reached that of PBS challenged mice by day 6 (1190 ± 210 cm, 9% decrease to PBS mice, $p > 0.3$; 80% increase over

naive + nicotine, $p < 0.05$). Collectively, these data indicate that the high levels anti-nicotine antibody evoked by dAd5AM1-300 restrict nicotine access to the brain, can inhibit nicotine-induced behavior and suggest that conjugation of nicotine haptens to disrupted Ad may be an effective anti-smoking vaccine.

171. Transfection of Cells by RGD-Tagged PEGylated Lipid-DNA Nanoparticles in Serum

Chia-Ling Chan,^{1,2} Ramsey N. Majzoub,¹ Kai K. Ewert,¹ Keng-San Liang,² Cyrus R. Safinya.¹
¹Departments of Physics, Materials, and Molecular, Cellular and Developmental Biology, University of California, Santa Barbara, Santa Barbara, CA; ²National Synchrotron Radiation Research Center, Hinchey, Taiwan.

Cationic liposomes (CLs) are widely used to transfer DNA into cells for gene therapeutic or cell biological purposes, due to their low immunogenicity and toxicity, ease of scale-up procedures, and ability to transfer large pieces of DNA into cells. However, further improvement of these vectors is required for *in vivo* applications. Poly (ethylene glycol) (PEG)-lipids are commonly used to stabilize and extend the circulation time of liposomes. In the case of CL-DNA complexes, however, the steric shielding conferred by PEGylated lipids also screens the attractive electrostatic interaction between complexes and cell membranes, reducing transfection efficiency of the resulting nanoparticles. In order to overcome this problem, we have synthesized a PEG-lipid where the PEG chain acts as a tether for a linear RGD peptide, which mediates cell adhesion. We present work aimed at understanding how RGD-tagged PEG-lipids influence gene delivery, measuring transfection efficiency (TE) *in vitro* at different concentrations of serum as an initial model for *in vivo* gene delivery. We investigated the effect of lipid composition, addition of RGD-tagged PEG derivatives, and cationic lipid headgroup charge on the biophysical and biological properties of CL-DNA nanoparticles. Cryogenic transmission electron microscopy, dynamic light scattering, and small-angle X-ray scattering reveal that the addition of PEG-lipid stabilizes both the lamellar phase of complexes and their size in cell culture medium (e.g., DMEM) and under appropriate conditions in serum. PEGylation reduces TE, but RGD-tagged PEG lipids recover activity through an RGD-mediated enhancement of TE in the absence of serum. Furthermore, PEGylated complexes containing the custom-synthesized pentavalent lipid MVL5 exhibit lower toxicity and superior TE in a large operating window of lipid composition compared to the commercially available monovalent DOTAP. The neutral lipid also has a drastic effect on TE in serum. Our data for a range of lipids (both charged and neutral) with varying degrees of hydrophilicity has led to a new hypothesis regarding serum resistance of the TE of RGD-tagged PEGylated lipid-DNA nanoparticles which will be presented.

172. A "Soft Polyplex" of Oligoarginine-Grafted Polymers Affording a Protein Kinase-Responsive Gene Expression

Takeshi Mori,¹ Hiroyuki Tanaka,¹ Riki Toita,¹ Takuro Niidome,¹ Yoshiki Katayama.¹
¹Kyushu University, Fukuoka, Japan.

We have recently developed a gene expression system responding to intracellular signalings for a disease cell-specific gene therapy¹. In this system we have used hydrophilic neutral polymers grafted with cationic oligopeptides which are substrates of signal transduction proteins such as protein kinases and proteases. The polymers formed stable polyplex at physiological conditions due to the cationic charges of the grafted peptides. Interestingly, the grafted-peptides in the polyplex could be reacted efficiently with the signal transduction proteins irrespective of the electrostatic interaction with pDNA. In

order to reveal the mechanism of this unique character of the polyplex, we conducted herein the physicochemical characterization of polyplex of oligoarginine-grafted polymers with varying charge density and grafting density of the oligoarginine peptides.² We found that there are threshold values both in charge density and grafting density of the peptides to afford enzymatic reactions. The loose binding of the polymers to pDNA is essential for the protein kinase-responsive release of pDNA. 1) J.-H. Kang, et al, *J. Am. Chem. Soc.* 2008, 130, 14906. 2) R. Toita, et al, *J. Control. Release* 2009, 139, 133.

173. Directed Movement and Velocity of Transfected Plasmids Is Enhanced on Acetylated Microtubules

Melissa A. Badding,¹ David A. Dean.¹

¹*Pediatrics, University of Rochester Medical Center, Rochester, NY.*

Our lab and others have shown that in order for DNA to reach the nucleus during transfections, it must move along microtubules in the cytoplasm. In several studies looking at the effects of mechanical strain or cytoskeletal disruption by drugs, we found that populations of microtubules remain that are stable and post-translationally acetylated. We can increase levels of acetylated tubulin through inhibition of the tubulin deacetylase HDAC6, and this allows more rapid plasmid nuclear localization and greater levels of gene transfer. Using variations of an *in vitro* spin down assay with quantitative PCR and immunofluorescence, we previously found that plasmids bound to acetylated microtubules to a greater degree than they did to non-acetylated microtubules. To determine if cytoplasmic trafficking along microtubules is also affected by acetylation, plasmid movement was evaluated in real-time using cells with varying levels of acetylated microtubules (cells with HDAC6 either overexpressed or knocked-down). These studies involved cytoplasmic microinjections of fluorescently labeled DNA, followed by live cell plasmid tracking. We found that plasmids have greater net rates of movement in cells with highly acetylated microtubules compared to those with fewer modifications (0.183 m/second versus 0.108 m/second). Additionally, plasmid particles spend less time in diffusive motion when microtubules are highly acetylated (17% versus 32%), providing more time in directed movement. When the average plasmid run lengths were analyzed in the two cell lines, we found that plasmid DNA spends almost twice as much time in continuous movement on highly acetylated microtubules compared to under-acetylated microtubules. These results all suggest that plasmid DNA movement is enhanced along highly acetylated microtubules, which reduces the time spent in the cytoplasm prior to nuclear import allowing a better chance for gene expression. Taken together, these findings will provide a foundation for determining how modulation of microtubule acetylation can be used as a means to increase intracellular trafficking of plasmid DNA and enhance gene therapy.

174. Quantification of Intracellular Polyplex Distribution Via Subcellular Fractionation Techniques

Julie Shi,¹ Brian Chou,¹ David Chu,¹ Russell N. Johnson,¹ Suzie H. Pun.¹

¹*Department of Bioengineering, University of Washington, Seattle, WA.*

The most common methods for studying the intracellular trafficking pathways of polymer therapeutics are qualitative fluorescence microscopy and the use of the intracellular pathway chemical inhibitors. Subcellular fractionation has also been used in a few applications to quantify intracellular polymer distribution. The aim of this study is to establish a method for quantifying of intracellular polymer/DNA complexes (polyplexes) distribution via subcellular fractionation techniques and to use this method to better understand

trafficking of N-(2-hydroxypropyl)methacrylamide (HPMA)-peptide copolymers in HeLa and other cultured cell lines. Sufficient separation of organelle compartments using density-gradient subcellular fractionation was confirmed by marker enzyme assays and western blotting. Successful quantification of fluorophore-labeled polymer or quantum dot-labeled DNA in collected fractions was also confirmed. This method is now being used to assess the subcellular distribution of HeLa cells transfected with complexes of either polyethylenimine (PEI)/plasmid DNA or various HPMA-peptide copolymers/plasmid DNA.

175. Histone-Mimetic Polyplexes as Self-Activating and Tailorable Non-Viral Gene Delivery Vehicles

Meghan J. Reilly,¹ Millicent O. Sullivan.¹

¹*Chemical Engineering, University of Delaware, Newark, DE.*

Recent developments with non-viral gene carriers have focused on enhancing the effectiveness of gene therapies and improving understanding of the cell milieu and endocytic machinery. A novel solution to address inefficient non-viral DNA delivery is the development of biomimetic materials capable of regulating DNA accessibility and transcriptional activation. For example, recognition of the histone H3 tail trimethylated at lysine 4 by nucleosome remodeling factors has been implicated in chromatin activation. This work examines H3 tail peptides both with and without a trimethylated K4 for their potential as gene delivery materials. We have found that the H3 tail peptides, in combination with the helper cationic polymer poly(ethylenimine) (PEI), bind, protect, and release DNA. Dynamic light scattering and agarose gel electrophoresis were used to demonstrate that both H3 peptides condense DNA into nanoscale particles that were stable in the presence of serum nucleases. The H3-PEI hybrid polyplexes were found to transfect a substantially higher number of CHO-K1 cells *in vitro* compared to both polyplexes that were formed with only the H3 peptides and those that were formed with only PEI at the same total charge ratio. In addition, the PEI polyplexes exhibited a cytotoxic effect, whereas the H3-PEI hybrid polyplexes did not compromise cell viability. We have explored the observed synergies between the H3 peptides and PEI through the use of various chemical endocytic uptake and trafficking inhibitors, and have determined that the endocytic pathway plays a vital role in the fate of the polyplexes. Both the clathrin- and caveolar-dependent endocytic pathways contributed to polyplex uptake and gene expression, but caveolar-dependent endocytosis was the favored pathway for successful gene expression for both the H3-PEI hybrid polyplexes and traditional PEI polyplexes. The clathrin-dependent endocytic pathway was particularly unfavorable for the hybrid H3-PEI carriers, as gene expression increased in the presence of clathrin inhibitors when these hybrid carriers were used. These studies provide insight into the role various organelles (e.g., endosomes, caveosomes) and organelle-associated proteins (e.g., clathrin, caveolin-1) play for successful delivery of the H3-PEI conjugates to the nucleus. With this knowledge, we will be able to provide the framework for further innovation in the design of an efficacious non-viral vehicle.

176. Oligonucleotide-Conjugated Silver Nanoparticles for Photoactivated Gene Silencing

Paige K. Brown,¹ Ammar T. Qureshi,¹ Alyson L. Moll,¹ Daniel J. Hayes,¹ W. Todd Monroe.¹

¹*Biological & Ag Engineering, Louisiana State University and AgCenter, Baton Rouge, LA.*

We report the development of a silver nanoparticle-based platform for antisense oligonucleotide delivery and controlled gene silencing with light. We demonstrate a citrate-reduction based synthesis of 40-80nm silver nanoparticles which are functionalized with photolabile

DNA oligonucleotides via terminal thiol linkages. The singular photonic properties of these silver nanoparticle-oligonucleotide conjugates contribute to: ease of attachment verification, delivery confirmation, and in situ photo-activation of protected antisense cargo packed on particle surfaces. In vitro assays as well as fluorescent confocal microscopy of treated cell cultures demonstrate efficient UV-wavelength photoactivation of surface-tethered ISIS2302 antisense oligonucleotides possessing internal nitrobenzyl derivative linkers. As a demonstration of the advantages and utility of these nanohybrids we investigate properties such as: enhanced stability to nucleases, increased hybridization activity upon photorelease, and improved cellular uptake over traditional nucleic acid delivery approaches. The potential for this antisense nano-hybrid as a multicomponent delivery agent for tethered oligonucleotide therapeutics is shown through controlling the silencing of ICAM-1 (Intracellular Adhesion Molecule-1) expression in cells. Our results suggest a means to achieve light-induced, spatiotemporally-controlled gene silencing via non-toxic, UV-photo-activated silver nanocomposites, which could be beneficial for gene therapy and other nanomedicine applications.

177. Development of Peptide-Based HPMA-Copolymers for Nucleic Acid Delivery

Russell N. Johnson,¹ Dave Chu,¹ Julie Shi,¹ Suzie H. Pun.¹

¹Department of Bioengineering, University of Washington, Seattle, WA.

Efficient gene therapy with nonviral nucleic acid carriers has the potential to revolutionize the field of medicine and science; however, physiological barriers, such as stability in the extracellular matrix and escape from endosomes, have limited their use as a clinical treatment modality. Recently, our group has administered plasmids to mice by intraventricular injection using multifunctional PEI-PEG conjugates as gene vectors. These studies illustrated that multifunctional vectors can improve the delivery of genes in vivo to the central nervous system. The observed in vivo transfection efficiency also emphasized the need for more flexible delivery platforms that can access alternative conjugate architectures and designs, thereby facilitating more efficient nucleic acid delivery. In our current study, we present peptide-based gene delivery vehicles that are composed of peptide monomers copolymerized with N-(2-hydroxypropyl) methacrylamide (HPMA). This strategy is advantageous given endemic structural and biofunctional versatility of peptides and the stabilizing nature of hydrophilic polymers. Furthermore, a living polymerization technique was employed as a facile method of synthesis of well-controlled and high-yielding materials not possible with current bioconjugate techniques. The synthetic process included reverse addition-fragmentation chain transfer (RAFT) polymerization of HPMA with either a single functional peptide (L-lysine based DNA condensing monomer) or two functional peptides (L-lysine based DNA condensing monomer and L-histidine based endosomal lytic monomer), that could then be modified on the α - and ω -terminals of the polymers with additional functional peptides (targeting or endosomal lytic peptides) or a fluorophore for visualization and trafficking studies. Initial biological studies demonstrated that copolymers of HPMA and oligo-L-lysine peptides demonstrated transfection efficiencies that were orders of magnitude higher than poly-L-lysine (PLL) and approaching that of polyethylenimine (PEI). The HPMA copolymers additionally demonstrated salt stability necessary for in vivo studies without further modification, whereas PEG-modified PEI is salt stable but with diminished transfection efficiency compared with unmodified PEI. In more recent studies, additional peptides and peptide monomers have been studied as material components with an array of bioactivities and biofunctionalities. These “next-generation” peptide monomers included enzymatic degradable or reducible linkers

in their design to enhance biocompatibility of the vehicles. We have also included peptides with more potent bioactivity that should enhance the functionality and utility of the gene delivery vehicles.

178. Multifunctional Nanocarriers for Enhancing Suicide Gene Therapy

Jiesheng Wang,¹ Jen-I. Hsu,¹ Ching-An Peng.¹

¹Department of Chemical Engineering, Michigan Technological University, Houghton, MI.

Cancer is a leading cause of death worldwide. One approach scientists are using gene therapy to treat cancer is through suicide gene therapy. In such an approach, a cytotoxic drug converted from an enzyme-catalyzed prodrug. So far, delivery of the gene for an enzyme and the prodrug has been conducted via separate routes. That is, first the foreign gene is introduced into the targeted cancer cells and expressed as prodrug-activating enzyme, and the prodrug is administered afterwards. The prodrug is activated by the gene-expressed enzyme and converted to its cytotoxic form. In this study, we intend to develop a polymeric nanocarrier which contains both the prodrug (i.e., doxorubicin) and its activating gene (thymidine phosphorylase cDNA). Doxorubicin (prodrug of 5-fluorouracil) was used as the initiator directly in ring-opening polymerization of epsilon-caprolactone to form hydrophobic doxorubicin-poly(epsilon-caprolactone) (doxorubicin-PCL) which was further grafted with hydrophilic chitosan to fabricate amphiphilic polymer (doxorubicin-PCL-chitosan). Thymidine phosphorylase (TP) gene encoded plasmid was employed to form complexes with chitosan which is deployed on the outer surface of the self-assembled micellar nanoparticles made of doxorubicin-PCL-chitosan. The cleavage of the ester bond between doxorubicin and PCL in the presence of porcine esterase was confirmed by the kinetic release profile of doxorubicin from the polymeric micelles. After HT-29 colon cancer cells were targeted with such polymeric drug/gene nanocarriers, doxorubicin was converted into 5-fluorouracil by TP overexpressed via gene transfection in cancer cells. For comparison, methoxypolyethylene glycol (MPEG) was used to replace prodrug doxorubicin as the polymerization initiator to synthesize MPEG-PCL-chitosan polymeric micelles, form complexes with TP gene-encoded plasmids, and then treated with HT-29 cells. Our result showed that slowly released cytotoxic 5-fluorouracil in HT-29 cells treated with doxorubicin-PCL-chitosan nanocarriers led to significant cell death, while the control group based on MPEG-initiated nanocarriers revealed no cell death. Chemotherapy drug 7-ethyl-10-hydroxy-camptothecin (SN-38), an active water insoluble metabolite of irinotecan hydrochloride, was further encapsulated in the hydrophobic core of the polymeric drug/gene nanocarriers and treated with HT-29 cells. The effectiveness of such multifunctional drug/gene nanocarriers was extensively enhanced by synergistic anticancer activity of slowly released cytotoxic drugs (i.e., 5-fluorouracil and SN-38).

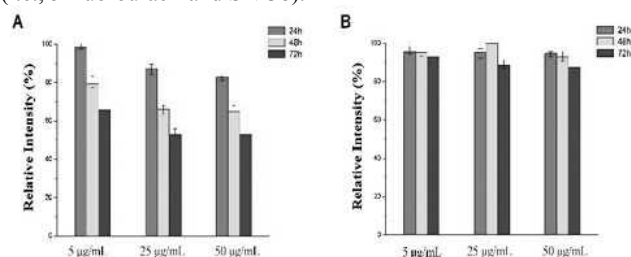

Figure 1. Antitumor activity of various amounts (5, 25, and 50 µg/mL) of (A) doxorubicin-PCL-chitosan nanoparticles (B) MPEG-PCL-chitosan nanoparticles complexed with TP gene-encoded plasmids (1 µg/mL), respectively. HT-29 cells (10^4 cells per well) were inoculated in a 24-well flat bottomed cell culture plate. Cell viabilities were determined at 24, 48, and 72 h post-inoculation using the MTT assay.

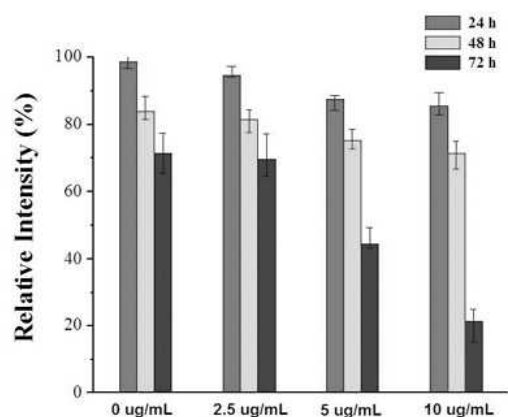

Figure 2. Antitumor activity of doxorubicin-PCL-chitosan/TP nanocarriers encapsulated with various concentrations (0, 2.5, 5, and 10 µg/mL) of SN-38. HT-29 cells (10^4 cells per well) were inoculated in a 24-well flat bottomed cell culture plate. Cell viabilities were determined at 24, 48, and 72 h post-inoculation using the MTT assay.

179. Enhanced Stability and Knockdown Efficiency of Poly(ethylene Glycol)-*b*-Polyphosphoramidate/siRNA Micellar Nanoparticles by Co-Condensation with Sodium Triphosphate

Masataka Nakanishi,^{1,2} Rajesh Patil,¹ Yong Ren,¹ Hai-Quan Mao.^{1,2,3}

¹Department of Materials Science and Engineering, Johns Hopkins University, Baltimore, MD; ²Translational Tissue Engineering Center, Johns Hopkins University, Baltimore, MD; ³Whitaker Biomedical Engineering Institute, Johns Hopkins University, Baltimore, MD.

Polyelectrolyte complex nanoparticles are a promising vehicle for siRNA delivery. However, this strategy suffers from low stability of these nanoparticles under physiological condition. Effective stabilization method is essential to success of polycationic nanoparticle-mediated siRNA delivery. In this study, sodium triphosphate (TPP), an ionic crosslinking agent, is used to stabilize siRNA-containing nanoparticles by co-condensation. The siRNA and TPP were co-encapsulated into a block copolymer, poly(ethylene glycol)-*b*-polyphosphoramidate (PEG-*b*-PPA), to form ternary nanoparticles. Physicochemical characterization was performed by dynamic light scattering and gel electrophoresis. Gene silencing efficiency in cell lines was assessed by dual luciferase assay system. The PEG-*b*-PPA/siRNA/TPP ternary nanoparticles exhibited high uniformity with smaller size (80 - 100 nm) compared with PEG-*b*-PPA/siRNA nanoparticles.

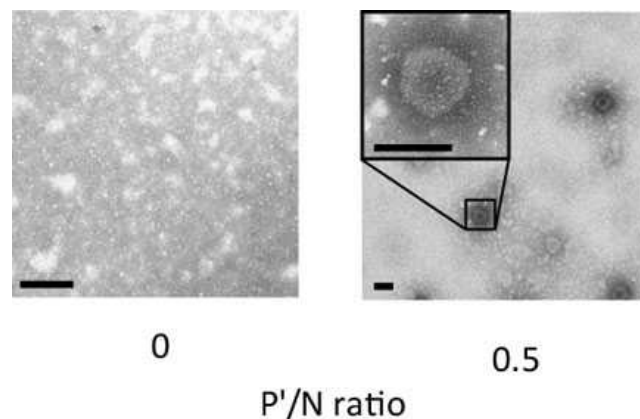

Figure 1. TEM images of PEG-*b*-PPA/siRNA/TPP ternary nanoparticles formed at P'/N ratios of 0 and 0.5 for N/P ratio of 4 (scale bar = 100 nm). N/P: [primary amine of PPA]/[phosphate of siRNA] P'/N: [phosphate of TPP]/[primary

These ternary nanoparticles showed increased stability in a solution with the physiological ionic strength, due to the stabilization effect from the ionic crosslinks between negatively charged TPP and cationic PPA segment. The transfection and gene silencing efficiency of these ternary nanoparticles increased with the TPP content and correlated well with their improved stability.

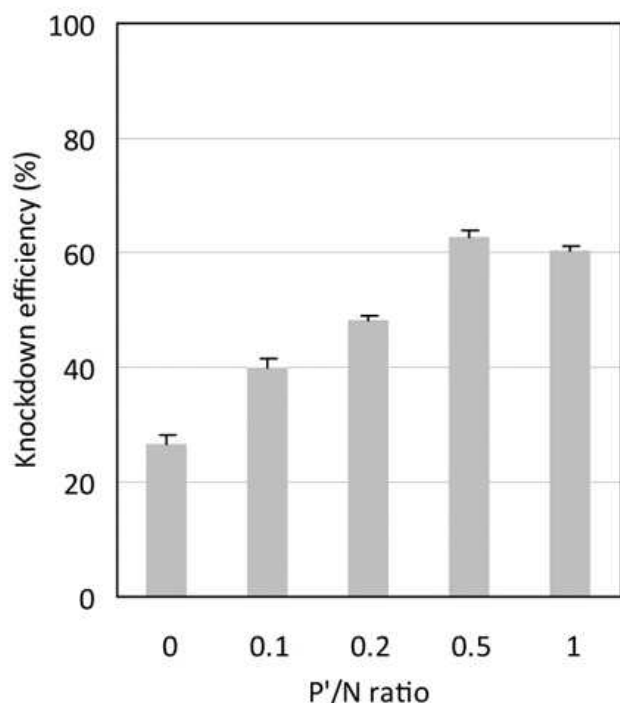

Figure 2. Gene silencing efficiency mediated by PEG-*b*-PPA/siRNA/TPP ternary nanoparticles at various P'/N ratios for N/P ratio of 4 in HeLa cells (siRNA dose of 100 nM). Values are expressed as mean \pm SEM (n = 4).

There was no significant difference in cell viability observed between nanoparticles prepared with and without TPP co-condensation.

180. Aromatic Self-Assembling Polyethylenimines Are Efficacious siRNA Delivery Reagents

Guy Zuber,¹ Benoit Frisch,¹ Gaëlle Creusat.¹

¹Laboratoire de Conception et Application de Molécules Bioactives UMR7199, CNRS - Université de Strasbourg, Illkirch, France.

Oligonucleotides are becoming valuable tools in biomedical research because they can be designed to bind in a highly selective manner to RNAs and interfere downstream at the protein expression level. However, oligonucleotides do not freely diffuse across the plasma membrane and rely on conception of synthetic delivery systems. We have previously reported that modification of branched 25 kDa polyethylenimine with tyrosine (PEIY) improves considerably its oligonucleotide delivery abilities. Mechanistic investigations led us to the hypothesis that the efficacy was related to the ability of the siRNA/PEIY complexes to be stable in extracellular media but unstable in the acidic endosomal environment. This allows an effective cell anchorage and cell internalization of the complexes into endosomes while favoring later siRNA release upon PEI-mediated endosomolysis and concomitant acidic environment-mediated disassembly of siRNA/PEIY complexes. In the present study, we verified the accuracy of our hypothesis by preparing other effective PEI-based siRNA carriers that do not contain tyrosine. Amines of commercially available polyethylenimines of 25 kDa or 1.8 kDa were first modified at a 30% extent (relative to ethylenimine) by reaction with succinimidyl ester of various aromatic compounds. After

purification and NMR analysis, the various polymers were evaluated for their properties to deliver siRNAs into a human glioblastoma cell line that was stably transfected to express a luciferase gene (U87Luc). Results showed several polymers to be as effective as PEIY for assisting selective siRNA-mediated luciferase gene silencing but with improved toxicological profiles. We also showed that the efficacious polymers share the same ability to form siRNA polyplexes that sustain the presence of heparin at pH above 7.4 but dissociate at pH 6.0. In conclusion, our results confirmed our initial hypothesis and open as well perspectives for in vivo administration.

181. Liver Targeted siRNA Delivery by Different Polymeric Carriers Containing Monosaccharide or Polysaccharide

Tetsuji Yamaoka,¹ Wakako Kamata,¹ Yoichi Tachibana,¹ Mariko Harada-Shiba,² Jeong-hun Kang.¹

¹Department of Biomedical Engineering, National Cerebral and Cardiovascular Center Research Institute, Suita, Japan;

²Department of Molecular Pharmacology, National Cerebral and Cardiovascular Center Research Institute, Suita, Japan.

Small interfering RNA (siRNA) based therapeutics are now attracting considerable attention in the treatment of not only the fatal diseases such as tumors but also chronic diseases or lifestyle-related diseases. However, naked siRNA is easily degraded in the blood, and then an efficient and stable siRNA delivery into the target cells or organs is of prime importance to reduce the cost and suppress the side effects. In the present study, two types of liver targeted non-viral carriers for siRNA with polysaccharide or monosaccharide molecules were designed and evaluated. We previously found that pullulan, which is a water-soluble polysaccharide consisting of three α -1,4-linked glucose polymers with α -1,6-glucosidic linkages, possess high affinity for the asialoglycoprotein receptor in the liver (Drug Delivery, 1993). Then a cationic segment, polyethylenimine (PEI), which is the most popular synthetic polymer were chemically conjugated to the pullulan side chain (pull-PEI). Another approach to design non-viral carrier is based on 6-o-vinyl adipoyl galactose (VAGal). VAGal monomer copolymerizes with various types of cationic vinyl monomers, and polycationic polymeric carriers with different compositions can be easily designed (DMGal). Apolipoprotein B-100 gene is one of the most known target genes for treating hyperlipoproteinemia, and then we used the following *ApoB* siRNA in the present study; 5'-GUCAUCACACUGAAUACCAAUdTdT-3' (sense) and 5'-dTdTTCACAGUAGUGUGACUUAUGGUUA-3' (antisense). The hepatocyte-targeted efficacy of these carriers and the reduction of Apo-B mRNA in the hepatocytes were evaluated in vitro and in vivo. After systemic injection of pull-PEI/siRNA complexes to mice, siRNA molecules quickly accumulated in the liver while PEI/siRNA complex localized in the lung. The siRNA distribution ration in liver/lung was increased as time in the case of pull-PEI/siRNA complexes. For the carriers with monosaccharide (DMGal), the optimum copolymerization composition of galactose monomer to the cationic monomer was found and the most effective one lead to the very quick siRNA delivery into the nuclei when evaluated in hepatocytes: NMuLi cells. By comparing the results with the control carrier DMGlu composed of cationic DM unit and control glucose unit, the quick intracellular siRNA trafficking was found to be in the receptor mediated manner. In addition, both types of the carriers effectively suppressed the degradation of the siRNA by RNase and lead to the suppression of ApoB expression in the hepatocytes. This work was supported by the Program for Promotion of Fundamental Studies in Health Sciences of the National Institute of Biomedical Innovation and Grants-in-Aid from the Research on Human Genome Tailor Made, the Ministry of Health, Labour and Welfare of Japan.

182. Cutaneous Gene Delivery Using Pyrene-Substituted Gemini-Lipid Nanoparticles

Mahmoud Elsabahy,¹ Ildiko Badea,² Ronald Verrall,² Marianna Foldvari.¹

¹*School of Pharmacy, University of Waterloo, Kitchener, ON, Canada;* ²*University of Saskatchewan, Saskatoon, Canada.*

Purpose: Localized scleroderma (morphoea) is an autoimmune connective tissue disease characterized by inflammation, fibrosis, vasculopathy and a deranged immune system. In vitro and in vivo studies showed that interferon (IFN)- γ , an inhibitor of collagen synthesis and an immunomodulator, reduces fibroblast collagen synthesis, induces the repression of fibroblast growth and improve the clinical signs of the disease [Rheumatology 48, 213 (2009)]. Topical application of IFN- γ gene can provide a more continuous supply within the skin more than the protein itself. Furthermore, it limits the systemic exposure and can be self-administered by the patients. We have previously shown that high levels of IFN- γ expression could be achieved in the skin of a mouse model of scleroderma (Tsk1/+) after non-invasive application of plasmid DNA (pDNA) coding for IFN- γ , using gemini surfactants-based nanoparticles [J Gene Med 7, 1200 (2005) and Eur J Pharm Biopharm 65, 414 (2007)]. The purpose of the current study is to examine the impact of the pyrene substitution of gemini surfactants on the in vitro and in vivo transfection of the gemini-lipid nanoparticles (GLN) aiming to improve nucleic acids delivery through the skin. **Methods:** 12-3-12 and Py-3-12 gemini surfactants have been synthesized as previously described [Langmuir 23, 8995 (2007)]. Plasmid vectors expressing td-tomato or GFP and IFN- γ were mixed with gemini surfactants, followed by addition of DOPE/DPPC lipid vesicles to form GLN. PAM212 murine keratinocytes were transfected with Lipofectamine PlusTM, jetPEITM and GLN and incubated for 3 h. Proteins expression and intracellular trafficking were investigated using Agilent Bioanalyzer 2100 and Zeiss LSM 710 confocal microscopy. In addition, the different gemini-based formulations were painted on shaved CD-1 and Tsk mice. Topically applied and intradermally injected naked pDNA were used as controls. Skin biopsies were collected 24-h after the treatment and proteins expression was examined by using BioplexTM 200 system and confocal microscopy. **Results:** Substitution of gemini surfactants with pyrene groups on their alkyl chains modified the characteristics of the nanoparticles, their cellular uptake and resulted in higher transfection efficiency both in vitro and in vivo in mice, as indicated by protein expression levels and confirmed by the confocal microscopy. Moderate expression of the reporter gene was observed with the intradermally injected skin and the skin treated topically with the 12-3-12 nanoparticles, while no expression was observed with the naked pDNA. Much higher protein expression was observed with the skin treated topically with the pyrenyl substituted nanoparticles. The higher efficacy of this formulation might be explained by the faster uptake and the efficient nuclear translocation of the carriers as confirmed by the transfection efficiency and confocal microscopy experiments. **Conclusion:** These novel constructs appear as a promising nanomedicine platform for topical gene therapy with potential applications for the treatment of cutaneous disorders such as scleroderma.

Genetic and Metabolic Diseases Gene & Cell Therapy I

183. Improved Chylomicron Clearance as a Marker for Long-Term Efficacy of Alipogene Tiparvovec (AAV1-LPL^{S447X} Gene Therapy) in LPLD Patients

Jaap Twisk,¹ Frederique Frisch,² Stephen Greentree,¹ Harald Petry,¹ Janneke de Wal,¹ Diane Brisson,³ Claude Gagné,⁴ André C. Carpentier,² Daniel Gaudet.³

¹*Research and Development, Amsterdam Molecular Therapeutics B.V., Amsterdam, Netherlands;* ²*Division of Endocrinology, Centre Hospitalier Universitaire de Sherbrooke, Sherbrooke, QC, Canada;* ³*Department of Medicine, Université de Montreal, Ecogene-21 and Lipid Clinic, Chicoutimi, QC, Canada;* ⁴*La Clinique de Maladies Lipidiques de Quebec, Quebec, QC, Canada.*

Introduction: Complete lipoprotein lipase deficiency (LPLD) is caused by homozygous or compound heterozygous mutations in the *LPL* gene. As a consequence, triglycerides (TG) cannot be hydrolyzed and TG-rich chylomicrons (CM) accumulate in the circulation. Clinical manifestations of LPLD include recurrent and life-threatening pancreatitis. Gene therapy for LPLD constitutes a one-time intramuscular administration of alipogene tiparvovec (AAV1-LPL^{S447X}). Experiments in LPL-deficient mice and cats have demonstrated dose-dependent LPL expression, plasma TG reduction and resolution of chylomicronemia (Ross, 2004 & 2006). Clinical trials with alipogene tiparvovec and AMT-010, its predecessor, in LPLD patients led to persistent intramuscular expression of LPL protein mass and activity, significant reduction of plasma TG, and a decrease in pancreatitis frequency. In the third clinical trial, additional markers of efficacy were included to further elucidate the mode of action in LPLD patients. **Methods:** 5 LPLD patients were administered alipogene tiparvovec (1×10^{12} genome copies per kg, IM). Before and 14 and 52 weeks after gene therapy, patients were given a test meal supplemented with [³H]-palmitate tracer, to specifically monitor the handling of newly-formed CM particles in the circulation during the postprandial phase. **Results:** Postprandial CM handling was poor in all patients prior to therapy: total [³H]-tracer accumulated in plasma over 9 hours following intake of the test meal. The majority of tracer was found in the lipoprotein fraction representing large, buoyant CM. In contrast, after therapy the amount of [³H]-tracer recovered from the CM fraction was greatly reduced, and in each case the [³H]-tracer within this CM fraction was eliminated completely and well within 9 hours. The effect was consistent (found in all subjects analyzed) and sustained (observed both at the 14 week and 52 week time points). **Conclusions:** Alipogene tiparvovec administration to LPLD patients improved CM handling, in particular that of the CM fraction representing large buoyant CM, as measured at 14 weeks and 52 weeks after administration of alipogene tiparvovec. Given the central role of LPL in CM metabolism, improved CM handling is taken as an (indirect) measure of increased systemic LPL activity following a one-time administration of alipogene tiparvovec. The improved postprandial handling of particularly larger CM can also be used to explain the observed reduction in pancreatitis.

184. Pharmacological Immunosuppression Fails To Improve the Outcome of AAV-Based Liver Gene Transfer in Non-Human Primates

Carmen Unzu,¹ Sandra Hervás-Stubbs,¹ Ana Sampredo,¹ Itsaso Mauleon,¹ Uxua Mancheño,¹ Carlos Alfaro,¹ Rafael Enriquez de Salamanca,² Alberto Benito,³ Ignacio Melero,¹ Antonio Fontanellas.¹

¹Gene Therapy and Hepatology Area, Centre for Applied Medical Research (CIMA), Pamplona, Navarra, Spain; ²Research Center, Hospital Universitario 12 de Octubre, Madrid, Spain; ³Departement of Radiology, Clínica Universitaria de Navarra, Pamplona, Navarra, Spain.

Adeno-associated vectors (rAAV) have been engineered to attain long-term liver gene transfer. Porphobilinogen deaminase (PBGD) haploinsufficiency (acute intermittent porphyria) benefits from gene transfer of hepatocytes in mouse models and clinical trials are about to begin. In humans, the cellular immune response poses a serious obstacle for transgene persistence while neutralizing humoral immunity curtails re-administration. In the present work, using macaca fascicularis primate model we have studied the feasibility of repeated gene transfer with intravenous rAAV5 vectors under the effects of an intensive immunosuppressive regimen that was designed to block T and B-cell mediated adaptive immune responses. Successful liver gene transfer following the intravenous injection of 1e13 rAAV5-hPBGD gc/kg was confirmed by quantification of plasmid vector DNA in liver biopsies performed 15 days after vector administration. A control macaque developed cellular and humoral immunity against viral capsids but not towards the intracellular transgene product. Two macaques received a combination of mycophenolate mofetil (MMF), anti-thymocyte immunoglobulin, tacrolimus and rituximab in such a way that anti-AAV immune responses were abolished during 12 weeks but rebounded following cessation of the immunosuppressants. Persistence of viral antigens in circulation due to poor clearance in the absence of antibodies against the viral capsids underlies the rebound. Subsequent gene transfer with a rAAV5 vector encoding enhanced green fluorescent protein was impossible even in a macaque in which the intensive immunosuppression regimen was given again. Hepatic PBGD expression in terms of enzymatic activity, mRNA and protein levels were measured at sacrifice, 25 weeks after the rAAV5-hPBGD administration. Enhanced transgene expression was only observed in one of the macaques, which actually had received immunosuppression only around the first rAAV administration. Results in mice indicate that MMF decreases rAAV-encoded transgene expression in the liver via a paradoxical mechanism that critically involves a functional adaptive immune system. In conclusion, intravenous delivery of rAAV5 activates humoral and T cell responses to capsid antigens in macaques despite of the strong immunosuppressant protocol. Moreover, a MMF-dependent drug-mediated interference with transgene expression took place via an elusive effect exerted on the adaptive immune system as investigated in experiments performed in mice.

185. Pre-Existing Neutralizing Antibodies to AAV Capsids in Large Animals Other Than Monkeys May Confound In Vivo Gene Therapy Studies

Roberto Calcedo,¹ Judith Franco,¹ Qiuyue Qin,¹ Dean W. Richardson,² Jeffrey B. Mason,² Surina Boyd,¹ James M. Wilson.¹
¹Gene Therapy Program, Department of Pathology & Laboratory Medicine, University of Pennsylvania, Philadelphia; ²Department of Clinical Studies, New Bolton Center, School of Veterinary Medicine, University of Pennsylvania, Philadelphia.

Critical to the success of gene therapy is the availability of animal models that accurately predict outcomes in humans. One factor

that influences safety and efficacy of in vivo gene transfer is prior exposure to viruses that are similar to the virus used to create the vector which can lead to activation of B cells and production of neutralizing antibodies (Nab). Viruses of the parvovirus family, of which AAV is a member, cause natural infections in many species including humans, monkeys, pigs, dogs and horses. Pre-existing Nabs to AAV vectors were not felt to be a problem in non primate models because their endogenous parvoviruses were believed to be structurally distinct from primate AAVs. To confirm this hypothesis we evaluated the prevalence of Nab to AAV capsids used to make vectors (i.e., AAV1, AAV2, AAV5, AAV6 and AAV8) in non primate animal models commonly used in gene therapy pre-clinical studies including horses, dogs and pigs. A large number of serum samples were screened for Nab in an in vitro transduction inhibition assay. Remarkably high rates of seroprevalence were noted. In horses, AAV5 is the most seroprevalent AAV serotype with 100% of the samples positive for Nab; low or no Nab to other AAV serotypes were found. In dogs, AAVs 1 and 6 were the most seroprevalent AAV serotypes with 100% of the samples positive for Nab; no Nab were detected to other AAV serotypes. In pigs, we found that AAV5 again was the most seroprevalent AAV serotype with 100% of the samples positive for Nab; seroprevalence of Nab to AAV1, AAV2 and AAV8 ranged from 30 to 47%. While AAV6 was the least seroprevalent AAV serotype with only 6% of the samples positive for Nab. Several serum samples from horses, dogs and pigs, that were positive for AAV Nab by the in vitro assay, were also analyzed by an in vivo assay in which sera from individual animals were passively transferred into mice before intravenous injection of a vector generated with the capsid of interest as follows: AAV5 for horses, AAV1 for dogs and AAV8 for pigs. The data showed that in vivo AAV transduction in recipient mice was completely inhibited or substantially diminished by sera that scored as positive by the in vitro transduction inhibition assay. These studies suggest careful screening of all large animal models for pre-existing Nab when designing pre-clinical studies.

186. Impact of Pre-Existing Neutralizing Antibodies on AAV8-Mediated, Liver-Directed Gene Transfer and Vector Biodistribution in Nonhuman Primates

Lili Wang,¹ Roberto Calcedo,¹ Peter Bell,¹ Jianping Lin,¹ Rebecca Grant,¹ Don L. Siegel,² James M. Wilson.¹
¹Gene Therapy Program, Department of Pathology & Laboratory Medicine, University of Pennsylvania, Philadelphia; ²Department of Pathology & Laboratory Medicine, University of Pennsylvania, Philadelphia.

Vectors based on adeno-associated virus (AAV) are being evaluated in pre-clinical and clinical models such as those involving liver-directed gene therapy. The major challenges to date have been related to host immune responses and poor transduction efficiency due to limited vector tropism and poor delivery of the vector to the target cell. Improved transduction efficiencies have been achieved with second generation vector technologies such as novel AAV serotypes, engineered AAV capsids, or self-complementary genome. Much is being learned about host vector interactions such as the role of innate immunity and activation of T cells and B cells to the vector and its transgene product. Natural infections with related AAVs activate memory B cells that produce antibodies capable of modulating the efficacy and safety of the vector. We have evaluated the biology of AAV8 gene transfer in macaque liver with a focus on assessing the impact of pre-existing humoral immunity. Twenty one macaques with varying levels of AAV neutralizing antibody (NAb) were injected intravenously with AAV8 vector expressing GFP. Pre-existing antibody titers in excess of 1:10 substantially diminished hepatocyte transduction which, in the absence of NAbs, was highly efficient. Vector-specific Nab diminished liver deposition of genomes and

unexpectedly increased genome distribution to spleen. The majority of animals showed high level and stable sequestration of vector capsid protein in follicular dendritic cells (FDCs) of splenic germinal centers. Altered vector biodistribution and stable sequestration of vector capsid protein in FDCs were also reproduced in mice received passive transfer of human IVIG or were pre-immunized with AAV8 vector. These studies illustrate how natural immunity to a virus that is related to a vector can impact on the efficacy and potential safety of in vivo gene therapy. These findings provide important data for designing future clinical trials.

187. Comprehensive Integration Site Analysis of One New Gene Therapy Vector AAV-rDNA

Zhongya Wang,¹ Hiroyuki Nakai,² Markus Grompe.¹
¹Oregon Stem Cell Center, Oregon Health & Sciences University, Portland, OR; ²The Department of Microbiology and Molecular Genetics, University of Pittsburgh School of Medicine, Pittsburgh, PA.

We have previously reported that an AAV vector containing rDNA homology is more efficient at integration than conventional AAV. Integration efficiency was at least 10 times higher than regular AAV vectors in two human disease murine models as well as human cell lines. Prior to any clinical application, several issues need to be addressed: Is the integration pattern of AAV-rDNA vectors site-specific or random? What are the exact chromosomal locations of AAV-rDNA mediated integration and are there any chromosomal consequences, e.g. chromosomal deletion, accompanying AAV-rDNA mediated integration? To thoroughly analyze these issues, a shuttle vector rescue strategy was used. We have constructed a shuttle vector: pAAV-rDNA-ori-PGK-Gb2-neo, which encodes the following elements between 2 rDNA arms of the AAV-rDNA vector: 1) a hybrid promoter driving the neomycin/kanamycin resistance gene which combines a prokaryotic promoter (gb2) for expression of kanamycin resistance in *E. coli* with a eukaryotic promoter (PGK) for expression of neomycin resistance in mammalian cells; a poly(A) signal derived from the human β -globin gene, and 3) a plasmid origin of replication (Ori), which allows replication of the shuttle vector in bacteria. A human version, pAAV-hrDNA-Ori-PGK-Gb2-neo was also designed and the functionality of the rescue vectors has been tested in a human cell line. AAV8 was made and injected into WT 129 svj mice at two different doses: high dose, 3×10^{11} and low dose, 10^{10} . After rescuing AAV-rDNA mediated integration sites, preliminary data has suggested that AAV-rDNA vectors have different integration patterns than regular AAV vectors, which have been reported to integrate into random genome location with preference in the actively transcribed chromosome regions.

188. Relationship between Neutralizing Antibody and Factor IX Expression in Non-Human Primates Following IV Administration of AAV8 Vectors

Hiroaki Mizukami,¹ Jun Mimuro,² Akira Ishiwata,² Hiroya Yagi,¹ Tsukasa Ohmori,² Seiji Madoiwa,² Tomonori Tsukahara,¹ Masashi Urabe,¹ Akihiro Kume,¹ Yoichi Sakata,² Keiya Ozawa.¹
¹Div. of Genetic Therapeutics, Center for Molecular Medicine, Jichi Medical University, Shimotsuke, Japan; ²Div. of Cell and Molecular Medicine, Center for Molecular Medicine, Jichi Medical University, Shimotsuke, Japan.

Adeno-associated virus (AAV) vectors are promising in gene therapy approaches especially for hemophilia. In order to evaluate utility of AAV vectors in hemophilia gene therapy, we have been working on preclinical studies using cynomolgus macaques. Earlier results indicate the efficacy of AAV8-based vectors in transducing macaque liver by intravenous injection. Nonetheless, inhibitory

actions of pre-existing neutralizing antibody (NAb) against vector capsid, even at marginal levels, are also concerned, suggesting the necessity of more sensitive assay for NAb detection. To solve this issue, we have improved NAb detection system against AAV8 capsid through augmenting infection steps. Based on this assay, 6 sero-negative male cynomolgus macaques were selected. AAV8-based vector encoding mutant macaque factor IX driven by liver-specific promoter was injected into saphenous vein at $2 \sim 5 \times 10^{12}$ vg/kg, which are relevant vector dose in human trials. Five out of 6 animals exhibited robust and sustained factor IX expression at the therapeutic window (3.0 ~ 20.2% of normal). Among animals showing positive results, no differences were found in factor IX concentration by the vector dose; high copy numbers of vector genome (12.9 ± 1.3 vg/dge) were also detected in the liver biopsy specimen. One animal, which did not show expression, turned to be sero-positive during 11 months of stay in the original colony, suggesting acquired infection within the facility. Our results indicate a prospect of hemophilia gene therapy using AAV8 as well as the sufficient sensitivity of our improved NAb assay, which would be useful in human clinical trials using AAV vectors. This study was performed in collaboration with Tsukuba Primate Research Center, National Institute for Biomedical Innovation, and The Corporation for Production and Research of Laboratory Primates, Japan.

189. Development of a Clinical HIV-Based SIN Vector Encoding a High-Expression Factor VIII Transgene for the Treatment of Hemophilia A

Christopher B. Doering,¹ Gabriela Denning,² Robert Moot,¹ Jennifer Johnston,¹ Jordan Shields,¹ Boro Dropulic,³ H. Trent Spencer.¹

¹Pediatrics, Emory University School of Medicine, Atlanta, GA; ²Expression Therapeutics, Tucker, GA; ³Lentigen, Gaithersburg, MD.

Hemophilia A results from mutations in the gene that encodes coagulation factor VIII (fVIII). We have shown that transplanting hematopoietic stem cells genetically modified with retroviral vectors encoding a high-expression fVIII transgene cures the bleeding phenotype and restores systemic fVIII levels in hemophilia A mice. High level *in vivo* fVIII expression was achieved by cloning high expression elements of the porcine sequence into human fVIII, thus generating a human/porcine chimeric transgene that preserves 90% of the human sequence. Now, we have completed optimization of a clinical SIN lentiviral vector in regards to fVIII expression, safety and effectiveness. The contribution of a WPRE element was shown to be negligible with respect to viral titer, transduction efficiency, transcriptional read through, and fVIII expression. Therefore, this element was removed from the final construct. In contrast to recently published data showing a codon optimized version of human fVIII enhanced expression, codon optimization did not enhance expression of the chimeric construct. Based on these and previous optimization studies, a clinically processed HIV-based SIN vector with an eF1-alpha promoter and chimeric fVIII transgene was produced with a titer of 2×10^7 and tested using human hematopoietic cell lines, human bone marrow CD34⁺ cells and mobilized peripheral blood CD34⁺ cells. Transduced K562 cells expressed greater than one unit of fVIII activity/ 10^6 cells/24 hours, which is consistent with results using research grade centrifuge concentrated vector, and transduction had no effect on cell growth. Clinically processed HIV vector encoding eGFP was used to optimize transduction of human CD34⁺ cells. Highly reproducible transductions of greater than 35% CD34⁺ cells was achieved when cells were transduced at an MOI of 50 twice over a period of 18 hr in cytokine containing growth medium. Transduction of mobilized peripheral blood human CD34⁺ cells with the clinically processed vector encoding the fVIII transgene did not affect cell growth in semisolid medium or liquid cultures. Copy number analysis

of cultured cells for three weeks after transduction were comparable to eGFP transduced controls, and *in vitro* fVIII expression was observed during the first week of culture, which was the timeframe of analysis. Gene-modified human CD34⁺ cells were transplanted into sublethally irradiated NSG mice. Measurement of fVIII expression in NSG mice is complicated by the expression of endogenous mouse fVIII, thus an ELISA assay was developed to measure expression of the chimeric protein in these mice, which is currently ongoing. These results show that a high-expression fVIII-encoding HIV SIN vector can be produced under clinical conditions and the resulting vector efficiently transduces primary human hematopoietic stem and progenitor cells resulting in high level fVIII expression, which further validates the use of the chimeric construct in clinical gene therapy trials for hemophilia A.

190. Gene and Cell Therapy for Hemophilia B Using Adipose Tissue-Derived Stem/Stromal Cells Transduced with a Self-Inactivating SIV Lentivirus Vector

Natsumi Watanabe,¹ Kazuo Ohashi,¹ Kohei Tatsumi,¹ Rie Utoh,¹ Kazuko Kanegae,¹ Yuji Kashiwakura,² Tsukasa Ohmori,² Yoichi Sakata,² Makoto Inoue,³ Mamoru Hasegawa,³ Teruo Okano.¹
¹Institute of Advanced Biomedical Engineering and Science, Tokyo Women's Medical University (TWIns), Tokyo, Japan; ²Reserach Division of Cell and Molecular Medicine, Center for Melocular Medicine, Jichi Medical University School of Medicine, Tochigi, Japan; ³DNAVEC Corporation, Tsukuba, Ibaraki, Japan.

Background: Adipose tissue-derived stem/stromal cells (ADSCs), also known as adipose tissue-derived mesenchymal stem cells (AT-MSCs), are considered to be an attractive cell type to treat genetic and non-genetic disorders. One example is hemophilia B, which is a hereditary bleeding disorder caused by lack of biologically active coagulation factor IX (FIX). Methods to prophylactically treat hemophilia B has yet to be effectively developed. The present study describes the feasibility of using an integrating simian immunodeficiency virus (SIV) vector system to produce sustained expression of FIX in the ADSCs to treat hemophilia B. **Methods and results:** Adipose tissues were isolated from the inguinal region of male FIX-KO mice (8 weeks old) followed by enzymatic digestion using collagenase. The stromal-vascular fraction was collected by centrifugation and cultured in DMEM/F12 with 10%FBS. Adhered and proliferating cells were trypsinized for subculturing (defined as passage 1). The sub-cultured cells were defined as mADSCs. Flow cytometric analysis confirmed the mADSCs surface profiles: CD29+/CD44+/CD90+/CD31-/CD45-. We also checked the bipotency of the mADSCs *in vitro* by inducing osteogenic and adipogenic differentiation assessed by Alizarin Red S and Oil Red O staining, respectively. SIV vectors expressing EGFP under control of CMV promoter (SIV-CMVp-EGFP) or human FIX gene (SIV-CMVp-hFIX) were generated. mADSCs at passage 2 transduced with SIV-CMVp-EGFP vector showed nearly complete transduction efficiency by flow cytometric analysis 3 days after infection. EGFP-transduced mADSCs were cultured on temperature-responsive culture dishes that enable harvesting cells with intact surface proteins by incubation below 32°C, for ~20 min, and recovering of cell sheets. Subcutaneously transplantation in syngeneic mice resulted in successful engraftment of mADSC-EGFP sheets. mADSCs at passage 2 transduced with SIV-CMVp-hFIX, could produce hFIX at a concentration of ~1000 ng/ml/48h in the culture medium. Clotting activity of this culture medium was investigated and ~2.3% of activities were detected. **Conclusion:** The present study describes that ADSCs can be generated and expanded from the adipose tissues of hemophilia B mice. Furthermore, *in vitro* experiments confirmed that the SIV-mediated hFIX gene transduced ADSCs could express and secrete biologically active hFIX. In all, gene transduced ADSCs could be a valuable cell

source for establishing a cell and gene therapy toward the treatment of bleeding disorders, including hemophilia B.

191. Optimizing Engraftment of FANCA Gene-Modified Bone Marrow Cells in a Mouse Model of Fanconi's Anemia

Jennifer E. Adair,¹ Xin Zhao,² Pamela S. Becker,² Hans-Peter Kiem.^{1,2}

¹Clinical Research Division, Fred Hutchinson Cancer Research Center, Seattle, WA; ²Department of Medicine, University of Washington, Seattle, WA.

Engraftment of gene-corrected cells is a major hurdle for gene therapy in Fanconi Anemia (FA) patients. We previously developed a lentiviral vector encoding the *FANCA* gene for use in a pending clinical trial of gene therapy for FA patients. We have also reported on the successful transduction and phenotypic correction of FA patient bone marrow (BM) cells using this vector in an overnight transduction protocol under conditions to reduce oxidative damage, including hypoxic culture (5% O₂) with reducing agent. Here we evaluated engraftment of *FANCA* lentivirus transduced BM cells in *fanca*^{-/-} mice without conditioning (Control), with Cyclophosphamide (Cy) conditioning, or non-alkylating agent conditioning. Regimens included Control, Cy alone (120 mg/kg), cytarabine (A) alone (1000 mg/kg), or A combined with fludarabine (A+F; A-300 mg/kg daily x3, F-200 mg/kg daily x3). We performed two types of experiments: (1) transplant of *fanca*^{+/-} mouse BM cells transduced with a GFP-encoding lentivirus into *fanca*^{-/-} recipients, and (2) transplant of *fanca*^{-/-} cells transduced with a *FANCA* expressing lentivirus vector into *fanca*^{-/-} recipients. In both experiments, following transplantation, *FANCA* gene-modified cells were selected *in vivo* with Cy (120 mg/kg). Gene marking was determined by flow cytometry and/or PCR-based methods in both bulk white blood cell (WBC) populations and methylcellulose colonies. In Experiment 1, the Cy group displayed the most efficient engraftment in 3/3 mice with GFP⁺ WBCs by day 35 (range 2.6-52.7% GFP⁺), compared to 2/5 mice in the other groups (range <1-5.6% GFP⁺). *In vivo* selection by Cy increased WBC marking across all groups, the highest being the Cy group (range 24-77% GFP⁺ WBCs). Sensitivity of colony forming cells to MMC [20nM] correlated well with gene marking, and genotyping PCR confirmed that provirus⁺, MMC-resistant colonies were heterozygous. In Experiment 2, 4/5 Cy group mice displayed engraftment of *FANCA* gene-modified WBCs (range 0.14-0.53 provirus copies per cell) whereas 1/5 mice in the A group displayed detectable marking (0.05 provirus copies per cell) by day 35. Selection increased WBC gene marking across all groups, the highest being the Cy group (5/5 mice, range 0.42-1.3 provirus copies per cell). Colony growth was equivalent across all groups without MMC; however, there was a significant difference in MMC-resistance between the Cy group (44.6 ± 28.3 colonies/plate) and the Control (4.8 ± 1.7, p=0.014) or A (5.4 ± 6, p=0.031) groups. Colony PCR confirmed BM marking in transplanted mice and corresponded with MMC [20nM] sensitivity. Importantly, no cytogenetic abnormalities were observed in BM cells of Cy-treated mice in either experiment. These data demonstrate engraftment capability of *FANCA* gene-modified cells using a clinical grade lentivirus vector and suggest Cy will be an optimal preparative regimen in a clinical setting of gene therapy for FA patients.

192. Mozobil-Alone or Mozobil+G-CSF Significantly Improve the Mobilization Efficiency of Thalassaemic Mice: Implications for Human Gene Therapy of Thalassemia

Evangelia Yannaki,¹ Nikoleta Psatha,^{1,2} Eleni Sgouramali,^{1,3} Evangelia Athanasiou,¹ Eleftheria Tsolaki,^{1,3} Minas Yiangou,^{1,3} Minas Arsenakis,^{1,2} Athanasios Fassas,¹ Achilles Anagnostopoulos.¹
¹Gene and Cell Therapy Center, Hematology-BMT Unit, George Papanicolaou Hospital, Thessaloniki, Greece; ²Medical School, Department of Genetics, Development and Molecular Biology, Aristotle University, Thessaloniki, Greece; ³School of Biology, Department of Genetics, Development and Molecular Biology, Aristotle University, Thessaloniki, Greece.

We have previously shown that splenomegaly in thalassaemic mice contributes to a less efficient G-CSF-mobilization compared to normal C57Bl6 strain, mainly because of the increased trapping of hematopoietic stem cells in the enlarged spleen. In this study, we investigated whether the novel mobilizer, Mozobil (Mzl), either alone or in combination with G-CSF, could improve the mobilization efficiency of thalassaemic mice (HBBth-3). HBBth-3 mice received G-CSF or Mzl or their combination. Hematopoietic tissues (blood, bm, spleen) were collected and the absolute numbers of Lin-sca-1+ckit+ cells (LSK) and CFU-GM were calculated based on their frequency (by FCM and clonogenic assays) and in relation to the individual cell count/tissue. Mzl-alone resulted in lower splenic enlargement and increased numbers of circulating CFU-GM as compared to G-CSF ($p=0.01/p=0.009$, respectively). The Mzl+G-CSF combination caused spleen size increase comparable to G-CSF, whereas it further improved mobilization over the G-CSF- and Mzl-treated groups, in terms of blood LSK ($p=0.03/p=0.06$, respectively) and CFU-GM ($p=0.02/p=0.06$, respectively). Mzl peripheralized LSK by “detaching” them from bm and spleen as it was implicated by the reduced numbers of LSK after Mzl [Mzl vs untreated: $p=0.04$ and $p=0.07$, respectively], in contrast to G-CSF-induced bm and splenic hyperplasia [G-CSF vs untreated: $p=0.04$ and $p=0.07$, respectively]. As a consequence of the opposing effects of G-CSF and Mzl in bm and spleen, the Mzl+G-CSF combination didn't significantly increase stem cells in the bm and spleen over the steady-state situation [LSK:bm and spleen, $p=ns$ / CFU-GM:bm, $p=ns$] although it still resulted in significant splenic CFU-GM increase ($p=0.0001$). Splenectomy, as previously shown, improved the G-CSF mobilization over non-splenectomized mice (LSK $p=0.05$ /CFU-GM $p=0.02$), however, it didn't improve Mzl-or Mzl+G-CSF mobilization, adding support to the hypothesis that Mzl may mobilize HSCs from extramedullary sites also. This concept was further augmented by the decreased SDF-1 expression in the spleens of Mzl-treated mice as compared to all other groups. In terms of migration capacity towards SDF-1, higher numbers of Mzl+G-CSF-mobilized blood or -primed bm cells migrated in a transwell system as compared to all other groups. Our data imply that Mzl overcomes the barrier of splenic sequestration of stem cells during mobilization due to their release from this site also and that Mzl+G-CSF-mobilized blood could be the preferable source of stem cells for thalassemia gene therapy because of the higher numbers of hematopoietic stem cells that could be obtained for genetic correction and a putative better homing potential of these cells upon transplantation.

193. AAV Mediated Liver-Specific Gene Therapy for Thrombotic Thrombocytopenic Purpura (TTP) in a Murine Model

Sheng-Yu Jin,¹ Juan Xiao,¹ J. Fraser Wright,¹ X. Long Zheng.¹
¹Department of Pathology and Laboratory Medicine, The Children's Hospital of Philadelphia and The University of Pennsylvania, Philadelphia, PA.

ADAMTS13, a reprotolysin-like zinc metalloprotease, is primarily synthesized in hepatic stellate cells, megakaryocytes or platelets and endothelial cells. It cleaves von Willebrand factor (VWF) after the Tyr1605 residue. This proteolytic cleavage is essential for normal hemostasis. Deficiency of plasma ADAMTS13 activity results in thrombotic thrombocytopenic purpura (TTP), a life-threatening syndrome. 5-10% of all TTP cases are caused by genetic mutations of ADAMTS13 gene, whereas 90% of patients are caused by autoantibodies against ADAMTS13 enzyme. To date, an intermittent infusion of fresh frozen plasma and/or plasma exchange is the only effective therapy. Complications associated with the administration of plasma including adverse events with central line placement, bacterial infections, chronic hepatitis C and allergic reactions to plasma proteins remain of concern, particularly in the pediatric population. To develop a safer and more effective therapeutic approach, we determined the efficacy and safety of AAV2-mediated expression of a C-terminal truncated ADAMTS13 variant (i.e. mMDTCS) for correction of TTP-phenotype in a murine model. We showed that a single injection of AAV2 encoding mMDTCS either under a ubiquitous promoter elongation factor 1 α (EF1 α) or under a liver-specific promoter human alpha 1-anti-trypsin (hAAT), at vector doses between 1.3×10^{12} and 1×10^{13} vg/kg, resulted in a sustained expression of recombinant mMDTCS. The plasma levels of ADAMTS13 activity were 1.0-1.6 units/ml at 4-6 weeks after the vector administration and then declined to approximately 20-30%, which lasted for about 20 weeks (the end of observation). Plasma VWF multimers were assessed at 2, 4, 8, 12, 16 and 19 weeks after vector administration by 1% agarose gel electrophoresis and Western blotting. The results showed that plasma UL-VWF multimers were dramatically reduced in Adamts13^{-/-} mice expressing mMDTCS, compared with those receiving PBS control. The reduction of plasma ULVWF multimers was highly correlated with the levels of the expressed plasma ADAMTS13 activity. Real-time PCR analysis showed that the mMDTCS mRNA was detected in the liver, lung, kidney, spleen, brain and heart after the injection of AAV2-EF1 α -mMDTCS, but more limited to the liver and heart after injection of AAV2- hAAT-mMDTCS. Furthermore, the high-level expression of mMDTCS under either promoter (EF1 α or hAAT) did not elicit the formation of anti-mMDTCS IgGs, nor cause an elevation of liver transaminases. Finally, the expressed plasma mMDTCS effectively prevented the development of “TTP-like” syndrome triggered by an administration of bacterial toxin (Shiga toxin-2), and dramatically reduced the mortality rate as a result of Shiga toxin-2 challenge. In conclusion, we have demonstrated for the first time that AAV-mediated expression of a C-terminal truncated ADAMTS13 variant may be a safe and effective therapy for TTP in a murine model. Our results provide molecular basis for rational design of a gene therapy for humans.

Neurologic & Ophthalmic Gene & Cell Therapy I

194. Long-Term Phenotypic Correction of Feline Lysosomal Storage Disease by Intracranial AAV Gene Therapy

Victoria J. Jones,¹ Allison M. Bradbury,¹ Misako Hwang,¹ Stanley G. Leroy,² Stacy Maitland,² Aime K. Johnson,³ Miguel Sena-Esteves,² Douglas R. Martin.¹

¹Scott-Ritchey Res Ctr/Dept Anat, Phys, Pharm, Auburn University College of Vet Med, Auburn, AL; ²Gene Therapy Center, University of Massachusetts Medical School, Worcester, MA; ³Dept Clinical Sciences, Auburn University College of Vet Med, Auburn, AL.

Deficiency of lysosomal β -galactosidase (β gal) causes storage of GM1 ganglioside, resulting in progressive neurological deterioration and death, often by 5 years of age. AAV gene therapy has been extraordinarily successful in the GM1 mouse model, (*Mol Ther*, 15:30, 2007; *PLoS One*, 5:e13468, 2010), resulting in enhanced survival and complete clearance of storage in the brains of GM1 mice. Because the mouse brain is ~1000 times smaller and much less complex than the human brain, it is important to test AAV gene therapy in an animal model whose brain size and complexity more closely resemble humans. First reported ~40 years ago, the feline GM1 model presents an unparalleled opportunity to evaluate AAV gene therapy in a non-rodent, 'large animal' prior to initiating human clinical trials. In the current study, AAV2/1 or AAV2/rh8 vectors expressing a feline β gal cDNA (3.1-12.0e12 g.c. total) were injected bilaterally into the thalamus and deep cerebellar nuclei of 2-month old GM1 cats (disease onset ~3.5 months). In treated brains collected 4-16 weeks post-injection, β gal was distributed throughout the entire anterior-posterior axis of the cerebrum and cerebellum at levels up to 4 times normal. Cervical and lumbar spinal cord regions demonstrated β gal activity 0.5 -1 times normal, and filipin staining demonstrated extensive clearance of storage material. Little evidence of an inflammatory cellular infiltrate was observed in H&E-stained brain sections, though serum antibody titers to the AAV vectors were pronounced (~1:65,000). Long-term therapeutic experiments in 2-month old GM1 cats were conducted using the same vector dose and route of delivery. Currently, AAV-treated GM1 cats are 16, 14 and 12 months of age, with no evidence of clinical neurological disease (untreated humane endpoint, 7.7 ± 0.8 months, n=9). Treated GM1 cats demonstrate normalization of MRI brain lesions and absence of gait abnormalities typical of untreated cats. Other than serum antibody titers, no evidence of vector toxicity has been documented, and no β gal activity was detected in peripheral blood mononuclear cells. Further encouraging results come from treatments performed nearer to clinical disease onset (3.0 months of age, 2 weeks prior to disease onset), in which 2 GM1 cats remain neurologically normal at 8.3 months of age. These translational studies provide strong support for the initiation of AAV-based clinical trials for human GM1 gangliosidosis.

195. Brain Gene Therapy for Metachromatic Leukodystrophy: Optimized Clinical Protocol

Caroline Sevin,^{1,2} Françoise Piguet,¹ Dolan Sondhi,³ Marie-Anne Colle,⁴ Thomas Roujeau,^{1,5} Sylvie Raoul,⁶ Jack-Yves Deschamps,⁷ Celine Bouquet,¹ Ornella Ahouansou,¹ Marie Vanier,⁸ Philippe Moullier,⁹ Yan Cherel,⁴ Neil R. Hackett,³ Michel Zerah,^{1,5} Ronald G. Crystal,³ Patrick Aubourg,^{1,2} Nathalie Cartier.^{1,2}

¹INSERM U745, Paris, France; ²Pediatric Neurology and Endocrinology, St Vincent de Paul Hospital, Paris, France; ³Weill Medical College of Cornell University, New York; ⁴UMR INRA 703, Nantes, France; ⁵Pediatric Neurosurgery, Necker-Enfants Malades Hospital, Paris, France; ⁶Neurosurgery, CHU Nord, Nantes, France; ⁷National School of Veterinary Medicine, Nantes, France; ⁸Inserm U820, Lyon, France; ⁹Inserm U649, Nantes, France.

Metachromatic Leukodystrophy (MLD) is a lethal neurodegenerative disease caused by deficiency of Arylsulfatase A (ARSA). The most severe late-infantile form starts around 1-2 years, leading to death within a few years, without available treatment. Among potential new therapeutic interventions, brain gene therapy could ensure rapid and sustained delivery of ARSA enzyme in the brain, a prerequisite to arrest the neurodegenerative process in due time. We have demonstrated efficiency and safety of intracerebral delivery of adeno-associated-vector serotype 5 (AAV5) encoding human ARSA in MLD mice and non-human primates. We recently demonstrated that AAVrh.10 encoding ARSA improves more rapidly MLD mice that AAV5-ARSA and, importantly, allows normalization of sulfatide isoforms that accumulate specifically in oligodendrocytes. In a clinical perspective, we optimized in non-human primates the neurosurgical procedure to allow simultaneous infusion of vector at 12 different brain sites in less than 2 1/2 hours. We also developed a brain imaging protocol using MRI to select the injection sites and evaluate the tolerance of the surgical procedure. Following the same protocol planned to be used in patients, we demonstrated in non-human primates that intracerebral injection of AAVrh.10/ARSA vector ($1.1 \cdot 10^{11}$ viral particles per hemisphere in selected areas of the white matter) is well tolerated and results in the diffusion of the vector in 66 to 90% of the injected hemisphere. We also documented up to 31% increased activity of ARSA, reaching foreseeable therapeutic levels. As compared to our previous results with AAV5/ARSA, the use of a 20-fold lower dose of AAVrh.10 vector injection led to higher amounts of vector and increased level of ARSA activity in the brain. Toxicological studies are in progress towards phase I/II tolerance and efficiency clinical trial in late 2011. This trial will enroll five patients with rapidly progressing MLD. AAVrh.10/ARSA vector will be administrated to 12 locations in the CNS, guided by brain imaging. Safety and efficiency parameters will be evaluated up to 2 years, a period that will be sufficient enough to assess the potential therapeutic efficiency of this brain gene therapy strategy in rapidly progressing forms of MLD.

196. Dosage Thresholds and Vector Serotype Define AAV Targeting of Rod and Cone Photoreceptors in Non-Human Primates

Luk H. Vandenberghe,¹ Peter Bell,¹ Albert M. Maguire,² Ru Xiao,¹ Rebecca Grant,¹ Jean Bennett,² James M. Wilson.¹

¹Gene Therapy Program, Department of Pathology and Laboratory Medicine, University of Pennsylvania, Philadelphia, PA; ²F M Kirby Center for Molecular Ophthalmology, Scheie Eye Institute, University of Pennsylvania, Philadelphia, PA.

Gene therapy is emerging as a therapeutic modality for treatment of retinal disorders. Rod and/or cone photoreceptors are the primary cell types in many inherited retinal degenerations and successful gene therapy for those diseases will therefore require identification

of efficient and safe targeting vectors. Previously, we injected non-human primate eyes with 6 AAV serotypes via a subretinal route in order to determine relative efficiencies of transduction of the retinal pigment epithelium (RPE) and characterize the histological and immunological consequences of vector administration at various doses. Here, we further examined the injected eyes qualitatively and quantitatively for photoreceptor transduction. Non-human primates are the only animal models with a macula and therefore we also sought to determine the expression profile in the macula, including the fovea. Based on an interesting transduction profile in the murine retina, AAV2, 7, 8, 9 and the engineered capsid isolates rh64R1 and rh8R were subretinally injected into cynomolgus macaque eyes at doses ranging from $10E8$ to $10E11$ GC per eye of a GFP expressing AAV. Eyes were sectioned and analyzed histologically 2 to 6 months following injection. Morphometry for transduction efficiency and intensity highlighted substantial differences between vector serotypes. AAV8 was the most efficient serotype in transducing photoreceptors at the moderate dose of $10E9$ GC. At a dose of $10E10$ GC however, all serotypes with the exception of AAV2, demonstrated very efficient and roughly equivalent levels of GFP expression in the photoreceptor cell layer. Detailed histological analysis of 3 macular regions, including the fovea, and a fourth non-macular site illustrated striking differences in the relative targeting efficiency of cones and rods. Whereas all vectors transduced rods quite readily, AAV9 and rh8R emerged as substantially more efficient in cone transduction both within and outside of the fovea. At higher doses, the efficiency of cone transduction of the other vectors can be boosted, but nevertheless, the differential permissivity of cones versus rods for each vector remains apparent.

197. AAV2/5-Mediated Gene Therapy Synergizes with Bone Marrow Transplantation in the Treatment of Infantile Neuronal Ceroid Lipofuscinosis

Shannon L. Macauley,¹ Marie S. Roberts,¹ Mark S. Sands.¹

¹Internal Medicine, Washington University School of Medicine, Saint Louis, MO.

Infantile neuronal ceroid lipofuscinosis (INCL) is an inherited, neurodegenerative lysosomal storage disease (LSD) affecting the central nervous system (CNS) during infancy. INCL is caused by mutations in the CLN1 gene leading to a deficiency in the lysosomal enzyme, palmitoyl protein thioesterase 1 (PPT1). Pathological changes in the CNS include brain atrophy, cortical thinning, autofluorescent accumulation, neurodegeneration, and glial activation. The clinical signs include seizures, blindness, motor dysfunction, mental retardation and premature death by 6 years of age. The PPT1-/- mouse accurately mimics the human disease. PPT1-/- mice have a decreased life span, visual defects, cognitive deficits, epilepsy, and motor dysfunction. PPT1-/- brains show similar pathological changes to INCL patients including autofluorescent accumulation, neurodegeneration, glial activation as well as brain atrophy. The similarities between PPT1-/- mice and children with INCL make this an excellent tool to investigate therapeutic strategies for the treatment of INCL. Currently, gene and stem cell therapies are in clinical trials for the treatment of INCL and late infantile neuronal ceroid lipofuscinosis (LINCL). Although both therapies demonstrated partial improvements on biochemical and histological parameters, the behavioral improvements were modest and no improvement in lifespan was seen. Furthermore, another clinical study utilizing bone marrow transplantation (BMT) as a potential therapy for INCL or LINCL proved unsuccessful. Thus, given the complexity of INCL and the inadequate therapeutic benefit from any singular therapy, we hypothesized that combining therapeutic modalities must be used to be efficacious. In this study, we combined intracranially (IC) delivered AAV2/5 expressing PPT1 with bone marrow transplantation (BMT). At birth, PPT1-/- mice received six injections of AAV2/5-PPT1

delivered bilaterally to the anterior cortex, thalamus/hippocampus, and cerebellum. The following day the treated PPT1-/- mice were irradiated with a myeloreductive-conditioning regimen (400 rads) followed by BMT via a temporal vein injection of 1×10^6 bone marrow derived stem cells. BMT alone provided no enzyme activity to the brain and did not improve lifespan or motor function, similar to clinical trials. Surprisingly, neonatal BMT synergized with IC delivery of AAV2/5-PPT1 to dramatically increase the median lifespan of PPT1-/- mice (untreated PPT1-/- ~ 8mo, AAV2/5-PPT1-only ~ 13mo, AAV2/5-PPT1/BMT ~ 17mo). The combination also resulted in sustained improvements in motor function (constant speed and rocking rotarod). On the constant speed rotarod paradigm, the AAV2/5-PPT1+BMT mice performed similar to wildtype mice until 13 months of age and then their performance steadily decreased through 17 months. The combination therapy also demonstrated improvements on the rocking test when compared to untreated mice through 11 months of age and then steadily decreased thereafter. This combination of CNS-directed gene therapy and BMT demonstrates clinical improvements unparalleled by any previous pre-clinical study or clinical trial done in INCL.

198. RNAi Therapy for Spinocerebellar Ataxia Type 1

Megan K. Keiser,³ Ryan L. Boudreau,¹ Beverly L. Davidson.^{1,2,3}

¹Internal Medicine, University of Iowa, Iowa City, IA; ²Neurology, University of Iowa, Iowa City, IA; ³Graduate Program of Neuroscience, University of Iowa, Iowa City, IA.

Spinocerebellar Ataxia Type 1 (SCA1) is an autosomal dominant late onset neurodegenerative disease. SCA1 toxicity is caused by an expanded polyglutamine tract in ataxin-1. The disease affects cerebellar and brainstem neurons, including Purkinje cells. Motor symptoms include gait, balance, and motor coordination deficits. Currently, there are no curative therapies for SCA1, however, evidence supports that reducing mutant ataxin-1 expression may provide therapeutic benefit. RNA interference (RNAi) is a naturally occurring process which mediates gene silencing and is currently being investigated as therapy for dominant diseases such as SCA1. Previous work from our laboratory has shown that RNAi-mediated silencing of a mutant human ataxin-1 transgene improves neuropathological and behavioral phenotypes in a transgenic mouse model of SCA1. The results from this proof-of-concept study highlight the potential of RNAi therapy for treating SCA1 patients. Subsequently, we have initiated studies to test this therapeutic strategy in the knock-in mouse model of SCA1, which more closely genocopies human patients. We have designed several artificial microRNAs (miRNAs) targeting conserved sequences in both the mouse and human ataxin-1. This approach may facilitate the transition of therapeutic sequences from mouse studies to human. We screened the artificial miRNAs in vitro against both transgenic and endogenously expressed ataxin-1. Two therapeutic candidates (siSCA1.1, siSCA1.2) showed effective silencing of ataxin-1 in both human and mouse cell lines. siSCA1.1 and siSCA1.2 were placed into adeno-associated viral (AAV) vectors for in vivo delivery. Pilot studies showed expression in cerebellar Purkinje cells, knock down of target, and reduction of protein expression. At 30 weeks of age (25 weeks after therapy) the SCA1 mutant mice treated with siSCA1.1 trend toward improved motor phenotypes relative to controls. Additional tests of therapeutic efficacy are underway. This data provides the first evidence of effective RNAi against ataxin-1 in the knock-in model of SCA1.

199. Long-Term Persistence of AAV Mediated Gene Therapy for Leber Congenital Amaurosis Type 1 (LCA1)

Sanford L. Boye,¹ Thomas Conlon,² Kirsten Erger,² Travis Cossette,² Jijing Pang,¹ Sukanya Karan,³ Renee Ryals,¹ Wolfgang Baehr,³ William W. Hauswirth,¹ Shannon E. Boye.¹

¹Ophthalmology, University of Florida, Gainesville, FL; ²Powell Gene Therapy Center, University of Florida, Gainesville, FL; ³Ophthalmology, University of Utah, Salt Lake City, UT.

Purpose. We have previously shown that Adeno-associated viral (AAV) vectors containing the murine GC1 cDNA driven by either the photoreceptor-specific human rhodopsin kinase (hGRK1) or the ubiquitous (smCBA) promoter were capable of restoring cone-mediated function and visual behavior and preserving cone photoreceptors in the GC1KO mouse for at least three months. In the present series of experiments, we evaluated persistence of therapy in this model. Additionally, we examined whether delivery of GC1 to photoreceptors of the GC1/GC2 double knockout mouse (GCdko), a model which exhibits loss of both rod and cone structure and function and phenotypically resembles human LCA1, would confer therapy to both cell types. **Methods.** Subretinal injections of AAV5-hGRK1-mGC1, AAV5-smCBA-mGC1 or the highly efficient capsid tyrosine mutant AAV8(Y733F)-hGRK1-mGC1 were performed in one eye of GC1KO or GCdko mice between postnatal day 14 (P14) and P25. Rod and cone photoreceptor function were assayed electroretinographically. Localization of therapeutic GC1 expression and extent of cone photoreceptor preservation were determined by immunohistochemistry. Biodistribution studies were used to evaluate the presence of vector genomes in optic nerves and brains of treated animals. **Results.** Cone photoreceptor function was restored in GC1KO mice treated with all vectors, with AAV8(733) being the most efficient. Responses were stable for at least 12 months post-treatment. Therapeutic GC1 was found in photoreceptor outer segments. At 10 months post-injection, AAV5 and AAV8(733) vector genomes were detected only in the optic nerves of treated eyes of GC1KO mice. AAV8(733)-vectored mGC1 restored function to both rods and cones in treated GCdko mice. **Conclusions.** We demonstrate for the first time that long-term therapy is achievable in a mammalian model of LCA1, the GC1KO mouse. Importantly, therapy is also achievable in the GCdko mouse which better mimics the rod/cone phenotype of human LCA1 patients. Our results provide a framework for the development of an AAV-based gene therapy vector for treatment of LCA1.

200. Correction of the Lysosomal Storage Defect in Mouse Model of Juvenile Neuronal Ceroid Lipofuscinosis by Neonatal Injection of AAV Serotype rh.10 Vector Expressing the Human CLN3 Gene

Dolan Sondhi,¹ Neil R. Hackett,¹ Emma Scott,¹ Alvin Chen,¹ Susan Cotman,² Ronald G. Crystal.¹

¹Genetic Medicine, Weill Cornell Medical College, New York, NY;

²Center for Human Genetic Research, Massachusetts General Hospital, Boston, MA.

Juvenile neuronal ceroid lipofuscinosis (JNCL) is an autosomal recessive lysosomal storage disease resulting from mutations in the CLN3 gene encoding a lysosomal membrane protein of unknown function. The primary symptoms, starting at ages 4 to 7, are visual failure, followed by neurological symptoms with seizures and progressive neurodegeneration. As an experimental treatment for the CNS manifestations of JNCL, we have developed adeno-associated virus vector of serotype rh.10 expressing the human CLN3 cDNA intended for direct administration into brain parenchyma. This approach offers the advantages of a wide distribution of transgene expression, the absence of a pre-existing human anti-vector immunity

and a safety record of use of this vector in humans. As a critical step in translating this strategy to humans, we hypothesized that administration of this vector into the CNS of the mouse model of JNCL, which has the same genomic deletion as the most common causative human JNCL mutation, would modify the CNS phenotype of lysosomal accumulation. JNCL knock-in mice were administered with 10¹⁰ genome copies of the AAVrh.10hCLN3 vector into 6 locations (3 per hemisphere) in the brain as newborns and underwent biweekly behavioral assessment on grip strength test and balance beam test. Control groups consisted of untreated JNCL knock-in mice and wildtype mice. There was no difference in behavior at any age between wildtype, naive JNCL knock-in mice nor AAVrh.10hCLN3-treated JNCL knock-in mice, i.e., the JNCL knock-in mice do not exhibit an abnormal physiologic phenotype with these tests, and therefore, the impact of treatment on a murine “clinical equivalent” phenotype could not be assessed. However, when sacrificed at 18 months, there was clear immunohistochemical evidence of CLN3 transgene expression in the AAVrh.10hCLN3 treated JNCL knock-in mice, with a significant reduction in the lysosomal accumulation of autofluorescent storage materials dependent on treatment. The total area with fluorescent intensity greater than a fixed background (based on wildtype mice) was increased by an average of 2.1 ± 0.7-fold (p<0.0001) in untreated knock-in mice. This disease-dependent increase in autofluorescence area varied among different brain regions with more autofluorescence in the thalamus (3.8 times greater area in JNCL mice compared to wildtype) than in striatum (1.7 times). Neonatal AAVrh.10hCLN3 treatment reduced the total autofluorescence area in the JNCL knock-in mice with an average area 1.11 ± 0.38 compared to wildtype mice (p<0.001 compared to untreated, p=0.6 compared to wildtype), with the efficiency of autofluorescence clearance greater in the cortex than in medulla. These analyses demonstrate that AAVrh.10 administration provides a widespread correction of neurological lysosomal storage defect in the JNCL mouse model, and therefore this strategy merits further preclinical development.

201. The Effect of Pre-Existing Immunity to AAV on CNS Directed Gene Therapy

Christopher M. Treleaven,¹ Thomas J. Tamsett,¹ Jonathan A. Fidler,¹ Gregory D. Hurbult,¹ Seng H. Cheng,¹ Lamya S. Shihabuddin,¹ James C. Dodge.¹

¹Genzyme Corporation, Framingham, MA.

CNS directed gene therapy with adeno-associated virus (AAV) vectors has been used effectively to slow disease progression in a variety of mouse models of neurometabolic (e.g., Niemann Pick Type A disease, mucopolysaccharidosis VII and infantile neuronal ceroid lipofuscinosis) and neurodegenerative (e.g., amyotrophic lateral sclerosis and spinal muscular atrophy) diseases. However, these studies are typically conducted in naive mice with no prior exposure to AAV. Therefore, in our current experiments we sought to determine if either active (through prior systemic exposure to AAV2/5-bgal) or passive (via an IV injection of Gamunex) immunization to AAV led to a reduction in AAV2/5 mediated expression of insulin like growth factor 1 (IGF-1) within the CNS of C57BL/6 male mice following either intraparenchymal (IP) or intracerebroventricular (ICV) vector delivery (CNS dose = 5E9 drp/injection). We also determined if pre-existing immunity to AAV triggered an enhanced inflammatory response following CNS delivery of AAV2/5-IGF-1. Regardless of the mode of delivery employed (IP vs. ICV), active immunization (which generated anti AAV5 serum antibody titer greater than 1:100K) significantly reduced IGF-1 levels in the brain by 60 to 95% (depending on the brain region analyzed). Interestingly, GFAP (a marker of astrogliosis), Iba1 (indicator of microglial activation) and H&E staining did not show evidence of an enhanced inflammatory response in mice with pre-existing immunity to AAV after vector

delivery to the CNS. Interestingly, passive immunization with Gamunex (which resulted in anti-AAV serum antibody titers of 1:3200) did not significantly influence AAV mediated expression of IGF-1 within the CNS (although a trend toward a reduction was observed in the injected hemisphere) or lead to an enhanced neuroinflammatory response within the CNS following vector delivery. Collectively, these findings suggest that pre-existing immunity to AAV can significantly diminish AAV mediated expression within the CNS when serum antibody titers are > 1:100K, but not at lower (i.e., clinically relevant) titers. They also show that prior exposure to AAV (regardless of anti-AAV antibody titer) does not lead to an enhanced neuroinflammatory response following CNS directed gene therapy. These results support the continued development of AAV based therapies for the treatment of neurological disorders.

202. Microglia as an Attractive Cellular Vehicle for Gene Therapy of Parkinson's Disease

K. C. Biju,¹ Rene A. Santacruz,¹ Cang Chen,¹ Robert A. Clark,¹ Senlin Li.¹

¹Medicine, UTHSCSA and South Texas Veterans Health Care System, San Antonio, TX; ²Medicine, UTHSCSA and South Texas Veterans Health Care System, San Antonio, TX; ³Medicine, UTHSCSA and South Texas Veterans Health Care System, San Antonio, TX; ⁴Medicine, UTHSCSA and South Texas Veterans Health Care System, San Antonio, TX; ⁵Medicine, UTHSCSA and South Texas Veterans Health Care System, San Antonio, TX.

Parkinson's disease (PD) is an increasingly common neurodegenerative disease resulting from the death of dopaminergic neurons in the substantia nigra. Symptoms of PD start to appear when about 70-80% of striatal dopamine and about half of nigral dopamine neurons have been lost progressively, generally over the course of a pre-clinical period of several years. Therefore, prevention of ongoing neuronal loss in symptomatic patients represents a high priority objective although it is also desirable to treat asymptomatic patients if early diagnosis can be done. Neurturin (NTN), a member of the GDNF family of ligands has been shown to promote survival of nigrostriatal dopaminergic neurons in animal models of PD. However, its use is hindered by difficulties in delivery to the brain due to the presence of the blood-brain barrier. Here, we exploited the natural homing property of macrophages to show that bone marrow stem cell-derived macrophages/microglia are capable of delivering therapeutic levels of NTN to regions of PD-associated dopaminergic injury and prevent or retard ongoing neuronal loss. Bone marrow cells from donor mice were transduced *ex vivo* with lentivirus expressing either a NTN or GFP gene driven by a synthetic macrophage-specific promoter. The NTN- or GFP-transduced cells were then transplanted to separate recipient mice. Eight weeks after transplantation, recipient mice were injected with the neurotoxin, 1-methyl-4-phenyl-1,2,3,6-tetrahydropyridine (MPTP) for seven days to induce dopaminergic neurodegeneration. In the brain, gene-modified macrophages differentiated into microglia and were recruited in large numbers to substantia nigra of MPTP-treated mice. Macrophage-mediated NTN treatment prevented degeneration of tyrosine hydroxylase (TH)-positive neurons by up to 80 percent and protected TH-positive terminals in the striatum against MPTP-mediated injury. These results indicate that macrophage-mediated NTN delivery is a promising strategy for developing a neuroprotective therapeutic approach for PD. Moreover, because macrophage-derived microglia are recruited specifically to sites of neurodegeneration wherever they occur in the CNS, their use as a delivery vehicle for neurotrophic factors, for example NTN as in this study, offers potential avenues for protection of dopaminergic, as well as non-dopaminergic systems that ultimately undergo degeneration in PD.

203. Early Functional and Long-Term Rescue of the LHON Mouse with Wild-Type Human ND4 Gene Delivery

Rajeshwari D. Koilkonda,¹ Tsung-Han Chou,¹ Marco Ruggeri,¹ Vittorio Porciatti,¹ William W. Hauswirth,² Vince Chiodo,² Sanford L. Boye,² John Guy.¹

¹Department of Ophthalmology, University of Miami, Bascom Palmer Eye Institute, Miami, FL; ²Department of Ophthalmology, University of Florida, College of Medicine, Gainesville, FL.

Purpose: To demonstrate the feasibility of gene therapy with a wild-type (wt) human ND4 subunit of complex I to rescue visual loss and optic neuropathy. **Methods:** To induce optic neuropathy single-stranded (ss) AAV containing the mutant human R340H ND4 responsible for most cases of LHON caused by G11778A mutated mitochondrial DNA was injected into the vitreous of both mouse eyes. Self-complementary rescue vectors containing the wt human ND4 with an appended FLAG epitope were packaged in single phenylalanine (F) for tyrosine (Y) substitutions in the VP3 AAV capsid (position 444) or triple F-Y substitutions (positions 444,500,730). For rescue either construct was injected into the right eyes. Contralateral eyes received scAAV-GFP. To gauge expression another series of mice received only the wt ND4 into the right eyes and GFP into the left eyes. ND4FLAG or GFP expressing cells relative to Thy1.2 labeled RGCs were quantitated 1, 3 and 7 days post injection (PI). Pattern electroretinogram (PERG) assessed rescue of visual function. Thickness of the optic nerve head and retina was evaluated by OCT. 1yr PI, rescue was gauged by ATP synthesis, TUNEL positive RGCs and optic nerve (ON) fiber counts. **Results:** Expression- Confocal microscopy revealed punctate and perinuclear expression of wt ND4FLAG. Relative to Thy1.2+ RGCs, quantification of scAAV-ND4FLAG+ RGCs was 21%, 50% and 85% by 1, 3 and 7 days respectively. Rescue- PERG at 1 and 3m PI showed a 28% and 48% reduction of amplitude in the rescued eyes compared to baseline. In contralateral eyes the reduction was 44% (p<0.05) and 54%. In addition, the control eyes showed latency delay of 17% and 20% (p<0.05) compared to rescued eye 1 and 3m PI. OCT images showed optic disc (OD) swelling in 60% of the controls at 1m. WT-ND4 reduced the OD swelling to 28%. A year after injections ON sections revealed significant thinning in control eyes (AVG±SD) 317±23 μm, relative to wt ND4 rescued eyes 347±20 μm (p<0.05). WT-ND4 rescued eyes had 30% less ON fiber loss (p<0.05) and less TUNEL + RGCs/mm² (AVG±SE) 39±9 relative to 262±36 for control eyes (p<0.05). ATP synthesis in rescued ONs of 190 nM ATP/min/mg was similar to 192 nM ATP/min/mg for normal uninjected ONs and it was greater than 89 nM ATP/min/mg for unrescued control left eyes. **Conclusions:** Human ND4 delivered by self-complementary Y-F AAVs improved oxidative phosphorylation, suppressed visual loss and optic neuropathy, thus providing proof of concept of this therapy for LHON patients.

204. Adeno-Associated Virus Mediated Gene Therapy for Treatment of Autosomal Dominant Retinitis Pigmentosa (ADRP)

Haoyu Mao,¹ Marina S. Gorbatyuk,² William W. Hauswirth,³ Alfred S. Lewin.¹

¹Department of Molecular Genetics and Microbiology, University of Florida, Gainesville, FL; ²North Texas Eye Research Institute, University of North Texas Health Science Center at Fort Worth, Fort Worth, TX; ³Department of Ophthalmology, University of Florida, Gainesville, FL.

Autosomal dominant retinitis pigmentosa (ADRP) leads to blindness through death of photoreceptor cells of the retina. ADRP is frequently caused by mutations in the RHO gene, which codes for the opsin of rod photoreceptor cells. The purpose of this study

is to treat ADRP by an RNA suppression and replacement approach using siRNA combined with normal, but resistant, rhodopsin gene. We tested gene therapy in a mouse model of ADRP that expresses the human P23H RHO transgene and a single copy of the mouse rhodopsin gene. We constructed a combination AAV vector containing an siRNA that degrades both mouse and human opsin mRNA and a “hardened” RHO gene (RHO301) that is resistant to that siRNA. The gene RHO301 was generated by introducing silent mutations to eliminate the siRNA cleavage site. The combination cassette (RHO301-siRNA301) or RHO-only cassette (RHO301) in AAV5 was delivered into the right eyes of transgenic mice by subretinal injection, and AAV-GFP was injected by the same method in the left eyes. Following delivery of RHO301-siRNA301 in AAV5 to P23H RHO transgenic mice, the electroretinogram (ERG) a-wave and b-wave response was significantly increased in treated eyes relative to control treated eyes for more than 3 months, suggesting preservation of retinal function. To assess retinal structure, the outer nuclear layer (ONL) thickness was measured with the optical coherence tomography (OCT) in living mice at 3 months post injection. The integrity of treated eyes was significantly greater compared with control treated eyes. Augmentation by delivery of RHO301 alone did not show consistent improvement in ERG response over the same time course in the same mouse model. AAV delivery of a combination construct containing gene encoding wild-type rhodopsin and RHO-specific siRNA improved retinal function and structure in this ADRP model, suggesting that this approach may be useful for the treatment of this inherited blinding disorder.

205. CNS Expression of Glucocerebrosidase Corrects Hippocampal alpha-Synuclein Aggregates and Memory Deficits in a Mouse Model of Gaucher-Related Parkinsonism

Pablo S. Sardi,¹ Lamya S. Shihabuddin,¹ Seng H. Cheng.¹
¹Genzyme Corporation, Framingham, MA.

Emerging genetic and clinical evidence suggest a link between Gaucher disease and the synucleinopathies, Parkinson’s disease (PD) and dementia with Lewy bodies (DLB). Gaucher patients harboring mutations in the glucocerebrosidase gene (*GBA*) present an increased risk for Parkinsonism and subjects with sporadic PD and DLB exhibit an increased occurrence of mutations in *GBA*. Lewy body-like alpha-synuclein inclusions, a neuropathological hallmark of PD, have also been found in patients with GD. To better understand the relationship between mutant *GBA* and alpha-synuclein accumulation, the behavior and brain histopathology of two mouse models of GD (*Gba*^{D409V/D409V} and *Gba*^{+/+}) were examined. Both mouse models of Gaucher disease exhibited features of synucleinopathies such as the progressive accumulation of proteinase K-resistant alpha-synuclein/ubiquitin aggregates in hippocampal neurons. Co-incident with the appearance of this pathology was a loss in memory as determined using novel object recognition and contextual fear conditioning tests. Hippocampal aggregates of alpha-synuclein/ubiquitin were apparent in Gaucher mice with less than 60% glucocerebrosidase activity provided there was concurrent presence of a mutant *Gba* allele. This suggests that the presence of mutant glucocerebrosidase might confer a gain in toxic function. However, although the presence of aggregates was necessary, it was not sufficient to engender the observed impairment in hippocampal memory. Importantly, AAV1-mediated expression of glucocerebrosidase in the CNS of *Gba*^{D409V/D409V} mice ameliorated both the pathological accumulation of alpha-synuclein/ubiquitin aggregates and memory deficit. Together, these data support the contention that mutations in *Gba* can render the brains of mice with Parkinsonism-like pathology and that reconstituting the CNS with exogenous glucocerebrosidase activity may represent a potential therapeutic strategy for *Gba*-associated synucleinopathies.

206. Anterograde Trafficking of AAV2 Vectors in the Primate Brain

Adrian P. Kells,¹ Ernesto Aguilar Salegio,¹ Krystof S. Bankiewicz.¹
¹Neurosurgery, University of California San Francisco, San Francisco, CA.

Neuro gene delivery via direct intrapranchymal injections of adeno-associated viral (AAV) vectors is a locally administered treatment that requires accurate delivery to maximize safety and efficacy. The large volume and convoluted architecture of the human brain is a barrier to translating small animal findings into clinical procedures. Too little target coverage and the treatment risks being ineffective. Excessive distribution or off-target delivery raises the possibility of adverse effects. In order to target large structures such as the putamen for the treatment of Parkinson’s disease (PD), we have developed real-time MRI monitored convection-enhanced delivery (CED) demonstrating safe and reliable delivery of large volume (>300 L) AAV vector infusions in non-human primates (NHP). Subsequent to our discovery that AAV2 vectors undergo anterograde transport along thalamocortical projections, we have now analyzed prior NHP studies to look for evidence of anterograde transport of AAV2 in other brain regions. We have conducted multiple NHP studies to investigate the delivery of AAV2-GDNF (glial-derived neurotrophic factor) to the putamen or substantia nigra as a neuro-regenerative treatment for PD. These studies have shown delivery of AAV2-GDNF into NHP putamen is well tolerated with significant functional improvements and restoration of dopaminergic activity, however delivery to the substantia nigra resulted in weight loss. Additional assessment of these NHP studies shows anterograde distribution of AAV2-GDNF vector resulting in the transduction of neurons and expression of GDNF in secondary regions of the brain not directly infused. Of particular interest is the equivalent transduction of nigral neurons after putamen delivery in both MPTP-lesioned and naïve NHP indicating that GDNF expression in nigra is not dependent on the integrity of the dopaminergic neurons. Double staining with tyrosine hydroxylase (TH) showed that almost all GDNF in the substantia nigra was localized to TH-negative fibers and cell bodies within the pars reticulata. GDNF expression in the globus pallidus and sub-thalamic nucleus is further evidence of anterograde transport with no GDNF observed in non-basal ganglia nuclei. Conversely, AAV2-GDNF delivery to the substantia nigra resulted in significant co-localization of GDNF with TH-positive pars compacta neurons, however transduction was not limited to the nigra but included the hypothalamus, sub thalamic nucleus, globus pallidus, thalamus, septum and caudate nucleus. This GDNF presence in non-dopaminergic areas is indicative of protein and vector trafficking that may have contributed to the weight loss and demonstrates the non-localized gene delivery that can occur with AAV2. We have confirmed anterograde transport of AAV2 by PCR detection of vector DNA in non-infused regions of an AAV2-GFP treated NHP brain. In conclusion, AAV2 gene delivery is not localized to the infusion site and consideration should be given to the potential effects of transgene expression in anterogradely connected areas from primary target brain region. Furthermore, we believe that anterograde axonal trafficking pattern of AAV2 will occur in other brain regions outside of the thalamocortical and basal ganglia circuits.

207. Evaluation of the Immune Responses in the Treatment of RPE65 Deficient Dogs by Subretinal Injection of a Recombinant AAV Serotype 4

Nathalie Provost,¹ Lise Libléau,¹ Alexandra Mendes Madeira,¹ Jack-Yves Deschamps,³ Michel Weber,² Guylène LeMeur,² Yan Cherel,³ Philippe Moullier,¹ Fabienne Rolling,¹ Christine Chauveau.¹

¹INSERM U649, Nantes, France; ²Service d'Ophthalmologie, CHU Hotel Dieu, Nantes, France; ³Ecole Nationale Veterinaire, Nantes, France.

Leber's Congenital Amaurosis (LCA) is a group of hereditary retinal degeneration leading to total blindness in adulthood. We previously demonstrated that targeted gene transfer to the RPE cells using a recombinant adeno-associated virus serotype 4 (rAAV2/4) can be used to correct the RPE65 defect in a LCA model of RPE65^{-/-} purebred Briard dogs. We aim to evaluate the role of the immune responses in RPE65^{-/-} dogs treated by subretinal rAAV2/4.hrpe65 mediated gene delivery in order to determine (i) whether the subretinal injection of the therapeutic dose of rAAV2/4.hrpe65 leads to development of immune responses to the vector or the RPE65 transgene, (ii) the immune consequences of the subretinal injection of rAAV2/4.hrpe65 in the contralateral eye of dogs with a first eye previously treated, (iii) whether a preexisting immunity to AAV4 could limit the therapeutic effectiveness of the subretinal injection of rAAV2/4.hrpe65. Three RPE65^{-/-} dogs were treated by subretinal injection of rAAV2/4.hrpe65 in one eye. ELISA analysis showed that none of the animals had detectable serum antibodies (Abs) neither against the transgene, nor against the AAV4 vector capsid in the 4 months following the treatment. IFN γ enzyme-linked immunosorbent spot (ELISpot) assays performed on peripheral blood mononuclear cells (PBMCs) did not show any cellular responses to the transgene or to the AAV4 vector capsid at any time. Four months after the treatment of the first eye, the contralateral eye of the dogs was treated by a subretinal injection of rAAV2/4.hrpe65. Analysis of the sera of the animals did not allow to detect Abs to the transgene or the AAV4 capsid. IFN γ ELISpot assays performed on PBMCs did not show any cellular responses to the transgene or the AAV4 capsid. In addition, IFN γ ELISpot performed with splenocytes 12 months after the first subretinal injection did not allow detection of any cellular responses to the transgene or to the AAV4 vector capsid. Because data indicate that low levels of neutralizing Abs can abrogate transduction with high titers of AAV vectors, we aim to evaluate the impact of a preexisting immunity to AAV4 on the transduction efficacy of subretinal AAV2/4.hrpe65 mediated gene delivery. In order to induce a high titer of anti-AAV4 Abs in serum of the animals, two dogs were pre-immunized with AAV4 2 months before subretinal injection of AAV2/4.hrpe65. Bilateral full field electroretinographic recordings performed after gene transfer showed that a strong preexisting immunity to AAV4 did not block AAV2/4.hrpe65-mediated gene delivery and long term function recovery in RPE65^{-/-} dogs. To conclude, our findings suggest (i) that subretinal administration of the therapeutic dose of rAAV2/4.hrpe65 does not induce a detectable immune response to the transgene or the AAV4 vector capsid, (ii) that sequential subretinal readministration of rAAV2/4.hrpe65 is safe and potent, (iii) that preexisting immunity to AAV4 does not block subretinal AAV2/4.hrpe65 mediated gene transfer.

Infectious Diseases and Vaccines I

208. Inhibition of Human Immunodeficiency Virus (HIV) Type 1 Replication through Expression of RNAi Effectors Targeting HIV-Dependency Factor HTATSF1

Victoria Green,¹ Patrick Arbuthnot,¹ Marco S. Weinberg.¹

¹Antiviral Gene Therapy Research Unit, Department of Molecular Medicine and Haematology, University of the Witwatersrand, Johannesburg, South Africa.

Given the high mutability of human immunodeficiency virus type 1 (HIV-1), an appealing antiviral strategy is to minimize the emergence of escape mutants by silencing cellular factors required for viral replication. Despite many putative HIV-1 dependency factors (HDFs) being identified in genome-wide screens, few have subsequently been validated as potential therapeutic targets. Ten RNA Pol III-driven short hairpin (sh) RNA cassettes were constructed targeting expression of the predicted HDF HTATSF1, and confirmed HDF p75 as a control. Three shRNAs targeting *htatsf1* decreased endogenous mRNA and protein levels by ~50%, as determined by qRT-PCR and Western blot, respectively. Processing of guide strands were confirmed by Northern blot, supporting silencing via an RNAi mechanism. No significant cytotoxic effects were observed on shRNA expression. TZM-bl cells, a luciferase reporter cell line, were used to determine the efficacy of shRNAs. HTATSF1-targeting shH1 significantly inhibited luciferase activity in a dose-dependent manner when transiently expressed in TZM-bl cells infected with various HIV-1 strains. shH1 also decreased infectious virion production by 68%. As CD4⁺ T cells are a physiological substrate of HIV, lentiviruses were used to generate T cell lines with stable shRNA expression. Replication kinetics of the HIV-1 molecular clone p81A-4 were determined from p24 antigen levels up to 18 days post-infection. SupT1 T cells with stable expression of shH1 exhibited decreased p24 production throughout the time course (<1% at day 10), and to a greater extent than the viral genome-targeting positive control. Moreover, HTATSF1 inhibition had no effect on splicing of cellular and viral transcripts but did slightly reduce cellular proliferation. The results demonstrate that post-transcriptional gene silencing of HTATSF1 can lead to decreased HIV-1 replication without cytotoxic effects in a T cell line. Anti-*htatsf1* RNAi effectors may, therefore, be a useful addition to existing HIV-1 combinatorial gene therapies.

209. Protection Against Divergent Influenza H1N1 Virus by a Centralized Influenza Hemagglutinin

Eric A. Weaver,¹ Richard Webby,² Michael A. Barry.¹

¹Mayo Clinic, Rochester, MN; ²St. Jude Children's Research Hospital, Memphis, TN.

Influenza poses a persistent worldwide threat to the human population. As evidenced by the 2009 H1N1 pandemic, current vaccine technologies are unable to respond rapidly to this constantly diverging pathogen. We tested the utility of adenovirus (Ad) vaccines expressing centralized consensus influenza antigens. Ad vaccines were produced within 2 months and protected against influenza in mice within 3 days of vaccination. Ad vaccines were able to protect at doses as low as 1e7 virus particles/kg indicating that approximately 1,000 human doses could be rapidly generated from standard Ad preparations. To generate broadly cross-reactive immune responses, centralized consensus antigens were constructed against H1 influenza and against H1 through H5 influenza. Twenty full-length H1 HA sequences representing the main branches of the H1 HA phylogenetic tree were used to create a synthetic centralized gene, HA1-con. HA1-con minimizes the degree of sequence dissimilarity between the vaccine and existing circulating viruses. HA1-con induced stronger

and broader protective responses than heterologous wildtype genes. HA1-con protected against three genetically diverse lethal influenza challenges. When mice were challenged with 1934 influenza A/PR/8/34, HA1-con protected 100% of mice while vaccine generated from 2009 A/TX/05/09 only protected 40%. Vaccination with 1934 A/PR/8/34 and 2009 A/TX/05/09 protected 60% and 20% against 1947 influenza A/FM/1/47, respectively, whereas 80% of mice vaccinated with HA1-con were protected. Notably, 80% of mice challenged with 2009 swine flu isolate A/California/4/09 were protected by HA1-con vaccination. These data show that HA1-con in Ad has potential as a rapid and universal vaccine for H1N1 influenza viruses.

210. Administration of AdC7-OprF Expressing the *P. aeruginosa* Protein OprF and Carrying the RGD Sequence in the Fiber Provides Longterm Mucosal Immunity without Increasing Cellular Immunity

Anja Krause,¹ Wen Zhu,¹ Yaqin Xu,¹ Ronald G. Crystal,¹ Stefan Worgall.¹

¹Weill Cornell Medical College, New York, NY.

Pseudomonas aeruginosa causes chronic infections of the respiratory tract, particularly in cystic fibrosis (CF). The outer membrane protein F (OprF) of *P. aeruginosa* is a promising vaccine candidate and our prior studies have shown that human (Ad5) and non-human primate (AdC7) Ad vectors expressing a secreted form of OprF evoke protective immunity against *P. aeruginosa*. Systemic or lung mucosal immunization with AdC7OprF induced robust lung mucosal immunity in the presence of pre-existing anti-Ad5 immunity. The present study focuses on the development of a 2nd generation AdC7 vaccine candidate which has the RGD sequence incorporated in the Ad fiber to enhance gene delivery to antigen presenting cells and to promote anti-transgene Th1 cellular immunity without affecting antibody responses. AdC7OprF and AdC7OprF.RGD were administered to C57Bl/6 mice via the intramuscular or intratracheal route at a dose of 10¹⁰ particle units (pu). Ad5Null was used as control. Anti-OprF IgG and IgA serum titers, analyzed by ELISA, were similar following intramuscular immunization with AdC7OprF.RGD compared to AdC7OprF at 4 and 8 wk ($p > 0.09$, all comparisons). Interestingly, the serum anti-OprF IgG titer following intratracheal immunization with AdC7OprF.RGD were 2- and 3.5-fold increased at 4 and 8 wk, respectively compared to immunization with AdC7OprF ($p < 0.04$, all comparisons). Similar results were obtained analyzing anti-OprF IgA titers with a 3- and 5-fold increase at 4 and 8 wk after intratracheal immunization of AdC7OprF.RGD compared AdC7OprF ($p < 0.03$, all comparisons). To analyze the cellular anti-OprF response lung CD3⁺ T cells were isolated from mice immunized via the intramuscular or intratracheal route with AdC7OprF and AdC7OprF.RGD after 8 wk and were stimulated with either syngeneic splenic or pulmonary dendritic cells (DC) pulsed with OprF for 3 days. Intracellular anti-OprF Th1 cytokine profiles for IL-12 and IL-17 and anti-OprF Th2 cytokine profiles for IL-4 and IL-5 in splenic and pulmonary CD4 T cells of animals immunized with AdC7OprF.RGD were similar to those immunized with AdC7OprF ($p > 0.06$, $p > 0.08$, respectively; all comparisons). Also, Th1 INF- γ responses in CD8 T cells from spleen and lung were similar following immunization with AdC7OprF compared to AdC7OprF.RGD. These findings are in contrast to our previous findings with RGD-modification of an Ad5-based vector expressing OprF or other transgenes. To evaluate the effect of the RGD sequence in the AdC7 capsid on infectivity of antigen presenting cells, human monocyte-derived DC were infected *in vitro* with 10⁴ pu of Ad5OprF, Ad5OprF RGD, AdC7OprF and AdC7OprF.RGD and analyzed by Realtime RT-PCR. As previously shown, infection with Ad5OprF.RGD resulted in an 8-fold higher OprF expression compared to Ad5OprF. In contrast, AdC7OprF.RGD only lead to a 2-fold increase

in OprF expression compared to AdC7OprF. This data suggests that RGD-modification to the fiber of an AdC7-based vector can induce higher humoral immunity following lung mucosal immunization without affecting the Th1-cellular response.

211. Combination of CCR5delta32 and shRNAs Targeting HIV

Ekta Patel,¹ Starlyn Okada,¹ Yingchi Chen,² Miao-Fen Chao,³ Qingwen Jin,⁴ Li-Min Huang,³ Ghalib Alkhatib,⁴ Lung-Ji Chang.¹
¹Department of Molecular Genetics and Microbiology, University of Florida, Gainesville, FL; ²Vectorite Biomedica Inc, Taipei, Taiwan; ³Department of Pediatrics, National Taiwan University, Taipei, Taiwan; ⁴Department of Biomedical Sciences, Texas Tech University, El Paso, TX.

To establish a gene and cell based therapeutic approach for the treatment of HIV/AIDS, we constructed lentiviral vectors (LVs) encoding shRNAs targeting endogenous CCR5, miRNAs targeting highly conserved HIV-1 sequences and a codon-optimized CCR5delta32 gene that can down-regulate endogenous CCR5 and CXCR4. Resistance to HIV-1 was demonstrated by using LV-modified hematopoietic stem cells (HSCs). LVs carrying the codon-optimized CCR5delta32 gene, H1-promoter driven CCR5-28mer shRNA and three miRNA intronic cassettes (miR155, 19a, 30a) against HIV-1 pol, int and vpu were sequence confirmed and packaged into virus particles. All vectors produced high titer virus as demonstrated by qPCR of proviral DNA in infected cells and coexpression of 2A-fused red fluorescent protein (RFP). Significant resistance to HIV-1 infection and envelope-mediated fusion was observed upon using these LVs to target HOS-R5 cells that endogenously express CD4, CCR5 and CXCR4. Expression of endogenous CCR5 was inhibited more than 90% after LV CCR5shRNA gene transfer as demonstrated by flow cytometry. The codon-optimized CCR5delta32 cDNA was constructed as a 2A-RFP fusion gene and after LV transduction of HOS-R5 cells, high expression of CCR5delta32 and RFP was coupled with reduced expression of CCR5 as well as CXCR4. LV transduction of CCR5 shRNA, codon-optimized CCR5delta32 and the triple miRNA intronic cassettes, individually or in combination, demonstrated various degrees of antiviral effects. Resistance to HIV persisted after prolonged passages of the LV-transduced HOS-R5 cells, demonstrating the stability of the integrated anti-HIV provirus. For safety and efficacy analyses, protection against HIV-1 infection of the LV-modified HSCs has been demonstrated following differentiation *in vitro* into functional dendritic cells and T cells. Our goal is to generate a population of genetically modified stem cells that can establish stable HIV resistance in all lineages of differentiated cells after autologous transplantation.

212. Post-Exposure Treatment with a Human Adenovirus 5 Vector-Based Combination Therapy Against Zaire Ebolavirus and Avian Influenza H5N1 in Small Animals

Ami Patel,^{1,2} Jason Richardson,¹ Jane Ennis,³ Jeff Turner,³ Gary P. Kobinger.^{1,2}

¹Public Health Agency of Canada, Winnipeg, MB, Canada;

²Medical Microbiology, University of Manitoba, Winnipeg, MB, Canada; ³Defyris Inc., Toronto, ON, Canada.

Cytokine therapy can effectively modulate immune responses and has been studied in combination with gene therapy, cancer immunotherapy, and vaccines against infectious diseases to increase immune reaction or tolerance. One cytokine, type I interferon, has been evaluated as an anti-viral against several viruses leading to acute or persistent infections. Interferon alpha (IFN α) inhibits viral translation and several RNA viruses including Zaire Ebolavirus (ZEBOV) and avian influenza H5N1 can interfere with its production.

It has been considered that the administration of IFN α could be advantageous immediately following a suspected exposure to improve overall clinical outcome. Delivery of IFN α by adenovirus-based vector to transiently express interferon early during viral infection has been tested as an alternative to recombinant IFN α which has a short half-life and a prohibitive cost. We have developed an improved Ad-based vaccine expressing the ZEBOV glycoprotein (AdHu5-ZGP) capable of stimulating complete post-exposure immune protection against ZEBOV in mice but not in guinea pigs. In the current study, post-exposure protection was evaluated in mice and guinea pigs following co-administration of a human adenovirus 5-based vector expressing IFN α (AdHu5-IFN α) and AdHu5-ZGP. Groups of B10Br mice and Hartley guinea pigs were immunized with AdHu5-IFN α , AdHu5-ZGP, or a combination of (AdHu5-IFN α +AdHu5-ZGP) at 30 minutes, 24hours, and 48hours following challenge. Vaccination with AdHu5-IFN α alone provided effective post-exposure treatment against lethal ZEBOV challenge in B10Br mice. In guinea pigs, the AdHu5-IFN α and AdHu5-ZGP groups both offered partial protection against lethal ZEBOV challenge. Full protection was achieved through combination of (AdHu5-IFN α +AdHu5-ZGP) by intramuscular or intranasal administration 30 minutes post-exposure. Improved protection was also observed when (AdHu5-IFN α +AdHu5-ZGP) was administered 24 hours after lethal challenge with ZEBOV. Combination of AdHu5-IFN α to a porcine adenovirus 3 vector expressing the A/Hanoi/30408/2005 H5N1 haemagglutinin antigen (PAV3-HA) which demonstrated better post-exposure protection than an AdHu5-based vaccine was also evaluated at 1, 2, 5, and 8 days post-exposure to lethal challenge with H5N1 virus. Together, the data supports the importance of IFN α production early after viral infection to improve clinical outcome to lethal challenge in small animals. Interestingly, co-administration of AdHu5-IFN α +AdHu5-ZGP at the same site potentiate post-exposure survival suggesting that IFN α may adjuvant Ad-based vaccine. Future evaluation of the interferon therapy in combination with post-exposure vaccine treatment in larger animals modelling aggressive human infectious diseases is warranted.

213. Lentivector Expressing HBsAg and Immunoglobulin Fc Fusion Antigen Induces Potent Immune Responses and Results in Seroconversion in HBsAg Transgenic Mice

Yuan Hong,¹ Yibing Peng,¹ Michael Mi,² David H. Munn,¹ Guiqiang Wang,³ Yukai He.¹

¹*Immunology/Immunotherapy Program, MCG Cancer Center, Medical College of Georgia, Augusta, GA;* ²*Harvard Medical School, Harvard University, Boston, MA;* ³*Department of Infectious Diseases, Peking University First Hospital, Beijing, China.*

Even though hepatitis B virus (HBV) vaccines effectively prevent new cases of HBV infection, with approximately 350 million patients worldwide, chronic HBV infection remains a major health problem because of the associated complications (such as liver cirrhosis and hepatoma) and the limited treatment options. Immunotherapy has the potential to effectively control HBV replication. In this current study, we found that compared to DNA vaccines, recombinant lentivectors could induce much more potent HBV surface antigen (HBsAg) specific T cell responses and humoral immune responses. Tagging the HBsAg with immunoglobulin Fc fragment further substantially increased the HBsAg specific immune responses. Remarkably, the HBS-Fc-Iv lentivector could effectively break immune tolerance and induce potent HBsAg specific adaptive immune responses in HBsAg transgenic (Tg) mice with low serum level of HBsAg. More importantly, the induction of HBsAg specific immune responses in Tg mice accompanied seroconversion from HBsAg to anti-HBsAg

antibody (anti-HBsAb). Our study demonstrated the potential of utilizing lentivector to treat chronic HBV infection following reduction of viral load with antiviral drug therapy.

214. Passive Immunization Strategy for Pandemic Influenza Using AAV Delivery of Broadly-Neutralizing Antibodies

Virginie S. Adam,¹ James M. Wilson,¹ Maria P. Limberis.¹

¹*Gene Therapy Program, Department of Pathology & Laboratory Medicine, University of Pennsylvania, Philadelphia, PA.*

Seasonal influenza, principally caused by human H3N2 and H1N1 subtypes, is responsible for 3-5M cases of severe illness and 250,000-500,000 deaths per year. In June 2009, the World Health Organization declared swine H1N1 influenza virus (different from the human H1N1 seasonal strain) a new pandemic. This virus has acquired efficient human to human transmission and caused an estimated death toll of 17,000 between April 2009 and April 2010. Influenza therefore remains a significant healthcare burden, particularly to infants and the elderly, and the emergence of novel strains is a threat to the global population. The majority of the natural immune response mounted by an infected host is directed towards the highly mutagenic head of the viral haemagglutinin protein and is thus strain-specific. Recently, broadly-neutralizing antibodies that bind a conserved epitope on the stem of haemagglutinin have been isolated using phage display to screen B-cell libraries from human donors (Throsby, 2009; Sui, 2009). These have been shown to neutralize all Group 1 influenza viruses, including the H5N1 ("bird" flu) and the swine and human H1N1 strains. We harnessed the neutralizing capabilities of these antibodies by cloning them into adeno-associated virus (AAV) serotype 9, in order to obtain high expression levels of the antibodies in animal hosts. Protein expression levels were verified *in vitro* by Western Blot and ELISA. Mice were then injected with 10¹¹ genome copies of AAV9 intranasally or intravenously, and antibody expression levels in the lungs and in the serum were assessed over a period of 28 days. Currently, we are evaluating the protective efficacy of various AAV-expressed influenza-specific antibodies in BALB/c mice challenged with mouse-adapted PR8 virus or influenza A/California/04/2009.

215. Strategies for Therapeutic Vaccination: Electroporation-Mediated Delivery of DNA Vaccines in the Woodchuck Hepatitis Model

Claire F. Evans,¹ Katherine H. Liu,² Mary A. Ascenzi,² Christine A. Bellezza,² Abraham J. Bezuidenhout,² Alain Luxembourg,¹ Drew W. Hannaman,¹ Paul J. Cote,³ Bud C. Tennant,² Stephan Menne.^{2,3}

¹*Ichor Medical Systems, San Diego, CA;* ²*Department of Clinical Sciences, College of Veterinary Medicine, Cornell University, Ithaca, NY;* ³*Department of Microbiology & Immunology, Georgetown University Medical Center, Washington, DC.*

Despite the availability of a range of antiviral drugs for treatment of chronic hepatitis B virus (HBV) infection, clinical outcomes remain suboptimal for many patients, indicating that novel approaches for treating chronic HBV infection are needed. Interestingly, in chronically infected HBV individuals who received bone marrow transplants from HLA-matched donors with natural immunity to HBV, transfer of HBV specific T cells was associated with resolution of HBV infection (Lau *et al.* 2002). These findings suggested that generation of antiviral cellular immunity in chronically infected individuals may be a means of achieving durable remission or cure of HBV infection. One approach for generating antiviral cellular immunity is through therapeutic vaccination. Several vaccine platforms are being evaluated for therapeutic HBV vaccination, including the use of DNA vaccines. DNA vaccines are particularly suited for HBV since they promote broad cellular and humoral immune responses, especially when delivered with electroporation

(EP). In the present studies, EP-mediated delivery of DNA vaccine candidates for treatment of chronic HBV infection was evaluated in the woodchuck hepatitis virus (WHV) animal model. Initial studies in WHV-naïve woodchucks confirmed enhanced reporter gene expression following EP-mediated delivery when compared to conventional intramuscular administration. Immunogenicity of DNA vaccine candidates encoding WHV antigens delivered with EP was previously demonstrated in rodents and rabbits (Luxembourg *et al.* 2008). EP-based delivery of a construct encoding the WHV surface antigen into WHV-naïve woodchucks resulted in dose-dependent T cell and antibody responses to WHsAg that were enhanced compared to conventional intramuscular injection. In addition, EP-based vaccination induced a shift in the Th1/Th2 balance with a skew toward Th1 immune responses that is considered beneficial for therapeutic vaccination in chronic HBV infection. These encouraging results provided the impetus for evaluating EP-mediated delivery of WHV DNA vaccine candidates in woodchucks chronically infected with WHV to provide proof of concept for this approach in humans with chronic HBV infection. Given the emerging consensus supporting the combination of immunotherapy and antiviral therapy in chronic viral infections, incorporation of antiviral therapy in these studies was considered a key component of the study design. Response to therapeutic immunization following EP-mediated delivery of DNA vaccines encoding WHV antigens with or without antiviral therapy in chronically infected woodchucks is currently being evaluated.

216. Porcine Adenovirus 3 or Human Adenovirus 5 Vectors Expressing HA and NP Does Not Improve Cross-Clade Protection Against Avian Influenza H5N1

Ami Patel,^{1,2} Suresh K. Tikoo,³ Yan Li,¹ Gary P. Kobinger.^{1,2}
¹Public Health Agency of Canada, Winnipeg, MB, Canada;
²Medical Microbiology, University of Manitoba, Winnipeg, MB, Canada;
³Vaccine and Infectious Disease Organization/University of Saskatchewan, Saskatoon, SK, Canada.

Experimental vectors offer unique alternatives to traditional vaccines for improving protection against emerging infectious diseases. Adenovirus-based vectors such as porcine adenovirus 3 (PAV3) and human adenovirus 5 (AdHu5) have demonstrated protective efficacy and generation of robust immune responses against several infectious disease agents including H5N1 avian influenza virus. Combining multiple Ad-based vaccines expressing variable and conserved H5N1 antigens could potentially improve cross-protection against antigenically different H5N1 viruses. The current study evaluates protection and immune responses following co-administration of either PAV3 or AdHu5-based vaccines expressing two different influenza antigens against matched and divergent H5N1 viruses. Optimized expression cassettes containing the A/Hanoi/30408/2005 (H05) hemagglutinin (HA) or nucleoprotein (NP) genes were inserted into replication incompetent PAV3 (PAV3-HA, PAV3-NP) or AdHu5 (AdHu5-HA, AdHu5-NP) vectors. Vaccine efficacy was first monitored in BALB/c mice following lethal homologous H05 challenge. Groups of mice were also challenged with two heterologous H5N1 viruses representing different clades: A/Hong Kong/483/1997 (HK97) and A/Indonesia/05/2005 (In05). Although both AdHu5-HA and PAV3-HA shared comparable protective efficacy against matched H05 virus, significantly better protection against divergent HK97 or In05 virus was observed in lethally challenged mice immunized with the PAV3-HA vaccine. To assess if co-administration of multiple Ad-based vaccines could improve cross-protection, (PAV3-HA+PAV3-NP) or (AdHu5-HA+AdHu5-NP) were combined at a single immunization site. Interestingly, more severe signs of disease were observed against H05 following addition of the NP antigen to either vaccine. Reduced protection was also observed following vaccination with (PAV3-HA+PAV3-NP) and

(AdHu5-HA+AdHu5-NP) against HK97. No detectable difference in protection was observed against In05. Antibody and T-cell responses were also monitored to assess immune responses post-immunization. Higher hemagglutination inhibition antibody titres against HK97 and In05 were detected following PAV3-HA vaccination. Addition of NP did not significantly change antibody titres. Interestingly, T-cell responses against HA were equivalent following co-administration of (PAV3-HA+PAV3-NP) or (AdHu5-HA+AdHu5-NP) but reduced activation was detected against the NP antigen. Overall, the data suggests that combining adenovirus vectors expressing HA+NP does not enhance protection against lethal challenge with matched or divergent H5N1 viruses. An intriguing finding is that the addition of NP can interfere with protection provided against some H5N1 virus isolates. Further assessment of underlying immune mechanisms and the role of antigen competition will be necessary to expand cross-clade protection against antigenically diverse H5N1 viruses.

217. HIV Latency: Overcoming Transcriptional Block (Initiation and Elongation)

Suresh K. Arya.¹

¹National Cancer Institute, National Institutes of Health, Bethesda, MD.

Beyond developing vaccine, curtailing HIV latency is the biggest challenge. There is no cure, and there will not be any cure, unless the latently infected cells are purged from the body. One ideal solution would be to design 'molecular scissors' that will scan the host genome and snip out integrated viral genome(s). However, our ability to do so is not there - yet. The major cause of latency is thought to be a transcriptional block where no viral genes are expressed, the infected cell is not marked to elicit host response or be responsive to HAART. The cell with reactivated virus expression could be subjected to immuno- or chemotherapeutic elimination. The virus uses a number of mechanisms to mute transcription to achieve and maintain latency. These include epigenetically silenced chromatin sites of integration, defect in transcriptional initiation, and block in transcriptional elongation. An additional hypothesis of transcription interference states that transcription initiated at the cellular promoter reads through the viral promoter, thus precluding the assembly of transcriptional complexes on the viral promoter itself. Much of the current effort to overcome transcriptional block has focused on activation of transcriptional initiation, such as by activating the NFκB pathway with phorbol esters, by chromatin remodeling with HDAC inhibitors, and by demethylating the viral promoter with AzaCdR. Not much effort has been expended in correcting transcriptional elongation. Elongation block could result from Tat insufficiency. Tat is the viral elongation factor, required for viral transcription. As a prelude to preclinical studies with patient CD4+ cells, we tested the idea of elongation block by using cell culture model of HIV latency (J-Lat set of cells, NIH AIDS Reagent Program. Several of these cell lines carry Env-truncated full length HIV-1 genome with the GFP gene in cis, and where virus expression is scored by GFP read-out. We demonstrate that genetically introduced extra copies of Tat indeed enhanced virus expression. Tat was provided in trans with lentiviral vectors, where Tat was directed by the hCMV or hTERT promoter. Tat by itself had only minimal effect, but in combination with NFκB activator Prostratin, it further enhanced virus expression several folds. For example, for J-Lat 6.3 cells (Env-, GFP+ provirus), preliminary results of the percentage of GFP+ cells in culture were: No treatment, 0.3 ± 0.2; Tat, 0.6 ± 0.2; Prostratin, 7.1 ± 2.1; Tat + Prostratin, 34.2 ± 7.2. Preliminary results with AzaCdR are presently unclear - with AzaCdR alone, there was little or no activation. Addition of Tat did not induce significant further activation. One interpretation would be that transcriptional initiation must be induced before Tat can promote elongation, and that in these experiments AzaCdR treatment

(in contrast to Prostratin treatment) did not induce transcriptional initiation. Experiments with the HDAC inhibitor SAHA alone and in combination with Tat are in progress.

218. Production and Characterization of Monoclonal Antibodies Against *Brucella melitensis* Bp26 for Mapping the Antigenic Epitope

Jinlang Qiu,¹ Wenjing Wang,¹ Hui Zhang,² Yuanzhi Wang,² Ling Zhang,¹ Yixin Bian,¹ Hongwei Li,¹ Chuangfu Chen,² Chengyao Li.¹
¹*School of Biotechnology, Southern Medical University, Guangzhou, Guangdong, China;* ²*Animal Science and Technology College, Shihezi University, Shihezi, Xinjiang, China.*

Periplasma protein bp26 was identified as an important diagnosis antigen in Brucellosis. However, current diagnostic assays can not identify the animals wildly infected by *Brucella* species from the vaccinated. Molecular marker within vaccine has been considered as a way to solve the weakness of *Brucella* vaccines. This study was to reveal antigenic epitopes of bp26 in order to genetic modification of a current *Brucella* vaccine M5-90. A total of 29 monoclonal antibodies (mAb) against *Brucella melitensis* bp26 were produced and then tested by Peptide-ELISA, Western-Blot, and Dot-ELISA. MAbs were classified into three statuses: recognition for linear, semi-conformational and conformational epitopes. To map epitopes, 28 of 16 mers overlapping peptides spanning the entire protein bp26 were synthesized. By Peptide-ELISA, 11 mAb clones reacted with three overlapping peptides, in which clone 3D7, 3H5 and 4D9 recognized peptide 11 (P11), clone 2A4, 2H9, 3H6 and 5F12 recognized P12 and 1G1, 5A5, 5B12 and 7C6 recognized both P12 and P13, respectively. For fine mapping the mAbs reactive epitopes, 12 of shorter overlapping peptides (9 mers) from P11 and P12 were synthesized. Competitive inhibition ELISA (CIEIA) was performed to determine the epitopes recognized by mAb 3H5, 2A4 and 5A5. The results showed that two linear epitopes were discovered by recognition with 3H5 or 2A4 that both reacted to the sera from vaccinated and infected sheep. These two linear epitopes could be potentially used for molecular markers of *Brucella* vaccines. *equal contribution.

219. GLA Synergize with Dendritic Cell-Directed LV for an Improved Immune Response

Liang Xiao,¹ Matt Lin,¹ Jocelyn Kim,² Lili Yang,² Pin Wang.¹
¹*Mork Family Department of Chemical Engineering and Material Science, University of Southern California, Los Angeles, CA;* ²*Division of Biology, California Institute of Technology, Los Angeles, CA.*

Lentivectors(LVs) enveloped with Sinbis virus glycoprotein have been shown to target dendritic cells (DCs) in vitro and in vivo. These LVs can successfully generate both T cell and B cell immune responses against antigens expressed by the encoded transgene in mouse studies. DC-directed LVs have been shown to activate DCs by slightly upregulating the surface markers. In order to improve the immune response generated by this vector system, combinations of targeting LVs with TLRs agonist can be a promising strategy. GLA (glucopyranosyl lipid A), unlike LPS and MPL that are extracted from bacteria, is a novel and chemically synthesized agonist for TLR-4. Thus GLA may pose less safety concerns while maintaining its TLR-4 stimulation effect. In this study, we found that GLA-stimulated BMDC in vitro greatly enhanced the surface activation markers and the secretion of some important cytokines and chemokines; this activation is strictly TLR-4 dependent, as a TLR-4 KO BMDC does not display this activation. We further assessed the effect of immunization by combining targeting LVs with GLA; this combination exhibited a significantly greater response of CD8 and CD4 T cells than that of the targeting LVs alone. Combination with GLA also enhanced the titers of different isotypes of antibodies

against the antigen. Taken together, an increase in T cell and B cell responses resulted in better tumor protection in both the preventive and the therapeutic EG.7 tumor challenge model. In a CD4 depletion experiment, we found that improved cytotoxic CD8 T cell response to GLA is CD4 T cell-dependent. Furthermore, the downstream signaling pathway of TLR-4 bound with GLA is both MyD88 and TRIF dependent; these conclusions were established by observing the surface activation markers and cytokine and chemokines secretions. However the MyD88 pathway is favored more as shown by the secretion of IL-6, TNF- α and IL-1- β being almost MyD88-dependent in a knockout BMDC study. In a later immunization study, using MyD88 and TRIF KO mice, we observed that GLA's adjuvant effect is MyD88-dependent. Conversely, combination with GLA in TRIF KO mice can still improve T cell response. The results of this study show that immune response generated by the DC-directed LVs can be greatly improved by the use of GLA adjuvant targeting TLR-4 and the adjuvanting effect is mediated through a MyD88 biased pathway.

Cancer - Immunotherapy I

220. Chemotherapy in Combination with T-Cell Therapy Results in Significant Antitumor Activity and Improved Clinical Outcomes for EBV-Associated Nasopharyngeal Carcinoma

Marissa Teo,¹ John Chia,¹ Peter Wang,¹ David Tai,¹ Joanna Ng,¹ ChitLai Chee,¹ Fei Gao,² SzeHuey Tan,² SooFan Ang,¹ Yatanar Soe,¹ Stephen Gottschalk,³ HanChong Toh.¹
¹*Medical Oncology, National Cancer Centre, Singapore, Singapore;* ²*Clinical Trials and Epidemiological Sciences, National Cancer Centre, Singapore, Singapore;* ³*Pediatrics and Immunology, Center for Cell and Gene Therapy, Baylor College of Medicine, Houston, TX.*

Advanced nasopharyngeal carcinoma (NPC) is overall incurable. Presence of EBV makes adoptive immunotherapy with EBV-specific cytotoxic T cells (EBV-CTL) an attractive therapeutic option. This phase II clinical study aims to evaluate safety and efficacy of standard cytoreductive combination chemotherapy followed by serial infusions of autologous EBV-CTL. Patients with metastatic or locally recurrent NPC received, as first line therapy, 4 cycles of gemcitabine and carboplatin on days 1,8,15 every 4 weeks, followed by 6 cycles of EBV-CTL prepared using autologous lymphoblastoid cell lines as antigen presenting cells(induction dose of $1 \times 10^8/m^2$ weekly x2 followed by maintenance of $1 \times 10^8/m^2$ every 8 weeks x4). 38 de novo metastatic(n=19), locoregionally recurrent(n=9) or both(n=10) NPC patients were enrolled, making it the largest phase II clinical study of chemo/immunotherapy for NPC. 35 patients completed 4 cycles of gemcitabine and carboplatin. 33 patients completed at least 3 cycles of CTL and 5 patients came off study due to rapid progressive disease. CTL lines were predominantly CD8+ (mean87.62%), and contained a mixture of effector memory (mean43.85%), late effector memory (mean14.63%), and central memory T cells (mean1.66%). All 33 CTL lines contained T cells specific for immunodominant EBV antigens EBNA3s and/or BZLF1. 29 CTL lines contained T cells specific for EBV antigens predominantly expressed in NPC: LMP2(n=24), LMP1(n=7), and EBNA1(n=4). Infusions were well tolerated with no dose limiting toxicity. Objective response rate (ORR includes CR and PR) after chemotherapy was 62.2% and clinical benefit rate (CBR includes CR, PR and SD) was 94.6%. ORR post CTL infusion was 24.2% and CBR was 66.7%. Overall response rate was 64.9% with CBR of 97.3%. Intent to treat analysis of all 38 patients revealed a median progression-free survival (PFS) of 7.73 months. The 2-year OS for this trial to date, was higher (62.6%;95% CI: 41.6-77.8 vs 46.4%; 95%CI:27.6-63.3) when compared to historic controls (n=28) treated at our center with optimal 4-drug chemotherapy(paclitaxel,gemcitabine,carboplatin and 5-Fluorouracil). Plasma

EBV-DNA load significantly correlated with tumor load as judged by imaging (Spearman's $\rho=0.466, p=0.016$). IFN γ Elispot analysis in peripheral blood of patients did not reveal significant correlation between precursor frequency of CTL post infusion and response. However, OS correlated with presence of LMP2-specific T cells in CTL with a median follow up of 16.3 months ($p=0.021$). In conclusion, combining gemcitabine and carboplatin followed by autologous polyclonal EBV-CTL is feasible and safe, and results in significant clinical anti-tumor activity, especially if infused CTL contains T cells specific for LMP2. Our results warrant further exploration of chemo/immunotherapy for EBV-positive NPC.

221. A Novel Single Chain Chimeric Antigen Receptor Framework Provides Tumor Reactivity of Retrovirally Transduced Human T Cells towards an erbB2⁺ Breast Carcinoma Cell Line

Ralf-Holger Voss,¹ Winfried S. Wels,² Matthias Theobald.¹

¹Department of Hematology and Oncology, Universal Medical Center of Johannes Gutenberg-University, Mainz, Germany;

²Chemotherapeutisches Forschungsinstitut, Georg-Speyer-Haus, Frankfurt am Main, Germany.

One approach of cellular human gene therapy relies on the heterologous expression of tumor-reactive molecules in human T-cells to eradicate tumor cells after their adoptive transfer in tumor patients. For this either T-cell receptors (TCR) that recognize class I-complexed tumor associated antigens (TAA) or antibody fragments (Fv) that recognize tumor-specific antigens were genetically designed so as to accomplish maximal expression and target specificity in human T-cells. The transfer of double chain (dc) TCRs into human T-cells poses the risk that the transferred TCR α and β chains may form mispaired dimers with endogenous TCRs potentially leading to autoimmunity. To prevent this, we recently developed a novel 3-domain single chain (sc) TCR framework of the domain order V α -Linker-V β -C β specific for the Melanoma-derived TAA gp100(280-288). The scTCR was functionally triggered by coexpression of an extra domain, a modified TCR C α -domain comprising a TCR α signal peptide spliced in front of the C α domain for being secreted as an autonomous membrane protein. Importantly, this approach obviates the need to chimerize the antigen recognizing moieties to the signalling molecule CD3 ζ that hitherto classical scTCR-approaches needed to do and thus, might have resulted in non-native T-cell signalling. Since mispairing was substantially reduced this in turn may have increased the number of therapeutic molecules on the T-cell surface. Here, we assessed whether this approach may be generalized to an antibody V_H/V_L-linked Fv-fragment as antigen recognizing particle that targets a breast carcinoma cell line overexpressing a Her2/neu (erbB2)-specific tumor antigen so as to generate a novel single chain antigen receptor (scCAR). For this, we hooked up the FRP5 Fv-fragment on a C β -domain derived from a mouse TCR β and coexpressed the scCAR with the C α domain in human T-cells by retroviral gene transfer. We were able to demonstrate superior expression of the 4-domain scCAR/C α on a Jurkat cell line devoid of endogenous TCRs when murinized in their C-domains and covalently attached by an artificial disulfide bond at their C-domains interface. Additionally, both CD4⁺ T-cells secreted IFN γ and CD8⁺ T cells lysed an erbB2⁺ carcinoma cell line with high specificity and efficacy when compared to a mock control. Importantly, a breast carcinoma cell line deficient in erbB2 expression was not recognized at all. Currently, we are studying the amount of intracellular T-cell signalling in comparison to a classical scCAR by phosphorylation of downstream effector molecules such as ZAP-70 and are verifying the amount of mispairing of such a scCAR compared to a scTCR with endogenous TCR chains. Furthermore, we are going to establish an in vivo mouse model to further reveal the usefulness of our novel scCAR-approach for the adoptive immunotherapy of cancer diseases.

222. GM-CSF Gene Transduced Murine Cancer Stem Cells Eliminate Tumorigenicity In Vivo

Chika Sakamoto,¹ Hiroyuki Inoue,¹ Yusuke Murakami,¹ Yosuke Yokota,¹ Megumi Narusawa,¹ Shohei Miyamoto,¹ Ayumi Watanabe,¹ Makoto Inoue,² Koichi Takayama,³ Mamoru Hasegawa,² Yoichi Nakanishi,³ Kenzaburo Tani.¹

¹Division of Molecular and Clinical Genetics, Medical Institute of Bioregulation, Kyushu University, Fukuoka, Japan; ²DNAVEC Corporation, Tsukuba, Japan; ³Institute of Diseases of Chest, Kyushu University, Fukuoka, Japan.

Recently, cancer stem cells (CSCs), intrinsically resistant to standard chemotherapies, have gained significant recognition as the pivotal player of tumorigenesis. In clinical settings, it has been shown that autologous granulocyte macrophage-colony stimulating factor (GM-CSF) gene-transduced tumor vaccine therapy (GVAX) is safe, and has substantial antitumor effects against various cancers. However, its efficacy is limited, presumably because CSCs manage to survive by escaping host's antitumor immunity. Thus, we hypothesized whether enriched CSCs subpopulation had a susceptibility to antitumor immunity provoked by GM-CSF. In this study, we used the Hoechst33342 dye-based side population (SP) technique to isolate CSCs from a 4T1 murine breast cancer cell line. Our in vitro assays revealed that isolated SP cells showed a markedly higher colony formation and repopulation ability than that of non-SP and whole cells. In addition, our in vivo tumor formation assay showed that SP cells elicited significantly higher tumorigenesis than non-SP cells. Regardless of the higher tumorigenic property of SP cells, GM-CSF gene transduced SP cells (SP/GM) had less tumorigenicity in vivo than GFP gene transduced SP cells (SP/GFP) or parental SP cells, suggesting that SP cells possess sufficient sensitivities to immunological responses induced by GM-CSF. Subsequently, to gain detailed insights into the antitumor mechanism, we examined whether the antitumor effect observed in mice treated with SP/GM cells was influenced by the depletion of CD4⁺T cells, CD8⁺T cells and NK cells, respectively, during the tumor formation assay as described above. The result showed that the tumor rejection observed in mice treated with SP/GM cells was robustly abrogated in the mice depleted of CD8⁺T cells, implicating that CD8⁺T cells (CTLs) are indispensable for the tumor rejection. Furthermore, our repeated flow cytometric analyses showed that dendritic cells of tumor draining lymph nodes (TDLNs) harvested from mice injected with non-SP/GM cells or SP/GM cells elicited higher expression level of several co-stimulatory molecules, as compared with those from mice injected with non-SP/GFP cells or SP/GFP cells. Collectively, our results revealed that murine breast cancer stem cells are susceptible to antitumor CD8⁺T cell immunity induced by GVAX in vivo and offer promising prospect that GVAX therapy targeting CSCs sheds hopeful light on patient with advanced cancer.

223. Estimation of T Cell Receptor (TCR) Diversity by Next Generation Sequencing Technologies

Eliana Ruggiero,¹ Ali Nowrouzi,¹ Anne Arens,¹ Hanno Glimm,¹ Manfred Schmidt,¹ Christof von Kalle.¹

¹Translational Oncology, National Center for Tumor Diseases and German Cancer Research Center, Heidelberg, Germany.

T lymphocytes specifically recognize antigenic peptides presented by class I or II major histocompatibility complex (MHC) molecules through their heterodimeric α - β T cell receptor (TCR). The antigenic specificity is mainly determined by the complementarity determining region 3 (CDR3) that originates during T cell development in the thymus from the somatic rearrangement of variable (V), diversity (D, for the β chain), joining (J) and constant (C) segments. The high number of V, D and J segments constituting the TCR locus together

with the activity of the terminal deoxynucleotidyl transferase adding or deleting nucleotides at the rearranging locations, lead to the great variability of the TCR repertoire. Based on our expertise on high resolution integration site and clonality analyses using standard and non-restrictive (nr) linear amplification-mediated (LAM) PCR, we have established a novel unbiased methodology (TCR nrLAM-PCR) and deep sequencing for the in-depth characterization of the TCR locus. The advantage of our technique relies on the possibility to amplify different TCRs in one reaction independently of multiple simultaneous PCRs and other 'biasing' factors. At first, we analyzed a monoclonal sample derived from a T cell single clone and we could show the specificity of our methodology by identifying only the expected V and J region constituting the processed clone. We then started to analyze polyclonal conditions derived from peripheral blood cells of 3 different healthy donors and, with a low number of unique sequences ranging from 1100 to 2300 (Donor 1: 2300 sequences, Donor 2: 1700 sequences, Donor 3: 1100 sequences), we could already achieve the unequivocal identification of TCR β chain clonality for every sample by providing a precise measurement of TCR V and J usage, TCR V-J pairing and CDR3 diversity. Even with such a small number of TCR sequences as 2300 retrieved from Donor 1, we could characterize the vast majority of TCR genes (functional and pseudogenes). More in detail, we identified a high number of V (65%) and J genes (92%), every D and C segment and 167 different V-J pairings. Furthermore, we observed that the number of unique sequences analyzed in the different datasets correlated well with the number of different V and J genes detectable, e.g. for Donor 1 by increasing the amount of sequences to 44000 we identified nearly every V region (86%) expressed in the TCR locus. Most importantly, we could obtain a deep analysis of the CDR3 nucleotide/amino acid sequence giving information on the abundance of a specific T cell clone and on the functional status of the T cell population. More in detail, we observed that more than 50% of TCR clonotypes revealed a CDR3 length between 39 and 42 nt. Solexa sequencing is now in process to reach millions of TCR sequences for 5 different healthy donors. Our preliminary results show the feasibility of our approach to monitor the constitution, complexity and dynamics over time of immunogenetic reactions in humans and in mouse models and will allow us to establish a database for the identification of disease-specific T cell repertoires.

224. Targeting B-Cell Malignancies with Chimeric Antigen Receptor-Modified $\gamma\delta$ T Cells

Drew C. Deniger,¹ Harjeet Singh,¹ Helen Huls,¹ Simon Olivares,¹ Laurence J. N. Cooper.¹

¹Pediatrics, The University of Texas MD Anderson Cancer Center, Houston, TX.

Chimeric antigen receptors (CARs) are used to re-direct the specificity of T cells independent of T-cell receptor (TCR) and major histocompatibility complex (MHC) interaction. B-cell malignancies have been targeted via CARs specific for the B-lineage cell-surface antigen CD19 and clinical trials are investigating adoptive transfer of CD19-specific CAR⁺ T cells. T cells can be defined into two subsets based on their TCR isotype, of which the TCR $\alpha\beta$ represents the majority (~95%) and TCR $\gamma\delta$ comprises the minority (~5%). TCR $\gamma\delta$ T cells have inherent anti-tumor cytotoxicity, which resulted in clinical trials for their use in cancer therapy. They may also have application after allogeneic hematopoietic stem-cell transplantation (HSCT) as they have limited risk for graft-versus-host-disease. To test the feasibility of CAR⁺TCR $\gamma\delta$ to be used after allogeneic HSCT, we hypothesized that the cytolytic capacity of $\gamma\delta$ T cells can be synergized with the targeting of CD19-specific CAR to kill B-cell malignancies. *Sleeping Beauty* transposon was used for non-viral gene transfer of a 2nd generation CD19-specific CAR into PBMC, and CAR⁺ TCR $\alpha\beta$ and TCR $\gamma\delta$ T cells were expanded on K562-derived

artificial antigen presenting (aAPC) cells modified to express CD19 and T-cell co-stimulatory molecules. As controls, bisphosphonates and anti-CD3 antibody were used for the numeric expansion of CAR^{neg}TCR $\gamma\delta$ ⁺ and CAR^{neg}TCR $\alpha\beta$ ⁺ T cells, respectively. As shown in **Figure 1**, expression of the CD19-specific CAR resulted in superior expansion of TCR $\gamma\delta$ ⁺ T-cells when compared to bisphosphonates, and CAR⁺TCR $\gamma\delta$ ⁺ T cells were readily produced in kinetics similar to CAR⁺TCR $\alpha\beta$ ⁺ T cells. TCR $\gamma\delta$ ⁺ T cells propagated on aAPC were not restricted to V γ 9V δ 2 lineage, which is characteristic of bisphosphonate expansion. Given that we have adapted CD19⁺ aAPC for propagation of clinical grade CAR⁺TCR $\alpha\beta$ ⁺ T cells, our data provide an approach to generating polyclonal CAR⁺TCR $\gamma\delta$ ⁺ T cells for clinical use. Both CAR⁺TCR $\alpha\beta$ ⁺ and CAR⁺TCR $\gamma\delta$ ⁺ T cells exhibited redirected specificity for CD19 with similar CAR-dependent cytolytic capability and production of IFN γ (**Figure 2**). CAR⁺TCR $\gamma\delta$ ⁺ T cells displayed a memory phenotype characterized as CD62L⁺CCR7⁺CD27⁺CD28⁺CD45RA⁺CD45RO⁻CD57⁻, which is in contrast to the CD62L⁺CCR7⁺CD27⁺CD28⁺CD45RA⁻CD45RO⁻CD57⁻ displayed by CAR⁺TCR $\alpha\beta$ ⁺ T cells. This study reports a clinically-appealing approach of generating large numbers of polyclonal CAR⁺TCR $\gamma\delta$ ⁺ T cells to target B-cell malignancies, which represents a novel therapeutic option for adoptive therapy of allogeneic T cells after HSCT.

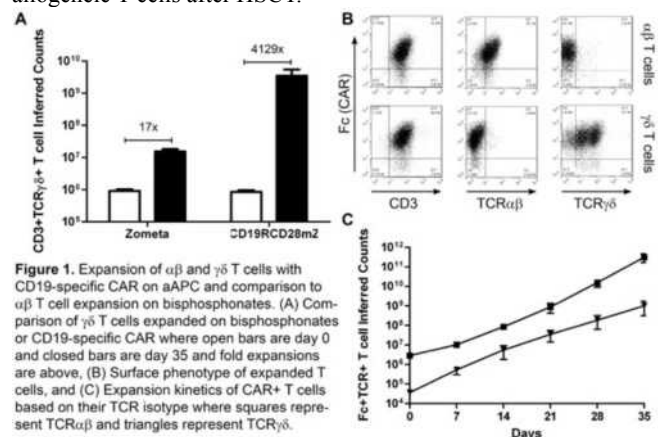

Figure 1. Expansion of $\alpha\beta$ and $\gamma\delta$ T cells with CD19-specific CAR on aAPC and comparison to $\alpha\beta$ T cell expansion on bisphosphonates. (A) Comparison of $\gamma\delta$ T cells expanded on bisphosphonates or CD19-specific CAR where open bars are day 0 and closed bars are day 35 and fold expansions are above. (B) Surface phenotype of expanded T cells, and (C) Expansion kinetics of CAR⁺ T cells based on their TCR isotype where squares represent TCR $\alpha\beta$ and triangles represent TCR $\gamma\delta$.

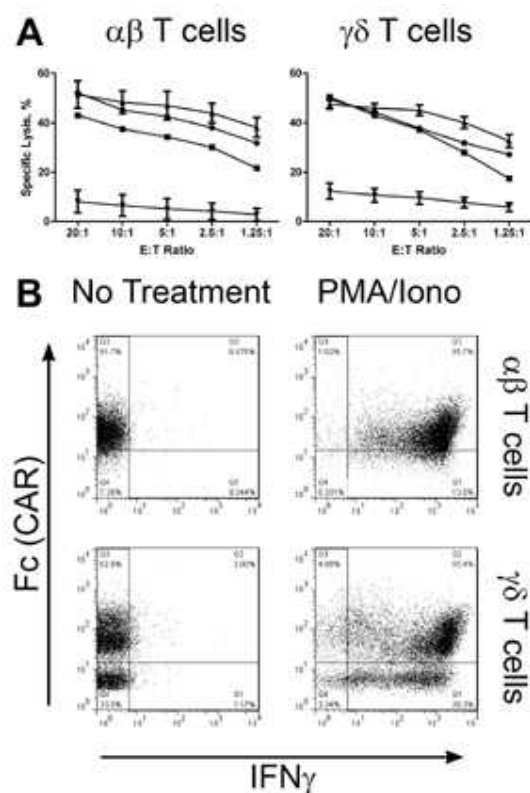

Figure 2. Cytolysis and IFN γ production by CAR⁺ T cells. (A) Chromium release assay of CD19-specific T cells against CD19⁺ tumor targets DAUDI.b2M (●), NALM-6 (■), and EL4-CD19 (▲) and CD19⁻ target EL4 (▼), and (B) Intracellular IFN γ staining following PMA/Ionomycin treatment.

225. Adoptive Transfer Therapy Using Expanded Melanoma-Specific T Cells Programmed Ex Vivo for Improved Efficacy In Vivo

Helen A. Andersson,¹ Jessica A. Hernandez,¹ Sourindra Maiti,¹ Helen Huls,¹ Laszlo Radvanyi,¹ Laurence J. N. Cooper.¹
¹UT MD Anderson Cancer Center, Houston, TX.

Adoptive cell transfer (ACT) of expanded autologous tumor-infiltrating lymphocytes (TIL) mediates tumor regression in up to 50% of Stage IV melanoma patients refractory to all other types of therapy. Further improvement of ACT based on current technology (using OKT3 and allogeneic PBMC) to propagate T cells has reached a point of diminishing returns due to the technically cumbersome and resource-intensive production of TIL for clinical administration. The extended culture times needed to generate clinically-sufficient numbers of TIL typically results in acquisition of terminally-differentiated CD8⁺ T cells with loss of effector memory function and reduced antigen specificity, resulting in poor *in vivo* persistence and reduced therapeutic potential. Compounding this problem is that TIL cannot be expanded from many melanoma patients leaving them without an option for cellular therapy. To improve ACT, here we show that K562 cells can function as artificial antigen-presenting cells (aAPC) for propagating melanoma-specific T cells from both

TIL and peripheral blood. K562 were genetically modified to function as “generic” aAPC for *in vitro* propagation of T cells with central and effector memory phenotypes by enforced expression of the costimulatory molecules CD86 and 41BB-L in addition to membrane-bound versions of the cytokines IL7/IL15/IL21. As K562 do not express endogenous HLA A and B molecules engendering allogeneic responses, they were genetically modified as “specialized” aAPC using the *Sleeping Beauty* DNA non-viral transposon/transposase system to express the melanoma-associated antigens MART-1 and gp100 in combination with desired HLA molecules (Table 1). We show that these aAPC selectively propagate melanoma-specific CD8⁺ T cells from both PBMC and TIL, generating T cells with improved memory phenotype, expansion capability, and cytolytic function compared to TIL generated in standard expansion protocols. By *ex vivo* manipulation of the microenvironment, we can expand T cells with a younger, less differentiated phenotype which maintain expression of critical T-cell costimulatory molecules predicted to improve persistence and antitumor function following adoptive transfer. K562 cells are preferred over the existing propagation approach as they can be readily transfected, expanded to large numbers, stored irradiated as an off-the-shelf reagent, and be manufactured in compliance with good manufacturing practice (cGMP). These data suggest that K562-aAPC can be used as a platform technology for the robust and rapid manufacturing of clinical-grade melanoma-specific T cells. Furthermore, this aAPC strategy broadens the application of T cell therapy so that patients from whom TIL cannot be expanded may receive immunotherapy.

HLA class I molecules used to genetically modify K562 aAPC and their proportion in the US population and in melanoma patients at MDACC.

HLA class I	African-American (%)	Caucasian (%)	Hispanic (%)	Asian (%)	Percent of stage IV melanoma patients at MDACC
A*0101	11	28	12	3	15
A*0201	23	47	41	18	27
A*0301	19	24	14	2	12
A*1101	5	14	11	41	8
A*2301	21	3	4	1	3
A*2402	6	13	23	34	8
B*0702	16	21	12	5	
B*3501	12	13	14	7	
B*4403	7	6	11	9	
B*5101	2	11	12	13	

226. Intratumoral Expression of CTLA4 Monoclonal Antibody Induces Immunosuppressive NKT Cells in a Mouse Model of Breast Cancer with Tolerance to Her2/neu

Jonas Persson,¹ Ying Liu,¹ Roma Yumul,¹ Ines Beyer,¹ Hans-Peter Kiem,² Steve Roffler,³ Andre Lieber.¹
¹Department of Medicine, University of Washington, Seattle, WA;
²Fred Hutchinson Cancer Research Center, Seattle, WA; ³Institute of Biomedical Sciences, Academia Sinica, Taipei, Taiwan.

Monoclonal antibodies specific for cytotoxic T lymphocyte-associated antigen 4 (aCTLA4) are a novel form of cancer immunotherapy. While preclinical studies in mouse tumor models have shown anti-tumor efficacy of aCTLA4 injection or expression, aCTLA4 treatment in patients with advanced cancers had only disappointing therapeutic benefit. In a recent study in mice with implanted syngeneic tumors expressing HPV16 E6/E7, we showed that intratumoral expression of aCTLA4 gene increased anti-E6/E7 immune responses and resulted in a delay of tumor growth. Here we tested a stem cell based approach of intra-tumoral aCTLA4 expression in a breast cancer model based on *neu*-transgenic mice. This model resembles key immunological features of breast cancer in humans, most importantly the existence of peripheral tolerance to Neu and the presence of Neu-reactive T-cells. Contrary to studies in non-tolerized mice, aCTLA4 expression in the *neu* transgenic breast cancer model did not only fail to exert anti-tumor effects, but instead stimulated tumor growth. Further analysis revealed that aCTLA4 expression

increased the percentage of immunosuppressive CD1d-restricted NKT cells inside the tumors. Our study suggests that aCTLA4 can have a tolerance promoting effect. This finding gives a potential explanation for the low efficacy of CTLA4 blockage approaches in cancer immunotherapy trials.

227. Efficient Eradication of Castration-Resistant Human Prostate Cancers by Inactivated Sendai Virus Particle

Koji Hatano,^{1,2} Yoshifumi Kawaguchi,^{1,3} Yasuhide Miyamoto,⁴ Norio Nonomura,² Yasufumi Kaneda.¹

¹Division of Gene Therapy Science, Graduate School of Medicine, Osaka University, Suita, Japan; ²Division of Urology, Graduate School of Medicine, Osaka University, Suita, Japan; ³Division of Radiation Oncology, Graduate School of Medicine, Osaka University, Suita, Japan; ⁴Department of Immunology, Osaka Medical Center for Cancer and Cardiovascular Diseases, Osaka, Japan.

Castration-resistant prostate cancer is one of the intractable human cancers in the world. Here, we examined the direct tumor-killing activity of inactivated Sendai virus particle (hemagglutinating virus of Japan envelope; HVJ-E) through induction of type I interferon (IFN) in the castration-resistant human prostate cancer cell lines PC3 and DU145. HVJ-E can induce apoptosis in castration-resistant human prostate cancer cells, PC3 and DU145, but not in normal prostate epithelium PNT2.

Figure 1. Cell survival after HVJ-E treatment

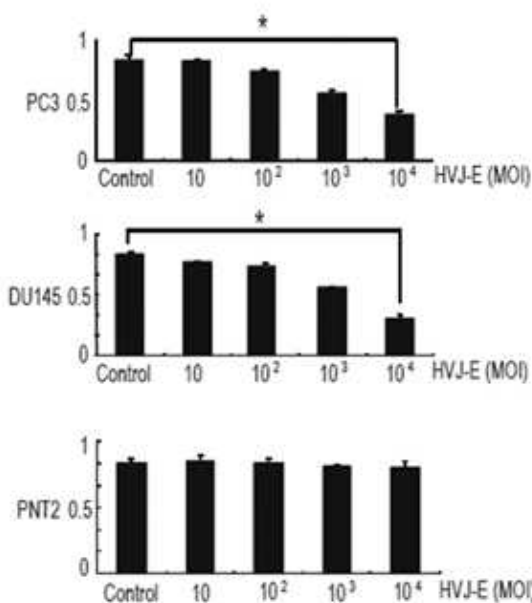

Preferential binding of HVJ-E to PC3 and DU145 over normal prostate epithelium was observed, resulting in a number of fused cells. After HVJ-E treatment, a number of IFN-related genes were up-regulated, resulting in type I IFN production in PC3 cells. Then, RIG-I (retinoic acid-inducible gene-I) helicase which activates type I IFN expression after Sendai virus infection was up-regulated in cancer cells following HVJ-E treatment. Produced IFN- α and - β enhanced caspase 8 expression via JAK-STAT pathway, activated caspase 3 and induced apoptosis in cancer cells. When HVJ-E was directly

injected into a mass of PC3 tumor cells in SCID mice, a marked reduction in the bulk of each tumor mass was observed and 85% of the mice became tumor-free. Although co-injection of an anti-asialo GM1 antibody with HVJ-E into each tumor mass slightly attenuated the tumor suppressive activity of HVJ-E, significant suppression of tumor growth was observed even in the presence of anti-asialo GM1 antibody.

Figure 2. Tumor eradication and growth inhibition following intra-tumor injection of HVJ-E

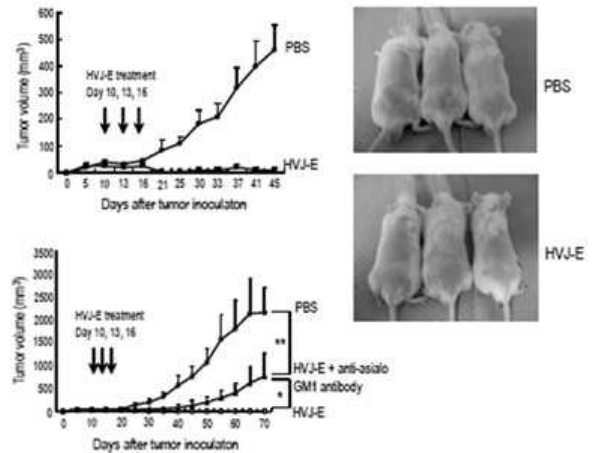

This suggests that NK cell activation made small contribution to tumor regression following HVJ-E treatment in castration-resistant prostate cancer model *in vivo*. Thus, HVJ-E effectively targets castration-resistant prostate cancer by inducing apoptosis in tumor cells, as well as activating anti-tumor immunity.

228. Development of a T Cell Receptor Targeting the HLA-A*0201 Restricted Epitope SSX2: 41-49 for Adoptive Immunotherapy of Cancer

Nachimuthu Chinnasamy,¹ Jeremy L. Davis,¹ Mahadev Rao,¹ David S. Schrupp,¹ Daniel E. Speiser,² Steven A. Rosenberg,¹ Richard A. Morgan.¹

¹Surgery Branch, National Cancer Institute, National Institutes of Health, Bethesda, MD; ²Clinical Tumor Immune-Biology Unit, Ludwig Institute for Cancer Research Ltd, Lausanne, Switzerland.

Cancer testis antigens are attractive targets for adoptive immunotherapy because their normal expression is restricted to immunoprivileged germline tissue of the testis while being aberrantly expressed in several types of cancer. The synovial sarcoma X breakpoint (SSX) genes are located on the X chromosome and encode a family of ten highly homologous nuclear proteins, SSX-1-10. Among the SSX genes, SSX-1, -2, -4, and -5 are the most commonly expressed members in tumors. According to the published literature SSX-2 is expressed in a significant proportion of human cancers including melanomas, head and neck cancers, lymphomas, multiple myeloma, pancreatic cancer, prostate cancer, sarcomas, hepatocellular and colon carcinomas, but not in normal tissues. Therefore, SSX-2 is an attractive target for T cell based adoptive immunotherapy. We isolated six HLA-A2 restricted T cell receptors (TCRs) from natural T cell clones derived from tumor-infiltrated lymph nodes from two melanoma patients seropositive for SSX-2 and whose tumors expressed SSX-2. We constructed four retroviral vectors expressing

the TCR α and β chains of these TCRs. Peripheral blood lymphocytes (PBL) were transduced with SSX2 TCRs and tested for antigen specific reactivity and tetramer binding. PBL engineered with three of the four TCRs showed SSX-2: 41-49 (KASEKIFYV) peptide specific reactivity, tumor cell recognition and tetramer binding. One of the TCR exhibited tetramer binding in both CD4 and CD8 cells. We selected this TCR for further development and tested it against a wide range of tumor cell lines from different histologies for antigen specific recognition and function. Very high levels of antigen specific interferon- γ secretion were observed following culture of TCR engineered PBL with HLA-A2+/SSX2+ tumor cell lines. SSX2 TCR engineered PBL also showed specific lytic activity and proliferative response upon encounter with antigen. Peptides homologous to SSX-2: 41-49 in the other members of SSX family of proteins differ by only 1 or 2 amino acids from peptide KASEKIFYV. Peptide epitopes derived from SSX-3, 4, 5, 9 and 10 were also recognized by the SSX-2: 41-49 TCR at a concentration >10 ng/ml. In an effort to improve TCR function a codon-optimized version and a chimeric TCR with a mouse constant region were generated and are being tested. This TCR may be useful as a clinical reagent to redirect patient T cells to treat SSX2 expressing tumors.

229. Apoptosis Inducer ABT-737 Enhances Efficacy of Engineered CD19-Targeting T-Cells

Hannah Karlsson,¹ Camilla Lindqvist,¹ Gabriella Paul-Wetterberg,¹ Per Frisk,² Angelica Loskog.¹

¹Dept of Immunology, Genetics and Pathology, Science for Life Laboratory, Uppsala University, Uppsala, Sweden; ²Oncology Unit, Childrens Hospital at Uppsala University and University Hospital, Uppsala, Sweden.

Introduction: Retargeted T-cells are currently used in clinical trials for patients with B-cell leukemia or lymphoma. Many B-cell tumors exhibit enhanced levels of anti-apoptosis molecules such as BCL-2 which may interfere with treatment efficacy. ABT-737 is a small molecule inhibitor of anti-apoptosis proteins such as BCL-2 and BCL-xL and, hence, induces apoptosis via the intrinsic apoptosis pathway in contrast to T-cells that utilize the extrinsic pathway controlled by death receptors and their ligands. ABT-737 has been shown efficient to promote apoptosis in B-cell tumors as exemplified in models of pre-B-ALL. Recently, ABT-737 was shown to synergize with TRAIL to induce apoptosis. This prompted us to investigate if ABT-737 could be combined with T-cell therapy to enhance tumor cell death. **Methods:** CD19-targeting T-cells were obtained by gene transfer of a chimeric antigen receptor (CAR) to T-cells using a lentiviral system. A conventional CAR consisting of a CD19-targeting single chain fragment fused to intracellular TcR and CD28 signaling domains was inserted into preactivated T-cells donated from children with pre-B-ALL and healthy blood donors. The T-cells and ABT-737 were tested as single agents, or in combination, for their cytotoxic capacity in *in vitro* assays such as flow cytometry and Caspase 3/7-Glo. The effects were confirmed in a panel of B-cell tumors. **Results:** CD19-targeting T-cells specifically induced apoptosis in the CD19+ tumor cell lines. Similarly, but less effectively ABT-737 as single agent increased apoptosis in various B-cell tumor cell lines. When combining T-cell and ABT-737 therapy, the tumor cell death was significantly increased to that of single agent treatment. The effect varied from additive to synergistic effects. The tumor cell lines did not change the level of antigen presenting molecules (MHC-I and II), death receptors (Fas) or adhesion or costimulatory molecules (ICAM I, CD80, CD86) upon ABT-737 treatment. Hence, the effect did not likely represent increased killing by enhanced physical interaction between T-cells or tumors but rather simultaneous engagement of both intrinsic and extrinsic apoptosis pathways. **Conclusion:** The

apoptosis inducer ABT-737 is potentially enhancing CD19-targeting T-cell therapy. By triggering both intrinsic and extrinsic apoptosis pathways also resistant tumors may succumb to treatment.

230. Validation of Donor Derived Virus Specific T-Lymphocytes Genetically Modified To Target the CD19 Antigen for the Treatment of Relapsed Leukemia

Kevin J. Curran,¹ Clare Taylor,² Ekaterina Doubrovina,¹ Xiuyan Wang,² Richard J. O'Reilly,¹ Michel Sadelain,^{2,3} Nancy A. Kernan,¹ Renier J. Brentjens,^{2,3} Isabelle Riviere.²

¹Department of Pediatrics, Memorial Sloan-Kettering Cancer Center, New York, NY; ²Cell Therapy and Cell Engineering Facility, Memorial Sloan-Kettering Cancer Center, New York, NY; ³Department of Medicine, Memorial Sloan-Kettering Cancer Center, New York, NY.

Human T-cells can be genetically modified to target tumor antigens through tumor antigen-specific artificial T-cell receptors termed chimeric antigen receptors (CARs). Patients suffering relapse leukemia following allogeneic stem cell transplant (allo-SCT) have limited treatment options and could benefit from this novel therapeutic approach. However, the potential for graft versus host disease is prohibitive when using donor derived lymphocytes. On the contrary, we and others have shown infusion of donor derived virus specific T cells targeting EBV (EBV-CTLs) does not lead to the development of GVHD in the recipient. Herein we describe the validation process for an upcoming clinical trial treating relapsed leukemia following allo-SCT using donor derived virus specific T cells genetically modified to target the CD19 antigen which is expressed by most B-cell leukemias. Using gammaretroviral vector gene transfer we established EBV-CTL donor cell lines could be genetically modified to express our anti-CD19 CAR (19-28z). We compared several methods of EBV-CTL activation including the use of autologous EBV B-cell lymphoblastoid cell lines (EBV-BLCL), beads coated with agonistic CD3 + CD28 monoclonal antibodies (Invitrogen Carlsbad, CA), or a combination of BLCL + beads. Furthermore, we compared the transduction efficacy of activated EBV-CTLs transduced immediately following activation (early transduction) and one week following activation (late transduction). Transduction efficiency ranged from 25-75% and was consistently higher in the EBV-CTL groups activated using EBV-BLCL alone. In standard ⁵¹Cr release cytotoxicity assay 19-28z⁺ EBV-CTLs exhibited specific cytotoxicity against the CD19⁺ human tumor cell lines BA-25 (B-ALL), Raji (Burkitt's lymphoma) and the mouse thymoma cell line EL4 modified to express the human CD19 antigen (EL4-hCD19⁺). In contrast our control untransduced EBV-CTLs failed to lyse these CD19⁺ targets. Both 19-28z⁺ EBV-CTLs and the untransduced EBV-CTLs retained the ability to specifically lyse autologous BLCL but not autologous PHA-blasts showing retained EBV specificity. Finally and most significantly, 19-28z⁺ EBV-CTLs are able to eradicate established systemic Raji tumor in our SCID-Beige model of disease. These results validate the therapeutic potential of genetically modified EBV-specific T-lymphocytes which will be tested in an upcoming clinical trial for patients with relapsed CD19+ B-ALL following allo-SCT.

231. Development of Genetically Engineered T Cells Expressing a Chimeric Antigen Receptor Against Prostate Stem Cell Antigen for the Adoptive Cell Therapy of Cancer

Kiran H. Lagisetty,¹ William R. Burns,² Zheng Zhili,¹ Steven A. Rosenberg,¹ Richard A. Morgan.¹

¹*Surgery Branch, National Cancer Institute, Bethesda, MD;*

²*Surgery, Johns Hopkins School of Medicine, Baltimore, MD.*

T-cell receptor (TCR) and chimeric antigen receptor (CAR) based gene therapies provide a new treatment option for patients suffering from metastatic stage IV cancers. Development of MHC class I independent chimeric antigen receptors have allowed for the ability to treat any patients whose cancer expresses a tumor antigen of interest on the cell surface. Prostate stem cell antigen (PSCA) is an overexpressed surface antigen on a variety of cancers including: prostate, pancreas, cervix, bladder and esophagus. PSCA is a GPI anchored cell surface protein whose function is unknown. It has been hypothesized that PSCA may act as either a tumor suppressing gene or tumor promoting gene. In previously published work PSCA was found to be overexpressed in up to 90 percent of prostate tumors and up to 50 percent of pancreatic adenocarcinomas. PSCA expression in normal tissue expression is limited to the prostate and to a much lower degree in the placenta, bladder, kidney and stomach. Given this overexpression on a variety of tumors and its limited expression on normal tissues, PSCA may be an ideal target for CAR-based T cell therapy. Using publicly available sequences of antibodies specific for PSCA, we cloned the single chain variable fragments combined with CD28/CD3 ζ or CD28/CD3/41BB signaling domains into a MSGV1 based retroviral vector. These CARs are well expressed on the surface of T-cells and we have achieved transduction efficiencies of up to 90 percent based on flow cytometry data. Several PSCA-CARs were tested for the ability to secrete IFN gamma when transduced cells were cultured with PSCA expressing targets. Based on these results we selected the CARs containing the scFv fragments of the humanized, murine derived bm2B3 antibody and the fully human Ha1-4.117 antibody for further testing and development. Analysis of CAR transduced cells by tumor cytolytic assays and intracellular staining demonstrated the ability of these CARs to specifically recognize a PSCA expressing tumor, secrete IL-2 and IFN gamma as well as actively lyse PSCA transduced prostate lines. The anti-PSCA CAR transduced T cells have also been shown to proliferate 2-3 times higher than untransduced controls in response to antigen encounter. These data demonstrate that T-cells can be transduced with PSCA specific CARs and are functionally active when encountering PSCA expressing tumors. We currently plan on further optimizing these CARs for eventual treatment of humans in a clinical trial.

232. Delivery of Dendritic Cells Engineered To Express T-bet into Solid Murine Tumors Defines an Effective Therapy

Jennifer L. Taylor,¹ Yanyan Qu,¹ Lu Chen,¹ Walter J. Storkus.¹

¹*Dermatology, University of Pittsburgh, Pittsburgh, PA.*

The induction of protective Type-1 immunity appears to represent a prerequisite for effective and durable anti-tumor therapy. We have previously shown that the genetic engineering of human dendritic cells (DC) to express hT-bet cDNA yields a Type-1 polarizing APC *in vitro*. To analyze the potential therapeutic efficacy of this modality, murine CD11c⁺ DCs were transduced with a recombinant adenovirus encoding full-length mTbet (DC.mTbet) and analyzed for their immunomodulatory functions *in vitro* and *in vivo*. DC.mTbet were superior to control DC in promoting Th1 and Tc1 responses *in vitro*, and when injected into day 7 s.c. CMS4 sarcoma lesions growing in syngenic Balb/c mice, DC.mTbet mediated potent anti-tumor effects, with overall survival extended via a mechanism dependent

on both CD4⁺ and CD8⁺ T cells. DC.mTbet-based therapy not only induced superior tumor-specific Tc1 responses in the periphery of treated animals, it limited accumulation of CD11b⁺Gr1⁺ myeloid-derived suppressor cells (MDSC) in the tumor microenvironment. Furthermore, chaotic blood vessels found in the tumors of control treated animals became “normalized” in their architecture after intratumoral delivery of DC.mTbet. Since the mechanism of protective action of DC.Tbet was noted to be IL-12p70-independent, we also assessed whether combined gene therapy using DC expressing ectopic Tbet and IL-12p70 (DC.Tbet/IL12) would render even more profound clinical benefit to tumor-bearing animals. We observed that intratumoral delivery of DC.Tbet/IL-12 yielded superior activation of tumor-specific T cells and anti-tumor efficacy when compared with either single gene-based treatment, supporting the translation of such gene therapy approaches for patients with (injectable) solid cancers.

233. Comparative Microarray Analysis Implicates the Pivotal Participation of Type I Interferon Related Signaling Pathway in Antitumor Effect Provoked by In Vivo GM-CSF Gene Transduced Lung Cancer Cells

Megumi Narusawa,¹ Hiroyuki Inoue,¹ Yoshihiro Tanaka,¹ Yosuke Yokota,¹ Chika Sakamoto,¹ Shohei Miyamoto,¹ Tomoko Inoue,¹ Makoto Inoue,² Koichi Takayama,³ Mamoru Hasegawa,² Yoichi Nakanishi,³ Kenzaburo Tani.¹

¹*Division of Molecular and Clinical Genetics, Medical Institute of Bioregulation, Kyushu University, Fukuoka, Japan;* ²*DNAVEC Corporation, Tsukuba, Japan;* ³*Institute of Diseases of the Chest, Kyushu University, Fukuoka, Japan.*

Growing evidences accumulating from many preclinical and clinical settings have demonstrated that GM-CSF (Granulocyte-Macrophage Colony-Stimulating Factor) provoked substantial antitumor immunity. However, its efficacies were limited especially at clinical level. Thus, the improvement of its efficacy is considered to be essential. In this study, we attempted to molecularly clarify detailed mechanism of antitumor immunity induced by *in vivo* administration of GM-CSF gene transduced lung cancer cells by exploring crucial factors through cDNA microarray analysis of gene expression of GM-CSF-sensitized DCs (GM-DCs) that primes efficiently T cells in tumor draining lymph nodes (LN). First, we confirmed that immunocompetent mice subcutaneously inoculated with LLC, mouse non-small cell lung cancer, transduced with non-transmissible Sendai virus encoding GM-CSF (LLC/SeV/GM), but not control mice (LLC, LLC/SeV/GFP), significantly inhibited the tumor growth (p<0.05). Second, to determine the maximum phase of T cell priming by GM-DCs, we compared each DC's stimulatory capacity for the proliferation of allogeneic T cells by allogeneic MLR test during *in vivo* tumor formation assay. Our results showed that degree of enhanced proliferative capacity of both CD4⁺T and CD8⁺T cells stimulated by GM-DCs were largest at day 2 after tumor challenge. In addition, CD80, CD86, and MHC class II expression levels of GM-DCs at day 2 were more up-regulated than those of other control groups. Accordingly, we determined day 2 as an assumed maximum phase of GM-CSF-sensitized DCs followed by T cell priming. Third, we performed DNA microarray analysis of total RNA harvested, at day 2 after LLC or LLC/SeV/GFP, LLC/SeV/GM cells challenge, from CD86⁺ LN-DCs which included PKH26-labelled LLC-derived tumor associated antigens phagocytosed by DCs. The results showed that expression levels of type I IFNs associated factors including IRF7 were robustly up-regulated in GM-DCs compared with those in other control DCs. Upon viral infection, resting plasmacytoid DCs (pDC) initiates type I IFN transcription via MyD88/IRF7 complex. Therefore, we compared synergistic *in vivo* antitumor effects of subcutaneously inoculated with several TLR agonists with LLC/SeV/

GM cells. The results showed that mice inoculated with LLC/SeV/GM cells combined with Imiquimod, an agonist of TLR7, elicited more rapid elimination of tumor challenge than them inoculated with LLC/SeV/GM cells alone. Taken together, we demonstrated that TLR7 agonist enhance GM-CSF-induced antitumor immunity in mouse lung cancer model, suggesting that pDC generating type I IFNs might be a pivotal subpopulation of APCs which mainly contributes to GM-CSF-induced antitumor effects.

234. T Cells Genetically Modified To Express Chimeric Antigen Receptor Specific for EGFR for Glioma

Hillary G. Caruso,¹ Sonny Ang,¹ Singh S. Harjeet,¹ Simon Olivares,¹ Laurence J. N. Cooper.¹

¹Pediatrics, M.D. Anderson Cancer Center, Houston, TX.

Diffuse Intrinsic Pontine Glioma (DIPG) is an inoperable and nearly uniformly fatal tumor that afflicts children. These tumors overexpress wild type epidermal growth factor receptor (EGFR), and a recent clinical trial had shown that Nimotuzumab, an anti-EGFR monoclonal antibody (mAb), has transient and surprisingly moderate clinical benefit for these patients. We seek to extend this antibody therapy to T-cell therapy by introducing a chimeric antigen receptor (CAR) to redirect the specificity of autologous T cells to EGFR. A second-generation EGFR-specific CAR was generated by fusing the specific region (scFv) of Nimotuzumab to T cell activation domains CD28 and CD3 ζ and expressed as *Sleeping Beauty* (SB) transposon. The CAR was electroporated into primary PBMC with a SB transposase enzyme to cut CAR out of the vector and insert it into the genome. T cells expressing EGFR-specific CAR were propagated on irradiated artificial antigen presenting (aAPC) cells modified to express EGFR. The culture system was adapted to provide robust and selective outgrowth of CAR⁺ T cells by every-seven-day addition of γ -irradiated aAPC in the presence of IL-2 and IL-21. It is this platform that we are using to generate clinical-grade CD19-specific CAR⁺ T cells. T cells expressing EGFR-specific CAR were detected 24 hours post-electroporation in 30-50% of the PBMC by flow cytometry using Fc-specific Ab which recognizes the IgG4 region of the CAR. EGFR-specific T cells were numerically expanded by 5 logs over 28 days to yield a population of primarily CD8⁺ T cells with effector-memory phenotype (CCR7^{neg} CD45RO⁺). We were able to detect re-directed target specificity of the EGFR-specific CAR⁺ T cells by measuring intracellular IFN- γ production in response to EGFR⁺ targets.

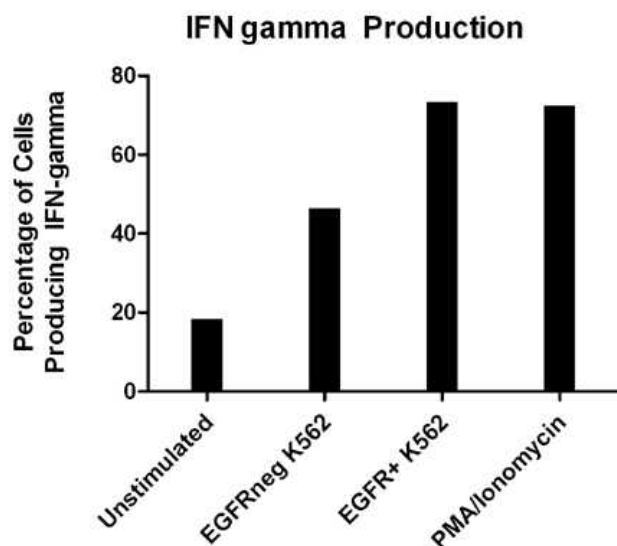

In aggregate, these data establish that T cells can be re-directed for EGFR based on Nimotuzumab. Given our ability to manufacture clinical-grade CAR⁺ T cells, we are proceeding with studies to enable EGFR to be targeted in children with DIPG.

235. In Vivo Delivery of Interferon-alpha Gene Enhances Tumor Immunity and Suppresses Immunotolerance after Autologous Hematopoietic Stem Cell Transplantation

Kenta Narumi,¹ Takeshi Udagawa,¹ Yoshinori Ikarashi,¹ Takahiro Ochiya,² Teruhiko Yoshida,³ Kazunori Aoki.¹

¹Division of Gene and Immune Medicine, National Cancer Center Research Institute, Tokyo, Japan; ²Division of Molecular and Cellular Medicine, National Cancer Center Research Institute, Tokyo, Japan; ³Division of Genetics, National Cancer Center Research Institute, Tokyo, Japan.

It is known that lymphopenia is followed by spontaneous expansion of the remaining T cells in the periphery to restore the original T-cell pool size and maintain homeostasis. Lymphopenia-induced homeostatic proliferation (HP) of T cells following autologous hematopoietic stem cell transplantation (HSCT) is driven by the recognition of self antigens, and there is an opportunity to skew the T-cell repertoire during the T-cell recovery by engaging tumor-associated antigens (TAAs), leading to an induction of antitumor immunity. However, integration of other immunotherapeutic strategies is necessary to successfully suppress pre-existing malignant tumors, because HP-driven antitumor responses decay gradually since they are vulnerable to a development of tolerance. IFNs have important roles in regulating the innate and adaptive arms of the immune system: up-regulation of major histocompatibility complex class I gene, promotion of the priming and survival of T cells, increase of the cytotoxic activity of natural killer cells and CD8⁺ T cells, and activation of dendritic cells (DCs). Therefore, in this study, we examined whether HP-induced antitumor activity can be enhanced by IFN- α gene transfer during a physiologic immune reconstitution. From the viewpoint of IFN- α immune therapy also, an autologous HSCT following a preconditioning is expected to introduce a fresh immune system, in which tolerance to tumor cells is not yet induced, and may present a unique opportunity for IFN- α to augment efficacy of the immune therapy. Growth of subcutaneous tumors was significantly suppressed in syngeneic hematopoietic stem cell transplantation (synHSCT) recipient mice, and an IFN- α gene transfer into the tumors resulted in synergistic tumor suppression when administered in the early period of synHSCT. The antitumor effect of the combination therapy was evident even in distant tumors such as liver metastases that were not transduced with the IFN- α vector. There was no significant toxicity in the treated animals. To analyze antitumor immune mechanisms induced by the combination therapy, we isolated CD11c⁺ cells from the IFN plasmid-injected tumors in synHSCT recipients. The intratumoral delivery of the IFN- α gene promoted the maturation of CD11c⁺ cells and effectively augmented the antigen-presentation capacity of the cells. An analysis of the cytokine profile showed that the CD11c⁺ cells in the treated tumors secreted a large amount of immune-stimulatory cytokines including IL-6. The CD11c⁺ cells rescued effector T-cell proliferation from regulatory T cell-mediated suppression, and IL-6 may play a dominant role in this phenomenon. The intratumoral IFN- α gene transfer creates an environment strongly supporting the enhancement of antitumor immunity in reconstituted lymphopenic recipients through the induction of tumor-specific immunity and suppression of immunotolerance.

236. Induction of Epitope-Specific CD8+ T Cells for Melanoma Eradication by Intratumoral Electroporation of IL-12 cDNA: A Possible Mechanism for Tumor Killing

Jeong-Im Sin.¹

¹*Microbiology, Kangwon National University School of Medicine, Chuncheon, Gangwon-do, Korea.*

Intratumoral (IT)-electroporation (EP) of IL-12 cDNA has been reported to be effective at eradicating melanoma established in the skin of animals (C57 BL/6). Here we explore the mechanism(s) as to how this tumor eradication is mediated *in vivo*. IT-EP of IL-12 cDNA effectively eradicated B16 melanoma (6-8 mm) without inducing anti-melanoma memory responses. This antitumor effect required mainly CD8+ T cells and to a far lesser degree CD4+ T cells, but not NK cells. Furthermore, CD8+ T cells recognized melanoma cells and melanoma peptides with high-affinity to MHC class I but not those with low-affinity to MHC class I or non-specific control tumor cells. Moreover, CD8+ T cells and more importantly CD4+ T cells were responsible for IFN- γ production upon stimulation *in vitro* with melanoma cells. In this melanoma control, IFN- γ was also required, but not directly involved as no tumor was controlled by IT-EP of IFN- γ cDNA. Even though B16 cells expressed Fas, no anti-Fas-mediated cell cytotoxicity was detected, suggesting Fas of B16 cells might be non-functional. On the other hand, the perforin/granzyme B-mediated pathway appeared to be associated with this melanoma eradication. Finally, antitumor memory responses were inducible by integrating melanoma peptide vaccines to IL-12 therapy. Thus, these data clearly show that IT-EP of IL-12 cDNA can eradicate melanoma by epitope-specific CD8+ T cells through the perforin/granzyme B-mediated killing pathway. IFN- γ also appeared to be indirectly associated with IL-12-mediated melanoma control. Furthermore, melanoma peptide vaccines might be of benefit for inducing anti-melanoma memory responses in this IL-12 gene therapy.

237. Oncolytic Plasmid System, a Novel Antitumor Strategy by Plasmid Encoding Adenovirus Protein

Yoshiyuki Koyama,¹ Chieko Yoshihara,¹ Masahiko Tojyo,² Tomoko Ito,^{1,3} Katsuyuki Hamada.⁴

¹*Otsuma Women's University, Tokyo, Japan;* ²*Nagai Animal Hospital, Osaka, Japan;* ³*Musashino University, Tokyo, Japan;* ⁴*Ehime University, Toon City, Ehime, Japan.*

Since the pioneering work of G. Dock was performed more than a century ago, a number of clinical trials were conducted using viruses to treat tumors. It has made remarkable advancements after genetically engineered, replication-selective oncolytic virus was developed in 1991. Oncolytic virus is expected to proliferate in and destroy tumor cells. Virus is also thought to generate antitumor immunity through releasing tumor-associated antigens into the tumor microenvironment. Virally infected cells or their fragments would effectively interact with DCs via pathogen recognition receptors, and crossprime tumor-specific T cells. Virus-specific protein presented on the infected cells would, thus, play an important role in enhancement of the adaptive antitumor immunity. We thought that expression of the virus-specific protein on the tumor cell surface could be induced not only by virus infection but also by the transfection of the viral protein-encoding gene. Extra viral gene would produce the viral antigen in the tumor cells, and invite recognition by DCs as well as the viral infected cells. Among the adenovirus proteins, our interest was focused on adenovirus death protein (ADP). ADP is an adenovirus nuclear membrane glycoprotein encoded by the E3 transcription unit, and is required at very late stages of infection for efficient cell lysis and release of adenovirus from infected cells. It was reported that adenovirus which overexpresses ADP showed highly improved tumor

growth regression. As a carrier of ADP gene, we have developed a highly effective gene transfection systems comprising very small (< 70 nm) plasmid complexes with negative surface charge (Biomaterials 31 (2010) 2912-2918). In this study, the small complex was made of the plasmid harboring ADP gene, and their high therapeutic effect in tumor-bearing mice was examined. Animal clinical study on primary tumor-bearing dogs and cats was also carried out, and evident suppression of the tumor growth was observed.

Cancer-Targeted Gene & Cell Therapy I

238. Therapeutic Efficacy and Safety Studies of a Novel Oncolytic Adenovirus Active in Tumor-Associated Stromal Cells and Tumor Microenvironment

Diego L. Viale,¹ Veronica M. Lopez,¹ Eduardo G. Cafferata,¹ David Gould,² Yuti Chernajovsky,² David T. Curiel,³ Osvaldo L. Podhajcer.¹

¹*Laboratory of Molecular and Cellular Therapy, Leloir Institute-CONICET, Buenos Aires, Argentina;* ²*Bone and Joint Research Unit, University of London, London, United Kingdom;* ³*Division of Human Gene Therapy, University of Alabama at Birmingham, Birmingham, AL.*

Human tumors are a heterogeneous mass of malignant cells intermingled with tumor-associated stromal cells that are actively engaged to promote metastatic dissemination. Therefore, a therapy aiming to completely eliminate tumor growth should target both cell types. Wide gene expression analysis identified SPARC as a protumorigenic protein in most human cancers. SPARC is overexpressed in melanoma cells and tumor associated fibroblasts and endothelial cells. We have previously described a conditionally replicative, type 5 adenovirus (CRAd) where E1A expression was driven by a 0.5 kb fragment of the human SPARC promoter (Ad-F512). This CRAd exhibited a strong *in vivo* therapeutic effect on SB2 melanomas, but its effect was abrogated on mixed tumor models made of SB2 cells and WI-38 fibroblasts (Lopez MV et al, PLOS One, 2009). We aimed to augment Ad-F512 replication capacity by the incorporation to the 0.5 Kb SPARC promoter of genetic elements responsive to cancer-associated environmental conditions, such as inflammation and hypoxia. The new adenoviral vector, named Ad(5)-kBF512HRE, contained 12 NFkB response elements upstream of the 0.5 kb (kB) SPARC promoter and 3 hypoxia response elements (HRE) inside the promoter sequence that did not disrupt specific motifs. This CRAd exhibited an improved transcriptional activity and higher replication rate on three different melanoma cell lines (SB2, Mel-LES and A375N) and in WI-38 cells when placed in hypoxia, in the presence of TNF- α and under both conditions. *In vivo*, Ad(5)-kBF512HRE was able to eliminate 100% (8/8) of SB2/WI-38 mixed melanoma/fibroblasts tumors in two different assays. However, no therapeutic effect was observed on mice harboring Mel-LES tumors. By flow cytometry we established that Mel-LES cells lacked CAR expression but expressed CD46, a candidate receptor of adenovirus type 3. Thus, we genetically modify Ad(5)-kBF512HRE by pseudotyping the virus with a chimeric 5/3 (shaft/knob) fiber. Ad(5/3)-kBF512HRE exhibited a high replication rate and lytic effect on Mel-LES cells *in vitro* and its administration induced the complete elimination of Mel-LES melanomas in 2/4 mice, while in another mouse a highly reduced tumor growth was observed. In order to evaluate safety parameters, we analyzed CRAd replication on *ex-vivo* hamster tissue explants that are permissive to adenoviral replication. Ad5-WT highly replicated in lung and spleen hamster explants while we observed no replication of Ad(5/3)-kBF512HRE. In liver tissue explants, we observed 4.5-fold less replication of Ad(5/3)-kBF512HRE compared to Ad5-WT. These data demonstrate the

improved lytic capacity of a novel CRAAd based on a triple promoter that include enhancer elements responsive to cancer-environmental conditions and a tumor-stroma specific promoter.

239. Expansion and Anti-Tumor Efficacy of CD19 Targeted Cord Blood T Cells

Hollie J. Pegram,¹ Vincent La Russa,² Renier J. Brentjens.^{1,2,3}

¹Department of Medicine, Memorial Sloan-Kettering Cancer Center, New York, NY; ²Department of Clinical Laboratories, Memorial Sloan-Kettering Cancer Center, New York, NY; ³Center for Cell Engineering, Memorial Sloan-Kettering Cancer Center, New York, NY.

Transplantation of unrelated umbilical cord blood (CB) derived stem cells is often used to treat adult patients with B-cell acute lymphoblastic leukemia (B-ALL). However, leukemic relapse remains a significant cause of mortality post-transplant. We hypothesize that additional therapy involving adoptive transfer of CB derived T cells modified to express a tumor specific chimeric antigen receptor (CAR) could reduce leukemic relapse following CB transplant. To this end, we have previously demonstrated that human T cells which express the anti-CD19 1928 ζ CAR, containing the signaling domains of the co-stimulatory CD28 receptor and CD3 ζ chain, effectively eradicate CD19+ tumors both in vitro as well as in vivo in a SCID-Beige model of lymphoma. In this study we demonstrate the ability to effectively isolate and expand T cells from fresh CB samples and subsequently compared T cell expansion in in vitro cultures with the addition of exogenous stimulatory cytokines, including IL-2, IL-7, IL-12, IL-15 or combinations thereof. We demonstrate that in vitro culture in the context of exogenous IL-12 combined with IL-2 or IL-7 resulted in optimal expansion of CB T cells (over 150-fold). In addition, expansion of T cells in the context of exogenous IL-12 + IL-2 or IL-12 + IL-7 resulted in a phenotypic changes, with respect to memory and functional markers. Expanded CB T cells were subsequently retrovirally transduced to express the 1928 ζ CAR. The resulting CD19-specific CB derived T cells were able to specifically lyse CD19+ tumor targets and secrete both IFN- γ and IL-2 in response to CD19+ tumor targets. Furthermore, adoptive transfer of expanded CB T cells results in 80 % survival in SCID-Beige mice in a preclinical lymphoma model. We ultimately plan to use modified, CB-derived T cells in a Phase 1 clinical trial in patients with B-ALL undergoing CB transplant.

240. Expression of Membrane Bound GD2 Peptide Mimic on K562 Cell Line Supports Antigen Specific Expansion of T Cells Modified with GD2 Chimeric Antigen Receptor

Srinivas S. Somanchi,¹ Laurence J. N Cooper,¹ Dean A. Lee.¹

¹Division of Pediatrics, The University of Texas M.D. Anderson Cancer Center, Houston, TX.

GD2 is a disialoganglioside expressed abundantly on various tumors like neuroblastoma, melanoma, osteosarcoma and small cell lung cancers. This renders GD2 as an attractive molecule for targeted therapies. Numerous chimeric antigen receptor (CAR) mediated T cell therapies have been developed targeting the GD2 ganglioside. Historically, the GD2-CAR modified T cells are expanded on GD2 antigen positive melanoma or neuroblastoma tumor cell lines. In the work presented here, we report the development of an artificial antigen presenting cell (aAPC) bearing a membrane-bound peptide mimic of GD2 that supports activation and proliferation of GD2-CAR modified T cells. In previous work, we had developed an aAPC based on K562 engineered to express various co-stimulatory molecules and membrane bound IL15 (K562 C14 mIL15) to support proliferation of antigen activated T cell. Based on recent publications that described the development of peptide mimics of GD2 ganglioside,

we engineered the K562 C14mIL15 to express a membrane bound circular decapeptide, that exhibited best GD2 mimicry in anti-GD2 antibody - Ch14.18 binding assays, as a fusion protein using Sleeping Beauty transposon/transposase system. PBMCs from healthy donors were electroporated with GD2-CAR containing CD28 and CD3Z endodomains using Sleeping Beauty transposition system. Transfected and un-transfected PBMCs were expanded for three weeks and stimulated weekly with aAPCs with or without GD2 mimic. When cultured on aAPCs expressing GD2 peptide mimic the GD2-CAR positive T cells expanded selectively, in both CD4 and CD8 cell populations. The GD2-CAR modified T cells showed enhanced cytotoxicity against melanoma and neuroblastoma tumor targets that express GD2 antigen as determined by in vitro cytotoxicity assay. In this report we have demonstrated that expression of GD2 peptide mimic on K562 C14mIL15 supports selection, activation and proliferation of the GD2-CAR positive T cells. This is the first report to the best of our knowledge describing the generation of an aAPC for the expansion of CAR modified T cells in which the natural ligand for the CAR is not a protein antigen. Based on these results we propose the expression of membrane bound peptide mimics as a novel approach to overcome the complexity of non-protein antigen biosynthesis in establishing expansion platforms for CAR modified T cells and natural killer (NK) cells.

241. Identification of Targeted Adenovirus Vector for Pancreatic Cancer by Screening Large Adenoviral Library with Random AB-Loop-Mutations

Yoshiaki Miura,¹ Eric Brown,¹ Julia Davydova,¹ Masato Yamamoto.¹

¹Department of Surgery, University of Minnesota, Minneapolis, MN.

Adenoviral tropism is determined by the interaction between adenoviral capsid proteins and specific protein molecules on the cell surface. Adenovirus type5 initially binds to the cells via the interaction between the fiber knob and the primary receptor, the coxsackie virus and adenovirus receptor (CAR). Thus, modification of the fiber knob region has been a major strategy for vector targeting, and screening from adenoviral library with fiber-mutants is logical strategy for identifying targeted adenovirus. AB-loop of the fiber knob has high possibility as a locus of binding-motif presenting region because this loop is including major CAR-binding domains. However, only few point-mutations in AB-loop were analyzed for ablating CAR-binding because mutations in AB-loop possibly change the crucial adenoviral fiber-knob structure. To date, fiber-modified adenovirus library have been successfully constructed only in HI-loop of the fiber knob, not with AB-loop mutations. We hypothesize that adenovirus with AB-loop mutants isolated by the screening of the library would result in a new class fiber structure exploitable for gene therapy of cancers. First, we have developed a novel adenovirus vector generating system enabling adenoviral library with 10⁸ diversity in single 6cm culture dish (detail is explained in separate presentation). Briefly, this system used single loxP site in rescue virus and shuttle plasmid. Also, the vector generation with fiber complementing cell line avoids the elimination of the clones which does not efficiently infect producer cells. Next, we constructed shuttle plasmids library with random mutations in AB-loop of fiber knob, that the C411 to K417 of the fiber protein were replaced with 7 amino acids random library. This shuttle plasmids library was recombined with rescue virus in adenovirus producer cell line. Then, the resultant adenoviral library was screened with pancreatic cancer cell line (Panc1). Since the library used in the screening was collected from ten 6cm dishes, the theoretical diversity in the library was estimated to be approximately at a 10⁹ level. In the initial phase of the screening, although many low-affinity or nonspecific viruses might bind and internalize into the Panc1 cells,

the use of a replication-competent type of adenovirus could allowed the rapid spreading of the most efficient viruses present in the library, leading to an effective enrichment of such viruses. The DNA region of the AB-loop mutations in adenoviruses recovered from 3 rounds of selection was then amplified by PCR. The convergence of AB-loop mutant sequence to several particular sequences was observed. We are analyzing these adenovirus clones with AB-loop mutant for specificity, efficacy, and in vivo function. We have successfully identified a new class of adenoviruses with AB-loop mutant virus by screening large adenovirus library with AB-loop mutations. Also, the virus pool after the 3 rounds of selection was free of CAR-binding clones because the library region in AB-loop included major CAR-binding domains. So these selected clones may have novel infectivity to Panc1 cells via CAR-independent new cell entry pathway.

242. Insulin-Like Growth Factor Binding Protein 7 (IGFBP7): A Novel Therapeutic for Hepatocellular Carcinoma

Dong Chen,¹ Byoung Kwon Yoo,² Prasanna K. Santhekadur,² Rachel Gredler,² Paul B. Fisher,² Devanand Sarkar.^{1,2}

¹Pathology, Virginia Commonwealth University, Richmond, VA; ²Human and Molecular Genetics, Virginia Commonwealth University, Richmond, VA.

Hepatocellular Carcinoma (HCC) is the third leading cause of cancer mortality worldwide with a dismal prognosis. Currently no effective system therapy is available for advanced stages of HCC patients. Identification of novel molecules involved in hepatocarcinogenesis would help develop novel, targeted and effective therapeutics for HCC. Insulin-like Growth Factor Binding Protein-7 (IGFBP7) has been identified as a tumor suppressor gene for breast, prostate and colorectal carcinoma. However, little is known about the role of IGFBP7 in HCC. We document by immunohistochemistry that in 104 HCC patients, IGFBP7 expression is significantly downregulated compared to normal liver and IGFBP7 expression inversely correlates with the stages and grades of HCC. Loss of heterozygosity (LOH) of IGFBP7 locus is identified in 26% of HCC patients analyzed thus elucidating a potential mechanism of IGFBP7 downregulation in these patients. IGFBP7 mRNA and protein expression is significantly downregulated in human HCC cell lines compared to normal, immortal hepatocytes THLE-3 cells. Stable overexpression of IGFBP7 in HCC cells significantly inhibits in vitro growth and induces senescence and also profoundly inhibits growth of subcutaneous xenografts in nude mice. Conditioned medium from IGFBP7-overexpressing cells inhibits neovascularization in chicken chorio-allantoic membrane (CAM) and tube formation by human umbilical vein endothelial cells (HUVEC) documenting that IGFBP7 inhibits angiogenesis. These findings indicate that IGFBP-7 might be a tumor suppressor for HCC and adenovirus-mediated delivery of IGFBP7 might be an effective therapeutic for HCC. Adenovirus serotype 5, which is the most commonly used Ad used for gene therapy, infects human cells via coxsackie-adenovirus receptors (CAR). CAR is known to be downregulated in cancers. For this purpose a serotype chimeric Ad (Ad.5/3) is generated in which the Ad5 virus knob is replaced by Ad3 virus knob and which expresses IGFBP7 (Ad.5/3.IGFBP7). Ad.5/3.IGFBP7 significantly inhibits viability of human HCC cells, such as, HepG3, Hep3B and Huh7 and induces apoptosis when compared to the empty vector. These results support the evaluation of Ad.5/3.IGFBP7 in mouse models for developing as an effective HCC therapeutic.

243. Uterine Fibroids Gene Therapy: Targeted Adenovirus Vector (Ad-SSTR-RGD-TK/GCV) Provides Superior Inhibition of Human Leiomyoma Cells than Human Uterine Smooth Muscle Cells

Sangeeta Nair,¹ David T. Curiel,² Ayman Al-Hendy.¹

¹Obstetrics Gynecology, CWHR, Meharry Medical College, Nashville, TN; ²Division of Human Gene Therapy, University of Alabama, Birmingham, AL.

Background: Uterine leiomyomas continue to be a major cause for hysterectomy in premenopausal women. They are well defined tumors making gene therapy a suitable and effective approach for treatment. We have recently tested several modified adenovirus vectors with luciferase marker gene to identify the best transductional and transcriptional modification to target adenovirus for uterine fibroid cells in vitro. Adenovirus was modified by adding a RGD-4C (arginine-glycine-aspartic acid) motif to make the vector CAR (Coxsackie adenovirus receptor) independent and increase its transduction affinity towards human leiomyoma cells (Hassan M et. al., 2009). Objective: To test the utility of Ad-SSTR-RGD vector against immortalised human leiomyoma cells and human uterine smooth muscle cells. Methods: Immortalized human leiomyoma cells (HuLM) and human uterine smooth muscle cells (UtSMC) were infected with different multiplicities of infection (MOI)(5-100 PFU/cells) of Ad-SSTR-RGD vector. The cells were treated with GCV (ganciclovir) at concentration of 10ug/ml for 5 days followed by cell count. In human leiomyoma cells transfected with different MOIs of Ad-SSTR-RGD-TK/GCV (5, 10, 50,100pfu/cell), the cell number was reduced by 40%, 32%, 20%,or15% respectively (P<0.05) compared to control cells which were transfected with Ad-LacZ/GCV. In uterine smooth muscle cells (UtSMC) which were transfected with the same MOIs cell count though reduced by 68%,58%,52%, or 47% was statistically non significant compared to the control. We are currently testing the effect of Ad-SSTR-RGD-TK/GCV treatment on the expression of genes involved in cell cycling and growth in human leiomyoma cells. Conclusions: Targeted Adenovirus mediated delivery of Ad-SSTR-RGD-TK/GCV effectively reduces cell growth in HuLM cells compared to human uterine smooth muscle cells (UtSMC). These data demonstrate the potential utility of Ad-SSTR-RGD-TK/GCV gene therapy approach as a viable non-surgical alternative treatment option for women with symptomatic uterine fibroids. **Support:** NIH/NICHD R01 HD046228 and RCMI G12 RR 03032

244. Telomerase Inhibition Strategies by siRNAs Against Either hTR or hTERT in Oral Squamous Cell Carcinoma

Yan Li,¹ Liying Xiao,¹ Mingyuan Li,² Gang Yao,³ Yun Feng.¹

¹Department of Microbiology, State Key Laboratory of Oral Diseases, Chengdu, Sichuan, China; ²Department of Microbiology, West China School of Preclinical and Forensic Medicine, Chengdu, Sichuan, China; ³Department of Microbiology, Chengdu Institute of Biological Products, Chengdu, Sichuan, China.

Human telomerase RNA (hTR) and human telomerase reverse transcriptase (hTERT) are considered effective molecular targets for current anticancer therapy. In this study, we investigated the therapeutic effects of targeting hTR and hTERT individually or in combination by recombinant adenovirus-delivered siRNA in oral squamous cell carcinoma (OSCC) Tca8113. Further we screened the optimal strategy for RNA interference. Our results show that these different recombinant adenoviruses specifically reduced the levels of hTR mRNA, hTERT mRNA, hTERT protein, and telomerase activity in Tca8113 cells. Moreover, they successfully inhibited xenograft tumor growth in nude mice. The potency of their antitumor activities was ranked as follows: anti-hTR > anti-hTR + anti-hTERT > anti-

hTERT. Therefore, we demonstrated that the siRNA-expressing recombinant adenoviruses were an effective anticancer tool for treatment of OSCC. Furthermore, the anticancer effect of solely targeting hTR was more direct and efficient, compared to the effect of targeting hTR and hTERT in combination, or hTERT exclusively. The mechanism of this anticancer effect in OSCC was not only related to the inhibition of cell proliferation and the induction of cell apoptosis, but might also involve the inhibition of tumor angiogenesis.

245. Functional Characterization of TCRP1, a Novel Gene Mediating Resistance to Cisplatin in Oral Squamous Cell Carcinoma Cell Line

Yixue Gu,^{2,3} Shasha Fan,² Yang Xiong,⁴ Bo Peng,² Guopei Zheng,² Zhimin He.^{1,2}

¹Cancer Hospital and Cancer Research Institute, Guangzhou Medical University, Guangzhou, Guangdong, China; ²Cancer Research Institute, Xiangya School of Medicine, Central South University, Changsha, Hunan, China; ³Medical School, University of South China, Hengyang, Hunan, China; ⁴Department of Pharmacology, Guangzhou Medical University, Guangzhou, Guangdong, China.

To reveal the molecular mechanisms of resistance to chemotherapy in oral squamous cell carcinoma (OSCC), we previously established a multi-drug resistant cell line, Tca8113/ Pingyangmycin (Tca8113/PYM) and identified differential expression in genes and ESTs using microarray analysis. In this study, we identified a novel gene from one of those ESTs (AL707095) which encoded an 1834bp of full-length mRNA and translated a protein having 235 amino acids. This gene was denominated as tongue cancer resistance-associated protein 1 expression gene (TCRP1, accession number: EF363480). Database search indicated that TCRP1 gene located on localizes at human chromosome 11q13.4. The cellular localization analysis showed TCRP1 was mainly distributed in the cytoplasm. We further determined its functional characteristics by up/down-regulating expression of the gene in Tca8113 or Tca8113/PYM cells, respectively. Our study proved that exogenous overexpression of TCRP1 increased the resistance to cisplatin, while TCRP1 knockdown sensitized the multi-drug resistant Tca8113/PYM cell to cisplatin-induced cell apoptosis and decreases in cellular proliferation and long-term survival. These suggested that TCRP1 exerted a very important role in resistance to cisplatin in Tca8113 cells. Taken together, our study provided strong evidence for the linkage between up-regulated TCRP1 expression and cisplatin resistance in tongue cancer cell. We therefore concluded that TCRP1 is a candidate gene involved in chemotherapeutic resistance and might be a novel molecular target to reverse cisplatin-induced chemoresistance.

246. Aerosol Delivery of Small Hairpin Osteopontin Blocks Pulmonary Metastasis of Breast Cancer in Mice

Kyeong-Nam Yu,¹ Myung-Haing Cho.^{1,2,3}

¹Toxicology, College of Veterinary Medicine, Seoul National University, Seoul, Republic of Korea; ²Nano Fusion Technology, Graduate School of Convergence Science and Technology, Seoul National University, Seoul, Republic of Korea; ³Graduate Group of Tumor Biology, Seoul National University, Seoul, Republic of Korea.

Metastasis to the lung may be the final step in the breast cancer-related morbidity. Conventional therapies such as chemotherapy and surgery are somewhat successful; however, metastasis-related breast cancer morbidity remains high. Thus, a novel approach to prevent breast tumor metastasis is needed. Aerosol of lentivirus-based small hairpin osteopontin was delivered into mice with breast cancer twice a week for 1 or 2 months using a nose-only inhalation system. The

effects of small hairpin osteopontin on breast cancer metastasis to the lung were evaluated using near infrared imaging as well as diverse molecular techniques. Aerosol-delivered small hairpin osteopontin significantly decreased the expression level of osteopontin and altered the expression of several important metastasis-related proteins in our murine breast cancer model. Aerosol-delivered small hairpin osteopontin blocked breast cancer metastasis. Our results showed that noninvasive targeting of pulmonary osteopontin or other specific genes responsible for cancer metastasis could be used as an effective therapeutic regimen for the treatment of metastatic epithelial tumors. *This work was supported by the National Research Foundation (NRF-2010-0000784)*

247. A Fusion Protein, Tat-CYGB, Is a Potential Agent for Liver Cancer Therapy

Ruian Xu,¹ Weijie Shi,¹ Weidong Xiao.^{1,2}

¹Engineering Research Center of Molecular Medicine, Ministry of Education, China & Institute of Molecular Medicine, Huaqiao University, Fujian, China; ²Department of Microbiology, Temple University, Philadelphia.

To verify the bioactivity of the fusion proteins containing Tat with Cytochrome b5 (Cygb) and test the anti-tumor effect of the Tat-CYGB. The recombinant elements were inserted into the pET-22b after the restriction enzymes digestion. The ligated product transformed into the *E. Coli* strain, DH5 α , and identified with restriction enzymes digestion, PCR and DNA sequencing. The verified plasmid was transformed into the *E. Coli* strain, BL21. Expression of protein in BL21 was induced with lactose medium. The crude solution was purified with CM sepharose chromatography, and then condensed and desalted with Amicon Ultra-15. The Tat-CYGB was identified with Western blotting and immuno-cytochemistry. The activity of the peroxidase of the Tat-CYGB group was determined and compared with the CYGB group. The trans-membrane ability and excitation of the EGFP group were observed by fluorescence microscope. All the sequence displayed as expected except the mutation in the 3' end of EGFP of pET22b-TAT-EGFP. The inducible fusion proteins, including 23kDa Tat-CYGB and 31kDa Tat-EGFP, were obtained by CM sepharose. The results revealed that the peroxidase activity of the Tat-CYGB group was similar with that of the CYGB group. However, studies of immuno-cyto-chemistry showed that the concentration of CYGB in Chang Liver treated with Tat-CYGB was higher than that of either the CYGB group or the Tat-EGFP group. Tat-EGFP could enter cancer cells with excited green fluorescence. The concentration of 0.5 mol/L Tat-CYGB inhibited the proliferation of SMMC-7721 cells significantly but not either the CYGB group or the Tat-EGFP group. All data above demonstrated that the purified fusion protein of Tat-CYGB obtained from *E. Coli* was of trans-membrane ability and could therefore well inhibit the proliferation of SMMC-7721 cells, indicating that Tat-CYGB would be a potential agent for liver cancer therapy.

248. Transcriptional Targeting of Retrovirus Vector through the SSX4 Tumor-Specific Promoter

Toshio Yawata,¹ Eri Ishida,¹ Masahiro Kitahara,¹ Keiji Shimizu.¹

¹Department of Neurosurgery, Kochi Medical School, Nankoku, Kochi, Japan.

Suicide gene therapy has been shown to be effective in inducing tumor regression. The expression of suicide genes is best restricted to tumor cells but is ubiquitous in most brain tumor tissues. In this study, a human brain tumor-specific promoter was identified and used to develop transcriptionally targeted gene therapy. We identified SSX4 and MAGEA3 as genes expressing in glioma cell lines at high frequency among CTA and MAGE gene family by in silico and RT-PCR screening. SSX4 gene promoter activity was high in human

brain tumor cells but not in normal human astrocyte cells, whereas the MAGE-A3 promoter showed activity in both tumor and normal cells. In order to define a useful tumor-specific promoter for targeting in context of retroviral-mediated gene therapy, the SSX4 promoter were used to restrict the expression of suicide gene HSVtk in retroviral vector. Glioma and human telomerase catalytic subunit (hTERT)-immortalized fibroblast BJ-5ta cell lines transduced with retrovirus vectors were assayed for killing activity by ganciclovir. Glioma cell lines were effectively killed by ganciclovir in a concentration-dependent manner, whereas BJ-5ta cells were not. In addition, mouse glioma RSV-M cells transduced with retrovirus vector also showed suppressed tumor formation activity in syngeneic mice in response to ganciclovir administration. These results suggest that the promoter of SSX4 is useful for tumor-specific gene therapy, and promising the safe and effective retroviral-mediated gene therapy.

249. Establishment of Transgenic Mice Expressing a Biotin Binding Targeting Construct on the Endothelium of Blood Vessels

Thomas Wirth,¹ Anke Nicolaus,² Georg Breier,² Seppo Ylä-Herttua.¹

¹A.I. Virtanen Institute, Department of Biotechnology and Molecular Medicine, University of Eastern Finland, Kuopio, Finland; ²Department of Pathology, University Clinic Carl Gustav Carus, Dresden, Germany; ³Department of Medicine, University of Eastern Finland and Gene Therapy Unit, Kuopio University Hospital, Kuopio, Finland.

Background: Current treatment methods for malignant gliomas rarely achieve long-term tumor control. Furthermore, a significant percentage of high grade gliomas are located in anatomical sites that make resection impossible. We have developed a gene therapy based targeting system for targeting chemotherapy, toxin therapy or radiotherapy to inoperable gliomas. In order to evaluate the efficacy of this targeting construct in vivo in more detail, we established transgenic mice expressing the targeting construct, which is driven under the endothelial specific promoter Flk-1. **Methods:** A transgenic mouse model was established, wherein the transgene is driven under the endothelial specific promoter Flk-1. We generated 6 founder animals by microinjection of fertilized oocytes and established transgenic lines by breeding with C57BL/6 mice. **Results:** Double-immunofluorescence staining on frozen sections of embryos confirmed endothelial specific expression of the transgene. Furthermore, the staining demonstrated that the targeting construct was expressed during embryogenesis and that expression was co-localized with PECAM-1. **Conclusion:** Our study demonstrates that the transgenic mouse is a powerful tool to evaluate the properties of the targeting construct in vivo.

Hematologic and Immunologic Gene & Cell Therapy I

250. MGMT^{P140K} and TK^{HSV} Chemoselection of Allogeneic HSC and Correction of β -Thalassemia after Neonatal Transplantation without Myeloablation or Post-Transplant Immunosuppression

Rustom Falahati,¹ Jianqing Zhang,¹ Yimin Shi,¹ Linda Flebbe-Rehwaldt,¹ Stanton L. Gerson,² Karin M. L. Gaensler.¹

¹Department of Medicine, University of California, San Francisco, CA; ²Department of Hematology and Oncology, Case Western Reserve University, Cleveland, OH.

The feasibility of allogeneic transplantation, without myeloablation or post-transplant immunosuppression, was tested using in vivo

chemoselection of allogeneic hematopoietic stem cells (HSC) after transduction with a novel tricistronic lentiviral vector (MAGIT). This vector contains P140K-O⁶-methylguanine-methyltransferase (MGMT^{P140K}), HSV-thymidine kinase (TK^{HSV}), and eGFP enabling a) in vivo chemoselection of HSC by conferring resistance to benzylguanine (BG), an inhibitor of endogenous MGMT, and to chloroethylating agents such as BCNU and, b) depletion of proliferating cells such as malignant clones or donor T cells mediating GVHD, by expression of the suicide gene TK^{HSV} and Ganciclovir administration. Non-myeloablative transplantation of transduced, syngeneic, lineage depleted (Lin-) BM in neonates resulted in 0.69% GFP+ mononuclear cells in peripheral blood. BG/BCNU, administered 4 and 8 weeks post-transplant, produced 50-fold donor cell enrichment. Transplantation and chemoselection of MHC-mismatched MAGIT-transduced Lin- BM produced similar expansion for > 40 weeks. The efficacy of this transplantation approach was then successfully demonstrated in Hbb^{th3} heterozygous mice by correction of β -thalassemia intermedia, without toxicity or GVHD. Negative selection, by administration of Ganciclovir resulted in donor cell depletion. Re-expansion of donor cells could be achieved with additional BG/BCNU treatment. These studies show promise for developing non-ablative transplant approaches using in vivo positive/negative selection.

251. Pharmacologically Regulated Cell Growth of Specific Hematopoietic Lineages

David W. Emery,¹ Brandon Thomas,¹ Kiyoshi Okazuka,¹ Emilie A. Lovelett,¹ Brian C. Beard,² Hans-Peter Kiem,² C. Anthony Blau.¹

¹Institute for Stem Cell and Regenerative Medicine, University of Washington, Seattle; ²Clinical Research Division, Fred Hutchinson Cancer Research Center, Seattle.

We have been investigating a novel approach for the in vivo selection of vector-transduced hematopoietic cells based on regulated cell growth. Promising results have been achieved by fusing the signaling domain of the thrombopoietin receptor Mpl to an artificial dimerization domain that is, in turn, specific for a small drug molecule called a chemical inducer of dimerization (CID). In the absence of CID, the hybrid receptor is inert. However, addition of CID results in receptor dimerization and a resulting cell growth signal. Several years ago we transplanted two dogs (E900 and E958) with autologous marrow CD34+ cells transduced with a gammaretroviral vector constitutively expressing this Mpl cell growth switch. We previously reported in vivo selection in response to two 30-day intravenous courses of CID administered within the first 8 months post-transplant. In studies reported here we assessed the responses to 5-day subcutaneous courses of CID treatment at months 14, 90 and 93 (E900), or month 18 (E958), post-transplant. Long-term monitoring showed no rise in transduced cells in the absence of CID. Retroviral insertion site analysis showed that four of 6 (E958) and five of 12 (E900) transduced hematopoietic cell clones persisted lifelong. Both dogs were euthanized for reasons unrelated to the gene therapy treatment nearly 9 years post-transplant. Three clones from E900 remained detectable in each of two secondary recipients, one of which was treated with, and responded to, CID. In our combined studies, the strongest CID responses were observed in the erythroid lineage (≤ 7 fold increase), followed to a lesser degree by platelets (≤ 3.5 -fold) and B-cells (≤ 2.8 -fold). With the goal of adopting this approach for the specific production of only red blood cells or platelets for the treatment of specific congenital and cancer-related anemias, we sought to bring expression of this Mpl cell growth switch under lineage-specific regulation. Toward this end, we generated two lentiviral vectors: one in which the hybrid Mpl cassette is expressed from the promoter of the megakaryocyte-specific gene PF4; and another in which the hybrid Mpl cassette is expressed from a beta-globin promoter and associated locus-control region regulatory elements.

Transduction studies in definitive megakaryocyte and erythroid cell lines demonstrated high-level, lineage-restricted expression for both vectors. Functional cell growth studies in the Epo-dependent cell line UT7, a model exhibiting both megakaryocytic and erythroid potential, demonstrated both vectors expressed sufficient levels of the Mpl cell growth switch to bring transduced cells under CID regulation. Studies are underway to assess the activities of these vectors in mouse and human bone marrow culture assays. Taken together, these studies demonstrate the feasibility of safely regulating genetically engineered hematopoietic cells over many years with this system, as well as proof-of-principle for bringing the Mpl cell growth switch under lineage-specific regulation.

252. Towards Lentiviral IL2RG Gene Therapy for SCID-X1: The Importance of Pre-Transplant Conditioning and Cell Dose

Marshall W. Huston,¹ Niek P. van Til,¹ Trudi P. Visser,¹ Helen de Boer,¹ Gerard Wagemaker.¹

¹Hematology, Erasmus University Medical Center, Rotterdam, Netherlands.

Gene therapy for X-linked severe combined immunodeficiency (X-SCID) by gammaretroviral vectors to deliver a functional copy of the IL2RG gene into the host genome has been effective in the clinical setting, but carries the risk of insertional oncogenesis. HIV-1 derived lentiviral vectors have advantages over gammaretroviruses in transducing quiescent cells, such as long-term repopulating hematopoietic stem cells (HSC), are less likely to integrate near transcription start sites, have no preference for integration near proto-oncogenes and have a lower genotoxicity profile. We have previously demonstrated the efficacy of lentiviral IL2RG gene therapy for X-SCID in an *Il2rg*^{-/-} mouse model when using a self-inactivating lentiviral vector and a codon optimized human IL2RG cDNA (*coγc*) driven by the strong SF viral promoter, the constitutively active cellular promoter PGK or a 1.1kb section of the native human IL2RG promoter region (*γcPr*). Here we explore the importance of conditioning regimens and cell dose for successful reconstitution. We investigated the effects of lowering the cell dosage and of reducing or eliminating the pre-transplant irradiation conditioning of recipient *Il2rg*^{-/-} mice when transplanting wild type donor cells or *Il2rg*^{-/-} cells transduced with our *γcPr-coγc* and PGK-*coγc* vectors. We found that lowering the number of cells transplanted below 500,000/kg body weight had a negligible effect on the reconstitution of T cells in mice given WT cells, but resulted in a significant reduction of the number of circulating B cells. The effect of low cell dose on the gene therapy treated mice was even more pronounced, with reduced T cells and few or no peripheral B cells being observed in these mice. Reducing pre-transplant irradiation conditioning from 6 Gy to 2 Gy had little or no effect, but mice given no pre-transplant conditioning had a more protracted immune reconstitution in both *coγc*-treated and wild type groups and also had poor responses to immune system challenges. We conclude that successful immune system reconstitution requires a higher number of gene therapy treated cells to be transplanted compared to wild type cells, and that moderate conditioning is required for reliable full reconstitution, especially of the B cells. When the minimum requirements of conditioning and cell number are met, lentiviral-based *coγc* gene therapy is an effective treatment for X-SCID. The PGK promoter and native *γc* promoters driving expression of the codon optimized IL2RG gene are efficacious candidates for future clinical gene therapy development. Current experiments focus on long-term follow-up monitoring of potential adverse effects and integration analyses of treated mice.

253. A2UCOE-eGFP Confers Sustained Transgene Expression in Human Fetal Liver Hematopoietic Stem Cells (FL-HSC)

Niraja Dighe,¹ Maroun Khoury,⁴ Mark Chong,¹ Citra Mattar,¹ Simon Waddington,⁵ Michael N. Antoniou,⁶ Jianzhu Chen,⁴ Mahesh Choolani,¹ Jerry Chan.^{1,2,3}

¹Experimental Fetal Medicine Group, Department of Obstetrics and Gynecology, Yong Loo Lin School of Medicine, National University of Singapore, Singapore, Singapore; ²Department of Reproductive Medicine, KK Women's and Children's Hospital, Singapore, Singapore; ³Cancer and Stem Cell Program, Duke-NUS Graduate Medical School, Singapore, Singapore; ⁴Interdisciplinary Research Group in Infectious Diseases, Singapore-Massachusetts Institute of Technology Alliance in Research and Technology, Singapore, Singapore; ⁵Institute of Women's Health, Gene Transfer Technology, University College London, London, United Kingdom; ⁶Department of Medical and Molecular Genetics, King's College London, School of Medicine, Guys Hospital, London, United Kingdom.

Introduction: We have previously reported human fetal liver-derived Hematopoietic Stem Cells (FL-HSC) as a candidate for targeted gene transfer, for the treatment of single-gene hemopoietic disorders. Recent studies suggest efficient and stable expression of transgenes from the ubiquitously acting chromatin opening element (UCOE) promoter in murine models. Here, we study the use of UCOE-mediated transgene regulation in FL-HSC, in comparison to other commonly used promoters. **Methods:** CD34⁺ cells were isolated from second trimester human liver (fHSC) by MACS and subsequently infected with Lenti-UCOE-eGFP, PGK-eGFP and EF1α-eGFP at multiplicities of infection (MOI) from 1 to 20. CFU assays, vector copy number analyses (VCN) and methylation studies were done to evaluate the effects of transduction on HSC character, efficiency of transduction and silencing effects of vectors respectively. Subsequently, infected cells were transplanted into sublethally-irradiated neonatal NOD/SCID/*Il2rg*^{-/-} mice via intracardiac injection to study multilineage engraftment and secondary transplantation capacity of transduced HSC. Reconstitution and GFP expression were analysed in blood, bone marrow and spleen of mice sacrificed at 10 months post injection. In parallel, some cells were expanded in culture to study the continued expression of GFP. **Results:** Lenti-UCOE-eGFP demonstrated 90% transduction at a MOI of 10 with sustained transgene expression (84%) 12 weeks post injection. This was maintained at 10 months in vivo, with 98% of huCD45⁺/CD34⁺ cells continuing to express GFP. This was mirrored with in vitro cultured transduced HSC in extended culture. In contrast, cells transduced with PGK-eGFP demonstrated 40% GFP expression at a MOI of 10, and a further reduction in GFP expression in CD45⁺/CD34⁺ cells to 29% after 12 weeks in vivo. Methylation studies suggest a possible role of methylation resistance in the sustained expression from UCOE. Lentiviral transduction of HSC did not alter multilineage capacity on methylcellulose cultures. **Conclusions:** Lenti-UCOE-eGFP, has shown sustained transgene expression of at least 10 months owing to its silencing resistant property, thus lending support to its utility for HSC mediated gene therapy.

254. Correction of RAG2 Severe Combined Immunodeficiency by Lentiviral Gene Therapy Requires Strong Expression of RAG2

Niek P. van Til,¹ Helen de Boer,¹ Roya Sarwari,¹ Trudi P. Visser,¹ Barbara Cassani,² Anna Villa,³ Gerard Wagemaker.¹

¹Department of Hematology, Erasmus University Medical Center, Rotterdam, Netherlands; ²Fondazione Humanitas per la Ricerca, Rozzano, Milan, Italy; ³CNR-ITB; Telethon Institute for Gene Therapy-HSR, Milan, Italy.

Recombination activating gene 2 (RAG2) deficiency results in severe combined immunodeficiency (SCID) due to a lack of T and B lymphocytes, caused by a block in differentiation. Patients succumb due to recurrent infections within the first year of life, unless treated with an allogeneic bone marrow (BM) transplant. Unfortunately, the paucity of compatible donors affects the efficacy of treatment and the survival of treated patients. Gene therapy using gammaretroviral vectors for X-linked SCID gene therapy and adenosine deaminase (ADA)-SCID has been shown to be highly effective, but RAG2 SCID may require more tightly controlled expression as its expression is heavily regulated during normal T and B cell development. Previously, it has been shown that gammaretroviral vectors can effectively restore immune function in *Rag2*^{-/-} mice. To improve efficacy and reduce the risk of genotoxicity we developed and tested self-inactivating lentiviral vectors constituting a codon-optimized RAG2 (RAG2co) driven by the spleen focus forming virus promoter (SF). This vector was then compared to its native RAG2 counterpart as well as to weaker cell-restricted promoters based on minimum elements of the RAG2 and γ c promoter. 5×10^5 *Rag2*^{-/-} transduced lineage negative BM cells were transplanted in sublethally irradiated *Rag2*^{-/-} mice, monitored for six months. Codon-optimization of RAG2 increased detectable RAG2 protein 3-fold, determined in HeLa cells. The SF-RAG2co vector resulted in a significant reduction in the developmental block during T and B cell differentiation in thymus and BM, respectively, and in robust reconstitution of CD4 and CD8 T cell subsets, as well as mature IgM⁺IgD⁺ B cells in peripheral blood and spleen. Reconstitution of T and B cells following transplantation of cells transduced with the vector carrying the native RAG2 was significantly slower, and most peripheral T cells expressed a single dominant T cell receptor subtype. In contrast, the RAG2 and γ c promoter reconstituted T cells effectively, but hardly any B cells. Vector copy number per cell determined in bone marrow was considerable higher in the SF-RAG2co (2.3±2.0, n=17) and SF-RAG2 treated mice (3.0±0.9, n=7) than in those treated with the RAG2 and γ c promoters (0.5±0.5, n=9 and 0.5±0.4, n=11 respectively), and proportional to the levels of reconstitution. In the SF-RAG2co treated mice, T cell responses to mitogens, plasma immunoglobulin levels and T cell dependent (tetanus toxoid) and independent (pneumococcal polysaccharide vaccine) antibody responses were fully restored, but incomplete in the other treatment groups. We conclude that complete immune restoration can be achieved in *Rag2*^{-/-} mice by use of the strong SF promoter driving constitutive RAG2co expression and that further development towards safe promoter cassettes is required for clinical application.

255. Correction of X-SCID by Sleeping Beauty-Mediated Gene Transfer into Hematopoietic Cells

Kendra A. Hyland,¹ Erik R. Olson,¹ Nicola Philpott,² Xianzheng Zhou,³ R. Scott McIvor.¹

¹Discovery Genomics, Inc., Minneapolis, MN; ²Medicine, Rheumatic and Autoimmune Diseases, University of Minnesota, Minneapolis, MN; ³Pediatrics, University of Minnesota, Medical School, Minneapolis, MN.

Primary immune deficiencies comprise a group of inherited genetic disorders caused by interruption of normal lymphoid development.

X-linked severe combined immunodeficiency (X-SCID) is one of the most common primary immunodeficiencies, and is caused by a mutation in the gene encoding the common gamma chain (γ c) of the receptors for IL-2, IL-4, IL-7, IL-9, IL-15, and IL-21. In the absence of γ c protein, cytokine signaling via the JAK-STAT pathway is interrupted, thereby blocking normal lymphoid development. Clinical trials employing retroviral vectors for *ex vivo* treatment of X-SCID have resulted in complete restoration of patient immunity. However, serious adverse events have emerged, highlighting the need for development of alternate and less genotoxic approaches for therapeutic gene transfer. The *Sleeping Beauty* (SB) transposon system mediates stable integration of sequences into mammalian chromosomes, supporting long term expression of both reporter and therapeutic genes. Advantages of the SB system include ease of manufacture, reduced immunogenicity in comparison with viral vectors, and a more random and potentially less genotoxic integrant profile in comparison with retroviral and lentiviral vectors. We first demonstrated successful transposon-mediated expression of γ c protein and restoration of JAK-STAT signaling in a T-cell line, lacking the γ c gene. Introduction of plasmid DNA by electroporation into mouse hematopoietic stem cells (HSC) is not currently feasible, so we will deliver the SB system to mouse HSC using a non-integrating lentiviral vector system. After transplantation of transduced HSC in γ c-deficient mice, we will assay for correction of lymphoid development by measuring the presence of B, T, and NK cells as well as restoration of normal immunity. Transposition will be verified by recovery and molecular characterization of transposon integrants and flanking chromosomal sequence. Results from these studies will provide a platform for establishment of SB-mediated transposition of HSC in the treatment of human X-linked SCID.

256. The Comparison of Various Promoters for Wiskott Aldrich Syndrome Gene Therapy Using Insulated Lentiviral Vectors

Rachel M. Koldej,¹ Gael Carney,¹ Matthew Wielgosz,¹ Satyanarayana Pondugula,¹ Arthur W. Nienhuis.¹

¹Hematology, St Jude Children's Research Hospital, Memphis, TN.

Wiskott Aldrich Syndrome (WAS) is a severe disease which affects virtually all lineages of the hematopoietic system. Thrombocytopenia, eczema and recurrent or persistent infections are common disease manifestations. Patients with a matched sibling donor can be cured by bone marrow transplantation but transplantation from alternative donors leads to a poorer outcome. Development of effective lentiviral vector mediated gene therapy for WAS would provide alternative curative therapy. Our efforts to develop a safe and effective self-inactivating lentiviral vector for gene therapy of WAS have focused on the evaluation of vectors with an insulator element in the integrated long terminal repeats (LTRs) and various internal promoters driving the WAS protein (WASp) cDNA. The ideal promoter for WAS gene therapy would achieve physiological expression levels at the majority of integration sites in all relevant blood lineages, particularly T-cells, B-cells, monocytes and megakaryocytes. Several promoters including a γ -retroviral LTR (MND), a short fragment (240 bp) from the elongation factor 1- α (EF1 α) promoter and various length fragments of the proximal WAS gene promoter are being evaluated. These promoters were cloned into non-insulated, 400bp or 650bp chicken HS4 insulated lentiviral vectors and examined in mouse bone marrow transplant studies using GFP as a surrogate marker for hWASp expression. Lineage negative B6.SJL-*Ptprca*^o *Pepe*^o/BoyJ mouse bone marrow was prestimulated for 28 hours prior to transduction on retronectin coated plates for 21 hours with virus at an MOI of 20 after which the transduced cells were administered *via* tail vein to irradiated recipient C57BL/6J mice. The mice were monitored with periodic eye bleeds and sacrificed 22 weeks post transplant. In peripheral blood all mice exhibited equal levels of

engraftment (>80%) with percent GFP positive ranging from 40-100% in CD45.1 positive white blood cells. The presence of the 400bp insulator increased relative GFP expression in lymphoid lineages when combined with the short (500bp) WAS promoter fragment but not the full length (1.6kb) WAS promoter or the EF1 α promoter. Platelet counts stabilized at 600 to 1,200 $\times 10^3$ /ul and GFP expression, when normalized to bone marrow copy number, showed that the presence of the 400bp insulator increased expression in the platelets independent of the promoter utilized. In bone marrow, the 400bp insulator decreased GFP expression from the EF1 α promoter in every lineage examined. In contrast, expression from either the short or full length WAS promoter was not affected. Secondary transplants are ongoing. *In vitro* studies in WAS patient peripheral blood mononuclear cells using insulated hWASp expression vectors have demonstrated that while all the promoters examined will express to wild-type levels in transduced cells, the MND promoter gives a higher proportion of cells expressing at this level.

257. In Vivo, Lineage-Directed Transgene Expression after Hematopoietic Stem Cell Gene Transfer in a Large Animal Model

Aravind Ramakrishnan,^{1,2} Beverly Torok-Stord,¹ Mortimer Poncz,³ Nathaniel P. Williams,¹ Christina Ironside,¹ Hans-Peter Kiem,^{1,2} Brian C. Beard.¹

¹Clinical Research Division, Fred Hutchinson Cancer Research Center, Seattle, WA; ²Department of Medicine, University of Washington, Seattle, WA; ³Pediatric Hematology, The Children's Hospital of Philadelphia, Philadelphia, PA.

Efficacy of gene-modified hematopoietic stem cell (HCS) transplantation for the treatment of patients with single allele genetic disease has unequivocally been demonstrated for adenosine deaminase deficiency severe combined immunodeficiency (ADA-SCID), X-linked severe combined immunodeficiency (SCID-X1), chronic granulomatous disease (CGD), adrenoleukodystrophy, (ALD), and Wiskott-Aldrich Syndrome (WAS). For a subset of these patients proto-oncogene activation as a result of insertional mutagenesis have resulted in both clonal dominance and frank leukemia. The strong promoter enhancer elements in the long terminal repeats (LTR) were likely responsible for the adverse events seen in these patients. In order to maintain the efficacy of these pioneering clinical trials while improving the safety for future patients a promising strategy is to eliminate the LTR promoter and enhancers and instead use inducible or lineage-directed promoters. In mouse and human cells, the platelet factor 4 (PF4) promoter is largely megakaryocyte lineage-specific and has been used to study megakaryopoiesis. We hypothesized that the PF4 promoter could potentially be used as a tool to target transgene expression specifically to the megakaryocytic lineage. In theory, this could be used to correct underlying genetic defects that affect platelets or utilize platelets as delivery vehicles to deposit specific gene products at sites of thrombosis/injury. To effectively test hematopoietic lineage expression of the PF4 promoter in a large animal, we used the clinically relevant dog model. Specifically, autologous CD34-selected bone marrow cells were transduced with a VSVG-pseudotyped HIV-derived self-inactivating (SIN) lentivirus vector with PF4 expressing green fluorescent protein (GFP) using a 24-hour protocol at a multiplicity of infection of ~ 10 . Following ablative conditioning $\sim 1.0 \times 10^6$ cells/kg were infused and the dog displayed normal gene-modified hematopoietic engraftment kinetics. At the most recent follow-up, 77 days after transplantation, the dog has stable *in vivo* gene marking of $\sim 5.4\%$ in granulocytes, $\sim 2.4\%$ in red blood cells, and $\sim 19.0\%$ in platelets. Importantly, compared to historical controls at similar time points for dogs that received cells gene-modified with HIV-derived SIN lentivirus vectors expressing GFP from a constitutive promoter (phosphoglycerate kinase-PGK) the fold difference in mean fluorescence intensity of GFP+ relative

to GFP- gene marked granulocytes was 34.9 (PGK) compared to 12.2 (PF4) and gene marked platelets was 12.9 (PGK) compared to 72.1 (PF4). These data shows that the PF4 promoter is preferentially active in platelet lineages and far less active in myeloid lineages and have important implications for improving the safety and efficacy of gene therapy strategies by limiting transgene expression primarily to affected subsets or specifically for this application, sites of thrombosis/injury.

258. Non-Myeloablative Conditioning with Busulfex 8 mg/kg or 200 cGy TBI Is Equivalent in Gene Therapy of Canine Leukocyte Adhesion Deficiency Using Foamy Viral Vectors

Thomas R. Bauer, Jr.,¹ Erik M. Olson,² Laura M. Tuschong,¹ Tanya H. Burkholder,³ David W. Russell,² Dennis D. Hickstein.¹

¹Experimental Transplantation and Immunology Branch, National Cancer Institute, National Institutes of Health, Bethesda, MD;

²Department of Hematology, University of Washington, Seattle,

WA; ³Division of Veterinary Service, Office of Research Services, National Institutes of Health, Bethesda, MD.

The optimal non-myeloablative regimen for hematopoietic stem cell gene therapy for treatment of phagocytic diseases remains unclear. In particular, the use of low doses of ionizing radiation, although widely used in reduced intensity allogeneic hematopoietic conditioning regimens, has not been used in human gene therapy clinical trials. To address this issue, we compared the results with non-myeloablative conditioning with Busulfex 8 mg/kg to conditioning with 200 cGy total body irradiation (TBI) in the engraftment and chimerism of foamy viral (FV) vector transduced CD34+ cells in animals with canine leukocyte adhesion deficiency (CLAD). Similar to children with LAD-1, dogs with CLAD suffer from recurrent bacterial infections and early death within the first six months of life due to infections resulting from the absence of the CD18 leukocyte integrin on the neutrophil surface and the resultant lack of adherence and migration of neutrophils lacking CD18. Initially, four CLAD pups were treated using a non-myeloablative conditioning regimen of 200-cGy total body irradiation (TBI) administered the day before receiving genetically-corrected cells. The four dogs survived for four years, at which time the study was completed. Of note, CD18+ neutrophil levels ranged from 2.9 to 3.9% in the peripheral blood, and CD18+ T-cell levels ranged from 10.7 to 22.9% at one-year post-transplant. In the companion study four CLAD pups received a reduced intensity conditioning regimen with Busulfex 8 mg/kg given IV two days prior to infusion of genetically-corrected cells. All four dogs survived more than 1 year, free of severe CLAD disease. CD18+ neutrophil levels ranged from 1.8 to 4.5% and CD18+ T-cell levels ranged from 14.1 to 21.6% at one-year post-transplant. Thus, comparison of the chimerism levels in the dogs in each group revealed little difference between the conditioning regimens at 1 year post-transplant. The slight variation in chimerism could be attributed to the corrected cell doses infused. No animal with either regimen became neutropenic nor required platelet infusions due to conditioning. These results demonstrate the efficacy of both conditioning regimens for achieving sufficient levels of CD18+ cells to reverse the CLAD disease phenotype, and further show that Busulfex 8 mg/kg appears to represent an effective substitute for 200 cGy TBI as a conditioning regimen for the treatment of myeloid disease such as LAD by hematopoietic stem cell gene therapy.

259. Mouse Transplant Models for Evaluating the Safety of a SCID-X1 Lentiviral Vector

Sheng Zhou,¹ Zhijun Ma,¹ Taihe Lu,¹ Laura J. Janke,¹ John T. Gray,¹ Brian P. Sorrentino.¹

¹St. Jude Children's Research Hospital, Memphis.

The multiple cases of hematological malignancies in several gene therapy trials underscore the need for better preclinical safety models for assessing vector safety. Mouse transplant models allow in vivo studies of vector safety and also testing in a SCID-X1 genetic background, which is known to increase transformation risk. We also used a second model based on serial transplantation of wildtype cells using the SFFV gamma-retrovirus as a positive control. Both of these studies lasted up to 14 months and a full necropsy is performed by a certified veterinary pathologist. The test item was our self-inactivating CL20i4-EF1 α -hy_gOPT vector (EF1 α) expressing a codon optimized gamma chain cDNA under control of a short EF1 α promoter. In the first experiment (Exp 1, table 1), none of the primary recipient mice developed any hematological malignancies during the 5-7 months of observation period. Three secondary recipients from the same primary recipient donor in the EF1 α group with SCID-X1 donor cells developed a clonal IgM+, Pax5+ B cell lymphoma. Vector integration analysis identified a single copy vector insertion in the first intron of the Pkn2 gene, in the antisense orientation. The Pkn2 gene encodes for a serine threonine kinase involved in cell cycle entry and mitosis, suggesting that its deregulation could be oncogenic. Pkn2 mRNA levels measured by qRT-PCR from sorted leukemic cells was 58% of that of the normal IgM+ B cells and 30-43% of that of two B cell leukemic cells lines 70Z and CH12.1.6, showing that the B cell lymphoma was not caused by insertional activation of the Pkn2 gene. No hematological malignancies occurred in any other groups so that this single case of malignancy was not statistically significant. In the second transplant experiment (Exp 2, table1), no hematological malignancies occurred in any primary recipients. However, peripheral blood lineage analysis by flow cytometry showed significant myeloid lineage skewing in the SFFV-DsRed group at 14 weeks to 7 months. Secondary transplants have recently been performed and three mice from a single primary recipient donor in the SFFV-DsRed group had high leukocyte count at 18 weeks, with blasts on blood smear. All the mice will continue to be monitored for 7 months and results will be reported at the meeting. Altogether, our study showed no vector induced leukemias in as many as 79 primary recipients that received transplant of vector transduced bone marrow cells, supporting the notion that mouse models are insensitive for vector safety evaluation. In the SCID-X1 model, we did not derive useful information and we conclude the single case of B cell lymphoma was not related to vector insertion. The ongoing study with wildtype cells suggests that the EF1 α lentiviral vector is less prone to inducing clonal skewing than the SFFV gamma-retroviral vector.

Table1. Design of two transplant experiments

	# Primary recipients	vector copy number in PBMNC of Primary recipients	# Secondary recipients
Exp 1	Rag2 ^{-/-} IL2rg ^{-/-}		Rag2 ^{-/-} IL2rg ^{-/-}
Mock	11		23
MSCV	15	1.4 ± 0.58	36
EF1 α	15	2.17 ± 0.74	39
Exp 2	WT		WT
Mock	15		42
MFG- γ c	15	0.81 ± 0.31	42
SFFV-DsRed	19	1.81 ± 1.23	51
EF1 α	15	1.59 ± 0.39	45

MSCV: MSCV- γ c-IRES-GFP. MFG- γ c: French SCID-X1 trial vector.

260. Balancing Efficacy and Adverse Outcomes in Gene Therapy for Wiskott-Aldrich Syndrome

Alexander Astrakhan,^{1,3} Blythe Sather,³ Sara Mamman,³ Michelle Brault,³ Socheath Khim,³ Byoung Ryu,³ Carol Miao,³ David J. Rawlings.^{1,2,3}

¹Immunology, University of Washington, Seattle, WA; ²Pediatrics, University of Washington, Seattle, WA; ³Center for Immunity and Immunotherapies, Seattle Children's Research Institute, Seattle, WA.

Wiskott-Aldrich Syndrome (WAS) is a rare primary immunodeficiency caused by mutation of Wiskott-Aldrich Syndrome protein (WASp). Defective WASp functionality results in abnormal immunological synapse formation, impaired cellular migration and compromised cellular signaling. As a result, WAS patients present with frequent infections, thrombocytopenia, autoimmunity and increased risk of malignancies. The disease is usually fatal in the absence of bone marrow transplant; and gene therapy represents a promising alternative for patients lacking well-matched donors. We investigated selective advantage and promoter activity as variables potentially regulating successful lentiviral (LV) - based gene therapy treatment in a murine model of WAS. We compared in vivo efficacy of transplanted hematopoietic stem cells transduced using LV vectors containing either the gammaretroviral-derived enhancer/promoter, MND, or the mammalian WAS endogenous promoter, WS1.6, to drive human WASp in WASp^{-/-} recipient mice. MND-huWASp LV resulted in endogenous levels of WASp expression in all hematopoietic lineages and selection for WASp+ T, NKT and B cells. MND-huWASp recipients exhibited normalized T cell proliferation and cytokine production and generated abundant marginal zone (MZ) B cells. We also observed a single instance of viral-mediated myeloid clonal dominance with MND-huWASp, suggesting an enhanced risk of insertional mutagenesis using this promoter. In contrast, WS1.6-huWASp LV exhibited substantially weaker promoter activity and resulted in only partial selection for WASp+ T cells and minimal selection for WASp+ B cells. WS1.6-huWASp recipients exhibited minimal rescue of MZ B cell formation and an increase in autoimmune-prone B cells. Our findings identify relative benefits and potential risks for each of these enhancer/promoter elements currently in use in clinical trials; and suggest approaches that may lead to a safer and more effective gene delivery platform for treating Wiskott-Aldrich Syndrome.

261. Further Amelioration of the Late Effects of Total Body Irradiation (TBI) by Manganese Superoxide Dismutase Plasmid/Liposome (MnSOD-PL) Gene Therapy Supplemented by a Continuous Antioxidant-Chemopreventive Diet

Michael W. Epperly,¹ Hong Wang,¹ Jeffrey A. Jones,^{2,3} Tracy Dixon,¹ Carlos A. Montesinos,⁴ Joel S. Greenberger.¹

¹Department of Radiation Oncology, University of Pittsburgh Cancer Institute, Pittsburgh, PA; ²National Aeronautics and Space Administration, Johnson Space Center, Houston, TX; ³Department of Urology, Baylor College of Medicine, Houston, TX; ⁴AmeriSciences LP, Houston, TX.

Both acute and chronic effects of ionizing irradiation are mediated by reactive oxygen species (ROS) and reactive nitrogen species (RNS) which deplete antioxidant stores leading to cellular apoptosis, stem cell depletion, and accelerated aging. TBI acute effects occur within the first month after irradiation. Survivors may suffer late effects which occur months to years after irradiation. Following irradiation, there is continued expression of ROS or RNS for weeks to months leading to accumulation of damage which contributes to late effects. We tested the hypothesis that late effects of TBI may be reduced if increased antioxidants are continually present during prolonged

expression of ROS and RNS following irradiation. We demonstrated that C57BL/6NHsd mice receiving intravenous MnSOD-PL prior to 9.5 Gy total body irradiation (TBI) show increased survival from the acute hematopoietic syndrome as well as improved long term survival (Epperly, et al., *Radiation Research*, 170(4):437-444, 2008). We now evaluated whether an antioxidant-chemopreventive diet alone or with MnSOD-PL (compared to a regular diet) improved long-term survival. Beginning seven days before TBI, two groups of eighty C57BL/6NHsd female mice were placed on either a control house diet or a diet enriched with antioxidants. Twenty-four hours before the LD 50/30 dose of 9.5 Gy TBI subgroups of forty mice were injected intravenously with MnSOD-PL (100 µg plasmid DNA in 100 µl). Following irradiation each group remained on the house diet or on the antioxidant diet. Mice treated with MnSOD-PL showed decreased deaths in the first 30 days following irradiation, independent of diet compared to irradiated mice on the house diet alone ($p = 0.031$ for the House Diet plus MnSOD-PL or 0.015 for antioxidant diet plus MnSOD-PL). Survival over the first 30 days was unaffected by either diet alone in the absence of MnSOD-PL ($p = 0.823$). Mice on the antioxidant-chemoprevention diet alone or combined with MnSOD-PL that survived 30 days had a significant increase in survival compared to TBI mice on the regular diet ($p = 0.040$ or 0.010 , respectively) and mice treated with MnSOD-PL only and surviving 30 days after TBI had increased survival compared to those on the regular diet alone ($p = 0.020$). The best overall (acute and long term) survival was in mice receiving MnSOD-PL and antioxidant diet. The data support continually increasing bioavailable antioxidants to reduce acute and late effects of irradiation.

262. High Levels of Polyclonal, Multilineage Hematopoietic Cell Gene Marking Following Lentiviral Transduction and Transplantation of Steady-State Bone Marrow CD34⁺ Cells in a Non-Human Primate Model

Phillip W. Hargrove,¹ Yoon-Sang Kim,¹ Amy Taylor,¹ Dana Simpson,¹ Andrew M. Davidoff,¹ Perdeep K. Mehta,¹ Derek A. Persons.¹

¹St. Jude Children's Research Hospital, Memphis, TN.

Non-human primate autologous hematopoietic stem cell (HSC) transplantation models have been invaluable in developing the ex vivo transduction protocols used in human gene transfer clinical trials. Previous studies of HSC gene transfer using gamma-retroviral and lentiviral vectors in these models have almost exclusively utilized cytokine-mobilized peripheral blood (PB) or bone marrow (BM) CD34⁺ cells as target cells. The administration of the combination of granulocyte colony stimulating factor (G-CSF) plus stem cell factor (SCF) became standard as a priming method prior to HSC collection after it was shown that SCF coupled with G-CSF resulted in significantly improved long-term gene transfer levels, compared to poor gene transfer with G-CSF alone. However, SCF is not available in the US for human gene transfer trials due to its history of causing severe anaphylactic reactions. For this reason and to define a clinically relevant gene transfer protocol for sickle cell disease, in which G-CSF administration is also contraindicated, we evaluated lentiviral stem cell gene transfer using steady-state BM CD34⁺ cells in the pigtail macaque transplantation model. Bone marrow CD34⁺ cells were enriched using an anti-CD34 antibody, immunomagnetic beads and prestimulated overnight in serum-free medium containing 100 ng/ml of FLT-3 ligand, thrombopoietin, and stem cell factor. Cells were then exposed for 14 hours to a VSV-G pseudotyped, HIV-based lentiviral vector encoding GFP at an MOI of 40. After 24 hours of culture in serum-free medium, cells were transplanted into an animal (15 x 10⁶/kg) which had been conditioned with 950 cGy. The marked cells, as assessed by flow cytometry for GFP expression, was 74% and all hematopoietic colonies obtained in methylcellulose cultures were GFP

positive. Neutrophil recovery (ANC > 500) was observed on day 20. At 96 weeks post-transplant, PB leukocyte marking levels are: 16%, B cells 16% and T cells 17%. Vector copy number in PB leukocytes at 80 weeks was 0.4. Insertion site analysis using LAM-PCR coupled with next generation sequencing technology identified 950-2200 unique vector insertion sites (clones) present at each of multiple, individual time points post-transplantation. We observed some clones with a large contribution to hematopoiesis early on, but much less frequently at subsequent time points and a highly polyclonal vector insertion site set of more than 2000 unique insertions was identified at 5 months post-transplant. We are currently obtaining insertion site data from the 80 week time point. Two additional animals were transplanted with transduced steady-state BM CD34⁺ cells (11 x 10⁶ cells/kg and 6.7 x 10⁶ cells/kg). One animal displayed granulocyte marking of 75% two weeks post-transplant but died unexpectedly due to a "bloat" syndrome unrelated to the transplant procedure. The third animal at day 46 showed myeloid marking of 35%. These data are critical as they suggest that therapeutic levels of lentiviral vector gene transfer can be obtained using CD34⁺ cells from steady-state BM as the HSC cell source.

263. Long-Term Multi-Lineage Engraftment of NOD-scid IL2Rgnull Mice after Transplantation with Genetically Modified b-thalassemic CD34⁺ Cells

Leda Ferro,¹ Jinrong Qu,¹ Clare Taylor,¹ Xiuyan Wang,¹ Aurelio Maggio,² Farid Boulad,¹ Sadelain Michel,³ Isabelle Riviere.¹

¹Gene Transfer Facility, MSKCC, New York; ²Hematology II, V. Cervello Hospital, Palermo, Italy; ³Center of Stem Cell Engineering, MSKCC, New York.

The β -thalassemias are genetic disorders caused by β -globin mutations that reduce or abolish β -globin gene expression. The transplantation of autologous hematopoietic stem cells (HSCs) modified with recombinant lentiviral vectors (LVs) encoding the human β -globin gene represents a potentially curative therapy for patients lacking an HLA-matching donor. We previously showed stable erythroid specific and therapeutic levels of human β -globin expression in mice transplanted with TNS9 transduced HSCs genetically modified with the TNS9 LV. Here we sought to optimize the transductions of G-CSF mobilized-CD34⁺ cells derived from thalassemic patients using the LV TNS9 and analyzed the engraftment potential of the genetically modified patient HSCs. We tested the transduction efficiency of G-CSF mobilized-CD34⁺ cells derived from patients with β -thalassemia using various prestimulation cytokine cocktails, MOIs, time in culture and single versus double transductions. We were able to obtain an average of 0.6-1.2 vector copies/cell and 1-2 copies/cell in a methocult based clonogenic assay. β -globin expression was demonstrated by HPLC. We further investigated the engraftment efficiency of the genetically modified HSCs using the NOD-scid IL2Rgnull mouse model. Transduced thalassemic CD34⁺ cells, harvested after 3 or 4 days in culture, were injected into sublethally conditioned mice at various doses. We detected 5-50% of CD45⁺ cells in the bone marrow of the transplanted mice up to six months after bone marrow transplantation. Detectable amount of CD45⁺ cells were also found in peripheral blood, spleen and liver of this animals. Multi-lineage engraftment was obtained as demonstrated by the presence of both myeloid (up to 20%) and lymphoid (up to 90%) cell types. The majority of the CD45⁺ cells detected in the bone marrow were of the lymphoid lineage with mature B cells ($\leq 70\%$ CD19/CD10⁺ cells), immature B cells ($\leq 15\%$ CD10⁺ cells) and/or T lymphocytes ($\leq 3\%$ CD3⁺). Additionally, we found cells of the myeloid lineage such as early erythroblasts ($\leq 6\%$ CD71⁺), megakaryocytes ($\leq 3\%$ CD61⁺) and monocytes ($\leq 7\%$ CD14⁺) β -globin vector sequences were also detected in the engrafted human cells. Our findings demonstrated that we could

achieve long-term multi-lineage engraftment using transduced patient specific thalassemic G-CSF mobilized CD34+ cells expressing human beta-globin. These studies provide the basis for the upcoming phase I clinical trial of β -thalassemia major using LV transduced CD34+ cells encoding beta-globin.

264. Uncovering Haemopoietic System Dynamics and Tracking Fate and Long-Term Survival of Single Progenitor Clones In Vivo in Humans by Retroviral Tagging

Luca Biasco,¹ Cristina Baricordi,² Cynthia Bartholomae,³ Immacolata Brigida,¹ Samantha Scaramuzza,¹ Raffaele Fronza,⁴ Stefania Merella,¹ Alessandro Ambrosi,⁵ Danilo Pellina,⁵ Clelia Di Serio,^{2,5} Eugenio Montini,¹ Christof von Kalle,⁴ Manfred Schmidt,⁴ Alessandro Aiuti.^{1,6}

¹San Raffaele Telethon Institute for Gene Therapy (HSR-TIGET), Milan, Italy; ²Vita-Salute University San Raffaele, Milan, Italy; ³National Center for Tumor Diseases (NCT), German Cancer Research Center (DKFZ), Heidelberg, Germany; ⁴Alma Mater Studiorum University, Bologna, Italy; ⁵CUSSB Vita-Salute University, Milan, Italy; ⁶University of Rome "Tor Vergata", Rome, Italy.

Upon retroviral mediated gene correction of haemopoietic stem cells (HSC) each transduced progenitor is univocally marked by an integration site. Long-term studies in gene therapy (GT) patients allow for the first time to track haemopoietic clonal dynamics and survival of single progenitor clones in humans by retroviral tagging. We previously showed that ADA-SCID GT with CD34+ cells combined to reduced intensity conditioning resulted in full multilineage engraftment, in the absence of aberrant expansions. We now performed a comprehensive multilineage longitudinal insertion profile of bone marrow (BM) (CD34+, CD15+, CD19+, Glycophorin+) and peripheral blood (PB) (CD15+, CD19+, CD4+, CD8+ cells, naïve and memory T cells) cells in 4 patients 3-6 years after GT, retrieving to date 1055 and 1999 unique insertions from BM and PB cell lineages respectively. We could shape the "insertional landscape" of each lineage through a tri-factorial analysis based on insertional variables allowing to uncover the effects of selective advantages of gene-corrected cells in the periphery and the frequency of identical integrants in different haematopoietic compartments. BM cells and PB granulocytes displayed the highest proportion of shared integrants (up to 58.1%), reflecting the real-time repopulating activity of gene-corrected progenitors. Strikingly, we detected "core integrants", shared between CD34+ cells and both lymphoid and myeloid lineages at multiple time points, stably tagging active long-term multipotent progenitors overtime. Tracking two of these integrants (inside a fragile site of MLLT3 gene and downstream the LRRC30 gene) by specific PCRs we confirmed the multilineage contribution to haematopoiesis of these progenitor clones, showing fluctuating lineage outputs over a period of 5 years in the patient. We also retrieved 170 integrations from 4 T cell subtypes (Naive, TEMRA, Central and Effector memory) from one patient who received infusions of transduced PBL showing evidences that naive T cell clones may survive in humans for up to 10 years while maintaining their differentiation capacity into different T cell subpopulations. Additional analyses on transcriptional and chromatin status of integration sites collected from all lineages are ongoing. In conclusion, through retroviral tagging, we can uniquely track single transduced haemopoietic cells directly in vivo in humans. The application of mathematical models to our insertion datasets is allowing to uncover new information on the fate and activity of haematopoietic progenitors and their differentiated progeny years after transplantation in GT patients.

265. Deep Sequencing Analyses of Small RNAs in HIV-1 Infected Cells Transduced with a Triple Inhibitory RNA Lentiviral Vector

Haitang Li,¹ John Rossi.¹

¹Molecular and Cell Biology, City of Hope, Duarte, CA.

In an effort to develop a hematopoietic gene therapy approach to treat HIV infection, we created a lentiviral vector containing three different inhibitory agents including a short hairpin RNA (shRNA) targeting the HIV tat/rev region, a nucleolar localizing Tat binding decoy and a ribozyme against the endogenous CCR5 chemokine receptor mRNA. This lentiviral construct, has proven to be highly effective in inhibiting HIV replication in cell culture and is currently in use in gene therapy trial for AIDS/lymphoma patients. The potential deregulation of miRNA expression by ectopic expression of a short hairpin RNA or HIV-1 infection has been a matter of concern for gene therapy applications of RNAi. We therefore took advantage of next generation sequencing to monitor endogenous microRNA changes during the time course of HIV-1 infection in CEM T-cells transduced with the triple construct vector in the presence and absence of HIV-1 infection. Consistent with the idea that HIV replication was effectively inhibited, microRNAs generated from HIV-1 TAR and Nef were greatly reduced in triple construct treated CEM cells relative to vector backbone alone transduced cells, HIV-1 infected cells. Interestingly, the level of several endogenous microRNAs changed dramatically at different time points in the face of HIV-1 challenge, but the changes were less dramatic in cells expressing the anti-tat/rev shRNA. We also analyzed the ratios of the anti-HIV tat/rev guide strand versus the passenger strand over time in the triple construct transduced cells infected with HIV versus the uninfected triple construct transduced cells. Our results show that the guide strand/passenger strand ratio increases dramatically in HIV-1 infected cells whereas it remains stable in uninfected vector transduced cells. These results support a model in which engagement of an siRNA guide strand via targeting of the HIV transcripts leads to its stabilization. Finally, we analyzed the microRNA profile from a patient in the clinical trial at two time points-one pre-transduction and the other one year post transduction and post autologous stem cell transplant. The results of these analyses show marked changes in the miRNA profile as well, most likely a consequence of the stem cell transplant. We also see the HIV-1 TAR miRNA pre-transplant but it is absent post-transplant/transduction. In summary, our results provide the first in depth look at the microRNA profiles of HIV-1 infected cells in the presence of a protective gene therapy vector.

266. Decade-Long Persistence of Adoptively Transferred Autologous Redirected CD4 ζ Chimeric Receptor T Cells in HIV+ Study Subjects

John Scholler,¹ Naomi Aaronson,² Gabriela Plesa,¹ Richard Carroll,¹ Gwendolyn Binder,¹ Kristen Hege,³ Steven Deeks,⁴ Ronald Mitsuyasu,⁵ Ashley Vogel,¹ Zhaohui Zheng,¹ Julio Cotte,¹ Wendy Bernstein,⁶ Troy Brady,¹ Bruce Levine,¹ Carl June.¹

¹University of Pennsylvania, Philadelphia, PA; ²Walter Reed Army Medical Center, Washington, DC; ³Cell Genesys, South San Francisco; ⁴University of California, San Francisco; ⁵University of California, Los Angeles; ⁶National Cancer Institute, Bethesda.

The ability of adoptively transferred T cells to persist long term and function in a homologous or enhanced fashion is a central goal of immunotherapy. To test the hypothesis that genetically modified T cells can have long term persistence, we measured the frequency of CD4 ζ modified T cells in patients with HIV in three trials following adoptive transfer of CD4 and CD8 T cells transduced with the CD4 ζ chimeric receptor over time. We developed a quantitative PCR (qPCR) assay to measure the persistence of adoptively transferred T lymphocytes transduced with a chimeric receptor consisting of

extracellular CD4 linked to intracellular CD3- ζ ("CD4 ζ " chimeric receptor). PBMC's from a series of clinical trials in which HIV+ study subjects received autologous CD4 ζ gene modified T cells from up to 11 years post-infusion were available for this long term persistence analysis. The data from three clinical trials demonstrated that 37 of 39 subjects continue to have CD4 ζ modified cells detectable in PBMC, up to 11 years post infusion. While the majority of patients had an average CD4z copy level in their PBMC populations of 0.01 to 0.1%, a considerable proportion had levels exceeding 0.1% PBMC (i.e. ~0.5% CD4 cells) and at relatively stable engraftment levels over time. The calculated half-life for the persistence of these cells in the three studies ranged from 13.8 to 28 years. RT-PCR analysis of RNA isolated from viably frozen cells representing 13 patients at 5 to 10 years post infusion, indicates that the CD4z gene is transcriptionally active throughout the period of CD4z gDNA detection. To determine the polyclonality in these long term persistent populations, 3 to 5 samples selected from five patients showing unique engraftment profiles between the 1st to the 10th anniversary after infusion were deep sequenced for integration site diversity. There are no clinical indications of delayed adverse events relating to the gene therapy in any of the patients. The data suggests that adoptively transferred retrovirally-modified T cells can have long term survival at levels equivalent to or exceeding levels of central memory T cells for at least 10 years.

267. Development of a New Strategy for X-CGD Gene Therapy Using a miRNA Regulated Lentiviral Vector

Maria Chiriaco,¹ Giada Farinelli,¹ Bernhard Gentner,² Gigliola Di Matteo,¹ Valentina Capo,¹ Silvia Di Cesare,¹ Samantha Scaramuzza,² Lucia Sergi Sergi,² Antonella Isgro,³ Didier Trono,⁴ Manuel Grez,⁵ Andrea Finocchi,¹ Paolo Rossi,¹ Luigi Naldini,^{2,6} Alessandro Aiuti.^{1,2}

¹Dep. of Pediatrics, Children's Hospital Bambino Gesù and Univ. of Rome Tor Vergata, Rome, Italy; ²San Raffaele Telethon Institute for Gene Therapy (HSR-TIGET), Scientific Institute HS Raffaele, Milan, Italy; ³Mediterranean Inst. of Hematology, Policlinico Tor Vergata, Rome, Italy; ⁴École Polytechnique Fédérale de Lausanne, Lausanne, Switzerland; ⁵Georg-Speyer Research Institute, Frankfurt, Germany; ⁶"Vita-Salute" S.Raffaele University, Milan, Italy.

Chronic Granulomatous Disease (CGD) is caused by defective NADPH oxidase function in patients' phagocytes leading to increased susceptibility to fungal and bacterial infections. Gene therapy with hematopoietic stem cells (HSC) may represent a valid alternative for gp91phox deficient patients (X-CGD). Previous clinical trials with gamma-retroviral vectors have achieved short-term benefit, which was hampered by low engraftment levels of gene modified cells, transgene silencing, and the occurrence of clonal dominance. Our goal was to develop a novel gene transfer approach into HSC for safe and efficacious therapy of X-CGD based on third generation SIN lentiviral vectors (LVVs) encoding gp91phox driven by an internal cellular promoter (LVV-PGK.gp91). To reduce the potential risk of ectopic gp91phox expression in HSC, we introduced miR-126 target sequences (miR-126T) into the gp91phox expression cassette (LVV-PGKgp91_126T) to obtain post-transcriptional downregulation of transgene expression by miR-126 which is found to high levels in HSC and early progenitors but not in the myeloid progeny. Transduced myeloid (PLB985) and EBV-B cell lines defective for gp91phox showed effective gp91phox expression and restoration of a functional NADPH oxidase complex. After superinfection with a miR-126 expressing LVV, LVV-PGKgp91_126T-transduced gp91phox-deficient cells showed dramatically reduced gp91phox expression compared to LVV-PGKgp91-transduced cells, indicating specific regulation of gp91phox expression by miR-126. Transduction

of Lin-negative cells from X-CGD mice resulted in restoration of gp91 transgene expression and NADPH activity after differentiation. We next investigated the effect of miR-126 mediated post-transcriptional regulation in healthy donor CD34+ cells. After short-term culture, gp91phox was detected ectopically in cells expressing CD34+ which were transduced with the LVV.PGK.gp91. Gp91phox ectopic expression in CD34+ expression was substantially reduced when cells were transduced with the LVV-PGKgp91_126T or a LVV vector encoding gp91phox driven by a synthetic myeloid specific promoter, but was similar in CD34-negative cells. Moreover, gene transfer into human CD34+ cells from XCGD patients with both LVV-PGK-gp91 vectors resulted in expression of gp91phox in 30% of cells and restored NADPH activity after myeloid differentiation. In summary these results indicate that that SIN-LVVs containing internal, cellular promoters represent an efficient approach for X-CGD gene therapy, and miRNA regulation can overcome potentially harmful, ectopic transgene expression in HSC.

268. Correction of Mouse *Prkdc scid* Deficiency by ZFN-Driven Gene Repair

Hayder H. Abdul-Razak,¹ Céline Rocca,¹ Francisco Javier Molina Estévez,² Guillermo Güenechea,² Steven J. Howe,³ Chih Hao V. Gan,³ Alison Roberts,⁴ Michael C. Holmes,⁵ Philip D. Gregory,⁵ Adrian J. Thrasher,³ Juan A. Bueren,² Rafael J. Yáñez-Muñoz.¹
¹School of Biological Sciences, Royal Holloway-University of London, Egham, Surrey, United Kingdom; ²Division of Hematopoiesis and Gene Therapy, Centro de Investigaciones Energéticas, Medioambientales, y Tecnológicas (CIEMAT) and Centro de Investigación Biomédica en Red de Enfermedades Raras (CIBER-ER), Madrid, Spa; ³UCL Institute of Child Health, University College London, London, United Kingdom; ⁴Medical and Molecular Genetics, King's College London School of Medicine, London, United Kingdom; ⁵Sangamo BioSciences, Inc, Richmond, CA.

Recent reports have described successful correction of several diseases by *ex vivo* retroviral vector-mediated gene addition in hematopoietic stem cells (HSCs) followed by autologous transplantation. Unfortunately, in X-linked SCID (severe combined immunodeficiency), X-CGD (chronic granulomatous disease), WAS (Wiskott-Aldrich syndrome) and β -thalassemia the treatment has led to some insertional mutagenesis-related serious adverse events. For this reason and others, an improved way to treat both dominant and recessive genetic disorders would be to repair the mutant gene by homologous recombination-mediated gene targeting. To demonstrate therapeutic gene repair in a pre-clinical model of immunodeficiency we are developing an *ex vivo* system to correct the classical *scid* mouse, a model of human DNA-dependent protein kinase catalytic subunit (*PRKDC*) deficiency. We have obtained and optimised a zinc-finger nuclease (ZFN) targeting mouse *Prkdc* in the vicinity of the *scid* mutation, produced targeting constructs to correct the mutation, and incorporated ZFN genes and targeting constructs into integration-deficient lentiviral vectors (IDLVs). We have demonstrated specific ZFN activity in *scid* fibroblasts using the *Surveyor* assay, which detects modifications introduced at the target site upon repair by nonhomologous end-joining of the ZFN-induced DNA double strand break. Importantly, we have also demonstrated ZFN-mediated gene targeting of the *scid* mutation in fibroblasts through the incorporation of a diagnostic restriction site from the targeting construct into the targeted locus. We are currently conducting preliminary experiments of ZFN cutting and *Prkdc* gene correction in *scid* HSCs using optimised IDLV-mediated transduction.

269. Safety and Clonality Analyses for a New Vector for CGD Clinical Gene Therapy

Simone Scholz,¹ Margarita Diaz,² Stefan Stein,² Axel Schambach,³ Hanno Glimm,¹ Christof von Kalle,¹ Manuel Grez,² Manfred Schmidt.¹

¹*Translational Oncology, German Cancer Research Center and National Center for Tumor Diseases, Heidelberg, Germany;*

²*Institute for Biomedical Research, Georg-Speyer-Haus, Frankfurt, Germany;* ³*Experimental Hematology, Hannover Medical School, Hannover, Germany.*

Several (pre)clinical gene therapy trials have shown that integrating full-LTR driven gammaretroviral vectors can successfully be used to treat monogenetic diseases. However, with increasing efficiency of retroviral gene transfer severe side effects occurred. We have previously reported on a severe side effect in two patients enrolled in a clinical trial for the treatment of X-linked chronic granulomatous disease (X-CGD). Insertional activation of MDS1/EV11 mediated by the used SFFV vector has led to clonal expansion of gene marked myeloid progenitor cells, triggering the development of a myelodysplastic syndrome with monosomy 7. Therefore, a new self-inactivating (SIN) gammaretroviral vector with an optimized design (SINfes.gp91s) was developed aiming to decrease vector-host interactions and associated side effects (Manuel Grez, Georg-Speyer-Haus, Frankfurt). In the course of the preclinical testing we performed safety and clonality analyses in vitro and in vivo. Samples from mice transplanted with gene modified hematopoietic stem cells were analyzed by LAM- and LM-PCR and subsequent high-throughput integration site (IS) analysis in combination with deep sequencing (454/Roche). As a control, a full LTR SFFV-promoter driven vector (SF91eGFP) similar to the one used in the previous clinical trial was analyzed in parallel. We could detect a total of 1938 unique IS in SF91eGFP (n = 4) and 3516 in SINfes.gp91s mice (n = 5). In average, we retrieved 530 unique IS in SF91eGFP mice, showing a less polyclonal IS pattern than SINfes.gp91s transplanted mice (754 unique IS/mouse). Moreover, (pre)dominant clones were found more frequently in mice transplanted with the SF91eGFP vector than with SINfes.gp91s. While in SF91eGFP mice we could detect 13 IS in/near the EV11/MDS1 locus with relative sequence counts (SC) up to 31%, in SINfes.gp91s mice only 5 IS with relative SC $\leq 0,2\%$ were detectable in that locus. Overall, the SINfes.gp91s vector showed no obvious signs of vector-induced side effects.

Lung and Respiratory Disease Gene & Cell Therapy

270. Adeno-Associated Virus Transduction in the Ferret Airway

Ziyang Yan,^{1,2} Diana C. M. Lei-Butters,¹ Xingshen Sun,¹ Xiaoming Liu,^{1,2} Nicholas W. Keiser,¹ John Fisher,¹ Hongshu Sui,¹ John F. Engelhardt.^{1,2}

¹*Department of Anatomy and Cell Biology, The University of Iowa, Iowa City;* ²*Center for Gene Therapy, The University of Iowa, Iowa City.*

Cystic fibrosis (CF) is an inherent disease caused by a single gene defect of cystic fibrosis transmembrane conductance regulator (CFTR). Since lung disease is the most life-threatening pathology in CF, the airways are currently the primary target for therapy. Since CF mouse models do not contract spontaneous lung disease, we recently generated a CFTR-KO ferret. This model develops neonatal and adult lethal lung infections that closely mirror pathology seen in CF patients. In an effort to develop CF lung gene therapy approaches with rAAV in this model, we have screened rAAV serotypes for their ability to infect the ferret airways. Previous studies demonstrated that apical transduction of AAV1 in ferret primary polarized airway epithelia culture is more efficient than that of AAV2 and AAV5 vectors. Co-

administration with proteasome inhibitors doxorubicin and LLnL during the infection period dramatically enhanced the transduction for these AAV serotypes. To develop a lung-directed protocol for the ferret, we screened four AAV serotypes (AAV1, 2, 5, 6) for efficacy of gene transfer to the lungs of 14 day-old ferrets. Surprisingly, we found little gene transfer with any of these serotypes using an alkaline phosphatase reporter to allow for cellular localization. Application of 200 uM doxorubicin at the time of vector administration gave rise to the highest level of transduction with rAAV1 (with the majority of expression in the intra-lobar airways and alveolar regions of the lung and little expression in the trachea). These findings demonstrated that the tropism of various AAV serotypes tested to infect polarized tracheal ferret airway epithelia was substantially different than in vivo infection of more distal airways epithelia. To better determine the level of proteasome inhibitor augmentation of AAV1 infection in vivo, we infected 14 day-old ferrets by intratracheal instillation (n=4 for each group) with rAAV1-luciferase virus in 600ul saline or saline formulated with doxorubicin at the concentration of 7.4uM, 22uM, 67uM and 200uM. Luciferase reporter assays were performed 8 days after infection and demonstrated a >2000-fold induction by doxorubicin. We further compared the AAV1 and AAV2 transduction in newborn ferret pups (2 day old). Virus administration was performed by trans-tracheal injection. Each ferret was infected with 20ul virus solution containing 6×10^{10} AAV1-luciferase or AAV2-luciferase and proteasome inhibitors (2ug doxorubicin (175uM) and 3ug LLnL (400uM)). Reporter assays were performed on 4 days after infection (n=6 for both groups). Results demonstrated that the AAV1 transduction efficiencies were 7.4 fold higher in trachea and 11.2 fold higher in lung than that of AAV2. These studies suggest that the AAV1 is the best candidate AAV vector for ferret airway transduction.

271. The Airway Epithelium Differentiation State Affects Efficiency of siRNA Oligonucleotide Delivery

Sateesh Krishnamurthy,¹ Ashley Jacobi,² Scott D. Rose,² Mark A. Behlke,² Paul B. McCray, Jr.,^{1,3} Beverly L. Davidson.¹

¹*Internal Medicine, University of Iowa, Iowa City, IA;* ²*Integrated DNA Technologies, Coralville, IA;* ³*Pediatrics, University of Iowa, Iowa City, IA.*

The delivery of siRNA oligos to the surface epithelium of the airway offers the opportunity to manipulate host or pathogen gene expression for therapeutic or biologic purposes. However, well-differentiated epithelia present several barriers to the successful delivery of nucleic acid. Here we used primary pig airway epithelial cells grown at the air-liquid interface as a model for the delivery of dicer-substrate siRNA duplexes against pig IL-8 and HPRT. In well-differentiated epithelia (> 2 weeks in culture), the application of oligos to the apical (mucosal) surface using lipid reagents or several different cationic polymers yielded no knockdown. Furthermore, transduction of siRNA with a peptide-delivery vehicle (PTD-DRBD) or transfection with siRNA coupled to a ligand failed to knockdown the target. Neither increasing oligo dosages, the oligo residence time, or enhancing the permeability of epithelial junctions during transfection resulted in knockdown. In contrast, in poorly differentiated cells (1-4 days in culture), transfection or transduction of siRNA with any of the reagents resulted in approximately 30-70% knockdown of the target. We used DIG-labeled siRNA to follow the fate of the oligos under various experimental conditions. Using the PTD-DRBD formulation, we observed that internalization of the oligo was significantly reduced in well-differentiated cells compared to the poorly differentiated cells. These results indicate that airway epithelial cell differentiation is accompanied by the development of a significant barrier for oligo entry. An improved understanding of the differentiation process may yield insights that facilitate oligo delivery to well-differentiated airway epithelia.

272. Strain-Specific Differences in Pulmonary Gene Transfer Efficiency: Relevance for Toxicology Studies in Mice

Giannoulis Legakis,¹ Benjamin Causton,² Jie Zhu,¹ Nikki Newman,¹ Raymond Farley,¹ Cuixiang Meng,¹ Clare M. Lloyd,² Eric W. F. W. Alton,¹ Uta Griesenbach.¹

¹Department of Gene Therapy, Imperial College and the UK Cystic Fibrosis Gene Therapy Consortium, London, United Kingdom; ²Leukocyte Biology Section, NHLI, Imperial College, London, United Kingdom.

As part of our ongoing clinical trial programme aimed at assessing, if non-viral gene transfer improves lung disease severity in cystic fibrosis (CF) patients, the UK CF Gene Therapy Consortium is currently conducting toxicology studies to support a multi-dose non-viral gene therapy trial in CF subjects. As part of this work, preliminary experiments determined significantly lower (approximately one log) lung transfection efficiency in outbred ICR(CD-1) mice (commonly used for toxicology studies conducted by contract research organisations) compared to inbred Balb/C mice (commonly used for pre-clinical gene transfer experiments) following nebulisation with pCIKLuc (regulated by a CMV promoter/enhancer). Here, we reproduced and confirmed these initial findings. We next extended these showing that strain-specific differences were maintained when using other non-viral vectors such as PEI, plasmids regulated by eukaryotic promoters or when transfecting the mouse nasal epithelium, which is a good model for human airways. To understand these strain specific-differences we first compared inflammatory responses after bolus administration of GL67A/pCIKLux complexes to the mouse lung by nasal sniffing. As previously reported nasal sniffing of GL67A/pDNA caused lung inflammation, but on histological assessment 24 hr after transfection there were no differences between the two strains. The pro-inflammatory chemokines KC and MIP1a were significantly ($p < 0.05$) increased in broncho-alveolar lavage fluid of both strains 6 and 24 hrs after gene transfer. Interestingly, levels of both cytokines were significantly higher in Balb/C compared to CD-1 mice at both time-points (KC (pg/ml) shown as example, Balb/C 6 hr: 896 ± 438 , CD1 6 hr: 438 ± 67 , Balb/C 24 hr: 644 ± 97 , CD1 24 hr: 255 ± 33 , $n = 16$ /group). It is currently unclear if and how differences in cytokine expression relate to differences in transfection efficiency and additional studies have to be performed. We next compared gene expression in CD1/Balb/C F1 hybrids to the parental strains. Interestingly, the F1 hybrids had intermediate levels of gene expression and were significantly different from both parental strains. In conclusion, the mouse strain affects transfection efficiency. In the short-term, these underline the importance of careful selection of suitable mouse strains before embarking on toxicology studies and has led us to perform our toxicology study in Balb/C mice rather than CD1 mice. In the longer-term, understanding the reasons for these differences may inform key factors involved in airway gene transfer and may be informative for improving gene transfer in man.

273. Reporter Gene Expression Following Repeat Administration of a HIV-1 Lentiviral Vector in Mouse Airways

Patricia L. Cmielewski,^{1,3} Don S. Anson,^{2,4} David W. Parsons.^{1,3,4,5}
¹Respiratory and Sleep Medicine, Women's and Children's Hospital, Adelaide, South Australia, Australia; ²Gene Technology Unit, Women's and Children's Hospital, Adelaide, South Australia, Australia; ³School of Paediatrics and Reproductive Health, University of Adelaide, Adelaide, South Australia, Australia; ⁴Centre for Stem Cell Research, University of Adelaide, Adelaide, South Australia, Australia; ⁵Women's and Children's Health Research Institute, Adelaide, South Australia, Australia.

Introduction: Repeat dosing may be necessary to ensure long term correction for cystic fibrosis airway disease. Using luciferase (Luc) bioluminescence imaging, we have examined *in-vivo* the persistence of gene expression in individual animals over time to determine if repeat dosing with a VSV-G pseudotyped lentiviral (LV) gene vector maintained gene expression in airways of normal mice. **Methods:** Three groups of mice ($n = 8$ /group) received a single VSV-G pseudotyped LV gene vector delivered intra-nasally (4 μ l of lysophosphatidylcholine (LPC, 0.3%) followed 1 hour later by a 20 μ l bolus of the LV-Luc gene vector). Four weeks later 1 group of mice was re-dosed with a different reporter-gene (LPC/LV-LacZ), while another group was re-dosed with the same LPC/LV-Luc gene. Luc bioluminescence was measured 1, 4, 5, 8 and 12 weeks later (IVIS, Xenogen) 10 mins after intranasally delivered substrate D-luciferin (50 μ l, 15mg/ml). **Results:** Nasal bioluminescence was the same across all 3 groups at 1-5 weeks post initial LV instillation (n.s., ANOVA). Those mice that received a different transgene at re-dose (i.e. LPC/LV-LacZ) displayed similar gene expression compared to the single dose group at both later time points. However at 8 and 12 weeks after the 2nd dose, mice that received two doses of LPC/LV-Luc showed significantly less gene expression compared those given a single dose of LPC/LV-Luc ($p < 0.001$, ANOVA). **Conclusions:** These results indicate that re-administration of the same LV vector transgene can reduce subsequent gene expression. This effect is likely to be due to a cell-mediated immune response directed against the specific transgene.

274. Gene Transfer by Influenza HA Pseudotyped EIAV Lentiviral Vectors to the Airways of Neonatal Mice

Manij Patel,¹ John C. Olsen.¹

¹Cystic Fibrosis/Pulmonary Research and Treatment Center, University of North Carolina, Chapel Hill, NC.

CF lung disease starts early in childhood and so phenotypic correction at the beginning of life could be a very desirable option for early treatment or amelioration of early onset lung disease. We have been investigating the use of influenza hemagglutinin (HA) pseudotyped lentiviral vectors to transfer genes to the airway epithelium of mice. Previously, we reported that nasal inhalation of EIAV vectors pseudotyped with influenza HA resulted in high levels of gene transfer to nasal, tracheal, and lung epithelial cells of adult mice. To determine if these vectors would be suitable for transferring genes to newborn mice, we intra-nasally administered HA pseudotyped EIAV vectors to mouse pups 24 to 48 hours after birth. For these studies, we used vectors encoding luciferase, lacZ, or dual luciferase-lacZ expression cassettes. Bioluminescence in the noses and lungs of the pups from luciferase expression could be detected within 48 hour of vector administration. Measurement over a 10-day period in the nose and ultimately luciferase activity in lung homogenates showed that gene transfer was dose dependent. In other studies, pups were dosed with 6, 12, or 18 microliters of concentrated (2E8 IU/ml) vectors encoding lacZ. Histochemical analysis revealed,

similar to adult animals, that all airway compartments including nose, trachea, and lungs were positive for lacZ expression. At the higher dose, significant expression of lacZ was observed in all the major airways of the lungs. Morphometric analysis of left-lobe lung sections revealed that there were 0.1, 0.3, and 0.5 lacZ expressing cells/micron, with respect to the three doses. From these studies, we conclude that HA-pseudotyped EIAV vectors are suitable for studying lentiviral gene transfer to neonatal animals. Because newborn mice have an immature immune system, further studies are underway to characterize the status of the immune response towards the vector and expression of the transgene.

275. Generation of Inducible CFTR-Expressing Lentiviral Vectors for Gene Therapy

Xiaoming Liu,¹ Meihui Luo,¹ Yulong Zhang,¹ John F. Engelhardt,¹
¹Department of Anatomy and Cell Biology, Gene Therapy Center, University of Iowa, Iowa City, IA.

For prolonged gene therapies of cystic fibrosis to be successful, it would be optimal to target stem/progenitor cells of the airway capable self-renewal and proliferation following airway transduction. Using a human bronchial xenograft model, we have assessed the extent of lentiviral-mediated transduction of airway stem/progenitor cells using CFTR or LacZ transgene expression vectors. The preliminary results from this model suggested that ectopic expression of CFTR imposes a selective disadvantage to human airway stem/progenitor cell proliferation and/or capacity for differentiation in actively regenerating airways. This finding suggests that reconstitution of CFTR in airway stem cells may require regulated expression. To test this hypothesis, we have generated an inducible lentiviral vector that overexpresses inducible CFTR and a constitutively active alkaline phosphatase (AP) reporter gene that can be used for clonal analysis of stem/progenitor cells in xenografted airways. This system is based on the Tet/On Advanced® inducible gene expression system, whereby gene expression is induced in response to doxycycline. Three lentiviral vectors have been generated and packaged into VSV-G pseudotyped capsids: 1) LentiTetR/Bgal is a lentiviral vector that expresses the Tet-controlled reverse transcriptase protein and a constitutive RSV promoter-driven β -galactosidase reporter; 2) LentiTightCFTR/AP is a vector that expresses TRE-tight controlled CFTR that has a 3xHA tag in the ECL4 domain, and a constitutive RSV promoter-derived AP reporter gene; 3) LentiTightAP/BSD is a vector that expresses a TRE-tight controlled AP reporter gene and a constitutive RSV promoter derived blasticidin (BSD)-resistance gene. The titers of the concentrated lentiviral vectors were all above $\sim 10^7$ CFU/ml as determined by infection of HT1080 cells followed by CFU detection of reporter-gene expression (LacZ, AP, BSD). We tested the inducibility of these vectors following co-infection of 293T cells and CuFi cells with LentiTetR/Bgal and either LentiTightCFTR/AP or LentiTightAP/BSD vectors. In the presence of 1.0 mM of Doxycycline, CFTR protein and mRNA was only detected cells co-infected with LentiTetR/Bgal and LentiTightCFTR/AP vectors using in vitro phosphorylation assays and Northern Blot. The induction of AP reporter was also confirmed in the cells co-infected with LentiTetR/Bgal and LentiTightAP/BSD vectors using AP histochemical staining. No detectable expression of CFTR or AP reporter was observed in the absence of Doxycycline. Quantitative RT-PCR analysis of the CFTR-ECL4-HA transgene demonstrated that a 25-fold and 120-fold increasing of CFTR expression in the presence of Doxycycline over that in the absence of Doxycycline, in the CuFi cells and 293T cells, respectively. These results suggest that this inducible CFTR-expressing vector may be a useful tool to investigate the deleterious effects of ectopic CFTR expression in airway stem/progenitor cells.

276. The Therapeutic Role of TSLP shRNA in Treating Pulmonary Fibrosis

Guo-Zheng Liu,¹ Tsung-Jen Hung,² Su-Fen Liu,³ Tao-Chen Lee,⁴ Zih-Han Yang,¹ Lea-Yea Chuang,⁵ Jinn-Yuh Guh,³ Tung-Nan Liao,⁶ Min-Yuan Hung,⁶ Yu-Lin Yang.^{1,6}

¹Graduate Institute of Biomedical Science, Chung Hwa University of Medical Technology, Tainan, Taiwan; ²Department of Health, Executive Yuan, Chest Hospital, Tainan, Taiwan; ³Department of Internal Medicine, Kaohsiung Medical University, Kaohsiung, Taiwan; ⁴Department of Neurosurgery, Kaohsiung Chang Gung Memorial Hospital, Kaohsiung, Taiwan; ⁵Department of Biochemistry, Kaohsiung Medical University, Kaohsiung, Taiwan; ⁶Department of Medical Technology, Chung Hwa University of Medical Technology, Tainan, Taiwan.

RNA interference (RNAi)-based gene silencing is widely used in laboratories for gene function studies and also holds a great promise for developing treatments for diseases. The cytokine thymic stromal lymphopoietin (TSLP) has been linked to human allergic inflammatory diseases; however the mechanism underlying pulmonary fibrosis remains unclear. In this study, effects of TSLP shRNA on Transforming growth factor- β 1 (TGF- β 1) and its downstream fibrogenic signal proteins were investigated in vitro. we show that exogenous TGF- β 1 dose-dependently (0.1 to 10 ng/ml) increased the level of fibronectin in HFL-1.

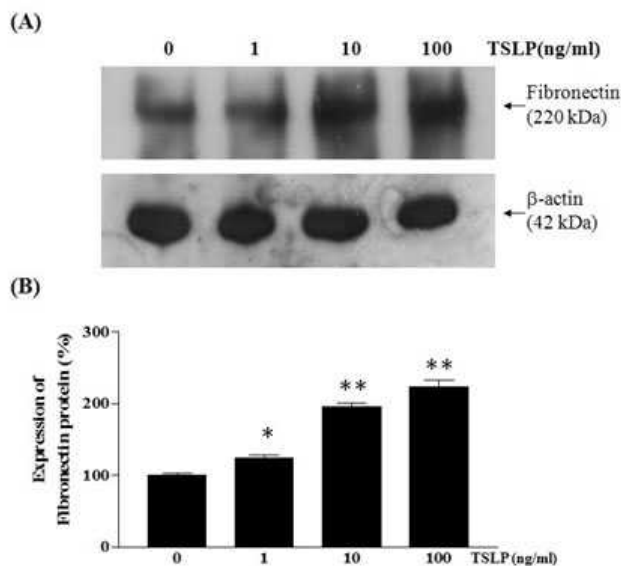

Similarly, we found exogenous TSLP dose- (1 ng/ml to 100 ng/ml) and time- (0 to 24 hr) dependently increased the level of fibronectin in HFL-1 ($P < 0.05$). In addition, the fibrosis signaling (i.e. pSmad2/3 and Smad4) was significantly induced by TSLP. Intriguingly, TSLP shRNA dramatically reversed TGF- β 1-induced cellular fibrosis.

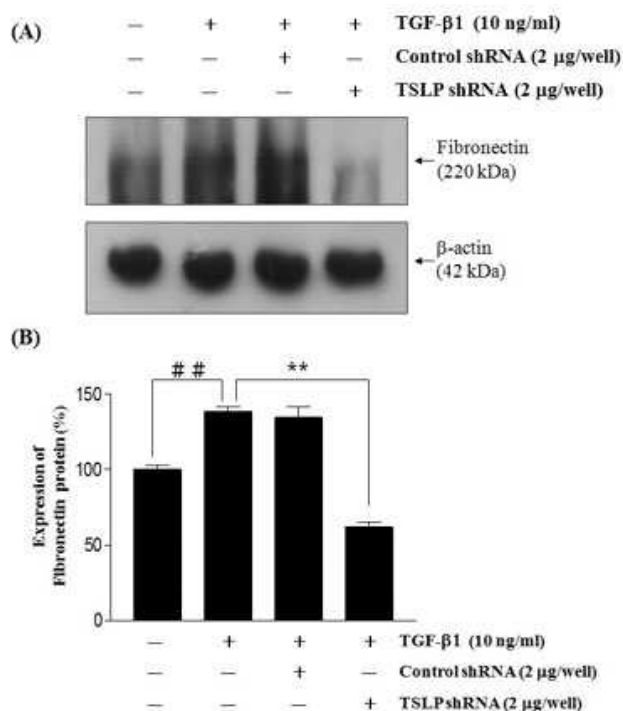

The above effect was concomitantly with the suppressing of the level of TGF- β RI and phosphorylated Smad2/3. Collectively, these findings suggest that TSLP plays a pivotal role on pulmonary cellular fibrosis. Moreover, TSLP shRNA might act as a novel pulmonary fibrosis antagonist by down-regulating TGF- β RI and pSmad2/3 in vitro, respectively.

277. Efficient Transduction of Alveolar Type II Epithelial Cells in Nonhuman Primates by Helper-Dependent Adenovirus 5-Fiber 35 Chimeric Vectors

Amanda Rosewell,¹ Peter Hiatt,² Ruth McConnell,² Dianne Dang,¹ Francesco Vetrini,¹ Nathan Grove,¹ Donna Palmer,¹ Milton Finegold,³ Arthur Beaudet,¹ Philip Ng.¹

¹Molecular and Human Genetics, Baylor College of Medicine, Houston, TX; ²Pulmonary Pediatrics, Baylor College of Medicine, Houston, TX; ³Pathology, Baylor College of Medicine, Houston, TX.

Cystic Fibrosis (CF) is the most common autosomal recessive disease affecting the Caucasian population and is associated with a high mortality rate. There is no cure for CF which is caused by mutations in the cystic fibrosis conductance regulator (CFTR) gene. Adenovirus serotype (Ad5) vectors have been used extensively for CF gene therapy but without success because of inefficient transduction of the airway epithelium due to the absence of the virus receptor, CAR, on the apical cell surface. It has been reported that Ad5F35, a chimeric Ad5 vector containing the Ad serotype 35 fiber, can mediate a 10-fold improvement in transduction of primary human airway epithelia via the apical cell surface in vitro compared to Ad5 presumably due to the apical location of its CD46 receptor. Additionally, a variant, Ad5F35++, bearing two mutations (Asp207Gly, Thr245Ala) in the Ad35 fiber has been shown to increase the vector's affinity for CD46 60-fold. Thus, we have produced two helper-dependent adenoviral vectors, HDAd5F35LacZ and HDAd5F35++LacZ, and tested them for apical transduction in the NuLi-1 (normal human bronchial epithelia) cell culture system. Contrary to the published report, our results suggest that their apical transduction efficiencies were comparable to HDAd5. Intrapulmonary aerosolization of HDAd5F35,

HDAd5F35++, or HDAd5 into nonhuman primates resulted in only modest transduction of the respiratory airway epithelium. Surprisingly, extensive transduction of type II alveolar epithelial cells was observed for HDAd5F35 (Fig) and HDAd5F35++, but not HDAd5. Thus, while these vectors may not be ideal for CF gene therapy, they may be very useful for gene therapies where the target cells are alveolar type II cells, such as surfactant deficiencies.

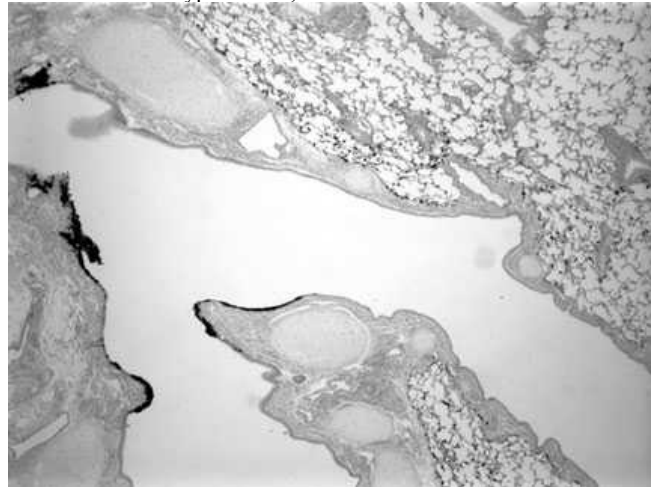

278. Delivery Dynamics and Destination of Gene Vector Instillations in Live Mouse Airways

Martin W. Donnelly,^{1,2,3} Karen K. W. Siu,^{4,5} R. Aidan Jamison,⁶ David W. Parsons.^{1,2,3,7}

¹Respiratory and Sleep Medicine, Women's and Children's Hospital, North Adelaide, South Australia, Australia; ²School of Paediatrics & Reproductive Health, University of Adelaide, Adelaide, South Australia, Australia; ³Centre for Stem Cell Research, University of Adelaide, Adelaide, South Australia, Australia; ⁴School of Physics, Monash University, Clayton, Victoria, Australia; ⁵Centre for Synchrotron Science, Monash University, Clayton, Victoria, Australia; ⁶Division of Biological Engineering, Monash University, Clayton, Victoria, Australia; ⁷Women's & Children's Health Research Institute, North Adelaide, South Australia, Australia.

Introduction: Much respiratory research using mouse models relies on bolus fluid doses into the nasal and lung airways, however the immediate fate of delivered agents is poorly understood. Our cystic fibrosis gene-therapy studies use bolus delivery of an airway pre-treatment followed by a lentiviral-vector. Despite using standardised delivery techniques we and others observe substantial variability in the amount and location of gene-transfer. Aim: The aim of this experiment was to determine the regional distribution of fluid doses delivered into live mouse nasal and lung airways using synchrotron phase contrast X-ray imaging. Methods: Imaging of barbiturate-anaesthetised mice was performed on the BL20B2 beamline at the SPring-8 synchrotron in Japan. In six mice a 4 μ l sample of iodine-based contrast fluid (a surrogate for our 4 μ l gene-transfer airway pre-treatment) was delivered to the right nostril over 10 seconds, with images captured at 1 Hz. Ten minutes later an additional bolus of 20 μ l (a surrogate for gene-vector) was delivered over 30 seconds. For the lung studies 4 mice were intubated and ventilated at 80 br/min with 1 image captured per breath. A 15 μ l sample of iodine-based contrast fluid (airway pre-treatment or gene-vector surrogate) was delivered over 30 seconds via a thin cannula extending from the ET tube. Twenty minutes later another 15 μ l bolus was delivered over 3.6 seconds to test the effect of delivery speed. Background subtraction techniques were used to reveal fluid motion. Results: Contrast fluid was well tolerated. In the nasal airways the same delivery protocol resulted

in different dose dynamics and distributions. Though optimised for nasal gene transfer, the complete nasal delivery transported fluid into the trachea. Incomplete dosing (e.g. by droplet retention at the cannula tip) substantially reduced the distribution of dose fluid. In the lung, substantial dose losses occurred in some mice via immediate retrograde fluid loss via the ET tube. Faster bolus delivery into the lung increased the targeting of conducting airways and deep lung. Conclusions: Synchrotron imaging produced unambiguous visualisation of the complexity of dose delivery in nasal and lung airways, providing the opportunity to match dose distributions to outcomes from gene-transfer protocols. Our findings suggest the need for careful consideration of the specifics of the dosing protocol (e.g. animal orientation, dose volume and dosing speed) in mouse airway gene therapy development studies, and should enable improvements in airway gene transfer reliability.

279. Lung Epithelial Binding Peptide-Linked High Mobility Group Box-1 A Box as a Lung Epithelial Cell Targeting Gene Carrier

Hyun Ah Kim,¹ Su Hee Cho,¹ Ji Hwan Park,¹ Minhyung Lee.^{1,2}

¹Department of Bioengineering, College of Engineering, Hanyang University, Seoul, Republic of Korea; ²Institute for Bioengineering and Biopharmaceutical Research, Seoul, Republic of Korea.

High mobility group box 1(HMGB1) is an abundant nuclear protein. Recently, HMGB1 was identified as a pro-inflammatory cytokine, which is involved in sepsis, rheumatoid arthritis and acute lung injury. High mobility group box 1 A box (HMGB1A) is an antagonist to HMGB1, which reduces inflammation by HMGB1. In addition, HMGB1A has high positive charges due to lysine and arginine contents and was also evaluated as a DNA delivery carrier into cells. Lung epithelial-specific gene delivery is required for the gene therapy of various lung diseases such as acute lung injury. In this study, a lung epithelial-specific DNA carrier was produced by linking the lung epithelial binding peptide (LEBP) to HMGB1A. LEBP, which was composed of 15 amino acids, NH₂-RNVPPIFNDVUWIAF-COOH. LEBP-linked HMGB1A (LEBP-HMGB1A) was expressed in *Escherichia coli* BL21 by recombinant DNA technology. The purification steps for LEBP-HMGB1A were optimized and the purified LEBP-HMGB1A was evaluated as a gene carrier in lung epithelial cells. In a gel retardation assay, LEBP-HMGB1A completely retarded DNA at a 5:1 weight ratio (peptide:DNA). DNase I protection assay showed that LEBP-HMGB1A protected DNA from degradation by DNase I. LEBP-HMGB1A/pDNA complexes were prepared at various weight ratios, to which a fixed amount of polyethylenimine (2 kDa, PEI2k) was added to increase the proton buffering effect of the complex. Transfection assays were performed to evaluate the DNA delivery efficiency of LEBP-HMGB1A. In the results, LEBP-HMGB1A had the highest transfection efficiency to L2 lung epithelial cells at a 20:1 weight ratio (peptide:DNA). At this ratio, LEBP-HMGB1A had higher transfection efficiency than poly-L-lysine (PLL) as well as HMGB1A without LEBP. To evaluate the toxicity of free LEBP-HMGB1A, MTT assay was performed. Various amounts of LEBP-HMGB1A without DNA were added to the L2 cells for 24 hrs. PLL was used as a control. The results showed that LEBP-HMGB1A was not toxic to L2 cells. In addition, the toxicity of the LEBP-HMGB1A/PEI2k/DNA complex was also measured by MTT assay and compared with those of the HMGB1A/PEI2k/DNA and PLL/DNA complexes. The MTT assay showed that HMGB1A/PEI2k/DNA and LEBP-HMGB1A/PEI2k/DNA complexes were not toxic to L2 cells compared with PLL. The results suggest that LEBP-HMGB1A may be useful in developing gene therapies for lung diseases.

280. Development of a Nonviral Gene Therapy Approach for Surfactant Protein B Deficiency

Rebecca C. Barnett,¹ David A. Dean.¹

¹Department of Pediatrics, Division of Neonatology, University of Rochester, Rochester, NY.

Surfactant Protein B (SPB) Deficiency is a rare but lethal disease of the neonate caused by an autosomal recessive mutation on chromosome 2 in codon 121. Conventional treatment and exogenous surfactant replacement is ineffective, leaving only lung transplantation and Extracorporeal Membrane Oxygenation (ECMO) as a bridge to transplantation as available treatments. Since this is a monogenetic disorder, it could lend itself well to development of gene therapy treatments. To date, only one gene therapy study using adenoviral vectors in mice has been reported. However this gave only low level mRNA production and did not evaluate SPB protein expression and activity. Due to potential problems associated with viral gene therapy, we wanted to develop a nonviral approach for this disease. Our lab has shown gene delivery via electroporation can be effective in gene delivery and expression in the lung tissues without any adverse effects in both small and large animals. We hypothesize that electroporation may be an effective method to deliver plasmid DNA (pDNA) containing the gene for human SPB protein to lung tissue, thus restoring correct SPB production, surfactant processing and lung function. To test this we cloned, amplified and sequenced pDNA expressing the human SPB protein into three different vectors. The first vector is the cytomegalovirus (CMV) promoter vector which has been shown to give high level and short duration gene expression. The second vector is the human ubiquitin C promoter which gives about 50% gene expression compared to the CMV promoter but has longer duration of expression. The third vector is the human SPC Promoter which is cell-specific to airway epithelial type II (ATII) cells. We are currently delivering these plasmids to both wild type mice and compound tetracycline-inducible transgenic SPB null mice. Since SPB null mice show embryonic lethality, these transgenic mice are null for the endogenous SPB gene but carry an extra tet-inducible copy that is turned on during gestation to allow for development and birth and can be turned off to assess gene therapy-mediated replacement strategies. We will harvest the lungs and SPB expression will be measured by mRNA isolation, RTPCR, and immunoblot. Survival in these compound SPB null mice will also be evaluated in another set of experiments by removing the tetracycline from their food/water supply then immediately performing gene transfer. These findings will help further the role of gene therapy in SPB Deficiency and may open up future treatment options for other genetic pulmonary diseases as well.

281. One Year Persistence from a Single HIV-1 Lentiviral Vector Delivery into Marmoset Lung: LacZ and Vector Gene Presence

David W. Parsons,^{1,3,4,5} Nigel Farrow,^{1,3,4} Darren Miller,⁵ Shannon Le Blanc,¹ Richard Bright,¹ Don S. Anson.²

¹Respiratory & Sleep Medicine, Womens and Childrens Hospital, Nth Adelaide, South Australia, Australia; ²Gene Technology Unit, SA Pathology, Adelaide, South Australia, Australia; ³Paediatrics, University of Adelaide, Adelaide, South Australia, Australia; ⁴Center for Stem Cell Research, University of Adelaide, Adelaide, South Australia, Australia; ⁵Womens and Childrens Health Research Institute, Nth Adelaide, South Australia, Australia.

Introduction: The focus of our work is to develop an effective cystic fibrosis airway gene therapy, able to produce long term transgene expression. In the lungs of the marmoset, a non-human primate, short-term (7 day) airway gene transfer can be achieved using a VSV-G pseudotyped HIV-1 based lentiviral (LV) LacZ vector. We asked whether the same dosing protocol could produce gene expression that

would extend for at least a year. Methods: Two 1 year old marmosets (1F, 1M) were anaesthetized (Isoflurane), intubated and dosed with 350ul of lysophosphatidylcholine (LPC, 0.1%) delivered via a cannula inserted to extend from the ET tube into the distal third of the trachea. One hour after LPC delivery, a 500ul or 550ul bolus (respectively) of LV-LacZ vector was similarly introduced. Animals received normal care over the following 14 months with regular blood, waste and secretion samples taken. After humane killing (Nembutal) lungs and other tissues were removed for assessment: lung LacZ expression via Xgal; LacZ and vector GAG genes via RT-PCR in 18 samples taken from each lung. Studies were approved under the NH&MRC Animal Ethics Code of Practice. Results: After processing LacZ staining was not observed, possibly due to excessive fixation following an unexpected delay in lung shipment. However, compared to untreated lung tissue both marmoset lungs displayed LacZ and HIV-1 vector GAG gene presence (3/18 and 7/18 samples) primarily from upper lung regions. Positive controls derived from our earlier 7-day study where clear LacZ staining was present showed a similar index (Ct) of LacZ and GAG gene presence. Conclusions: A single LV vector airway administration can introduce transgene and vector structural gene components into a primate lung that persist for more than a year. Analyses are continuing, to demonstrate LacZ protein expression and to document relevant findings in secretions, organs and blood.

282. E1B-55kDa Deleted Adenoviruses Induce p53 Up-Regulation Resulting in Apoptosis in Human Malignant Mesothelioma

Yuji Tada,¹ Makako Yamanaka,¹ Kiyoko Kawamura,² Shinya Okamoto,³ Shan Yang,² Atsushi Kitamura,¹ Suguru Yamauchi,² Liang Min,⁶ Hiroshi Kobayashi,³ Yuichi Takiguchi,¹ Koichiro Tatsumi,¹ Hideaki Shimada,⁴ Kenzo Hiroshima,⁵ Masatoshi Tagawa.²

¹Department of Respiratory, Respiratory Graduate School of Medicine, Chiba University, Chiba, Japan; ²Division of Pathology and Cell Therapy, Chiba Cancer Center Research Institute, Chiba, Japan; ³Department of Biochemistry, Graduate School of Pharmaceutical Science, Chiba University, Chiba, Japan; ⁴Department of Surgery, School of Medicine, Toho University, Tokyo, Japan; ⁵Department of Pathology, Tokyo Women's Medical University Yachiyo Medical Center, Chiba, Japan; ⁶TOT Shanghai RD Center, Shanghai, China.

The mechanism of Ad-delE1B55-mediated anti-tumor effects remains poorly understood but, although empirically, showed the elevated cytotoxicity to various type of tumors cells. We examined the possible cytotoxicity to malignant mesothelioma cells, most of which possess the wild-type p53 gene but lack p14/p16 genes which result in inactivation of p53. Ad-delE1B55 inhibited proliferation of mesothelioma cell lines with the wild-type p53 gene and the suppressed growth levels in respective cells were in part correlated with the Ad infectivity. Ad-delE1B55 up-regulated p53 protein expression and induced the phosphorylation, and dephosphorylation of pRB in the infected cells. Expression levels of p21 and p27 were down-regulated and caspase-3, -8 and -9 were activated although BAX, NOXA and PUMA expressions were not modulated. Combination of Ad-delE1B55 with cisplatin synergically produced anti-tumor effect both *in vitro* and *in vivo*. These data suggest that Ad-delE1B55 is a possible therapeutic agent for malignant pleural mesothelioma.

Immunologic & Host Responses in Gene & Cell Therapy

283. dAd5GNE300, a 2nd Generation Anti-Cocaine Adenovirus-Based Vaccine That Blocks Cocaine-Induced Activity, Reward and Drug Seeking in Rodents

Jonathan B. Rosenberg,¹ Sunmee Wee,² Martin L. Hicks,¹ Bishnu P. De,¹ Stephen M. Kaminsky,¹ Amira Y. Moreno,² Kim Janda,² George Koob,² Ronald G. Crystal.¹
¹Weill Cornell Medical College, New York, NY; ²The Scripps Research Institute, La Jolla, CA.

We have previously demonstrated that a vaccine comprised of a disrupted Ad conjugated to GNC, a cocaine analog, generated a high-titered antibody response and reduced cocaine-induced behavior in mice. The present study focuses on a 2nd generation cocaine analog termed GNE. GNE was coupled to a disrupted serotype 5 Ad vector coding for β -galactosidase to create dAd5GNE300. The response to the vaccine in both mice and rats was striking, with marked reduction of cocaine-induced behaviors. In Balb/c mice vaccinated with dAd5GNE300 (n=10), the titers remained constantly high ($>5 \times 10^5$) over 3 months. Testing in open field infra-red beam chambers to track movement showed that vaccinated mice had complete blockade of hyperactivity in distance traveled and activity time, similar to that of non-treated mice, over multiple challenges at 25, 50 and 100 μ g of cocaine. When the dAd5GNE300 vaccine was tested in Wistar rats (n=8), long-term high titers of anti-cocaine antibodies were elicited ($>10^6$), leading to a significant reduction in hyperactivity in the rats challenged repeatedly with high levels of cocaine (15 mg/kg). Following sensitization of the rats to cocaine, there was a $60 \pm 13\%$ reduction compared to naive rats with the same cocaine dose after 3 wk ($p < 0.002$). The dAd5GNE300 vaccinated rats displayed complete reduction in cocaine-induced vertical hyperactivity for multiple challenges over 3 wk indistinguishable to that of naive rats injected with PBS ($p > 0.3$). Lastly, the dAd5GNE300 vaccine was tested in Wistar rats on a series of tests using intravenous cocaine self-administration (n=12). After vaccination, rats with indwelling intravenous catheters acquired cocaine (0.5 mg/kg per infusion) self-administration behavior when tested in operant chambers. Using a progressive ratio probe, where the rats are required to perform greater numbers of lever presses for each sequential cocaine reward, the vaccinated rats were significantly less likely to pursue additional effort for cocaine reward suggesting vaccine efficacy in blocking cocaine reward ($p < 0.006$). On the first day of extinction studies, when rats are deprived of cocaine and allowed to pursue lever presses that resulted in no cocaine reward, the vaccinated rats did not exhibit the extinction "burst" of activity as observed in the non-vaccinated control group ($p < 0.01$). Significant differences between vaccinated and controls persisted over 13 sessions ($p = 0.01$). Finally, in cocaine reinstatement studies, vaccinated rats failed to reinstate cocaine seeking following a prime injection (interaction value, $p = 0.05$). These data demonstrate that this 2nd generation anti-cocaine Ad vaccine effectively blocks the cocaine-induced behavior in animal models of the psychostimulant, reward efficacy and relapse effects of cocaine, supporting its development as a therapeutic option for cocaine-associated drug addiction.

284. Lmo2 Over-Expression and p19^{Arf} Loss Genetically Cooperate To Increase the Self-Renewal Capacity of Immature Thymocytes

Louise M. Treanor,¹ Sheng Zhou,¹ Taihe Lu,¹ Brian P. Sorrentino.¹
¹Hematology, St. Jude Children's Research Hospital, Memphis, TN.

Four patients in X-linked severe combined immunodeficiency (X-SCID) gene therapy trials developed T-cell leukemia associated

with vector-induced activation of LMO2. In three of these cases, the tumor suppressor genes in the *CDKN2A* locus were inactivated either by biallelic deletion or by a second activating vector insertion in the *BM11* gene, a known repressor of the *CDKN2A* locus. We reasoned that LMO2 activation could be collaborating with loss of the *Arf* tumor suppressor, encoded in the *CDKN2A* locus, in the transformation process. We developed a mouse model for these events by transducing both *Arf*^{-/-} and *Arf*^{+/-} mouse bone marrow progenitor cells or thymocytes with a MSCV vector that expressed Lmo2 or an analogous control vector that expressed only GFP. As previously reported at this meeting, the combination of *Arf* loss and Lmo2 overexpression in transplanted bone marrow cells significantly reduced the latency of T cell lymphomas over either event alone. To discern the mechanism of this interaction, either *Arf*^{+/-} or *Arf*^{-/-} thymocytes were directly transduced and then cultured on OP9-DL1 stromal cells. In both cases, developing thymocytes were blocked at the DN2 stage of thymocyte differentiation, indicating that *Arf* loss did not directly affect the Lmo2-induced differentiation block. The DN2 population was sorted from both the Lmo2+ *Arf*^{+/-} and the Lmo2+ *Arf*^{-/-} populations and replated on OP9-DL1 stromal cells. After 11 days post sorting the Lmo2+ *Arf*^{-/-} DN2 population had accumulated three fold more thymocytes than the Lmo2+ *Arf*^{+/-} population indicating that *Arf* loss may be increasing the self-renewal of the DN2 population. To directly test if *Arf* loss and Lmo2 over-expression could increase self-renewal in vivo, double negative thymocytes were transduced and cultured on OP9-DL1 cells for 20 days before being transplanted into recipient mice. Specifically, 2x10⁵ Lmo2+ *Arf*^{-/-} or 2x10⁵ Lmo2+ *Arf*^{+/-} DN2 thymocytes were cotransplanted with 2x10⁵ WT bone marrow cells into lethally irradiated syngenic recipients. Three weeks later, Lmo2+ *Arf*^{-/-} (n=7) cells were only detected in the thymi of recipient mice while no Lmo2+ *Arf*^{+/-} cells were detected in any recipients. By week 18 after transplant, the Lmo2+ *Arf*^{-/-} cells comprised up to 97% of total thymocytes while no thymic repopulation was noted in recipients receiving Lmo2+ *Arf*^{+/-} cells. Lmo2+ *Arf*^{-/-} thymocytes isolated from primary recipients were serially transplanted and led to thymic repopulation in secondary and tertiary recipients. These results indicate that the combination of increased Lmo2 expression and *Arf* loss may lead to the accumulation of a T-cell leukemia "stem cell" population with increased self-renewal. It is interesting to note that normal hematopoietic stem cells express relatively high levels of Lmo2 and have suppression of the *CDKN2A* locus, suggesting these events are conserved in conferring a self-renewal phenotype.

285. Sequential Gene Therapy with Augmentation of Expression Is Possible with Neonatal Gene Transfer

Chuhong Hu,¹ Eun K. Lee,¹ Gerald S. Lipshutz,¹
¹*Surgery, David Geffen School of Medicine, Los Angeles, CA.*

Correction of diseases during neonatal development offers potential advantages over postnatal gene transfer including the limitation or abrogation of pathologic consequences. In addition, neonatal immune immaturity may result in blunted immune responses to the transgene and may induce immune tolerance. However, in the developing liver where cellular proliferation is high, transgene expression from AAV falls rapidly despite efficient initial transduction; this correlates to a loss of episomal vector. As many diseases will require treatment early in life, we sought to determine the possibility of augmenting expression with subsequent postnatal injections of AAV in mice administered vector in the neonatal period and furthermore, examine the immune response to both vector and transgene-encoded proteins. **Methods:** 2-day-old mice were administered serotype rh10 AAV expressing luciferase. Expression was followed longitudinally by bioluminescent imaging and by tissue luminometry. Subgroups of mice were subsequently administered serotype rh10 AAV on the 9th day of life and with serotype 9 AAV administered at 6 weeks.

Humoral immune responses to vector antigens of serotypes rh10 and 9 AAV as well as luciferase were examined; proliferative responses to luciferase were examined. Genome copy number was examined after vector readministration. **Results:** 1) *Immune Studies.* After the first injection of AAVrh10, no humoral immune response developed to either rh10 capsid antigens or luciferase; in addition there were no proliferative responses to luciferase (single dose mice). After the 2nd postnatal injection of AAVrh10 on the 9th day of life, similarly there was a lack of development of a humoral or cellular responses to luciferase; however, a humoral response did develop to the AAVrh10 capsid (double dose mice). With injection of AAV 9 at 6 wks, there was no development of humoral or cellular responses to luciferase, but antibodies to serotype 9 AAV capsid proteins did develop (triple dose mice). 2) *Expression Studies.* As expected, luciferase decreased from day 2 to day 100 in the single dose group. However, luciferase expression was augmented by a 2nd postnatal injection on day 9 in the double dose group and was further increased by an adult injection in the triple dose group. 3) *Genome Studies.* Examining the rapidly dividing liver, we detected a substantial decline in viral copy number to 100 days in mice administered a single dose of AAV shortly after birth. However, copy number could be increased with a second dose postnatally and further augmented with a third dose as adults. **Conclusions:** Neonatal gene therapy with episomally-located vectors is hampered by the rapid loss of genomes with cellular proliferation. However, with establishment of tolerance, augmentation of expression is possible without immune consequences with vector readministration. Protective immunity to viral pathogens remains intact as the initial capsid immune unresponsiveness was due to ignorance. These studies demonstrate that neonatal tolerance induction makes augmentation of expression by serotype switching possible to overcome the loss of vector genomes. These studies along with similar studies in the murine hemophilia A model will be presented.

286. Live Oral Bacterial Cell Therapy for Term Infants with Cyanotic Congenital Heart Malformations: Investigating Hypoxia and Probiotic Induced Changes in the Intestinal Microbiota

Collin L. Ellis,¹ John C. Rutledge,¹ Gary W. Raff,¹ Mark A. Underwood,¹
¹*University of California-Davis, Sacramento, CA.*

Necrotizing enterocolitis (NEC) is a relatively common post-operative complication in infants with cyanotic congenital heart diseases (CCHD) which adds to their morbidity and mortality and involves both gut microbes and immunity. Two novel critical questions are 1. whether chronic hypoxia in CCHD alters the neonate's developing gut microbial cellular populations (microbiota), increasing NEC risk and 2. whether gastrointestinal-introduction of probiotic (beneficial, live) bacterial cells, a form of prokaryotic cell therapy, can restore/direct the host's microbiota to become more like infants without CCHD, potentially decreasing NEC risk. To answer question 2 we aimed to test the *hypothesis* that an orally-administered probiotic selected for its functionally-annotated genome, *B. longum* subsp. *infantis* ATCC 15697, at a dose of 10⁹ CFU 2x/d to term infants with CCHD would change their gut microbiota as assessed by molecular methods. Specifically, we hypothesized there would be a decrease in pro-inflammatory bacteria (of which a majority have classical Gram- stains), with a corresponding increase in anti-inflammatory bacteria (of which a majority have classical Gram+ stains), compared to placebo controls. 16 neonates with CCHD were enrolled in a registered, randomized, placebo-controlled, double-blind, prospective pilot trial and assigned to receive either probiotic or placebo for 8 weeks or until discharge or death. Placebo and probiotic were well tolerated without obvious side effects. Stool specimens are

surrogates for assessing gut target-site delivery of probiotics and were obtained weekly for 4 weeks and at study completion. Extracted DNA was qPCR-amplified via primers targeting the microbial 16S ribosomal RNA gene (a phylogenetic marker) used here to quantify total microbial loads and relative taxa abundances. *At the time of submission*, we have analyzed 8 total specimens from 2 infants: 1 probiotic and 1 placebo (x=unanalyzed). We report quantitative measurements of total bacterial load and relative % of 3 bacterial populations at the higher-taxonomic order-level: Gram- Bacteroidales and Enterobacteriales and Gram+ Lactobacilliales.

	STOOL ANALYSIS	WEEK 1	WEEK 2	WEEK 3	WEEK 4	COMPLETION
Placebo	Total Bacteria	4.17e5	x	2.33e8	1.12e7	7.56e5
	% Bacteroidales	6	x	48	42	0
	% Enterobacteriales	0	x	5	20	13
	% Lactobacilliales	0	x	0.8198	0	0
Probiotic	Total Bacteria	4.56e7	2.02e7	1.21e7	x	1.34e8
	% Bacteroidales	0	0	1	x	0.0011
	% Enterobacteriales	22	23	0.5325	x	15
	% Lactobacilliales	1	0.2675	4	x	0.0845

The number of infants analyzed thus far precludes any study conclusions or statistics, however, our results are consistent with our hypotheses. There are greater overall Bacteroidales in the placebo and lower mid-study Enterobacteriales in the probiotic infant. Lactobacilliales both bloomed earlier in the probiotic than in the placebo infant and sustained colonization after study completion. Blinded analysis of remaining specimens from all infants and Gram+ Bifidobacteriales and Clostridiales assays, among others, are going. Upon completion, correlations will be explored including timing of antibiotics, type of feeding, and episodes of sepsis and NEC.

287. Liver-Specific Expression of the Insulin Epitope 9-23 Using a Lenti-Viral, microRNA142 Regulated Vector Protects Against Autoimmune Diabetes

Akbarpour Mahzad,¹ Kevin Goudy,¹ Naldini Luigi,^{1,2} Maria-Grazia Roncarolo.^{1,2}

¹San Raffaele Telethon Institute for Gene Therapy, Milan, Italy;

²Vita Salute San Raffaele University, Milan, Italy.

Type 1 diabetes (T1D) is an autoimmune disease caused by the T cell-mediated destruction of the insulin-producing β cells. Among the autoimmune pathogenic effector T cells, the insulin-specific CD4 and CD8 T cells that recognize the insulin (Ins) β chain amino acid region 9-23 are critical in orchestrating β cell destruction. While microRNA regulated lentiviral vectors can induce tolerance to many foreign proteins in an antigen-specific manner, the goal of this study is to determine whether a microRNA 142 (miR-142)-regulated lentiviral vector (LV) encoding the Ins β 9-23 region can induce tolerance in an autoimmune disease and prevent diabetes onset in the human model for T1D, the non-obese diabetic (NOD) mouse, through the generation of Ins β 9-23 regulatory T cells. A series of miRNA142 LV vectors encoding the Ins β fragment 9-23 or an irrelevant protein using a constitutive promoter (PGK.Ins β 9-23.miR142 and PGK.OVA.miR142) or containing liver-specific promoter (ET.Ins β 9-23.miR142) were injected into prediabetic 8-10wk old female NOD mice and followed for diabetes. Surprisingly, PGK.Ins β 9-23.miR142 injected mice developed diabetes at a similar rate compared to that of PGK.OVA.miR142 and untreated mice (33% and 20% respectively), however, ET.Ins β 9-23.miR142 injected showed 85% protection at 20 weeks. To verify that the Ins β 9-23 used has immunostimulatory properties, a PGK.Ins β 9-23 model was evaluated in a dendritic cell (DC) transfer model, which showed DC transduced with Ins β 9-23 LV lacking miRNA142 induced robust IFN- γ production in an

antigen-specific recall assay. Thus, while the induction of Ins β 9-23 specific-regulatory T cells is under current investigation, Ins β 9-23 specific responses can occur and is a key element to protecting NOD mice from developing diabetes since mice treated with OVA encoded construct has no effect on diabetes development. Taken together, the use of liver-specific, miRNA vectors encoding for an autoantigen is a successful approach to circumvent established autoimmune responses, and presents a promising therapeutic advance in designing a clinical gene delivery system to treat immune-related diseases.

288. The AAV2(Y-F) Mutant Capsid Causes Immune Avoidance to Killing by Capsid Specific CD8+ T Cells and Is Further Improved by Proteasome Inhibition

Ashley T. Martino,¹ David M. Markusic,¹ Arun Srivastava,¹ Roland W. Herzog.¹

¹Pediatrics, University of Florida, Gainesville, FL.

A primary goal of AAV vector development is to create optimized vectors for highly efficient gene transfer while limiting detection by the immune system. Although it is well established that rAAV vectors are generally safe, they are not devoid of immune complications. A triple Y-F AAV2 mutant capsid, AAV2(Y-F), was developed to improve both gene transfer and immune avoidance. The change from tyrosine to phenylalanine residues minimizes poly-ubiquitination of capsid proteins and bypasses degradation by proteasomes, which not only shuttles more vector to the nucleus but should also reduce MHC I presentation of capsid peptides. An in vitro CTL (cytotoxic T-cell lymphocyte) assay was developed to determine the degree to which AAV2(Y-F) may avoid targeting by capsid-specific CD8+ T cells. By adding proteasome inhibitors to cultured hepatocytes, this approach also enabled us to test whether killing of transduced cells with wild-type or modified capsid vectors was entirely dependent on proteasome activity. Using an ELISpot assay, we first verified that the dominant CD8+ T cell epitope for AAV2 in BALB/c (H-2d) mice (VPQYGLTL) produced a similar frequency of IFN- γ secreting cells independent of whether AAV2 or AAV2(Y-F) capsid was injected. Next, we established an in vitro CTL assay using AAV infected murine hepatocytes as target cells and capsid-specific CD8+ cells as effector cells. VPQYGLTL-specific CD8+ T cells were generated in BALB/c mice by a primary IM administration of AAV2, followed by a boost with the VPQYGLTL peptide in adjuvant. Subsequently, splenocytes were cultured and capsid specific CD8+ cells further expanded by in vitro stimulation with the epitope for 6 days. The resulting CD8+ cells were then co-cultured at different E:T (effector to target cells) ratios with a BALB/c-derived hepatocyte cell line infected at variable MOIs of AAV2 or AAV2(Y-F) with or without proteasome inhibition. Gene expression was assessed and cell death was measured by flow cytometry. Dead target cells were co-stained with DiOC18 (a stable membrane dye used for labeling of the target cells) and a cell death (7-AAD) marker. In order to achieve similar transduction efficiency, a 10-fold higher MOI was required for AAV2 compared to AAV2(Y-F). While hepatocyte killing was MOI-dependent, reducing the MOI from 105 to 103 vg/cell resulted in a only 23% decrease in killing at the highest E:T ratio for AAV2 capsid but 60% for AAV2(Y-F). At MOIs of 103-104, killing of AAV2(Y-F) transduced hepatocytes was reduced by 56% and, when adjusted for equal transduction efficiency, was reduced by 67%. Proteasome inhibition during infection (MG-132 or Bortezomib) reduced cell death for AAV2 capsid by 92% and 31% for AAV2(Y-F) at equal MOIs, representing the background level of non-specific killing. Together, these data show that CTL-mediated killing of murine hepatocytes transduced with AAV2(Y-F) as compared to AAV2 was substantially reduced. Effectiveness in elimination of the remaining level of targeting by CD8+ T cells by proteasome inhibitors suggests that MHC I presentation of wild-type and modified capsid antigens requires proteasomal activity.

289. Differential Activation of Innate Immune Responses and T Cell Proliferation by Adeno-Associated Virus Vectors Containing Different Regulatory Cassettes in Murine Pompe Disease

Ping Zhang,¹ Takuya Osada,² Andy Bird,¹ Songtao Li,¹ Timothy Clay,² Dwight Koeberl.¹

¹*Pediatrics, Duke University, Durham, NC;* ²*Surgery, Duke University, Durham, NC.*

Innate immune responses to adeno-associated virus (AAV) vectors have been incompletely investigated, despite immune responses that complicated both preclinical experiments and clinical trials with AAV vectors. Gene therapy experiments in acid α -glucosidase knockout (GAA-KO) mice have provided useful insight, because these mice sometimes mount immune responses to GAA expressed with AAV vectors. Liver-specific expression of hGAA with an AAV2/8 vector containing a liver-specific regulatory cassette (LSP-hGAA) has established immune tolerance in GAA-KO mice, as demonstrated by the absence of antibody formation in response to GAA and adjuvant. In contrast, an AAV2/8 vector containing the universally active CMV enhancer/chicken β -actin regulatory cassette (CB-hGAA) provoked both T cell and antibody responses against GAA. The immune mechanisms for the differing immune responses against these two vectors are largely unknown, and therefore we investigated innate immune responses against these vectors. Groups of mice were injected with LSP-hGAA, CB-hGAA or uninjected. One hour and 6 hours later, serum was collected and liver was snap frozen. Gene expression of a broad range of cytokines and chemokines was analyzed by real-time PCR from liver. CB-hGAA induced expression of cxcl-1 and IL-1 β in liver at 6 hours compared with the LSP-hGAA. Serum cxcl-1 was elevated in CB-hGAA injected mice. We hypothesize that the liver-specific expression of GAA induces tolerance at the T cell level and the ubiquitous expression of GAA does not induce T cell tolerance, because adaptive responses are controlled by innate immune responses. We next investigated adaptive immune responses to the AAV2/8 vectors to correlate with innate immune responses. Groups of mice were injected with the LSP-hGAA, CB-hGAA, or uninjected as controls. Six weeks later, mice were immunized with GAA and adjuvant. At 8 weeks, splenocytes were harvested and T cell proliferation was tested using ³H-thymidine method. As expected, liver specific expression of GAA by LSP-hGAA suppressed the anti-GAA IgG1 response. The control group showed a vigorous T cell proliferation in response to GAA, whereas the T cells from mice injected with LSP-hGAA failed to proliferate at all. The CB group mice exhibited increased GAA specific T cell proliferation compared with the LSP-hGAA-injected group. We conclude that LSP-hGAA did not activate innate immune responses, which is associated with T cell tolerance to GAA. In contrast, the CB-hGAA induced selective cytokine and chemokine expression, which directs adaptive immune response to GAA and abrogated efficacy from AAV vector treatment of mice with Pompe disease. Moreover, co-administration of the two vectors prevented adaptive responses against GAA. The innate and adaptive immune responses to ubiquitously expressed GAA will have implications for the choice of regulatory cassette, when designing vectors intended for gene therapy in muscle diseases such as Pompe disease.

290. FoxP3-Treg Preconditioning with IL-2-IL-2 Antibody Complex Overcomes Promotes Transgene Tolerance in a Stringent Autoimmune Model after Lenti-Viral Transfer

Kevin Goudy,¹ Mahzad Akabarpur,¹ Andrea Annoni,¹ Luigi Naldini,^{1,2} Maria-Grazia Roncarolo.^{1,2}

¹*San Raffaele Telethon Institute for Gene Therapy, Milan, Italy;* ²*Vita Salute San Raffaele University, Milan, Italy.*

The frequency and potency of FoxP3-expressing regulatory T cells (Treg) play a pivotal role in regulating tolerance to transgenes in most mouse strains after gene therapy with a highly tolerogenic lenti-viral vector platform containing a micro-RNA 142 target sequence and a liver specific promoter (ET.LV.142T). However, the non-obese diabetic (NOD) represents a stringent and clinically relevant model that clears transgene expressing cells despite using the ET.LV.142T platform. To test whether expansion of the Treg pool prior to vector delivery can overcome the clearance of transgene and promote long-term tolerance, NOD mice were treated three times with ultra low doses of the IL-2 complex (recombinant IL-2 coupled with the IL-2 antibody (Ab) JES61) before injecting an ET.LV.142T vector encoding GFP (ET.LV.GFP.142T). Control mice treated with ET.LV.GFP.142T alone had elevated levels of GFP-specific CD8 T cell responses in liver and spleen in terms of frequency and IFN γ expression, modest induction of liver Treg compared to untreated mice and the absence of GFP expressing hepatocytes 3 wks after treatment. To the contrary, IL-2 complex treated mice prior to ET.LV.GFP.142T injection possessed GFP-expressing hepatocytes, high levels of liver Treg compared to vector treated and untreated mice and had reduced IFN γ producing GFP-specific cells. While long-term tolerance is still under investigation, this study provides important evidence that i) clearance of transgene using ET.LV.142T platforms likely is a result from low frequency and function of the Treg population at the time of injection, ii) increased frequency of the total Treg pool with the IL-2 complex prior to vector injection promotes transgene tolerance and iii) Treg expansion may be a means to overcome the limitations of gene therapy in the clinic resulting from clearance of transgene due to pre-existing immunity and/or potent immune response to transgene.

291. The Critical Role of Activation Induced Cell Death and Passive Apoptosis in the Induction of *In Vivo* Tolerance toward AAV8 in the Liver

Susan M. Faust,¹ Tullia Lindstein,² Craig B. Thompson,² James M. Wilson.¹

¹*Gene Therapy Program, Department of Pathology & Laboratory Medicine, University of Pennsylvania, Philadelphia;* ²*Department of Pathology, Memorial Sloan-Kettering Cancer Center, New York, NY.*

The development of gene replacement therapy provides a tremendous opportunity to treat genetic diseases, but the risk of an adverse immune response toward the vector as well as the therapeutic transgene product remains problematic. Numerous studies in mice demonstrate that AAV8 gene transfer to the liver is associated with immunological tolerance toward both the AAV vector and the antigenic transgene product. Apoptosis of mature T lymphocytes is integral for regulating the induction of tolerance following stimulation with self and foreign antigens. T cell apoptosis occurs through two primary pathways: antigen driven death (activation induced cell death) and cytokine withdrawal (passive apoptosis). To study the role of activation induced cell death and passive apoptosis in tolerance induction toward AAV8 vectored transgene expression following hepatic gene transfer, mice lacking functional Fas and mice that express Bcl-xL constitutively were intravenously injected with 1E11 viral particles of AAV2/8 expressing a nuclear β gal (nLacZ) transgene. In Fas deficient mice, nLacZ expression is significantly

reduced compared to WT counterparts beginning 4 weeks post vector administration. Loss of transgene expression is not associated with diminished viral genome copy numbers but does correspond with a progressive accumulation of β gal reactive T cells in the periphery as well as a heavy CD4⁺ and CD8⁺ cellular infiltrate within the liver resembling neo-lymphoid aggregates. TUNEL stain of liver sections detect the presence of apoptotic lymphocytes in wild type mice challenged with AAV8 peaking around day 28 post vector administration. These data demonstrate that Fas-mediated apoptosis regulates the accumulation of transgene reactive T cells within the periphery following AAV8 gene transfer. Enhanced neutralizing antibody responses toward AAV8 in Fas deficient mice also indicate that Fas must be expressed on B cells to prevent the accumulation of activated B cells capable of generating neutralizing antibody to AAV8 and/or that the accumulation of CD4⁺ T cells results in greater opportunity for B cells to become activated and produce antibody toward AAV8. These data provide evidence that Fas signaling in lymphocytes is important for immune hyporesponsiveness toward AAV8 transgene expression. Bcl-xL regulated apoptosis also plays a role in tolerance induction toward AAV8 vectored transgene product and has a more dominant effect on transgene expression than Fas deficiency, resulting in an almost complete abrogation of transgene expression. These results demonstrate that two different pathways of apoptosis--activation induced cell death and passive apoptosis--eliminate transgene reactive T cells and are critical for the induction of tolerance in the liver toward AAV8.

292. Direct Presentation, Not Cross Presentation of AAV Capsids, Render Hepatocytes Target for CTLs in a Humanized Mouse Model

Suryanarayan Somanathan,¹ Luk Vandenberghe,¹ Peter Bell,¹ Soumitra Roy,¹ James L. Riley,¹ James M. Wilson.¹
¹Gene Therapy Program, Department of Pathology & Laboratory Medicine, University of Pennsylvania, Philadelphia.

The first ever clinical trial to correct a metabolic disorder by gene transfer to the liver using an adeno-associated viral vector (AAV2) expressing FIX was underscored by mild transaminase elevation and transient expression from the vector. It was hypothesized that the presence of pre-existing capsid specific T cells, reactivated upon vector administration, were responsible for the loss of transgene expression. Since AAV vectors lack expression of capsid proteins and inefficiently transduce antigen presenting cells, the results led to the hypothesis that elimination of transgene expression was a result of cross-presentation by the transduced hepatocytes – a process normally ascribed to professional antigen presenting cells. Here we report on the development of a humanized mouse model to replicate cross-presentation of AAV capsid antigens in the liver. Immuno-compromised mice expressing human class I HLA in the liver were adoptively transferred with human CTLs redirected to an epitope restricted by human HLA. Specifically, we created vectors based on a variant AAV2 capsid that was engineered to contain a highly immunogenic epitope of HIV-gag (SL9). These vectors were injected IV into animals stably expressing human HLA A*0201/ β 2 microglobulin in the liver; the animals were adoptively transferred two weeks earlier with ~4 million HLA A*0201 restricted highly active SL9-redirected T cells. The presence of highly activated CTLs prior to vector administration recapitulates the presence of a capsid-specific anamnestic response. In pilot experiments we noted that the engineered vectors behaved no different than control vectors in transducing mouse hepatocytes following systemic administration. Levels of human beta chorionicgonadotrophin (hBCG) expressed from a liver-specific promoter were then used as a surrogate for capsid-specific immune responses. In addition, an adenoviral vector expressing the AAV capsid and hBCG driven by CMV and EF1 promoters respectively, was a positive control for class I presentation

of the SL9 epitope. The redirected T cells expressing SL9 did target Ad transduced hepatocytes expressing AAV2 with the SL9 epitope. The redirected T cells had no effect on Ad vectors that expressed capsids devoid of the engineered epitope indicating the specificity of the immune response to the SL9 epitope. Interestingly, redirected T cells failed to impact expression from an AAV2 vector with the engineered SL9 epitope. In all instances, liver enzyme elevations were uneventful and transgene expression was stable. In summary, high frequencies of potent CTLs were incapable of targeting AAV2 transduced hepatocytes when the AAV capsid contained a high affinity T cell epitope to the CTLs. Our studies do not support the hypothesis that cross presentation of AAV capsid sensitizes the capsid to killing.

293. Adaptive Immunity to rAAV1 Is Supported by Capsid-Specific Th1 T Cell Responses and Is Critically-Dependent upon MyD88 Signaling in B Cells

Muriel Sudres,¹ Séverine Ciré,¹ Virginie Vasseur,² Léa Bréaut,² Sylvie Darocha,¹ Florence Boisgérault,¹ Christine LeBec,¹ David-Alexandre Gross,¹ Bernard Ryffel,² Anne Galy.¹
¹Immunology and Innovative Biotherapies, Inserm UMR S951, Genethon, Evry, France; ²Immunology and Molecular Embryology, CNRS UMR 6218, CNRS, Orleans, France.

The administration of adeno-associated viral vectors (AAV) for gene transfer can induce strong humoral responses against the viral components of the vector through mechanisms that remain incompletely characterized. To determine if the vector triggers cell-intrinsic innate responses linked to the development of CD4-mediated adaptive immunity, various mice deficient in single TLR, type-1 IFN or inflammasome signaling were injected with rAAV1 to measure T-dependent antibody responses. As in normal mice, high levels of vector-specific IgGs were induced in mice deficient in either TRIF, TLR9, TLR7, INFabR, TLR2, TLR4, NALP3, ICE or IL1R but not in mice deficient in MyD88. Whereas normal mice mount high titer T-dependent, neutralizing, capsid serotype-specific antibodies essentially of the IgG2 and IgG3 subtype, MyD88^{-/-} mice failed to mount capsid-specific Th1 T cell responses and also failed to produce rAAV1-specific IgG of any subtype. Purified cell transfers show that MyD88 is differentially required and played no essential role in T cells nor in antigen presentation by dendritic and B cells, but is required for the productive priming of capsid-specific T cells. In addition, MyD88 plays an autonomous role in B cells, favoring Th1 antibody production independently of antigenic presentation. The response to rAAV1 therefore involves a complex but specific cross-talk between innate and adaptive immune responses leading to CD4 T cells and B cell activation. MyD88 emerges as a pivotal target for combined T and B immunosuppression strategies aiming to control antibody responses to rAAV.

294. Development of Novel Strategies To Modulate Pre-Existing Anti-Factor VIII Immune Responses in Hemophilia A Inhibitor Mice Treated with Factor VIII Plasmid-Mediated Gene Therapy

Chao-Lien Liu,¹ Peiqing Ye,¹ Jacqueline Lin,¹ Carol H. Miao.^{1,2}
¹Department of Pediatrics, Seattle Children's Research Institute, Seattle, WA; ²University of Washington, Seattle, WA.

Inhibitory antibody formation (FVIII inhibitors) against transgene product can constitute a major complication following gene therapy for genetic diseases such as hemophilia A. Recently many approaches have been developed to prevent the formation of anti-FVIII antibodies, and most of the successful protocols involve the suppressive functions of regulatory T (Treg) cells. Nevertheless, innovative strategies to overcome pre-existing anti-FVIII immune responses in primed

subjects are still lacking. Anti-FVIII inhibitory antibodies once generated sustain for very long time due to the persistence of memory B cells. We devised and investigated single or combination therapy using agents targeting memory B cells to eradicate/inactivate the memory responses and agents inducing Treg expansion to suppress the T cell function. A monoclonal anti-murine CD20 IgG2a antibody was used to deplete pan B lymphocytes from pre-B cells to memory B cells ranged from 50-80%. The depletion of B cells lasted for sustained periods of time and gradually returned to normal at ~8 weeks post treatment. A specific IL2/IL2mAb (JES6-1) complex was used to induce in vivo expansion of Treg cells. Treg cells increased ~5-7 folds in the peak day (day 3 post treatment), then gradually returned to normal levels at 9-12 days following treatment. Rapamycin was used to enhance and maintain Treg cell expansion. Inhibitor mice were generated by hydrodynamic injection of 50 μ g of hFVIII plasmid via tail vein of hemophilia A mice and only mice with inhibitor titers >30 Bethesda units were used. Five groups of FVIII plasmid-primed inhibitor mice were treated with five different immunomodulation regimens: anti-CD20+IL2/IL2mAb complexes+rapamycin+FVIII, anti CD20+IL2/IL2mAb complexes+rapamycin, anti-CD20+FVIII, IL2/IL2mAb complexes+rapamycin+FVIII, FVIII+IgG control. Anti-CD20 (250 μ g/mouse/treatment) was given i.v. 3 times in consecutive days at the first week, followed by a second boost at the third week. IL2/IL2 mAb complexes (6 μ g/mouse) and rapamycin (25 μ g/mouse) were injected i.p. for three consecutive days every week for 4 weeks. FVIII protein (0.3U/mouse) was given 3 times every other day per week for 4 weeks. Combination therapy used the same schedule for each agent as the single treatment. Except the FVIII+IgG control group, all four groups treated with immunosuppressive regimens showed a reduction of inhibitory titers following treatment. Most significant reduction of inhibitory antibody titers was detected in the anti-CD20+IL2/IL2mAb complex+rapamycin+FVIII treated group, inhibitor titer was reduced to 0 in two out of the four treated mice and a reversion of 8% FVIII gene expression was observed. Long-term responses are being followed and second challenge with FVIII plasmid will be used to evaluate the induction of long term tolerance to FVIII. These combination regimens are highly promising in modulating/eliminating pre-existing anti-FVIII antibodies and inducing long-term tolerance in FVIII plasmid primed subjects.

295. Upregulation of Interferon Pathways in Tumors Resistant to Oncolytic Adenovirus

Ilkka Liikanen,¹ Vladia Monsurrò,² Laura Ahtiainen,¹ Mari Raki,¹ Tanja Hakkarainen,¹ Iulia Diaconu,¹ João D. Dias,¹ Vincenzo Cerullo,¹ Anna Kanerva,¹ Sari Pesonen,¹ Daniela Marzioni,³ Marco Colombatti,² Akseli Hemminki.¹

¹Cancer Gene Therapy Group, Molecular Cancer Biology Program, Transplantation Laboratory, Haartman Institute and Finnish Institute for Molecular Medicine, University of Helsinki, Helsinki, Finland; ²Department of Pathology, University of Verona Medical School; Azienda ospedaliera Universitaria Integrata di Verona, Verona, Italy; ³Department of Molecular Pathology and Innovative Therapies, Polytechnic University of Marche, Ancona, Italy.

Although preclinical results with oncolytic adenoviruses have been promising, and clinical safety has been excellent, it is also apparent that tumors can become virus resistant resulting in progression after initial response. The resistance mechanisms acquired by advanced tumors against conventional therapies are increasingly well-understood, which has allowed designing countermeasures. To study this in the context of oncolytic adenovirus, we developed an in vivo model of acquired resistance, and investigated the phenomenon on the RNA and protein levels using two types of analysis of microarray data, reverse transcriptase-polymerase chain reaction and immunohistochemistry. Interferon signaling pathways were found

upregulated and Myxovirus resistance protein A expression was identified as a simple marker protein correlating with resistance to virus. Furthermore, pathway analysis suggested potential therapeutic targets to counteract interferon induction. Improved understanding of the antiviral phenotype causing tumor recurrence is of key importance in order to improve treatment of advanced tumors with oncolytic adenoviruses. We identified upregulated interferon signaling as an in vivo resistance mechanism that tumors can acquire to escape the antitumor effect of oncolytic adenovirus. Given the similarities between mechanisms of action, this finding might be relevant for other oncolytic viruses as well.

296. TLR9 Signaling and Regulatory T-Cells Orchestrate the Immune Response to the Transgene Product in Muscle

Brad E. Hoffman,¹ Mario Cooper,¹ Roland W. Herzog.¹
¹Pediatrics, U of Florida, Gainesville, FL.

Immune responses to gene products are a major concern in gene therapy. For example, in gene replacement therapy for hemophilia, the functional coagulation factor may in fact represent a neo-antigen that can be subject to an adaptive immune response. Thus, the ability to maintain immunological unresponsiveness to the therapeutic protein is a key requirement for successful therapy. The development of effective protocols is dependent upon a deeper understanding of the mechanisms that circumvent the induction of the adaptive response. Advances in the field have suggested that the innate immune response plays an essential role in initiating the process, while activation of immune regulatory pathways can prevent such responses. How innate immunity and immune regulation may be linked has been unclear. Toll-like receptors (TLRs) are a class of proteins that play a significant role in the activation of innate immunity and are believed to primarily drive Th1 immunity. AAV vectors provoke only mild innate immune responses and have thus been considered ideal for therapy by *in vivo* gene transfer. However, it has recently been demonstrated that the TLR9 pathway is critical for the activation of CD8+ T-cells and antibody responses to the vector capsid and the transgene, potentially leading to the loss of expression. Interestingly, muscle-directed gene transfer of human factor IX (hFIX) results in sustained systemic expression without (or limited) antibody formation in B6 mice if a specific AAV serotype and dose is used. In this study, we take advantage of this experimental model to evaluate the interactions between innate mechanisms and CD4+CD25+Foxp3+ Treg-mediated immune tolerance. AAV1-CMV-hFIX (1e11 vg/mouse) containing a TLR9 agonist (CpG-ODN) or vector alone was injected into the muscle of transgenic B6 mice expressing a diphtheria toxin (DT) receptor-fusion protein under the control of the Foxp3 promoter. At 3 & 6 days post gene transfer, groups of mice were administered DT to selectively, but transiently, deplete Foxp3+ Tregs. In contrast to mice that received vector only, transient Treg depletion resulted in complete loss of tolerance as shown by the lack FIX expression and sustained anti-hFIX antibody formation.

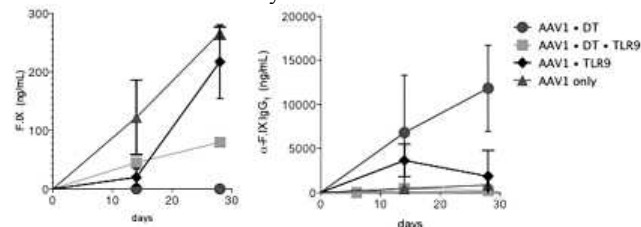

Interestingly, when mice received vector combined with TLR9 (but not TLR2) stimulation, there was a transient IgG1 (i.e. Th2-like) antibody response that attenuated systemic hFIX expression. However, in the absence of Treg, TLR9 activation failed to induce IgG1 formation and instead drove a substantial CD8+ T cell

infiltration in the muscle, suggesting Th1 immunity. In this case, moderate systemic expression in the absence of anti-hFIX was observed. These results indicate that the integration of TLR9 signaling and Treg function regulates the response to the transgene product in skeletal muscle, with Treg deviating the TLR9-induced response toward Th2.

297. Activities of Nucleic Acid Binding and Stimulation of ATP Hydrolysis by RNA Helicase RIG-I and Activation of Type I Interferon Response

Sujin Yoon,^{1,2} Kyung-Bo Kim,¹ Kkothanahreum Park,¹ Keun-Sik Kim,¹ Dong-Eun Kim.^{1,2}

¹Department of Bioscience and Biotechnology, Konkuk University, Seoul, Korea; ²WCU and BRL Program, Konkuk University, Seoul, Korea.

Appearance of viral nucleic acids in mammalian cytoplasm triggers antiviral defense mechanism by activating innate nucleic acids receptors: retinoic acid-inducible gene I (RIG-I) and Toll-like receptors (TLRs). RIG-I is critical in sensing viral RNA and DNA in the cytoplasm of cells. RIG-I belongs to the DExD/H family of helicases, which contains both nucleic acids binding and ATP hydrolysis activity. Activation of RIG-I by binding of non-self RNA present in the cytoplasm invokes antiviral responses including type I interferon (IFN) expression, inflammasome activation and proapoptotic signaling. Several reports have shown that C-terminal domain of RIG-I recognize distinct RNA patterns: double-stranded (ds) and 5'ppp single-stranded (ss) RNA. These patterns have been believed to be related with the extent of type I IFN immune response in cells. In this study, we have characterized diverse enzyme activities of RIG-I to investigate which enzyme activity of RIG-I is correlated with the extent of immune response in cells. Since the ATPase activity of RIG-I is dependent on the presence and nature of RNA ligands, ATP hydrolysis activity was measured by using several nucleic acid substrates differing in their structure and presence of 5' terminal phosphate. RIG-I exhibited the best ATPase activity for the blunt-end dsRNA with 5'ppp, and the least activity for the ssRNA with 5'OH end. Double-stranded RNA with blunt end is required for stimulation of ATPase activity regardless of 5' terminal phosphate. Nucleic acids binding by RIG-I was also investigated by electrophoresis mobility shift assay and nitrocellulose filter binding assay. When the blunt-end RNA substrates generated by annealing of two ssRNA strands (47 and 25 nts) were compared for binding to RIG-I, the blunt-end dsRNA containing a longer 5' strand was more favorable for binding. Furthermore, we have observed that ATP hydrolysis significantly weakens stable binding affinity of RNA ligands to the enzyme. Absence of ATP or nonhydrolyzable ATP analogue showed tighter binding of RNA ligands. We are currently investigating type I IFN response with several RNA ligands transfected into the cells. These results will reveal the important correlation between the innate IFN stimulation and the enzyme activities of RIG-I such as RNA binding affinity and/or ATPase stimulation extent.

Gene Regulation I

298. Integration of Lentiviral Vectors in Human Genes Generates Abnormal Transcripts through the Usage of Constitutive and Cryptic Splice Signals

Arianna Moiani,¹ Riccardo Mezzadra,² Daniela Sartori,¹ Ylenia Paleari,² Annarita Miccio,³ Fabienne Cocchiarella,³ Claudia Cattoglio,¹ Giuliana Ferrari,^{2,4} Fulvio Mavilio.^{1,3}

¹Laboratory of Gene Expression, Istituto Scientifico H. San Raffaele, Milan, Italy; ²H. San Raffaele-Telethon Institute for Gene Therapy (HSR-TIGET), Milan, Italy; ³Center for Regenerative Medicine, University of Modena and Reggio Emilia, Modena, Italy; ⁴Università Vita-Salute San Raffaele, Milan, Italy.

HIV-derived, self-inactivating (SIN) lentiviral vectors (LVs), depleted of LTR enhancer and promoter regions, provide an efficient, versatile and relatively safe gene delivery system. Nevertheless, since LVs integrate preferentially into active genes, they have the potential to de-regulate gene expression at the post-transcriptional level, by interfering with the normal splicing and polyadenylation of primary transcripts. To test this hypothesis, human T cells, myeloid cells and keratinocytes were transduced with a specifically designed, "splice trap" LV, and cloned for the expression of a promoter-less GFP gene placed downstream of the constitutive HIV GAG splice acceptor site. Cells were transduced also with SIN-LVs carrying internal GFP expression cassettes or a full human β -globin gene driven by a β -globin promoter and a reduced-size LCR. Cells were individually cloned and integration sites mapped by LM-PCR in individual clones. Chimeric transcripts were identified by RACE PCR and exon-specific RT-PCR. Abnormal, chimeric transcripts were identified in >50% of the LV target genes in all cell types. Semi-quantitative RT-PCR revealed that fusion transcripts were mostly represented at low level compared to constitutively spliced, wild-type transcripts. Fusion transcripts were generated through aberrant splicing caused by the usage of both constitutive and cryptic splice sites located in the viral intron and the U5 portion of the 5' LTR and in the β -globin transcriptional cassette. We have identified a limited set of cryptic splice sites that are responsible for most of the aberrantly spliced transcripts, providing a platform to recoding vector backbones in order to reduce their potential post-transcriptional genotoxicity.

299. The RNA Interference Pathway Is Responsible for Silencing of Transgene Expression after Sleeping Beauty Mediated Somatic Integration

Christina Rauschhuber,¹ Anja Ehrhardt.¹

¹Department of Virology, Max von Pettenkofer-Institute, Munich, Germany.

Integrating non-viral vectors based on transposable elements and bacteriophage derived integrases are widely used for genetically engineering mammalian cells in functional genomics and therapeutic gene transfer. For the Sleeping Beauty (SB) transposase, which is the most prominent representative of non-viral integration systems, however, it was demonstrated that convergent transcription driven by the SB transposase inverted repeats (IRs) in eukaryotic cells occurs. This may lead to the formation of double-stranded RNAs potentially presenting targets for the RNA interference (RNAi) machinery and subsequently resulting into silencing of the transgene. Therefore, we aimed at investigating transposition under RNA interference knockdown conditions. Thus, we generated RNAi knockdown HEK293 cell lines by introducing the RNAi suppressor protein P19 derived from the tomato bushy stunt virus to analyze the influence of the RNAi pathway. This dimeric protein appears in the cytoplasm and its conformational properties allow the binding and

inhibition of 21 nucleotide long double-stranded siRNAs. In order to characterize the generated RNAi knockdown cell lines we used the marker gene *HoxB8* which is, in differentiated cells, suppressed by the miRNA miR196a. A functional P19 protein binds to this siRNA resulting in an up-regulation of the *HoxB8* mRNA amount. Using a quantitative Real-Time PCR based approach we detected up to 10-fold higher mRNA levels in the RNAi knockdown cell lines compared to the parental cell line HEK293 indicating that P19 is a sufficient inhibitor of the RNAi pathway. Furthermore we analyzed transfection efficiencies of the transposase system components in the different cell lines by luciferase assays. Although we obtained varying transfection efficiencies in HEK293 cells and the RNAi deficient cell lines, the ratio of active transposase to the inactive version of the protein are similar and therefore also comparable for the following experiments. After performing colony forming assays, we found that SB transposition was increased up to 4.5-fold in our RNAi knockdown cell lines. Mechanistically the enhanced transposition events were due to increased transgene expression from the transposon vector and not because of enhanced transposase expression or activity as demonstrated by quantitative Real-Time PCR. In contrast, for another transposable element, the Frog Prince transposon that displays only modest transcriptional activity, a 1.2-fold increase in transposition events was observed. Moreover, after insertion of shielding sequences flanking the transgene expression cassette and preventing inward transcriptional activity, we did not see any difference in transposition events from colony forming assays. In conclusion, we provide clear evidence for the first time that the outcome of a SB transposase based gene therapeutic approach in mammalian cells is regulated by the RNAi machinery. Our results show that after integration, transposon derived transgene expression is regulated by the endogenous RNAi machinery. In the future this finding will help to further improve the molecular design of the SB transposase vector system for therapeutic applications in mammals.

300. Further Improvements and Applications of Context-Dependent Assembly (CoDA): A Publicly Available, Selection-Free Method for Engineering Zinc Finger Nucleases

Jeffrey D. Sander,^{1,2} Deepak Reyon,^{1,3} Ryan Kuzmickas,¹ Cyd Khayter,¹ Morgan L. Maeder,¹ J. Keith Joung.^{1,2}

¹Molecular Pathology Unit, Center for Cancer Research, and Center for Computational Integrative Biology, Massachusetts General Hospital, Charlestown, MA; ²Department of Pathology, Harvard Medical School, Boston, MA; ³Department of Genetics, Development and Cell Biology and Bioinformatics and Computational Biology Program, Iowa State University, Ames, IA.

Engineered zinc finger nucleases (ZFNs) can induce highly efficient genome modifications in a broad range of cell types. ZFNs consist of a customized DNA-binding zinc finger array fused to a non-specific nuclease domain. Double-stranded DNA breaks induced by ZFNs can be repaired by either non-homologous end-joining or homologous recombination, processes that can be harnessed to introduce desired alterations with high efficiencies at or near the site of the break. Widespread adoption and large-scale use of ZFN technology have been hindered by continued lack of a robust, easy-to-use, and publicly available method for engineering zinc-finger arrays. We and other collaborators recently described Context-Dependent Assembly (CoDA), a publicly available platform of reagents and software that is simple to practice and shows a success rate comparable to selection-based methods such as Oligomerized Pool ENgineering (OPEN). With the CoDA approach, three-finger arrays are assembled using a large archive of N- and C-terminal fingers that have been previously identified in other arrays containing a common middle finger. CoDA is rapid and requires no specialized expertise; multi-finger arrays can be constructed in one to two weeks or less using standard cloning

techniques or commercial DNA synthesis. Using CoDA, we rapidly engineered ZFNs and altered 20 different endogenous genes in zebrafish, Arabidopsis, and soybean (Sander et al., Nat Methods 2011). Here we report on the engineering of CoDA ZFNs to multiple loci in endogenous human genes. We will provide an update on the activities of these CoDA ZFNs in cultured human cells. In addition, we will also describe the creation of additional finger units that further extend the targeting range of the CoDA method.

301. Direct Regulation of GDNF Protein Stability Using Destabilizing Domains

Luis Quintino,¹ Khalid Tai,¹ Christina Isaksson,¹ Tom Wandless,² Cecilia Lundberg.¹

¹Wallenberg Neuroscience Center, Lund, Sweden; ²Department of Chemical and Systems Biology, Stanford University, Stanford.

Parkinson's Disease (PD) is a debilitating, progressive and frequent neurodegenerative disease. Gene therapy approaches have potential to slow or even halt disease progression. Although several genes and their products have shown therapeutic potential, glial-cell derived neurotrophic factor (GDNF) has been the most promising so far. Nevertheless, several studies have indicated that prolonged expression of GDNF can have side effects. Therefore, it would be useful to regulate GDNF expression in vivo to minimize any possible side effects. A novel induction system using destabilizing domains (DD) has been recently developed and further adapted to gene regulation in the Central Nervous System. Fusing a protein to a destabilizing domain will selectively target the protein for proteasomal clearance. In the presence of a drug such as tryptophan (TMP), that binds to the destabilizing domain, fusion proteins will be protected from degradation. DD were fused to either the N-terminus (DD-GDNF) or the C-terminus (GDNF-DD) of GDNF respectively. The fusion proteins were subsequently tested for secretion, regulation and function. Lentiviral vectors encoding the fusion proteins were produced and used to transduce 293T cells at specific MOI. Transduced 293T were subsequently treated with increasing concentrations of TMP for 24 hours. After TMP treatment, ELISA was used to estimate GDNF concentration in the cell media. The DD-GDNF and GDNF-DD concentration in the culture media was increased with increased TMP concentrations. However, the concentration of GDNF-DD and DD-GDNF in the culture media were lower than wildtype GDNF. TGW cells were used to screen for functionality. These cells constitutively express the GDNF receptors GFR α and RET. Furthermore, treatment of these cells with GDNF induces the expression of TH. TGW cells were incubated with culture media from transduced 293T. Treatment of TGW with media containing wildtype GDNF or induced DD-GDNF was able to induce TH expression. This result indicates that DD-GDNF is able to activate GDNF canonical signaling cascades to levels comparable to wildtype GDNF. Although the fusion proteins seem to be secreted at lower rates than wildtype GDNF, DD-GDNF is functional. Novel fusion constructs have been designed to have improved secretion and are being screened.

302. Interaction between LCR and a Replicator Mediated by the LARC Complex Prevents Methylation-Dependent Gene Silencing

Liang Huang,¹ Haiqing Fu,¹ Chii Mei Lin,¹ Mirit I. Aladjem.¹

¹Laboratory of Molecular Pharmacology, Center for Cancer Research, National Cancer Institute, National Institutes of Health, Bethesda, MD.

We have previously reported that replicators can prevent transcriptional gene silencing. To advance our understanding of the mechanism, we studied the interactions between two cis-elements, the locus control region (LCR) and one of the two replicators in the human β -globin locus (Rep-P). Here we report the identification and

characterization of a replicator-binding protein complex involved in the prevention of silencing that mediated the interactions between LCR and Rep-P. The protein complex consisting of hnRNP C1/C2, SWI/SNF, and MeCP1 (the LCR-associated remodeling complex, LARC) interacted with an essential asymmetric region within the Rep-P. A Rep-P variant that cannot bind the protein complex failed to prevent gene silencing. Silenced transgene constructs with the mutant Rep-P variant could be re-activated by a DNA methyltransferase inhibitor (zebularine). The re-activation was transient and exposure to zebularine induced distinct, stable, methylation-independent transcriptional silencing that was accompanied by changes in H3K27me3 and H4K20me2 patterns. Our observations suggest that the interaction of LARC complex with replicators plays a role in preventing methylation-dependent gene silencing and propose a novel, epigenetic mechanism of resistance to methylation inhibitors.

303. Multimodal Targeted In Vivo Imaging of Brain Tumors

Johanna M. Niers,¹ Mariam Kerami,¹ John W. Chen,² Ralph Weissleder,² Bakhos A. Tannous.¹

¹Neurology, Harvard Medical School and Massachusetts General Hospital, Boston, MA; ²Radiology, Harvard Medical School and Massachusetts General Hospital, Boston, MA.

We have developed a multifaceted highly specific technique for multimodal imaging of brain tumors. The naturally secreted *Gaussia* luciferase (Gluc) was fused at the C-terminus with a biotin acceptor peptide (BAP) followed by the transmembrane domain of the platelet-derived growth factor receptor (Gluc-BAPTM). Upon expression in mammalian cells, the BAP is biotinylated by biotin ligase with both biotin and Gluc displayed on the cell surface. Glioma cells were engineered ex vivo to express Gluc-BAPTM reporter and were injected intracranially. Brain tumors formation were imaged with Gluc bioluminescence imaging after i.v. injection of its substrate, coelenterazine. Further, brain tumors expressing this reporter had high sensitivity for magnetic resonance (MR) and fluorescence tomographic imaging upon injection of streptavidin conjugated to magnetic nanoparticles or Alexa750 fluorophore respectively. Moreover, single photon emission computed tomography (SPECT) showed enhanced imaging of these tumors upon injection with streptavidin complexed to biotin-DTPA-⁶⁷Ga. This work show for the first time a single small reporter (~20 kDa) which can be imaged with all available modalities including bioluminescence, fluorescence, MR and SPECT/PET allowing real-time tracking of any cells transduced to express it in vivo.

304. Regulation of B23/Nucleophosmin Protein Expression and Function by HIV-1 Derived miR-TAR-5p and miR-TAR-3p

Dominique L. Ouellet,^{1,2} John J. Rossi,² Patrick Provost.¹

¹Microbiology-Infectiology and Immunology, Université Laval, Québec, QC, Canada; ²Molecular and Cellular Biology, Beckman Research Institute at City of Hope, Duarte, CA.

MicroRNAs (miRNAs) are short, 21- to 24-nucleotide (nt) endogenous RNA species generated by the ribonuclease III Dicer and recognized as key regulators of gene expression. As determined previously by our team and others, the transactivating response (TAR) element, a structured RNA located at the 5' end of all transcripts derived from human immunodeficiency virus type 1 (HIV-1), represents a source of functional miRNAs, namely miR-TAR-5p and miR-TAR-3p. Proteomic analysis of stable, TAR miRNA-expressing Jurkat T cells unveiled a two-fold downregulation of B23/Nucleophosmin (NPM), a 37-kDa nucleolar protein known to interact with HIV-1 Tat and Rev proteins. Moreover, RNase protection assay (RPA) and RT-qPCR shown presence of TAR miRNAs and B23/NPM

messenger RNA (mRNA) in immunoprecipitated Argonautes (Ago) loading complexes. Reporter gene activity assays have shown the presence of elements responsive to miR-TAR-5p and miR-TAR-3p in the 3' untranslated region (UTR), but not in the 5' UTR or coding region, of NPM/B23 mRNA. Transposed to the endogenous B23/NPM protein, these data indicate that HIV-1-derived miR-TAR-3p can regulate endogenous B23/NPM expression without affecting the level of its mRNA, in agreement with a regulation based on translational repression. Immunofluorescence and coimmunoprecipitation experiments performed in Tat and/or Rev-transfected cells revealed an interaction between them and B23/NPM, pointing to the nucleolus as a niche for these HIV-1 proteins. Short hairpin RNA-inducing downregulation of B23/NPM expression delocalized Tat and Rev proteins from the nucleolus, suggesting a modulation of B23/NPM by HIV in TAR RNA-expressing cells like memory CD4⁺ T latently infected cells. Our study may provide novel insights into the biological role and functional significance of TAR-containing transcripts and TAR-derived miRNAs in HIV-1 pathogenesis.

305. Scavenging in Reactive Oxygen Species Improves Gene Expression in Polyplex Supported Gene Delivery: Nitroxyl-Radical Containing Nanoparticles Assists Non-Viral Gene Delivery System

Yukio Nagasaki,^{1,2,3,4} Kazuko Toh,¹ Toru Yoshitomi,¹ Yutaka Ikeda.^{1,4}

¹Graduate School of Pure and Applied Sciences, University of Tsukuba, Tsukuba, Ibaraki, Japan; ²Graduate School of Comprehensive Human Sciences, University of Tsukuba, Tsukuba, Ibaraki, Japan; ³Satellite Laboratory, International Center for Materials Nanoarchitectonics (MANA), National Institute of Materials Science (NIMS), University of Tsukuba, Tsukuba, Ibaraki, Japan; ⁴Center for Tsukuba Advanced Research Alliance (TARA), University of Tsukuba, Tsukuba, Ibaraki, Japan.

Non-viral gene vector is one of the promising candidates for suitable gene carrier to avoid issues of viral vectors such as carcinogenicity. Because DNA possesses negative charge, polyion complex with polycation is one of the principles to improve resistance against enzymatic degradation and internalization in cell across the membrane. Though polyion complex is low risk to carcinogenicity, cationic materials are known to show high cytotoxicity due to the strong interaction with anionic cell membrane. For example, PEI induces inflammatory cytokines such as TNF- α and IL-6, which activate NF- κ B, followed by an induction of ROS generation to result in amplification of inflammation reaction, when it is added to the cultured cells. We hypothesized here that inflammation caused by the generated cytokines strongly related to gene expression. To suppress the inflammation, we examined scavenging effect of ROS on gene expression. Nitroxyl radical is known to catalytically react with ROS by its redox characteristics. Thus, we newly designed nitroxyl-radical containing nanoparticle (RNP, Fig. 1).

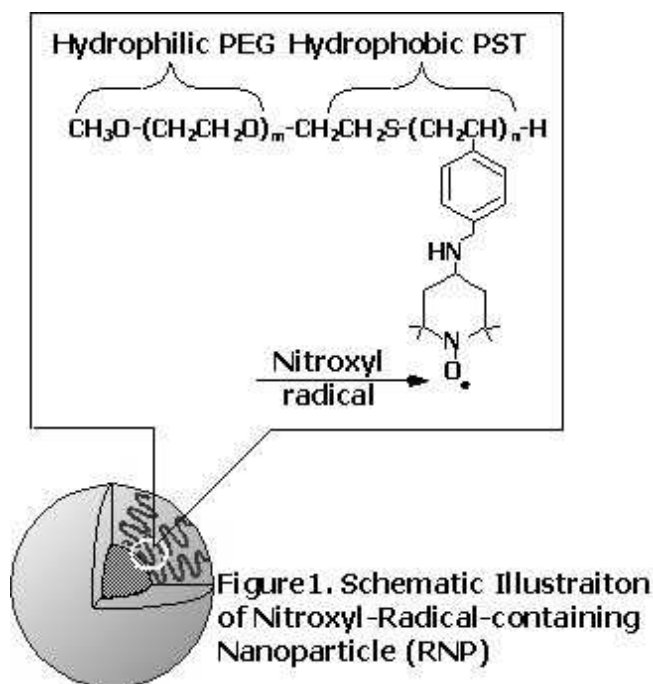

Due to this design, we improved blood circulation time, reduction resistance, lowered toxicity and accumulation in tumor due to the EPR effect. If the ROS scavenging character of RNP is effective to improve in gene expression, feasibility of the non-viral gene therapy will be expanded significantly. To examine the effects of RNP on the transfection efficiency, PEI/pDNA polyplex was added to HeLa cells with or without RNP. The gene expression increased significantly with the increasing amount of RNP and to finally attain about 2.5-fold higher than that without RNP addition (Fig.2).

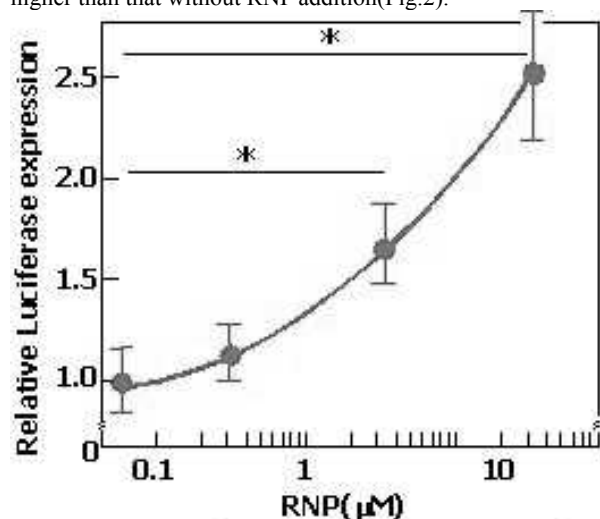

Figure 2. Luciferase gene expression of PEI/pDNA with RNP. pGL3 (0.75 µg/well) was transfected as PEI/pDNA complex (N/P=10). Luciferase expression ratio was normalized as RNP (0 mM) = 1. The independent experiments performed in 5 times (*p<0.01)

Note that no significant difference in protein content was observed regardless of RNP concentrations. We also confirmed that i) cellular uptake of polyplex improved with RNP addition; ii) TNF-α addition decreased gene expression; and iii) RNP addition recovers the gene

expression (data not shown). On the basis of these obtained results, RNP treatment as an ROS scavenger is promising strategy as a new strategy for non-viral gene delivery system.

306. Gaussia Luciferase: A Biomarker for In Vivo Evaluation of Systemic Protein Delivery through Circulation

Salim S. El-Amouri,¹ Phoung Cao,² Dao Pan.^{1,2}

¹Molecular and Cell Therapy Program, Division of Experimental Hematology, Cincinnati Children's Hospital Medical Center, Cincinnati, OH; ²Department of Pediatrics, University of Cincinnati School of Medicine, Cincinnati, OH.

There is a clear need to develop novel tools to monitor in real-time the bio-distribution of gene and protein therapy in vivo. In this study we aimed to evaluate the potential application of Gaussia luciferase (Gluc) as a reporter for real-time monitoring of in vivo protein bio-distribution in mice. To examine the in vivo Gluc production in blood stream and its bio-distribution profile, we injected naked plasmid DNA containing the coding sequence for the secreted Gluc under the control of the CMV promoter or a human alpha-1 antitrypsin-based hybrid promoter (hAAT) into mice by hydrodynamic tail-vein injection. Robust Gluc levels were achieved (500-5000 folds above the background) in blood of all mice 1-3 days after injection, and then decreased rapidly to ~10-folds as compared to control levels on day 7 and thereafter. Whole body imaging analysis showed that localized Gluc distribution could be observed with signals significantly above the background levels in all organs tested except the brain. Among four regions of interest (ROI) evaluated, imaging quantification obtained at paw area was directly correlated to blood luciferase activities as determined using luminometer. Moreover, three-dimensional (3D) bioluminescent imaging (BLI) revealed that the internal luminescent sources were positioned mostly in the liver, heart/spleen, and rectum regions as determined by photon density mapping analyses. These observations are consistent with the fact that the liver is the main target for hydrodynamic gene delivery, and that the metabolic degradation of Gluc involves rectum system. In perfused pHAT-Gluc injected animals, Gluc enzymatic activity was detected at highest levels in liver, and followed by kidney, lung, spleen and heart, suggesting that Gluc has been uptaken by the cells of those organs. However, no Gluc activity was detected in the brain samples of all animal tested, indicating the Gluc was not able to pass the blood brain barrier. To define the reuptake capability of Gluc in various cell types, non-tumorigenic cell lines were exposed to different volume of Gluc-containing medium for different time-points, resulting in different luciferase activities with variable intracellular half-life. These results suggest that BLI can provide a reliable mean for a real-time quantization of Gluc in the circulation and peripheral organs of the same animal at multiple times. Thus, the Gluc-based system can be a valuable tool for monitoring in vivo tracking of protein bio-distribution if in-frame fused with Gluc.

307. Multimodal In Vivo Imaging and Blood Monitoring of Intrinsic and Extrinsic Apoptosis

Johanna M. Niers,¹ Mariam Kerami,¹ Lisa Pike,¹ Grant Lewandrowski,¹ Bakhos A. Tannous.¹

¹Neurology, Harvard Medical School and Massachusetts General Hospital, Boston, MA.

Noninvasive detection and in vivo imaging of apoptosis plays a critical role in the development of therapeutics in many different fields including cancer. We have developed an apoptosis biosensor by fusing GFP to the N-terminus of the naturally secreted Gaussia luciferase separated by a caspase-3 cleavage peptide consisting of aspartic acid (D), glutamic acid (E), valine (V) and aspartic acid (D; DEVD). We showed that this fusion is retained in the cytoplasm

of cells in an inactive form. Upon apoptosis, the DEVD peptide is cleaved in response to caspase-3 activation, freeing ssGluc which can now enter the secretory pathway where it is folded properly and is released from the cells and can be detected in the conditioned medium in culture or in blood of live animals *ex vivo* over time. Since Gluc is secreted from cells via conventional pathway through the endoplasmic reticulum, Golgi and vesicles, we showed that the presence of Gluc in these compartments in response to apoptosis can be visualized *in vivo* using bioluminescence imaging. This reporter provides a valuable tool for imaging and real-time monitoring of apoptosis and is compatible with high-throughput functional screening application in cultured cells and animal models.

308. Prolonged Gene Silencing Effect Using Multilayered siRNA Coated Gold Nanoparticles

Seung-Koo Lee,¹ Myung-Shin Han,¹ Ching-Hsuan Tung,¹

¹Radiology, The Methodist Hospital Research Institute, Houston, TX.

Small interfering RNA (siRNA) has immense potential for the treatment of various diseases by silencing genes, but its delivery to the targeted cells and preservation of extended gene silencing remains challenging. Recently we have developed a fabrication method to prepare multilayer siRNA delivery nano-vectors. Up to 4 layers of poly-L-lysine (PLL) and 3 layers of siRNA were coated onto gold nanoparticles (AuNPs) by alternating the charged polyelectrolytes. The formulated siRNA nanoparticles were stable in physiological condition; however, the encapsulated siRNAs were released slowly when the shielding PLL layers were gradually degraded by intracellular proteases. Cell culture results indicated that the siRNA effect correlated with the number of siRNA layers. AuNPs with 3 layers of siRNA (>80% inhibition) are much better than particles with 2-layer (72% inhibition) or 1-layer (57% inhibition) of siRNA in gene silencing. Furthermore, the layering strategy could prolong inhibition effect. With 2 layers of siRNA, gene silencing effect sustained up to 10 days, while with Lipofectamin 2000 approach could only last for 2 days after transfection.

309. Implication of nNOS Delocalization on the Muscle Force in Dystrophin Deficient and δ -Sarcoglycan Knockout Mice

Dejia Li,¹ Yongping Yue,¹ Yi Lai,¹ Chady H. Hakin,¹ Dongsheng Duan,¹

¹Department of Molecular Microbiology and Immunology, University of Missouri-Columbia, Columbia, MO.

The mechanism of force reduction is not completely understood in Duchenne muscular dystrophy (DMD), a dystrophin-deficient lethal disease. Nitric oxide regulates muscle force. Interestingly, neuronal nitric oxide synthase (nNOS), a major source of muscle nitric oxide, is lost from the sarcolemma in DMD muscle. We hypothesize that nNOS delocalization contributes to force reduction in DMD. To test this hypothesis, we generated dystrophin/nNOS double knockout mice. Genetic elimination of nNOS significantly enhanced force in dystrophin-null mice. Pharmacological inhibition of nNOS yielded similar results. To further test our hypothesis, we studied δ -sarcoglycan-null mice, a model of limb-girdle muscular dystrophy. These mice had minimal sarcolemmal nNOS delocalization and muscle force was less compromised. Annihilation of nNOS did not improve their force either. To determine whether nNOS delocalization itself inhibited force, we corrected muscle disease in dystrophin-null mice with micro-dystrophins that either restored or did not restore sarcolemmal nNOS. Similar muscle force was obtained irrespective of nNOS localization. Additional studies suggest that nNOS delocalization selectively inhibits muscle force in dystrophin-null mice via nitrosative stress. In summary, we have

demonstrated for the first time that nitrosative stress elicited by nNOS delocalization is an important mechanism underlying force loss in DMD.

Stem Cell Therapies I

310. Human Hematopoietic Stem Cells Can Be Functionally Isolated Based on Their Low Intracellular Reactive Oxygen Species (ROS)

Activity

Brian Ichwan,¹ Cynthia E. Dunbar,¹ Andre Larochelle,¹

¹National Heart Lung and Blood Institute, National Institutes of Health, Bethesda, MD.

The search for novel approaches to isolate human hematopoietic stem cells (HSCs) has been a central question for functional stem cell studies and for the development of clinical applications, including gene therapy. Various combinations of antibodies directed to cell surface markers have been used to isolate human HSCs but these protocols result in poor enrichment or require multiple complex steps. Recently, a simple functional approach to enrich for murine HSCs has been described based on low levels of intracellular reactive oxygen species (ROS) (Blood 110: 3056, 2007). Long term HSCs are believed to reside predominantly in the osteoblastic niche, the lowest end of an oxygen gradient within the bone marrow (BM), to minimize the oxidative stress from ROS. We hypothesized that a low intracellular level of ROS (ROSlow), in contrast to a high level of ROS (ROShigh), could select for human HSCs in G-CSF mobilized peripheral blood (MPB) and BM samples obtained from healthy volunteers. Unfractionated MNCs or pre-enriched populations of CD34+ cells were incubated with the cell permeable fluorescent ROS indicator DCF-DA and total ROSlow/ROShigh populations as well as CD34+ or CD34+/CD38- ROSlow/ROShigh cells were isolated by FACS. The ROSlow and ROShigh populations were compared in CFU assays, cell cycle analyses, flow studies and *in vivo* reconstitution in immune-deficient (NSG) mice. Cell cycle analysis revealed a higher proportion of ROSlow BM MNC in the G0 phase of the cell cycle (9.6%) compared to the ROShigh fraction (0.8%), consistent with the more quiescent nature of the ROSlow BM cells. In CFU assays, fewer ROSlow BM CD34+ cells-derived colonies (30 CFU/1000 cells plated) were generated compared to the ROShigh fraction (185 CFU/1000 cells plated), suggesting a depletion of more mature progenitors in the ROSlow population. We estimated the frequency of CD34+CD38- ROSlow cells at 9 in 3x10⁶ BM cells. Given a frequency of long-term HSCs in the BM of 1 in 3x10⁶ as previously calculated in limiting dilution transplantation studies, 1 in 9 CD34+CD38-ROSlow may have long-term repopulating capacity. Transplantation of as few as 30 CD34+CD38-ROSlow BM cells resulted in 0.9% human cell engraftment in one NSG mouse two months after transplantation compared to less than 0.1% engraftment in a mouse transplanted with 30 CD34+ CD38-ROShigh BM cells. In contrast to BM cells, cell cycle and CFU assays revealed no significant difference between the ROSlow and ROShigh MPB CD34+ cell population. The frequency of CD34+CD38- cells was also comparable in the ROSlow (54%) and ROShigh (42%) MPB CD34+ cells. When transplanted into NSG mice, ROSlow and ROShigh MPB CD34+ cells gave rise to similar human cell engraftment 8 weeks after transplantation. ROS levels in MPB samples were found to be increased compared to BM cells, suggesting that the five day period necessary for HSC mobilization by G-CSF may have led to significant intracellular ROS accumulation in HSCs, preventing their selection using this functional approach. Our data indicate that primitive human HSCs that reside in a low-oxygen milieu of the bone marrow can be functionally enriched based on their lower levels of ROS.

311. Differentiation of Diabetic Patient-Specific iPS Cells into Insulin-Secreting Cells

Tayamma Thatava,¹ Karen Squillace,¹ Adam Armstrong,² Seiga Ohmine,¹ Yogish Kudva,² Yasuhiro Ikeda.¹

¹Molecular Medicine, Mayo Clinic, Rochester, MN;

²Endocrinology, Mayo Clinic, Rochester, MN.

The prevalence of type 1 and type 2 diabetes (T1D and T2D) is increasing in an epidemic fashion worldwide. The induced pluripotent stem (iPS) cell technology enables derivation of patient-specific pluripotent stem cells from non-embryonic source. Successful differentiation of iPS cells into functional islet-like cells could realize the urgent goal of customized islet regeneration and autologous iPS-based cell therapy for T1D and a subset of T2D patients. Recently, we used verified iPS clones and demonstrated that pancreatic endoderm inducer ILV and beta cell mass enhancer GLP-1 can facilitate efficient iPS differentiation into glucose-responsive, insulin-producing islet-like cells. However, the influence of clinical history and medical treatments on iPS derivation and subsequent pancreatic differentiation remains elusive. Here, we examined the feasibility of iPS derivation from adult T1D, elderly T2D and non-diabetic patients. Skin-derived keratinocytes, propagated in an animal component-free condition, were reprogrammed by lentiviral vectors expressing four stemness factors (OCT4, SOX2, KLF4 and c-MYC). Efficient reprogramming of keratinocytes into iPS cells was associated with induction of endogenous pluripotency markers, telomere elongation and dynamic morphological changes including the appearance of immature mitochondria with unorganized cristae. Upon spontaneous differentiation through embryoid body formation, derived iPS cells were differentiated into ectoderm, endoderm and mesoderm lineages, verifying the pluripotency of the iPS clones. Activin A and Wnt 3a treatment successfully guided all clones into SOX17- and FOXA2-positive definitive endoderm cells, while induction with FGF10 and all-trans retinoic acid resulted in PDX1 positive pancreatic progenitor cells and maturation in presence of GLP-1 led to the generation of insulin-secreting cells. Clonal variations in differentiation propensities were evident among iPS clones. Transplantation of iPS-derived pancreatic endoderm cells into kidney capsule of SCID-beige mice repeatedly resulted in teratoma formation. We are currently testing whether patient-specific iPS clones can be differentiated into insulin-producing cells *in vitro* and *in vivo*.

312. Overexpression of CXCR4 in Purified Hematopoietic Stem Cells Led to Poor Peripheral Reconstitution with Impaired Marrow Release of Progenitor Cells: Implications in Clinical Transplantation

Chen Yi Lai,¹ Sachie Suzuki,¹ Motohito Okabe,¹ Satoshi Yamazaki,² Masafumi Onodera,³ Makoto Otsu,¹ Hiromitsu Nakauchi.¹

¹Division of Stem Cell Therapy, Center for Stem Cell Biology and Regenerative Medicine, Institute of Medical Science, University of Tokyo, Tokyo, Japan; ²Nakauchi Stem Cell and Organ Regeneration Project, Japan Science Technology Agency, ERATO, Tokyo, Japan; ³Dept of Human Genetics, National Center for Child Health and Development, Tokyo, Japan.

Background/Aims: Hematopoietic stem cell (HSC) transplantation has been proved useful for the cure of various disorders, but the low level engraftment often limits its efficacy. It has been reported that overexpression of CXCR4 on human CD34+ progenitor cells increases their response to stromal-derived factor 1 (SDF-1) leading to better repopulation upon transplantation into NOD/SCID mice. However, since recent studies demonstrated that SDF1 likely arrests the cycling of murine HSCs, we sought to test whether forced expression of CXCR4 in a highly purified HSC population would

also lead to better transplantation outcomes. Methods/Results: We purified and used a CD34-c-Kit+Sca-1+Lineage maker- (CD34-KSL) population of C57BL/6 mice as stem cell source. Overexpression of wild-type (wt)- or Δ C-terminal truncated type (Δ C)-CXCR4 in HSCs by retroviral gene transfer was achieved and confirmed by flow cytometry analysis, which showed correlation of surface CXCR4 expression with EGFP intensity, a maker of transgene expression. We sorted HSCs overexpressing wt- or Δ C-CXCR4 and tested their *in vivo* long-term repopulation potency in a competitive repopulation assay. As expected, recipients of HSCs expressing high levels of Δ C-CXCR4 showed WHIM-syndrome-like features: poor repopulation in PB with enhanced BM retention of progenitors in donor cell compartments. Surprisingly, overexpression of wt-CXCR4 in HSCs also recapitulated WHIM-like phenotype in our murine system. Detailed analysis revealed enhancement in *in vitro* cobblestone-area forming ability and *in vivo* marrow repopulation potential early after transplantation (~3 weeks) in HSCs overexpressing either wt- or Δ C-CXCR4, indicating that reconstitution failure occurred at later stages after transplantation. Cell cycle analysis indicated that high expression of these molecules likely induces cell cycle retardation, suggesting detrimental effects on HSC repopulation resulting from supraphysiological levels of CXCR4 signal enhancement. Conclusions: In contrast to general understanding regarding roles of this receptor, our data demonstrated that overexpression in purified HSCs of CXCR4, even with its wild-type form, may not benefit transplantation outcomes, thus providing important implications into clinical HSC manipulation. Experiments are in progress to test what is a precise mechanism underlying observed detrimental effects of CXCR4 overexpression on purified HSCs.

313. Knockdown of p21^{Cip1/Waf1} Enhances Proliferation, the Expression of Stemness Markers and Osteogenic Potential in Human Mesenchymal Stem Cells

Tu-Lai Yew,^{1,3} Chih-Chien Tsai,^{2,3} Fang-Yao Chiu,⁴ Shih-Chieh Hung.^{1,3,4}

¹Faculty of Medicine, National Yang-Ming University, Institute of Clinical Medicine, Taipei, Taiwan; ²Faculty of Medicine, National Yang-Ming University, Institute of Pharmacology, Taipei, Taiwan; ³Taipei Veterans General Hospital, Stem Cell Laboratory, Department of Medical Research and Education, Taipei, Taiwan; ⁴Taipei Veterans General Hospital, Orthopaedics and Traumatology, Chest Medicine, Taipei, Taiwan.

Mammalian aging of many tissues is associated with a decline in the replicative and functional capacity of somatic stem cells. Understanding the basis of this decline is a major goal of aging research. Human bone marrow-derived multipotent stromal cells (MSCs) have been applied in the treatment of fracture nonunion. Clinical application of MSCs requires abundant cells that can be overcome by *ex vivo* expansion of cells, but often at the expense of stemness and differentiation potentiality. We first demonstrated that late-passage MSCs exhibited decreased proliferation capacity, reduced expression of stemness markers such as Oct-4 and Nanog, and deterioration of osteogenic potential. Further, late-passage MSCs showed increased expression of p21^{Cip1/Waf1} (p21), an inhibitor of the cyclin-dependent kinase. Knockdown of p21 by lentivirus-mediated shRNAs against p21 in late-passage MSCs increased the proliferation capacity, the expression of Oct-4 and Nanog, and osteogenic potential compared to cells transduced with control shRNA. More importantly, reduction of p21 expression in MSCs enhanced the bone repair capacity of MSCs in a rodent calvarial defect model. Knockdown of p21 in MSCs also increased the telomerase activity and telomere length, did not show chromosomal abnormalities or acquire transformation ability. Therefore, these data successfully demonstrate the involvement of senescence gene in the expression of stemness markers and osteogenic potential of MSCs.

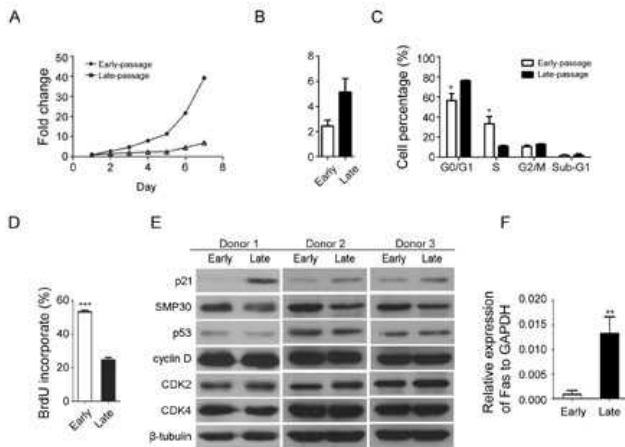

Figure 1

Late-passage MSCs showed decreased proliferation, and increased senescence. Early and late-passage MSCs were seeded at 100/cm² and cultured for 7 days. (A) MTT assay was performed at indicated period and data are shown as fold change of cell number. (B) Early- and late-passage MSC were stained with senescence-associated b-galactosidase (SA-b-gal). Late-passage MSC increase in the percentage of b-gal expression compared with early-passage MSC. Day 0 was set as 1. At 4 days of culture, (C) cell cycle distribution and (D) BrdU incorporation were analyzed by flow cytometric analysis following BrdU flush for 18 hrs. (E) Western blot analysis of early- and late-passage MSCs. Results shown are representative of three independent experiments. (F) Real-time quantitative reverse transcription-PCR analysis for marker of senescence Fas gene. After expansion the expression of senescence-related genes significantly increases in late-passage MSCs. Asterisks indicate significant differences (**p*<0.05, ***p*<0.01 between early- and late-passage).

314. Pre-Clinical Evaluation of Zinc Finger Nuclease-Modified Mobilized Hematopoietic Stem Cells in NSG Mice

Ursula Hofer,¹ Jill E. Henley,¹ Kathrin A. Burke,¹ Nathalia Holt,¹ Lijing Li,² David L. DiGiusto,² John A. Zaia,² Philip D. Gregory,³ Michael C. Holmes,³ Paula M. Cannon.¹

¹Keck School of Medicine, University of Southern California, Los Angeles, CA; ²Beckman Research Institute, City of Hope National Medical Center, Duarte, CA; ³Sangamo BioSciences, Inc., Richmond, CA.

Introduction: Recent advances in genome engineering technologies using zinc finger nucleases (ZFNs) are allowing the efficient genetic manipulation of human hematopoietic stem cells (HSC). However, HSC are sensitive to *ex vivo* manipulations and can rapidly lose their stem cell characteristics, so that validation of the stem cell potential of modified HSC is an important pre-clinical consideration. We have established a protocol to reliably test the overall engraftment and lineage differentiation potential of human HSC from various sources, including G-CSF mobilized peripheral blood, using humanized NOD/SCID-IL2Rgamma null (NSG) mice. **Methods/Results:** NSG mice were transplanted with HSC from mobilized peripheral blood and fetal liver, purified as the CD34⁺ cells. Both neonatal and adult animals were transplanted and sampling protocols were optimized to enable detection of any negative effects of gene modifications. In contrast to fetal HSC, which engrafted both neonatal and adult mice well, we found that mobilized HSC engrafted neonates inconsistently and only at low levels, even at doses up to 2 million CD34⁺ cells. In contrast, adult NSG mice were excellent recipients of mobilized HSC, giving rise to all major lineages, including T cells. **Conclusions:** Human

HSC isolated from different sources exhibit different engraftment characteristics when transplanted into neonatal or adult NSG mice. For clinically relevant mobilized peripheral blood HSC, we found that transplantation of adult NSG mice was the most useful model, supporting multi-lineage engraftment for up to 5 months. We also observed the development of T cells in these animals, without the need to supplement the mice with IL7. This model therefore allows the evaluation of the engraftment characteristics of gene-modified HSC, including those treated with ZFNs.

315. Establishment of Human iPS Cell Lines Heterozygous for Genes in the Non-Homologous End-Joining Pathway by Using Helper-Dependent Adenoviral Vectors

Keiichiro Suzuki,¹ Yuka Hirabayashi,¹ Emi Aizawa,¹ Yuzuru Iwanaga,¹ Ayako Tokumitsu,¹ Ko Mitani.¹

¹Research Center for Genomic Medicine, Saitama Medical University, Hidaka, Saitama, Japan.

Increasing the efficiency of gene targeting in human induced pluripotent stem cells (hiPSCs) is essential to improve both the experimental and therapeutic potential of these cells. Although gene targeting by electroporation has been routinely used in mouse embryonic stem cells (mESCs), its application in hiPSCs has been limited. By using high-capacity helper-dependent adenoviral vector (HDAdV), we previously reported ~45% of relative targeting efficiencies at the HPRT1 locus in hESC lines. In this study, we expanded the general applicability of HDAdVs to both gene knock-out and knock-in at both transcriptionally active (KU80, LIG1, LIG3) and inactive (motor neuron-specific HB9) loci in hiPSCs. At these and the HPRT1 loci, 3 to 59% of vector chromosomal integration (G418-resistant colonies) were found at the target loci, judged by PCR analyses, indicating a strong affinity of the gene targeting cassettes delivered by HDAdVs with homologous chromosomal sequences. After detailed Southern analyses with multiple probes and enzymes, 68-100% of these site-specific integration events were confirmed to be mediated by accurate homologous recombination (HR) without additional ectopic integrations, resulting in overall gene targeting efficiencies of 7-81% without detectable effects on undifferentiated state and pluripotency. The high fidelity and potential safeness of HDAdV-mediated gene targeting suggests that they might be especially useful for therapeutic applications. KU80, LIG1 and LIG3 proteins function in the non-homologous end-joining (NHEJ) and its backup pathway. It is known that both HR and NHEJ protein complexes access DNA double-strand breaks and compete with each other. It was reported that KU80 heterozygous mutants in two human somatic cell lines, HCT116 and NALM-6, showed haploinsufficiency such as growth defects, mutagen sensitivities and telomere shortening, as well as elevated frequencies of adeno-associated virus (AAV)-mediated gene targeting. By using HDAdV, the KU80 heterozygous hiPSCs were obtained at high frequencies of 81% and 55% of drug-resistant colonies with and without the negative selection, respectively. Unlike heterozygous mutants of LIG1 and LIG3, which showed sensitivities to a reagent causing DNA single-strand break, the KU80 heterozygous hiPSCs did not show any obvious phenotypes. Furthermore, increase in gene targeting efficiency using AAV was not observed in these heterozygous mutants. These results suggest functional differences of KU80 in hiPSCs and other human somatic cell types.

316. Combination Sox Transcription Factor and Tgf-Beta Gene Transduction Drive Pre-Transplant Chondrogenesis in Adult Marrow Derived Stromal Cells

Alan J. Nixon,¹ Jan-Jan Liu,¹ Michael S. Scimeca,¹ Ashlee E. Watts.¹

¹Comparative Orthopaedics Laboratory, Cornell University, Ithaca, NY.

Cartilage trauma is a frequent injury in sports events. Cell based therapies including ACI and stem cell implant have been used to improve repair and avoid OA. Mesenchymal stem cell (MSC) therapies have been proposed as a mechanism to provide cells capable of rebuilding cartilage. This study describes the development and analysis of viral based and Sleeping Beauty transposable element constructs, containing Sox 5, 6 or 9, and TGF- β 1 and β 3. Sequential transduction of various Sox transcription factors followed by TGF- β exposure may provide the stable chondrogenic transformation necessary to establish a hyaline like cartilage repair. *Sox and TGF- β constructs*. Full length equine Sox 5,6 and 9, and TGF-B3 were subcloned into adenovirus and the Sleeping Beauty (SB) pT2HB- SB transposon plasmid. *Cell Transduction* Cultured HeLA and 293 cell lines and equine MSCs were transduced with Ad-Sox or AdTGF to evaluate transgene expression and induction of chondrogenesis in MSC monolayer, pellet cultures, and transwell 3D cultures. For study of integrating gene effects, similar cell types were electroporated with an equimolar mix of SB-Sox or SB-TGF. Infected lines was verified by fluorescence microscopy. Genomic integration was confirmed by PCR of genomic DNA for the SB-Sox or TGF construct. Expression was assessed in SB-Sox and wild-type cells. Examination of transwell inserts and pellet cultures was done at 21 days. *Gene Expression Analysis*. RNA was isolated from monolayers at 12 days and from pellet and transwell cultures at 14 or 21 days, and assessed by qPCR for transgene construct and markers of chondrogenesis including coll type II and X, aggrecan and link. *Histology*. MSCs from 3D culture at 2 and 3 wks were sectioned for coll II and X immunofluorescence studies. Ad-Sox and AdTGFB3 transduced 293 and MSCs at >95% efficiency. Combination of AdSox5+9, Sox6+9, Sox 5+6, Sox5/6/9 and Sox 5/6/9+TGF-B3 all gave high GFP efficiencies, without sign of toxicity. Culture of MSCs in 3D transwell inserts indicated persisting high transduction efficiency. GFP expression slowly declined over 14 days in all cultures. Combination of Sox and TGF genes in 14 day pellet culture showed induction of collagen type II, with the most profound formation of type II in Sox5/6/9+TGFB3 3D cultures.

Coll II formation in Sox and TGF-B3 transduced pellet culture

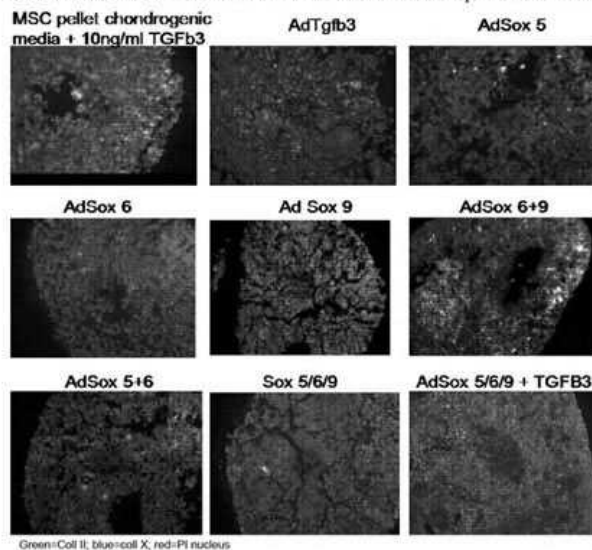

SB transduced cells and longer term cultures are being further characterized by qPCR. Based on this study, Sox TFs induced significant collagen type II and type X formation. Addition of TGF-B3 further increased deposition of Collagen type II and ultimately may be the ideal combination for MSC chondrogenesis. However, the preponderance of collagen type II in AdTGFB3 infected cultures, with little collagen type X, also suggests Sox TFs may not be appropriate for MSC pre-implantation articular cartilage treatment, where type X is not appropriate.

317. Generation of Induced Pluripotent Stem (iPS) Cells Using Helper-Dependent Adenoviral Vectors

Nunzia Pastore,¹ Rosa Maria Sepe,¹ Pasquale Piccolo,¹ Donna Palmer,² Philip Ng,² Nicola Brunetti-Pierri.¹

¹Telethon Institute of Genetics and Medicine, Naples, Italy;

²Molecular and Human Genetics, Baylor College of Medicine, Houston.

Patient-specific induced pluripotent stem (iPS) cells have great potential for regenerative medicine and disease modeling. The iPS cells have been generated from mouse and human somatic cells using both viral (retrovirus and lentivirus) and nonviral vectors (plasmid DNA) expressing specific combinations of transcription factors. A major concern for clinical application of viral vector-derived iPS cells is the potential degeneration of the reprogrammed and transplanted cells related to the expression of oncogenes by retroviral vectors which may themselves cause cancer by integrating into the genome. Transfections with non-integrating DNA plasmids expressing the reprogramming factors have been used to overcome this problem. However, this method is hampered by low efficiency of cell reprogramming. We have investigated non-integrating helper-dependent adenoviral (HDAd) vectors for generation of iPS cells. We have constructed an HDAd vector encoding the four reprogramming factors (OCT4, SOX2, KLF4, and c-MYC) under the control of the ubiquitous CMV promoter to infect mouse embryonic and adult fibroblasts from the Nanog-GFP mice, expressing the GFP reporter gene under the control of the Nanog embryonic stem cell promoter. As shown by the appearance of GFP positive cells with typical morphology and by alkaline phosphatase staining, HDAd infection resulted in generation of iPS cells by 7 days post-infection, which is earlier than previously reported methods. In conclusion, HDAd vectors may provide an efficient tool, not based on vector integration, for generating patient-specific iPS for regenerative medicine and disease modeling.

318. Cationic-Liposome-Mediated CXCR4 Gene Delivery into Hematopoietic Stem/Progenitor Cells: Implications for Clinical Transplantation

Peng Xu,^{1,2} Jie Chen,^{1,2,3} James Xing,^{4,5} Hilal Gul.^{1,3}

¹Department of Biomedical Engineering, University of Alberta,

Edmonton, AB, Canada; ²National Institute for Nanotechnology,

Edmonton, AB, Canada; ³Department of Electrical and Computer Engineering, University of Alberta, Edmonton, AB, Canada;

⁴Department of Laboratory Medicine & Pathology, University

of Alberta, Edmonton, AB, Canada; ⁵Cross-Cancer Institute,

Edmonton, AB, Canada.

Stromal-cell derived factor (SDF)-1a/CXCL12 and its cognate receptor, CXCR4, play crucial role in the trafficking of normal hematopoietic stem/progenitor cells (HSPC) and their homing/engraftment in the bone marrow. Consequently, modulation of CXCR4 expression is a potential target for improving the efficiency of HSPC transplantation. It has been shown using the efficient viral gene transfer technique that CXCR4 overexpression on human CD34⁺ HSPC significantly improves their engraftment of murine bone

marrow and spleen. However, past clinical trials with gene therapy have revealed some safety concerns related to the immunogenicity of the viral carriers due to the random integration of viral genes into the host genome. Therefore, a system of non-viral, efficient and safe CXCR4 gene delivery into HSPC is urgently needed to improve clinical transplantation. In this work, we investigated the efficacy and cytotoxicity of *in vitro* cationic-liposome-mediated nonviral CXCR4 gene transfer into HSPC. The cationic-liposome/DNA complexes were transfected into CD34⁺ HSPC from cord blood and the models of immature hematopoietic cells expressing CD34 antigen namely leukemia cell lines KG-1a and KG-1. Transfection efficiency was determined by flow cytometric analysis (FACS) 6, 12, 24, 48 h after the transduction. Moreover, the viability of cells after the transduction was analyzed by trypan blue exclusion assay. We found that the cationic-liposome-mediated transfection efficiency of HSPC grown in suspension is very low (~5%), whereas adhesion of HSPC to plates by polylysine significantly enhances transfection efficiency. Under these conditions we found that the transfection is achieved in 25% for KG-1a and KG1 cells and 20% for HSPC. Furthermore, the viabilities of transduced HSPC were not significantly altered. These results suggest that the efficient and safe cationic-liposome-mediated CXCR4 gene delivery technique to overexpress CXCR4 on HSPC has great potential for improving transplantation efficiency.

319. Development of Polyamidoamine Dendrimer-Conjugated Quantum Dots for Tracing Primary Cultured Mesenchymal Stem Cells in Mice

Yuriko Higuchi,^{1,2} Wu Can,¹ Shigeru Kawakami,¹ Fumiyooshi Yamashita,¹ Mitsuru Hashida.^{1,3}

¹Graduate School of Pharmaceutical Sciences, Kyoto University, Kyoto, Japan; ²PRESTO, Japan Science and Technology Agency (JST), Kawaguchi, Japan; ³Institute for Integrated Cell-Material Sciences (iCeMS), Kyoto University, Kyoto, Japan.

For the development of cell-based therapy, both disposition and differentiation of transplanted cells is directly related with therapeutic effects. In order to evaluate transplanted stem cell distribution, *in vivo* imaging is an attractive tool to obtain the real-time information of the disposition of target cells. Quantum dots (QDs) possess advantages of optical properties for imaging, involving remarkable resistance to photo bleaching, high fluorescence efficiency, etc. However, the cellular uptake of QDs by stem cells is extremely low. Furthermore, fluorescence intensity of the QDs decreases as pH decreases; therefore fluorescence intensity of QDs decreased non-reversibly after QDs moved into endosomes or lysosomes with a pH of around 4.0-5.0. In this study, we developed QDs for labeling stem cells with strong fluoresces for long period and tracing stem cells in mice in video rate. Polyamidoamine (PAMAM) dendrimer has a large number of amine groups, which promote cellular uptake through electrostatic interaction with cell membrane. Furthermore, it has strong buffering capacity that could promote endosomal escape and release into the cytoplasm. Therefore, we developed PAMAM dendrimer conjugated QDs. There were about 10 PAMAM dendrimers conjugated with a QD. After mesenchymal stem cells isolated from C57BL/6 mice were cultured with PAMAM dendrimer QD conjugates or QDs for 13 h at 10 nM, strong fluorescence signal was observed in almost all of PAMAM dendrimer QD conjugates treated-cells, although only weak fluorescence signal was observed some of QDs treated-cells. In order to comparing intracellular distribution between PAMAM dendrimer QD conjugates and QDs, endosomes were labeled with Transferrin-Alexa Fluor 488 conjugates. Intracellular distribution of QDs was almost coincident with that of Transferrin-Alexa Fluor 488, suggesting that almost QDs were entrapped into endosomes. On the other hand, fluorescence signal of the PAMAM dendrimer QD conjugates were partially observed outside endosomes, suggesting that PAMAM dendrimer QD conjugates partially escaped from endosome.

Although fluorescence signal in cells were significantly decreased in the cells labeled with QDs, fluorescence signal was slightly decreased in the case of PAMAM dendrimer QD conjugates on the 3rd day from the day when culture medium was changed to QDs free medium. After injection of MSCs labeled with QD or PAMAM dendrimer QD conjugates into mice, the number of cells with fluorescent signal was decreased in the case of QDs-labeling, but the number of cells with fluorescent signal was kept in the case of PAMAM dendrimer QD conjugates-labeling. These results suggested that modification of QDs by PAMAM dendrimer could retain fluorescence intensity of QDs in MSCs. Finally, we could observe QD labeled-mesenchymal stem cells moving on the flow of blood in video rate imaging using confocal microscopy. We could observe mesenchymal stem cells in long term and real time in mice using PAMAM dendrimer QD conjugates.

320. Optical, Nuclear and Magnetic Resonance Imaging for Stem Cell Tracking In Vivo

Gadi Pelled,^{1,2} Wafa Tawackoli,² Dmitriy Sheyn,² Olga Mizrahi,¹ Nadav Kimelman-Bleich,¹ Yoram Zilberman,¹ Ilan Kallai,¹ Lior Ben Assaf,¹ Susan Su,² Anthony Oh,² Xiaoyu Da,² Gevorg Karapetyan,³ Rex Moats,³ Uzi Eliav,⁴ Gil Navon,⁴ Zulma Gazit,^{1,2} Dan Gazit.^{1,2}

¹Hebrew University of Jerusalem, Jerusalem, Israel; ²Surgery-Regenerative Medicine Institute, Cedars-Sinai Medical Center, Los Angeles; ³Childrens Hospital, Los Angeles, CA; ⁴Tel Aviv University, Tel Aviv, Israel.

Introduction: Determining the fate and function of stem cells after implantation plays a pivotal role in the development of new therapeutic applications in regenerative medicine. In the current study we used lentiviral vectors encoding for various reporter genes and micron-sized iron oxide particles (MPIOs) to label mesenchymal stem cells (MSCs). Labeled cells were implanted in rodents and monitored for survival and osteogenic differentiation using bioluminescence imaging (BLI), microsingle photon emission computed tomography/CT (SPECT/CT), or micromagnetic resonance imaging (MRI). We demonstrate that we are able to track tissue-specific differentiation of MSCs using optical, nuclear, and MR-based imaging modalities in various implantation models. Methods: MSCs were labeled with MPIOs and injected into rat degenerated coccygeal intervertebral discs (IVD). In addition, MSCs were transduced with a lentivector encoding for GFP and Luciferase. The cells were injected into NOD/SCID mice via the tail vein and BLI was used to track the cells. MSCs were transduced as well with a lentivector encoding for the human sodium iodide symporter (hNIS) gene and implanted subcutaneously in mice. We used SPECT/CT to detect uptake of ^{99m}Tc-pertechnetate by the implanted cells. MSCs were also transduced with lentivectors encoding for either Luc or hNIS genes driven by the human osteocalcin (hOc) promoter. Expression of the reporter gene was evaluated *in vitro* in conditions of osteogenic induction. MSCs transduced with lenti-hOc-Luc were further infected with adeno- BMP2 vector and implanted in mice. BLI was performed to quantify osteogenic activity in this model. Results: MPIO-labeled cells were tracked in the rat IVD up to 25 days post-implantation. In mice injected systemically with Lenti-GFP-Luc labeled cells, the bioluminescent image was seen in the lungs 1 hour after injection and lasted for 48 hours. Lenti-hNIS labeling was verified using immunostaining Figure 1 -A&B.

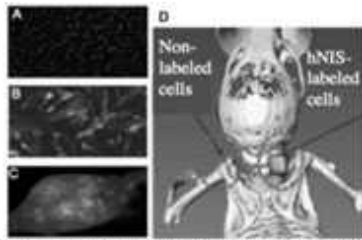

Figure 1. A & B: Immunocytochemical staining for hNIS expression of control MSCs (nuclei stained with DAPI) (A) and MSCs infected with lenti-hNIS (green) (B). C: MSCs labeled with lenti-hOC-hNIS were cultured in osteogenic media for 13 day and then stained with an anti-hNIS antibody (green). D: In vivo μ SPECT imaging of lenti-hNIS-labeled MSCs implanted in a NOD/SCID mouse. Note the uptake of radioisotope by labeled cells (right) while native cells (left) do not show any uptake.

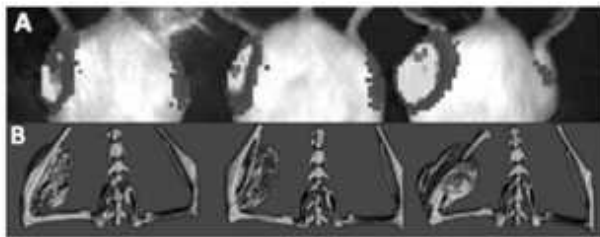

Figure 2. MSCs were labeled with the lenti-hOC-Luc vector. The cells were then infected with adeno-BMP2 vector to induce osteogenesis. The osteogenic cells were injected into the right limbs of NOD/SCID mice, whereas labeled nonosteogenic cells were injected into the left limbs. BLI was performed on Day 7 (A), and the μ CT analysis confirmed bone formation in the right limbs only (B).

In vitro, cells labeled with lenti-hOC-hNIS stained positively [Figure 1C]. The graft of lenti-hNIS labeled cells demonstrated radioisotope uptake in vivo. [Figure 1D] Luciferase expression was detected only in lenti-hOC-Luc labeled cells that also expressed BMP2. [Figure 2] Conclusions: We were able to monitor implanted stem cells in a minimally invasive, longitudinal, and quantifiable manner. The use of functional reporter vectors allows us to monitor cell function as well as cell fate using different imaging modalities, at various implantation sites.

321. Generation of Insulin-Producing Cells from PDX-1 Gene-Modified Human Umbilical Cord Mesenchymal Stem Cells

Dongmei He,¹ Juan Wang,² Yangjun Gao.³

¹Institute of Hematology, Medical College, Jinan University, Guangzhou, China; ²Institute of Hematology, Medical College, Jinan University, Guangzhou, China; ³Institute of Hematology, Medical College, Jinan University, Guangzhou, China.

Mesenchymal stem cells (MSCs) have significant advantages over other stem cell types, and greater potential for immediate clinical application. MSCs would be an interesting cellular source for treatment of type 1 diabetes. In this study, we investigated MSCs from human umbilical cord were differentiated into functional insulin-producing cells in vitro. MSCs were isolated from human umbilical cord. The expressions of cell surface antigens were detected by flow cytometry. After induction in an adipogenic medium or an osteogenic medium, the cells were observed by oil red O staining, alkaline phosphatase staining. Recombinant adenovirus carrying pancreatic and duodenal homeobox factor 1 (Pdx1) gene was constructed and the MSCs were infected by the recombinant adenovirus and combined with several inducing factors for differentiation into islet β cells. The expression of the genes related to islet β cells was detected by immunocytochemistry, RT-PCR and Western blot.

Insulin and C peptide secretion were assayed. Our results indicated that the morphological and immunophenotype of MSCs from human umbilical cord were similar to those present in human bone marrow. These MSCs could be differentiated into osteocytes and adipocytes. After induction by recombinant adenovirus vector with combined with induction factors, MSCs were aggregated and presented islets-like bodies. Dithizone staining of these cells was positive. The genes' expression related to islet β cells was found. After induction, insulin and C-peptide secretion in the supernatant were significantly increased. In conclusion, PDX-1 gene-modified human umbilical cord mesenchymal stem cells could be differentiated into insulin-producing cells in vitro.

322. New Adipose Tissue Formation by Human Adipose-Derived Stem Cell with Hyaluronic Acid Gel

Shu Hung Huang,^{1,3} Sheng Hua Wu,² Sin Daw Lin,¹ Chung Sheng Lai.¹

¹Division of Plastic Surgery, Department of Surgery, Kaohsiung Medical University Hospital, Kaohsiung, Taiwan; ²Department of Anesthesiology, Kaohsiung Medical University Hospital, Kaohsiung, Taiwan; ³Division of Plastic Surgery, Department of Surgery, Kaohsiung Municipal Ta-Tung Hospital, Kaohsiung, Taiwan.

Background: Currently available injectable fillers have demonstrated limited durability. This report proposes the in vitro culture of human adipose-derived stem cells (hASCs) on hyaluronic acid (HA) gel for in vivo growth of de novo adipose tissue. **Methods:** For in vitro studies, hASCs were isolated from human adipose tissue and were confirmed by multi-lineage differentiation and flow cytometry. hASCs were cultured on HA gel. The effectiveness of cell attachment and proliferation on HA gel was surveyed by inverted light microscopy. For in vivo studies, suspensions of HA gel containing hASCs were subcutaneously injected into the subcutaneous pocket in the back of nude mice (n=6). At eight weeks post-injection, the implants were harvested for histological examination by hematoxylin and eosin (H&E) stain and by Oil-Red O stain. The human-specific Alu gene was examined. **Results:** hASCs were well attachment and proliferation on the HA gel. In vivo grafts showed well-organized new adipose tissue on the HA gel by histologic examination and Oil-Red O stain. Analysis of neo-adipose tissues by PCR revealed the presence of the Alu gene. This study demonstrated not only the successful culture of hASCs on HA gel, but also their full proliferation and differentiation into adipose tissue. **Conclusions:** The efficacy of injected filler could be permanent since the reduction of the volume of the HA gel after bioabsorption could be replaced by new adipose tissue generated by hASCs. This is a promising approach for developing a long lasting soft tissue filler.

323. Mobilization and Enrichment of Mesenchymal Stem Cells In Vivo Augments Bone Healing in a Mouse Model of Segmental Bone Defect

Sanjay Kumar,¹ Selvarangan Ponnazhagan.²

¹Christian Medical College, Vellore, Tamil Nadu, India; ²Pathology, The University of Alabama at Birmingham, Birmingham, AL.

Although the number of mesenchymal stem cells (MSC) is sufficient to maintain homeostasis, in osteopenic pathology, aggravated osteoclast activity or insufficient osteoblast numbers ensues, affecting normal bone remodeling. Most of the currently available therapies are anti-resorptive with limited osteogenic potential. Thus, amplification of endogenous stem cells may provide an alternative approach in these conditions. The present study determined the potential of

MSC mobilization *in vivo*, using combinations of cytokines with the CXCR4 antagonist AMD3100 in a mouse model of segmental bone defect. Results indicated that the combination of IGF-1 and AMD3100 provided significant augmentation of bone growth as determined by DXA, micro-CT and histomorphometry. Further, characterization of MSC isolated from mice treated with IGF-1 and AMD3100 indicated Akt/PI3K, MEK1/2-Erk1/2 and smad2/3 as key signaling pathways mediating this effect. These data indicate the potential of *in vivo* stem cell mobilization as a novel alternative for bone healing.

324. Fully Pluripotent Patient-Specific Induced Pluripotent Stem (iPS) Cells and In Vivo Converted Cells: The Transient Epigenetic Gene Therapy Approach

Roger Bertolotti.¹

¹CNRS, Gene Therapy and Regulation Research, Faculty of Medicine, University of Nice - Sophia Antipolis, Nice, France.

Full pluripotency of mouse induced pluripotent stem (iPS) cells was recently demonstrated using the tetraploid complementation assay, thereby establishing transgenic expression of transcription factors as a bona fide reprogramming technique challenging somatic cell nuclear transfer (SCNT). Importantly, such a genesis of fertile adult iPS mice has shown that few of the former deemed bona fide mouse iPS cells were fully pluripotent. Tetraploid complementation stringency is thus expected to be instrumental in the identification of reprogramming caveats and critical iPS cell markers. Indeed, recent data show that full pluripotency is correlated to the activity of genes from the Dlk1-Dio3 cluster which are frequently aberrantly silenced in mouse iPS cells. Mouse tetraploid complementation should thus translate soon into optimized protocols for the genesis/identification of fully pluripotent human iPS cells, i.e. breakthrough substitutes for current allogenic human embryonic stem (ES) cells and planned patient-specific SCNT-derived ones. Free of the human oocyte scarcity and embryo destruction problems that hamper ES cells, fully pluripotent patient-specific iPS cells should also be free from biased epigenetic reprogramming issues. Their bench-to-bedside translation is thus discussed in light of transgene-free reprogramming protocols aimed at clearing the main safety concern of iPS cell genesis: oncogenic hazards resulting from random integration of reprogramming transgenes into genomic DNA. Reprogramming transgenes being silenced in iPS cells, we are dealing with an epigenetic remodeling process that stands as a perfect target of the transient epigenetic gene therapy arm of our proposed Universal Stem Cell Gene Therapy Platform. This transient epigenetic arm is aimed at long-term transcriptional activation/silencing of endogenous genes through the transient action of promoter-specific siRNAs/sense-antisense RNAs/oligonucleotides (oligos), thereby offering an attractive transgene-free avenue for the genesis of clinical-grade patient-specific iPS cells by direct long-term transcriptional activation of relevant endogenous gene(s) in appropriate somatic cells. Of note, transient epigenetic gene therapy paves also the way to direct *in vivo* conversion of resident cells into therapeutic ones through local delivery of promoter-specific siRNAs/oligos. Transient epigenetic gene therapy is thus discussed in terms of hazard-free reprogramming for ex vivo iPS cell genesis and *in vivo* lineage conversion culminating, possibly, in the ex vivo/*in vivo* programming of a true teratoma-free pluripotent state compatible with a direct therapeutic homing into diseased tissues. Such a pluripotent state might correspond to elusive stem cells identified in adult tissues (Vacanti et al, 2001; Toma et al, 2001; Kucia et al, 2006). This pluripotent state would ideally drive both tissue-specific and multisystemic therapeutic stem cell repopulation dynamics into appropriate niches (long-term engraftment) and tissues (regenerative/basic cell turn-over) both for ex vivo and direct *in vivo* protocols, thereby optimizing the main arms of our proposed universal stem cell gene therapy platform.

325. Benefits of Hypoxic Culture on Bone Marrow-Derived Mesenchymal Stem Cells

Shih-Chieh Hung,^{1,2} Chih-Chien Tsai.^{1,2}

¹Institute of Clinical Medicine, National Yang-Ming University, Taipei, Taiwan; ²Medical Research and Education, Taipei Veterans General Hospital, Taipei, Taiwan.

Oxygen is essential for life, but cultivation of cells is usually performed under 21% O₂. Such a condition does not replicate the hypoxic conditions of normal physiological or pathological status in the body. Recently, we have extensively investigated the effects of hypoxia on bone marrow multipotent stromal cells or mesenchymal stem cells (MSCs). In a long term culture, hypoxia can inhibit senescence, increase the proliferation rate and enhance differentiation potential along the different mesenchymal lineages. Hypoxia also modulates the paracrine effects of MSCs, causing upregulation of various secretable factors, including the vascular endothelial growth factor and interleukin-6. Finally, hypoxia plays an important role in mobilization and homing of MSCs, primarily by its ability to induce stromal cell-derived factor-1 expression along with its receptor, CXCR4. This report further emphasizes that hypoxia is an important factor in all major aspects of stem cell biology, and the mechanism involved in the hypoxic inducible factor-1 (HIF-1) signaling pathway behind these responses is also addressed.

AAV Capsids & Trafficking

326. Adeno-Associated Virus Serotype 9 Uses Galactose as a Cellular Receptor To Transduce Conducting Airway

Christie Bell,¹ Luk Vandenberghe,^{1,2} Peter Bell,¹ Maria P. Limberis,¹ James M. Wilson.¹

¹Gene Therapy Program, Department of Pathology & Laboratory Medicine, University of Pennsylvania, Philadelphia; ²F.M. Kirby Center for Molecular Ophthalmology, University of Pennsylvania, Philadelphia.

Adeno-associated virus serotype 9 (AAV9) efficiently transduces many different target organs, including liver, heart, brain, and lung. However, little is known about the biology and specifically the cellular receptor binding of AAV9. We sought to better understand the binding properties of AAV9 by examining its interaction with cell surface carbohydrate residues. Binding of a panel of AAV serotypes to CHO cells with or without sialic acid showed AAV9 was the only serotype exhibiting enhanced binding to cells devoid of sialic acid. Since terminal sialic acid residues are most commonly attached to galactose residues, we hypothesized that the absence of sialic acid allowed exposure of galactose, enabling AAV9 to use galactose as a cellular receptor for transduction. To test this idea, we first performed a series of *in vitro* studies in CHO cell lines deficient in different carbohydrate biosynthetic enzymes. While AAV9 bound 100-fold more efficiently to cells without sialic acid (Lec-2 cells) than to cells with sialic acid (Pro-5 cells), this binding efficiency dropped 100-fold when AAV9 was added to cells lacking galactose (Lec-8 cells); the AAV2 control bound similarly well to all three cell types. Additionally, competition assays using galactose-binding lectins decreased AAV9 binding and transduction of cells devoid of sialic acid. Finally, enzymatic cleavage studies showed binding and transduction of Pro-5 cells by AAV9 was significantly enhanced by neuraminidase (NA) treatment, which removes sialic acid from the surface, but this enhancement was reversed with subsequent β -galactosidase treatment. We then tested this hypothesis *in vivo* using the mouse lung as a model for AAV9 transduction. Using fluorescently labeled lectins specific for sialic acid (Sambucus nigra lectin; SNA) or galactose (Ricinus communis agglutinin; RCA) we found sialic acid residue staining in both alveolar and conducting airway epithelium, while exposed galactose residues

were only present in the alveolar epithelium. In previous studies, we found AAV9 exclusively targets the alveolar epithelium and not the conducting airway, so we sought to determine if this result was due to the lack of exposed galactose residues. C57Bl/6 mice were administered either AAV9 alone expressing nLacZ (10^{11} GC) or AAV9 co-administered with NA by intranasal (IN) instillation and evaluated for β -gal expression in the lung 21 days later. As expected, the control mice that received AAV9 alone showed transduction only in the alveolar epithelium. Interestingly, mice that received both AAV9 and NA showed both alveolar epithelium transduction and impressive conducting airway transduction. Additionally, we stained the lungs of mice with fluorescently labeled RCA lectin to detect galactose one hour after IN instillation of NA and observed abundant galactose staining on the apical surface of the airway. Taken together, our studies suggest that AAV9 is using galactose as a cellular receptor for transduction, which may aid us in better understanding its biological properties.

327. New Insight into Obstacles to Hematopoietic Stem and Progenitor Cell Transduction with rAAV2 Vectors

Hao-Yuan Jiang,¹ Yiwen Xiang,¹ Bridget Lins,² Angela E. Rivers,¹ Mavis Agbandje-McKenna,² Kirsten A. K. Weigel-Van Aken.¹
¹*Pediatrics, University of Florida, Gainesville, FL;* ²*Biochemistry and Molecular Biology, University of Florida, Gainesville, FL.*

Recombinant adeno-associated virus 2 (rAAV2) vectors are currently in use in several Phase I/II clinical trials. Application could be extended to hematopoietic stem and progenitor cells (HSPC) if remaining obstacles, such as inefficiency of nuclear localization and virion uncoating, can be overcome. HSPC maintain very low levels of reactive oxygen species (ROS) in order to protect their self-renewal potential. We observed in murine embryonic fibroblasts (MEF) that efficient transduction with rAAV2 vectors was dependent on high cellular levels of ROS. To explore this phenomenon, MEF deficient in transcription of genes that function in the anti-oxidant response were used to interrogate the relationship between cellular ROS and rAAV2 transduction. ROS did not affect cellular entry or trafficking of virions nor did ROS-dependent induction of proteasomal capsid protein degradation occur. Rather, the transient nature of an interaction between one of the major ER-resident chaperone proteins and rAAV2 capsids in the context of high cellular ROS levels facilitated vector performance and siRNA-mediated down-modulation of the chaperone promoted rAAV2 transduction. To discern between effects on cellular signaling pathways from direct effects on rAAV2 capsids, structural studies under different redox conditions in vitro were performed. Electron microscopy revealed morphological changes in the rAAV2 capsid structure in the presence and absence of the ER chaperone protein and under different redox conditions, leading to either enhanced or reduced/absent negative stain penetration, respectively. Capsid mutagenesis identified residues involved in the redox sensitivity and corroborated a function of redox modifications in the structural integrity of rAAV2 capsids. The role of cellular redox in rAAV2 transduction of murine hematopoietic stem and progenitor cells was assessed using pharmacological elevation of ROS levels within the endoplasmic reticulum (ER). Under these conditions, transduction efficiency could be increased ~6-fold as observed 7 days after HSPC culture in vitro and ~60-fold following bone marrow transplantation in vivo. Studies on vector trafficking and capsid integrity in HSPC under reducing and oxidizing conditions are under way. Taken together these data indicate that low ROS conditions in HSPC prevent efficient transduction with rAAV2 vectors potentially through inhibition of capsid destabilization steps that are a prerequisite for genome release and transgene expression. Our data suggest that transient elevation of ROS in HSPC can overcome this obstacle. However, although HSPC transplantation was achieved following

induction of ER ROS production, it remains to be determined whether the long-term repopulating potential of HSPC is affected, since increases in ROS have been linked to HSPC differentiation and loss of self-renewal potential. Our studies are the first to document an effect of cellular redox on rAAV2 conformation and transduction and provide the basis for the design of transduction protocols that meet the needs of low-ROS HSPC.

328. Engineering Liver-Detargeted AAV9 Vectors for Cardiac and Musculo-Skeletal Gene Transfer

Nagesh Pulicherla,¹ Kelli D. Bryant,¹ Sarah M. Brown,¹ Mavis Agbandje-McKenna,² Aravind Asokan.¹

¹*Gene Therapy Center, University of North Carolina at Chapel Hill, Chapel Hill, NC;* ²*Department of Biochemistry and Molecular Biology, University of Florida, Gainesville, FL.*

Amongst numerous AAV isolates, AAV9 vectors are known to display a systemic multi-organ transduction profile following intravenous administration. Rapid onset and high levels of transgene expression mediated by AAV9 vectors in heart and liver have been reported. We report the generation of a new class of AAV9-derived vectors displaying selective loss of liver tropism and demonstrating potential for cardiac and musculoskeletal gene transfer applications. Random mutagenesis of residues within a surface-exposed region of the major AAV9 capsid protein yielded a capsid library with mutations clustered at the icosahedral three-fold symmetry axes. Using a combination of sequence analysis, structural models, and in vivo screening, we identified several functionally diverse AAV9 variants. The latter were classified into three functional subgroups, with respect to parental AAV9 displaying: (I) decreased transduction efficiency across multiple tissues; (II) a selective decrease in liver transduction, or (III) a similar transduction profile. Notably, variants 9.45 and 9.61 (subgroup II) displayed 10 to 25-fold lower gene transfer efficiency in liver, while transducing cardiac and skeletal muscle as efficiently as AAV9. These results were further corroborated by quantitation of vector genome copies and histological analysis of reporter (tdTomato) gene expression. The study highlights the feasibility of generating AAV vectors with selectively ablated tissue tropism, which when combined with other targeting strategies could allow sharply segregated gene expression. Liver-detargeted AAV9 variants identified in the study are potential candidates for preclinical evaluation in animal models of cardiac and musculoskeletal disease.

329. Functional Mapping of Tissue Tropism of Naturally Occurring Adeno-Associated Virus Isolates from Human Hematopoietic Stem Cells

Laura J. Smith,¹ Kim Van Vliet,² Erin Miller,¹ M. Ariel Kauss,¹ Taihra B. Ul-Hasan,¹ K. K. Wong,³ Mavis Agbandje-McKenna,² Saswati Chatterjee.¹

¹*Virology, Beckman Research Institute of the City of Hope, Duarte, CA;* ²*Biochemistry and Molecular Biology Center for Structural Biology The McKnight Brain Institute, University of Florida, Gainesville, FL;* ³*Hematology/Stem Cell Transplantation, City of Hope Medical Center, Duarte, CA.*

Recombinant adeno-associated virus gene transfer vectors (rAAV) are widely recognized as highly promising for a variety of in vivo applications. This is based primarily upon their profile of safety, in vivo efficiency, non-pathogenicity and possible anti-oncogenicity. We have recently reported the identification, isolation and cloning of endogenous AAV from the genomes of human CD34+ human peripheral blood-derived stem cells of healthy donors. The genomic sequences of all the stem cell-derived AAV isolated thus far map to AAV clade F and were most homologous to AAV9. However, each of the novel isolates tested had unique amino acids in their

capsid genes, with the differences relative to AAV9 being limited to 1 to 4 amino acids. As expected, rAAV vectors derived from stem cell isolates display enhanced transduction of CD34+ human hematopoietic stem cells *in vivo*. And, interestingly, particularly strong liver tropism was noted with specific isolates upon systemic delivery by intravenous injection. Liver tropism of these isolates was further studied by serial *in vivo* bioluminescent imaging (BLI) of recipient NOD/SCID mice following intravenous injection with rAAV encoding firefly luciferase. Results revealed that despite limited amino acid changes in the capsids, rAAVHSC13, rAAVHSC15 and rAAVHSC17 displayed significantly enhanced liver tropism as compared with AAV9. Importantly, rAAVHSC15 displayed 4-10-fold stronger liver transduction than AAV8. In an effort to elucidate factors which influence liver tropism, we mutagenized each variant amino acid in HSC 15 and AAV9 singly and in combination. The luciferase transgene was then packaged in the mutant capsids and *in vivo* liver tropism was determined by BLI following systemic delivery, as described above. Results revealed that amino acid residues located near the external surface of the capsid contributed to liver tropism. However, internally located residues also appeared to act synergistically to increase transduction. Structural contributions of the unique amino acid changes in the stem cell-derived capsids and their contribution to tissue tropism will be further discussed. Thus the use of natural AAV capsid variants with limited amino acid alteration that differ widely with respect to *in vivo* tropisms may allow mapping of critical components necessary for efficient transduction.

330. Site-Directed Mutagenesis of a Surface-Exposed Serine Residue Leads to High-Efficiency Transduction by Recombinant Adeno-Associated Virus 2 Vectors

George V. Aslanidi,¹ Lakshmanan Govindasamy,² Chen Ling,¹ Sergei Zolotukhin,¹ Mavis Agbandje-McKenna,² Arun Srivastava.¹
¹Department of Pediatrics, University of Florida College of Medicine, Gainesville, FL; ²Department of Biochemistry and Molecular Biology, University of Florida College of Medicine, Gainesville, FL.

We have reported that cellular epidermal growth factor receptor protein tyrosine kinase (EGFR-PTK) impacts negatively on nuclear transport of, and transgene expression from, AAV2 vectors primarily due to phosphorylation of AAV2 capsids at tyrosine residues (*Mol. Ther.*, 15: 1323-1330, 2007). These studies led to the development of next generation of AAV2 vectors containing point mutations in surface-exposed tyrosines that transduce cells and tissues with high-efficiency (*Proc. Natl. Acad. Sci., USA*, 105: 7827-7832, 2008). In our more recent studies, we observed that AAV2 capsids can also be phosphorylated at serine/threonine residues by cellular serine/threonine kinases, such as calmodulin-dependent protein kinase II (CamK-II), c-Jun N-terminal kinase (JNK); and mitogen-activated protein kinase (MAPK) since pre-treatment of cells with specific inhibitors of these kinases significantly increased the transduction efficiency of both single-stranded (ss) and self-complementary (sc) AAV vectors (Fig. 1A). We hypothesized that site-directed mutagenesis of the surface-exposed serine residues might allow the vectors to evade phosphorylation and subsequent ubiquitination and, thus, prevent proteasome-mediated degradation. The AAV2 capsid contains 50 serine residues in the VP3 region, of which 15 residues (261, 264, 267, 276, 384, 458, 468, 492, 498, 578, 658, 662, 668, 707, 721) are surface-exposed. Each of the 15 serine (S) residues was substituted with valine (V) residues, and each S-V mutant vector was evaluated for its transduction efficiency. These results, shown in Fig. 1B,C, indicate that of the 15 mutants, only the S662V mutant transduced 293 cells ~20-fold more efficiently than its wild-type (WT) counterpart. The transduction efficiency of S458V and S492V mutants was increased by ~2-fold. Studies are currently underway

to combine the S662V mutation with the tyrosine triple-mutation (Y730+500+444F), which we have identified to be the most efficient (*Mol. Ther.*, 18: 2048-2056, 2010) to examine whether a further optimized vector can be developed. These studies have significant implications in the potential use of serine/tyrosine-mutant AAV vectors in human gene therapy.

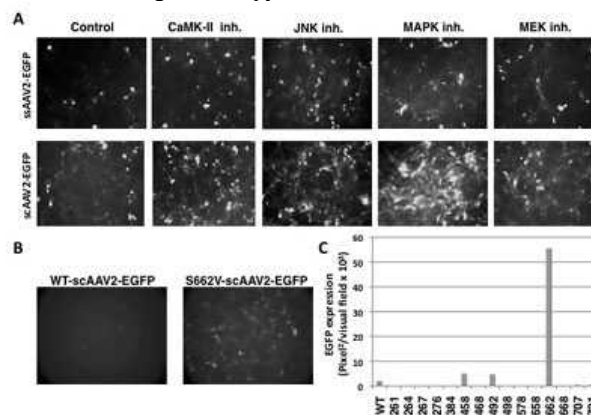

Fig. 1. A. Effect of various cellular serine/threonine kinase inhibitors on the transduction efficiency of ssAAV and scAAV vectors. 293 cells were pre-treated with 5 μ M conc. each of the inhibitors for 2 hrs, and transduced with AAV vectors at 1,000 vgs/cell. Transgene expression was evaluated 72 hrs post-transduction. B. Transduction efficiency of WT- and S662V-scAAV2-EGFP vectors. C. Relative transduction efficiency of each of the S-V mutant scAAV2 vectors.

331. Shuffled AAV Library Selection on Human Hepatocytes *In Vivo*

Leszek Lisowski,¹ Kirk Chu,¹ Mark A. Kay.¹

¹Departments of Pediatrics and Genetics, Stanford University School of Medicine, Stanford, CA.

Adeno-associated virus (AAV) is a small, single-stranded, nonpathogenic DNA virus of the Parvoviridae family. In light of unfortunate immuno- and geno-toxic side effects observed with the previously more commonly used retrovirus- and adenovirus-based vectors, AAV based vectors are being increasingly considered and used in human gene therapy trials. In addition to good safety profile, stable long-term transgene expression, ability to transduce both dividing and non-dividing cells, low immunogenicity, physical stability and episomal maintenance, characteristics that make AAV almost an ideal gene therapy vehicle, the AAV has the feasibility to pseudotype the recombinant viral DNA with a large number of available capsids. This dramatically extends the array of cells and tissues susceptible to gene transfer. We and others have shown in the past that the function and characteristics of AAV particle are dependent mostly on the capsid proteins. In order to generate and select AAV particles with a novel desired set of characteristics, investigators have tried number of approaches, from more rational and systematic domain swapping, addition of proteins to vector capsid, mosaic AAV capsid formation, to random peptide libraries insertions and random shuffled AAV libraries generation. We previously used a shuffled AAV library approach for selection of AAV capsids that infect human hepatocytes and hepatoma cells in culture (Grimm *et al.*, 2008). However, AAV transduction of primary cells in culture and *in vivo* can be very discordant. Therefore, we wanted to isolate AAV capsids that were selected *in vivo*. Thus we performed an AAV capsid library screen on human hepatocytes *in vivo*. The library selection was performed in the recently described Fah^{-/-}/Rag2^{-/-}/IL2rg^{-/-} (FRG) mice repopulated with more than 25% human hepatocytes. A new AAV shuffled capsid library generated from AAV1, 2, 3B, 4, 5, 6, 8, 9, Avian-, and Bovine-AAV capsid genes in a manner similar to that previously published by our lab

was cloned into a wildtype AAV genome (Grimm *et al.*, 2008). This AAV library was injected into FRG animals repopulated with human hepatocytes, followed 24 hrs later by human adenovirus 5 to provide helper virus function for AAV replication in human, but not mouse hepatocytes. Three days postinfection the mice were sacrificed and the intact AAV particles were purified from the liver. The purified AAV pool was then injected into a subsequent animal, followed by Ad5 as previously described. After 4 subsequent rounds of *in vivo* selection we observed a significant enrichment for number of novel AAV capsid sequences. Detailed amino acid sequence analysis showed that the new capsids contained significant contributions from AAV-3, AAV-6, AAV-8, and AAV-9, while sequences of AAV-1, AAV-2 and AAV-4 capsids were underrepresented. We are currently cloning the shuffled capsid genes into an AAV helper plasmid and make vectors with the individual capsids. These vectors will be evaluated for function and tissue/cellular tropism. We are also continuing with additional rounds of *in vivo* selection and various selection schemes. We believe this approach will allow us to select for novel AAV capsids with superior transduction properties for use in humans.

332. The Crystal Structure of AAV5: Role of Variable and Conserved Regions in Capsid Function

Lakshmanan Govindasamy,¹ Michael DiMattia,¹ Brittney L. Gurda,^{1,5} Robert McKenna,¹ John A. Chiorini,² Nicholas Muzyczka,³ Sergei Zolotukhin,⁴ Mavis Agbandje-McKenna.¹
¹Biochemistry and Molecular Biology, University of Florida, Gainesville, FL; ²MPTB, NIDCR, National Institutes of Health, Bethesda, MD; ³Department of Molecular Genetics and Microbiology, University of Florida, Gainesville, FL; ⁴Department of Pediatrics, University of Florida, Gainesville, FL; ⁵Pathology and Laboratory Medicine, University of Pennsylvania, Philadelphia, PA.

The Adeno-associated viruses (AAVs) under development for gene delivery applications display unique cell binding, transduction, and antigenic characteristics specified by their capsid viral protein (VP) sequence. Towards structural characterization of these VP determinants for the AAVs the crystal structure of AAV5, one of the most sequence diverse serotypes, has been determined to 3.45Å resolution. The AAV5 VP and capsid shares the topological features already described for AAV2, AAV4, and AAV8 but uniquely differs in the surface disposed HI loop between βH and βI of the VP core β-barrel motif in addition to pronounced conformational variation in two of the AAV surface variable regions (VRs), VRIV and VRVII. The HI loop is structurally conserved in AAV2, AAV4, and AAV8 despite amino acid differences but is smaller in AAV5 due to an amino acid deletion. This HI loop is adjacent to VRVII which is largest in AAV5. VRIV, which forms the outermost and larger of the two finger-like VP loops contributing to the protrusions surround the icosahedral three-fold axes of the AAVs, is truncated in AAV5 resulting in a smoother capsid surface topology. The HI loop plays a role in AAV capsid assembly and genome packaging, and VRIV and VRVII are associated with transduction and antigenic differences, respectively, between the AAVs. The interior capsid properties of AAV5, surface charge and volume, were compared to those of AAV2 and AAV4 to evaluate previous reports of its increased DNA packaging capacity. While the AAV5 surface contained an increased number of charged residues, the calculated volume was very similar to those of the other two viruses and inconsistent with the approximately double packaging capacity reported. This AAV5 structure provides an additional 3D template for functional annotation of the AAV capsid with respect to regions that confer assembly efficiency, dictate cellular transduction phenotypes, and antigenicity, towards improving AAV-based viral gene delivery vectors.

333. Selection of Neutralizing Antibody-Resistant AAV8 Variants with Structure-Guided Site-Specific Saturated Mutagenesis

Qiang Wang,¹ Brittney Gurda,¹ Luk Vandenberghe,¹ Jing Lu,¹ Sheng Li,¹ James M. Wilson.¹
¹Gene Therapy Program, Department of Pathology & Laboratory Medicine, University of Pennsylvania, Philadelphia.

Vectors based on AAV8 have shown promise for liver directed gene transfer. However pre-existing neutralizing antibody (Nab) due to natural infections, which are present in up to 20% of humans, interferes with transduction efficiency after intravenous infection. We hypothesize that the Nab responses to vector are characterized by a limited number of surface exposed B cell epitopes. If this is true it may be possible to create variants of AAV with minimal mutations that escape some Nab responses. Recent studies using cryo-electron microscopy have mapped Ab binding sites on the AAV capsid including the binding of monoclonal Ab ADK8 onto AAV8. Using this structural data as well as previous mutagenesis/function studies we devised a strategy to create a version of AAV8 which escapes neutralization from Nab generated in humans to natural infections. Seven sites of AAV8 VP1 gene, corresponding to amino acids at position 583,588,589 and 594-597 were chosen for saturated mutagenesis. Populations of vectors were made from these capsid libraries. After one round of transduction in the presence of ADK8 in 293 cells, variants were retrieved by PCR with genomic DNA and cDNA as the template and then cloned into a trans-plasmid carrying AAV rep gene. Eleven variants were retrieved from nineteen randomly selected clones and were used to package AAV.CMV.eGFP of which eight produced vector at high yield. *In vitro* infectivity assays show one variant, C42 (SFRLWSS), was at least 10 fold more infectious to 293 cell and Huh7 cells than the wt AAV8. All nine variants show *in vitro* resistance to the inhibition of ADK8, as well as another monoclonal Nab. Six variants were tested *in vivo* and showed efficiencies of liver transduction similar to wild type (vector genome copies/ug liver genomic DNA, 65%~179% compared to the wt AAV8; eGFP semi-quantification, 49%~108% to the wt AAV8). Five out of the six variants were also tested for resistance to sera from three individual AAV8, Nab-positive humans. A number of variants showed diminished inhibition of transduction *in vitro* to these sera with variant C41 providing convincing evidence of diminished inhibition in an *in vivo* passive transfer assay to 2/3 sera. These variants may be useful in human gene therapy in those subjects that are AAV8 Nab positive. Furthermore our data support the original hypothesis that a limited number of B cell epitopes exist on the surface of AAV8.

Genetic and Metabolic Diseases Gene & Cell Therapy II

334. Prevention of Murine Autoimmune Diabetes by CCL22-Mediated T Regulatory Cell Recruitment to the Islet

Joel Montane,¹ Loraine Bischoff,¹ Galina Soukhatcheva,¹ Lei Dai,¹ Paul Orban,¹ Gijs Hardenberg,² Megan Levings,² Merce Obach,¹ Rusung Tan,¹ C. Bruce Verchere.¹
¹Pathology and Laboratory Medicine, University of British Columbia, Vancouver, BC, Canada; ²Department of Surgery, University of British Columbia, Vancouver, BC, Canada.

Type 1 diabetes is characterized by destruction of insulin-producing β-cells by effector T cells. T regulatory cells (Tregs), defined by markers CD4 and FoxP3, regulate immune responses by suppressing effector T cells. The chemokine CCL22 recruits Tregs through interaction with its receptor CCR4, and this activity is exploited by tumor cells to evade immune responses. To drive islet-specific expression of CCL22, we created double-stranded adeno-associated

virus serotype 8 (dsAAV8) vectors containing a murine CCL22 or GFP cDNA, driven by the rat insulin promoter (dsAAV8-RIP/CCL22 and dsAAV8-RIP/GFP, respectively). To determine whether β -cell specific expression of CCL22 can delay or prevent diabetes, 8-week old NOD mice were injected via the pancreatic duct with 1.5×10^{11} vg of dsAAV8-RIP/CCL22, dsAAV8-RIP/GFP or PBS. NOD mice transduced with dsAAV8-RIP/CCL22 (CCL22-NOD) were protected from diabetes, with 9 of 11 mice remaining normoglycemic up to 160 days following virus injection, whereas all GFP-NOD (6/6) and PBS-NOD (7/7) mice developed diabetes within the first 100 days. In addition, adenoviral expression of CCL22 in syngeneic islet transplants in diabetic NOD recipients prevents β -cell destruction by autoreactive T cells, delaying recurrence of diabetes. Approximately half of recipients of islets expressing CCL22 remained normoglycemic (5/9) for more than 60 days after transplant, whereas all (6/6) recipients of control islets became diabetic within 20 days post-transplant. CCL22 expression increased the frequency of Tregs near islets (0.8 ± 0.09 vs $2.9 \pm 0.13\%$), and these Tregs expressed high levels of TGF- β . Islet CCL22 expression also limited accumulation of autoreactive CD8+ cells and decreased the frequency of CD8+IFN γ + producing cells. The protective effect of CCL22 was blocked by depletion of Tregs with anti-CD25 antibody, demonstrating that the observed effect was Treg-dependent. Our results indicate that islet expression of CCL22 recruits Tregs and attenuates autoimmune destruction of β -cells. CCL22-mediated recruitment of Tregs to islets may be a novel therapeutic strategy for type 1 diabetes.

335. Adeno-Associated Virus 8 (AAV8) Mediated Expression of XIAP in beta Cells Protects Islet Allografts in Diabetes

Joel Montane,¹ Merce Obach,¹ Galina Soukhatcheva,¹ C. Bruce Verchere.¹

¹Pathology and Laboratory Medicine, University of British Columbia, Vancouver, BC, Canada.

Apoptotic death of islet beta cells underlies loss of beta cell mass in type 1 diabetes and following islet transplantation. Understanding the intracellular pathways mediating apoptotic cell death has opened the door to new therapeutic approaches that target cell death. The X-linked inhibitor of apoptosis (XIAP) exhibits high binding affinity for and inhibition of caspases 3, 7 and 9, and has been shown to protect from apoptosis by numerous insults, pointing to a tremendous therapeutic potential for this molecule. We previously observed that adenoviral overexpression of XIAP in transplanted mouse islets provides protection of transplantation into allogeneic diabetic recipients. There are, however, several limitations to this approach if it is to be translated clinically; for example, adenoviral expression tends to occur primarily in the islet periphery (and not the beta cell rich islet centre) and the adenoviral expression XIAP wanes within a few weeks, which may provoke graft failure. Adeno-associated virus (AAV) is emerging as a vector choice for gene therapy approaches as it provides long-lasting expression with minimal immunogenicity and cell toxicity. Double-stranded AAV serotype 8 (dsAAV8), in particular, has been found to be an effective agent to induce long-term beta cell-specific gene expression in vivo. To determine whether dsAAV8-mediated XIAP expression in beta cells could enhance islet allograft survival, we injected dsAAV8 expressing a XIAP cDNA driven by the rat insulin promoter (dsAAV8-RIP-XIAP) or (dsAAV8-RIP-GFP as a control) into the pancreatic duct of C57Bl/6 mice. Four weeks following transduction, islets were isolated and transplanted into MHC-mismatched (Balb/c) mice made diabetic by intraperitoneal injection of streptozotocin. All (5/5) dsAAV8-RIP-XIAP transduced mice were still protected from allograft rejection (normoglycemic) after 125 days whereas all (4/4) control (dsAAV8-RIP-GFP) animals had failed (return of hyperglycemia) within 30 days after transplantation. Histological analysis of the graft confirmed numerous insulin

immunopositive cells within XIAP-expressing islets. To determine if transplantation of XIAP-expressing islets induced tolerance, when Balb/c serum from recipients of XIAP-expressing islets was incubated with B6 splenocytes, no increase in serum IgG was found, suggesting that humoral tolerance was induced. These findings indicate that AAV-mediated expression of XIAP by islets prior to transplantation prevents allograft rejection and may induce tolerance to recipients, thereby preventing recurrence of diabetes in this model. Manipulation of transplanted islets for long-term expression of XIAP may be a novel therapeutic strategy for diabetes.

336. Lentiviral Vector Enhanced Haematopoietic Stem Cell Gene Therapy Corrects the Neurological Phenotype of Mucopolysaccharidosis IIIA Mice

Alexander W. W. Langford-Smith,¹ Fiona L. Wilkinson,¹ Kia J. Langford-Smith,¹ Ana Sergijenko,¹ Rebecca Holley,² William Bennett,¹ Simon Howe,³ Adrian Thrasher,³ Catherine Merry,² Simon Jones,⁴ J. Ed Wraith,⁴ Robert Wynn,⁵ Brian W. Bigger.¹
¹MPS Stem Cell Research Group, The University of Manchester, Manchester, United Kingdom; ²Stem Cell Glycobiology, The University of Manchester, Manchester, United Kingdom; ³Centre for Immunodeficiency, UCL Institute of Child Health, London, United Kingdom; ⁴Genetic Medicine, St Mary's Hospital, Manchester, United Kingdom; ⁵Blood and Marrow Transplant Unit, Royal Manchester Children's Hospital, Manchester, United Kingdom.

Mucopolysaccharidosis IIIA (MPSIIIA) is a lysosomal disorder caused by deficiency of sulfamidase (SGSH), catabolising heparan sulphate (HS). Enzyme replacement therapy, and haematopoietic stem cell transplantation (HSCT) are both ineffectual and the lack of treatments results in abnormal behaviour, progressive cognitive and motor impairment, with death in early teens. We propose that HSCT failure is due to a dose effect, where insufficient enzyme is produced by donor-derived brain microglial cells. We compare HSCT using normal haematopoietic stem cells (WT-HSCT) against lentiviral overexpression of SGSH in transplanted cells (LV-HSCT) in MPSIIIA mice. Lineage depleted (lin-) bone marrow was transduced with SGSH-lentiviral vector at MOI 30. Transduced or untransduced WT/MPSIIIA lin- cells were delivered to myeloablated WT/MPSIIIA mice, achieving >90% chimerism. Cohorts of 8-10 mice per group were analysed in the open field test, perfused with Tyrodes and sacrificed 6 months post-transplant. Further mice were kept for long-term vector analysis. Six months post HSCT we found that WT-HSCT achieves sub-physiological levels of SGSH in visceral organs, with no significant increase in SGSH activity in brains of MPSIIIA recipients. Brain lysosomal compartment size is not significantly reduced but neuroinflammation (microglial cell numbers) is significantly reduced by 46%. However, WT-HSCT does not correct the abnormal hyperactive and rapid exploration, nor the reduced sense of danger observed in MPSIIIA mice. In contrast, recipients of LV-HSCT showed physiological levels of SGSH activity in spleen, 48% in liver and 10% of normal levels in brain. Cerebral cortex lysosomal size and total brain glycosaminoglycans are significantly reduced to near normal and neuroinflammation by 59%. LV-HSCT also normalised abnormal hyperactive and rapid exploration behaviours, including the reduced sense of danger observed in MPSIIIA mice to WT levels. LV-HSCT is able to correct the neurological phenotype in MPSIIIA mice where HSCT fails. This is a scalable and clinically viable approach to treating MPSIIIA.

337. Correction of Neurological Disease of Mucopolysaccharidosis IIIB in Adult Mice by rAAV9 Trans-Blood-Brain-Barrier Gene Delivery

Haiyan Fu,^{1,2} Juliann DiRosario,¹ Smruti Killekar,^{1,2} Kimberly Zaraspe,¹ Douglas M. McCarty.^{1,2}

¹Center for Gene Therapy, Research Institute at Nationwide Children's Hospital, Columbus, OH; ²Department of Pediatrics, The Ohio State University, Columbus.

The greatest challenge in developing therapies for Mucopolysaccharidosis (MPS) IIIB is to achieve efficient CNS delivery across the blood-brain barrier (BBB). In this study, we used the novel ability of AAV9 to cross the BBB from the vasculature to achieve long-term global CNS, and widespread somatic restoration of α -N-acetylglucosaminidase (NAGLU) activity. A single intravenous (IV) injection of rAAV9-CMV-hNAGLU, without extraneous treatment to disrupt the BBB, restored NAGLU activity to normal or above normal levels in adult MPS IIIB mice, leading to complete, or near complete, correction of lysosomal storage pathology in the CNS and periphery, and correction of astrocytosis and neurodegeneration. The IV-delivered rAAV9 vector also transduced abundant neurons in the myenteric and submucosal plexus, suggesting peripheral nervous system targeting. While CNS entry did not depend on osmotic disruption of the BBB, it was significantly enhanced (≥ 2 fold) by pretreatment with an IV infusion of mannitol. Most important, we demonstrate that a single systemic rAAV9-NAGLU gene delivery provides long-term neurological benefits in MPS IIIB mice, resulting in significant improvement in cognitive and motor function, and extension of survival (18.8-20 months, ongoing). In addition, much less vector is required to achieve functional benefits by IV AAV9 delivery, in comparison to IV-mannitol-AAV2 regimen. These data suggest promising clinical potential using the trans-BBB neurotropic rAAV9 vector for treating MPS IIIB and other neurogenetic diseases.

338. Enhancement of Gene Therapy in Pompe Disease by Increased Mannose-6-Phosphate Receptor Expression in Target Tissues

Dwight D. Koeberl,¹ Baodong Sun,¹ Jian Dai,¹ Andrew Bird,¹ Deeksha S. Bali.¹

¹Pediatrics, Duke University Medical Center, Durham, NC.

The underlying deficiency of acid α -glucosidase (GAA) in Pompe disease has been partially corrected by enzyme replacement (ERT). However, skeletal muscle weakness persists in many patients on ERT, and poor uptake of GAA by skeletal muscle has been linked to low abundance of the cation-independent mannose-6-phosphate receptor (CI-MPR). To further understand the role of CI-MPR in Pompe disease, we crossed muscle-specific CI-MPR knockout (KO) mice with GAA-KO (Pompe disease) mice. We evaluated adeno-associated virus (AAV) vector-mediated gene therapy in CI-MPR-KO/GAA-KO (double KO) mice. The essential role of CI-MPR was emphasized by the lack of efficacy from AAV vector administration, as demonstrated by markedly reduced biochemical correction of GAA deficiency and of glycogen accumulations in double KO mice, in comparison with administration of the same AAV vector in GAA-KO mice. We next attempted to increase CI-MPR expression in skeletal muscle to demonstrate the dependence of biochemical correction upon receptor-mediated uptake of GAA. Therefore, the AAV vector-transduced liver depot was enhanced by the addition of a drug, clenbuterol, which was previously demonstrated to increase the expression of CI-MPR in muscle. The liver was transduced by administering AAV-LSPHGAAPa (2×10^{10} vector particles) to two groups of 3 month-old male GAA-KO mice, and clenbuterol was administered to one group of vector-treated mice. The effect of clenbuterol was evident, when Rotarod latency was increased by

75% following vector administration and clenbuterol treatment, in comparison with vector administration alone ($p < 2 \times 10^{-5}$). The efficacy from clenbuterol treatment was evaluated with regard to biochemical correction of GAA deficiency and glycogen storage in striated muscles and the brain. GAA activity was significantly increased in the heart following vector administration and clenbuterol treatment, in comparison with vector administration alone ($p = 0.03$). Glycogen content was reduced in the diaphragm ($p = 0.04$), soleus ($p = 0.0006$), extensor digitorum longus (EDL; $p = 0.002$), cerebrum ($p < 5 \times 10^{-5}$), and cerebellum ($p = 0.03$) following vector administration and clenbuterol treatment, in comparison with vector administration alone. The basis for increased glycogen clearance during clenbuterol treatment was demonstrated by Western blotting detection of CI-MPR. The signal for CI-MPR was increased in the EDL ($p < 0.05$) and cerebrum ($p < 0.01$) of clenbuterol-treated GAA-KO mice. Furthermore, the effect of gene therapy with clenbuterol enhancement was evaluated in 15 month-old female GAA-KO mice, because elderly, female mice with Pompe disease are particularly resistant to correction with AAV vector-mediated gene therapy. Significantly increased Rotarod latency ($p = 0.02$) and weight ($p = 0.04$) were demonstrated 12 weeks following the initiation of therapy, indicating that long-term efficacy had been achieved in advanced Pompe disease. In summary, enhanced CI-MPR expression might improve the efficacy from gene therapy in Pompe disease through enhancing receptor-mediated uptake of GAA, and gene therapy could be similarly enhanced in other lysosomal storage disorders that primarily involve the brain.

339. Preservation of Renal Function in Murine Glycogen Storage Disease Type I with a Double-Stranded Adeno-Associated Virus Vector

Xiaoyan Luo,¹ Songtao Li,¹ Andrew Bird,¹ Michelle P. Winn,² Dwight D. Koeberl.¹

¹Pediatrics, Duke University Medical Center, Durham, NC;

²Medicine, Duke University Medical Center, Durham, NC.

Glycogen storage disease type Ia (GSD-Ia) is caused by the deficiency of glucose-6-phosphatase (G6Pase) in liver and kidney. Long-term complications of GSD-Ia occur frequently, including life-threatening hypoglycemia and proteinuria progressing to renal failure. To further develop gene therapy for GSD-Ia we cross-packaged a double-stranded (ds) adeno-associated virus serotype 2 (AAV2) vector encoding human G6Pase with AAV2, AAV7, AAV8 and AAV9, and evaluated efficacy in *G6pase* (-/-) mice. The AAV2/8 vector previously prevented hypoglycemia during fasting in *G6pase* (-/-) mice; however, the vector dose (1×10^{13} vp/kg) exceeded the highest dose administered in clinical trials of AAV vector-mediated gene therapy. Therefore, a reduced dose was administered in *G6pase* (-/-) mice (2×10^{12} vp/kg) for these 4 pseudotypes, and hypoglycemia during fasting was prevented for > 6 months by the AAV2/8 and AAV2/9 vectors. The AAV2/7 vector prevented hypoglycemia only at the higher dose (1×10^{13} vp/kg), and the AAV2/2 vector did not prevent hypoglycemia. Prolonged fasting for 8 hours revealed very significant correction of hypoglycemia following AAV2/9 vector administration at the higher dose. G6Pase activity was analyzed in tissues of *G6pase* (-/-) mice following vector administration, and G6Pase activity was significantly increased in the kidney to 43% of normal activity following AAV2/9 vector administration at 7 months of age. Similarly, G6Pase activity was significantly increased in the liver of *G6pase* (-/-) mice following AAV vector administration, and up to 48% of normal activity was demonstrated for the higher dose of the AAV2/9 vector at 7 months of age. Glycogen content was analyzed in tissues following vector administration to evaluate the biochemical activity of G6Pase expressed with each AAV vector. The glycogen content of kidney was reduced by $> 70\%$ in both the AAV2/7 and AAV2/9 vector-treated groups of *G6pase* (-/-) mice. Glycogen did not increase between 7 and 12 months of age in the kidney of the

AAV2/9 vector-treated groups, and a dose-response was observed for both AAV2/7 and AAV2/9 vectors. The AAV2/2 vector-treated groups had significantly higher glycogen content in the kidney, in comparison with the other 3 vectors. Every vector treated group had significantly reduced glycogen content in the liver, in comparison with the liver of untreated *G6pase* (-/-) mice. G6Pase expression was demonstrated by histochemical staining in the liver and kidney of *G6pase* (-/-) mice that received the AAV2/9 vector. In the kidney, G6Pase expression was detected in many renal epithelial cells of *G6pase* (-/-) mice treated with the higher dose of AAV2/9 at 7 and 12 months of age. Renal involvement in GSD-1a progresses from microalbuminuria to proteinuria, and therefore urinary microalbumin was quantified for vector-treated *G6pase* (-/-) mice. Microalbuminuria was prevented by vectors other than AAV2/2. Preservation of renal function in *G6pase* (-/-) mice demonstrates the potential of AAV vectors for the correction of inherited diseases of the kidney.

340. Robust and Sustained Correction of OTC Deficiency in Adult Sp^{fsh} Mice Using an AAV2/8-Based Vector Expressing Codon-Optimized Human OTC Gene

Lili Wang,¹ Jianping Lin,¹ Hiroki Morizono,² Peter Bell,¹ David Jones,² Deirdre McMenamin,¹ Mark Batshaw,² James M. Wilson.¹
¹Gene Therapy Program, Department of Pathology & Laboratory Medicine, University of Pennsylvania, Philadelphia; ²Center for Genetic Medicine Research, Children's National Medical Center, Children's Research Institute, Washington, DC.

Ornithine transcarbamylase deficiency (OTCD) is an X-linked recessive metabolic disease. Severe OTC deficiency (OTCD) can result in hyperammonemic coma in the neonatal period which, if left untreated, can rapidly become fatal. Current therapies include dialysis, the utilization of alternate nitrogen clearance pathways, and liver transplantation for severely affected patients, however, there is still an unacceptably high mortality rate. AAV vector based gene therapy would provide an alternative to current treatment options as long as the vector delivers high level and stable transgene expression in liver without substantial toxicity. Previously, we have developed an AAV2/8 based self-complementary vector expressing murine OTC gene driven by a liver-specific TBG promoter. A single tail vein injection of 3x10¹¹ GC of vector in Sp^{fsh} mice restored the OTC enzyme activity in the livers of treated mice to a level similar to wild-type. In the current study, we replaced the murine OTC gene with a codon-optimized human OTC gene. Robust OTC gene expression and correction of OTCD were achieved in Sp^{fsh} mice. Three days after intravenous injection of vector at dose as low as 1x10¹⁰ GC, urinary orotic acid in treated animals were corrected to normal levels and sustained through the experiment. Liver OTC activity in Sp^{fsh} mice treated with 3x10¹⁰ GC of vector were about 2-fold of normal levels assayed one month after treatment. Treated mice had significantly improved behavior scores following ammonia challenge. In contrary to previous conclusions drawn from studies using adenovirus-based vectors, we demonstrated that human leader peptides in OTC enzyme are fully functional in mouse. Replacing the human leader peptides with mouse leader peptides does not change the enzyme activity. The AAV2/8-human OTC vector we developed has great potentials for treating OTCD in human.

341. Long-Term Correction of Very Long-Chain Acyl-CoA Dehydrogenase Deficiency by Recombinant Adeno-Associated Virus 9 Gene Therapy

Allison M. Keeler,¹ Glenn Walters,² Thomas Conlon,² Karin Green,¹ Christian Mueller,¹ Terence R. Flotte.¹

¹University of Massachusetts, Worcester, MA; ²University of Florida, Gainesville, FL.

Very long-chain acyl-CoA dehydrogenase (VLCAD) catalyzes is the rate-limiting step in mitochondrial beta-oxidation of fatty acids. VLCAD deficiency causes not only an energy deficit but also an accumulation of long chain fatty acids. VLCAD deficiency presents in three different phenotypes: the most severe form presents during infancy with cardiomyopathy and hepatopathy, a second form also occurs in infancy and is usually triggered by a preceding infection resulting also in hepatopathy, and finally the least severe presents in adolescents or young adults with muscle weakness. In order for a therapy to comprehensively treat the heterogeneous phenotypes of this disease, it must correct the organs where pathogenesis occurs primarily in the liver, heart and skeletal muscle. Recombinant adeno-associated virus serotype 9 (rAAV9) was chosen over other serotypes because of its broad-spectrum tissue tropism. Therefore we hypothesize that using intravenous rAAV9-expressing VLCAD will effectively target the liver, heart and skeletal muscle of VLCAD deficient mice will in turn confer long-term correction of VLCAD deficiency. In this study, three cohorts of mice were injected with 1x10¹²vg of AAV9-VLCAD, AAV9-GFP or PBS. Tissue transduction by AAV9 was measured by a control virus expressing GFP; results showed GFP expression in the liver, heart, and to a lesser degree muscle. Biochemical correction was seen in treated mice starting at two weeks post-injection, as characterized by a significant drop in long chain accumulates in whole blood after an overnight fast. This significant reduction persisted until the first cohort was terminated at twelve weeks. Correction within the muscle was measured in vivo by Magnetic Resonance Spectrometry (MRS) at 14 weeks post injection in the second cohort; preliminary scans have shown reduction of lipid peaks dropped within the muscle of treated VLCAD deficient mice to the same levels as seen in wild-type animals. In the future, MRS will be performed on both the liver and the heart to see if reductions of lipids are also seen in those organs. The third cohort of mice underwent a fasting cold challenge six weeks post injection, in which an overnight fast is followed by a challenge in a 4°C cold room. During the cold-fast challenge, after 120 minutes all internal body temperatures of untreated VLCAD deficient mice dropped below 20°C and became severely lethargic requiring euthanasia, whereas all of the VLCAD treated deficient mice and the wild type controls maintained a body temperature averaging 28°C over the 150 minutes at 4°C. In conclusion, AAV9 expressing VLCAD effectively targeted the liver, heart and skeletal muscles and conferred near total correction as seen by reduced fatty acid accumulates in the blood, and muscle as well as the improved ability to thermoregulate in a cold environment. These promising results implicate rAAV gene therapy as a effective treatment for VLCAD deficiency in humans.

Hematologic and Immunologic Gene & Cell Therapy

342. Maintenance of Hematopoietic Polyclonality after MGMP140K-Mediated *In Vivo* Selection and Chemoprotection Following Multiple Cycles of Chemotherapy in Glioblastoma Patients

Jennifer E. Adair,¹ Brian C. Beard,¹ Grant D. Trobridge,² Maciej Mrugala,³ Hans-Peter Kiem.^{1,3}

¹Clinical Research Division, Fred Hutchinson Cancer Research Center, Seattle, WA; ²Pharmaceutical Sciences, Washington State University, Pullman, WA; ³Department of Medicine, University of Washington, Seattle, WA.

Drug resistance gene therapy with mutant MGMP140K gene-modified hematopoietic CD34⁺ cells has been proposed to circumvent hematopoietic toxicity associated with alkylating agent chemotherapy, however, the safety of this approach has not yet been demonstrated. We previously reported successful engraftment of MGMP140K gene-modified hematopoietic progenitor cells in three patients following reduced intensity BCNU (600mg/m²) conditioning, as part of a Phase I/II clinical study which includes post-transplant combination O6-benzylguanine (O6BG) and temozolomide (TMZ) chemotherapy. We have since expanded this cohort to include a fourth patient, and all patients have received at least two cycles and as many as 9 cycles of combination O6BG/TMZ chemotherapy to date. We observed transient increases in the number of circulating gene-modified white blood cells (WBCs) and granulocytes in each patient following each cycle. Analysis of CD34⁺ colony forming cells (CFCs) in peripheral blood revealed increases in the number of gene-modified CFCs over time and with multiple cycles of chemotherapy, ranging from 27% to 85% of peripheral blood CFCs. Analysis of CFCs derived from the bone marrow of two patients, one at 5 and the other at 13 months after transplant, showed levels of 77% and 61% gene-modified CFCs, respectively. Moreover, sustained gene marking has been observed in multiple cell lineages in three patients at more than 12 months after transplant. Given the persistence of MGMP140K gene-modified cells, we conducted a longitudinal retroviral integration site (RIS) analysis in an attempt to identify any selective advantage for gene-modified clones following repeated O6BG/TMZ regimens. To date, we have identified over 2,000 unique sites in the three aforementioned patients, and have employed a capture frequency analysis to semi-quantitatively identify potentially dominant clones. RIS analysis in WBCs before chemotherapy, and at a minimum of two time points after chemotherapy, demonstrated that multiple gene-modified clones contributed to hematopoiesis in each patient at each time point examined. Furthermore, none of the top five representative RIS captured at each time point in each patient were identified at any other time point to date, suggesting no emergence of a dominant clone or clones. RIS analysis near transcription start sites (TSSs) of proto-oncogenes before and after chemotherapy revealed no enrichment for clones with proximal proto-oncogenes following multiple rounds of chemotherapy. Additionally, functional annotation of RIS-proximal (≤ 500 kb) TSSs did not indicate enrichment of growth-promoting or apoptosis-evading cellular pathways after chemotherapy. We believe that these data demonstrate MGMP140K-modified hematopoietic cells as a safe method of chemoprotection and *in vivo* selection in patients.

343. Molecular Follow-Up of the German WAS Clinical Gene Therapy Trial

Anna Paruzynski,¹ Kaan Boztug,² Claudia Ball,¹ Ali Nowrouzi,¹ Christina Lulay,¹ Marie Böhm,² Sonja Naundorf,³ Klaus Kühlcke,³ Rainer Blasczyk,⁴ Irina Kondratenko,⁵ Laszlo Maródi,⁶ Hanno Glimm,¹ Christoph Klein,² Christof von Kalle,¹ Manfred Schmidt.¹

¹Department of Translational Oncology, National Center for Tumor Diseases and German Cancer Research Center, Heidelberg, Germany; ²Department of Pediatric Hematology/Oncology, Hannover Medical School, Hannover, Germany; ³EU-FETS AG, Idar-Oberstein, Germany; ⁴Institute for Transfusion Medicine, Hannover Medical School, Hannover, Germany; ⁵Department of Clinical Immunology, Russian Clinical Children's Hospital, Moscow, Russian Federation; ⁶Department of Infectious and Pediatric Immunology, Medical and Health Science Center, University of Debrecen, Debrecen, Hungary.

In the German WAS (Wiskott Aldrich Syndrome) clinical gene therapy trial nine out of ten patients were successfully treated with a MLV-based gamma retroviral vector encoding the therapeutic transgene WASP. We performed linear amplification mediated PCR (LAM-PCR) combined with high throughput sequencing to analyze the clonal inventory of the gene-corrected hematopoiesis. The analysis of the samples from patient 1 and 2 (P1 and P2) until $> 3 \frac{1}{2}$ years after gene therapy led to the detection of > 7000 and > 11000 unique integration sites (IS), respectively. Both patients showed a polyclonal reconstitution of the hematopoietic system till the latest time point analyzed (day 1467 and day 1435 after gene therapy). We detected amongst others a high clustering of IS within or close to the already known proto-oncogenes *MDS1-EVII* (P1: 91 IS; P2: 111 IS), *PRDM16* (P1: 12 IS; P2: 31 IS), *LMO2* (P1: 14 IS; P2: 31 IS) and *CCND2* (P1: 11 IS; P2: 22 IS). Quantitative analyses (Sequence Count Analysis and qPCR) revealed two striking clones with an IS 130 kb upstream of *CCND2* and one within the second Intron of the *MDS1* gene locus. The contribution of these two clones increased over time, but after reaching a contribution of $> 10\%$, a decrease could be detected at the later time points. Furthermore, we performed RT-PCR for P2 and we could detect an expression of *MDS1-EVII* at the latest time points analyzed (1253 and 1435 days after gene therapy). For patients 4-10 the IS analysis is still ongoing. So far we retrieved between 2000 and 5000 unique IS. One of the patients, Patient 6 (P6), developed 489 days after gene therapy a T-lineage acute lymphoblastic leukemia (T-ALL). The analysis of the leukemic sample revealed a dominant clone harboring an IS 33 kb upstream of the *LMO2* gene locus. The contribution of this clone increased from $< 1\%$ at day 405 after gene therapy to $> 90\%$ at the leukemic time point. Non-restrictive (nr) LAM-PCR as well as qPCR analysis confirmed this strong increase in the contribution. 33 days after starting the chemotherapy the *LMO2* clone could still be detected, but a decrease of the contribution was observed. RT-PCR analysis concerning the expression of *LMO2* is still ongoing. Eight out of nine patients in this trial show a polyclonal reconstitution of the hematopoietic system up to $> 3 \frac{1}{2}$ years after gene therapy. P6 underwent chemotherapy and is now in remission. Further molecular follow up in the patients will yield deep insights into clone dynamics and repopulation kinetics of the hematopoietic system.

344. Correction of Canine Pyruvate Kinase Deficiency by Foamy Virus Vector-Mediated MGMT-P140K Selection In Vivo

Brian C. Beard,¹ Robert A. Wu,² Christina Ironside,¹ Punam Malik,³ Hans-Peter Kiem,^{1,4} Grant D. Trobridge.⁵

¹Clinical Research Division, Fred Hutchinson Cancer Research Center, Seattle, WA; ²Molecular and Cell Biology, University of California, Berkeley, CA; ³Experimental Hematology and Cancer Biology, Cincinnati Children's Hospital Medical Center, Cincinnati, OH; ⁴Department of Medicine, University of Washington, Seattle, WA; ⁵Pharmaceutical Sciences, Washington State University, Pullman, WA.

Hematopoietic stem cell (HSC) gene therapy has cured several immunodeficiencies where relatively small numbers of gene-corrected cells are sufficient to correct the disease phenotype (i.e. SCID-X1). However, many severe erythroid diseases will require relatively high percentages of corrected repopulating cells to achieve a therapeutic benefit and the ability to increase the percentage of gene-corrected cells following transplantation is a powerful therapeutic approach. Here we developed therapeutic foamy virus (FV) vectors for pyruvate kinase (PK) deficiency in the Basenji dog model that contain a P140K mutant methylguanine methyltransferase (MGMT-P140K) transgene to increase the percentage of gene-modified cells to therapeutic levels following transplantation. FV vectors are attractive for HSC gene therapy since they efficiently transduce repopulating cells in animal models, and may be safer than more commonly used gammaretroviral vectors. Briefly, a FV vector was constructed with R-type canine pyruvate kinase, enhanced green fluorescent protein (EGFP) and MGMT-P140K transgenes. G-CSF and SCF mobilized autologous CD34-selected peripheral blood cells were transduced with the therapeutic FV vector using a 2-day protocol. Following 920cGy conditioning FV-modified cells were infused into a Basenji PK-deficient dog and following hematopoietic recovery, defined by an absolute neutrophil count >1,000/ μ l and platelet count >100,000/ μ l, we observed stable multi-lineage gene marking as evidenced by EGFP expression. Relatively low levels of gene marking, ~3.5% in granulocytes, was not enough to maintain hematocrit levels >20 without transfusion support. To achieve therapeutic levels of gene-corrected cells we selected cells in vivo two times using O6-benzylguanine (O6BG) and 1,3-bis-(2-chloroethyl)-1-nitrosourea (BCNU) and the gene marking in granulocytes increased and stabilized at ~25-30%. Sustained therapeutic benefit from gene-corrected cells has now been observed following in vivo selection of gene-corrected cells indicated by prolonged maintenance of hematocrit without transfusions for more than a year and a decrease in nucleated RBCs relative to pre-transplant levels. We have also developed FV vectors with enhanced ankyrin promoters and evaluated gene expression in vitro, towards developing FV vectors that restrict transgene expression to erythroid lineage cells. In summary, here we have established efficient gene marking and in vivo selection using a FV vector with a therapeutic transgene and MGMT-P140K for a monogenic erythroid disease in a large animal model. Our findings suggest this approach may be effective for other severe erythroid diseases such as hemoglobinopathies.

345. Zinc Finger Nuclease Mediated Safe Harbor Targeted Gene Transfer in Patient iPSCs Functionally Corrects X-Linked Chronic Granulomatous Disease

Colin L. Sweeney,¹ Jizhong Zou,² Bin-Kuan Chou,² Uimook Choi,¹ Jason Pan,¹ Hongmei Wang,¹ Sarah N. Dowey,² Linzhao Cheng,² Harry L. Malech.¹

¹Laboratory of Host Defenses, National Institute of Allergy & Infectious Diseases, National Institutes of Health, Bethesda, MD; ²Division of Hematology, Department of Medicine, and Stem Cell Program, Institute for Cell Engineering, Johns Hopkins University School of Medicine, Baltimore, MD.

X-linked chronic granulomatous disease (X-CGD) is a defect of neutrophil microbicidal reactive oxygen species (ROS) production resulting from gp91^{phox} deficiency, caused by a variety of mutations throughout the *CYBB* gene. We have developed induced pluripotent stem cells (iPSCs) from patients with X-CGD, and have demonstrated that mature neutrophils differentiated from X-CGD iPSCs lack ROS production, reproducing the defining characteristic phenotype of this disease. Utilizing zinc finger nucleases to facilitate homologous recombination, we have achieved high-efficiency targeted transfer of a therapeutic *CYBB* minigene into the safe harbor AAVS1 locus in X-CGD iPSCs from two patients with *CYBB* mutations in exon 5 or in the splice donor site of intron 10. Following puromycin selection for targeted gene transfer, iPSC clones were screened for evidence of off-target insertions or other changes. We observed that 78% (28/36) of corrected clones contained targeted vector insertion into a single AAVS1 allele without off-target inserts. Of these, approximately 50% contained small deletions or insertions at the non-targeted wild-type AAVS1 allele due to non-homologous end joining, while no mutations were detected at the top 10 predicted off-target sites for the AAVS1 zinc finger nucleases. After screening for single copy targeted insertion without additional genetic changes, corrected clones were found to exhibit sustained expression of gp91^{phox} and maintained normal karyotype and full pluripotency as measured by pluripotency markers and *in vitro* embryoid body and *in vivo* teratoma assays. Upon neutrophil differentiation, the corrected clones exhibited functional restoration of ROS production (27-42% of differentiated cells positive for oxidase by dihydrorhodamine flow cytometry assay, compared to 0.4-0.9% for neutrophils from uncorrected X-CGD iPSCs, or 23-39% for neutrophils from normal control iPSCs), at mean fluorescence intensity levels up to 80% of normal controls. Our findings demonstrate that precise safe harbor minigene targeting can be utilized for the correction of X-CGD using zinc finger nucleases in iPSCs from patients with different *CYBB* mutations, an approach that might also be applied to other monogenic diseases.

346. Long-Term Correction of Canine Leukocyte Adhesion Deficiency with a SIN Lentiviral Vector Using the Human PGK Promoter Expressing Canine CD18

Michael J. Hunter,¹ Huifen Zhao,² Laura M. Tuschong,¹ Tanya H. Burkholder,³ Derek A. Persons,² Dennis D. Hickstein.¹

¹Experimental Transplantation and Immunology, National Cancer Institute, NIH, Bethesda, MD; ²Department of Hematology, St. Jude Children's Research Hospital, Memphis, TN; ³Division of Veterinary Resources, Office of Research Services, NIH, Bethesda, MD.

Hematopoietic stem cell gene therapy would be considerably enhanced by the development of vectors utilizing cellular promoters to express the therapeutic transgene in the target cell population by reducing the risk of insertional mutagenesis observed with viral promoters. We sought to develop and identify a modified cellular promoter cassette in a lentiviral vector for our target disease, canine

leukocyte adhesion deficiency (CLAD), the homologue of Leukocyte Adhesion Deficiency-1 (LAD-1) in children. In both CLAD and LAD-1, mutations in the leukocyte integrin CD18 result in the inability to express CD11/CD18 heterodimers on the leukocyte surface leading to life-threatening bacterial infections. We compared three cellular promoters: human phosphoglycerate kinase (PGK), Elongation factor 1 α (EF1 α)-Short, and EF1 α -Long, to the viral Murine Stem Cell Virus (MSCV) promoter. The four promoters were cloned into a SIN lentiviral vector (pCL20c) upstream of the canine CD18 cDNA, and the viral supernatant from each vector was used to transduce CLAD CD34+ cells. In an in vitro transduction of CLAD CD34+ cells at an MOI of 10 with 24 hours of pre-stimulation with cytokines, and a subsequent 24-hour transduction, the hPGK promoter vector directed the highest percentage of CD18+ cells of the cellular promoters with 18% of cells positive for CD18 by day 14. This result was comparable to the number and percentage of CD18+ cells using the MSCV vector. We used the SIN lentiviral vector containing the hPGK promoter to treat two dogs with CLAD. Autologous, CLAD CD34+ cells were pre-stimulated for 24 hours, transduced overnight at an MOI of 10, and infused following a single, non-myeloablative dose of 8mg/kg busulfan. The percentage of CD18+ leukocyte compartments 12 months following infusion of the two dogs were: CD18+ neutrophils 1.8% in dog P1 and 5.4% CD18+ in dog P2; CD3+ T-lymphocytes 13.1% CD18+ in dog P1 and 22.0% CD18+ in dog P2; CD14+ monocytes 3.5% CD18+ in dog P1 and 11.5% CD18+ in dog P2; CD21+ B-lymphocytes 2.2% in dog P1 and 7.4% in dog P2. Clinically, both vector-treated dogs have had complete reversal of the CLAD phenotype. In contrast, untreated CLAD dogs succumbed to overwhelming infection within a few months of life. These results with the human PGK promoter in a SIN lentiviral vector and a non-myeloablative conditioning regimen are relevant for gene therapy of children with human LAD-1.

347. Gamma-Retroviral Salvage Gene Therapy for Two Children with Chronic Granulomatous Disease

Ulrich Siler,¹ Janine Reichenbach,¹ Anna Pruzynski,² Manfred Schmid,² Christof von Kalle,² Manuel Grez,³ Reinhard Seger.¹
¹*Immunology/Hematology/BMT, University Children's Hospital, RCC, Zürich, Switzerland;* ²*National Center for Tumor Diseases (NCT) and German Cancer Research Center (DKFZ), Department of Translational Oncology, Heidelberg, Germany;* ³*Georg-Speyer-Research Institute, Frankfurt a.M., Germany.*

Two children with X-linked CGD and therapy-refractory aspergillosis, age 5 (p1) and 8 (P2) years, received gammaretroviral salvage gene therapy after submyeloablative chemotherapy with Busulphan IV. Invasive Aspergillosis was eradicated within 8 weeks after expressing therapeutic gp91phox and reactive oxygen metabolite levels (15% and 30% oxidase positive cells, respectively). The children recovered from life-threatening paraparesis (P1) and respiratory insufficiency (P2). Subsequent myeloid expansion of transduced cells resulted from insertional mutagenesis by the vector and upregulation of Evi-1 expression. Expansion of gene transduced cells was seen in P1 after 1 year and up to 40% by one dominant MDS clone and in P2 after 3 months and up to 90% by two dominant clones (MDS1/CAMTA1 and MDS1/Stat3). While P2 showed beginning myeloid dysplasia (MDS) after 2.4 yr f/up, P1 remains clinically well (no MDS after 5yr f/up). Allogeneic haematopoietic stem cell transplantation has recently been performed for P2 and is planned for P1. A new SIN gamma-retroviral vector with an internal c-fes myeloid enhancer/promoter has been developed to avoid genotoxicity in the next CGD gene therapy study.

348. Alpharetroviral SIN Vectors: Evaluation of Genotoxicity and Long-Term Expression in Hematopoiesis

Julia D. Suerth,¹ Ute Modlich,¹ Martijn H. Brugman,¹ Tobias Maetzig,¹ Verena Thies,¹ Kerstin Kaufmann,² Manuel Grez,² Christopher Baum,¹ Axel Schambach.¹

¹*Hannover Medical School, Hannover, Germany;* ²*Georg Speyer Haus, Frankfurt, Germany.*

Insertional activation of proto-oncogenes and potential vector mobilization pose serious challenges for gene therapy. Comparative analyses of different retroviral vectors have elucidated distinct integromes, highlighting a relatively neutral integration spectrum of alpharetroviral Rous Sarcoma Virus (RSV). However, previously used RSV-based vectors contained viral coding sequences and intact long terminal repeats (LTR). To minimize the risk of vector mobilization and avoid the expression of potentially immunogenic retroviral proteins, we developed a split-packaging system for alpharetrovectors. Viral coding sequences could be completely eliminated from the vector backbone, resulting in a comparatively short leader region containing the packaging signal (<400 bp). Codon-optimization of the gag/pol allowed the production of high-titer vectors in human cells. Furthermore, removing most of the transcriptional elements in the U3 region of the LTR, we generated self-inactivating vectors (Suerth et al., *J Virol* 2010). We were also able to delete major splice sites from the vector backbone, to avoid interference with cellular transcripts processing. Comparing alpharetro-, gammaretro- and lentiviral vectors with identical pseudotypes, we found no major restriction of transduction in murine and human hematopoietic cells. Dose-escalating transduction in an established in vitro immortalisation assay (Modlich et al., *Blood* 2006) indicated that alpha vectors containing a strong retroviral promoter (SFFV) are even less likely than lenti vectors to transform hematopoietic cells by random integration near cellular proto-oncogenes such as Evi1. Overall, the risk to generate robustly growing insertional mutants was ~9-fold lower than for gamma and ~3-fold lower than for lenti. To compare alpha, gamma, lenti vectors containing the same internal expression cassette (SFFV-EGFP-WPRE), we transduced murine hematopoietic cells at low MOI (average copy number per cell <1 for alpha and gamma) and monitored mice (n=8 per vector, observation time 31 weeks) through serial transplantation. The SFFV internal promoter represents a worst case scenario for the risk of both, epigenetic silencing and insertional gene activation. Normalizing EGFP expression with vector copy number, we obtained evidence that epigenetic silencing occurred with all three vector systems. Mimicking a transgene-mediated conditional selective advantage we pooled bone marrow cells of four mice with high gene marking and established robust multilineage expression in serially transplanted mice (n=5 per vector, observation time 17 weeks). Integrome studies by deep sequencing showed that alpha vectors had a significantly reduced risk to integrate near cellular proto-oncogenes and select potentially transformed cells when compared to gamma vectors, for which we found a clone with insertion in the clinically relevant locus Lmo2. Altogether, our studies suggest that alpha vectors offer a reasonable platform for genetic modification of hematopoietic cells, with manageable issues related to locus-dependent epigenetic silencing and insertional mutagenesis.

349. Lentiviral Vectors Using a Ubiquitously Acting Chromatin Opening Element and Endogenous Btk Promoter Restore B and Myeloid Cell Defects in Murine X-Linked Agammaglobulinemia

Hannah Kerns,¹ Blythe Sather,¹ Sara Mamman,¹ Albanus Moguche,² Michelle Brault,¹ Alexander Astrakhan,¹ Byoung Ryu,³ David Rawlings.¹

¹Center for Immunity and Immunotherapies, Seattle Children's Research Institute, Seattle, WA; ²Department of Immunology, University of Washington, Seattle, WA; ³Bluebird Bio, Cambridge, MA.

X-linked agammaglobulinemia (XLA) is a rare immunodeficiency caused by a mutation in the gene encoding Bruton's tyrosine kinase (BTK), a key effector required for B cell receptor-dependent B cell activation and survival. Patients with XLA lack mature B cells and are unable to produce antibodies, leading to chronic and often fatal bacterial infections. In addition to its role in B cell signaling, Btk is expressed in all myeloid subsets and is implicated in signaling downstream of toll-like receptors (TLRs). Current management requires life-long immunoglobulin replacement, an expensive and incompletely protective therapy. Lentiviral (LV) vector gene therapy represents a promising alternative treatment for XLA. In the current study, we focused on development of a LV platform designed to deliver functional levels of Btk in B and myeloid cells while minimizing the risk of insertional mutagenesis. We evaluated a series of huBtk-expressing LV vectors containing the endogenous Btk promoter (Btkp), which is active in B and myeloid, but not T cells. LV were constructed containing Btkp alone or in association with either the immunoglobulin heavy chain enhancer (E_H) or a ubiquitously acting chromatin opening element (UCOE), anticipated to minimize integration position-dependent variegation. In B cells, the E_H Btkp-LV vector mediated high level Btk expression and robust developmental reconstitution. In contrast, the Btkp LV vector led to limited expression and B cell recovery, while the UCOE.Btkp LV resulted in intermediate levels of Btk expression, significant B cell reconstitution and improved B cell signaling. Further, UCOE.Btkp LV rescued primary and secondary T-dependent immune responses to levels equivalent to E_H Btkp LV vector or WT control treated animals. Btk/Tec^{-/-} bone marrow-derived macrophages exhibit marked elevation in TLR-dependent inflammatory cytokine production. All three Btkp-containing LV vectors facilitated significant Btk expression in myeloid cells and each ameliorated deregulated cytokine production in vector treated mice. Notably, mice treated using E_H Btkp (or an alternative E_H-containing LV vector, E_{B29}; previously described by our laboratory) developed high titer antinuclear autoantibodies- perhaps due to increased Btk expression in activated B cells. Importantly, despite significant rescue of B cell function and immune responses, autoantibody production was not observed in UCOE.Btkp LV vector treated mice. In summary, the UCOE.Btkp LV vector mirrors endogenous Btk expression patterns and restores B cell development and B and myeloid function without the evidence for toxicity, representing a safe and effective expression platform for pursuit of XLA gene therapy.

Cancer Immunotherapy - Emphasis on Adoptive T Cell Transfer

350. Adoptive Transfer of "Stem Cell-Like" Anti-Tumor T Cells Can Eradicate Tumors

Nicholas P. Restifo,¹ Christopher D. Morrison,¹ Pawel Muranski,¹ Luca Gattinoni.¹

¹NCI/NIH, Bethesda, MD.

Adoptive cell transfer (ACT)-based immunotherapy can be curative in some patients with metastatic cancer, but the functional and phenotypic characteristics of effective T cells are incompletely elucidated. Using retrospective analysis, we have found that tumor-specific T cells given to patients in clinical trials at the NCI/NIH (Bethesda, MD) contain a diversity of phenotypes, but highly effective cells have longer telomeres, express more CD27 and CD28, and persist longer than cells that are ineffective in patients. We have developed highly realistic mouse models to identify the functional and phenotypic qualities of adoptively transferred T cells that are associated with tumor rejection. We have found that the transfer of fully differentiated, cytolytic-type cells is largely ineffective, but the transfer of less differentiated T cells ("younger" cells) is highly effective. Specifically, we found that Wnt- β -catenin signaling arrested CD8⁺ T cell differentiation and promoted the generation of "T memory stem cells" (TSCM). These self-renewing, multi-potent T cells could be generated using inhibitors of glycogen synthase kinase-3 β or Wnt3a and were several logs more effective than fully differentiated anti-tumor cells in treating mice with large, vascularized tumors. We have also found that CD4⁺ T cells can have strong anti-tumor activities as well, and that signaling through STAT3 during the polarization of Th17 cells creates tumor-specific T cells that are less differentiated than their IFN- γ -producing counterparts and express stem cell-like molecular signature, including high activity of Wnt/ β -catenin pathway. Importantly, we have now identified the phenotypic markers of these stem cell-like undifferentiated T cells in rhesus macaques and in humans. Current effort to generate self-renewing anti-tumor T cell populations involves three major strategies: 1. Arrested development: Maturation of lymphocytes can be slowed or stopped using cocktails of cytokines or Wnt agonists. 2. De-differentiation/re-differentiation: Induced pluripotent stem cells (iPS) generated from lymphocyte cultures can be re-differentiated using the OP9-DL1 (although this process is highly inefficient.) 3. Direct reprogramming: Elucidation of the genetic programs associated with the differentiation of CD4⁺ and CD8⁺ T cells has led to efforts to directly reprogram terminally differentiated lymphocytes into "younger," less differentiated cells. Generation of anti-tumor lymphocytes with the "stem cell-like" attributes of self-renewal and multipotency represents a successful strategy in experimental animals. The adoptive immunotherapy of less-differentiated T cells and may enable the application of regenerative medicine in the clinic.

351. Adoptive Transfer of Autologous IL13-zetakine⁺ Engineered T Cell Clones for the Treatment of Recurrent Glioblastoma: Lessons from the Clinic

Christine E. Brown,¹ Renate Starr,¹ Araceli Naranjo,¹ Christine Wright,¹ James Bading,¹ Julie A. Ressler,¹ Massimo D'Apuzzo,¹ Behnam Badie,¹ Stephen J. Forman,¹ Michael C. Jensen.²

¹Beckman Research Institute, City of Hope National Medical Center, Duarte, CA; ²Center for Immunity and Immunotherapies, Seattle Children's Research Institute, Seattle, WA.

The prognosis of patients with high-grade gliomas remains grim despite improvements in standard therapies including surgery, radiation and chemotherapy. Our research program is focused on the development of novel immunotherapies for malignant gliomas

using genetically engineered cytolytic T lymphocytes (CTLs). We have established methods for genetically engineering and expanding primary human CTLs to express the IL13(E13Y)-zetakine chimeric antigen receptor (CAR). Expanded *ex vivo* IL13(E13Y)-zetakine⁺ CTL retain MHC-independent, IL13R α 2-specific anti-glioma cytolytic activity, maintain CAR-regulated Tc1 cytokine secretion and proliferation *in vitro*, and mediate regression of established human glioblastoma xenografts *in vivo*. Our work has culminated in the initiation of an FDA-authorized feasibility/safety clinical trial (IND#10109) employing intracranial adoptive transfer of autologous IL13(E13Y)-zetakine⁺ CTL clones. Here we present data from three patients, demonstrating the feasibility of this approach and absence of serious side effects. Importantly, our studies establish documented anti-glioma tumor responses following administration of IL13-zetakine⁺ CTLs, and the ability of adoptively transferred T cells to eliminate antigen positive glioma cells. Moreover, we demonstrate that IL13-zetakine⁺ CTLs can target and eliminate the CD133⁺ IL13R α 2⁺ glioma stem-like cells, a therapeutically resistant tumor population with potent tumor-initiating potential. Patients with heterogeneous IL13R α 2 antigen expression eventually recurred, and antigen escape of IL13R α 2^{NEG} glioma tumors appears to be a major mechanism responsible for disease progression. Our clinical data supports the potential of this therapeutic approach, while highlighting the challenges of targeted immunotherapy in settings when tumor antigens are not uniformly expressed by neoplastic cells.

352. *In Vivo* Selection of Gene Modified T Cells by Engineering Resistance to Clinical Immunosuppressive Drugs Mycophenolate Mofetil and Methotrexate

Mahesh Jonnalagadda,¹ Christine E. Brown,¹ Julie R. Ostberg,¹ Wen C. Chang,¹ Stephen J. Forman,¹ Michael C. Jensen.²
¹Cancer Immunotherapeutics & Tumor Immunology, City of Hope National Medical Center/Beckman Research Institute, Duarte, CA;
²Seattle Children's Research Institute, Seattle, WA.

The efficacy of adoptive T cell immunotherapy depends on the persistence of transferred gene modified T cells *in vivo*. In this study we propose selection strategy to select for gene modified T cells *in vivo* with lymphotoxic drugs to increase the frequency of transferred cells over endogenous lymphocyte pools during lymphopenia driven homeostatic expansion. Here we assess two mutated human enzyme transgenes, dihydrofolate reductase double mutant (DHFRdm) and inosine monophosphate dehydrogenase II double mutant (IMPDH2dm), for conferring resistance of engineered T cells to clinically relevant immunosuppressive drugs methotrexate (MTX) and mycophenolate mofetil (MMF, a prodrug of mycophenolic acid, MPA). As proof of concept, this platform was employed to evaluate the *in vitro* and *in vivo* selection of a primary human T cells co-expressing truncated EGFR reporter gene (EGFRt) that lacks cytoplasmic signaling domain. We demonstrate that CD45RO⁺ CD62L⁺ human central memory derived T cells (T_{CM}) engineered using a lentiviral vector to coordinately express EGFRt, DHFRdm (L22F, F31S) and IMPDH2dm (T333I, and S351Y) are resistant to as much as 0.1 M MTX and 2.5 M MPA *in vitro*, respectively. Importantly drug selected T cells that are enriched for expression of EGFRt by *in vitro* drug selection retain T_{CM} cell surface marker CD62L, proliferative potential and cytolytic function. Further, we compared the *in vivo* selection efficiency of EGFRt⁺, DHFRdm⁺, IMPDH2dm⁺ T cells following administration of MTX alone, MMF alone or combined MTX and MMF delivery in NOD scid Il2rg KO (NSG) mice. Our results suggest that expression of DHFRdm allows for potent selection that is more robust than MMF alone and comparable to dual selection with MTX and MMF together. These results set the stage for utilizing DHFRdm-MTX mediated *in vivo* selection to enforce the expression of therapeutic transgenes (e.g.

tumor specific chimeric antigen receptors) and facilitate the selective engraftment of gene modified cells following adoptive transfer.

353. Generating a Chimeric Antigen Receptor To Redirect T-Cell Specificity after Infusion

Sonny O. Ang,¹ Cassie Hartline,¹ Tiejuan Mi,¹ Sourindra N. Maiti,¹ George W. Jackson,² Helen Hul,¹ Elizabeth Shpall,³ Dean A. Lee,¹ Richard E. Champlin,³ Laurence J. N. Cooper.¹
¹Pediatrics, MD Anderson Cancer Center, Houston, TX; ²BioTex Inc., Houston, TX; ³Stem Cell Transplantation, MD Anderson Cancer Center, Houston, TX.

The elimination of tumors by adoptive T-cell immunotherapy is hampered by a metabolically harsh microenvironment, pervasive immunosuppressive T_{regs}, and tumor escape variants. To overcome these obstacles, we have developed a chimeric antigen receptor (CAR) that can be modified after expression to enable genetically modified T cells to target multiple antigens one-by-one, sequentially, or simultaneously, through specific adapters. The CAR platform consists of a single chain variable fragment (scFv) derived from an antibody recognizing fluorescein isothiocyanate (FITC), independent of human leukocyte antigen (HLA), fused to human CD28 and CD3 ζ signaling endodomains to render CAR⁺ T cells specific for FITC. To enable targeting of tumors, FITC-conjugated therapeutic molecules such as monoclonal antibodies, ligands, or nucleic acid-based aptamers which are specific for one or more tumor antigens of interest are employed as adapters. Since FITC is not an endogenous biomolecule CAR⁺ T cells will only recognize FITC-²'painted' target cells (Figure). The FDA has approved the systemic administration use of FITC for ophthalmologic exams as well as nucleic acid-based aptamers designed as therapeutics (e.g. Macugen), rendering the use of FITC-conjugated adapter molecules clinically feasible. We show that using adapter molecules allows for investigators to change the specificity of CAR⁺ T cells, useful in cases of antigen escape variants in tumors under attack. This approach enables one infusion of CAR⁺ T cells to be adapted to meet the changing needs of the tumor microenvironment as the CAR platform has tuneable specificity as opposed to generating a panel of CARs with specificity for a single antigen. In addition, it is possible to mix and match multiple FITC-conjugated adapter molecules to simultaneously target various antigens in different cell types all at once, or to target cells expressing single antigens, or combinations of antigens. To enable T cells to only recognize FITC-conjugated tumor, we have introduced a molecular sensor into the T cells so that the CAR is expressed only under conditions of hypoxia. To enhance the safety of using DNA plasmid for Sleeping Beauty (SB) transposition for T-cell immunotherapy, we engineered a self-inactivating transposase vector (psiT2) to integrate the CAR while preventing continued expression of the transposase. By decoupling antigen targeting and T-cell activation, we can program T cells with a "universal" CAR to treat multiple conditions, making "off-the-shelf" T-cell immunotherapy achievable.

The "universal" CAR approach enables one infusion of CAR⁺ T cells to be adapted to meet the changing needs of the tumor microenvironment as the CAR platform has tunable specificity through adapter molecules. It is possible to mix and match multiple FITC-conjugated adapter molecules to simultaneously target various antigens in different cell types all at once, or to target cells expressing single antigens, or combinations of antigens.

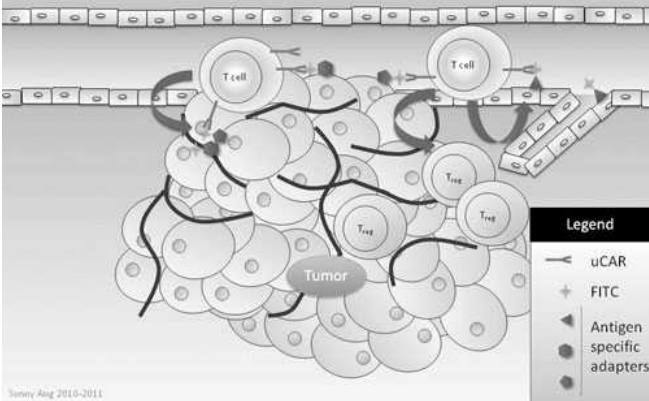

354. Improved Costimulation of CD19-Specific T Cells Transpresenting a Membrane-Bound IL-15

Lenka V. Hurton,¹ Harjeet Singh,¹ Simon Olivares,¹ Laurence J. N. Cooper.¹

¹Pediatrics-Research, M.D. Anderson Cancer Center, The University of Texas-Houston, Houston, TX.

Achieving an optimal therapeutic response in adoptive immunotherapy has been hampered by a lack of *in vivo* persistence. Infusion of interleukin (IL)-2 is used to improve T-cell survival, but is limiting due to severe side effects associated with systemic use and the generation of undesirable T cell phenotypes. IL-15 may be a more suitable molecule as it is a homeostatic cytokine that promotes the survival of memory CD8⁺ T cells and has been shown to re-establish the functionality of T cells. To provide localized IL-15 mediated signaling to T cells, we constructed a version of IL-15 as a membrane-bound molecule (mIL15) designed to stimulate T cells *in cis* and *trans* (Fig. 1A). The mIL15 construct was electro-transferred with a CD19-specific CAR (on day 0) into primary human T cells as two *Sleeping Beauty* DNA transposon plasmids. These genetically modified T cells could be numerically expanded *ex vivo* without additional soluble cytokine supplementation on CD19⁺ artificial antigen presenting cells (aAPC, derived from K562). This resulted in the preferential outgrowth of T cells expressing both mIL15 and CAR while CAR⁺ T cells receiving no soluble cytokine supplementation did not sustain proliferation (Fig. 1B). Notably, in our culture system mIL15-modified T cells acted in synergy with exogenous IL-21 to achieve superior expansion (Fig. 1B) and exhibited effector and central memory phenotypes. Under antigen and soluble cytokine-free conditions, the mIL15⁺CAR⁺ T cells persisted a minimum of 29 days *in vitro* while CAR⁺ T cells that were originally propagated on IL-2 and IL-21 were no longer viable at this time point. Signaling through the IL-15 receptor complex in mIL15⁺CAR⁺ T cells was confirmed by phosphorylation of STAT5. Using mixing experiments, it was demonstrated that IL-15-mediated signaling could be achieved via the physiologically relevant model of *trans* presentation as well as through *cis* interactions. These mIL15⁺CAR⁺ T cells exhibited comparable redirected specific lysis of CD19⁺ tumor targets as well as IFN- γ , RANTES, MIP1- α , and TNF- α secretion. These data demonstrate that mIL15 can be expressed by CAR⁺ T cells to enhance their proliferation and persistence without the need for exogenous cytokine support. The use of this fusion molecule: (i) provides stimulatory signals via STAT5 resulting in augmented T cell expansion without compromising tumor-specific functionality, (ii) mitigates the need for IL-2 for T-cell expansion and persistence, (iii) by-passes a reliance on clinical-grade IL-15, and (iv) presents the cytokine in a localized and physiologically relevant context (*trans*) as

well as *cis*. These results have implications for the design of clinical trials to evaluate whether mIL15⁺CAR⁺ T cells can exhibit enhanced persistence *in vivo* and thus improve therapeutic potential.

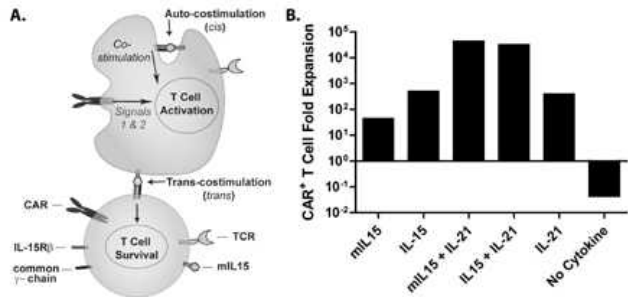

Figure 1. A.) Schematic of constitutively expressed mIL15 and CAR in genetically modified T cells. The CAR contributes both signals one and two for T cell activation via CD3 ζ and CD28 endosomal signaling while mIL15 with its receptor complex contributes additional costimulatory signaling. B.) Fold expansion of CAR⁺ T cells with and without co-expression of mIL15 under various soluble cytokine supplementation conditions. The mIL15 and CAR co-modified T cells cultured with soluble IL-21 expanded comparably to the respective soluble cytokine control.

355. Gene Transfer to Hematopoietic Stem/Progenitor Cells as a Novel Approach for Immunotherapy Against B-Lineage Malignancies

Satiro N. Oliveira,¹ Christine Ryan,² Francesca Giannoni,³ Cinnamon Hardee,³ Behrood Katebian,⁴ Arineh Sahaghian,³ Roger Hollis,³ Donald B. Kohn.⁵

¹Pediatrics, UCLA, Los Angeles, CA; ²UCLA, Los Angeles, CA; ³Microbiology, Immunology and Molecular Genetics, UCLA, Los Angeles, CA; ⁴California State University, Northridge, Northridge, CA; ⁵MIMG and Pediatrics, UCLA, Los Angeles, CA.

Chimeric Antigen Receptors (CAR) specific against CD19 have been shown to direct T cells to specifically target B-lineage malignant cells in animal models and clinical trials, with efficient tumor cell lysis. But, there has been insufficient persistence of effector cells, limiting its clinical efficacy. We propose gene transfer to hematopoietic stem/progenitor cells (HSPC) as a novel approach to deliver the CD19-specific CAR, as successful modification of progenitors presents a potential method of ensuring persistent production of effector cells targeting B-lineage malignant cells exponentially increasing the number of effectors that may be generated against tumor cells. Assessments were performed using *in vitro* and *in vivo* differentiation of human HSPCs transduced with lentiviral vectors carrying first and second generations of CD19-specific CAR. There was efficient and stable transduction with 1-2 copies of CAR/cell as determined by qPCR. *In vitro* differentiation of modified HSPC revealed that gene transfer did not impair hematopoietic differentiation. Myeloid and NK cells bearing CAR specifically lysed CD19-positive cells. *In vivo* studies in NOD-SCID-IL2 receptor gamma chain null (NSG) mice showed that CAR-transduced human HSPC successfully differentiated into all lineages, populating bone marrow, spleen and peripheral blood. The human CD19⁺ B cell populations formed in the NSG mice were significantly reduced when the transplanted HSPC were transduced with the anti-CD19 CAR. Our results provide evidence for the feasibility and efficacy of the modification of HSPC with CAR as a protocol for generation of effector cells for immunotherapy against B-lineage malignancies.

356. CD8:Class I MHC Interactions Influence T Cell Activity Mediated by Chimeric Antigen Receptors

David H. Aggen,¹ Jennifer D. Stone,¹ Adam S. Chervin,¹ Andrea Schietinger,² Karin Schreiber,² Hans Schreiber,² David M. Kranz.¹
¹Department of Biochemistry, University of Illinois Urbana-Champaign, Urbana, IL; ²Department of Pathology, Committee on Cancer Biology, University of Chicago, Chicago, IL.

One approach to adoptive T cell therapy uses chimeric antigen receptors (CARs) that contain an antibody (scFv) specific for a tumor-associated antigen. CARs derived from antibodies were originally conceived to target non-MHC restricted antigens, and unlike most full-length T cell receptors, should in principle be able to redirect T cell activity independent of the coreceptors CD4 or CD8. To examine the ability of a single-chain fragment variable (scFv) CAR to redirect T cells to tumor antigen, we used a model murine scFv, called 237, to redirect T cell activity against a tumor-specific antigen. The 237 antibody recognizes a mutated glycopeptide expressed by an aggressive murine fibrosarcoma tumor cell line called Ag104a. The tumor-specific glycopeptide is generated as a result of a mutated chaperone protein Cosmc that when repaired, ablates the 237 neo-epitope. Using a CAR that consisted of the 237 scFv fused to the intracellular signaling domains of CD28, CD3 ζ , and Lck, we demonstrate here that T cell specific activation occurred in the presence of the Ag104a tumor line, but not in the presence of a cell line with a repaired chaperone protein that lacks the tumor antigen (ACosmc). To assess whether CD8 plays any role in the activation, we generated a T cell hybridoma line that expressed the 237 CAR, with and without CD8. The CD8- 237 and CD8+ 237 expressing cells mediated similar activation with Ag104a tumor cells. However, when the 237 CAR lines were incubated with plate-bound glycopeptide antigen, the CD8+ line was completely inactive, whereas the CD8-line was stimulated effectively. Thus, CD8 expression inhibited antigen-specific activity when antigen was targeted that lacked MHC Class I. We propose that Lck sequestration by the co-receptors away from the immunological synapse reduced signaling mediated by interactions with non-MHC ligands. Additional lines of evidence included the inhibition of activity of the 237 CAR/CD8 line, in the presence of the Ag104a APC, with an antibody to CD8. In the normal activation of CD8+ T cells, CD8 with its associated Lck co-localizes at the immunologic synapse with T cell receptors, facilitating efficient T cell responses. CD8 contributed to CAR mediated activity, presumably through interactions with class I MHC molecules that cluster near the scFv antigen epitopes. This observation that class I MHC can facilitate the activity of a CAR through a CD8-dependent mechanism has important implications for CARs directed against non-MHC antigens in tumor immunotherapy. For example, reduced class I MHC levels on a patient's tumor cells may reduce the efficacy of CAR-mediated T cell activity by allowing Lck to be sequestered away from the synapse. Support from NIH Program Project # P01 CA097296

357. Genetically Engineered T-Cells Targeting Cancer Associated Fibroblasts for Cancer Immunotherapy

Sunitha Kakarla,^{1,3} Lisa Wang,¹ David Rowley,¹ Klaus Pfizenmaier,² Stephen Gottschalk.^{1,3}
¹Translational Biology and Molecular Medicine, Baylor College of Medicine, Houston, TX; ²Institute of Cell Biology and Immunology, University of Stuttgart, Stuttgart, Germany; ³Center for Cell and Gene Therapy, Baylor College of Medicine, Houston, TX.

Introduction: Adoptive T-cell therapy has had considerable success in effectuating antitumor responses, however complete eradication of bulky disease is rarely observed. This limited efficacy

is most likely due to the tumor stroma, which is not targeted by tumor-specific T cells. Cancer associated fibroblasts (CAFs), the central component of the tumor stroma, secrete inhibitory factors and nutrient depleting enzymes that are detrimental to effector T-cell function. In addition, CAFs promote angiogenesis and secrete extracellular matrix components, which act as a physical barrier. CAFs express fibroblast activation protein (FAP), a membrane bound serine protease, which is an attractive immunotherapeutic target. The aim of this project was to generate FAP-specific T cells and determine if targeting the tumor stroma with FAP-specific T cells has antitumor effects. **Methods:** To generate FAP-specific T cells we took advantage of chimeric antigen receptors (CARs), which consists of antigen-specific single chain variable fragments (scFv) linked to T-cell receptor signaling domains. Using this approach we generated 2 CARs, which are specific for human FAP (hFAP) or human and murine FAP (mhFAP). T cells expressing hFAP-CARs or mhFAP-CARs were generated by retroviral transduction (hFAP- or mhFAP-T cells). Ex vivo, efficacy of hFAP- and mhFAP-T cells was determined by their ability to 1) secrete cytokines in coculture experiments with FAP-positive tumor or stroma cells, and 2) kill FAP-positive targets in cytotoxicity assays. To test *in vivo*, if selective targeting of FAP on tumor stroma prevents the development of human tumors in a xenograft model, we took advantage of lymphoblastoid cell lines (LCL), which are FAP-negative. **Results:** hFAP-CARs or mhFAP-CARs were successfully expressed on T cells as judged by FACS analysis. hFAP- T cells recognized FAP-positive human tumor and stroma cells as judged by cytokine production and cytotoxicity assays. In addition to recognizing human FAP positive targets, the mhFAP-T cells also recognized and killed murine FAP targets. To evaluate if targeting the tumor stroma, prevents the development of tumors, FAP-negative, luciferase-expressing LCLs, were mixed with hFAP, mhFAP-, or nontransduced T cells prior to the s.c. injection into flanks of SCID mice. While LCLs tumor readily established in mice injected with LCL/hFAP-T cells or LCL/NT-T cells; LCL tumor growths was 10 to 100 fold slower in mice injected with LCL/mhFAP-T cells as judged by serial bioluminescence imaging. **Conclusions:** Our results indicate that targeting FAP-positive stroma with T cells delays the development of tumors in human xenograft models. Thus, targeting the tumor stroma in addition to cancer cells with FAP-specific T cells has the potential to improve current immunotherapy approaches for cancer.

Cancer-Oncolytic Viruses

358. Systemic Combination Virotherapy for Malignant Melanoma with Vesicular Stomatitis Virus and Adoptive T Cell Transfer

Diana M. Rommelfanger,^{1,2} Phonphimon Wongthida,¹ Karen K. Kaluza,^{1,3} Rosa M. Diaz,^{1,3} Jill M. Thompson,¹ Timothy J. Kottke,¹ Richard G. Vile.^{1,3}

¹Department of Molecular Medicine, Mayo Clinic, Rochester, MN; ²Department of Molecular Pharmacology and Experimental Therapeutics, Mayo Clinic, Rochester, MN; ³Department of Immunology, Mayo Clinic, Rochester, MN.

Our goal is to develop truly systemic virotherapy treatment regimens for metastatic cancer that do not necessitate direct intratumoral injection. We have shown in the B16ova melanoma model that combining adoptively transferred OT-I T cells (1×10^6 naïve cells), which are specific for the surrogate tumor-associated antigen (TAA) OVA, with intratumoral VSV (5×10^8 PFU) encoding the OVA antigen (VSV-ova) results in regression of established tumors and an enhancement of survival compared to either treatment alone ($p < 0.00001$, $p = 0.052$ respectively). Comparable results were obtained when combination treatments targeting the endogenous melanoma TAA gp100 (gp100-specific PMEL T cells + VSV-gp100) were

administered ($p < 0.00001$ compared to PMEL T cells alone, $p = 0.016$ compared to VSV-gp100 alone). We also showed that combining adoptively transferred T cells with intratumoral virus results in activation of a potent, tumor-specific T cell response that is able to target and eliminate both the injected and, importantly, uninjected tumors. Therefore, we are currently developing a fully systemic regimen that is designed to provide efficacious anti-tumor therapy, even for tumors that are inaccessible to the end of a needle. In this respect we have shown that combining PMEL T cells (1×10^6 naïve cells) with intravenous VSV-gp100 (5×10^7 PFU) provides significant survival benefit over the individual treatments ($p = 0.0001$, $p = 0.0002$ respectively). Presently, we are working to improve upon the number of long-term regressions by refining the timing of the T cell and virus injections and investigating further combinations targeting additional tumor antigens. Mechanistic studies are also ongoing and indicate that intravenous, TAA-expressing virus promotes the survival and activation of the adoptively transferred T cells in the tumor-draining lymph nodes and spleen, which is critical for the observed therapy. More specifically, intravenous VSV-gp100 results in a significantly greater persistence of PMEL T cells than the control treatments of intravenous and intratumoral VSV-GFP ($p < 0.001$), intravenous and intratumoral PBS ($p < 0.002$) as well as intratumoral VSV-gp100 ($p < 0.01$). These data will lead to clinically-relevant, completely systemic virotherapy protocols for cancer patients, melanoma and otherwise, that have a dismal prognosis with the currently available treatments.

359. Enhancing Therapeutic Index of Oncolytic Vaccinia Virus through Combining MicroRNA Regulation and Thymidine Kinase Deletion

Mina Hikichi,¹ Minoru Kidokoro,² Hisatoshi Shida,³ Hideaki Tahara,¹ Takafumi Nakamura.^{1,4}

¹Institute of Medical Science, Tokyo University, Tokyo, Japan;

²National Institute of Infectious Diseases, Musashimurayama,

Japan; ³Institute for Genetic Medicine, Hokkaido University,

Sapporo, Japan; ⁴PRESTO, Japan Science and Technology Agency, Kawaguchi, Japan.

Vaccinia virus, once widely used for smallpox vaccine, has been engineered and used as an oncolytic virus for cancer virotherapy. We have previously shown that microRNA (miRNA) regulation enables tumor-specific viral replication by altering the expression of a targeted viral gene of an attenuated vaccinia virus vaccine strain LC16m8, which is an attractive backbone because of extremely low neurovirulence profile. Since the deletion of viral glycoprotein B5R not only decreases viral pathogenicity but also impairs the oncolytic activity of vaccinia virus, we used miRNA-based gene regulation to suppress B5R expression through let-7a, a miRNA that is downregulated in many tumors. In mice with s.c. human pancreatic cancer xenografts, intratumoral administration of miRNA-regulated vaccinia virus (MRVV) with target sequences complementary to let-7a in the 3'-untranslated region (3'UTR) of the B5R gene resulted in tumor-specific viral replication and significant tumor regression without side effects, although all of the mice treated with the control let-7a_{mut} virus containing insertion of the disrupted miRNA target sequences died or were sacrificed on days 39–59 due to the virus-associated toxicity, such as pock lesions on body surfaces and weight loss. On the other hand, our recent study has shown that MRVV escapes from the cellular miRNA system in another therapy model, where the control let-7a_{mut} virus causes death on days 24–43 earlier than the intratumoral therapy model. Although intraperitoneal injection of MRVV on day 0 (1×10^7 pfu per mouse) in mice with the i.p. xenografts significantly prolonged survival compared with that of the control let-7a_{mut} virus, all of the mice treated with MRVV finally died or were sacrificed on days 32–52 due to the viral toxicity. Sequence analysis did not show any mutations in the target inserts

of MRVV which is recovered from pock lesions on their tail 35 days after virus administration, suggesting that there are other possibilities such as miRNA saturation. In an effort to address this toxicity, we have developed a combined miRNA-regulated and thymidine kinase-deleted vaccinia virus (MDVV) and investigated its properties in the same intraperitoneal therapy model. The expression cassette encoding luciferase and EGFP was inserted into the A56R or J2R locus of MRVV by homologous recombination, resulting in MRVV-LG or MDVV-LG respectively. Intraperitoneal administration of MDVV-LG significantly prolonged survival compared with that of MRVV-LG and mock therapy. Furthermore, all of the mice treated with MDVV-LG did not show any symptoms of viral toxicity at the end of the experiment. Our study demonstrated that multi-mechanistic regulation of oncolytic vaccinia viruses through combining incorporation of specific miRNA target sequences into the 3'UTR of B5R gene and insertional inactivation of vaccinia virus gene encoding thymidine kinase enhances the safety profile, tumor specificity and therapeutic index.

360. Engineering Viruses To Enhance and Monitor Systemic Oncolytic Efficacy

Shruthi Naik,¹ Rebecca Nace,¹ Glen Barber,² Stephen J. Russell.¹

¹Department of Molecular Medicine, Mayo Clinic, Rochester, MN;

²Department of Microbiology & Immunology, University of Miami School of Medicine, Miami, FL.

The need for potent systemically delivered therapies prompted us to engineer Vesicular stomatitis virus (VSV) to enhance both viral cytolytic activity and immunogenicity to treat Multiple Myeloma (MM), an incurable disseminated plasma cell malignancy. VSV is a rapidly replicating oncolytic vector that preferentially replicates in and kills tumor cells. We demonstrate here a single systemic administration of VSV coding for IFN β (VSV-IFN) has potent activity in treating both subcutaneous and disseminated 5TGM1 myeloma in syngeneic C57KaLwRij mice. VSV administration in mice bearing disseminated myeloma transiently reduced myeloma burden, delayed overall myeloma progression and significantly prolonged survival. Expression of murine IFN β significantly enhanced therapeutic activity. We re-engineered VSV to induce increased expression of Interferon- β (IFN) and the Sodium Iodide symporter (NIS) transgenes, to improve viral toxicity profile, enhance IFN β mediated oncolytic efficacy and to allow noninvasive imaging of viral bio-distribution following systemic administration. Similar to previous findings, a single intravenous dose of VSV-IFN-NIS induced complete regression of subcutaneous 5TGM1 myeloma tumors with a significantly reduced tumor relapse rate of tumors in mice treated with VSV-mIFN-NIS (expressing murine IFN β). Non-invasive SPECT-CT imaging using Tc-99m shows tumor specific viral gene expression by 24h and viral activity occurs within the first week post viral administration. The speed of viral activity indicated by in vivo imaging prompted further analysis of treated tumors providing detailed visualization of the key steps of viral entry and oncolysis. Viral extravasation is distributed throughout the tumor parenchyma infecting clusters of tumor cells without infecting blood vessel endothelial cells. Localized spread of infectious centers forms rapidly expanding foci of infection that subsequently coalesce to destroy tumors by 48–72h following treatment. Preliminary results have demonstrated similar ability of systemically administered to pervade and destroy MPC-11 myeloma tumors in immune competent Balb/c mice emphasizing the potent ability of VSV to effectively eradicate myeloma tumors in vivo by direct viral spread and oncolysis. Further studies using antibodies to suppress T-cells revealed T-cell activity mediated IFN β -induced prevention of tumor relapse. Overall, the data provides clear evidence that engineered VSV-IFN-NIS specifically and rapidly eliminates tumor cells following systemic administration. Viral activity can

be monitored non-invasively and IFN β prevents tumor relapse and enhances therapeutic efficacy by stimulating T-cell mediated clearance of residual tumor cells.

361. Systemic Delivery of Reovirus in Combination with Carefully Scheduled Chemotherapy Cures Established Tumors

Timothy Kottke,¹ Jill Thompson,¹ Rosa Diaz,¹ Phonphimon Wongthida,¹ Diana Rommelfanger,¹ Gerry Nuovo,² Matt Coffey,² Peter Selby,² Hardev Pandha,² John Chester,² Kevin Harrington,² Alan Melcher,² Richard Vile.^{1,2}
¹Mayo Clinic, Rochester, MN.

We have reported previously that modulating the levels of VEGF supplied to tumor associated endothelium can induce a pro-viral state in endothelial cells which facilitates the replication of systemically delivered Reovirus. In turn, this leads to vascular destruction *in vivo* - both through direct viral cytolysis as well as immune mediated vascular attack - which produces significant tumor regressions, and cures, upon systemic administration of Reovirus (*J.Clin.Invest.*, 2010; **120**: 1551). We have now gone on to show that VEGF conditioning of tumor associated endothelium occurs through two distinct signaling pathways. In the first, viral replication is facilitated in endothelial cells through VEGFR2 signaling. In the second, Reovirus-infected endothelial cells acquire sensitivity to NK cell attack through VEGFR1 signaling. Since the administration of VEGF to cancer patients may be clinically difficult, we screened for chemotherapeutic agents which could be more readily used in patients and which could induce the pro-viral state associated with tumor regressions *in vivo*. In this respect, treatment of both murine and human endothelial cells *in vitro* with paclitaxel inhibits both Reovirus replication and induction of sensitivity to immune attack. However, if endothelial cells are exposed to paclitaxel but are then allowed to recover in the presence of tumor cell-derived VEGF, the pro-viral state is potently induced dependent upon VEGFR2 signaling, leading to viral replication and endothelial cell destruction. These *in vitro* results translated into highly significant *in vivo* cures of B16 tumors upon carefully scheduled administration of paclitaxel and systemic Reovirus. Moreover, therapy of established B16 tumors was also achieved using T cell-mediated delivery of Reovirus to overcome high levels of neutralizing antibody to Reovirus. Overall, our data show that careful scheduling of administration of clinically relevant chemotherapy can facilitate the systemic delivery of oncolytic virus to generate significant therapy of established tumors. The direct translation of this approach into clinical trials will be discussed.

362. Vstat120 Modulates the Innate Pro-Inflammatory Response to Oncolytic Virus

Jayson Hardcastle,¹ Jeffrey Wojton,^{2,3} Eric Wohleb,³ W. Hans Meisen,¹ Christopher Alvarez-Breckenridge,¹ M. Oskar Nowicki,² Jonathan Godbout,³ Balveen Kaur.²

¹Integrated Biomedical Science Program, Department of Neurosurgery, The Ohio State University, Columbus, OH;

²Department of Neurosurgery, Dardinger Laboratories, The Ohio State University, Columbus, OH; ³Neurosciences Graduate Studies Program, The Ohio State University, Columbus, OH.

Oncolytic virus (OV) therapy is a promising cancer therapy. Vstat120 is antiangiogenic extracellular fragment of Brain Angiogenesis Inhibitor-1 (BAI1). BAI1 has also been shown to function as an engulfment receptor on macrophages. We have also found expression of BAI1 in microglia. Both microglia and macrophages have been implicated in limiting OV efficacy by clearing out the virus once it has been injected. We have previously engineered and tested an OV that expresses Vstat120: RAMBO (**R**apid anti-**A**ngiogenesis **M**ediated **B**y **O**ncolytic virus) and have shown it to

have a significantly increased anti-tumor efficacy. We hypothesized that Vstat120, produced by RAMBO would inhibit phagocytosis of infected glioma cells, increasing OV efficacy. We have found that Vstat120 inhibits phagocytosis of carboxylate beads coated with concentrated CM from RAMBO, HSVQ, and uninfected glioma cells by N13, and BV2 murine microglia at numerous time-points ($p < 0.05$). RAMBO also inhibits BV2, N13, and primary murine microglia migration towards infected glioma cells ($p < 0.05$). In-vivo FACS analysis of U87 Δ -EGFR intracranial gliomas treated with RAMBO or HSVQ revealed a significant increase in macrophage infiltration into the tumor treated by HSVQ ($p < 0.05$). Monocytic activation markers Ly6-C, MHC-II, CD86, and CD206 were significantly down regulated for both microglia and macrophages infiltrating into the tumor environment treated with RAMBO compared to HSVQ ($p < 0.05$ for all) as assessed by FACS analysis. QPCR experiments using murine specific primers for primary murine microglia co-culture experiments and human glioma cells infected with RAMBO or HSVQ showed a significant down regulation of IFN- α , IFN- β , IFN- γ , IL-6, IL-8, MCP-1 murine mRNA ($p < 0.05$ for all). OV gene copy assays from BV2 microglia and RAMBO or HSVQ treated glioma co-culture experiments showed a significant increase in RAMBO gene copy vs. HSVQ gene copy 12 hrs post co-culture initiation ($p < 0.05$). In-vivo QPCR for ICP4 and OV gene copy from intracranial U87 Δ -EGFR tumors treated with either RAMBO or HSVQ showed a dramatic increase in ICP4 mRNA and OV gene copy for RAMBO treated tumors compared to HSVQ treated tumors ($p < 0.05$ for both), indicating a significant increase in RAMBO replication *in-vivo*. This is the first study examining the immune modulatory effects of Vstat120 on the role of microglia in OV therapy.

363. Vaccine, but Not Wild-Type, Measles Virus Infection Has Pleotropic Effects on Human Neutrophil Function – A Mechanistic Insight into the Effects of an Oncolytic Virus on the Innate Immune System

Yu Zhang,¹ Lena Rai,¹ Bella Patel,¹ Aditi Dey,¹ Anna Castleton,¹ Adele K. Fielding.¹

¹Academic Haematology, University College London, London, United Kingdom.

Numerous studies implicate neutrophils in eliminating tumour cells following cancer treatments. We showed previously that neutrophils play a role in regression of human B-cell tumours in SCID mice following oncolytic measles virus (MV) treatment. Here we sought, using normal human neutrophils, to identify potential mechanisms for such effects. We compared the effects of oncolytic, vaccine MV (MV-Moraten) with a wild-type strain MV-Dublin (MV-WT) to delineate mechanisms of oncolysis. First, we showed that human neutrophils express CD46 but not SLAM. We confirmed by RT-PCR for MV-N RNA and expression of surface MV-H that neutrophils were efficiently infected by MV-Moraten *in-vitro*. Despite lacking SLAM, MV-WT-infected neutrophils expressed MV-N at the same level and within the same time frame, indicating MV-WT also efficiently infected neutrophils. However, MV-H was not detected on the surface of WT-MV infected neutrophils. Neutrophils became activated as evaluated by L-selectin shedding and lived longer *ex-vivo* after infection with both MV-Moraten and MV-WT. Next, we examined the expression of mRNA and protein for several pro-inflammatory cytokines and chemotactic proteins which are known to have an impact on the immune response to cancer. The mRNA for IL-8, TNF- α and MCP-1 was upregulated by 7-, 89- and 120-fold respectively upon MV-Moraten infection; significantly higher than the 3-, 5- and 12-fold increase upon MV-WT infection (all $p < 0.05$). No up-regulation was observed in uninfected controls. Significantly higher level of the corresponding IL-8 (14068 \pm 2710pg/ml), TNF- α (670 \pm 370pg/ml), MCP-1 (2369 \pm 750pg/ml), and IFN- α (78 \pm 24pg/

ml) (n=11) proteins were detected in supernatant from MV-Moraten-infected neutrophils than the uninfected control or MV-WT (levels similar to the controls) ($p < 0.01$). Only one of the molecules evaluated, TRAIL was secreted from MV-Moraten infected neutrophils without a concomitant up-regulation of TRAIL mRNA. Inhibiting protein synthesis with cycloheximide did not reduce MV-induced TRAIL secretion, suggesting that pre-formed TRAIL was secreted from granules. Hence, we evaluated neutrophil de-granulation by FACS in response to MV infection (n=7). A significant enhancement of CD66b and CD63 expression (specific granule and azurophil granule markers) on neutrophil cell surface confirmed that MV-Moraten induced neutrophil degranulation, whereas MV-WT did not. These data suggest that MV-Moraten can directly stimulate neutrophil immunoregulatory and anti-tumor functions causing both de-novo protein synthesis and degranulation. Our data provide the first documented example of a differential effect between an attenuated, oncolytic virus and its wild-type counterpart on the innate immune system. The contrast between the effects of MV-Moraten and MV-WT in this regard are not simply due to the fact that MV-WT does not infect neutrophils since abundant MV-N RNA was detected in both cases. The distinct innate immune responses elicited by MV-Moraten may play an essential role in oncolysis *in-vivo* and require merit further investigation during clinical studies.

364. Cyclophosphamide Controls the Humoral Response to Oncolytic Viruses

Kah-Whye Peng,¹ Andrew Greenslade,¹ Rae Myers,¹ Emily K. Mader,¹ Suzanne M. Greiner,¹ Mark J. Federspiel,¹ Stephen J. Russell.¹

¹Molecular Medicine, Mayo Clinic, Rochester, MN.

Oncolytic viruses can be neutralized in the bloodstream by antiviral antibodies whose titers increase progressively with each exposure, resulting in faster virus inactivation and further reductions in efficacy with each successive dose. Here we evaluated if cyclophosphamide, which kills proliferating lymphocytes, can be used to modulate these counterproductive antiviral antibody responses during virotherapy. In virus-susceptible mice, primary antibody responses to oncolytic measles virus or Vesicular Stomatitis Virus (VSV) were completely suppressed by a high dose cyclophosphamide regimen initiated one day before virus administration. Lower doses of cyclophosphamide slowed the kinetics of the primary antibody response and lowered maximum titers. When measles-immune or VSV-immune mice were re-challenged with the respective viruses and concurrently treated with high dose cyclophosphamide, their anamnestic antibody responses were completely suppressed, and their antiviral antibody titers fell significantly below pre-booster levels. Antibody titers declined still further after additional exposures to the virus with concurrent high dose cyclophosphamide, at least as much as when cyclophosphamide was given without the virus booster. In immunocompetent tumor-bearing mice, VSV could be administered repeatedly by the intravenous route with cyclophosphamide without provoking an antibody response, and leading to more efficient virus delivery to sites of tumor growth. We conclude that cyclophosphamide should be used in combination with oncolytic virotherapy to control the antiviral antibody response.

365. Inhibition of Rho Associated Coiled-Coil Forming Kinase Increases Efficacy of Measles Virus Infection

Mateusz Opyrchal,¹ Ianko Iankov,¹ Cory Allen,¹ Evanthia Galanis.¹

¹Molecular Medicine, Mayo Clinic, Rochester, MN.

BACKGROUND: Attenuated measles virus (MV) is a promising oncolytic agent in cancer virotherapy and it has been shown to have robust antitumor effect against wide range of cancer cells both *in vitro*

and *in vivo*. MV strains exert their cytopathic effect by inducing cell fusion and syncytia formation. RhoA and its downstream effector, Rho associated coiled-coil forming kinase (ROCK) are known regulators of formation of actin cytoskeleton in cells. Regulation of RhoA and actin cytoskeleton is known to influence paramyxovirus associated cell fusion. The two isoforms of ROCK (ROCK1 and 2) are ubiquitously expressed in all human cells and the ROCK inhibitor, Y27632, has been shown to inhibit hepatic and prostate cancer metastases in mouse models. Y27632 and other specific ROCK inhibitors are being tested as anti-neoplastic agents. We hypothesized that the combination therapy of Y27632 and MV could improve MV mediated oncolysis through enhanced cell fusion and increase in syncytia size. **RESULTS:** The hypothesis was tested *in vitro* on three cancer cell lines. First we assessed the effect of Y27632 cell proliferation against prostate cancer (PC-3), glioblastoma (U251) and breast cancer (MDA-MB-231) cells. Concentrations with minimal effect on cell proliferation were employed in combination experiments (100 nM, 25 nM and 150 nM respectively). The effect of Y27632 on MV cytopathic effect was explored next. Cells infected with MV while concurrently treated with Y27632 showed increased cytopathic effect of the virus as assessed by trypan blue exclusion assays. This effect was dependent on the concentration of the inhibitor in MDA-MB-231 cells. Next we tested the effect of the ROCK inhibitor on viral proliferation. In all three cell lines, there was a significant increase in viral proliferation after day two by at least one log or more as tested in one step viral growth curves. Viral titers correlated with increasing concentration of Y27632 up to 150 nM in MDA-MB-231 cells. Furthermore, treatment with Y27632 significantly increased syncytia size in MDA-MB-231 and PC-3 cells following MV infection, associated with cytoskeleton disruption as demonstrated by actin staining. Animal combination experiments are ongoing. **CONCLUSIONS:** Inhibition of ROCK by the specific inhibitor, Y27632, enhanced therapeutic efficacy of oncolytic effect of MV on prostate, breast and glioblastoma cancer cells. Increased killing effect correlated with higher viral titers and larger syncytia. Y27632 effect on cellular cytoskeleton likely accounts for the larger syncytia size. These results contribute to better understanding of the mechanism of MV infection and present new direction in improving efficacy of MV virotherapy.

Stem Cell Therapies II

366. Reprogramming Mouse iPS Cells as a New Approach To Correct the Stem Cell Defect in the Mpl^{-/-} Mouse Model

Jackie Roy,¹ Angela Epp,¹ Junli Feng,¹ Xiaoping Wu,¹ Neil C. Josephson.¹

¹Research Division, Puget Sound Blood Center, Seattle, WA.

Congenital Amegakaryocytic Thrombocytopenia (CAMT) is an inherited recessive stem cell disorder cause by loss of function mutations in Mpl, the receptor for Thrombopoietin. Infants with CAMT typically present with isolated thrombocytopenia in the perinatal period and over the course of months to years develop a lethal pancytopenia. The only effective treatment is allogeneic stem cell transplantation. Unfortunately, a significant number of patients do not have a suitable HLA matched donor and even patients with donors still face significant complications post-transplantation including graft rejection, graft versus host disease, and infectious risks from chronic immunosuppression. Restoration of Mpl expression by hematopoietic stem cell (HSC) gene therapy offers numerous advantages in the treatment of CAMT. However, the disease's inherent HSC defect greatly limits the number and viability of marrow repopulating cells that could be isolated and corrected. An alternate strategy is to generate and correct patient-derived iPS cells which could then be differentiated into HSCs and used to rescue individuals with marrow

failure. In addition to being an alternate source for HSCs, iPS cells also have the advantage of excellent ex vivo viability, making them amenable to both Mpl gene addition and targeted gene correction. We are testing these approaches in the Mpl^{-/-} mice, a disease model which demonstrates both a platelet and stem cell defect. Using retroviral vectors expressing Oct 3/4, Sox 2, and Klf-4 we reprogrammed Mpl^{-/-} fibroblasts into iPS cells. In our initial studies the Mpl^{-/-} iPS cells were corrected by transduction with lentiviral vectors expressing a codon-optimized Mpl transgene driven by engineered versions of the Mpl promoter. To induce hematopoietic differentiation the corrected iPS cells were first cultured under conditions to generate embryonic bodies and then transduced with a retroviral vector expressing HOXB4-IRES-GFP. In some studies murine ES cells were similarly differentiated by HOXB4 overexpression. The resultant HSC-like cells were then used to rescue lethally irradiated Mpl^{-/-} recipients. Our results show engraftment of repopulating cells that produce progenitor marrow cells which express c-Kit, CD41, and to a lesser extent CD45. In the peripheral blood of these mice almost all of the RBCs and some CD45+ WBCs were shown to be derived from engrafted HSC-like differentiated iPSCs or ESCs. Although engraftment appeared robust at early time points most mice developed severe anemia and died by 6 weeks post-transplantation. We are now optimizing conditions for generating durable engraftment of HSC-like cells differentiated from ESCs and corrected iPSCs. We also plan to evaluate different methods for correcting the Mpl^{-/-} iPSCs including testing different versions of the Mpl promoter to drive expression of a codon-optimized Mpl transgene and the generation of iPSCs that have undergone gene correction by homologous recombination.

367. Targeting NF-κB Enhances the Regenerative Potential of Muscle Stem Cells through Multiple Mechanisms

Jonathan D. Proto,^{1,2} Aiping Lu,¹ Kayla Imbrogno,¹ Ying Tang,¹ Paul D. Robbins,³ Bing Wang,¹ Johnny Huard.¹

¹Orthopedic Surgery, University of Pittsburgh School of Medicine, Pittsburgh, PA; ²Pathology, University of Pittsburgh School of Medicine, Pittsburgh, PA; ³Microbiology and Molecular Genetics, University of Pittsburgh School of Medicine, Pittsburgh, PA.

Multiple groups have demonstrated that members of the nuclear factor kappa B (NF-κB) protein family are able to negatively regulate myogenesis. Until now, little has been found to suggest a regulatory role for NF-κB in myogenic cells beyond differentiation and growth. NF-κB contains five subunits, two of which, a p50/p65 heterodimer, are thought to mediate the suppression of myogenesis. In this investigation, we examined the consequences of NF-κB blockade on the regenerative phenotype of muscle-derived stem cells (MDSCs) isolated from the gastrocnemius of p65 haploinsufficient mice (p65^{+/-}) and their wild type littermates (p65^{+/+}). Results thus far have found that p65^{+/-} MDSCs have enhanced myogenic potential in vitro and regenerative capacity *in vivo*, in accordance with the reports of others studying myoblasts. We also found p65^{+/-} MDSCs to display increases in cell proliferation under normal growth conditions as well as enhanced survival under oxidative stress. However, as a pleiotropic transcription factor, growth factors and cytokines are among NF-κB's target genes. We investigated the impact of p65 reduction on MDSC growth factor expression and found that p65^{+/-} MDSCs express higher levels of hepatocyte growth factor. Our preliminary data also demonstrates that MDSCs secrete anti-inflammatory factors capable of limiting the expression of inflammatory cytokines in activated macrophages *in vitro*. We have further tested this hypothesis *in vivo* using a cardiotoxin injury model and found that delivery of p65^{+/-} MDSCs post-injury results in engraftments that are associated with reduced inflammation and fiber necrosis compared to p65^{+/+} MDSC engraftments in injured skeletal muscle. Taken collectively, our results suggest that NF-κB/p65 reduction enhances MDSC-mediated muscle

regeneration through multiple mechanisms. Therefore, NF-κB may be a potential therapeutic target to improve muscle pathology in diseases of degeneration via enhancing not only the myogenic potential of MDSCs, but their anti-inflammatory properties as well.

368. Recombinase Strategies To Make and Modify iPS Cells

Marisa Karow,¹ Christopher L. Chavez,¹ Alfonso P. Farruggio,¹ Jonathan M. Gesinger,¹ Joseph C. Wu,¹ Yanru Chen-Tsai,¹ Michele P. Calos.¹

¹Stanford University School of Medicine, Stanford, CA.

Induced pluripotent stem cells (iPSC) have revolutionized the stem cell field. iPSC are most often produced by using retroviruses, but the resulting cells are ill-suited for clinical application. Several alternative strategies to make iPSC have been developed, but none encompass within them a simple methodology to facilitate the precise insertion of a therapeutic gene for gene therapy approaches. Here we report practical strategies to create and genetically modify murine iPSC that rely on plasmid DNA and the sequential application of three site-specific recombinases. PhiC31 integrase was used to insert the reprogramming cassette at preferred locations in the genome, producing iPSC demonstrated to be pluripotent by a full range of in vitro and in vivo criteria, including teratoma formation and generation of chimeric mice. The reprogramming plasmid includes the target attP site for a second site-specific integrase, which can be utilized for precise insertion of a therapeutic gene into the target site. Cre recombinase can be employed for clean excision of the entire reprogramming cassette and most plasmid sequences. We demonstrated the efficient operation of this type of strategy in accessible cell types, including fibroblasts and adipose stem cells. Furthermore, to illustrate a clinically relevant example, we generated iPSC from the A/J limb girdle muscular dystrophy mouse model, introduced the therapeutic dysferlin gene, and deleted the reprogramming genes. This simple strategy produces pluripotent cells that are corrected for a genetic defect and have the potential to be used in a clinical setting.

369. Doxycyclin-Inducible Expression of Human Cytidine Deaminase (hCDD) in Hematopoietic Cells Mediates Protection Against Cytosine-Arabinoside Ara-C In Vitro and In Vivo

Nico Lachmann,¹ Nils Pfaff,¹ Sebastian Brenig,¹ Tobias Cantz,² Axel Schambach,³ Christopher Baum,³ Thomas Moritz.¹

¹REBIRTH Cluster of Excellence, RG Reprogramming, Hannover Medical School, Hannover, Germany; ²REBIRTH Cluster of Excellence, JRG Stem Cell Biology, Hannover Medical School, Hannover, Germany; ³REBIRTH Cluster of Excellence, Department of Experimental Hematology, Hannover Medical School, Hannover, Germany.

Hematopoietic stem cells (HSCs) genetically modified to overexpress drug resistance genes have been advocated to overcome chemotherapy induced myelosuppression. Recently, we demonstrated that overexpression of hCDD from a constitutive spleen focus forming virus (SFFV)-derived promoter protects hematopoietic cells from Ara-C toxicity in vitro and in vivo. However, these studies also indicated substantial lymphotoxicity by high level constitutive CDD expression (Rattmann et al. Blood, 2006). To circumvent this problem, we now have established a doxycyclin (Dox)-inducible (TET-ON) CDD-expression system and have evaluated this system in murine in vitro and in vivo protection assays. In vitro CDD-mediated Ara-C resistance was evaluated in 32D cells as well as primary Lin-clonogenic progenitor cells. In these studies cells were co-transduced with two lentiviral constructs expressing CDD (TET-CDD) and the reverse transactivator protein (rtTA3). In 32D cells Dox-inducible

CDD expression was observed within 24h and protected cells from Ara-C concentrations of up to 5000 nM (applied for 48hrs), whereas control- or untransduced cells died at a 25-fold lower dose. After Dox withdrawal transgene expression remained detectable for at least three days. Similar protection was observed in primary lin- murine cells and progenitor cell derived colonies were protected from Ara-C doses of 300 to 600 nM while untransduced control cells did not yield colony growth at doses of 50 nM Ara-C or higher. In vivo studies were performed by transplanting C57Bl/6 mice with Lin-cells from Rosa26-M2rtTA mice previously transduced with the TET.CDD or a control SIN lentiviral vector. Transgene expression was induced by Dox administration starting four weeks post transplantation. In this model Dox administration induced stable transgene expression in peripheral blood B-, T- and myeloid cells peaking 15 days after start of administration and remaining detectable for 21 days after Dox withdrawal. No significant lymphotoxicity was detected in these studies. Moreover, the TET.CDD vector conveyed significant protection against Ara-C (500 mg/kg, d1-4, i.v.) to the hematopoietic system as measured by granulocyte counts (0.26 ± 0.25 versus 0.8 ± 0 , $p=0.02$) and platelet counts (584 ± 159 versus 883 ± 194 , $p=0.02$) on day 7 after CTX application. Therefore, taken together, our data demonstrate efficient Dox-inducible hCDD expression in 32D and primary murine bone marrow cells in vitro as well as in our murine in vivo bone marrow transplant/ gene transfer model. Most importantly, in the latter model Dox-inducible CDD expression not only allowed for significant protection from Ara-C induced myelotoxicity but also abrogated the lymphotoxicity observed previously with high and constitutive hCDD expression.

370. Enhanced Cell Survival, Differentiation and Down-Regulation of Hypoxia-Related Genes by Increased Oxygen Supply

Dmitriy Sheyn,^{1,2} Shimon Benjamin,¹ Shiran Ben David,² Ilan Kallai,¹ Yoram Zilberman,¹ Anthony Oh,² Gadi Pelled,^{1,2} Dan Gazit,^{1,2} Zulma Gazit.^{1,2}

¹Hebrew University of Jerusalem, Jerusalem, Israel; ²Cedars-Sinai Medical Center, Los Angeles.

Introduction: Osteogenesis of mesenchymal stem cells (MSCs) is highly dependent on oxygen supply. Reduction of oxygen availability within the scaffold limits osteogenic differentiation. We have shown that perfluorotributylamine (PFTBA), a synthetic oxygen carrier, enhances MSC-based bone formation in vivo. In this study we aim to explore the mechanism of this phenomenon. We hypothesize that a transient increase in oxygen levels generated by PFTBA will affect MSC survival, proliferation and differentiation, thus affecting bone formation and metabolism in vitro and in vivo. To test this hypothesis, we incorporated PFTBA into MSC-loaded alginate beads and investigated the effect on oxygen availability, cell survival, osteogenesis and the expression of hypoxia-related genes. **Materials and Methods:** MSCs overexpressing the BMP2 gene were encapsulated in alginate beads that had been supplemented with 10% (w/v) PFTBA. A control group consisted of similar cell-loaded beads containing PBS. Monitoring of oxygen levels was performed using a needle-type oxygen microsensor.

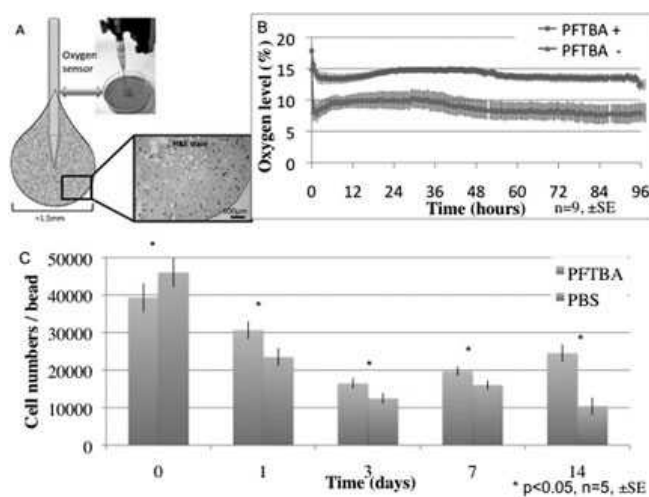

-A. To evaluate cell growth, cells were retrieved from the beads, counted and stained with PI; then cell death was analyzed using FACS. The effect of PFTBA on MSC osteogenesis was measured using an ALP assay. Gene expression was evaluated using qRT-PCR. To verify that the MSCs maintained their osteogenic potential in vivo, alginate beads with or without PFTBA were implanted subcutaneously in C3H/HeN mice. The implants were harvested after 2 or 4 weeks and analyzed using μ CT. Results: Oxygen measurements showed that supplementation of PFTBA significantly increased the available oxygen level during a 96-hour period [figure 1B]. PFTBA-containing beads displayed an elevation in cell viability, which was stably preserved throughout 2 weeks of culture [figure 1C]. Cell death analysis showed that beads with PFTBA contained a significantly lower ratio of dead cells throughout the experiment. In addition, cells in the PBS group expressed significantly more hypoxia-related genes such as VEGF, DDIT3 and PKG1. Moreover, we found that PFTBA supplementation led to an increase in the osteogenic differentiation of MSCs based on ALP expression in vitro. Similar result was obtained in vivo where the implantation of MSCs in alginate beads resulted in higher bone volume in the PFTBA group, as shown by μ CT. **Conclusions:** Our results indicate that there is an oxygen shortage during the first days after cell encapsulation in alginate beads and that PFTBA supplementation increases the local oxygen level in the vicinity of the cells. Consequently, cell survival and osteogenesis are increased and hypoxia-related genes are downregulated. These results indicate that oxygen supply might accelerate MSC-based bone regeneration.

371. In Vitro Reprogramming of Murine Gall Bladder Cells to beta-Like Cells

Raymond D. Hickey,¹ Kathryn M. Schubert,¹ Jessie S. Coleman,¹ Feorillo Galivo,¹ Eric Lagasse,² Markus Grompe.¹
¹Oregon Stem Cell Center, OHSU, Portland, OR; ²McGowan Institute, Pittsburgh, PA.

Current cell therapies for type I diabetes are restricted to transplantation of donor islets, but success has been hindered by both immune rejection of transplanted cells and by lack of donor islets available. In theory, a more suitable cell therapy approach would involve an autologous source of cells that could be expanded and reprogrammed in vitro to beta cells, which could then be transplanted back to the patient without the need of long-term immune suppression. We hypothesized that gall bladder cells (GBCs) could fulfill these requirements, as removal of the gall bladder is a minimally invasive surgery with no adverse effects. Additionally, the gall bladder and pancreas are developmentally related, and therefore we reasoned that these cells would be more readily reprogrammable to beta

cells than other cell types. Here, we show that murine GBCs can be robustly expanded in vitro, and present evidence that these cells can be reprogrammed to the beta cell fate. In order to expand GBCs in culture, we seeded primary GBCs on an irradiated feeder layer on which the GBCs form distinct colonies that grow readily and can be passaged. These cells can undergo at least 14 passages, allowing a rapid generation of cells amenable to reprogramming. In order to reprogram GBCs, we chose a non-integrating vector, adenovirus, to express the relevant pancreatic transcription factors. Using an adenoviral vector expressing the EGFP transgene, we show adenovirus is able to transduce and express EGFP in GBCs. Next, we investigated whether GBCs can be reprogrammed to a different cell lineage. Using different combinations of Neurog3, Pdx1, MafA, MafB, Pax4 and Nkx6.1, we analyzed pancreatic cell specific gene expression by qPCR to identify the optimal combination of transcription factors for reprogramming. By detection of the mRNA transcripts for Ins1, Ins2, Neurod1, Nkx2.2, Sst, Ppy and others, we confirmed that GBCs are reprogrammable to the pancreatic lineage. We hypothesized that the reprogramming resulted in the generation of heterogeneous pancreatic endocrine cell types. Further experiments supported this, as we were able to FACS-sort specific populations of reprogrammed cells that were more highly enriched for beta cell mRNA transcripts. In order to isolate a more pure population of gall bladder-derived beta-like cells, we used a reporter mouse strain in which the Ins1 gene promoter drives the expression of EGFP. In normal GBCs there is no expression of EGFP; however in reprogrammed GBCs, a population of EGFP-positive cells could be FACS-sorted within 48 hours post adenovirus transduction. By qPCR analysis, these cells were highly enriched for beta cell-specific transcripts and these cells will be further characterized by RNA-Seq and immunocytochemistry methods. These results indicate that GBCs are amenable to reprogramming towards a beta-like cell fate. In addition, we are currently characterizing these gall bladder-derived beta cells at the functional level, including their transplantation into a diabetic mouse model. These experiments will allow a more thorough understanding of the potential for the gall bladder to be used for the treatment of diabetes.

372. Improved Hematopoietic Stem/Progenitor Cell Maintenance of Nonhuman Primate Marrow Cells Via a Non-Cell-Autonomous Effect of Fos and Vps72

Korashon L. Watts,¹ Eric Deneault,² Guy Sauvageau,² Hans-Peter Kiem.¹

¹Fred Hutchinson Cancer Research Center, Seattle, WA;

²University of Montreal, Montreal, QC, Canada.

Expansion of hematopoietic stem cells has important implications for stem cell transplantation and gene therapy. For example, it can potentially facilitate engraftment in settings where cell doses are limited, allow for prescreening of expanded stem cells, or aid engraftment in a nonmyeloablative setting. To this end, we tested genes previously identified as having an enhanced role in hematopoiesis to determine if any demonstrate a non-cell-autonomous effect on Macaca nemestrina bone marrow (BM) CD34⁺ cells, thus rendering them potential candidates for non-integrating cell expansion techniques. NIH 3T3 cells were transduced with gamma retroviruses expressing each of the following genes: pKOf1 (control), Fos and Vps72. These cells were then FACS-sorted to greater than 95% purity to establish 3 feeder cell lines expressing each of the genes (1 control gene and 2 genes with demonstrated hematopoietic effect.) Macaque BM CD34⁺ cells were co-cultured for 7 days on each feeder layer. After 7 days, phenotypic analysis was performed to detect CD3⁺, CD13⁺, and CD34⁺ percentage. Annexin V and 7AAD staining were used to assess viability and apoptosis, and CFUs were set up in triplicate using 10,000 BM cells from each treatment. Furthermore, cytopins

were prepared on Day 7 from BM cells from each feeder treatment. Slides were Giemsa-stained, and the ratio of blasts to differentiated cells determined for each treatment. All experiments were in triplicate. After 7 days of co-culture, macaque BM cells grown on Vps72- and Fos-transduced NIH 3T3 cells were 8% and 10% CD3⁺, respectively, compared to only 1% CD3⁺ on control (pKOf1)-transduced NIH 3T3 cells. CD13⁺ percentages on Fos-, Vps72- and control-transduced feeders were 8%, 10%, and 48%. Furthermore, CD34⁺ percentages of 37% (control), 67% (Vps72), and 71% (Fos) were obtained after 7 days of co-culture. Viability by 7AAD stain showed that Fos and Vps72 resulted in a higher viability (95% and 96%) after 7 days, while all other treatments exhibited viabilities between 88% and 91%. Finally, annexin V staining confirmed that Fos (6%) and Vps72 (4%) resulted in lower rates of apoptosis than all other treatments (range, 16% to 22%). The majority of apoptotic cells were in early-phase, rather than late-phase, apoptosis. Co-culture on Fos-overexpressing cells resulted in a CFU plating efficiency of 2.4%; co-culture on Vps72-overexpressing cells resulted in a plating efficiency of 2.5%, and all others ranged from 1.0% to 1.4%. Morphological analysis from Giemsa-stained cytopins showed Fos and Vps72 were the only genes tested in which the ratio of blasts to differentiated cells was >1. We found that Fos and Vps72 exhibited a non-cell-autonomous effect on macaque CD34⁺ cells. This discovery has immense potential in the development of a large animal clinical model for stem cell transplant. We have shown that Fos and Vps72 influence macaque cells via a non-integrating pathway to yield (a) an increase in the lymphoid lineage, (b) improved maintenance of CD34⁺ cells, (c) higher viability, and (d) better maintenance of a primitive, undifferentiated morphology compared to control.

373. Muscle Derived Stem Cells Transduced with BMP4 Interact Broadly with Host Cells To Promote Bone Healing in Critical Sized Skull Defect

Xueqin Gao,¹ Arvydas Usas,¹ Aiping Lu,¹ Jonathan Proto,¹ Jessica C. Tebbets,¹ Hongshuai Li,¹ James H. Cummins,¹ Mathieu Huard,¹ Johnny Huard.¹

¹Stem Cell Research Center, Department of Orthopaedic Surgery, University of Pittsburgh, Pittsburgh, PA.

Introduction: We have shown that muscle derived stem cells transduced with BMP4 (MDSCsBMP4) promoted ectopic bone formation and bone defect healing in mice. The aim of this study was to investigate the interaction of MDSCs with the host cells and determine their contribution to the cranial bone regeneration. **Methods:** We transduced male MDSCs with retroBMP4-GFP and identified chemo-attractant gene expression by RT-PCR. Transduced MDSCs were then implanted into critical sized skull defects created in 12 week old male C57BL/6J mice using Tisseel FS as a scaffold. The control mice received PBS instead of cells and a scaffold. We monitored bone healing weekly by μ CT. To investigate the donor and host cell interaction dynamically, we sacrificed mice at 3, 7, 14, 21, and 28 days post implantation (PI) and harvested the skull tissues for cryosectioning. We defined donor cell contribution by colocalizing GFP with Collagen2A1 (Col2A1) and osteocalcin (OC). We identified the host response by immunofluorescence: inflammatory cells by colocalizing Gr-1 and CD68 with GFP; endothelial cells by colocalizing CD31 and CD105 with GFP; immune cells by colocalizing CD4 and CD8 with GFP at different time points. **Results: (1)** RT-PCR indicated that MDSCs endogenously express Sox9, Bmpr1b, Bmpr2, Cox-2, Inos, Mcp1 and Vegf, but not Cyt11. BMP4 transduction did not affect the expression of these genes except Inos. **(2)** μ CT revealed that MDSCsBMP4 healed bone completely in 4 weeks. Co-localization of GFP with Col2A1 and OC showed that MDSCs contributed to majority of the endochondral bone at the defect site. **(3)** At 3 d PI, we observed significantly more inflammatory cells (CD68⁺ macrophages and Gr-1⁺

neutrophils) in the MDSCsBMP4 group versus the PBS control group. At 7d PI, we observed a trend in a decrease of inflammatory cells in the MDSCsBMP4 group compared to the PBS control group. At 14d and 21d PI, we found significantly fewer neutrophils and macrophages in the MDSCsBMP4 group versus the PBS control group. (4) We found significantly more vascular endothelial cells migrating actively from the dura mater toward the MDSCs transplanted in the MDSCsBMP4 group versus the control group at 3d, 7d, 14d, and 21d PI. These endothelial cells were derived from the host. (4) We found significantly more vascular endothelial cells migrating actively from the dura mater toward the MDSCs transplanted in the MDSCsBMP4 group but not control group at 3d. At all time points PI, we observed significantly more endothelial cells in the MDSCs group versus the PBS group. (5) We observed significantly fewer CD4 and CD8 immune cells at 7d in the MDSCsBMP4 group versus the control group. But we found significantly more CD4 and CD8 cells at 14d and 21d PI in MDSCsBMP4 group which indicated the recruitment of bone marrow cells. **Conclusion:** MDSCs expressed SOX-9, BMP receptors and other chemo-attractant genes. BMP4-expressing MDSCs participated in endochondral bone regeneration during cranial defect healing. Chemo-attracted inflammatory cells induced early onset and early resolution of inflammation which facilitated bone regeneration. MDSCs also chemo-attracted vascular cells from the host and promoted angiogenesis. MDSCs inhibited the immune response at early time point which reduced the immune rejection of transplanted stem cells.

Immunologic & Host Responses in Gene & Cell Therapy

374. Characterizing AAV1 Capsid Antigenic Regions

Yu-Shan Tseng,¹ Brittney Gurda,^{1,2} Wendy Weichert,³ Colin R. Parrish,³ John A. Chiorini,⁴ Mavis Agbandje-McKenna.¹
¹Biochemistry and Molecular Biology, University of Florida, Gainesville, FL; ²Pathology and Laboratory Medicine, University of Pennsylvania, Philadelphia, PA; ³James A. Baker Institute for Animal Health, Cornell University, Ithaca, NY; ⁴MPTB, NIDCR, National Institutes of Health, Bethesda, MD.

Analyses of human samples and the pre-clinical trial screening of patient serum has detected the prevalence of significant levels of pre-existing capsid-targeted antibodies directed against the Adeno-associated viruses (AAVs) under development as vectors for human gene delivery applications. These antibodies are detrimental to the successful outcome of gene delivery procedures. However, other than the prototype AAV2 serotype, very little is known about the antigenic regions of the AAV capsids. We have used cryo-electron microscopy and image reconstruction obtain data for AAV:Fab complex structures which resulted in the proposal that ocommon antigenic epitopes exist on the capsid surface of a number of AAV serotypes, including AAV1, AAV2, AAV5, and AAV8. These studies point to the protrusions which surround the icosahedral threefold axes as the common target of antibody reactivity for vector neutralization. We have extended AAV1 studies using biochemical and molecular approaches to verify the antigenic epitopes for three different neutralizing antibodies mapped onto the capsid. These studies confirm pseudo-atomic modeling studies previously used to propose the antigenic epitopes on the AAV1 which overlap with regions of the AAV2 and AAV5 capsids known to interact with receptors, suggesting a possible mechanism of neutralization. Significantly, mutant vectors, now able to "escape" neutralization by parental antibodies, have wild virus titre levels and maintain the ability to transduce cells *in vitro*. Thus these viruses have the potential to be developed as secondary generation vectors with the ability to evade pre-existing host immune responses for improved AAV gene delivery efficacy.

375. Avoiding Transgene Immune Rejection after AAV Vector Delivery to the Skeletal Muscle: Tolerogenic Dendritic Cell-Based Immunotherapy in a Nonhuman Primate Model

Aur lie Moreau,¹ Mercedes Segovia,² Laurence Dubreil,³ Ga lle Tilly,² Jack-Yves Deschamps,³ Yan Cherel,³ Ignacio Anegon,² Philippe Moullier,^{1,4} Maria Cristina Cuturi,² Oumeya Adjali.¹
¹INSERM UMR 649, Nantes Hospital, Nantes, France; ²INSERM UMR 643, Nantes Hospital, Nantes, France; ³INRA UMR 703, Nantes National Veterinary School, Nantes, France; ⁴Department of Molecular Genetics and Microbiology, University of Florida, Gainesville, FL.

Recombinant adeno-associated virus (rAAV) provides a clinically relevant platform for efficient and sustained gene therapy. However, recent gene transfer studies into animal models, and more recently in humans, indicate that the risk of transgene immune responses is not negligible and depends on multiple factors including the route of vector delivery. Even if immunosuppressive regimens have been successfully used, they are associated to adverse effects. Immunomodulation strategies to avoid transgene immune rejection are therefore needed. One innovative strategy is based on the delivery of tolerogenic dendritic cells (DC). The successful use of such cells over the ten past years in rodent models of allograft rejection has indeed highlighted the therapeutic potential of this immunotherapy. Our aim is to evaluate the tolerogenic potential of DC in the context of a nonhuman primate model of rAAV-based gene transfer. We first generated immature macaque bone marrow derived-DC with *in vitro* immunomodulatory effects. We then tested their *in vivo* potential after intramuscular (IM) injection of a rAAV expressing an immunogenic transgene. 2 groups of primates were injected with the vector in combination with immature autologous DC administered either intradermally (ID) or via the intravenous (IV) route. When autologous DCs loaded with the transgene product were not immunogenic per se if injected alone in the absence of gene transfer, we found that their intradermal injection one day before the IM delivery of the vector was not able to prevent anti-transgene immune response. Moreover, intradermal DC delivery resulted in an earlier immune transgene rejection as compared to the control group injected with the vector alone. In contrast, in 2 primates who received DC via the IV route, we observed a long term expression of the transgene, suggesting a possible immunomodulatory effect of DC immunotherapy. When these results are still preliminary, they highlight the potential of tolerogenic DC *in vivo* in a large animal model of rAAV delivery, and in gene transfer protocols in general.

376. Immunosuppressive Strategies To Protect Transgenic Skin Cells from Immune Rejection: Implications for Cutaneous Gene/Cell Therapy

Soosan Ghazizadeh,¹ Weibing Zhang,¹ Li T. Huang.¹
¹Oral Biology and Pathology, Stony Brook University, Stony Brook, NY.

Epidermal keratinocytes and dermal fibroblasts are both potential targets for cutaneous gene/cell therapy for genodermatoses. Immune elimination of genetically modified cells, however, presents a major impediment to effective therapy. Using *ex vivo* approaches to gene transfer, we have previously shown that expression of an antigen by either cell type was sufficient to prime T cells and induce immune rejection of transplanted cells. The nature of these responses and the kinetics of immune rejection, however, were significantly different for these two cell types suggesting different immunosuppressive strategies to control unwanted immune responses. In this study, we explored the potential of local expression of immunosuppressive factors to protect transgenic skin cells from immune rejection. Primary cultures of mouse keratinocytes or fibroblasts were transduced with a

bicistronic vector encoding green fluorescent protein (GFP; as a model antigen) and an immunomodulatory molecule including CTLA4Ig, PDL1-Ig or PDL1, and were transplanted onto the back of a syngeneic mouse to regenerate skin. Surface GFP expression in live mice was monitored weekly to assess the fate of transgenic cells. Coexpression of transgene with either CTLA4Ig or PDL1 in fibroblasts resulted in long-term survival of transgenic fibroblasts (>20 weeks) despite the presence of systemic transgene-specific immune responses. Similar treatment did not, however, protect keratinocytes from immune rejection. Long-term protection of transgenic keratinocytes was achieved through transient blockade of CD40/CD154 interactions by administration of anti-CD154 antibody during the first two weeks of cell transplantation. Although neither of these strategies induced long-lived antigen-specific tolerance, they were sufficient to prevent loss of genetically modified cells. These results thus indicate that different strategies are required to restrict rejection of neoantigen-expressing keratinocytes and fibroblasts and long-term survival of genetically modified cells does not require induction of transgene-specific tolerance.

377. Hepatocyte-Targeted Expression by Integrase-Defective Lentiviral Vectors Induces Antigen-Specific Regulatory T Cells and Immune Tolerance to Foreign Antigens

Andrea Annoni,¹ Alessio Cantore,^{1,2} Kevin Goudy,¹ Lucia Sergi Sergi,¹ Luigi Naldini,^{1,2} Maria Grazia Roncarolo.^{1,2}
¹San Raffaele Telethon Institute for Gene Therapy, Milan, Italy;
²Vita Salute San Raffaele University, Milan, Italy.

Integrase-Defective Lentiviral Vectors (IDLV) are emerging as an attractive gene delivery system. These vectors harness the pantropism and proficiency of LV transduction without relying on integration and permanent modification of the cellular genome, thus providing a substantial safety feature. It is not known whether IDLV can achieve therapeutically relevant transgene expression in the liver, and induce transgene-specific tolerance exploiting the tolerogenic properties of hepatocyte-targeted expression. Here we characterize IDLV performance in primary human hepatocytes and in the mouse liver. We show that IDLV efficiently transduce vector genomes, but express the transgene at lower levels on a per copy basis, as compared to their integration-competent (IC) counterparts. To investigate whether hepatocyte-targeted IDLV can induce tolerance to a specific antigen, treated mice were re-challenged with the antigen to evaluate the induction of secondary anti-transgene immune response. The absence of response to transgene indicated that IDLV treatment generate a state of transgene-specific immunological tolerance in recipient mice, while secondary expansion of transgene-specific CD8⁺ T cells was detectable in mice injected with control immunogenic IDLV. To further confirm tolerance induction by IDLV, Rag2^{-/-}γ-chain^{-/-} mice expressing GFP in hepatocytes were immune reconstituted by adoptive transfer of a pool of splenocytes and liver lymphocytes isolated either from immunized (control IDLV-treated) or tolerized or naïve mice. Comparable amounts of GFP-expressing hepatocytes were detected in the mice reconstituted with naïve cells or cells derived from tolerant mice, whereas a complete clearance of GFP⁺ hepatocytes was observed in recipient mice reconstituted with immune cells derived from control immunogenic IDLV-treated mice, accompanied by loss of vector DNA. In addition, monitoring GFP expression in CD4⁺T CD45.2⁺ cells we could detect de novo Treg induction in mice that received the tolerogenic IDLV encoding for Ovalbumin (OVA) in which Treg-depleted OTII-FOXP3GFP-CD4⁺CD45.2⁺T cells (IAb-OVA323-339 specific tg-TCR and GFP-FOXP3⁺ knock in) were adoptively transferred. Critical factors leading to Treg development in the liver are currently under investigation. We previously reported the tolerogenic outcome of ICLV stringently targeted to hepatocytes. We did not know, however,

whether this outcome depends on sustained high levels of transgene expression within hepatocytes, which requires substantial levels of vector integration, limiting the application of this approach outside of gene replacement strategies for the correction of monogenic diseases. Our new findings demonstrate that Tregs induction in vivo can be obtained in a safer way by IDLV, thus opening up new therapeutic opportunities for immune modulation.

Cell Processing and Vector Production

378. Micro RNA Knockdown Significantly Enhances Adenovirus Replication and Vector Production

Christina Rauschhuber,¹ Martin Hausl,¹ Dirk Nettelbeck,² Anja Ehrhardt.¹

¹Department of Virology, Max von Pettenkofer-Institute, Munich, Germany; ²Department of Dermatology, German Cancer Research Center, Heidelberg, Germany.

The use of micro RNAs (miRNAs) fundamentally improved the generation of viral vectors for gene therapy. In this study we used our recently established HEK293 cells derived RNAi knockdown cell line B6 based on the RNAi suppressor protein P19 derived from the tomato bushy stunt virus to analyze the influence of the RNAi pathway on adenoviral vectors. We investigated replication of wildtype adenovirus 5 (wtAd5) and first generation adenovirus (FgAd) on a genome level. An up to 10-fold increase in viral genome copy numbers could demonstrate that there is significantly enhanced viral DNA replication under RNAi knockdown conditions. To analyze whether we can also achieve higher viral titers in the B6 cell line, we infected with a common FgAd expressing firefly luciferase (FgAdluc). After re-infection of HEK293 cells we measured up to 5-fold increased luciferase activity indicating a higher titer of FgAdluc derived from B6 cells. To reach even stronger effects we hypothesized that the amount of the RNAi suppressor protein P19 may be the limiting factor. Thus, we generated a recombinant adenovirus expressing p19 under the major late promoter (Bwtp19ΔE3) using an advanced cloning technology based on bacterial artificial chromosomes. We detected up to 100-fold increased genome copy numbers compared to wtAd5 and the corresponding control virus. Notably, replication of Bwtp19ΔE3 was even faster compared to an oncolytic virus that contains a 24 bp deletion in the E1a gene. To shed light on the mechanism responsible for up regulation of adenoviral replication, we analyzed expression levels of early and late adenoviral proteins. We found that expression levels of the early genes E4Orf6, DBP and E1B55K were significantly enhanced on mRNA and protein levels. However, structural proteins like hexon and fiber were nearly unaltered on protein level but increased on mRNA level at late time points of infection. Furthermore, we analyzed the fate of the virus-associated RNAs VAI RNA and VAII RNA, which are known to be processed by Dicer into 19-29 nucleotide long small virus-associated RNAs (sva-RNAs). We found that under the presence of P19, sva-RNAs are bound to P19 and are degraded into smaller products. Last but not least, we developed a helper-virus expressing p19 (BHVp19) for helper-dependent adenovirus (HC-AdV) production. HC-AdVs represent the most advanced generation of recombinant adenoviral vectors and hold great promise with respect to safety and efficacy in gene therapeutic applications. However, production of HC-AdVs is sophisticated and only a few groups are able to produce these vectors in sufficient amounts. Thus, we wanted to further improve the viral titers by taking advantage of our finding that adenovirus replication is enhanced in the presence of P19. We found that in contrast to a conventionally used helper-virus the BHVp19 increased HC-AdV titers up to 12-fold. In conclusion, we provide new insights into regulation of adenoviral vectors by RNAi and our RNAi knockdown cell line B6 could be used as a novel producer cell line for adenoviral vectors and in the future also for improvements of oncolytic viruses.

379. GMP Production of a SIN Lentiviral Vector for the Treatment of SCID-X1 Using a Stable Producer Cell Line

Tim Lockey,¹ Susan Sleep,¹ Robert Throm,² Mike Greene,² Paolo Fagone,² Harry Malech,³ Brian Sorrentino,² John T. Gray.²

¹Children's GMP, LLC, St. Jude Children's Research Hospital, Memphis, TN; ²Hematology, St. Jude Children's Research Hospital, Memphis, TN; ³Laboratory of Host Defenses, NIAID, NIH, Bethesda, MD.

We describe here our process and large scale production results for GMP grade production of a clinical lentiviral vector for the treatment of SCID-X1 using a stable, HIV based producer cell line (described in Throm, et al. Blood, v113 n21 p5104). Process optimization was performed with cells from our master cell bank at 1 and 5 liter scale prior to pre-clinical production at 5 liter scale and clinical production at 25 liter scale. The final process consists of cell expansion in flasks prior to seeding into a WAVE bioreactor bag containing FibraCell disks for expansion to final production scale. When daily glucose consumption exceeds 1 – 1.5 g/L, the media (DMEM+10%FCS+1 ng/ml Doxycycline) is replaced with Doxycycline free media to induce vector production. On Days 3 through 8 post induction (p.i.) supernatant is harvested and held at 4C. On days 4, 6, and 8 two harvests are pooled, adjusted to pH 8.0 and 300 mM NaCl, and flowed through Mustang Q cartridges to capture vector particles. Following elution with 1.5 M NaCl, vector is diluted with buffer to reduce salt concentration and held at 4C until the final harvest has been similarly processed. The three anion exchange eluates are then pooled, desalted, and concentrated by using tangential flow filtration with a 500 kDa cutoff membrane. The final concentrated vector is formulated in PBS containing 0.5% human serum albumin. Production yield and QC assay results for the pre-clinical and clinical batches were similar and results for the clinical product are presented here. Infectious titer of the vector product was determined on ED7R cells, a T-cell line that does not significantly express the γ_c gene. Peak supernatant titer occurred on day 3 p.i. at 1.25×10^7 tu/ml, and the average of all 6 harvests was 5.5×10^6 tu/ml, giving a total transducing unit yield of 8×10^{11} tu. p24 similarly peaked on day 3 p.i. at 5.2 g/ml, and averaged 2 g/ml for all 6 harvests. After purification, yield was 2.3×10^{11} total tu, or ~30%, predominantly due to losses at the Mustang Q step. Final volume was 500 mls and titer was 4.5×10^8 tu/ml, with an infectivity of ~5000 tu/ng p24, which is comparable to that described for the transient transfection product used for the successful lentiviral treatment of adrenoleukodystrophy (Cartier et al, Science, v326 n5954 p818). The product has been extensively tested for adventitious agents including replication competent lentivirus and confirmed negative. Critical potency measurements were performed by transducing mobilized adult human peripheral blood CD34+ cells at 10^8 tu/ml. CFU-C derived from those transductions were typically >20% positive by PCR depending on the donor. Final FDA review of this clinical grade product is pending, with anticipated initiation of clinical trial immediately following approval. This represents to our knowledge the first clinical grade lentiviral vector produced from a stable cell line system.

380. Generation and Characterization of AAV Producer Cell Lines

John Martin,¹ Amy Frederick,¹ Yuxia Luo,¹ Robert Jackson,¹ Dianna Ambach,² Christopher Renzi,² Lisa Budzinski,² Lois Horton,² Angela Johnsen,² Simon Godwin,² Donna Armentano,¹ Sam Wadsworth,¹ Karen Vincent.¹

¹Molecular Biology, Genzyme Corporation, Framingham, MA; ²Gene Therapy Development, Genzyme Corporation, Framingham, MA.

AAV producer cell lines represent an effective method for large-scale production of AAV vectors for clinical applications. In the system described here, a single plasmid containing three components: the vector sequence, the AAV *rep* and *cap* genes and a selectable marker gene is stably transfected into HeLa S3 cells. Following transfection, candidates (referred to as masterwells or MW) are initially selected on the basis of a relative production screen where vector yields are estimated and used to rank MW relative to each other. High-producing MW are then subjected to a specific production screen in which yield (of DNase-resistant particles; DRP) is determined on a per cell basis. A transfection to generate an AAV2/SEAP producer cell line has been performed. The relative production screen revealed that 6.4% of the MW yielded greater than 1×10^{10} DRP/ml. Several of these showed vector yields in the 5×10^4 to 2.0×10^5 DRP/cell range when assessed for specific production. Analysis of genomic DNA in the high-producing MW showed plasmid copies integrated in a head-to-tail configuration. Upon infection with adenovirus, *rep/cap* copy number was amplified approximately 100-fold. *Rep* expression in the producer cell line was first detected a few hours post-infection and was followed closely by *cap*; expression of both genes reached a peak at 48 hr. This pattern of gene expression correlated with the appearance of packaged vector at the 24 hr time point. Vector production reached a maximum at 48 hr and was maintained through the 96 hr (final) time point. AAV2/SEAP was produced in a small-scale (1L) shaker culture and purified via affinity chromatography to provide vector for assessment of vector potency. Results of experiments comparing AAV2/SEAP generated by the producer cell line with vector produced via the triple transfection method will be presented.

381. A New Cell Line for Clinical Grade Production of E1-Deleted Adenovirus Encoding Toxic Proteins

Rénauld Gilbert,^{1,2} Claire Guilbault,¹ David Gagnon,¹ Danielle Jacob,³ Lucie Bourget,¹ Amine Kamen,³ Bernard Massie.^{1,4}

¹Genomics & Gene Therapy Vectors, Biotechnology Research Institute, Montreal, QC, Canada; ²Neuromuscular Research Group, Montreal Neurological Institute, McGill University, Montreal, QC, Canada; ³Animal Cell Technology, Biotechnology Research Institute, Montreal, QC, Canada; ⁴Département de Microbiologie et Immunologie, Université de Montréal, Montreal, QC, Canada.

First generation (E1-deleted) adenovirus vectors (FGAd) are important vectors for therapeutic applications such as cancer and vaccination. An ideal cell line for clinical grade production of FGAd should produce high viral titers in suspension culture for scale-up and in serum-free medium for regulatory compliance. Most importantly, it should not produce replication competent adenovirus (RCA). Some gene products carried by FGAd, such as those employed for cancer therapy, are cytotoxic. For this reason, they should not be synthesized during the propagation of FGAd, because their toxicity reduces the vector yield. The present study describes the construction of a cell line (Sf-BMAd-R) that possesses such properties. The cell line was generated by stable transfection into A549 cells of the E1A and E1B regions of adenovirus and of the repressor of the cumate-switch (CymR). A clone producing elevated amounts of FGAd was

isolated and adapted to serum-free suspension culture. CymR binds to the cumate operator (CuO) and prevents transcription when CuO is inserted downstream of a strong enhancer/promoter such as CMV. Expression of a transgene regulated by the CMVCuO promoter is repressed when the FGAd carrying the transgene are propagated on Sf-BMAd-R cells. The yield of FGAd expressing GFP regulated by CMVCuO (Ad-CMVCuOGFP) was 1000 transducing units (TU) per cell, a value comparable to the yield obtained with our 293SF cell line previously characterized. Production of Ad-CMVCuOGFP and repression of GFP by CymR were stable for at least three months of culture in the absence of selective agent. Production of Ad-CMVCuOGFP to a level of 1000 TU/cell was also validated in a 2.5 liter bioreactor in protein-free chemically defined medium. We also demonstrated that the yield of FGAd encoding a suicide gene (Cytosine deaminase::uracil phosphoribosyltransferase) regulated by CMVCuO was 6 times higher with our Sf-BMAd-R in comparison to our standard 293SF cells. In summary, because of its interesting characteristics, the Sf-BMAd-R cell line should become a useful tool to produce clinical grade preparations of FGAd for gene therapy and vaccination.

RNA Virus Vectors II

382. Rapid Titration of Lentiviral and Gamma Retroviral Vectors Using a Beta-Lactamase Protein Fragment Complementation Assay

Wu Ou,¹ Connie Lu,² Jakob Reiser.¹

¹Division of Cellular and Gene Therapies, FDA/CBER, Bethesda, MD; ²University of Maryland, College Park, MD.

We have developed a rapid assay to titrate lentiviral and gamma retroviral vectors. The assay is based on protein fragment complementation involving the N-terminal (Bla1) and C-terminal (Bla2) fragments of β -lactamase (BLAK), which were fused to the yeast FRB (the FKBP-rapamycin binding domain of TOR) and FKBP (FK506 binding protein) domains, respectively. In addition, a 15-amino acid membrane anchoring sequence (S15) derived from c-Src was fused to the N-terminus of FRB-Bla1. For vector production a plasmid encoding S15-FRB-Bla1 was co-transfected with lentiviral packaging and vector plasmids into HEK 293T cells, resulting in the incorporation of S15-FRB-Bla1 in the vector's envelope. Transduction of HEK 293 cells stably expressing FKBP-Bla2 using vector particles containing S15-FRB-Bla1 resulted in BLAK fragment complementation, mediated by FRB and FKBP and rapamycin. Enzymatically active BLAK could be detected by the conversion of a green fluorescent substrate CCF2/AM into a blue fluorescent product and BLAK activity could be easily quantified in that way using FACS. The enzymatic conversion of CCF2/AM was found to be directly related to vector entry since a neutralizing antibody completely blocked the conversion. The titers obtained using this rapid assay correlated well with titers measured by functional transduction assays. The whole assay can be finished within 8 hours. This time frame is considerably shorter compared to other transduction-based titration assays for lentiviral and gamma retroviral vectors. This assay may also be useful for rapid titration of other enveloped viruses and for studying virus entry processes.

383. Insulated Lentiviral Vectors towards Safer Gene Transfer to Stem Cells

Caroline Duros,¹ Alexandre Artus,¹ Armelle Gaussin,² Scholtz Simone,³ Daniela Cesana,⁴ Eugenio Montini,⁴ Manfred Schmidt,³ Christof von Kalle,³ Nicolas Mermod,² Odile Y. D. Cohen-Haguenaier,¹ Odile Y. D. Cohen-Haguenaier.⁵

¹LBP and CLINIGENE, Ecole Normale Supérieure, Cachan, France; ²Laboratory of Molecular Biotechnology, University of Lausanne (UNIL), Lausanne, Switzerland; ³Laboratory of Translational Oncology, Deutsches Krebsforschungszentrum (DKFZ), Heidelberg, Germany; ⁴FCSR-TIGET, San Raffaele, Milan, Italy; ⁵Medical Oncology and Oncogenetics, Hôpital Saint-Louis and University Paris-Diderot, Paris, France.

The need for better gene transfer systems towards improved risk/benefit balance for patients remains a major challenge in the clinical translation of gene therapy (GT). We have investigated the improvement of integrating vectors safety in designing new short synthetic genetic insulator elements (GIE). In otherwise successful GT-trials in SCID, CGD and WASp patients, insertional mutagenesis has resulted in leukemia from transduced cells. The identification of new GIEs which would prevent such activation effects is a main challenge since attempts e.g. with the chicken β -globin HS4, have met with poor efficacy and genetic instability. We have constructed SIN-insulated retrovectors with two candidate GIEs and compared them to native and SIN-LTRs. With each constructs two internal promoters have been tested: either the strong Fr-MuLV-U3 or the housekeeping hPGK. We could identify a specific combination of insulator 2 repeats which translates into best functional activity, high titers and boundary effect in both gammaretro (p20) and lentivectors (DCar4). In target cells a dramatic shift of expression is observed with an homogenous profile the level of which is strictly conditioned by the promoter strength. These data remain stable in both HeLa cells over three months and cord blood HSCs for two months, irrespective of the multiplicity of infection (MOI). In comparison, control vectors show heterogeneous expression profiles with levels which depend on the MOI and prove unstable. We have undertaken genotoxicity assessment in comparing integration patterns ingenuity in human target cells sampled over three months using high-throughput pyro-sequencing. Data indicate reduced clonality developed over time. In addition, utmost recent data in cancer-prone mice do not show statistically different from mock-untransduced mice. We have developed new lentivectors (and gammaretrovirus) which might provide improved versatile tools toward improvement of integrating gene therapy vectors.

384. Generation of Transgene-Free Induced Pluripotent Stem Cells Using Polycistronic Foamy Virus Vectors

Iram F. Khan,¹ Jordan Kho,³ David R. Deyle,¹ Yi Li,¹ David W. Russell.^{1,2}

¹Medicine, University of Washington, Seattle, WA; ²Biochemistry, University of Washington, Seattle, WA; ³Program in Developmental Biology, Baylor College of Medicine, Houston, TX.

Induced pluripotent stem cells (iPSCs) generated by ectopic expression of transcription factors are an ideal source of patient-specific cells given their capacity to differentiate into different cell types. However, multiple insertions of retroviral vectors at random sites within the genome can alter endogenous gene expression and render these cells unsuitable for clinical applications. Expressing all transcription factors from a single vector can minimize the number of viral integrations. Here we describe excisable, polycistronic Foamy Virus (FV) vectors for reprogramming human somatic cells into pluripotent stem cells. Wild type FV is non-pathogenic and FV vectors exhibit no preference for integration within genes,

resulting in less genotoxicity as compared to other retroviral vectors. The reprogramming cassette present in our FV vectors includes a human codon-optimized polycistronic cassette with ORFs for the four pluripotency genes *OCT4*, *SOX2*, *KLF4* and *MYC* separated by viral 2A cleavage peptides. FV vectors harboring different internal promoters including CMV, MLV LTR or EFl α were tested by transduction of human fibroblasts and scoring for alkaline phosphatase positive iPSC colonies. MLV promoter-driven vectors were most efficient in reprogramming. Engineering a murine U6 promoter-driven shRNA against *P53* gene into the vector resulted in a further increase in the number of iPSC colonies observed. Using these vectors, we successfully established iPSC lines from human fibroblasts and adult mesenchymal stem cells targeted at the *COL1A2* locus, several of which contained a single FV vector integration. RT-PCR analysis of the iPSCs revealed expression of pluripotency-specific marker genes and silencing of the reprogramming transgenes. The FV vectors described here also have a loxP site in their LTRs to facilitate removal of the vector genome once the cells have become pluripotent. To excise the reprogramming cassette, a non-integrating FV vector expressing Cre was employed. Transduction of iPSCs with the Cre vector resulted in approximately one fully excised clone per 5-7 clones analyzed. Mapping of the chromosomal locations of the FV vector proviruses in the excised clones was performed so that clones with the residual deleted LTR remnant(s) outside of genes could be identified. Several transgene-free human iPSC lines were produced by this approach, which could be useful in future clinical applications.

385. Increasing Lentiviral Transduction by MG132- and CSP-Induced Inhibition of the Innate Immune Response

Naoya Uchida,¹ Matthew M. Hsieh,¹ Kareem N. Washington,¹ John F. Tisdale.¹

¹National Institutes of Health, Bethesda, MD.

TRIM5 α and the APOBEC family act as major restricting factors of HIV1 infection. When these innate immune factors are pharmacologically suppressed, retroviral infectivity significantly increases. MG132 is a proteasome inhibitor that targets APOBEC proteins and enhances retroviral gene transfer. Cyclosporin A (CSP) blocks interaction with HIV1-capsid (CA) and cyclophilin A (CypA) to enhance TRIM5 α restriction. Previously, we developed a chimeric HIV1 vector (χ HIV) with SIV-CA substituted for HIV1-CA in order to facilitate transduction efficiency for both human and rhesus CD34+ cells. This vector is presumed to function independently of the CA-CypA interaction; thus, we hypothesize that MG132 and CSP will increase transduction efficiency of the χ HIV vector for human CD34+ cells. We first performed 24-hour transduction of human CD34+ cells with GFP-expressing χ HIV or HIV1 vectors in media containing either MG132 or CSP. In dose-escalation studies of MG132 (0.05-0.5mM) and CSP (0.5-5.0mM), MG132 was found to increase %GFP detected for both the vectors (0.2mM; $p < 0.01$). However, a decrease in %GFP was observed at the highest concentration of MG132 (0.5 mM; $p < 0.01$) due to severe cell toxicity ($p < 0.01$). CSP treatment led to increases in %GFP of the χ HIV vector (0.5-2.0mM; $p < 0.01$) but to decreases in %GFP of the HIV1 vector (except at 2.0mM; $p < 0.05$). We then transduced CD34+ cells from six healthy donors in the presence of MG132 (0.2mM) or CSP (1.0mM). Averaged data indicated the same trends but large variations occurred among individuals. These data suggest that both MG132 and CSP can enhance transduction efficiency of CD34+ cells with the χ HIV vector, which is CypA-independent; however, MG132 and CSP have a small range of effective dose and large individual variation, and MG132 is toxic at high concentrations for human CD34+ cells. To assess the enhanced effects on transduction efficiency for long-term hematopoietic progenitor cells *in vivo*, we transduced human CD34+ cells with the

χ HIV vector in media containing MG132 (0.2 mM) or CSP (1.0 mM). The transduced cells were transplanted into sublethally-conditioned immunodeficient mice. MG132 and CSP increased %GFP expressed in the human cells (MG132 at 8, 16, 20 weeks; CSP at 8, 12, 20 weeks; $p < 0.05$), while there was no difference of human chimerism among MG132, CSP, and control groups. These data suggest that both MG132 and CSP can increase transduction efficiency of the χ HIV vector for long-term progenitor cells, and that both have less toxicity for long-term progenitor cells. In summary, both MG132 and CSP can increase transduction efficiency of the CypA-independent χ HIV vector for human CD34+ cells *in vitro* and *in vivo*. However, the dose of both should be carefully considered in each condition, since both drugs have a small range of effective dosage and MG132 is toxic to human CD34+ cells at high concentrations. These findings should contribute insights into the innate immune effects on lentiviral transduction of human hematopoietic cells.

386. Selective Gene Transfer Do CD105 Positive Cells – Targeting Mesenchymal Stroma Cells

Tobias Abel,¹ Irene Schneider,¹ Klaus Cichutek,¹ Christian J. Buchholz.¹

¹Medical Biotechnology, Paul-Ehrlich-Institute, Langen, Germany.

Endoglin (CD105), a surface molecule involved in the TGF- β signaling was initially described for its strong expression on endothelial cells. However it is also found to a great extent on multipotent mesenchymal stroma cells. Differentiated mesenchymal lineages like fibroblasts express CD105 to a lower degree. Selective transduction of mesenchymal stroma cells would be of great interest, as these cells are able to home to sites of tissue repair and can differentiate into several cell types like muscle, cartilage, bone and fat tissue. Nevertheless extracting mesenchymal stroma cells from tissue is a process, which is quite time consuming and the outcome greatly depends on methods and culture conditions. Thus it would be preferable to have a selective gene correction of those pluripotent cells widely independent of selection method and culture conditions, which in long term can also be used for direct gene transfer *in vivo*. To reach this goal we used lentiviral vectors re-targeted for CD105. The cell entry targeting is based on a technology, which relies on the pseudotyping of lentiviral vectors with engineered measles virus (MV) glycoproteins, the hemagglutinin and the fusion protein. Specificity for targeted gene delivery to CD105 is provided through the display of a single-chain antibody recognizing the antigen on the surface of the targeted cell population by fusing the reading frame of the single-chain antibody to that of the MV-hemagglutinin. Such re-targeted vectors are able to recognize CD105 expressing cells in cell culture at high efficiency, while CD105 negative cells remain virtually untouched. Taking advantage of the relatively low CD105 surface density on fibroblasts, mesenchymal stem/stroma cells were transduced about 10-fold more efficiently than fibroblasts in separate cultures. For *in vivo* studies also a vector targeting mouse CD105 was designed. In cell culture the mouse CD105 vector showed similar selectivity to mouse CD105 expressing cells and transduced efficiently primary CD105 positive cells isolated from heart tissue. As the expression pattern of CD105 slightly differs between human and mouse, species differences are evaluated. Currently ongoing, vectors are tested *in vivo* transferring a dual luciferase/sfGFP reporter. The data suggest that lentiviral endoglin-targeting vectors allow the specific genetic modification of pluripotent mesenchymal stroma cells and may thus improve the specificity of *in vivo* gene transfer applications. However upcoming experiments have to evaluate the strength of the targeting based on different administration routes *in vivo*.

387. Engineered Lentiviral Vectors Pseudotyped with a CD4 Receptor and a Fusogenic Protein Can Target Cells Expressing HIV-1 Envelope Proteins

Chi-Lin Lee,¹ Jason Dang,¹ Kye-Il Joo,¹ Pin Wang.¹

¹Department of Chemical Engineering, University of Southern California, Los Angeles, CA.

Lentiviral vectors (LVs) derived from human immunodeficiency virus type 1 (HIV-1) are promising vehicles for gene delivery because they not only efficiently transduce both dividing and non-dividing cells, but also maintain long-term transgene expression. Development of an LV system capable of transducing cells in a cell type-specific manner can be beneficial for certain applications that rely on targeted gene delivery. Previously it was shown that an inverse fusion strategy that incorporated an HIV-1 receptor (CD4) and its co-receptor (CXCR4 or CCR5) onto vector surfaces could confer to LVs the ability to selectively deliver genes to HIV-1 envelope-expressing cells. To build upon this work, we aim to improve its relatively low transduction efficiency and circumvent its inability to target multiple tropisms of HIV-1 by a single vector. We investigated a method to create LVs co-enveloped with the HIV-1 cellular receptor CD4 and a fusogenic protein derived from the Sindbis virus glycoprotein and tested its efficiency to selectively deliver genes into cells expressing HIV-1 envelope proteins. The engineered LV system yields a higher level of transduction efficiency and a broader tropism towards cells displaying the HIV-1 envelope protein (Env) than the previously developed system. Furthermore, we demonstrated *in vitro* that this engineered LV can preferentially deliver suicide gene therapy to HIV-1 envelope-expressing cells. We conclude that it is potentially feasible to target LVs towards HIV-1-infected cells by functional co-incorporation of the CD4 and fusogenic proteins, and provide preliminary evidence for further investigation on a potential alternative treatment for eradicating HIV-1-infected cells that produce drug-resistant viruses after highly active antiretroviral therapy (HAART).

388. A Multi Platform HIV-2 Derived Lentiviral Vector System and Its Potential Use as a Research Tool and for Gene Therapy Development

Ajit G. Chande,¹ Hemant R. Dhamne,¹ Rohan H. Kamat,¹ Santhosh V. Chakkaramakkil,¹ Rabindranath Mukhopadhyaya.¹

¹Virology, ACTREC, Tata Memorial Centre, Kharghar, Navi Mumbai, Maharashtra, India.

We developed an Indian human immunodeficiency virus type 2 (HIV-2) isolate derived lentiviral vector (LV) with a versatile multiple cloning site (MCS) that also allows direct sub-cloning of a PCR amplified transgene cassette. Efficiency of the vector systems has been validated by development of transgenic cell lines as well as long term expression of transgene *in vivo* (mouse models) and effective down regulation of target gene by delivery of specific shRNA, both *in vitro* and *in vivo*. Multiple user friendly formats have been developed now to expand utility of the LV. These include different antibiotics selection (G-418, puromycin and hygromycin), blue-white colony selection, streptavidin and HA tag for pull down and detection in interactome study, inclusion of additional MCS in LTR (dual MCS format) and use of a novel promoter for sustained transgene expression *in vivo*. In LV mediated gene transfer only those cells where the LV integrates receive the benefit of transgene expression and fewer number of target cell transduction *in vivo* is a major limitation. To bypass this limitation we developed a novel format where the product coded by the transgene can be secreted out with a cell penetrating peptide allowing entry to nearby untransduced cells thereby resulting in enhanced biodistribution of LV mediated transgene product. Efficacy of the system was evaluated using two different LV mediated transgene coded proteins, a fluorescent protein and a cytokine. We are also developing novel pseudotyping

as an approach to target specific cell types. Towards this we are using viral envelop protein to pseudotype LV for appropriate gene delivery to cells which are natural target for a particular virus and also pseudotype LV with particular carbohydrate binding proteins to target tumour cells over expressing specific interacting sugar moieties. Simultaneous development of appropriate vector formats with novel of target cell specific gene delivery will help in better gene therapy strategy evaluation.

389. Directed Integration of Insulated Lentiviral Vectors to the Heterochromatin towards Safer Gene Transfer to Stem Cells

Alexandre Artus,¹ Caroline Duros,¹ Yaïr Botbol,² Simone Scholz,³ Manfred Schmidt,³ Christof von Kalle,³ Marc Lavigne,² Odile Y. D. Cohen-Haguenaer,¹ Odile Y. D. Cohen-Haguenaer.⁴

¹LBPA and CLINIGENE, Ecole Normale Supérieure, Cachan, France; ²Laboratoire Joliot Curie, ENS de Lyon, Lyon, France; ³Laboratory of Translational Oncology, Deutsches Krebsforschungszentrum (DKFZ), Heidelberg, Germany; ⁴Medical Oncology and Oncogenetics, Hopital Saint-Louis and University Paris-Diderot, Paris, France.

We have investigated the improvement of integrating vectors safety in combining (i) new short synthetic genetic insulator elements (GIE) and (ii) directing integration to heterochromatin. We have previously identify a specific GIE combination in collaboration with Nic Mermod, which translates into high titers and boundary effect in both gammaretro and lentivectors (DCar4). In target cells, the expression profile becomes homogenous; its level is strictly conditioned by the promoter. These data remain stable in both HeLa cells and cord blood HSCs for over three months, irrespective of the multiplicity of infection (MOI). Since GIEs are believed to shield the transgenic cassette from inhibitory effects and silencing, 4xIns2-DCar4 has been further tested and compared to its non-insulated counterpart, with chimeric HIV-1 derived integrases targeting heterochromatin through either histone H3 or methylated CpG islands (ML6 & ML10 chimeras, respectively). With DCar4 and ML6 chimeras, a homogeneous expression is sustained over time. With the control, GFP expression is just over background double-mutant in catalytic and ledgf binding-sites while expression can be induced with HDAC. In CD34+ cells from cord-blood, these data are partially recapitulated with the ML6 chimera and entirely with the ML14, which includes an additional mutation translating in an enhanced specificity by one order of magnitude. High throughput integration sites analysis reveals a distinct profile with histone H3 targeting chimeras. Our approach could significantly reduce integration into open chromatin sensitive sites in stem cells at the time of transduction, a feature which might significantly decrease subsequent risk for insertional mutagenesis through undesired enhancer-activation, in combination with a potent and stable genetic insulation, regardless of the integration site.

390. Retroviral Delivery of Episomal Vectors

Julie Lemay,¹ Claudia Hagedorn,² Elena Kuzmenko,¹ Hans-Joachim Lipps,² Reinhard Seger,¹ Janine Reichenbach,¹ Ulrich Siler.¹

¹Division of Immunology/Hematology/BMT, PRC, University Children's Hospital Zürich, Zürich, Switzerland; ²ZBAF, Institute of Cell Biology, University Witten/Herdecke, Witten, Germany.

Recent clinical successes in human retroviral gene therapy were accompanied by unexpected side effects due to transactivation events. One approach to mediate transgene expression without the risk of transactivation is the expression from episomally maintained plasmids. As chemical transfection of hematopoietic stem cells is inefficient, we developed a new strategy for episomal vector delivery, using non-integrating retroviral vectors. We incorporated various

IFN- β S/MAR sequences into retroviral vectors allowing nuclear retention and replication of the circular DNA forms naturally produced by retroviruses alternatively to integration. We tested the viral delivery of these episomal vectors, and their persistence in dividing cells. We identified four splice acceptor site within the (+) oriented S/MARs interfering with vector production and GFP transgene expression. A 1.4kb S/MAR fragment in the (-) orientation was able to restore titers and transgene expression. Hygromycin resistant clones showed a weak GFP expression that could be increased by a histone deacetylase inhibitor confirming the episomal status of the vector in individual clones. Therefore, in human gene therapy the retroviral delivery of episomal constructs might represent a promising alternative to the electroporation of hematopoietic stem cells merging the limitation to cuvette size in electroporation.

391. Optimal Promoter Usage for Lentiviral Vector-Mediated Transduction of Different Cell Lines

Ling Zhang,¹ Pengyu Sun,² Wenjing Wang,¹ Junwen Shi,³ Dong Xiao,³ Jinlang Qiu,¹ Jingbo Wu,¹ Wanlong Tan,² Hongwei Li,¹ Chengyao Li.¹

¹School of Biotechnology, Southern Medical University, Guangzhou, Guangdong, China; ²Nanfeng Hospital, Southern Medical University, Guangzhou, Guangdong, China; ³Cancer Institute, Southern Medical University, Guangzhou, Guangdong, China.

Lentiviral vectors transduce both dividing and non-dividing cells and can support sustained expression of transgenes. Lentiviral vectors can target specific cell types by using different promoters in the lentiviral shuttle vector. Even with identical constructs, levels of expression can vary significantly in different types of cell lines. We systematically assessed the ability of different promoters to directly express EGFP foreign transgenes in 293A, acute lymphoblastic leukemia (MOLT-4 cells), and prostate cell lines (DU145 cells, PC3 cells and RM1 cells) via Flow Cytometry analysis. In 293A cells, the cytomegalovirus (CMV), ubiquitin, and polypeptide chain elongation factor-1 alpha (EF-1 α) promoters resulted in high levels of transgene expression. The results obtained in vitro indicated that the efficiency in 293A cells were: CMV (94.83 \pm 3.89) > ubiquitin (89.13 \pm 5.44) > EF-1 α (79.90 \pm 8.84). In MOLT-4 cells, they were: EF-1 α (74.27 \pm 2.14) > ubiquitin (64.83 \pm 13.01) > CMV (5.87 \pm 1.70). The order of transduction efficiency in DU145 cells was the same as MOLT-4 cells, and it was EF-1 α (25.15 \pm 7.0) > ubiquitin (23.55 \pm 7.71) > CMV (16.30 \pm 5.37). In PC3 cells, the values were: CMV (20.95 \pm 4.45) > EF-1 α (14.1 \pm 1.7) > ubiquitin (5.60 \pm 0.42). In RM1 cells, all three promoters showed very low activities: ubiquitin (16.90 \pm 0.42) > EF-1 α (10.10 \pm 1.56) = CMV (9.55 \pm 0.92). It can be suggested that specific promoters and appropriate host cells are important in achieving high levels of transgene expression. *Both authors contributed equally to this work.

AAV Capsids & Trafficking

392. Biodistribution of IV Injected AAV9 in Young Cynomolgus Macaques

Kevin D. Foust,¹ Adam K. Bevan,¹ Lyndsey Braun,¹ Leah Schmelzer,¹ Pablo R. Morales,² Brian K. Kaspar.¹

¹Center for Gene Therapy, Nationwide Children's Hospital, Columbus, OH; ²The Mannheimer Foundation, Homestead, FL.

Adeno-associated viruses (AAV) are effective viral vectors for producing stable transgene expression within the central nervous system. However, widespread transgene expression has been precluded by the limited dissemination of the virus following parenchymal injections. New AAV serotypes have shown the ability to escape the

vasculature following an intravenous injection and produce body wide transduction. We recently reported that intravenous injection of AAV9 results in transgene expression throughout the entire neuraxis of mice. Similar findings were subsequently reported by multiple independent groups who demonstrated that AAV9 can cross the blood brain barrier (BBB) in mice, rats and cats. In addition we published that AAV9 can also cross the BBB in non-human primates (NHP) which suggests the broad potential for the clinical utility of AAV9 in neurodegenerative disease. Here we expand on our initial report on AAV9 in NHP following intravenous injection into the peripheral limbs of male cynomolgus macaques. Using self-complementary AAV9 CB GFP at a dose comparable to our mouse studies (1-3x10¹⁴vg/kg body weight), in conjunction with The Mannheimer Foundation, we treated NHP at P1, P30 and P90. Animals persisted for 14-25 days post injection then were perfused with 4% paraformaldehyde. GFP histology from brain, spinal cord, skeletal muscle and major organs revealed system wide transgene expression after intravenous injection. GFP expression within brains was found predominantly in astrocytes and microglia while spinal cords had evidence of gene expression within motor neurons and dorsal root ganglia. All tissues examined had evidence of GFP expression at all time points, with skeletal muscle being the most extensively labeled. When possible, animals were pre-screened for the presence of antibodies against AAV9 prior to treatment and again upon sacrifice. All animals were negative for antibodies prior to dosing, but seropositive (>1/6400, the highest dilution tested) for antibodies against the vector capsid upon sacrifice. In conclusion, these results demonstrate that systemic injection of AAV9 can enter the CNS and transduce both glia and neurons of a non-human primate. These results are similar to those published in smaller species and further support the potential translation of AAV9 mediated delivery to the CNS of humans. In mice, the shift from neuronal to glial transduction in the spinal cord occurred by P10. It remains to be demonstrated if a predominantly glial pattern can be produced in NHP spinal cord, but it seems likely as the vector produces extensive glial transduction throughout the brains of all the animals examined. Importantly, motor neurons were targeted at all ages examined indicating a prolonged window of opportunity.

393. Terminal N-Linked Galactose Is the Primary Receptor for Adeno-Associated Virus Serotype 9 (AAV9)

Shen Shen,^{1,2,3} Kelli D. Bryant,² Sarah M. Brown,² Aravind Asokan.^{2,3,4}

¹Department of Biochemistry and Biophysics, The University of North Carolina at Chapel Hill, Chapel Hill, NC; ²Gene Therapy Center, The University of North Carolina at Chapel Hill, Chapel Hill, NC; ³Molecular and Cellular Biophysics Program, The University of North Carolina at Chapel Hill, Chapel Hill, NC; ⁴Department of Genetics, The University of North Carolina at Chapel Hill, Chapel Hill, NC.

The discovery of a large number of AAV isolates over the past decade has accelerated efforts to exploit their diverse tissue tropisms for therapeutic gene transfer applications. Successful translation from bench to bedside will require a thorough understanding of molecular mechanisms underlying AAV infection. As with other viruses, attachment to cell surface glycans constitutes the first step in the AAV infectious pathway. For instance, several AAV serotypes have been shown to bind heparan sulfate proteoglycans (AAV2; AAV6), while others utilize sialic acid for cell surface binding and entry (AAV4; AAV5; AAV1/6). We report an atypical example, where desialylation increases cell surface binding and infectivity of adeno-associated virus (AAV) serotype 9. Enzymatic removal of sialic acid, but not heparan sulfate or chondroitin sulfate, increased AAV9 transduction regardless of cell type. Viral binding and transduction assays on cell lines defective in various stages of glycan chain synthesis, revealed

a potential role for core glycan residues under sialic acid in AAV9 infection. Treatment with chemical inhibitors of glycosylation and competitive inhibition studies suggest that terminal galactosyl residues facilitate cell surface binding and transduction by AAV9. Quantitative analysis of AAV9 binding to parental or sialic acid-deficient cells revealed increased binding affinity of AAV9 particles to the cell surface upon desialylation. In summary, we will present a molecular basis for low infectivity of AAV9 *in vitro*. Studies corroborating the role of asialoglycans in AAV9 transduction *in vivo* will also be presented.

394. Rational AAV Capsid Engineering Via Peptide Insertion Reveals Critical Roles of the Underlying Vector Serotype

Marina Bechtel,¹ Eike Kienle,¹ Teresa Pankert,¹ Dirk Grimm.¹
¹*Infectious Diseases, Heidelberg University, Cluster of Excellence CellNetworks, Heidelberg, Baden-Wuerttemberg, Germany.*

Adeno-associated viruses (AAV) are remarkable templates for gene therapy vector development due to their amenability for rational capsid engineering. One of the most potent and versatile methods is peptide display whereby short amino acid stretches are inserted into exposed regions of the AAV capsid, hoping they will be presented on the viral surface and mediate particle re-targeting to specific cell types. In the past, a flurry of studies have documented the power of this approach in the context of the AAV2 prototype capsid, by creating entire libraries of peptide-modified AAV2 particles and by then selecting individual candidates with a desired novel tropism on cultured cells, or occasionally *in vivo*. Here, we asked whether and to what extent the AAV serotype background would actually influence the potency and specificity of a given peptide. We therefore initially modified 11 alternative AAV serotypes - 1, 3 to 9, rh.10, po.1 and 12 - by introducing unique restriction sites for cloning of peptide-encoding oligonucleotides into regions analogous to those identified for AAV2. Next, we inserted 6 different peptides previously selected in the AAV2 context on various cell types into our 11 modified capsids, resulting in a total of 84 distinct AAV capsids, i.e., 12 wildtypes, plus 72 mutants. We then produced reporter gene-expressing vectors based on all capsids in small scale and tested their efficiency and specificity of transduction on 28 diverse cell types, including numerous primary cells. Our key findings were: 1) The capsid backbone indeed essentially influences the functionality of given peptides, to an extent that was not anticipated and that was evidenced by the often drastically enhanced performance of individual serotypes as compared to the AAV2 prototype when expressing the same peptide; 2) Expression of certain peptides frequently not only rendered otherwise inefficient or even inert AAV wildtypes - such as AAV7, 8 or 9 - principally functional, but also made them highly efficient; 3) In many cases, the combination of specific peptides with certain capsids yielded vectors with such an increased efficiency that they allowed for the first time to transduce cell types that had previously been hard or impossible to infect. Our most impressive examples include human B- and T-cells for which we obtained >75% or even close to 100% transduction using purified vectors, respectively. Moreover, we made a number of biologically interesting observations that shed new light on the mechanisms of AAV transduction, including a curious increase in AAV9 mutant efficiency upon neuraminidase treatment of target cells, and the identification of NXXR as a generally highly potent re-targeting motif. Taken together, our results demonstrate an enormous previously unanticipated potential to improve AAV tropisms and efficiencies via the combination of specific peptides with certain non-serotype-2 capsids, and they thus open a wealth of new options to exploit AAV isolates for human gene therapy. Hence, we now created libraries of serotypes 1, 2, 7, 9 and rh.10 each displaying >1e5 randomized peptides and will present first results from their selection on various target cells.

395. Quantitatively Dissecting Viral Trafficking Kinetics at Single Particle Level

Ping-Jie Xiao,^{1,2} Richard J. Samulski.^{1,3}
¹*Gene Therapy Center, UNC-CH, Chapel Hill, NC;* ²*Cell and Developmental Biology, UNC-CH, Chapel Hill, NC;* ³*Pharmacology, University of North Carolina at Chapel Hill, Chapel Hill, NC.*

Virion trafficking through various intracellular organelles, eventually targeting the nucleus, is essential for successful infection by DNA viruses. However, given that numerous viral entry and trafficking events result in futile infection, a reliable and robust method that can be widely applied to quantitatively study all virus-host interaction is still lacking. Here we present a novel quantitative methodology that integrates single-particle fluorescence confocal microscopy with 3D deconvolution, isosurface-rendering and quantification to unambiguously sample all intracellular Cy5-labeled particles. Using Adeno-associated virus (AAV) as a working substrate, we quantitatively examined viral distribution and dynamics in human cells at the single viral particle level. By combining confocal microscopy and atomic force microscopy (AFM), we experimentally defined the numerical parameters for the singularity of Cy5-labeled viral particles *in vitro* as well as in a cellular environment. We quantitatively measured the association of viral particles with various subcellular organelles including lysosomes and nucleus over time. More importantly we uncovered an uncharacterized rate limiting step of nuclear entry when measuring nuclear accumulation of virions during the first 8hrs post-infection. Finally, we will briefly highlight the potential of this method for dissecting virus-subcellular organelle interactions and for resolving 3D distribution of biological nanoparticles in mouse tissues.

396. Structurally Annotating the Tropism and Transduction Determinants of AAV1 and AAV6

Robert Ng,¹ Mavis Agbandje-McKenna.¹
¹*Biochemistry and Molecular Biology, University of Florida, Gainesville, FL.*

The Adeno-associated viruses (AAVs) as attractive gene delivery vectors due to their ability to package non-genomic DNA, transduce a wide range of cell types and lack of associated disease. Of the hundreds AAV sequences isolated, the AAV2 serotype serves as the prototype member and has been utilized in several clinical trials. However, due to its broad tissue tropism and an observed pre-existing immune response to recombinant vectors, which reduces therapeutic efficacy, other serotypes are being actively characterized for clinical applications with a goal to achieve tissue specific and a reduced host immune response. These studies have shown that the capsid sequence of each AAV serotype plays a significant role in tissue tropism, transduction efficiency, and antigenic response. For example; despite high (82%) capsid protein sequence identity between AAV2 and AAV1/AAV6, the latter viruses transduce muscle and lung ~100 and ~200-fold more efficiently than AAV2, respectively. To start dissecting the capsid-associated tissue tropism and transduction determinants for the AAVs, structural, biochemical, and molecular genetics approaches are being applied to pinpoint the specific amino acids residues on the capsid of two highly homologous serotypes, AAV1 and AAV6, which differ by only 6/736 VP amino acids yet have distinct receptor binding and tissue transduction phenotypes. AAV1 binds sialic acid while AAV6 uniquely utilizes sialic acid and heparan sulfate for transduction. In addition, while AAV1 exhibits enhanced muscle transduction, AAV6 exhibits better liver and lung epithelial transduction. The three-dimensional structures of both AAV1 and AAV6 have been determined using cryo-electron microscopy and image reconstruction and using X-ray crystallography. Both viruses are structurally very similar with their VP structure consisting of the highly conserved, eight anti-parallel β -barrel core with large loop

regions between the β -strands that is the typical topology of the AAVs and parvoviruses in general. Comparison of the two structures shows that five of the 6 differing residues in VP3 are located at or close to the icosahedral 3-fold axis of the capsid, while one residue in the VP1 unique region is disordered in the structures. Review of the available mutagenesis data identifies this region as imparting important functions, such as receptor attachment and transduction phenotype. Further mutagenesis and biochemical studies are underway to pinpoint the specific residue(s) important for receptor recognition, cell binding, and transduction properties for these two viruses. The results of this study will contribute to efforts to manipulate the capsid sequences of the AAVs for specific cell targeting in therapeutic clinical applications.

397. A Potential Breakthrough in the AAV Biology: A Novel High-Throughput Capsid Functional Analysis Using Barcoded AAV Libraries and a Deep Sequencing Technology

Kei Adachi,¹ Tatsuji Enoki,² Christopher S. Naitza,¹ Hiroyuki Nakai.¹

¹Department of Microbiology and Molecular Genetics, University of Pittsburgh School of Medicine, Pittsburgh, PA; ²Center for Cell and Gene Therapy, Takara Bio Inc., Otsu, Shiga, Japan.

Biological applications of the next generation parallel sequencing technologies have been increasingly expanding due to their ability to quickly generate an enormous amount of information from over 10-100 millions of sequence reads in one run at ever-decreasing costs. By taking advantage of such contemporary technologies, we have proposed and are developing a new systematic and comprehensive viral reverse genetics approach named "Barcode-Seq" analysis. Capsid protein is the major determinant of the biological properties of AAV. Conventional approaches have provided clues to the identification of functional domains in the AAV capsid; however, the biological rule that governs the capsid structure-phenotype relationships has remained extremely puzzling. To make a breakthrough in this field, we have started exploring a high-throughput method to study the biological properties of AAV capsids derived from various serotypes and variants in an unprecedented manner, using barcoded AAV libraries and the next generation Illumina sequencing technology. Here we show proof-of-principle and the power of our new approach, Barcode-Seq, in the AAV biology. In our study, we constructed 100 wild type AAV9 (wtAAV9-BC) plasmids and those that encode different serotype capsid genes (wtAAVx-BC), each of which contained 2 sets of unique 12-nucleotide barcodes (i.e., VBC1 and VBC2). First, using a barcoded library containing 100 different wtAAV9-BC (in which each carried a unique set of VBC barcodes), we investigated the correlation between digital read numbers obtained from the Illumina sequencing and the quantity of DNA templates, showing high correlation with $R^2=0.91$ and 0.98 for VBC1 and VBC2, respectively, over a 4-log range. A computer simulation study using Mann-Whitney U-test revealed that as low as 2-fold difference can be detected with $p<0.05$ and r (power) >0.99 when digital reads from as low as 4 sets of VBC1 and VBC2 barcodes are sampled and compared between two experimental groups. Second, a mixture of 100 wtAAV9-BC and 22 wtAAVx-BC viruses (AAVBCLib1) were produced and injected into mice intravenously, and investigated for blood clearance rates, tissue infectivity, antibody reactivity etc., by the Barcode-Seq approach. The representativeness of each of 100 wtAAV9-BC virus genomes recovered from 7 different tissues was very well retained with no statistical significance between the tissues by the Kruskal Wallis test, showing negligible tissue-dependent bias in the viral infectivity among the 100 wtAAV9-BC viruses. In addition, the digital reading of phenotypes readily revealed the distinctively delayed blood clearance of AAV9 compared to the other 7 serotypes in the library and characteristic reactivity to neutralizing antibodies

in each serotype. Thus, our study establishes proof-of-principle of our new approach and opens a new avenue to comprehensive high throughput reverse genetics study of the AAV capsid functions toward the development of next generation vectors with the most desirable biological properties.

398. Adeno-Associated Virus 2 Infection Requires Endocytosis through the CLIC/GEEC Pathway

Matthieu Nonnenmacher,¹ Thomas Weber.¹

¹Cardiovascular Research Center, Mount Sinai School of Medicine, New York, NY.

Several receptors responsible for the attachment of adeno-associated virus type 2 (AAV2) to the cell surface have been characterized but the endocytic mechanism involved in AAV2 infection has not been fully established. Here, we report that recombinant AAV2 transduction is independent of clathrin-, caveolin- and dynamin-mediated endocytosis. Conversely, AAV2 infection involves an intact actin cytoskeleton and cholesterol and is sensitive to EIPA, a fluid-phase uptake inhibitor. However, AAV2 infection is only marginally affected by Rac1 inhibition and does not trigger increased cellular uptake of fluid-phase, arguing against macropinocytosis as the major endocytic pathway for AAV2. In contrast, AAV2 endocytosis and transduction are dependent on GRAF1, Cdc42 and Arf1, all involved in the formation of clathrin-independent carriers (CLIC), and virions co-localize with markers of the GPI-enriched endosomal compartment (GEEC). Taken together, our results indicate that the pleiomorphic CLIC/GEEC pathway constitutes the major endocytic route for AAV2 infection.

399. AAV2 and AAV8 as Gene Therapy Vectors Targeting Distal Lung Epithelial Progenitor Cells

Benjamin R. Steines,¹ David D. Dickey,¹ Boulos S. Nassar,¹ Joseph Zabner,¹ Xiaopeng Li.¹

¹Internal Medicine, University of Iowa, Iowa City, IA.

There are several diseases for which the targeting of lung tissues for gene therapy would be beneficial, such as cystic fibrosis, surfactant deficiency, and some lung cancers. In many of these instances, transduction of stem or progenitor cells of the lung could provide a lasting therapeutic effect. Vectors derived from Adeno-associated viruses (AAV) are promising gene therapy vector candidates due to their inherent low immunogenicity, long term expression in transduced cells, and wide tissue tropism which includes both dividing and non-dividing cells. Here we hypothesized that AAV vectors could be used to transduce distal lung epithelial progenitor ($\alpha6\beta4$ integrin positive) cells and asked which AAV serotype is most proficient at transducing this type of cell. Using multiple serotypes of AAVs containing a GFP reporter, we infected lung epithelial cells that were either positive or negative for $\alpha6\beta4$ integrin and analyzed the number of cells infected. All AAV serotypes were capable of transducing both $\alpha6\beta4^+$ and $\alpha6\beta4^-$ cells and did so in a dose dependent manner. In all cases, $\alpha6\beta4^+$ cells were transduced more efficiently than their $\alpha6\beta4^-$ counterparts. Importantly, AAV2 and AAV8 were significantly more effective at transducing $\alpha6\beta4^+$ cells than $\alpha6\beta4^-$ cells. These data suggest that AAV2 and AAV8 may prove to be useful at targeting distal lung epithelial progenitors in gene therapy applications.

400. Characterization of Chimpanzee-Derived Novel Natural Variants of AAV5

Li Zhong,^{1,3} Mengxin Li,^{1,2,4} Jun Xie,^{1,4} Qin Su,¹ Ran He,¹ Yu Zhang,^{1,4} Jason Goetzmann,⁵ Terry Flotte,³ Guangping Gao.^{1,4}
¹Gene Therapy Center, University of Massachusetts Medical School (UMMS), Worcester, MA; ²Division of Hematology/Oncology, Department of Medicine, University of Massachusetts Medical School, Worcester, MA; ³Department of Pediatrics, University of Massachusetts Medical School, Worcester, MA; ⁴Department of Microbiology and Physiology Systems, University of Massachusetts Medical School, Worcester, MA; ⁵New Iberia Research Center, University of Louisiana at Lafayette, New Iberia, LA.

Recent development in AAV vectorology resulted in a panel of efficient vehicles that were originated from natural serotypes/variants, direct evolution, or rationale design. AAV5-derived vector stands out in transduction of some major organs, such as lung, joint and brain in animal models. In an attempt to isolate natural variants of AAV5, we rescued 30 full length capsid sequences that were closely related to AAV5 from chimpanzee tissues including liver (Lv), heart (Ht) and spleen (Sp). A subset of these novel AAV5 variants that were retrieved from either cellular DNA by PCR (CHt6.1, CHt6.6, CHt6.10, CSp8.6, and CSp8.8) or RNA by RT-PCR (CLv-M2, CLv-M6, CLv-M8, CHt-P6 and CHt-P8) was selected for vector development and evaluation. Differences in capsid sequences between AAV5 and these selected novel variants ranged from 1 to 5 amino acids. Three vectors can be packaged efficiently (CHt6.1, CHt6.10 and CHt-P6), one can be packaged at lower titer (CSp8.8), and the other six cannot be packaged. These data indicated that several amino acids are critical for AAV5 packaging. Those four vectors were evaluated in 293 cells in vitro and showed similar transduction efficiency as AAV5, except for CSp8.8, which barely transduced 293 cells. These four vectors along with AAV5 were further evaluated in C57BL/6 mice in vivo for α 1-anti-trypsin (AAT) gene transduction after intravenous (i.v.), intramuscular (i.m.), and intra-nasal (i.n.) administration at dose of 1.5×10^{10} - 1.0×10^{11} GC/animal. Our data demonstrated CHt-P6 topped all other vectors and led AAV5 in AAT expression by 2-3 folds after i.v., i.m. and i.n. delivery for 12 weeks. Additionally, while CHt6.10 vector led to poor AAT expression, CHt6.1 and CSp8.8 accomplished decent transduction in between. In an attempt to compare tissue/cell tropisms, nLacZ transduction by AAV5 and CHt-P6 at dose of 1.0×10^{11} GC/animal was performed in liver, skeletal muscle and lung. The data did not demonstrate significant differences in liver and muscle transduction between these two vectors after i.v. and i.m. injection, but showing a slight lead by CHt-P6 in nLacZ transduction in lung after i.n. delivery. In the lung, CHt-P6 targeted both alveoli and airway epithelia as did AAV5. Also, CHt-P6 did not target other organs such as lung, muscle, heart and kidney after i.v. injection. This study provided useful information on development of novel AAV5 variants vectors, which could be an alternative choice for gene therapy in lungs. Further studies are important to elucidate the potential correlations among the capsid structure, viral infectivity, and critical functional domains in the AAV5 capsid, which may contribute to its interesting vector biology.

401. Widespread Transduction of Brain Parenchyma after Intraventricular Injection of AAV9 Compared to AAV4 and AAV5

Annagiusti Gargiulo,¹ Nicolina C. Sorrentino,¹ Carmine Spampinato,¹ Alessandro Fraldi,¹ Enrico M. Surace.¹
¹TIGEM-Telethon Institute of Genetics and Medicine, Naples, Italy.

Overcoming the difficulty of efficient delivering and distribution of therapeutic agents globally to the CNS represents a major challenge for the treatment of most brain disorders. Current protocols for viral

vector-mediated gene delivery have showed several limits. Stereotaxic injection of the vector to the CNS parenchyma results only in localized brain transduction while intra-vascular administration may results in extensive brain transduction but is hampered by the presence of the blood brain barrier (BBB) and by the systemic exposure of the therapeutic vector. Instead, intra-ventricular administration leads to a wide transduction of several brain structures of cerebral parenchyma and has the advantage of a limited extra-CNS exposure. In this study we tested transduction characteristics of adeno-associated virus (AAV) vector serotype 9 upon intra-ventricular administration and compared it to AAV4 and AAV5 vectors, currently considered the best vector serotype upon intra-ventricular delivery (Liu et al., 2005; Fraldi et al., 2007). To evaluate levels and pattern of viral transduction we injected intra-ventricularly P0/P1 wild-type mice with viral vectors containing both Luciferase and EGFP genes. Mice were examined 3 weeks after vector delivery by Luciferase assay and EGFP staining. To determine precisely vector transduction distribution, luciferase levels were evaluated in different brain slices over the anterior-posterior axes. Intra-ventricular administration of AAV9 outperforms all serotypes tested, mainly AAV4 on an average of 8-fold. Robust luciferase expression levels were found higher in the olfactory bulb and the striatum compared to hippocampus and cerebellum. EGFP signal confirms vector transduction in these brain sections. To determine cerebral cell subtypes transduction we are currently performing colocalizations staining with neuronal, glial and endothelial markers. The results here reported support the use of AAV9 as a promising vector for the treatment of brain disorders affecting the CNS globally such as the Multiple Sulfatase Deficiency (MSD).

402. High-Efficiency Transduction of Primary Human Monocytes-Derived Dendritic Cells (moDCs) by Recombinant Adeno-Associated Virus Vectors Containing a Point Mutation in the Surface-Exposed Serine Residue

George V. Aslanidi,¹ Chen Ling,¹ Ashley T. Martino,¹ Lakshmanan Govindasamy,² Mavis Agbandje-McKenna,² Roland W. Herzog,¹ Arun Srivastava.¹

¹Department of Pediatrics, University of Florida College of Medicine, Gainesville, FL; ²Department of Biochemistry and Molecular Biology, University of Florida College of Medicine, Gainesville, FL.

Gene-modified dendritic cells (DCs) are able to modulate antigen-presenting cell functions and induce therapeutic immunity or tolerance in an antigen-specific manner. However, there are conflicting reports on the transduction efficiency of dendritic cells (DCs) by commonly used rAAV vectors. We hypothesized that rAAV2 vectors fail to transduce DCs effectively, in part, because serine/threonine-specific protein kinases phosphorylate surface exposed serine and/or threonine residues followed by ubiquitination of AAV capsids, which leads to cellular proteasome-mediated degradation. In the present studies, we have observed that selective inhibitors of JNK and p38 MAPK serine/threonine kinases improve the transduction efficiency of primary human monocytes-derived DCs (moDCs) by rAAV2 up to 4- and 6-fold, respectively (Fig. 1A). We reasoned, therefore, that mutations of the surface-exposed serine residues might allow the vectors to evade phosphorylation and subsequent ubiquitination and, thus, prevent proteasome-mediated degradation. Indeed, site-directed mutagenesis of a serine residue at position 662 to valine (S662V) increased the transduction efficiency of AAV vectors by ~6-fold in moDCs (Fig. 1A). We next evaluated the possibility whether S662V-AAV vectors could be used for generating antigen-specific cytotoxic T-cells (CTLs). To this end, S662V-AAV2 vectors encoding a truncated human telomerase (hTERT) gene were generated, and used to stimulate CTLs against a human hepatocellular carcinoma cell line, Huh7. Our data show that S662V-AAV2-hTERT-transduced DCs

resulted in rapid (within one week), specific T-cell clone proliferation and generation of robust CTLs. An in vitro CTL assay was set up, and specific cell lysis was determined by fluorescence-activated cell sorting (FACS) analysis of live/dead cell ratios (Fig. 1B). These results suggest that high-efficiency transduction of moDCs by serine-modified AAV vectors is feasible, which supports the potential utility of these vectors for future human DC vaccine studies.

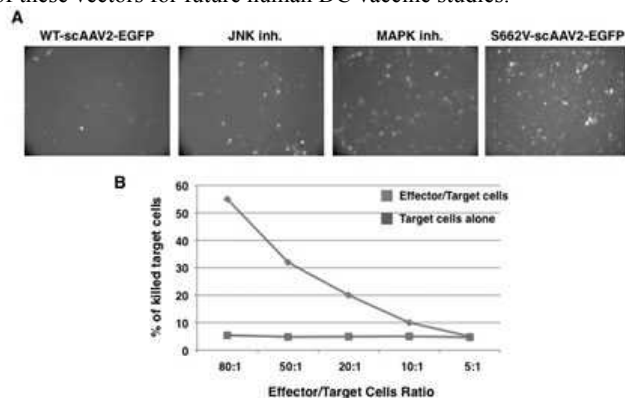

Fig. 1. (A). Transduction efficiency of scAAV2 vectors in primary human moDCs following pre-treatment of cells with JNK and MAPK inhibitors, or following site-directed mutagenesis of the surface-exposed serine (S) to valine (V) at position 662 (S662V). **(B).** Killing curve for specific lysis by S662V-AAV2-hTERT vector-transduced moDCs against Huh7 cells.

403. A Capsid Composition Variant Containing four VP Proteins Caused by a Novel Start Codon at Position 219 of the Nucleotide Sequence of AAV8 Cap

Olga Zelenai,¹ Federico Mingozzi,¹ Bernd Hauck,¹ Shangzhen Zhou,¹ Katherine A. High,^{1,2} J. Fraser Wright.^{1,3}

¹Center for Cellular and Molecular Therapeutics, Children's Hospital of Philadelphia, Philadelphia, PA; ²Howard Hughes Medical Institute, Children's Hospital of Philadelphia, Philadelphia, PA; ³Pathology and Laboratory Medicine, University of Pennsylvania School of Medicine, Philadelphia, PA.

Recombinant adeno-associated virus serotype 8 vectors generated by transient transfection of HEK293 cells and highly purified by combined column chromatography and gradient ultracentrifugation steps were observed to contain a VP band in addition to the canonical VP1, 2 and 3, when assessed by SDS-PAGE / silver staining. The additional band migrated at a position intermediate between the VP1 and VP2 as determined by Western blotting using monoclonal antibody B1, and was designated 'VP1.5'. Sequencing of the packaging plasmid used to generate this vector indicated a single nucleotide difference from the expected AAV8 Cap sequence, with G replacing C at position 219. This nucleotide exchange is not predicted to change the amino acid sequence of the encoded proteins, but results in a novel CTG start codon at a position intermediate between the VP1 and VP2 start codons. Estimated by band intensity using silver staining, or Coomassie blue staining (with higher loading) of SDS-PAGE gels, the anomalous VP1.5 band was present at a comparable quantity to VP1 and VP2. Dynamic light scattering analysis indicated that highly purified AAV8 particles containing VP1.5 were indistinguishable from normal recombinant AAV8, both demonstrating a radius in the range 13-15nm. Examination of normal and VP1.5-containing AAV8 particles by negative staining electron microscopy indicated similar morphology; however, a slight loss of symmetry in the variant particles was noted. In a side by side experiment to characterize the functional activity of the VP1.5 variant, a human coagulation FIX expression cassette driven by the

liver-specific human Alpha 1 Anti-Trypsin (hAAT) promoter was packaged using normal or VP1.5 variant capsids and the vectors were purified using an optimized double cesium gradient ultracentrifugation purification method (Grimm et al, 2005; Ayuso et al, 2010). Based on titering by two methods (protein based and qPCR) to ensure comparability, the respective vectors were injected via tail vein in B57/Bl6 mice at a dose of 2.5E10 vg/mouse (five mice per dose). Both vectors resulted in indistinguishable, high level expression of hFIX at all time points tested (2, 4 and 6 weeks), with > 75ug/mL of circulating hFIX measured at week 6. Animals receiving the variant capsid showed a lower anti-capsid IgG response than AAV8-injected mice. These data characterize a novel capsid composition observed in recombinant AAV8, caused by a novel translational start codon in Cap, that retains normal structure and functional activity. Manipulation of capsid protein VP length and composition may be exploited to further optimize recombinant vectors.

404. Systematical Evaluation of Tropism of Different AAV Serotype Vectors in Adult and Neonatal Mice Following I.V. Injections

Li Zhong,^{1,3} Mengxin Li,^{1,2,4} Xin Mu,^{1,4} Christopher Boisvert,^{1,4} Dmitry Ratner,^{1,4} Qin Su,¹ Ran He,¹ Sheng Chen,^{1,2,4} Jun Xie,^{1,4} Yu Zhang,^{1,4} Hongwei Zhang,^{1,4} Daniel Lucking,⁵ Terry Flotte,³ Guangping Gao.^{1,4}

¹Gene Therapy Center, University of Massachusetts Medical School, Worcester, MA; ²Division of Hematology/Oncology, Department of Medicine, University of Massachusetts Medical School, Worcester, MA; ³Department of Pediatrics, University of Massachusetts Medical School, Worcester, MA; ⁴Department of Microbiology and Physiology Systems, University of Massachusetts Medical School, Worcester, MA; ⁵Olympus America, Inc, Center Valley, PA.

Twelve adeno-associated virus (AAV) serotypes and more than 100 AAV variants have been characterized in human and non human primate (NHP) populations, which have gained much attention as potentially useful vector for gene transfer and gene therapy. Due to their different capsid surface properties, these new vectors present novel tropism profile in vivo. In this study, we compared the transgene expression in different organs after intravenously injecting different self-complementary (sc)AAV serotypes and variants - EGFP vectors at doses of 4x10¹² GC/animal in 10-week old adult mice (AAV1, 6, 6.2, 7, 9, rh10 and rh39) and 4x10¹¹ GC/animal in postnatal 1-day old newborn mice (AAV1, 2, 5, 6, 6.2, 7, 9, rh10, rh39 and rh43). The organs and tissues were collected, sectioned and examined under fluorescence microscopy after 3 weeks post-injection. In adult mice, we found that AAVrh10 led to dramatical GFP expression in adipose tissues, renal tubules in kidney, pancreas, keratinocytes in skin and stomachs, although it was the least efficient vector to transduce liver and also was modest in transducing cardiac muscles. The AAV mediated-GFP expression is low in the lung, and is high in the skeletal muscles without much difference among all the vectors. In neonatal mice, we found that the transduction profile was different. The AAV-mediated GFP expression was rare in pancreas and gastric intestines. The transduction efficiency was low in liver and stomachs. But all the vectors led to strong GFP expression in the skeletal muscles and cardiac muscles. In the kidney, the AAV2 vector transduced renal tubules and glomeruli very efficiently, whereas AAVrh10 led to highly-efficient GFP expression in renal papilla. In the skin, AAVrh39 and AAVrh10 led to high GFP expression in keratinocytes. In the lung, AAVrh10 resulted in highly efficient GFP expression, and both alveolar and airway epithelia cells were targeted. AAV7 and AAV9 also transduced the lung well, however, primarily targeted alveolar cells. Overall, our data not only provided the AAV tropism information after high dose I.V. administration, but also indicated some AAV vectors have unique tropism, such as AAVrh10, which targeted kidney,

lung, skin and adipose tissue efficiently after i.v. administration. The result of this study should be informative for selecting different AAV vectors for different applications in human gene therapy.

405. A Rationally Designed Synthetic Combinatorial AAV Capsid Library as a Gene Therapy Tool

Damien Marsic,¹ Sergei Zolotukhin,¹ Lakshman Govindasamy,² Babak Moghimi,¹ Daniela Hurtado.¹

¹*Pediatrics - Division of Cell & Molecular Therapy, University of Florida, Gainesville, FL;* ²*Department of Biochemistry and Molecular Biology, University of Florida, Gainesville, FL.*

Adeno-associated virus (AAV) is a promising vector for human gene therapy applications because of its absence of pathogenicity, low immunogenicity, episomal localization and stable transgene expression. However, major limitations include limited tropism and susceptibility to neutralization by human antibodies, both of which are determined by the capsid surface composition. Therefore, capsid libraries present an attractive approach to overcome those limitations. Various strategies have been described to generate AAV capsid libraries, including random peptide display, error-prone PCR or DNA shuffling. We describe a novel approach based on gene synthesis technology, which allows to specifically vary the amino acid residues which side chains are exposed to the capsid surface, and to limit diversity to naturally occurring variants. Compatibility with capsid structure and function is therefore optimized, resulting in a higher probability of generating useful clones. In addition, recombination between naturally-occurring sequences is at the nucleotide level. The resulting libraries therefore contain unique combinations that could not be obtained through other methods. We present here the design, assembly and characterization of such a synthetic AAV capsid library, as well as preliminary data on in vivo selection of targeted AAV vectors using rodent models.

406. Development of Optimized AAV3 Serotype Vectors: Mechanism of High-Efficiency Transduction of Human Liver Cancer Cells

Binbin Cheng,^{1,2} Chen Ling,¹ Yao Dai,³ Lyudmyla G. Glushakova,⁴ Yuan Lu,¹ Samantha W. Y. Gee,¹ Katherine E. McGoogan,¹ George V. Aslanidi,¹ Morag Park,⁵ Peter W. Stacpoole,⁴ Dietmar Siemann,³ Arun Srivastava,¹ Changquan Ling.²

¹*Department of Pediatrics, University of Florida College of Medicine, Gainesville, FL;* ²*Department of Traditional Chinese Medicine, Second Military Medical School, Shanghai, China;* ³*Department of Radiation Oncology, University of Florida College of Medicine, Gainesville, FL;* ⁴*Department of Medicine, University of Florida College of Medicine, Gainesville, FL;* ⁵*Department of Biochemistry, McGill University, Montreal, QC, Canada.*

We have reported that AAV serotype 3 vectors transduce human hepatoblastoma (HB) and hepatocellular carcinoma (HCC) cell lines as well as primary human hepatocytes extremely efficiently (*Mol. Genet. Metabol.*, 98: 289-299, 2009). We have also documented that AAV3 utilizes human HGFR as a cellular co-receptor for viral entry (*Hum. Gene Ther.*, 21: 1741-1747, 2010). Here, we provide further evidence that both extracellular as well as intracellular kinase domains of hHGFR are involved in AAV3 vector entry and AAV3-mediated transgene expression. We report here that: (i) AAV3 vector-mediated transduction is significantly increased in T47D cells, a human breast cancer cell line that expresses undetectable levels of the endogenous hHGFR, following stable transfection and over-expression of hHGFR (Fig. 1A); (ii) the tyrosine kinase activity associated with hHGFR negatively affects the transduction efficiency of AAV3 vectors (Fig. 1B,C); (iii) the use of proteasome inhibitors significantly improves AAV3 vector-mediated transduction; (iv) site-directed mutagenesis of

specific surface-exposed tyrosine residues on the AAV3 capsid leads to improved transduction efficiency; and (v) a specific combination of two tyrosine-mutations further improves the extent of transgene expression (Fig. 1D). These optimized AAV3 vectors may be useful for the potential gene therapy of liver cancer in humans.

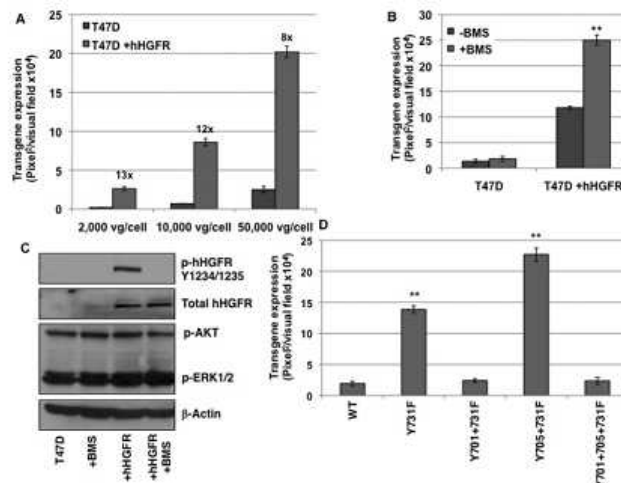

Fig. 1: AAV3-mediated transgene expression in T47D and T47D+hHGFR cells. (A) Cells were infected with various indicated multiplicity-of-infection of scAAV3-CBAp-EGFP vectors under identical conditions. Transgene expression was determined by fluorescence microscopy 72 hrs post-infection. (B) Cells were transduced with 2,000 vgs/cell of scAAV3 vectors in the absence or presence of 5 g/ml of hHGF. Transgene expression was determined as above. (C) The effect of HGFR tyrosine kinase-specific inhibitor, BMS-777607 (BMS), on AAV3-mediated transgene expression. Cells were mock-treated or pretreated with BMS for 2 hrs. Whole-cell lysates were prepared and analyzed on Western blots using various indicated primary antibodies. (D) Transduction efficiency of WT and single, double, and triple tyrosine-mutant AAV3 vectors. Cells were transduced with WT or various indicated Y-F mutant scAAV3-CBAp-EGFP vectors under identical conditions.

407. Development of a Simple and Serotype-Independent System To Assess the AAV Assembly-Activating Protein (AAP) Function

Tatsuji Enoki,^{1,2} Kei Adachi,¹ Christopher S. Naitza,¹ Hiroyuki Nakai.¹

¹*Department of Microbiology and Molecular Genetics, University of Pittsburgh School of Medicine, Pittsburgh, PA;* ²*Center for Cell and Gene Therapy, Takara Bio Inc., Otsu, Shiga, Japan.*

Recombinant adeno-associated virus (rAAV) is an attractive platform for gene delivery vectors due to its non-pathogenicity and ability to mediate long-term therapeutic gene expression in vivo. However, challenges remain in controlling in vivo tropism and creating next generation rAAV vectors with the most desirable properties in each application, due to the lack of sufficient knowledge about the AAV capsid biology. Recently, an alternative open reading frame, ORF2, has been identified within the AAV cap gene by Kleinschmidt and his colleagues. Their study has shown that assembly-activating protein (AAP) encoded by the ORF2 plays an indispensable role in AAV capsid assembly assumingly by providing a scaffold for capsid formation in nucleoli. It is presumed that the coincidental functional conservation of the two frame-shifted ORFs for VP and AAP proteins encoded by a shared viral genomic region have constrained natural evolution of the AAV capsids derived from various serotypes. Therefore, capsid reverse genetics studies with the AAP function being supplied in trans would be of great significance. Here we report our novel and simple system to assess

the function of AAPs derived from various serotypes. The current system reported in literature relies on mouse monoclonal antibody (mAb) A20, which reacts specifically with assembled AAV2 particles by recognizing an epitope(s) that is present only in the assembled but not in the unassembled VP proteins. Although the system based on mAbs against intact AAV particles is reliable and straightforward, the availability of such mAbs for serotypes other than AAV2 is currently very limited; therefore, it would not be easy to expand its application to various serotypes. To overcome this limitation, we constructed an AAV capsid assembly reporter, AAV-Rep2, and sought to exploit this reporter to indirectly assess the AAV capsid assembly. AAV-Rep2 carried only the AAV2 rep gene between the two AAV2 inverted terminal repeats; therefore it could express Rep proteins but required the cap gene expression in trans for its viral genomes to be packaged in virion shells. HEK293 cells were co-transfected with pAAV-Rep2 (a plasmid containing the AAV-Rep2 genome), pCMV-AAV9-VP3 (a plasmid expressing only AAV9-VP3) and an adenovirus helper plasmid in the presence or absence of the fourth plasmid expressing AAP2 (the reported AAP derived from AAV2) or AAP9 (a putative AAP derived from AAV9). At 48-hours post-transfection, DNase I-resistant AAV-Rep2 viral genomes were quantified by a dot blot assay. As a result, our new system could identify the functional AAP9 amino-acid sequence and successfully demonstrate the requirement of AAP expression in efficient AAV9 capsid assembly and the ability to complement the function of an AAP derived from one serotype with that from another. Thus, the new system we report here provides a powerful and reliable means to study the function of AAPs derived from various serotypes and serves as a tool for AAV capsid engineering that disrupts the AAP ORFs.

408. Directed Evolution of Adeno-Associated Virus: Construction of an Enriched Random Insertion Library and Artificial Selection To Identify Structure-Function Relationships

Justin H. Judd,¹ Jonathan Silberg,^{1,2} Junghae Suh.¹

¹Bioengineering, Rice University, Houston, TX; ²Biochemistry and Cell Biology, Rice University, Houston, TX.

Adeno-associated virus (AAV) is a promising clinical therapeutic gene delivery vector due to its unusually high safety profile. Still, virus targeting is a critical parameter in successful gene delivery that has yet to be entirely resolved. Using the crystal structure of AAV2 as a structural guide, rational design has been used to achieve vector targeting through ligand-receptor interactions. However, detailed *a priori* knowledge of protein structure and function is still elusive, often precluding direct translation of known cell-targeting ligands into the context of the AAV capsid. Directed evolution is an attractive alternative for altering virus tropism for which success has been reported using mutagenic techniques such as error-prone PCR and gene shuffling. Transposon-based random insertion or random domain insertion by DNase can be used to identify ideal insertion sites for known targeting ligands. However, limitations to these approaches include a high frequency of frameshifted, non-viable mutants and/or limited crossover diversity, reducing the output of ensuing, often tedious, selection efforts. To address these vector design challenges, we have developed a versatile, enriched, random insertion library using the AAV2 capsid gene (*cap*) as a scaffold. Briefly, a plasmid carrying *cap* was randomly linearized, blunted and ligated to a linker containing directional, unique, flanking restriction sites encoding small amino acids. *Cap* genes with a single insert were isolated and non-viable mutants were removed from the pool. Remaining *cap* genes - containing a single, in-frame, correctly oriented, randomly inserted linker - were subcloned into an AAV expression vector and the resultant library named pAAV_RaPID (Random Peptide Insertion by DNase). The pAAV_RaPID plasmid library can be used to quickly insert any peptide motif randomly into the AAV *cap* gene

with a high frequency of viable variants and broad crossover which should increase the occurrence of functional AAV variants in directed evolution studies. Additionally, we demonstrate that the carefully selected restriction sites used in the construction of the pAAV_RaPID library facilitate a novel vector-religation/recombination event, resulting in a high-throughput scanning alanine substitution library with enhanced diversity. Furthermore, we show the utility of this latter library variation in quickly identifying important functional motifs in the AAV2 capsid protein using simple *in vitro* selection methods.

Adenovirus and Other DNA Virus Vectors II

409. Necrosis and Autophagy, but Not Apoptosis, Are Induced in Macrophages In Vivo upon Interaction with Adenovirus

Nelson C. Di Paolo,¹ Dmitry M. Shayakhmetov.¹

¹Medical Genetics, University of Washington, Seattle, WA.

Several homeostatic and pathological cell death mechanisms exist, including apoptosis, pyroptosis, necrosis, and others. We are interested in understanding the cell death pathway induced in macrophages *in vivo* in response to a model virus, adenovirus (Ad). Our studies in mouse models revealed that splenic methallophilic CD169- and MARCO-positive marginal zone macrophages (MZM ϕ) selectively trap Ad after intravascular inoculation. After interaction with Ad, these cells undergo a rapid, caspase-independent pro-inflammatory cell death that is distinct from classical apoptosis. Staining of spleen sections with TUNEL or activated caspase-3-specific antibody revealed that MZM ϕ undergo a caspase-3-independent type of cell death. However, injection of mice with propidium iodine (PI) revealed numerous cells with PI-positive nuclei in splenic MZ 1h after virus administration, indicating that the plasma membrane integrity was compromised, a hallmark of necrotic type of cell death. Furthermore, we found that Ad entry into MZM ϕ induces formation of LC3-positive autophagosomes. Electron microscopy studies showed that MZM ϕ containing virus particles have complete disorganization of the cytoplasm and swelling and breakdown of mitochondria and other organelles by 4h after Ad challenge. Interestingly, administration of a mutant Ad, Ad-ts1, which is unable to rupture cellular endosomes, showed that both CD169- and MARCO-positive cells survived in the splenic marginal zone after virus injection, suggesting a link between endosome rupture and the induction of necrotic type cell death in macrophages. These results shed light on the unique mechanism of the adenovirus-induced macrophage death, as well as broaden our understanding of the biology of adenovirus that is being intensely studied for vaccination and as cancer therapeutic.

410. Adenovirus-Mediated NIS Expression in Xenografted Prostate Tumors Requires a Minimal Threshold of Viral Dose for Efficient Radioiodine Uptake

Miguel A. Trujillo,¹ Michael J. Oneal,² Samantha McDonough,¹ John C. Morris.¹

¹Endocrinology, Mayo Clinic Rochester, Rochester, MN;

²Molecular Medicine, Mayo Clinic Rochester, Rochester, MN.

Prostate cancer (PCa) remains the most common malignancy in men, with an estimated 217,730 new cases and 32,050 deaths in the United States in 2010. Despite new aggressive approaches, there is a high rate of recurrence. Gene therapy/virotherapy (GTV) strategies represent a rational direction for the development of novel therapeutics. However, the parameters required for effective GTV such as viral replication, spread, and gene transfer efficiency are not well validated. Clinical trials have demonstrated extremely limited tumor transduction, and this limitation remains the fundamental

barrier to effective cancer gene therapy. The efficiency issue has been historically addressed by increasing the administration dose. One conceptual approach to improve limited infectivity is to permit local vector replication after delivery. We reason however that there should be a minimum viral dose threshold required for efficient tumor transduction. To test this hypothesis we LnCaP tumor xenografts intratumorally with the conditionally replicating adenovirus Ad5PB₋RSV₋NIS CRAd in which the E1a gene is driven by the prostate specific promoter for Probasin and the cassette RSV promoter-human NIScDNA-bGH polyA replaces the E3 region (CRAd Ad5PB₋RSV₋NIS). In vivo NIS expression, as a marker for viral transduction, was measured by ⁹⁹Tc uptake and imaging. A kinetic curve of ⁹⁹Tc uptake was constructed showing quantifiable isotope uptake for up to one month post-infection. These data indicate that the Ad5PB₋RSV₋NIS CRAd induces long term expression of functional NIS in LnCaP tumors in vivo and, given the kinetics of NIS expression, suggest that Ad5PB₋RSV₋NIS replicates in vivo. The viral-dose response curve shows that a minimum dose of 10¹⁰ vp/tumor is required for quantitative radioisotope uptake. Taken together, our data indicate that, despite viral replication, a minimal injected viral dose threshold is required for efficient tumor transduction. These results also predict that CRAds mediated GTV will also require a threshold intratumoral viral dose for efficacy.

411. Cancer Specific Peptide-Tagged Ad Vectors in Systemic Therapy of Aggressive Solid Tumors

Anke Schmidt,¹ Christian Eipel,² Katharina Fürst,¹ Nadine Sommer,¹ Jens Pahnke,³ Brigitte M. Pützer.¹

¹Department of Vectorology and Experimental Gene Therapy, Biomedical Research Center, University of Rostock, Rostock, Germany; ²Institute of Experimental Surgery, University of Rostock, Rostock, Germany; ³Neurodegeneration Research Lab, Clinic of Neurology, University of Rostock, Rostock, Germany.

Significant advantage of targeted anticancer treatment consists in the possibility to restrict maximum therapeutic efficacy to the malignant cell population by reducing toxicity in healthy tissues. Using different clinical models for aggressive medullary thyroid carcinoma (MTC), we have recently identified peptide ligands that bind highly selective to tumor cells. By linking the most convincing SRESPHP peptide to an adenoviral (Ad) vector expressing the MTC-related oncogene inhibitor RETΔTK, gene transfer was specifically directed to neoplastic tissue after systemic virus administration. We show that peptide-mediated delivery of RETΔTK significantly enhanced apoptosis, resulting in a strong inhibition of orthotopic and xenograft tumor growth. Conversely, tumors treated with controls expanded their initial size without notable cell death. According to the therapeutic effect, strong virus accumulation was found exclusively in thyroid carcinomas. Strikingly, application of native tropism depleted viral vector linked to tumor-selective peptide was accompanied by a substantial reduction of Ad binding to the liver. Of note, single systemic injection of a low dose (10e8 pfu/mouse) of MTC-specific Ad.RETΔTK induced regression of multiple tumors at different sites in all treated animals. In sum, our results open up the possibility for an efficient cancer cell-specific therapy of primary MTC, their migrating populations and potentially metastases. This work was supported by DFG grants PU 188/5-1/5-2, PU 188/5-3, and the FORUN program (grant 889017) of Rostock University Medical Faculty.

412. Enhancing Therapeutic Effects of Oncolytic Agents through Switching of Mechanism of Tumor Killing

Hannah Chen,¹ Padma Sampath,¹ Wei Hou,¹ Rachel Sikorski,¹ Stephen H. Thorne.¹

¹Surgical Oncology, University of Pittsburgh, Pittsburgh.

One advantage of oncolytic viral therapies is their ability to destroy tumor cells through multiple mechanisms of action, including direct oncolysis, immune activation and vascular collapse. However, a careful balance is often required as many approaches that enhance immunotherapeutic potential of the vectors result in reduced oncolysis due to premature viral clearance from the tumor. We have therefore looked to create 'modular' vectors where the mechanism of action can be switched from predominantly oncolytic to predominantly immunotherapeutic through exogenous application of a small molecule external regulator. Modulation of gene expression from oncolytic viruses or gene therapy vectors is often desirable for the purpose of controlling therapeutic gene delivery, control of immune response, or as a means of rendering viral replication conditional, as a safety mechanism. We have focused on vaccinia virus, as a potent oncolytic agent currently demonstrating significant clinical potential. A novel strategy to regulate protein stability was applied, involving use of a small protein domain termed a destabilizing domain (DD) that can be cloned into either viral genes or transgenes. This confers instability to the protein of interest (POI) that may be reversed upon the exogenous administration of a small molecule that binds specifically to the DD. Using this strategy, we have demonstrated conditional production/destruction of various transgene products expressed from vaccinia virus, including reporter proteins, viral proteins and therapeutic molecules such as immunomodulatory cytokines both in vitro and in vivo. Enhanced anti-tumor activity can be achieved in mouse tumor models following systemic delivery of oncolytic vaccinia viruses harboring conditionally regulated cytotoxic or immunotherapeutic proteins, demonstrating the potential of this strategy to augment oncolytic virotherapy by offering reversible control of the timing and level of specific protein activity. In addition, a stabilizing domain (SD) that works through opposing regulation of the POI via binding of the same small molecule has been developed, allowing opposing regulation of multiple gene products and 'switching' of viral mechanism of action. This technology can be extended to other gene therapy applications and provides a novel and clinically relevant method for regulating the functional output of various protein targets.

413. A Novel Adenoviral Hybrid-Vector System Carrying a Plasmid Replicon for Safe and Efficient Cell and Gene Therapeutic Applications

Richard Voigtlander,¹ Martin Hausl,¹ Rudolf Haase,² Armin Baiker,¹ Anja Ehrhardt.¹

¹Virology, Max von Pettenkofer-Institute / LMU, Munich, Germany; ²Pharmacy, LMU, Munich, Germany.

In dividing cells the two aims a gene therapy should accomplish are defined as the nuclear distribution and retention of therapeutic DNA. Because monosystems fail to fulfil both tasks with equal efficiency, hybrid-vector systems are promising in facing the challenges of molecular medicine. Our hybrid-vector system HDAdV-pEPito synergizes the helper-dependent adenoviral vector (HDAdV) with the plasmid pEPito containing the therapeutic gene and a special DNA sequence called SMAR (Scaffold/Matrix Attachment Region) for episomal retention and replication. Our technique provides a tool for stable maintenance of transgenes reducing the risk of insertional mutagenesis. HDAdV-pEPito and the SMAR deleted control (HDAdV-pEPito-ΔSMAR) were generated with our laboratory's novel BAC-technology. Both vectors carry the respective linearized

plasmid flanked by FRT sites for FLP recombinase mediated excision, containing an eGFP-IRES-BSD-cassette under the control of the hCMV/EF1 promoter. FACS analysis showed that 61% of U87-MG-cells infected with MOI 200 were eGFP-positive verifying functionality of the expression cassettes. Additionally PCR analysis proved recombination of FRT sites releasing pEPito and pEPito- Δ SMAR from the linear adenoviral genomes by FLPe-recombinase expressed by co-infected vector HDAdV-FLPe. To analyse long-term persistence of excised replicons in cycling U87-MG cells a colony forming assay was performed. Therefore cells were infected either with HDAdV-pEPito and HDAdV-FLPe (group 1) or HDAdV-pEPito- Δ SMAR and HDAdV-FLPe (group 2) at MOI 10 and 100. After 5 weeks of selection for blasticidin group 1 showed an up to seven-fold increased number of colonies compared to group 2. This is the first evidence that a replicon containing the SMAR can be released from an adenoviral vector and maintained in dividing cells. In addition to further colony forming assays (MOIs 30 and 300) plasmid rescue experiments are currently performed to isolate and verify recombinated plasmids from infected cells of group 1 or 2, respectively. Therefore DNA was extracted from cells 4 days post infection and transformed into bacteria. Higher numbers of bacteria colonies for group 1 than for group 2 already indicate a more efficient establishment of persistent replicons in the HDAdV-pEPito group. For in vivo evaluation C57BL/6-mice have been co-infected with vectors of group 1 or group 2, respectively. During the first 3 months post infection all animals were treated three times with the liver toxin carbontetrachloride to induce cell cycling and therefore to test mitotic stability of recombinated pEPito in proliferating tissue. 4 months post infection mice will be sacrificed and liver tissue samples will be analysed on protein level for eGFP expression and on DNA level for the amount of recombinated products. In conclusion we demonstrated efficacy of our novel adenoviral hybrid-vector system with its unique mechanism of retention independent of any viral protein in vitro. Even in vivo applications remain to be evaluated this system represents an attractive alternative for safe long term expression in respect of cell and gene therapeutic approaches.

414. Chimeric Serotype 5/6 Helper-Dependent Ad Vector Improves Therapeutic Index for Liver-Directed Gene Therapy

Francesco Vetrini,¹ Reeti Khare,² Nathan C. Grove,¹ Donna J. Palmer,¹ Amanda Rosewell,¹ Michael A. Barry,^{2,3} Philip Ng.¹
¹Molecular and Human Genetics, Baylor College of Medicine, Houston, TX; ²Immunology, Department of Molecular Medicine, Mayo Clinic, Rochester, MN; ³Translational Immunovirology and Biodefense Program, Division of Infectious Diseases, Mayo Clinic, Rochester, MN.

Serotype 5 helper-dependent adenoviral vectors (HDAd5) are effective for liver-directed gene therapy because they can mediate long-term transgene expression in the absence of chronic toxicity. However, high and thus potentially toxic doses are required to achieve efficient hepatocyte transduction due, in part, to vector uptake by Kupffer cells. Therefore, novel strategies to achieve efficient hepatocyte transduction with lower vector doses are desirable. Previous studies have shown that the hypervariable region (HVR) of the capsid hexon protein plays a major role in hepatocyte transduction. In this study, the native HVR of HDAd5 was replaced with the HVR from Ad serotype 6. This chimeric HDAd5/6 yielded a 2 to 3-fold increase in liver-specific transgene (hFIX) expression compared to HDAd5 which was sustained for at least 3 weeks.

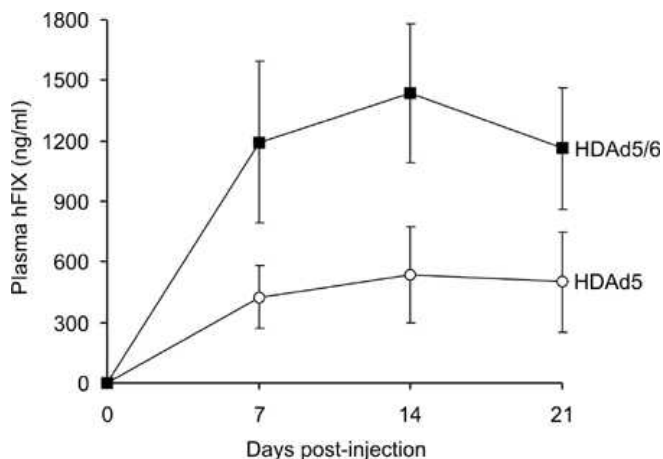

No significant differences were observed in serum AST, ALT, IL-6 and IL-12 in mice injected with either vector. However, HDAd5/6 appears to result in reduced serum LDH elevation compared to HDAd5, perhaps consistent with evasion of Kupffer cells. These results indicate that the therapeutic index of HDAd5 may be improved by incorporating the Ad6 HVR.

415. A Novel Protein Transduction Domain with Improved Secretion and Transduction Activity

Ying Shen,¹ William Yu,¹ Poonam Nagpal,¹ John G. Hay,^{1,2} Harald Sauthoff.^{1,2}
¹NYU School of Medicine, New York, NY; ²VA New York Harbor Healthcare System, New York, NY.

Cell penetrating peptides (CPPs) are widely used to deliver proteins and other macromolecules into cells. Generally, CPPs are either synthesized and coupled to the therapeutic payload or expressed in bacteria as fusion proteins followed by various purification steps. However, despite great interest in this technology, difficulties with production, purification and unfavorable pharmacokinetics are still limiting its clinical success. As an alternative approach, expression of CPPs that support intercellular transfer of fused proteins could avoid production and purification needs and serve as a tool to deliver therapeutic proteins. We have previously reported that the basic domain of HIV Tat, fused to fluorescent proteins can support intercellular transfer, but only when coupled to a secretory signal peptide (SP). However, SP-Tat fusion proteins are very inefficiently secreted and transduction seems mostly mediated by fusion proteins released by means other than secretion through the classic pathway. We also demonstrated that a modified Tat-based CPP (Tatm) is secreted much more efficiently, but its transduction activity was greatly reduced compared to Tat. We now show that an elongated 3x repeat sequence of Tatm (Tatm3x) enhances transduction activity. Secretion activity is greatly improved compared to Tat, although somewhat reduced when compared to Tatm. Expressed SP-Tatm3x fusion proteins are localized in the ER and cytoplasm and are secreted mainly via the classical pathway. Fusion proteins that are released through cell lysis have greatly improved transduction activity compared to SP-Tatm. Based on co-culture and mixing experiments, expressed SP-Tatm3x supports intercellular transport of fused fluorescent proteins *in vitro*. As previously shown for SP-Tatm fusion proteins, travel through the secretory pathway also reduces transduction activity of SP-Tatm3x fusion proteins. In conclusion, expressed SP-Tatm3x displays improved secretion and transduction activity and represents an important step forward in the development of a CPP that supports intercellular transport of fused proteins.

416. Traceless Bioresponsive Coating of Adenovirus Vectors

Jan-Michael Prill,¹ Vladimir Subr,² Tatjana Engler,¹ Karel Ulbrich,² Stefan Kochanek,¹ Florian Kreppel.¹

¹Dept. of Gene Therapy, University Clinic, Ulm, Germany; ²Dept. of Biomedical Polymers, Institute of Macromolecular Chemistry, v.v.i., Academy of Sciences, Prague, Czech Republic.

Efficacy of adenovirus vectors upon systemic delivery is significantly limited by a multitude of barriers imposed by interactions of the vector particles with cellular and non-cellular blood components. It is generally agreed upon that polymer coating is the most potent technology to overcome these barriers. However, the currently available coating technologies rely on irreversible chemical capsid modifications and it has been shown that this irreversibility can affect intracellular vector trafficking and limit nuclear delivery. While few approaches address this problem by introducing bioresponsive elements in the coating polymer, it has so far not been possible to generate polymer coats that are completely removed from the vector capsid in a bioresponsive manner after cell entry. Here we demonstrate for the first time that traceless bioresponsive polymer coating of adenovirus vectors is feasible by using “tailor-made” hydrophilic polymers. We present two types of novel poly[N-(2-hydroxypropyl) methacrylamide] (pHPMA)-based bioresponsive copolymers with and without additional positive charges and provide detailed *in vitro* and *in vivo* characterization of their advantages. We specifically modified hexon with the multivalent, thiol-reactive pHPMA derivatives bearing either dithiopyridyl groups (for bioresponsive, intracellularly removable coating) or maleimide-groups (for irreversible coating). Efficiency and responsiveness of coating were proven by Western-Transfer and coated particles were analyzed by photon correlation spectroscopy. Life cell imaging with fluorescently labelled and polymer-coated vector particles revealed equal cellular entry efficiency independent of the bioresponsiveness of the coating polymer. Once inside the cell, however, non-bioresponsively coated vectors displayed a significant impairment in nuclear trafficking and reduced transduction efficiency compared to uncoated particles. In contrast, bioresponsively coated vectors exhibited only a slight delay in nuclear trafficking and allowed for efficient transduction. To analyze the effects of coating on vector particle interactions with non-cellular blood components we performed antibody-based neutralization assays and blood coagulation factor X binding assays. Our data demonstrate that the positively-charged bioresponsive polymer was able to protect the vector from neutralizing antibodies whereas the uncharged derivative protected it only poorly. Shielding from FX-binding was complete for all derivatives and independent of charge. Finally we analyzed the *in vivo* biodistribution of the differently coated EGFP-expressing vector particles after systemic intravenous delivery in Balb/C mice by histological and qPCR analysis of spleen, liver, lung and kidney. Remarkably, the coated particles exhibited an almost complete detargeting from hepatocytes and spleen, the major sites of adenovirus vector sequestration. Overall our data demonstrate that traceless bioresponsive polymer coating is a significant improvement towards efficacious and safe adenovirus vectors. Support by MSMT grant No. 1M0505 is gratefully acknowledged.

417. Scalable Production and Purification Process of Helper-Dependent Adenoviral Vectors Using a Recombinase-Free System

Dan Cots,¹ Meritxell Puig,¹ Maria Mercedes Segura,¹ Assumpció Bosch,¹ Miguel Chillón.^{1,2}

¹Departament de Bioquímica i Biologia Molecular, Universitat Autònoma de Barcelona, Centre de Biotecnologia Animal i Teràpia Gènica, Bellaterra, Catalunya, Spain; ²Institució Catalana de Recerca i Estudis Avançats, ICREA, Barcelona, Catalunya, Spain.

Helper-dependent adenoviral vectors (HD-Ad) are devoid of all viral coding sequences and retain only minimal viral cis-acting sequences required for vector propagation. The Cre/loxP system is the most widely used method for producing HD-Ads. However, this method does not routinely reduce helper adenovirus contamination below 1%. Usually, to address this issue and reach contamination levels below 0.5-0.1% scientists use HDV and HV of different genomic sizes to allow density separation by centrifugation. However, this purification system greatly hinders scalability. In our laboratory, we have cloned attB/attP- ϕ C31 sequences flanking the packaging signal of human adenovirus (Ad5) vectors. From the initial steps of virus amplification, low yields of helper-Ad are observed, surprisingly even in ϕ C31-deficient cell lines, indicating that the mechanisms causing this delay were not related to the presence of the recombinase, but to the delayed packaging of helper-Ad. To test the potential of the attB-strategy to amplify helper-dependent adenoviral vectors at large-scale, we used suspension cultures in serum-free media, followed by purification of the crude lysate by tangential ultrafiltration and AEX chromatography. We report here, that the use of the attB-system together with scalable purification methods allows high titers of high quality helper-dependent vectors, as well as low adenovirus helper contamination (0.5-0.01%) paving the implementation of the GMP procedures needed for the use of helper-dependent vectors in clinical trials.

418. Carrier Cells Infected with IAI.3B Promoter-Driven Oncolytic Adenovirus Overcome Immunogenicity and Induce Complete Tumor Reduction in Oral Squamous Carcinoma Cells

Katsuyuki Hamada,¹ Ting Zhang,² Koh-ichi Nakashiro,² Hiroyuki Hamakawa.²

¹Obstetrics and Gynecology, Ehime University School of Medicine, Toon, Ehime, Japan; ²Oral and Maxillofacial Surgery, Ehime University School of Medicine, Toon, Ehime, Japan.

Replication-competent oncolytic viral vectors have been developed to improve antitumor activity but generation of high titers of neutralizing antibodies inhibits repetitive viral infection. Many studies of oncolytic virus-infected carrier cells have been reported to overcome this viral induced immunogenicity. *IAI.3B* promoter is highly activated in ovarian carcinoma and *IAI.3B* promoter-driven oncolytic adenovirus AdE3-*IAI.3B* kills specifically ovarian carcinoma. However, *IAI.3B* promoter and AdE3-*IAI.3B*-infected carrier cells have not yet been studied in human oral squamous cell carcinoma cells. In the present study, we examined the promoter activity of *IAI.3B*, the antitumor activity of AdE3-*IAI.3B* and the antitumor activity of carrier cells infected with AdE3-*IAI.3B* in human oral squamous cell carcinoma cells. *IAI.3B* promoter activity and the growth inhibitory effect (IC50) of AdE3-*IAI.3B* were determined respectively by dual luciferase assay and crystal violet assay in human oral squamous cell carcinoma cells (HSC-2, HSC-3, HSC-4, Ca9-22, GFP-SAS). A549 carrier cells infected with AdE3-*IAI.3B* was intratumorally injected for consecutive 6 days into GFP-SAS cell tumors in nude mice. Carrier cells infected with AdE3-*IAI.3B* and adenovirus-*mGM-CSF* was intratumorally injected for consecutive

3 days into murine squamous cell carcinoma SCC7 cell tumors in syngeneic C3H mice after immunization of adenovirus. *IAI.3B* promoter was highly activated in oral squamous cell carcinoma cells as well as in ovarian carcinoma cells but did not in normal cells. AdE3-*IAI.3B* killed oral squamous cell carcinoma cells as well as ovarian carcinoma cells *in vitro* but did not normal cells. AdE3-*IAI.3B*-infected A549 carrier cells eradicated oral squamous cell carcinoma cell GFP-SAS tumors in nude mice. The anti-adenovirus neutralizing antibodies completely blocked the anti-tumor effect of AdE3-*IAI.3B* but did not that of carrier cells. After the induction of antiadenoviral CTL responses by immunization of adenovirus, administration of carrier cells induced complete tumor regression of SCC7 tumors. Adenovirus-*GM-CSF* augmented the antitumor effect of carrier cells. The *IAI.3B*-driven oncolytic adenovirus-infected carrier cell system might prove useful in cancer therapy for oral squamous cell carcinoma cells and clinical trials should be conducted in the near future.

419. Characterization of Poly(I) as a Tool To Improve Liver Transduction by HDAd Vectors

Francesco Vetrini,¹ Nathan Grove,¹ Donna Palmer,¹ Philip Ng,¹ Nicola Brunetti-Pierri.^{2,3}

¹*Molecular and Human Genetics, Baylor College of Medicine, Houston, TX;* ²*Telethon Institute of Genetics and Medicine, Naples, Italy;* ³*Pediatrics, Federico II University of Naples, Naples, Italy.*

Helper-dependent adenoviral (HDAd) vectors have great potential for liver-directed gene therapy resulting in long-term transgene expression without chronic toxicity. However, high vector doses are required for an efficient hepatocyte transduction due to vector sequestration by Kupffer cells in the liver which can activate an innate inflammatory response. Pretreatment of mice with polyanionic compounds can increase hepatocyte transduction due to inhibition of Scavenger Receptor type A (SRA)-mediated vector uptake by Kupffer cells. We found that 0.05 mg polyinosine [Poly(I)] given 5 min before HDAd administration is the minimal effective dose/time required to increase hepatocyte transduction in mice. Poly(I) does not change splenic HDAd uptake and reduces the rate of hepatic HDAd genome loss. LDH increase is reduced with Poly(I) suggesting decreased Kupffer cell killing by HDAd. Although Poly(I) is toxic in combination with high HDAd doses, an HDAd dose of 5E11 vp/Kg with 0.05 mg Poly(I) yielded a 4-fold increase in liver transgene expression with no increase in AST/ALT and IL-6 as compared to Poly(I) untreated animals. However, hepatocyte transduction by HDAd in SRA^{-/-} mice is not increased and poly(I)-dependent increase in liver transduction in SRA^{-/-} mice was observed suggesting that Poly(I) is directed towards other Scavenger Receptors (SRs) besides SRA. Analyses of the mRNA levels of different SRs in SRA^{-/-} mouse livers revealed that CD36, CD68, LOX1, and SCARB-1/2 are increased, suggesting that other SRs besides SRA are potentially involved in the observed poly(I) effect.

420. Transient Immunosuppression with CsA in Adenovirus-Sensitized Cirrhotic Rats Increases Survival and Reduces Inflammation Maintaining Adenovector Biodistribution and Transgene Effectiveness

Ana Sandoval-Rodriguez,¹ Mayra Mena-Enriquez,¹ Jesus Garcia-Bañuelos,¹ Adriana Salazar-Montes,¹ Juan Armendariz-Borunda.^{1,2}
¹*Molecular Biology and Gene Therapy Institute, University of Guadalajara, Guadalajara, Mexico;* ²*Hospital Civil "Juan I. Menchaca", Guadalajara, Mexico.*

Introduction: Humans have been exposed to wild-type Adenovirus (Ad) infection by natural causes, developing a preimmunization status with neutralizing antibodies and T-cell immune responses. When Ad are used as gene therapy vectors, these factors could

reduce significantly adenovector-transduction and transgene expression, in particular in patients with liver disease. **Objective:** Evaluate biodistribution of adenovector and transgene expression in adenovirus-sensitized cirrhotic rats submitted to a transient immunosuppression with cyclosporine A (CsA). **Material and Methods:** Cirrhosis was induced with CCl₄ for 8 weeks. A group of cirrhotic rats was sensitized to Ad by a systemic administration of 3x10¹¹ vp/rat of Ad-ΔhuPA at the 5th week of the CCl₄ regimen. A second dose of Ad-hDuPA (3 x10¹¹ vp/rat) was administered by iliac vein in Ad-sensitized and Ad-naïve groups at the eighth week of CCl₄ intoxication. A sub-group of cirrhotic ad-sensitized animals was submitted to transient immunosuppression with 40 mg/kg of CsA, 24 hours before, simultaneously and 24 hours after second Ad-hDuPA administration. Animals were sacrificed 2 and 72 hours after second Ad administration. Liver and main organs were analyzed for transduction (real time PCR) and transgene expression (ELISA). Liver fibrosis and inflammation was analyzed in histologic samples. **Results:** Treatment with Ad-hDuPA reduces fibrosis in all cirrhotic groups; from a 72% reduction in Ad-naïve cirrhotic animals to a 50% in Ad-sensitized cirrhotic and Ad-sensitized cirrhotic + CsA group compared to cirrhotic controls (p<0.01). Histologic liver inflammation was reduced in ad-sensitized or ad-naïve cirrhotic animals treated with CsA compared to controls (p<0.05). Survival rate increased from 22 to 41 days in Ad-sensitized cirrhotic group treated with CsA (p<0.05). 2 hours after Ad-hDuPA administration adenovirus genome was detected in liver, spleen and lung. In the liver, viral particles had 10 times higher values 2 hours (200,000-300,000 vp/mg DNA) than 72 hours (22,000 vp/mg) post-adenovirus administration. At 72 hours, Ad-huPA genomes were localized in spleen and liver. Ad-huPA biodistribution was not affected by immunosuppression. At 72 hours, huPA protein was detected in liver, spleen and kidney. Cirrhotic Ad-naïve animals showed significantly higher huPA hepatic expression than their Ad-sensitized counterparts (4.5 ng/mg vs 150 pg/mg of protein). Transient immunosuppression seems to change uPA expression making spleen expression predominant over liver expression. At the same time, Ad-sensitized rats showed Ad-ΔhuPA expression and genomes in a greater number of organs. **Conclusion:** Transient immunosuppression seems to improve inflammation cell infiltrate and survival in ad-sensitized cirrhotic rats and did not change quantitatively or qualitatively adenovector biodistribution or transgene expression.

421. Oncolytic Adenovirus Regulated by Modified AFP Promoter Induces Hepatocellular Carcinoma-Specific and Hypoxia-Independent Cell Killing

Minjung Kim,¹ Oh-Joon Kwon,¹ Il-Kyu Choi,² Ji Young Yoo,¹ Soung-Kyung Lee,¹ Chae-Ok Yun.^{1,2}

¹*Brain Korea 21 Project for Medical Science, Institute for Cancer Research, Severance Biomedical Science Institute, Seoul, Republic of Korea;* ²*KOSEF through National Core Research Center for Nanomedical Technology, Yonsei Univ, Seoul, Republic of Korea.*

Hepatocellular carcinoma (HCC) is one of the most common malignancies worldwide, especially in several areas of Asia and Africa. Despite recent advances in cancer treatment modalities, the efficacy of treatments for advanced stages of HCC is far from satisfactory. Therefore, development of new technology to hold efficiency and safety is required for the cure of HCC. The alpha-fetoprotein (AFP) is highly expressed in the fetal liver but transcriptionally silent in normal adult hepatocytes. However, more than 70% of HCC demonstrate reactivation of this oncofetal protein. Therefore, AFP may be used as a target for hepatoma-selective gene therapy. Tumor development requires oxygen and nutrients, which are supplied through angiogenesis. Higher levels of VEGF expression have been found in HCC, which is generally considered to be a hypervascular

tumor, than in corresponding non-tumor tissues. Oncolytic adenovirus (Ad) can replicate selectively in cancer cells and then kill not only primary infected cells but also adjacent tumor cells. But, development of effective alternative approaches with increased gene expression just in cancer cells and reduced systemic toxicity to normal cells is needed for the use in clinics. In this study, we generated oncolytic Ads regulated by modified AFP promoters directly linked to 6 copies of HRE and evaluated the hepatoma-specific cell killing effects *in vitro* and *in vivo*. Modified AFP promoter-regulated oncolytic Ad overcome the inhibition of viral production in hypoxic condition and showed efficient cytopathic effect in HCC-specific manner. In conclusion, oncolytic Ad under the control of modified AFP promoter may be an alternative therapeutic modality for the treatment of HCC, surmounting the resistance to the conventional therapy caused by hypoxic condition in tumor.

DNA Vectorology & Gene Targeting - I

422. Targeted Gene Integration into a Mouse Safe Harbor Locus Directed by Engineered Zinc Finger Nucleases

Pablo Perez-Pinera,¹ David G. Ousterout,¹ Matthew T. Brown,¹ David Yudovich,¹ Charles A. Gersbach.¹

¹Biomedical Engineering, Duke University, Durham, NC.

Targeted gene addition to chromosomal “safe harbor” sites is being pursued as a potentially safer method of gene therapy that avoids aberrant effects of random gene integration, such as insertional mutagenesis. Gene targeting into the ROSA26 locus by homologous recombination has emerged as a preferred method for mouse transgenesis as this site provides improved targeting efficiency and ubiquitous transgene expression. Furthermore, gene addition to this locus does not have any adverse consequences on mouse viability or cell phenotype. Therefore ROSA26 is an ideal candidate for preclinical gene therapy studies focused on gene targeting to a chromosomal safe harbor locus. However, gene targeting by homologous recombination is not a very efficient process in adult cells as only ~1 in 10⁶ cells provided with excess template sequences undergo the desired gene modification. However, when a targeted genomic double-strand break (DSB) is introduced in cells, homologous recombination (HR) at that local site is induced to repair the DSB at significantly higher levels than spontaneous, random vector integration. Synthetic custom-designed zinc finger nucleases (ZFNs) combine the recognition specificities of DNA-binding zinc finger proteins with the non-specific catalytic domain of the FokI restriction endonuclease to create a DSB at any sequence in the genome. Using a modular assembly approach, we built a ZFN pair that binds to a target sequence in the ROSA26 locus with high affinity and specificity as measured by a fluorescence anisotropy-based DNA-binding assay. We demonstrated that when transiently expressed in a variety of cell types, this ZFN pair efficiently induces a DSB in the ROSA26 locus in a time- and dose-dependent manner as demonstrated by the presence of insertions and deletions detected using the Cel-I nuclease assay and DNA sequencing. We also constructed a donor vector that contained sequences ranging from 50 bp to ~3 kb flanked by two 800 bp homology arms. When delivered alone, we observed that this donor vector integrated randomly into different genomic loci, however, when delivered in conjunction with the ZFN pair targeting the ROSA26 locus, we detected targeted integration events at the desired target site. Given the increasing interest in targeted delivery of therapeutic expression cassettes to safe harbor sites for gene therapy, creation of transgenic animals, and cell line engineering, we expect there will be several promising applications for these zinc finger nucleases.

423. Correction of Adenosine Deaminase Deficiency Using Zinc Finger Nucleases

Alok V. Joglekar,¹ Gabriela Kufnec,¹ Jason Sims,¹ Andreas Reik,² Colin Flinders,² Michael C. Holmes,² Philip D. Gregory,² Roger P. Hollis,¹ Donald B. Kohn.¹

¹Microbiology, Immunology and Molecular Genetics, University of California, Los Angeles, Los Angeles, CA; ²Sangamo BioSciences, Richmond, CA.

Adenosine deaminase (ADA) is a housekeeping enzyme involved in the purine metabolism pathway. The absence of ADA activity leads to profound lymphopenia and consequently severe combined immunodeficiency (SCID). ADA-SCID patients have been treated successfully with gene therapy using retroviral vectors; however there is always a potential for insertional oncogenesis. As an alternative strategy, Zinc Finger Nucleases (ZFNs) can be used to stimulate targeted homologous recombination-mediated genome repair at the ADA locus. ZFNs specific for human ADA (hADA) were developed and their ability to stimulate gene correction via homology directed repair was assessed. We have developed ZFNs that specifically target regions in exon 1 and intron 6 of the hADA gene. As a measure of ZFN activity we use a Cel-1 digestion based assay that can quantify error prone repair of alleles at specific regions. Encouragingly, the ZFNs were found to disrupt 20-25% alleles in K562 cells and 15-20% in human umbilical cord blood CD34+ hematopoietic stem/progenitor cells upon transient transfection. For homology mediated gene repair, we have designed donor constructs to act as homologous recombination templates. One donor carries the entire hADA cDNA flanked by homology arms and is used to the target exon 1 (gene insertion strategy), another donor contains a segment of the hADA gene around the intron 6 target site (gene correction strategy). At the exon 1 target site we have PCR-based evidence for successful insertion of a 1.8kb hADA expression cassette as well as a 2.6kb eGFP expression cassette in K562 cells. We report up to 2% gene insertion of the eGFP expression cassette using a non-integrating lentiviral vector for delivering the donor template. At intron 6, we have shown gene correction frequencies up to 5% in K562 cells when a 1.4kb donor molecule was used. Our work demonstrates that the ZFN technology can be used to achieve correction of the human ADA gene.

424. An Insight into the Chromatin-Based Mechanism of In Vivo Silencing of Foreign DNA

Lia E. Gracey,¹ Zhi-Ying Chen,² Neil Phillips,² Jay M. Maniar,¹ Andrew Z. Fire,^{1,3} Mark A. Kay.^{1,2}

¹Genetics, Stanford University School of Medicine, Stanford, CA;

²Pediatrics, Stanford University School of Medicine, Stanford, CA;

³Pathology, Stanford University School of Medicine, Stanford, CA.

It has consistently been observed that exogenous transgenes in bacterial plasmid-based vectors are efficiently silenced within the first several weeks after hydrodynamic injection in mice, even though the DNA is still present in the nucleus of the hepatocytes. However, a minicircle, derived from the parental plasmid with a minimal expression cassette but lacking any bacterial backbone, still abundantly expresses the transgene. We have hypothesized that the chromatin structure that these two constructs adopt may be influencing the differential expression patterns. In this system, we have used an RSV promoter driving a human alpha-1antitrypsin (hAAT) transgene with a bovine poly-A signal. Using our novel nucleosome DNA hybridization method, we have studied nucleosome positioning throughout the DNA elements of vector DNA in murine liver. We have determined that the nucleosome positioning around key elements of the promoter (such as the transcription start site, TSS) was very similar in the expressed minicircle and the silenced plasmid, with a prominent nucleosome covering the annotated TSS (Figure 1, b and e).

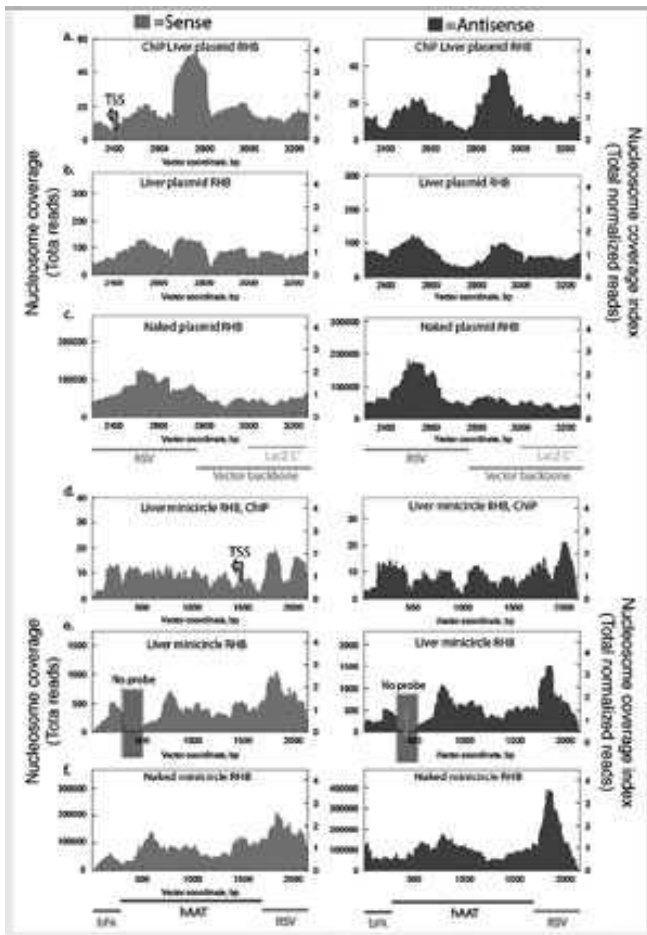

A control experiment with a minimal digest of naked DNA showed a pattern which indicates that DNA sequence alone can influence the *in vivo* chromatin structure, but does not solely account for the observed pattern (Figure 1, c and f). As an alternate hypothesis, we are currently doing chromatin immunoprecipitation followed by high-throughput Illumina/GAII sequencing (ChIP-Seq) to look at histone modifications present on the constructs. Previous work showed that the minicircle has an overall abundance of active histone marks (e.g., histone 3 lysine 4 trimethylation, H3K4me3) and the silenced plasmid has an abundance of histone marks for inactive expression (Riu, et al., 2007, Mol Ther). However, this work was at low resolution and it was not possible to decipher which histone modifications were on a single nucleosome. Our new approach allows the examination of a histone mark at single-nucleosome resolution. Importantly, our preliminary data shows an abundance of the activating H3K4me3 mark at nucleosomes around the TSS in both the plasmid and minicircle at late post-injection timepoints (Figure 1, a and d). Based on these results, we believe that there are distinct populations of constructs that are actively being transcribed while other populations are silenced. Further ChIP-Seq experiments and controls are being actively pursued to study the chromatin structure of the minicircle and plasmid with differential expression profiles. Elucidating the chromatin structure of vector DNA in tissues may provide insights into making more robust expression cassettes for gene therapy applications.

425. Meganucleases for Gene Therapy

Julianne Smith,¹ Cécile Schiffer-Mannioui,¹ Laurent Poirot,¹ Roman Galetto,¹ Agnès Gouble,¹ Carole Desseaux,¹ Frédéric Paques.²

¹Collectis Therapeutics, Romainville, France; ²Collectis, Romainville, France.

Targeted approaches have emerged today as an alternative to current random insertion strategies for gene therapy. Such approaches include the precise repair of a deleterious mutation at its endogenous locus as well as the insertion of a functional coding sequence at a chosen locus. These strategies require the use of specific endonucleases that can induce high frequencies of homologous gene targeting in the vicinity of their cleavage site. Natural meganucleases, also called Homing Endonucleases, are the most specific endonucleases in nature, and thus provide ideal scaffolds for the creation of new genome engineering tools. We have developed a two-step combinatorial method to entirely redesign the DNA-binding interface of the I-CreI LAGLIDADG meganuclease to create a large number of endonucleases cleaving human genes. Indeed, we have been able to show that natural meganucleases as well as engineered derivatives can be used to induce up to 20% of gene insertion into chosen sequences in immortalized cell lines. Therapeutic applications are among the most challenging ones and their effective use will depend on several important criteria. Intrinsic properties of meganucleases, such as a favourable activity/specificity ratio, as well as the use of appropriate vectorization methods are essential in order to optimize the efficacy of targeted recombination. In addition, epigenetic modifications of the DNA target can strongly impact meganuclease induced recombination, and thus the choice of the target sequence is an equally important property of the meganuclease. We will present data concerning our strategy for the development of therapeutic meganucleases including the selection and screening of potential candidates, the development of appropriate methods of vectorization and the use of meganucleases for the engineering of primary cells.

426. Characterization of Dynamic Change in the Distribution of the Integration Sites of the Sleeping Beauty Transposon

Nataly A. Kacherovsky,¹ C. Anthony Blau,² Cecilia M. Giachelli,¹ Suzie H. Pun.¹

¹Bioengineering, University of Washington, Seattle, WA;

²Institute for Stem Cell and Regenerative Medicine, University of Washington, Seattle, WA.

In cell therapy, *ex vivo* gene transfer is important for generating engineered cells that produce therapeutic proteins. We previously introduced an efficient non-viral gene transfer approach combining the Sleeping Beauty Transposon System with selective amplification of engineered cells triggered by chemically induced growth factor receptor dimerization. The transposon cassette in this method contains a GFP reporter gene, an internal ribosome entry site, and the gene encoding a chimeric receptor consisting of a modified FK506-binding protein domain, F36V, fused with the cytoplasmic domain of a fibroblast growth factor receptor (FGFR1), flanked by inverted repeats. The F36V domain contains a binding site for a bivalent synthetic ligand, AP20187. Addition of AP20187 results in F36VFGFR1 dimerization and activation of the FGFR proliferation pathway, causing selective amplification of transfected cells. Using the Ba/F3 cell line, we acquired highly pure (99% GFP positive) populations of engineered cells after only one week of AP20187-dependent growth. We used linear amplification-mediated PCR to analyze the integration site profile of stably transfected cells before and after AP20187 selection. Integration sites that were originally randomly distributed showed remarkable convergence to a few sites after applied selection.

427. Passive Topical Administration of Nucleic Acids to Targeted Skin Cells Via Sub-50 Nanometer Capsules

Gretchen M. Unger,¹ Martha Fuentes de Albin,² Roger L. Kaspar,³ Betsy T. Kren,² Diane K. Tobolt,¹ Michael P. Murtaugh.²

¹GeneSegues, Inc., Chaska, MN; ²University of Minnesota, Minneapolis, MN; ³TransDerm, Inc., Santa Cruz, CA.

Passive topical administration of nucleic acid drugs and vaccines is a desirable goal for patient-friendly manipulation of target cells in the skin. However, two major delivery challenges that have impeded topical nucleic acid development are 1) penetrating the stratum corneum, and 2) avoiding endosomal entrapment and degradation. GeneSegues has developed a novel non-viral drug delivery technology, sub-50 nanometer (s50) crystallized capsules, for intact delivery of nucleic acids to intracellular sites in target cells. s50 capsules are directed to specific tissue and cells by formulating appropriate targeting proteins, peptides or antibody ligands as the crystallized capsule shell. The novel size and structure of s50 capsules allows for efficient penetration of the stratum corneum and, by co-opting the non-endosomal pathway referred to as lipid rafts, intact delivery of nucleic acid cargo to the nucleus and cytoplasm of the target cell. Here we show in pilot studies using pig dermis organ culture as an established and relevant model for human skin, transcutaneous passage of plasmid-bearing s50 capsules with cell-specific targeting. In these studies, we compared fibronectin, hyaluronan and tenascin as shell targeting components. We then extended these studies of passive cutaneous delivery, using plasmid-bearing, fibronectin-coated s50 capsules, to in vivo timecourse studies in murine paws where stratum corneum layers in footpads are approximately 50 μ m thick, demonstrating uniform transfection of underlying basal keratinocytes. In a further extension, using hyaluronan-coated s50 capsules together with a novel adjuvant, we demonstrate a functional response to model antigen in studies of passive topical DNA vaccine administration in weanling pigs. Skin is a powerful immune organ, not conveniently addressed by current methods of vaccine administration, e.g., injection, gene gun, or electroporation. We found improvement in mucosal and cell-mediated immune responses, relative to intradermal protein antigen injection that was biased towards distal and draining nodal lymphocytes, demonstrating a functional response in a clinically relevant model to topical administration of nucleic acids using s50 capsules. We expect that with further characterization, these studies may provide a solid framework for further development of s50-mediated cutaneous delivery of nucleic acid drugs and vaccines. Grant acknowledgments: NIH R43 CA119556, R43 AI60268

428. Sensitive Methods To Detect Mutations Induced by Meganucleases

Jacques P. Tremblay,¹ Joël Rousseau,¹ Pierre Chapdelaine,¹ Sébastien Boivert,¹ Luciana Almeida,¹ Jacques Corbeil,¹ Alexandre Montpetit,² Frédéric Pâques.³

¹Médecine Moléculaire, Université Laval, Québec, QC, Canada;

²Genome Quebec Innovation Center, McGill University, Montréal, QC, Canada; ³Collectis Genome Surgery, Collectis S.A, Romainville, France.

Several hereditary diseases are due either to a nonsense codon or to a frame shift mutation. Meganucleases (MGNs) are enzymes, which can be engineered to induce double strand break at a specific DNA sequence. These breaks are repaired by Homologous Recombination (HR) or by Non Homologous End Joining (NHEJ), which results in insertions or deletions (indels) of a few base pairs. We have tested three methods to detect, characterize and quantify the frequency of the indels produced by various MGNs targeting the Rag1 (Recombination activating gene 1) or the dystrophin gene. The Surveyor enzyme method was not very sensitive and permitted at best to determine

whether abundant indels had been produced. For the other two methods, the DNA region targeted by the MGN was amplified by PCR. For one of them, the subtractive colony hybridization, the amplicons were cloned in the pDrive plasmid and bacteria colonies were grown. The colonies still containing the non-mutated sequences were detected by hybridization with a radioactive oligonucleotide complementary to the wild type sequence. Only the non-radioactive colonies were sequenced to identify indels. For the third method, called deep sequencing, the PCR primers include the adapters for Illumina deep sequencing, a multiplexing marker and a sequence to amplify the target gene. Roughly 15,000 to 65,000 amplicons were sequenced on the Illumina platform for each experimental condition. Indels of a variable number of base pairs were obtained. Some of these indels changed the reading frame by 1 or 2 bp while other did not. Different MGNs produced micro-deletions with different size distributions. These experiments are thus a proof of principle that MGNs, adequately engineered to target appropriate exon sequences should be able to: 1) restore the normal reading of a gene with a frame shift mutation by inducing indels with the appropriate number of bp; 2) delete a non-sense codon while maintaining the normal reading frame by inducing micro-deletions, which are multiple of 3 bp and 3) knockout a gene by inducing indels, which are not a multiple of 3 bp.

429. Combining Linear Expression Cassette Technology with Novel Electroporation Techniques To Deliver Influenza DNA Vaccines

Xuefei Shen,¹ Feng Lin,¹ Gary Kobinger,² Elizabeth E. Murray,² Kate E. Broderick,¹ Niranjana Y. Sardesai.¹

¹Research and Development, Inovio Pharmaceuticals, San Diego, CA; ²Special Pathogens, National Microbiology Laboratory, Public Health Agency of Canada, Winnipeg, MB, Canada.

Alternative DNA vaccine constructs such as fully synthetic linear expressing cassettes (LEC) offer the advantage of accelerated manufacturing techniques as well as the lack of both antibiotic resistance genes and bacterial contaminants. The accelerated speed of LEC manufacture makes this technology a possible future vaccination strategy for pandemic influenza outbreaks. To assess immunogenicity and efficacy of EP-enhanced LEC delivery in mice, we designed and tested two antigenic influenza proteins. DNA to vaccinate mice was produced traditional DNA plasmid form or as LEC's to express both influenza antigens. Both forms of DNA vaccines were delivered using the newly developed minimally-invasive electroporation (EP) device (MID-II). Previously, we reported on this novel concept of DNA delivery to dermal tissue by MID-II powered using low voltage parameters. In addition to enhancing the delivery of traditional plasmid DNA vaccines, this device may also offer a safe, tolerable and efficient method to administer LEC's. Strong CTL and antibody responses were induced by the LEC versions of the DNA vaccine. When challenged with A/Canada/AB/RV1532/2009 viruses, mice immunized with LEC encoding the M2 and NP antigens recovered significantly faster than naïve or mice immunized ID without EP. Mice immunized with either plasmid DNA or an equal-molar doses of LEC encoding the M2 and NP antigens showed up to 100% survival following a lethal (100 x LD50) challenge of the heterologous and highly pathogenic H5N1 influenza virus (A/Vietnam/1203/04). These results supports the further development of genetic vaccines based on the combination of LEC and MID-II delivery technologies.

430. Mechanisms of Enhanced Gene Expression by Gene Transfer Using Ultrasound-Responsive and Mannose-Modified Gene Carriers

Keita Un,^{1,2} Shigeru Kawakami,¹ Mitsuru Yoshida,¹ Ryo Suzuki,³ Kazuo Maruyama,³ Fumiyoshi Yamashita,¹ Mitsuru Hashida.^{1,4}
¹Graduate School of Pharmaceutical Sciences, Kyoto University, Kyoto, Japan; ²The Japan Society for the Promotion of Science (JSPS), Tokyo, Japan; ³School of Pharmaceutical Sciences, Teikyo University, Kanagawa, Japan; ⁴Institute for Integrated Cell-Material Sciences (iCeMS), Kyoto University, Kyoto, Japan.

Development of a gene delivery system to transfer the gene of interest selectively and efficiently into the targeted cells is essential for obtaining the potent therapeutic effects by gene therapy. The gene transfection method using microbubbles and ultrasound (US) exposure, called "sonoporation method" is a promising approach for effective gene transfection; however it is difficult to transfer the therapeutic gene into the targeted cells selectively by the conventional sonoporation method. Take into these considerations, we have developed a novel gene transfection method using US-responsive and mannose-modified gene carriers, named Man-PEG₂₀₀₀ bubble lipoplexes, and succeeded in obtaining the enhanced gene expression in mannose receptor-expressing cells selectively by intravenous administration of Man-PEG₂₀₀₀ bubble lipoplexes and external US exposure in mice. This level of gene expression obtained by Man-PEG₂₀₀₀ bubble lipoplexes and US exposure was approximately 500–800-fold higher compared with the conventional lipofection method using mannose-modified carriers. However, since the elucidation of the mechanisms of enhanced gene expression followed by this gene transfection method is essential for application to clinical-use. Therefore, we investigated its mechanisms focused on the intracellular transport of pDNA, the in-vivo distribution of pDNA and the transcriptional process. Initially, we studied the mechanism of intracellular transport of pDNA followed by gene transfer using Man-PEG₂₀₀₀ bubble lipoplexes and US exposure. As results, a large amount of pDNA was directly introduced into the cytoplasm not-mediated endocytosis in the gene transfer using Man-PEG₂₀₀₀ bubble lipoplexes and US exposure. Then, following evaluation of the effect on the tissue distribution of pDNA using Man-PEG₂₀₀₀ bubble lipoplexes and US exposure, the amount of distributed pDNA in the liver and spleen was significantly increased followed by US exposure. Finally, we investigated the effect on transcriptional process followed by the gene transfection using Man-PEG₂₀₀₀ bubble lipoplexes and US exposure. The levels of *ap-1* mRNA expression and the intranuclear transport of NF- κ B were significantly and transiently increased after not only gene transfer using Man-PEG₂₀₀₀ bubble lipoplexes and US exposure, but also US exposure alone. These observations suggest that the enhanced gene expression obtained by gene transfer using Man-PEG₂₀₀₀ bubble lipoplexes and US exposure is caused by direct transport of pDNA into the cytoplasm, the increased in-vivo distribution of pDNA into the targeted cells and the transient activation of transcriptional process followed by US exposure. These findings make a valuable contribution to overcome the poor efficiency of gene expression in the gene transfer using non-viral gene carriers.

431. Non-Integrative Lentivirus Drives High-Frequency Cre-Mediated Cassette Exchange in Human Cells

Raul Torres,¹ Aida Garcia,¹ Monica Paya,¹ Juan C. Ramirez.¹
¹Viral Vector Core Facility, Fundacion CNIC, Madrid, Spain.

Recombinant mediated cassette exchange (RMCE) is a two-step process leading to genetic modification in a specific genomic target sequence. The process involves insertion of a docking genetic cassette in the genome followed by DNA transfer of a second cassette flanked by compatible recombination signals and expression of the recombinase.

Major technical drawbacks are cell viability upon transfection, expression of the enzyme, and the ability to target efficiently cell types of different origins. To overcome such drawbacks, we developed an RMCE assay that uses an integrase-deficient lentivirus (IDLV) vector in the second step combining with promoterless trapping of double selectable markers. Additionally, recombinase expression is self-limiting as a result of the exchangeable reaction, thus avoiding toxicity. Our approach provides proof-of-principle of a simple and novel strategy with expected wide applicability modelled on a primary human cell line HR single integrated copies of a genetic landing pad using a ZFN. This strategy does not present foreseeable limitations for wide application to other cell systems modified by homologous recombination or random integration. Safety, efficiency, and simplicity are the major advantages of our system, which can be applied in low-to-medium throughput strategies for screening of cDNAs, non-coding RNAs during functional genomic studies, and drug screening.

432. Construction and Characterization of Ligand-Streptavidin Fusion Proteins for Targeting of Biotinylated DNA Nanoparticles

Wenchao Sun,¹ Pamela B. Davis.¹
¹Department of Pediatrics and Department of Biochemistry, Case Western Reserve University, Cleveland, OH.

DNA nanoparticles (DNA NPs), which self-assemble from DNA plasmids and polylysine-poly(ethylene glycol) (PEG) block copolymers, have been successfully used to transfect several cell types in vitro and in vivo. However, targeting of DNA NP could enhance gene transfer efficiency and provide tropism. To provide targeting, in this study, peptide ligands genetically fused to the streptavidin protein (SA) were attached to the surface of biotinylated DNA NPs through the non-covalent biotin-avidin interaction after DNA compaction. This targeting strategy avoids the problems encountered in covalent conjugation methods and is efficient and versatile for attaching peptide ligands to DNA NPs. To prepare biotinylated DNA NPs (biotin-DNA NPs), DNA plasmids were compacted by a triblock copolymer biotin-PEG-polylysine, which was produced by coupling a 30-mer of polylysine with an N-terminal cysteine to a heterobifunctional PEG, maleimide-PEG-biotin. To prepare ligand-SA fusion protein, a monovalent SA system (which has been previously established by another group) is adopted. In this system, the SA retains its tetrameric structure but the biotin binding activity of three of the four subunits is inactivated by mutation so that one SA tetramer can bind to only one biotin with unaltered affinity. This SA tetramer, once genetically fused with a peptide ligand on each subunit, will present a ligand cluster with enhanced targeting activity, and the monovalency of biotin binding will avoid potential aggregation of biotinylated DNA NPs. First, TAT peptide from the HIV-1 Tat protein was fused to the N-terminus of the subunits of the monovalent SA. The fusion proteins were expressed in *E. coli*, purified and analyzed by SDS-PAGE and transmission electron microscope. In a functional study, biotin conjugated Alexa Fluor 488 was efficiently delivered into HeLa cells by TAT-SA but not SA as observed by fluorescence microscopy. The gene transfer activity of biotin-DNA NPs targeted by TAT-SA increased with the number of TAT attached to each DNA NPs, but achieved only three times the expression of reporter genes mediated by non-targeted DNA NPs. The molecular weight of the TAT-SA fusion protein is currently being confirmed by Mass Spectrometry. Meanwhile, two other peptide ligands, cyclic RGD and 105Y derived from α_1 -antitrypsin are also being tested. In conclusion, this is an efficient and universal strategy for attaching peptide ligands to biotinylated gene transfer agents.

433. Octaarginine- and pH Sensitive Fusogenic Peptide-Modified Nanoparticles for Liver Gene Delivery

Yasuhiro Hayashi,¹ Ryoichi Mizuno,¹ Khalil A. Ikramy,¹ Hideyoshi Harashima.¹

¹Faculty of Pharmaceutical Sciences, Hokkaido University, Sapporo, Japan.

We previously reported that octaarginine peptide modified liposomes (R8-liposomes) largely accumulated in the liver after intravenous administration and that this is dependent on the R8-density. We report herein on the development of a Multifunctional Envelope-type Nano Device modified with R8 and GALA, as a pH-sensitive fusogenic peptide (R8-GALA-MEND) for liver gene delivery. An R8-MEND encapsulating pDNA prepared using two different cores (negatively or positively charged pDNA/polyethylene imine condensed particles) failed to produce a high gene expression in the liver. Modification with GALA dramatically increased gene expression particularly in the liver only in the case of a negative core R8-MEND. Quantification of the delivered gene copies to the liver nucleus revealed that the amount of pDNA was comparable in all 4 cases (positive or negative cores, absence or presence of GALA). Gene expression efficiencies per nucleus-delivered pDNA were greatly improved in the case of the negative core R8-GALA-MEND, suggesting that the substantial improvement in gene expression can be explained by an improved gene expression efficiency per pDNA in the presence of GALA. A comparative study between the developed R8-GALA-MEND and a similar system containing DOTAP, a commonly used cationic lipid, instead of R8 showed that gene expression of the R8-GALA-MEND was 29 times higher than that of the DOTAP-GALA-MEND and is more selective for the liver. Collectively, these results suggest that the combination of a negatively charged core system and GALA modification of the R8-MEND is useful system for efficiently delivering genes to the liver.

434. Oligonucleotides Delivery Using High-Pressurized Lipoplexes

Tsuyoshi Kimura,¹ Asami Sano,¹ Kwangwoo Nam,¹ Yoshihiro Sasaki,¹ Kazunari Akiyoshi,² Akio Kishida.¹

¹Tokyo Medical and Dental University, Tokyo, Japan; ²Kyoto University, Kyoto, Japan.

Regulation of gene expression using oligonucleotides (ONs) is one of attractive methods for gene therapy. Cationic liposomes (CLs) are used to deliver ONs into cells effectively, and to inhibit expression of target gene selectively because stable and small complexes of CL and ON, called lipoplex, are formed by electrostatic interaction. Although lipoplex could be introduced into cell effectively, the efficiency and selectivity of gene suppression are insufficient. Previously, we reported that high hydrostatic pressurization (HHP) treatment for the complex of CL and plasmid DNA could improve the transfection efficiency. In this study, we investigated antisense-ODNs (AS-ODNs) delivery using lipoplex treated with HHP to inhibit a target gene effectively and selectively. Further, physicochemical properties of the HHP-treated lipoplex were examined in order to elucidate relationship between the structure and the transfection efficiency of the HHP treated lipoplex. Some researchers reported that the supramolecular structure of lipoplex strongly affected the efficiency of transfection. The pressurized lipoplexes with AS-ODNs were added to HEK293 cells expressing luc2 stably. The activity of luciferase was measured by using luminometer. Although the levels of gene suppression were different between AS-ONs used, the efficiency of gene silencing was enhanced by using the HHP-treated lipoplex compared to the non-pressurized lipoplex. For TEM observation, the lamellar structure of the non-treated lipoplexes was observed, whereas the amorphous structure including small and regular structure was observed for

the HHP-treated lipoplexes. The hydrophobic microenvironment of lipoplex was investigated by using fluorescent hydrophobic probes, such as Laurdan and pyrene. The fluorescent spectrum and intensity of these probes differed between lipoplexes with/without pressurization. These results suggest that the structure of lipoplex was changed by the HHP treatment. In conclusion, we successfully improved the efficiency of gene suppression by using the HHP treated lipoplex. It was found that the change of the structure of lipoplex was induced by the HHP treatment. We believe that this change of lipoplex structure by the HHP treatment affected the efficiency of gene suppression. This HHP treatment for lipoplex appears to be a promising contribution to gene and ON delivery.

435. Aptamer Conjugated Liposomes (Aptasomes) as an Efficient Detection/Delivery Nano-Vehicle toward Prostate Cancer Cells

Keun-Sik Kim,¹ Seho Kim,² Hyun-Mi Kwon,^{2,3} Gwang-Hyun Lee,² Yong Serk Park,⁴ Dong-Eun Kim.^{2,3}

¹Department of Biomedical Laboratory Science, Konyang University, Daejeon, Korea; ²Department of Bioscience and Biotechnology, Konkuk University, Seoul, Korea; ³WCU and BRL Program, Konkuk University, Seoul, Korea; ⁴Department of Biomedical Laboratory Science, Yonsei University, Wonju, Korea.

Nucleic acid ligands (aptamers) are potentially well suited for the therapeutic targeting of drug or gene encapsulated liposomes particles in a cell- or tissue-specific manner. In this study, we report the design of aptamer conjugated POPC (1-parmitonyl-2-oleoyl-*sn*-glycerol-3-phosphocholine)-liposomes (aptasomes) that achieves selective and strong binding of otherwise low-affinity aptamers at physiological conditions. Published PSMA RNA aptamer A9 which was well known PSMA (prostate-specific membrane antigen) specific RNA sequences was extended for annealing with complementary DNA linker which was labeled with thiol group and FITC. The modified PSMA aptamers were conjugated with maleimide group on the surface of PEGylated micelles. Specifically, we prepared the PSMA-specific aptasomes by a new post-insertion method. These nanoparticle-aptasomes of the nano size (90–100 nm) bind to the PSMA protein expressed on the surface of LNCaP prostate epithelial cells resulting in significantly enhanced *in vitro* cellular binding as compared with nontargeted nanoparticles that lack the PSMA aptamer. The doxorubicin (Dox)-encapsulated aptasomes were significantly more cytotoxic toward targeted LNCaP cells than the nontargeted PC3 and A549 cells. The FITC-labeled siRNA encapsulated aptasomes also exhibited remarkable transfection efficacy of siRNA into LNCaP cells as compared with nontargeted cells (PC3 and A549). Furthermore, we are currently preparing for the Gd- aptasomes containing 10 mol % Gadolinium-phosphatidylethanolamine (Gd-DTPA-PE) as MRI agents for MR imaging to LNCaP tumor in LNCaP xenograft nude mouse. These results will show our PSMA-aptasome has high potential for *in vivo* imaging of prostate cancer cell recognition and for *in vivo* drug or gene delivery application.

436. Dual pH Response Nanoparticles for Gene Delivery

Jose M. Morachis,¹ Enas A. Mahmoud,¹ Jagadis Sankaranarayanan,¹ Jenny Huang,¹ Adah Almutairi.^{1,2}

¹Pharmaceutical Sciences, University of California at San Diego, La Jolla, CA; ²Materials Science and Engineering, University of California at San Diego, La Jolla, CA.

Emerging gene delivery tools offer novel therapeutic approaches to address several types of diseases including progeria, cystic fibrosis, parkinsons, and multiple types of cancers. We investigated a novel gene delivery system using logic gate nanoparticles developed with a dual pH responsive random co-polymer (poly-β-aminoester ketal-2).

The random co-polymer is unique because the amine backbone undergoes a sharp hydrophobic-hydrophilic switch at acidic pH. This leads to an increase in uptake of water (bulk dissolution) and hence an increase in ketal hydrolysis (surface and bulk degradation). We hypothesized that these nanoparticles would be able to increase gene delivery and expression efficiency by providing effective endosomal release and expression of DNA due to its ability to quickly “burst” and release the DNA content into the cytoplasm. Passive nanoparticle entry into cells was demonstrated by delivering Cy-5 labeled pDNA encoding EGFP into HCT116, a colon carcinoma cell line. Flow cytometry analysis showed cells to be positive for Cy5-DNA-nanoparticles and later produced EGFP expression superior to PLGA nanoparticles. Inhibition of VAMPases using bafilomycin A1 demonstrates that expression of EGFP is dependent on the “proton sponge effect”. Further experiments are underway to test if siRNA can also be encapsulated and delivered for fast release and gene knockdown. The advanced dual response nanoparticles offer new therapeutic possibilities and can be combined with cell type specific peptides for improved cellular entry and specificity.

437. The Interaction between SP100 and Rep78 Inhibits Rep-Dependent Integration and Mediates SP100 Degradation

Jinzhong Chen,¹ Yuan-Yuan Xue,¹ Ran Wang,¹ Yang-bo Yue,¹ Jing-lun Xue.¹

¹State Key Laboratory of Genetic Engineering, Institute of Genetics, School of Life Sciences, Fudan University, Shanghai, China.

The adeno-associated virus type 2 (AAV-2) Rep78 is a multifunctional protein that is required for viral transcription, replication, and site-specific integration. Rep-dependent integration is not related to any known disease; therefore, this type of integration may be a potential tool for carrying therapeutic genes to the human genome. However, the intracellular process of Rep-dependent integration is still unclear. As a result, improving the Rep-dependent integration system is difficult. In the present study, we revealed the interaction between Rep78 and the cellular protein SP100, a member of the PML nuclear bodies (PML-NBs). SP100 and Rep78 are located in the nucleolus, which provides the spatial possibility for their interaction. In addition, Rep78 was shown to co-immunoprecipitate with the EGFP-SP100 fusion protein but not with EGFP, which provided evidence for the interaction between SP100 and Rep78. A knock-down of the endogenous SP100 expression using siRNA resulted in an increased efficiency of the Rep-dependent integration.

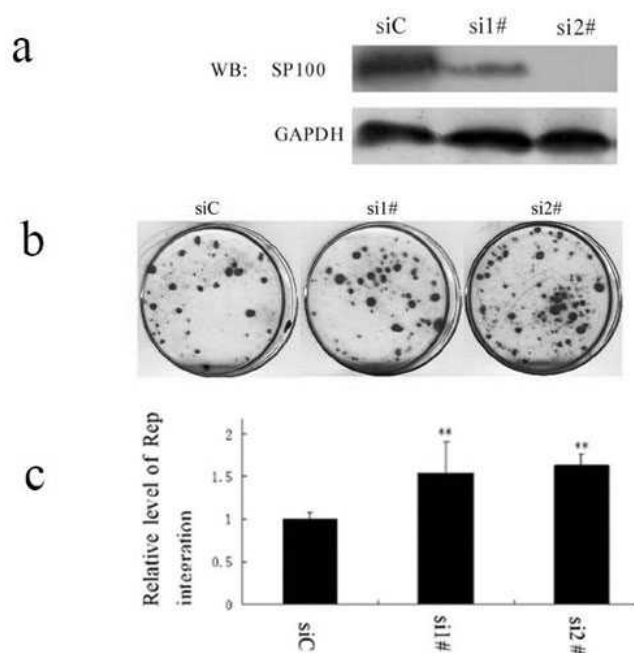

Conversely, the transient expression of Rep78 resulted in an increased degradation of cellular SP100. This degradation was inhibited by treatment with MG132, an inhibitor of the ubiquitin proteasome.

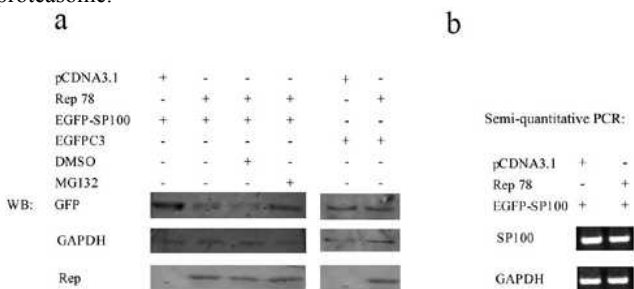

These results have furthered our knowledge about Rep78 and the cellular protein SP100. These results may also lead to an improvement in the Rep78-related transgene method and in the selection of target cells for gene therapy.

438. Rep of AAV Protects p53 from E1B Mediated p53 Nucleolus Egress and Degradation

Xu Wang,¹ Jing-lun Xue,¹ Wenjuan Li,¹ Jinzhong Chen,¹ Jinjin Wang.¹

¹State Key Laboratory of Genetic Engineering, Institute of Genetics, School of Life Sciences, Fudan University, Shanghai, China.

Adenoviral E1B mediated P53 degradation is key step of adenoviral early process. It also involved in regulating AAV infection cycle. We identified a C terminal fragment of rep78 is a p53 binding domain by protein array. The result was further verified by coIP assay, rep78 but not rep68 binds to p53. As a p53 binding protein, rep78 protects p53 from E1B mediated protein degradation.

Physical Methods of Delivery I

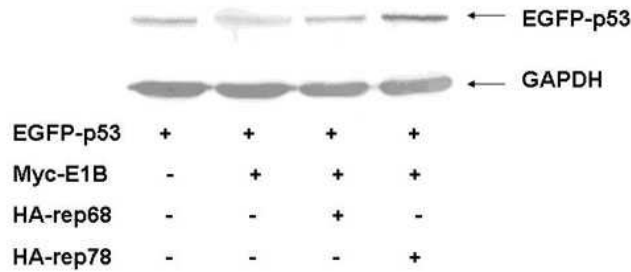

It also prevents E1B mediated p53 nucleolus egress.

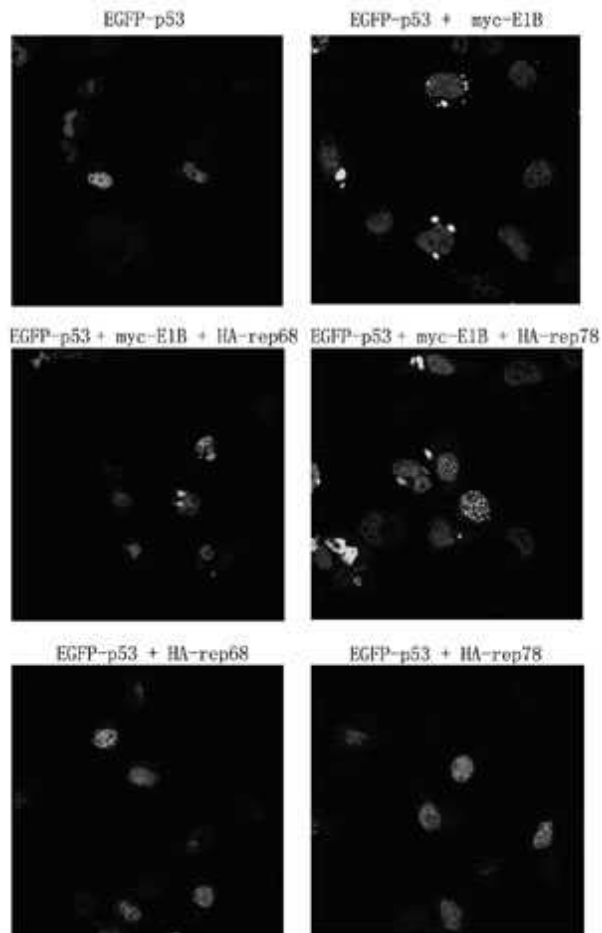

However, a dual-fluorescent based assay suggested that rep cannot rescue the p53 transcriptional activity from E1B inhibition. The results suggested that p53 play a key role both in adenoviral and AAV infection cycles. The detail mechanism need further study to clarify.

439. Genetic Electrotransfer Immunization for the Identification of Functionally Important Epitopes: The Example of VAR2CSA in Placental Adhesion of Plasmodium Falciparum Infected Erythrocytes

S. Gnidehou,¹ P. Bigey,² J. Doritchamou,³ M. Quiviger,¹ F. Viwami,³ A. Couturier,⁴ A. Salanti,⁴ Daniel Scherman,² P. Deloron,¹ N. Tuikue Ndam.^{1,3}

¹UMR216PD, Institut de Recherche pour le Développement (IRD), Université Paris Descartes, Paris, France; ²Unité de Pharmacologie Chimique et Génétique, Inserm U1022, CNRS UMR8151, Université Paris Descartes, ENSCP Chimie ParisTech, Paris, France; ³Faculté des Sciences de la Santé et Institut des Sciences Biomédicale et Appliquées, Université d'Abomey-Calavi, Cotonou, Benin; ⁴Institute of International Health, Immunology and Microbiology, Copenhagen, Denmark.

The consequences of pregnancy-associated malaria on pregnant women (anaemia), their babies (birth weight reduction), and infants (increased morbidity and mortality) arises from the placental sequestration of infected erythrocytes. Placental sequestration of infected erythrocytes has been linked to the binding to chondroitine sulfate A of the parasite protein VAR2CSA, which is expressed on the infected erythrocytes membrane. Compelling evidence shows that immune response to VAR2CSA gives an effective protection against pregnancy-associated malaria. This suggests that the syndrome could be prevented by a vaccine. However, VAR2CSA is a large transmembrane protein, and mapping of the regions functionally important for immunization has been unsuccessful so far. By using genetic immunization through intramuscular electrotransfer, we have raised a bank of polyclonal antisera against contiguous segments of VAR2CSA. Only a polyclonal antiserum raised against the N-terminal fragment DBL1X-Id1-DBL2X, could efficiently block parasite binding to CSA similarly to the full-length extracellular domain of the molecule. Interestingly, naturally acquired antibodies to this area of VAR2CSA target strain-transcendent anti-adhesion epitopes. The inhibitory capacity of the polyclonal antibodies was confirmed with a panel of fresh clinical isolates from pregnant women living in Benin. This study illustrates the value of genetic immunization for dominant epitopes localization and vaccine development.

440. Enhanced Gene Gun-Based Gene Delivery to the Liver through Trans-Peritoneal Bombardment

Kohei Tatsumi,¹ Kazuo Ohashi,¹ Tomohiko Yamazaki,² Akiyoshi Taniguchi,² Teruo Okano.¹

¹Institute of Advanced Biomedical Engineering and Science, Tokyo Women's Medical University, Shinjuku, Tokyo, Japan; ²Biomaterials Center, National Institute for Materials Science, Tsukuba, Ibaragi, Japan.

<Background> The liver is an important target organ for gene transduction to treat many forms of inherited genetic deficiencies. An important criterion in the development of effective liver-directed gene delivery systems is the ability to perform repetitive procedures in a minimally invasive manner. In recent years, gene gun-based approaches have been empirically tested to deliver plasmid DNA into the liver in vivo. However, when bombardment to the liver surface is performed at high pressure, liver injury, specifically liver necrosis, has been observed. The present study was designed to determine whether a modified trans-peritoneal gene gun approach would produce efficient transfection of plasmid DNA into the liver without any overt liver injury. <Methods and methods> Plasmid DNA expressing human coagulation factor IX (hFIX) under the control of

CMV promoter (pCMV-hFIX) was coated on gold particles (1 μ m diameter) by a salting-out protocol and loaded on the Helios Gene Gun System (BIO-RAD). C57Bl/6 mice were divided into two groups for gene gun-based plasmid delivery to the liver (50 μ g of plasmid per mouse) under 2 different procedures. For the first group (direct group), skin and abdominal incisions were made and left lateral liver lobes were exposed. Bombardment was performed right above the liver at 200 psi. For the second group (trans-p group), a skin incision was made and the peritoneal membrane where left liver lobe was located below was exposed to bombard the plasmid DNA with the gene gun at 200 psi. Plasma samples were assessed for AST levels at day 2 and for hFIX levels at day 7. At day 7, left lateral liver lobes were also harvested to measure hFIX mRNA expression levels. <Results> Plasma ALT levels at day 2 in the direct group, trans-p, and sham groups were 70.1 \pm 11.2 U/L, 27.2 \pm 6.3 U/L, and 28.7 \pm 5.9 U/L, respectively. There was 1 mortality event in the direct group, which was thought to be related with the bombardment. These data demonstrate that the trans-p bombardment procedure could be performed without inducing liver injury. Plasma hFIX levels at day 7 were significantly higher hFIX levels (12.9 \pm 0.6 ng/ml) in the trans-p group compared with direct group (2.7 \pm 1.8 ng/ml). In line with the plasma hFIX levels, the mRNA expression levels of the bombarded liver lobes showed significantly higher values in the trans-p group than those in the direct group. <Conclusion> The present study is the first to demonstrate that plasmid with gold particle can be safely and effectively delivered to the liver through trans-peritoneal bombardment. Gene gun bombardment-based trans-peritoneal DNA delivery could provide an alternate gene delivery approach to treat inherited liver disorders, including hemophilia.

441. Electroporation Parameters Utilized for Delivering Plasmids Encoding Cytokines Impact the Outcome of Melanoma Therapy

Shawna A. Shirley,¹ Richard Heller.¹

¹Frank Reidy Center for Bioelectronics, Old Dominion University, Norfolk, VA; ²Center for Molecular Delivery, University of South Florida, Tampa, FL.

Electroporation (EP) is an effective method for transferring therapeutic genes into a variety of tissues, making it attractive for use in cancer therapy. The delivery of plasmid DNA encoding therapeutic genes for the treatment of melanoma have been explored in numerous preclinical studies. The use of recombinant cytokines as an anti-cancer therapy, though promising, is limited by its side effects. Using a gene therapy-based EP approach may alleviate the deleterious effects. Direct delivery of the therapeutic cytokine interleukin 12 (IL-12) to the tumor has been shown to generate a local as well as a systemic antitumor effect. Furthermore, EP itself has been recently shown to trigger an immune response independent of the DNA delivered. With these things in mind, here we evaluate the effects of using different electroporation conditions to deliver therapeutic cytokines directly to the tumors in a B16.F10 model of melanoma. The voltage used, the duration of the pulses and the number of pulses used are directly related to the efficiency of gene transfer and ultimately gene expression. In this study we compare high voltage, short duration (HVSD) pulses with low voltage, long duration (LVLD) pulses. We evaluated the length and level of gene expression and ability of the treatment to generate long term protective effects. We also examined the immune response that was generated when using these conditions. We found that gene electrotransfer using all conditions generated elevated levels of cytokines, were able to generate an immune response and increased survival past day 60 after initial inoculation when compared to control. Gene delivery to mice using the LVLD pulses did not make them resistant to challenge with B16 cells, those mice that were treated using HVSD pulses were resistant to challenge

with B16 cells. The results from this study demonstrate that it is important to select the appropriate EP parameters for delivery as they will have an effect on the outcome of the therapy.

442. Generating Defined, Characterized Microbubbles To Enhance the Efficiency of Ultrasound-Mediated Gene Delivery System *In Vitro*

Samuel S. Sun,¹ Misty L. Noble,¹ Milo C. Snyder,¹ Adrienne Rothschilds,¹ Carol H. Miao.^{1,2}

¹Seattle Children's Research Institute, Seattle; ²Department of Pediatrics, University of Washington, Seattle.

Microbubbles (MBs) are commonly used as contrast agents in medical imaging; but it has also been used in conjunction with ultrasound (US) to enhance gene transfer into cells. MBs serve as cavitation nuclei in the presence of US, which enables sonoporation to take place and transiently increases cell membrane permeability to allow for efficient delivery of plasmid DNA into target cells. The specificity, low toxicity, and low immunogenicity of this non-viral delivery system are advantageous in gene therapy applications. The aim of our study is to generate MBs with controlled characteristics and to test their effectiveness in enhancing the US-mediated transfection *in vitro*. We generated MBs that have similar lipid shell composition and gas core to Definity®, a commercially available contrast agent. The size distribution, concentration, and binding efficiencies of MBs to plasmid were determined using a Coulter Counter and a flow cytometer. We found that the size of our MBs was comparable to Definity®, although the concentration was slightly lower. The lipid composition was also modified to produce cationic MBs that carried a slightly positive charge in the MB shell. When the MBs were combined with CyTM5-labeled plasmid DNA in a fixed ratio, we found that 70% to 80% of either type of MBs was fluorescent. Notably, the mean fluorescence intensity of the cationic MBs was much higher, indicating stronger binding to the negatively charged plasmid DNA. 293T and HepG2 cells were cultured and exposed to different US conditions (1 MHz frequency, 20% duty cycle at 100 Hz pulse repetition frequency, 0.5 to 2 W/cm² intensities for 1 to 5 mins). We found that cells exposed to 2 W/cm² for 3 mins in the presence of p2x-GFP plasmid produced the highest GFP expression while maintaining good cell viability as assessed by an MTT assay. In addition, we transfected the cells with pGL3 reporter plasmid and performed a luciferase assay to evaluate gene expression levels 24 and 48 hrs after transfection and US exposure. The luciferase activity (RLU/mg) after 48 hrs, though lower than that of the Lipofectamine-treated positive control, was over 3500-fold greater than that of plasmid DNA only transfected cells without ultrasound exposure. Moreover, preliminary data showed that the addition of neutral MBs even at low concentrations upon US treatment enhanced the luciferase expression by over 10-fold compared to that of cells transfected with US only. *In vitro* experiments are ongoing to test whether cationic MBs can further augment the transfection efficiency. Our study shows that changing the lipid composition of MBs can alter their binding affinity to plasmid DNA, which may potentially improve US-mediated gene delivery. In addition, we demonstrate a convenient *in vitro* method for testing US parameters and screening MBs to support *in vivo* findings and facilitate new designs of *in vivo* experiments.

443. phiC31 Integrase-Mediated Long-Term Gene Expression in the Cultured Renal Cell Lines and Murine Kidney

Shigeru Kawakami,¹ Yuki Otani,¹ Hidefumi Mukai,¹ Yoshiaki Umemoto,¹ Fumiyoshi Yamashita,¹ Mitsuru Hashida.^{1,2}

¹Department of Drug Delivery Research, Graduate School of Pharmaceutical Sciences, Kyoto University, Kyoto, Japan;

²Institute for Integrated Cell-Material Sciences (iCeMS), Kyoto University, Kyoto, Japan.

Long-term *in vivo* gene expression system in the kidney is a promising tool for wide variety of biomedical studies, such as functional analysis of disease-related genes, construction of animal disease models and gene therapy for the treatment of renal diseases. However, there are a number of obstacles to hamper the achievement of long-term *in vivo* gene expression in the kidney. The achievement in long-term gene expression in the kidney allows meaningful translation for not only gene therapy of renal and congenital diseases but also various genetic studies such as construction of animal disease models and functional analysis of disease-related genes. Recent studies revealed that the *Streptomyces* bacteriophage phiC31 integrase possesses a potential to achieve long-term gene expression because of its site-specific and unidirectional integration reaction. phiC31 integrase mediates site-specific recombination of the phage genome into the bacterial chromosome through a unidirectional reaction between the phage *attP* site and bacterial *attB* site. However, few reports are available on achieving the sustained gene expression using phiC31 integrase in the kidney. In this study, we constructed the donor pDNA which encoded luciferase cDNA as a reporter gene and the helper pDNA which expresses integrase protein and developed an *in vivo* long-term gene expression system in the murine kidney. At first, we determined whether the phiC31 integrase could mediate the long-term gene expression in murine and human kidney cell lines, RENCA, TCMK-1 and HEK293 cells. The significantly high luciferase expression levels were sustained over a month compared to non-integrase expression system. The genomic DNA and pDNA were extracted from the cells at 14 days post-transfection. The PCR analysis demonstrated that luciferase cDNA sequence was integrated in one of pseudo *attP* sites, called *mpsL1* site. In addition, phiC31 integrase transfected cells were received less damages of genomic DNA caused by integrase expression in RENCA and TCMK-1 cells. To construct the *in vivo* long-term gene expression system in the kidney, donor pDNA and helper pDNA were co-transfected into the right kidney via the direct pDNA injection into kidney followed by electroporation. Luciferase expression levels in the integrase group were sustained over 2 months and significantly higher than those in the control group. The findings of this study will offer the useful information toward not only the genetic fields, but also the gene therapy using phiC31 integrase of the chronic and congenital renal diseases.

444. Hydrodynamic Limb Vein Injection Method Can Open an Avenue of Mitochondrial Gene Delivery *In Vivo*

Yukari Yasuzaki,¹ Yuma Yamada,¹ Tsutomu Kanefuji,² Dexi Liu,² Hideyoshi Harashima.¹

¹Laboratory for Molecular Design of Pharmaceuticals, Faculty of Pharmaceutical Sciences, Hokkaido University, Sapporo, Japan;

²Department of Pharmaceutical Sciences, University of Pittsburgh, Pittsburgh, PA.

Mitochondria are unique organelle which have their own gene different from nuclear DNA (nDNA), so-called mitochondrial DNA (mtDNA). Because of their important roles as producers of energy in higher cells, mitochondrial dysfunction are involved with disorders at any kinds of tissues that have high energy requirements, such as brain, retina, heart, muscle, liver and endocrine systems.

Mitochondrion consists of at least 1500 proteins, and encoding genes are located in both the maternal inherited mtDNA and the Mendelian nDNA. Therefore, both mtDNA and nDNA can be target molecules to treat mitochondrial related diseases that caused by dysfunction of mitochondrial protein. For these therapies, optimal gene delivery system targeted to mitochondria or nucleus should be required. In the case of nuclear gene therapy, various gene delivery trials have been performed, and some cases proceed to the stage of clinical trial. As regarding nuclear gene delivery, there are many efforts such as cationic liposome methods, polycation conjugate methods, viral vector methods and so on. On the other hand, there is little report regarding mitochondrial gene therapy. Probably, unsatisfied mitochondrial gene delivery technology seems to have an unfeasibility of mitochondrial gene therapy. Even though *in vitro* experiment, very few studies of mitochondrial gene delivery have performed, there is no report of mitochondrial gene delivery *in vivo* experiment. Although many candidate genes with therapeutic and/or diagnostic potential have been known, their utility has not yet been realized because mitochondrial gene delivery technology is the bottleneck. Here, we attempted mitochondrial gene delivery in skeletal muscle tissue using hydrodynamic limb vein injection method. The procedure of hydrodynamic gene delivery is known for very useful methods in the context of nuclear gene delivery. We expected that hydrodynamic limb vein injection could introduce genes into not only nucleus but also mitochondria, since this method overcomes physical barrier, such as plasma nuclear membrane barriers. In this study, we injected fluorescent labeled plasmid DNA (pDNA) from Dorsalis pedis vein using hydrodynamic method. After 24-hr injection, we observed living muscle tissue after staining mitochondria, using confocal laser scanning microscopy. The result showed that several pDNA were colocalized with mitochondria in myofiber. Moreover, we confirmed that the hydrodynamic limb vein injection could deliver pDNA into myofibrillar mitochondria more effectively than conventional local injection. These findings indicate that hydrodynamic limb vein injection could achieve *in vivo* mitochondrial gene delivery. We believe that this approach has a potency of mitochondrial gene therapy.

445. Utilization of a Single Method for Transfection of Multi-Cistronic Plasmids, mRNA and Protein in Primary Human Dermal Fibroblasts

Laura A. Vozza-Brown,¹ Uma Lakshmiopathy,¹ Reut Mali,¹ Kristin Wiederholt.¹

¹Research and Development, Life Technologies, Carlsbad, CA.

The generation of pluripotent stem cells that are patient derived has the potential to accelerate the use of stem cells for clinical treatment of many devastating conditions such as neurodegenerative diseases, cardiovascular diseases, cancer and diabetes. Current methods have shown that introduction of a set of embryonic transcription factors encoding specific combinations of embryonic transcription factors Oct4, Sox2, C-Myc, Lin28, Nr5a2 and Klf4 can globally reset the epigenetic and transcriptional state of fibroblasts into that of pluripotent cells. Early methods relied on the use of retroviruses to efficiently deliver the factors into the primary somatic cells. However, these viral delivery methods also have the potential for mutational insertion and leaky expression and are not suitable in a therapeutic setting where an integration-free approach is preferred. Non-integrating methods to introduce these transcription factors by episomal multi-cistronic plasmids, purified proteins, and mRNA have been developed however the low efficiency at which the payloads are delivered has proven to be challenging. The purpose of the present study was to evaluate and optimize the efficiency at which each of these types of payloads can be delivered into human dermal fibroblasts. Using a Neon® electroporation device we successfully delivered purified β -galactosidase protein, an mRNA transcript encoding emerald GFP,

and both single and multi-cistronic plasmids into cultures of human dermal fibroblasts at high efficiency with minimal reduction in cell viability. These results provide the methodologies for further studies using electroporation for the induction of pluripotent stem cells from adult somatic cells.

446. Therapeutic Ultrasound Promotes Plasmid DNA Uptake by Clathrin-Mediated Endocytosis

Daisy Bentes de Paula,¹ Valderez Bastos Valero-Lapchik,¹ Edgar Julian Paredes-Gamero,¹ Sang Won Han.¹

¹Department of Biophysics, Federal University of São Paulo, São Paulo, São Paulo, Brazil.

Ultrasound (US) has been widely used to improve the efficiency of non-viral vector transfection. However, the mechanism that enables the uptake of plasmid DNA in cells by US insonation is poorly understood, but it is typically attributed to sonoporation. Based on our previous results, we hypothesized that other mechanisms, such as endocytosis, are involved in this process. To explore the mechanism of plasmid DNA uptake, a plasmid vector expressing EGFP (pEGFP-N3: 4.7 kb) was used to transfect NIH3T3 using a therapeutic US without microbubbles and was monitored in real-time using a confocal microscope. We achieved about 40% transfection efficiency when we applied 2 W/cm² with 20% of duty-cycle for 30 s, but 1 W/cm² resulted in a very low level of transfection. In these experiments, the production of reactive oxygen species was augmented during the insonation but was stopped soon after turning off the US. Calcium influx was also augmented during the insonation, but its level did not return to basal levels following the 3-min observation period. However, 1 W/cm² was not sufficient to mobilize calcium influx during the insonation, and calcium influx began 12 s after turning off the US. US insonation also changed the cell membrane potential to promote a hyperpolarization state, which returned to the normal state soon after turning off the US. The alteration of these parameters by US indicates the uptake of plasmid DNA by endocytosis. Finally, using a fluorescently labeled plasmid, we showed that this molecule enters into cells via clathrin-mediated endocytosis, not via caveolin-1.

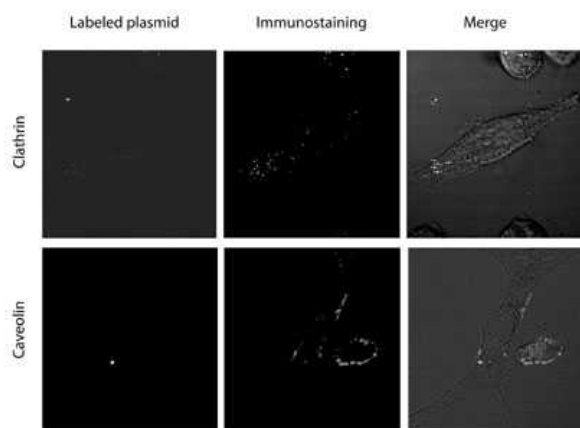

447. Importance of Electrode Choice on Gene Electrotransfer to Skin; Evaluated by Efficacy of Transgene Expression and Electric Field Calculation in a Porcine Model

Anita Gothelf,¹ Faisal Mahmood,¹ Frederik Dagnaes-Hansen,² Julie Gehl.¹

¹Department of Oncology 54B1, Copenhagen University Hospital Herlev, Herlev, Denmark; ²Department of Medical Microbiology and Immunology, University of Aarhus, Aarhus, Denmark.

Introduction: Gene electrotransfer, which designates the

combination of gene transfer and electroporation, is a non-viral technique of transporting DNA into cells and tissues. Results from the first clinical study in tumours have been published and several clinical trials on DNA vaccination using electrotransfer are underway. However, most preclinical studies have been performed in rodents and the body of evidence on electrode choice and optimal pulsing conditions is limited. We thus evaluated two different electrode configurations in a porcine animal model, which is more similar to human skin. Material and Methods: The luciferase (pCMV-Luc) gene was injected intradermally (100 µg DNA in 100 µl PBS) and subsequently electroporated with either non-invasive plate electrodes or invasive needle electrodes. The electric pulses delivered were composed of 1 high voltage pulse (HV, 1000 V/cm, 100 µs) and 1 low voltage pulse (LV, 80-140 V/cm, 400 ms). Forty-eight hours after the transfection, the treated skin areas were removed as punch biopsies and analyzed for content of luciferase enzyme. Results: We found needle electrodes were more efficient than plate electrodes in porcine skin ($p < 0.001$) and that in a HV + LV pulse combination, a LV pulse larger than 100 V/cm can improve the expression. Electric field calculations showed that penetration of the stratum corneum led to much more homogenous field distribution at the DNA injection site. In conclusion, our data support that needle electrodes should be used in human clinical studies of gene electrotransfer to skin for an improved expression.

448. Muscle Gene Electrotransfer Is Increased by Antioxidant Tempol in Mice

Bostjan Markelc,¹ Gregor Tevz,¹ Maja Cemazar,¹ Simona Kranjc,¹ Jaka Lavrencak,² Bojana Zegura,³ Justin Teissie,^{4,5} Gregor Sersa.¹

¹Department of Experimental Oncology, Institute of Oncology Ljubljana, Ljubljana, Slovenia; ²Department of Cytopathology, Institute of Oncology Ljubljana, Ljubljana, Slovenia; ³National Institute of Biology, Ljubljana, Slovenia; ⁴IPBS CNRS, UMR 5089, Toulouse, France; ⁵Université de Toulouse; UPS; IPBS, Toulouse, France.

Background. Electropermeabilization is an effective method for gene transfer into different tissues. However, several factors can affect transfection efficiency of gene electrotransfer, one of them being generation of reactive oxygen species (ROS) that can interact with plasmid DNA and lower transfection yield. The aim of our study was to explore the generation of ROS due to exposure of cells to electric pulses used for electrogene therapy and their consequence on expression of transgene. The effect of ROS scavengers on transfection efficiency of reporter gene electrotransfer to C2C12 myoblasts in vitro and m. tibialis cranialis in mice was evaluated. Materials and methods. Generated ROS were determined by lucigenin chemiluminescence after application of electric pulses (8 pulses, electric field intensity 600 V/cm, duration 5ms, frequency 1 Hz). A plasmid coding for green fluorescent protein (GFP) expression was used. Effect of electric pulses on plasmid DNA was determined by DNA electrophoresis and on genomic DNA by comet assay and by 8-oxoguanine assay. Transfection efficiency in vitro was determined by flow cytometry and by fluorescence microscopy in C2C12 myoblasts and by fluorescence imaging of m. tibialis cranialis in vivo in C57Bl/6 mice. Vitamin C and tempol were used as antioxidants in vitro and tempol in vivo. Results. The generation of ROS in C2C12 myoblasts was dependent on the amplitude of the applied electric pulses. The generated ROS were neutralized by plasmid DNA present at the time of electropermeabilization of cells, and scavenged by antioxidants vitamin C and tempol. The ROS generated on the cell did not affect genomic DNA. Presence of tempol during electropermeabilization increased transfection efficiency of plasmid DNA into the cells in vitro by 1.6-fold and increased expression in m. tibialis cranialis in mice by 1.4 fold. Conclusion. The generated ROS on the cells during the electropermeabilization can be scavenged by antioxidants.

Antioxidant tempol proved to be effective in increasing transfection efficiency also in vivo, and could be used as means to improve gene electrotransfer into the muscle and possibly also to other tissues.

449. Nanoparticle-Mediated Gene Transfer in an In Vitro Model of Human Trophoblasts

Helen Jones,¹ Donglu Shi,² Foong-Yen Lim,¹ Sundeep Keswani,¹ Timothy Crombleholme,¹ Mounira Habli.¹

¹Center for Molecular Fetal Therapy, Cincinnati Children's Hospital Medical Center, Cincinnati, OH; ²Chemical & Materials Engineering, University of Cincinnati, Cincinnati, OH.

Previous experiments in our laboratory with adenovirus-mediated gene transfer demonstrated the ability of intra-placental gene delivery to modulate placental functions and fetal growth in vivo (1, 2). However, the development of nonviral transgene delivery systems are essential for the safe application of gene therapy in the developing human fetus and placenta. A novel poly-amino-ester dendrimer complexed with DNA represents a non-viral nanoparticle alternative for gene transfer (3). To investigate the optimal density, efficiency of gene transfer and cell toxicity of poly-amino-ester-DNA nanoparticles to transfect human placental cells we used eGFP as a reporter transgene and BeWo cells, a choriocarcinoma derived trophoblast cell line as an in vitro model of human placental trophoblasts. BeWo cells were plated overnight in control media (Ham's F12 Nutrient Mix + Penicillin/Streptomycin + 10% FBS) to reach >75% confluence. Increasing w/w ratios of Dendrimer (1mg/ml):eGFP (2mg/ml) were incubated together for 1 hour at room temperature in serum-free media. Cells were washed and transferred to serum-free control media. Dendrimer-eGFP complexes were added to cells and after 6 hours 10% FBS was added. eGFP expression was observed microscopically, cell proliferation was assessed using the Crystal Violet assay (absorbance at 570nm) and apoptosis assessed by Caspase-3 expression 48 hours after nanoparticle addition. Time-matched controls included cells incubated in control media ± dendrimer only or eGFP only. Data are means ± SD, and were analyzed by ANOVA. Poly-amino-ester:DNA w/w ratios of 2:1, 4:1 and 6:1 resulted in the expression of GFP, with a transfection efficiency of 100% at 6:1. Cell proliferation remained at control levels (0.31 ± 0.03) in all treated groups up to a ratio of 6:1 but dropped significantly ($p < 0.05$, $n=4$) to 0.21 ± 0.02 or lower following incubation with ratios greater than 8:1 (figure 1). The apoptosis index was significantly ($p < 0.05$, $n=4$) increased using w/w ratios of 8:1 (2.45 ± 0.4) or 16:1 (3.25 ± 0.25) compared to controls (1 ± 0.2) and w/w ratios of 6:1 (0.95 ± 0.22). Nanoparticle gene transfer can be achieved with optimal expression efficiency, preserved rates of proliferation and apoptosis in an in vitro model of human trophoblasts using poly-amino-ester:DNA w/w ratios of 6:1. Higher ratios did not improve efficiency and showed detrimental effects on cellular proliferation and increased apoptosis. 1. Jones et al. Placenta. 2010 9;A137. 2. Habli et al. Molecular Therapy 2008 16;S27. 3. Ma et al. J. Am. Chem. Soc. 2009 131; 14795-14803.

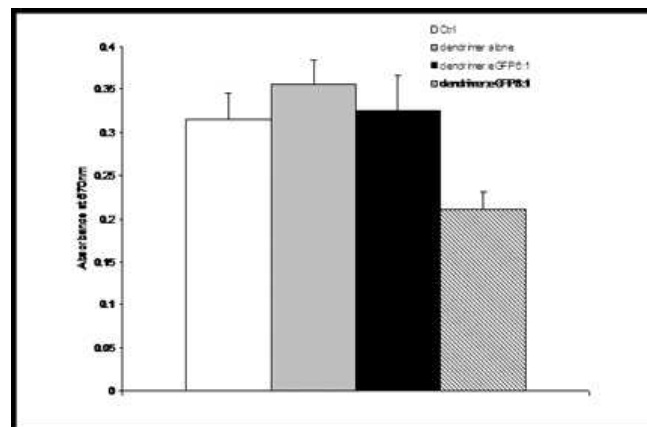

450. Aerosol Delivery of Plasmid DNA in a Mesh Nebuliser: Formulation and Transfection Studies

Eugene R. Arulmuthu,^{1,2} Andrew S. Tait,² David J. Williams,¹ Henk K. Versteeg,¹ John Ward,³ Mike Hoare.²

¹Healthcare Engineering, Wolfson School of Mechanical and Manufacturing Engineering, Loughborough University, Loughborough, United Kingdom; ²The Advanced Centre for Biochemical Engineering, University College London, London, United Kingdom; ³Institute of Structural and Molecular Biology, Division of Biosciences, University College London, London, United Kingdom.

Aerosol delivery of non-viral plasmid DNA-based gene therapeutics promises to be an effective way of administering future gene medicines. The main hurdle for the successful application of gene therapy to the clinic is the safe delivery of the vector to the targeted cells to obtain efficient gene expression. Recent clinical developments in inhaled insulin suggest systemic delivery of therapeutics through the pulmonary route as a viable approach. Understanding plasmid DNA integrity during delivery is crucial to the development of formulations aimed at protection of the super-coiled (sc) structure for non-viral gene therapy. Earlier studies showed the sc structure of a 5.7 kb plasmid was not damaged on aerosolisation in the mesh nebuliser, while the open-circular (oc) structure of the plasmid was damaged. In this paper, we report formulation and transfection studies of a 5.7 kb plasmid containing Green Fluorescent Protein (GFP) gene using a clinically approved MicroAir® (NE-U22) mesh nebulizer. *In vitro* transient transfection studies on CHO cells using 5.7 kb plasmid DNA aerosols formulated with polyethylenimine (PEI) resulted in no significant difference in transfection efficiency of nebulised and unnebulised plasmid. This result demonstrates that the nebulisation process does not affect delivery and gene expression, confirming our earlier paper on safe aerosol delivery of sc 5.7 kb plasmid DNA using a mesh nebuliser. Plasmids of different sizes from 5.7 to 20 kb were studied in order to determine the limiting plasmid size for safe aerosol delivery of the sc structure using mesh nebulisers.

Genetic and Metabolic Diseases Gene & Cell Therapy II

451. Fetal Gene Therapy for Lethal Murine Hypophosphatasia

Hanako Sugano,^{1,2} Tae Matsumoto,^{1,2} Koichi Miyake,¹ Atsushi Watanabe,¹ Sonoko Narisawa,³ José L. Millán,³ Yoshitaka Fukunaga,² Takashi Shimada.¹

¹Department of Biochemistry and Molecular Biology, Division of Gene Therapy Research Center for Advanced Medical Technology, Nippon Medical School, Tokyo, Japan; ²Department of Pediatrics, Nippon Medical School, Tokyo, Japan; ³Burnham Institute for Medical Research, La Jolla, CA.

Hypophosphatasia (HPP), caused by mutations of the tissue-nonspecific alkaline phosphatase (TNALP) gene, is an inherited systemic skeletal disease characterized by mineralization defects of bones and teeth. HPP is classified into five forms according to the age at diagnosis and the severity; perinatal, infantile, childhood, adult and odontohypophosphatasia. There is no established treatment at this moment, but several experimental approaches have been attempted to treat HPP model mice (*Akp2*^{-/-}) which phenotypically mimic to the severe infantile form of human HPP and die by two weeks of age. We have successfully treated HPP mice by repeated injection of bone-targeted TNALP which contains deca-aspartates at the C terminus (TNALP-D10), and we have recently reported that a single injection of lentiviral vector expressing TNALP-D10 during the neonatal period resulted in phenotypic correction and long-term survival of HPP mice. Clinical trials of enzyme replacement therapy using TNALP-D10 for infantile and adult forms of HPP have been just initiated. The perinatal HPP is the most severe form and usually die in utero or shortly after birth. In Japan, the lethal perinatal HPP is more common than in other countries and the fifth major disease among fetal-diagnosed skeletal dysplasias. The perinatal HPP can be diagnosed by prenatal ultrasound sonography, but there is no therapeutic option for this form. In this study, we investigated the feasibility of fetal gene therapy for lethal HPP model mice. On day 15 of gestation, fetal mice underwent transuterine intraperitoneal (IP) injection of AAV serotype 9 (AAV9). First, biodistribution of AAV9-GFP after fetal IP injection was studied using C57BL/6 mice. Histochemical detection of GFP and real time PCR of vector sequence at 8 weeks after birth revealed that AAV9 was widely distributed into many organs including heart, abdominal wall, skeletal muscle and liver. For gene therapy trials, the fetuses of HPP model mice were injected with AAV9 expressing TNALP-D10 (1×10^{11} viral genomes/fetus). HPP (*Akp2*^{-/-}) mice show failure to thrive from third or fourth day of life, develop epileptic seizure and cannot live longer than two weeks, while treated mice could achieve weight gain and seizure-free survival at least 8 weeks (versus 12 days for non-treated; n=3, p<0.001). ALP activity in plasma was elevated in the treated mice (0.016±0.006 U/ml in *Akp2*^{-/-} mice, 0.064±0.020 U/ml in *Akp2*^{+/+} mice, 3.50±1.51 U/ml in treated *Akp2*^{-/-} mice; n=3) and ALP activity was also shown in histochemical staining of the tibial bone. Enhanced mineralization was demonstrated by X-ray images of chest and fore paw. Our data clearly demonstrated that a systemic injection of AAV9 in utero is an effective strategy for treatment of lethal HPP mice. Fetal gene therapy may be an important choice after prenatal diagnosis of lethal perinatal HPP.

452. A Mouse Model To Test Liver-Targeted Therapies for MUT Methylmalonic Acidemia

Julien S. Sénac,¹ Justin R. Sysol,¹ Irini Manoli,¹ Randy J. Chandler,¹ Charles P. Venditti.¹

¹Genetic and Molecular Biology Branch, NHGRI, NIH, Bethesda, MD.

Methylmalonic acidemia (MMA) is caused by deficiency of the mitochondrial enzyme methylmalonyl-CoA mutase (Mut) and results in massive elevations of methylmalonic acid in tissues and body fluids. Studies in knockout mice (*Mut*^{-/-}) and transplanted MMA patients have suggested that a large portion of circulating methylmalonic acid derives from extrahepatic organs, mainly the skeletal muscle. To create an animal model that could be treated by hepatic- and renal-targeted cell and gene therapy throughout the lifespan, we generated mice that express the *Mut* gene under the control of an insulated, muscle-specific promoter (*Mut*^{-/-};Tg^{INS-MCK-Mut}). *Mut*^{-/-};Tg^{INS-MCK-Mut} mice were born in Mendelian proportions, showed greater than 83% survival past day of life 60, and demonstrated muscle-specific *Mut* RNA and protein expression. Although the mice are viable, they demonstrate severe growth retardation, achieving only 40-50% of their heterozygous littermates weight through the first year of life, have diminished oxidation of 1-¹³C propionate into ¹³CO₂, and display ~100 fold increased methylmalonic acid concentrations in the plasma compared to controls. As seen in *Mut*^{-/-} mice, the *Mut*^{-/-};Tg^{INS-MCK-Mut} animals also develop significant hepatic and renal pathology and are thus an attractive platform for testing liver-directed gene and cell therapy. In a proof-of-principle study, adult *Mut*^{-/-};Tg^{INS-MCK-Mut} mice were treated with a single systemic injection of 1×10^{11} genome copies of an rAAV8 expressing *Mut* under the control of a well-characterized liver-specific viral vector (rAAV8-TBG-mMut) to effect large scale hepatic transduction and direct tissue specific viral transgene expression. The rAAV8 treated *Mut*^{-/-};Tg^{INS-MCK-Mut} mice increased their body weight by 30% one week after injection and had marked improvement of disease-related metabolic parameters, including an increased capacity to oxidize 1-¹³C propionate into ¹³CO₂ (pre=10% to post=50%; p<0.01), and a significant decrease of plasma methylmalonic acid concentrations from 415 +/- 28.5 M (pre) to 162 +/- 11 M (post; p<0.0001). In addition to metabolic and growth improvement, rAAV8 gene therapy allowed treated *Mut*^{-/-};Tg^{INS-MCK-Mut} females to become, for the first time, pregnant and deliver viable pups. The *Mut*^{-/-};Tg^{INS-MCK-Mut} mouse model provides valuable insights into the pathology of MMA and confirms the importance of hepatic Mut function on disease manifestations. This model will enable the study of hepatic gene and/or cell therapy at varying ages throughout the mouse lifespan and the examination of both primary and secondary treatment-responsive disease biomarkers.

453. rAAV8 Gene Delivery Demonstrates Potential Efficacy as a Treatment of Cardiomyopathy in Propionic Acidemia

Randy J. Chandler,^{1,2} Nuria Carrillo-Carrasco,¹ Suma Chandrasekaran,¹ Patricia M. Zerfas,³ Charles P. Venditti.¹

¹Organic Acid Research Section, Genetics and Molecular Biology Branch, National Human Genome Research Institute, National Institutes of Health, Bethesda, MD; ²Department of Pharmacology, Institute for Biomedical Sciences, The George Washington University, Washington, DC; ³Diagnostic and Research Service Branch, Office of the Director, National Institutes of Health, Bethesda, MD.

Propionic Acidemia (PA) is an autosomal recessive disease caused by genetic defects in either the *PCCA* or *PCCB* genes, which code for the mitochondrial localized enzyme propionyl-CoA carboxylase. Affected individuals exhibit elevated levels of propionic acid and methylcitrate in their plasma and urine, and can present with

potentially lethal metabolic decompensations, hyperammonemia, neurological complications, and a potentially lethal cardiomyopathy. A murine model of PA, created by knocking out a portion of the *Pcca* gene, exhibits elevated levels of metabolites and neonatal lethality within the first 48 hours. We have previously demonstrated the ability of rAAV8 gene delivery to rescue the murine model of PA from lethality and decrease the levels of disease related metabolites. In light of the cardiomyopathy observed in patients with PA, the cardiac histology of the *Pcca*^{-/-} mice was examined to determine whether cardiac abnormalities are present. Histology revealed gross abnormalities of the cardiac tissue. However, *Pcca*^{-/-} mice treated by rAAV8 gene delivery of the PCCA gene did not exhibit histopathological changes of the cardiac tissue compared to wild-type mice. These results demonstrate the potential efficacy of rAAV8 gene delivery as an alternative treatment to transplantation for the potentially lethal cardiomyopathy observed in PA.

454. AAV Mediated Gene Transfer to Skeletal Muscle Results in Sustained Reduction of Hyperbilirubinemia in an Animal Model of Crigler-Najjar Syndrome Type 1

Nunzia Pastore,¹ Rosa Maria Sepe,¹ Francesco Vettrini,¹ Edoardo Nusco,¹ Alberto Auricchio,^{1,2} Nicola Brunetti-Pierri.^{1,2}
¹Telethon Institute of Genetics and Medicine, Naples, Italy;
²Pediatrics, Federico II University, Naples, Italy.

Crigler-Najjar syndrome is an autosomal recessive disorder characterized by severe unconjugated hyperbilirubinemia due to deficiency of the liver-specific uridine diphospho-glucuronosyl transferase 1A1 (UGT1A1). Current therapy relies on phototherapy to prevent life-threatening elevations of serum bilirubin levels but liver transplantation is the only permanent treatment. Given the mortality and morbidity related to the transplant procedures, there is high motivation at developing gene therapy for this disorder. Although correction of the deficient enzymatic activity in the affected organ, i.e. the liver, would be most straightforward, expression within an ectopic tissue to clear toxic metabolites from the circulation is very attractive. The muscle is the preferred tissue for this goal because of its simple and safe access through intramuscular (IM) injections. Moreover, the IM route has been investigated extensively for gene therapy of various diseases and in human clinical trials as well. In this study, we have investigated the efficacy of muscle-directed gene therapy for Crigler-Najjar syndrome type 1 using Adeno Associated Viral (AAV) vectors. A serotype 1 AAV vector expressing the UGT1A1 under the control of the muscle-specific creatine kinase (MCK) promoter was injected at the dose of 3x10¹² genome copies/kg into the muscles of one month-old Gunn rats, the animal model of Crigler-Najjar syndrome type 1. IM injections of AAV vectors resulted in the expression of functionally active UGT1A1 enzyme in the muscle as demonstrated by Western blot analysis and enzyme assay on muscle tissues. AAV-injected Gunn rats showed an approximately 50% reduction of baseline serum bilirubin levels by 3 weeks post-injection which were sustained for at least 1 year post-injection. Taken together, these data show that clinically relevant and sustained reduction of serum bilirubin levels can be achieved by simple and safe IM injections in the Gunn rats. AAV-mediated muscle directed gene therapy has potential for the treatment of patients with Crigler-Najjar syndrome type 1.

455. Neonatal Delivery of scAAV9-SMN: Impact of Disease Development in Two Models of Spinal Muscular Atrophy

Jacqueline Glascock,¹ Monir Shababi,¹ Christian Lorson.¹
¹Molecular Microbiology and Immunology and Veterinary Pathobiology, University of Missouri, Columbia, MO.

Spinal Muscular Atrophy (SMA), an autosomal recessive neuromuscular disorder, is the leading genetic cause of infant mortality. SMA is caused by the homozygous loss of Survival Motor Neuron-1 (SMN1). Despite its ubiquitous expression, low levels of full length SMN protein result in the preferential loss of lower motor neurons. It has been shown that replacement of SMN1 using viral vectors is a viable option for the rescue of motor neurons and the treatment of SMA in the delta 7 mouse model of SMA. In this study, we used self-complementary adeno-associated virus (scAAV) carrying SMN1 to compare two different routes of viral delivery in the delta 7 model. scAAV9-SMN1 was delivered to postnatal day 1 mice via intravenous (IV) or intracerebroventricular (ICV) injection. Both routes of scAAV9-SMN1 delivery resulted in a significant increase in lifespan and weight compared to untreated mice with a subpopulation of mice surviving more than 200 days. However, mice given ICV injections gained significantly more weight than their IV treated counterparts. Survival analysis shows that ICV treated mice displayed fewer early deaths than IV treated animals.

Figure 1

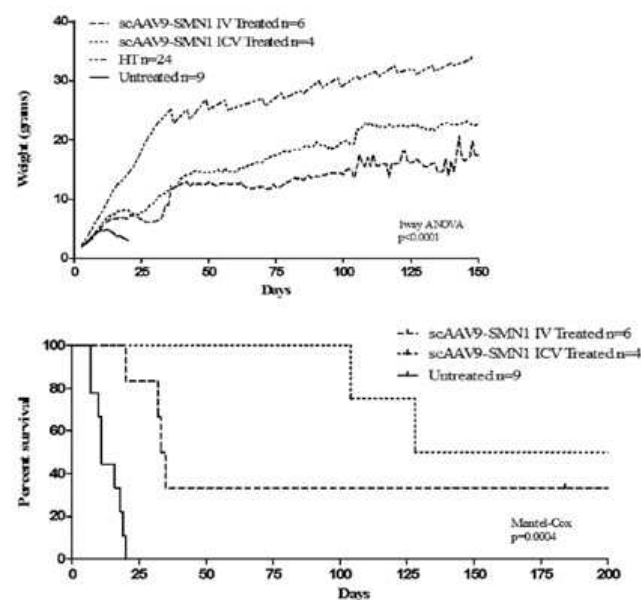

Preliminary results have shown that SMN protein levels in the brain and spinal cord of ICV treated animals are higher than SMN protein levels in IV treated animals. This study demonstrates that route of delivery is a crucial component of gene therapy treatment for SMA. These results prompted a study of this vector's (scAAV9-SMN1) ability to rescue a more severe model of disease. We now show that while lifespan is significantly improved in this more severe model, the inability to fully rescue suggests that either prenatal delivery is required or that the model is too severe to be fully rescued.

Figure 2

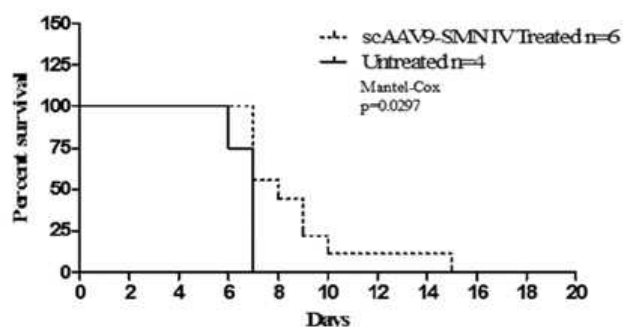

456. Successful Treatment of Hypophosphatasia Model Mice by a Single Intramuscular Injection of AAV Type 8 Vector Expressing Tissue-Nonspecific Alkaline Phosphatase

Tae Matsumoto,^{1,2} Koichi Miyake,¹ Noriko Miyake,¹ Hideo Orimo,³ Sonoko Narisawa,⁴ José Millán,⁴ Yoshitaka Fukunaga,² Takashi Shimada.¹

¹Department of Biochemistry and Molecular Biology, Division of Gene Therapy Research Center for Advanced Medical Technology, Nippon Medical School, Tokyo, Japan; ²Department of Pediatrics, Nippon Medical School, Tokyo, Japan; ³Division of Structural Biology and Metabolism, Department of Biochemistry and Molecular Biology, Nippon Medical School, Tokyo, Japan; ⁴Sanford Children's Health Research Center, Sanford-Burnham Medical Research Institute, La Jolla, CA.

Hypophosphatasia (HPP) is an inherited systemic skeletal disease characterized by a deficiency in tissue-nonspecific alkaline phosphatase (TNALP), which leads to abnormal mineralization of skeletal and dental tissues. Patients with the infantile form may appear normal at birth, however, the prognosis of this form is poor. Although enzyme replacement therapy or bone marrow transplantation was tried in these 30 years, there is no curative treatment for hypophosphatasia. Recently, it was demonstrated that TNALP knockout (*AKP2*^{-/-}) mice, which are good models for infantile form hypophosphatasia, could be treated by injection of a bone-targeted form of human TNALP in which a deca-aspartate sequence is linked to the C terminal end of soluble TNALP (TNALP-D10). We also reported that a single intravenous systemic injection of lentiviral or adeno-associated virus type 8 (AAV8) vectors expressing TNALP-D10 rescued neonatal knockout mice. However, the safety of a systemic injection of either lentiviral or AAV into neonates has not been established. In this study, to develop a more practical gene therapy for HPP, we examined the feasibility of AAV8 vector-mediated muscle directed gene therapy for neonatal HPP. Neonatal *AKP2*^{-/-} mice (n=6) were treated with a single intramuscular injection of AAV8-TNALP-D10 (1x10¹² vg/body). High level of plasma ALP activity (14.6 ± 4.5 U/ml) was then detected for more than one year, thereafter. X-ray analysis showed mature bone mineralization was detected in treated *AKP2*^{-/-} mice but not control AAV8 vector expressing GFP injected mice. Treated knockout mice lived for more than 1 year with normal physical activity and healthy appearance, while control mice died within 3 weeks. Ectopic calcification and abnormal calcium metabolism were not detected in treated mice. These findings suggest that AAV mediated intramuscular neonatal gene therapy is a highly practical option to cure the severe infantile form of HPP.

457. Successful Use of Lipoplex for Delivery of the Small Molecules ManNAc and Sialic Acid To Rescue Hyposialylation in a Mouse Model of Hereditary Inclusion Body Myopathy (HIBM)

Tal Yardeni,^{1,4} Carla Ciccone,¹ Shelley Hoogstraten-Miller,² Daniel Darvish,³ Yair Anikster,⁴ John Nemunaitis,^{5,6} Phil Maples,⁵ Chris M. Jay,⁵ William A. Gahl,¹ Marjan Huizing.¹

¹MGB, NHGRI/NIH, Bethesda, MD; ²OLAM, NHGRI/NIH, Bethesda, MD; ³HIBM Research Group, Encino, CA; ⁴Sackler Faculty of Medicine, Tel Aviv University, Tel-Aviv, Israel; ⁵Gradalis Inc., Dallas, TX; ⁶Mary Crowley Cancer Research Centers, Dallas, TX.

HIBM is an adult-onset, progressive neuromuscular disorder, caused by mutations in the ubiquitously expressed, key enzyme of sialic acid (SA) synthesis, UDP-GlcNAc 2-epimerase/ManNAc kinase, encoded by the *GNE* gene. We created an HIBM mouse model, mimicking the Persian-Jewish founder mutation. Mutant mice (-/-) unexpectedly died before day 3 of life (P3) from severe glomerulopathy due to hyposialylation. Renal findings included segmental splitting of the glomerular basement membrane, effacement of podocyte foot processes, and reduced sialylation of the major podocyte sialoprotein, podocalyxin. Oral administration of the SA precursor, N-Acetyl-D-mannosamine (ManNAc), yielded survival beyond P3 in 43% of the mutant pups. Then we assessed the efficiency and efficacy of ManNAc/SA delivery in liposomes (ManNAc-Lipoplex, SA-Lipoplex), and human *GNE* gene delivery in liposomes (*hGNE*-Lipoplex) in our HIBM mouse model. Newborn pups (P1) were retro-orbitally injected with ManNAc-Lipoplex, SA-Lipoplex or *hGNE*-Lipoplex. Mice were watched for clinical signs and survival beyond P3, and tissues were tested at P5 for sialylation, histology, glomerular disease and *hGNE* expression. *hGNE*-Lipoplex injections yielded no surviving -/- pups beyond P3, however, WT survivors showed *hGNE* expression in tested tissues at P5, indicating no toxicity of *hGNE*-Lipoplex and efficient gene delivery to tissues. Interestingly, -/- pups that died before P3 also showed *hGNE* expression in their tissues (as early as P2); treatment at P1 may not allow enough time for sufficient protein translation and SA production. In contrast, ManNAc-Lipoplex injections at P1 yielded survival beyond P3 in >90% of -/- pups. SA-Lipoplex yielded survival beyond P3 in >80% of -/- pups in contrast to SA in drinking water that didn't yielded any -/- pups surviving beyond P3. The surviving mutant pups showed improved glomerular histology and improved sialylation of glomerular sialoproteins at P5. ManNAc-Lipoplex treated -/- mice continued to live beyond weaning; the oldest mice are now 8 months. The development of a muscular phenotype in these mice, similar to the symptoms of HIBM, and the effects of ManNAc treatment on these symptoms can now be assessed. Our studies demonstrate: 1) retro-orbital injection in newborn mice is an efficient method for systemic delivery of compounds; 2) small molecules can be efficiently delivered in Lipoplex; 3) systemic delivery of a gene in Lipoplex yields gene expression in tissues after one day; 4) ManNAc-Lipoplex/SA-Lipoplex can be applied to increase sialic acid levels and systemic or intramuscular ManNAc-Lipoplex therapy should be considered for the treatment of patients with HIBM, and may also be considered for other disorders of hyposialylation (i.e., certain cancers, certain renal disorders).

458. Gene Therapy with Small Heat Shock Protein for Huntington Disease

Wuh-Liang Hwu,¹ Yu-May Lee,² Nathalie Clement,³ Ni-Chung Lee,¹ Barry Byrne.³

¹Medical Genetics, National Taiwan University Hospital, Taipei, Taiwan; ²Institute of Biological Chemistry, Academia Sinica, Taipei, Taiwan; ³Pediatrics, Powell Gene Therapy Center, University of Florida, Gainesville, FL.

Huntington disease (HD) is a late-onset neurodegenerative disease characterized by intranuclear and cytoplasmic aggregates and cell death in the striatal region. HD is caused by abnormal expansion of the trinucleotide (CAG) repeat sequence in exon 1 of the gene (*HTT*) encoding the huntingtin protein. Recently, heat shock proteins are identified as potential modulators of poly(Q) aggregation and/or cell death. More interestingly, the small heat shock proteins (sHsps) from human (Hsp27) and mouse (Hsp25) protect cells from heat shock and oxidative stress, and decrease apoptosis. Cells with expanded poly(Q) revealed reduced protein expression of HSP27. In this study, we use AAV1 vector to design a gene therapy for Huntington's disease. Intracerebral injection of AAV1 virus has been shown to give wide spread expression in mouse brain. We first injected 2×10^9 vg of scAAV1-CMV- mCherry to the putamen of control mice. Two week after injection, we could demonstrate widespread expression of red fluorescence on the injection hemisphere but not in the contralateral side. We then packaged AAV1-CMV-Hsp27 (1×10^{12} vg/ml). HD R6/2 mice were then injected with AAV1-CMV-Hsp27 (2×10^9 vg per site) or saline at bilateral putamens at 6 weeks of age. These animals were followed by rotarod analysis weekly. After 4 weeks post-injection, the treated mice showed poorer performance on rotarod than the mock-injected mice. It is possible that overexpression of the molecular chaperones may disturb normal protein turn over in the cells and then brings to untoward effects. It may be necessary to control the expression level in chaperone therapy in the future.

459. Gene Transfer of Constitutively Active Akt1 Increases Islet Cell Survival and Proliferation

Robert N. Bone,¹ Yuan Zhang,² Mert Icyuz,² Stacie M. J. Bryant,³ Henry K. Fortinberry,³ John A. Thompson,³ Gene P. Siegal,¹ Hongju Wu.⁴

¹Pathology, University of Alabama at Birmingham, Birmingham, AL; ²Medicine, University of Alabama at Birmingham, Birmingham, AL; ³Surgery, University of Alabama at Birmingham, Birmingham, AL; ⁴Ostetrics and Gynecology, University of Alabama at Birmingham, Birmingham, AL.

Type 1 Diabetes mellitus (T1D) is a metabolic disorder characterized by an absolute insulin deficiency due to the autoimmune destruction of insulin producing beta cells. Exogenous insulin therapy is the main treatment; however, it does not cure T1D. Islet transplantation is becoming a viable option to cure T1D. However, limited islet supply, inefficient islet recovery, and significant islet loss restrict the success of transplantation therapy. Therefore, a means to promote beta cell survival and proliferation is expected to offer therapeutic benefits. Akt1/PKB, a serine/threonine kinase that is the direct downstream target of PI3 kinase, has been shown to have anti-apoptotic function as well as inducing cell proliferation. Relevance of Akt1 to diabetes has been shown in transgenic mice expressing constitutively active Akt1 (CA-Akt1) and knockout mice lacking one form of Akt. On these basis, we hypothesize that gene transfer of CA-Akt1 into beta cells will promote beta cell survival and proliferation, thus can be protective to experimental diabetes. In this study, we generated a highly efficient and specific vector that can deliver CA-Akt1 into islet beta cells. The vector is based on a fiber-modified Ad5, Ad5RGDpk7, which has been shown to have enhanced infectivity for islet cells. In order to drive specificity to the pancreatic beta cells, the beta cell specific rat insulin promoter was used to control CA-Akt1 expression.

Our western blotting data have shown that this vector can efficiently deliver CA-Akt1 into islet cells in isolated human, rat and porcine islets. Islets transduced with the CA-Akt1 vector showed enhanced viability compared to control groups. Using BrdU incorporation assay, we found CA-Akt1 expression in the islet cells promoted beta cell proliferation. We also examined if CA-Akt1 expression could protect islet cells in vivo in streptozotocin-induced diabetic mice. Our data have shown the mice expressing CA-Akt1 exhibited better blood glucose control daily and following an single dose glucose challenge. We also found the pancreas of the CA-Akt1 treated mice contained more islets upon sacrifice. Taken together, our data suggest CA-Akt1 is effective in promoting beta cell survival and proliferation, thus has potential therapeutic use.

460. Helper-Dependent Adenoviral Vectors for Liver-Directed Gene Therapy of Primary Hyperoxaluria Type 1

Raffaele Castello,¹ Pasquale Piccolo,¹ Roberta Borzone,¹ Riccardo Sangermano,¹ Donna Palmer,² Philip Ng,² Nicola Brunetti-Pierri.^{1,3}

¹Telethon Institute of Genetics and Medicine, Naples, Italy; ²Molecular and Human Genetics, Baylor College of Medicine, Houston, TX; ³Pediatrics, Federico II University, Naples, Italy.

Primary hyperoxaluria type 1 (PH1) is an inborn error of liver metabolism due to deficiency of the peroxisomal enzyme alanine:glyoxylate-aminotransferase (AGT), which catalyzes the conversion of glyoxylate to glycine. AGT deficiency results in overproduction of oxalate which forms insoluble calcium salts that accumulate in the kidney and other organs which ultimately lead to end-stage renal disease and death. Organ transplantation as either preemptive liver transplantation or combined liver/kidney transplantation is the only therapeutic strategy available to prevent kidney failure. However, this treatment is associated with significant mortality and morbidity. Gene therapy is an attractive option to provide a definitive cure for PH1. Towards this goal, we are investigating helper-dependent adenoviral (HDAd) vectors for liver-directed gene therapy of PH1. HDAd vectors are very attractive for gene therapy because they are devoid of all viral coding sequences and result in efficient hepatocyte transduction and long-term transgene expression without chronic toxicity. We have injected PH1 mice with an HDAd encoding the AGT under the control of the liver-specific phosphoenolpyruvate carboxykinase (PEPCK) promoter and observed a sustained reduction of oxalate urinary excretion. Recently, we have developed a minimally invasive method to improve the therapeutic index of HDAd (Brunetti-Pierri et al., 2009). This approach based on balloon occlusion catheter to achieve preferential delivery of the vector to the liver, results in substantially higher efficiency of hepatocyte transduction using clinically relevant low vector doses and is accompanied by mild-to-moderate acute but transient toxicities. Therefore, this method of vector delivery may permits correction of PH1 using clinically relevant doses of HDAd and may thus pave the way to clinical application of HDAd for PH1 gene therapy.

461. Administration of Gene Therapy Improves Cholesterol Synthesis and Physical Outcome in a Mouse Model of Smith-Lemli-Opitz Syndrome (SLOS)

Lee Ying,¹ Xavier Matabosch,¹ Montserrat Serra,¹ Cedric Shackleton,¹ Gordon Watson.¹

¹Children's Hospital Oakland Research Institute, Oakland, CA.

Smith-Lemli-Opitz syndrome is an inborn error of cholesterol biosynthesis that results in a range of symptoms, including cognitive impairments, physical dysmorphia, and delayed growth. The biochemical cause is a defect in 7-dehydrocholesterol reductase (DHCR7), the enzyme that converts 7-dehydrocholesterol (7DHC) to

cholesterol. This results in cholesterol deficiency and accumulation of toxic precursors such as 7DHC in tissue and serum. The ratio of 7DHC to cholesterol is used to diagnose SLOS and in this study, to monitor the response to treatment. SLOS predominantly presents in Caucasian populations, with the incidence reportedly between 1:10,000 and 1:70,000 in northern and central Europe, and approximately 1:50,000 in the United States. The only approved treatment is dietary cholesterol supplementation, and while this has been shown to have positive biochemical and developmental benefits, preexisting defects are irreversible and prenatal treatment is ineffective. Gene therapy is a promising treatment that addresses many shortcomings of dietary cholesterol supplementation. In the present study, a recombinant type-2 adeno-associated virus (AAV2) vector carrying a human *DHCR7* cDNA and a heterologous promoter was packaged into a type-8 capsid vector (AAV2/8) and administered intravenously to newborn (3 days old) and juvenile (4 weeks old) SLOS mice to determine the efficacy of gene therapy as a treatment for SLOS. Newborns received a single dose of 4.5×10^{11} vector genomes while juveniles received 1.5×10^{12} . Both treatment regimens saw significant decreases in the 7DHC/C ratio in serum and liver compared to sham-treated controls. For the newborn cohort at 3 months of age, compared to sham-treated controls, the ratio of 7DHC/C in the liver was 50% lower, and the ratio in serum was 56% lower. For the juvenile treated cohort at 3 months, compared to sham-treated controls, the ratio of 7DHC/C in the liver was 53% lower and the ratio in serum was 55% lower. In neither case, however, were 7DHC/C ratios completely normalized. By three months of age treated SLOS mice still had vector in the liver and were still expressing human *DHCR7* mRNA as measured by qualitative and quantitative RT-PCR. Vector expression in mice treated as newborns was 42% higher than in mice treated as juveniles, suggesting that vector was not preferentially lost during the rapid growth between birth and weaning. SLOS mice are smaller than normal at birth and continue to grow at a reduced rate for an extended time, although they eventually approach a normal weight in 6 months to a year. Treatment of SLOS mice with the AAV vector increased the rate of growth. In terms of relative weight gain, treated mice in the juvenile cohort were 4 weeks ahead of their sham-treated littermates by the end of the experiment (3 months of age), while in the newborn cohort treated mice were 6 weeks ahead of their littermate controls. Thus, there was an improved physical outcome in addition to the improved rate of conversion of 7DHC to cholesterol. Together these results suggest that gene therapy holds promise for the treatment of SLOS and that early intervention would be beneficial.

462. Proliferative Adipocytes as Therapeutic Gene Vehicle toward Sustained Protein Replacement Therapy

Masayuki Kuroda,^{1,2,3} Sakiyo Asada,^{1,2,3} Yasuyuki Aoyagi,^{1,2,3} Shigeaki Tanaka,³ Shunichi Konno,³ Masami Tanio,³ Masayuki Aso,³ Yasushi Saito,⁴ Hideaki Bujo.²

¹Center for Advanced Medicine, Chiba University Hospital, Chiba University, Chiba, Japan; ²Department of Genome Research and Clinical Application, Graduate School of Medicine, Chiba University, Chiba, Japan; ³CellGenTech, Inc., Chiba, Japan; ⁴Chiba University, Chiba, Japan.

Adipose tissue is expected as a source of proliferative cells for cell-based therapy such as regenerative medicine and gene transfer applications. Most commonly used adipose tissue-derived cells are stromal vascular fractions (SVF), which is the sediment after collagenase digestion followed by centrifugation. Many studies demonstrated that SVF exhibits the differentiation potential for multi-lineage, suggesting the suitability for regenerative medicine. However, these data indicate that SVF are heterogeneous, and therefore imply that SVF may not result in stable therapeutic gene vehicle for gene therapy purpose. To solve this problem, we

propagated proliferative adipocytes by ceiling culture technique from mature adipocyte fraction, which is the floating fraction of above mentioned centrifugation, and designated the cells as ceiling culture-derived proliferative adipocytes (ccdPA). In this study, we focused on lecithin:cholesterol acyltransferase (LCAT) deficiency, one of inherited metabolic disorder caused by mutation in *lcat* gene, and evaluated ccdPA as a therapeutic gene vehicle for LCAT protein replacement therapy. By use of MoMLV-based amphotropic retroviral vector, ccdPA propagated by a 7-day ceiling culture resulted in a 40-50% transduction efficiency, with less than two integrated copies of viral genome per cell on average. The gene-transduced human ccdPA secreted functional LCAT protein, correlating with the integrated copy number of vector genome. Secreted LCAT protein clearly ameliorated the disturbed high-density lipoprotein subpopulation profile caused by impaired LCAT function in patient's serum by the *in vitro* incubation assay, strongly suggesting the feasibility of our strategy. The cells also retain the highly adipogenic potential in comparison to SVF even after consecutive *in vitro* passages. These results indicate that ccdPA are more homogeneous than SVF and suitable for stable gene transfer purpose. The gene-transduced cells could be expanded up to nearly 10^{12} cells from 1 g of fat tissue within one month after fat tissue preparation. The presence of therapeutic LCAT protein in serum was immunologically identified upon transplantation of the *lcat* gene-transduced ccdPA in mice model using clinically applicable fibrin scaffold. Thus, ccdPA would provide an excellent platform for developing a novel adipocyte-based protein replacement therapy of serum protein deficiencies who require long-term therapeutic protein supplements as well as LCAT deficiencies.

463. Knockdown of Genes Upstream of the Tyrosine Catabolic Pathway with siRNA Can Partially Rescue the Phenotype of Fah Mutant Mice

Changsheng Guo,¹ Zhongya Wang,¹ Sally Fitch,¹ Markus Grompe.¹
¹Pediatric, Oregon Health Sciences University, Portland, OR.

Deficiency of fumarylacetoacetate hydrolase (FAH) causes tyrosinemia type I (hepatorenal tyrosinemia, HT1) in humans and is characterized by severe liver dysfunction, renal tubular damage and liver cancer. In the murine model of HT1 hepatocytes stably expressing Fah have a strong selective growth advantage. Fah mutant mice are therefore uniquely suited for the study of the biology of integrating gene therapy vectors in the liver. We have succeeded in the synthesis of 2 potent small inhibitors of Fah, which work in mice *in vivo*. Because of the powerful selection found in genetic Fah deficiency, pharmacological inhibition of Fah may be a useful strategy for the *in vivo* selection of genetically modified hepatocytes. We are developing a generally useful system for *in vivo* selection of genetically modified hepatocytes by developing constructs that render hepatocytes resistant to Fah deficiency. There are 4 enzymes upstream of the Fah in tyrosine degradation pathway and blocking any of these should theoretically prevent the accumulation of FAA in Fah mutant. In the current study we constructed and tested the ability of vectors expressing shRNA against TAT and HPD, two of the 4 enzymes upstream of Fah. shRNA expression cassettes were inserted into a plasmid suitable for transposition by SB transposase. Plasmids were mixed with a hyperactive Sleeping Beauty transposase at a ratio of 25:1 with a total of 10 μ g and delivered by hydrodynamic injection consisted of a rapid injection of large volume (10% body weight) of plasmid DNA. For each experimental condition at least 4 mice were injected and selected for 3 months by going through 4 or 5 cycles of NTBC withdrawal. After the final cycle plasma and liver tissues were collected. Plasma samples were tested for liver functions and liver tissues were tested for GFP expression with IHC. During selection the body weights in each experimental group were measured every other day and compared with their initial body weight and the extent of loss to the controls. Hepatocytes from primary mice were

isolated and serially transplanted to Fah mutant mice in order to prove the stable integration of the siRNA constructs. We identified two TAT and one HPD siRNA constructs that could partially rescue Fah mutant mice. The mice injected with siRNAs showed improved liver functions and reduced body weight loss during NTBC withdrawal. Mice serially transplanted with hepatocytes from these mice also showed more tolerance to NTBC withdrawal and improved liver function. Conclusion: shRNA knockdown of TAT and HPD can render hepatocytes resistant to Fah deficiency and can serve in vivo selection genes.

464. Hematopoietic Differentiation of Airway Epithelial Cell-Derived Cystic Fibrosis (CF) Induced Pluripotent Stem (iPS) Cells

R. Geoffrey Sargent,^{1,5} Yanu Yang,⁵ Albert Lee,^{1,5} Marcus O. Muench,⁶ Soya Kim,⁵ Arash Bedayat,⁵ Layli Jamali,⁵ Lin Ye,³ Judy Chang,³ Dieter C. Gruenert.^{1,2,4,5,7}

¹Otolaryngology-Head and Neck Surgery, University of California, San Francisco, CA; ²Laboratory Medicine, University of California, San Francisco, CA; ³Medicine, University of California, San Francisco, CA; ⁴Eli and Edythe Broad Center for Regenerative Medicine and Stem Cell Research, Helen Diller Family Comprehensive Cancer Center, Institute for Human Genetics, University of California, San Francisco, CA; ⁵Cell Biology, California Pacific Medical Center Research Institute, San Francisco, CA; ⁶Blood Systems Research Institute, Department of Laboratory Medicine and Liver Center, University of California, San Francisco, CA; ⁷Medicine, University of Vermont, Burlington, VT.

CF is the most common inherited disease in the Caucasian population and has significant multiorgan damage that appears to compromise both epithelial and inflammatory cell function. The development of induced pluripotent stem (iPS) cells is a significant advance in the development of cell-based therapy that could benefit inherited diseases such as CF. The iPS cell system has the potential for generating patient-specific pluripotent stem (PS) cells that can ultimately be differentiated into tissue-specific precursor cells for repair of tissues and organs affected by the disease pathologies. CF-iPS cells were derived from airway epithelial cells of a patient with a $\Delta F508/\Delta F508$ genotype. These cells have been characterized for their pluripotent features including the expression of antigens associated with pluripotency (Nanog, SSEA3, SSEA4, Tra-1-60, Tra-1-81), as well as the ability to recapitulate the 3 primary germ layers (mesoderm, ectoderm, and endoderm) in vitro in embryoid bodies and in vivo as teratomas. Because CF pathology appears to manifest in inflammatory cells as well as epithelial cells, studies were undertaken to determine whether the CF epithelial cells could be differentiated into hematopoietic/inflammatory cell precursors. CF-iPS cells were grown under defined conditions and analyzed by FACS. The FACS analysis indicated the presence and co-expression of leukosialin (CD43) and the common leukocyte antigen, CD45 (CD43+CD45+) in a distinct subpopulation derived from the differentiation of the CF-iPS cells. Gene correction studies and kinetic analysis will be used to determine the corrected precursor population that gives rise to this more differentiated inflammatory cells population. This work is supported by funds from Cystic Fibrosis Research, Inc and Pennsylvania Cystic Fibrosis, Inc and NIH grant GM75111.

465. Quantitation of Transgene Expression with Isotope Dilution Mass Spectrometry

Michael J. Passineau,¹ Kalyan Paila,² Ramaz Geguchadze,¹ H. M. Skip Kingston.²

¹Cardiovascular Medicine, Allegheny-Singer Research Institute, Pittsburgh, PA; ²Chemistry, Duquesne University, Pittsburgh, PA.

Gene transfer studies are dosed according to a paradigm that assumes a constant relationship between the number of vector units delivered and the number of protein effector (transgene) molecules produced. Thus, gene therapy studies usually attempt to directly correlate physiological response to vector dose administered. Whereas this methodology has generally proven adequate for preclinical and even clinical gene therapy studies, an improved system would be one wherein vector dose, effector molecules expressed, and physiological endpoints could all be known with precision. Quantitation of transgene effector molecules may be very difficult, since many gene therapies are designed for diseases wherein the genetic defect is not a deletion but rather a mutation, meaning that the mutated endogenous protein may be virtually indistinguishable from the transgene effector molecule with immunological methods. This is of particular importance for our interest in gene therapy for Fabry disease, where required levels of the α -Galactosidase A (GLA) therapeutic are low, and difficult to distinguish from mutated endogenous GLA. We have designed a strategy, based upon Stable Isotope Dilution Mass Spectrometry (SIDMS) for protein quantitation that involves modifying the C-terminus of the GLA transgene with a strep-tag, allowing us to spike the sample with a known quantity of a strep-tagged isotopically enriched synthetic peptide mix that mimic the transgene as an internal standard and to co-purify the transgene; and the internal standard from a lysate of mouse liver following hydrodynamic gene delivery. This method is useful as a proof-of-principle due to the availability of the strep-tag for affinity purification. The concept could be extended to modify the C-terminus and/or N-terminus of a therapeutic transgene by the addition of as few as one amino acid, resulting in a mass shift of the tryptic amino acid sequence of the protein. In our example, tryptic digestion of GLA-strep-tag yields a C-terminal 24-amino acid peptide of mass 2733.4 Da. The isotopically-enriched internal standard, also a 24-amino acid (AA) C-terminal peptide with a mass upshift of +8 Da and total mass of 2741.4 Da. Both the 2733.4 Dalton peak and the 2741.4 Dalton peak were clearly identified by SIDMS and the 24-AA tryptic sequence tag was validated by Tandem MS or MS/MS spectrum of the mouse liver spiked with the isotopically enriched internal standard, allowing us precise quantitation of our strep-tagged GLA transgene.

465.5 Direct Gene Transfer with Compacted DNA Nanoparticles in Retinal Pigment Epithelial Cells: Expression, Repeat Delivery and Lack of Toxicity

Zongchao Han,¹ Adarsha Koirala,¹ Rasha Makkia,¹ Mark J. Cooper,² Muna I. Naash.¹

¹Department of Cell Biology, University of Oklahoma Health Sciences Center, Oklahoma City, OK; ²Copernicus Therapeutics Inc., Cleveland, OH.

The goal of this study is to evaluate the efficacy and safety profiles of single and multiple subretinal deliveries of compacted DNA nanoparticles (NPs). EGFP expression cassettes transcriptionally-controlled by the Vitelliform Macular Dystrophy 2 (VMD2) promoter were constructed as linear (L-eGFP) and circular (C-eGFP) DNA and compacted into rod-shaped neutral-charged NPs having a diameter of 8-11 nm in size using polyethylene glycol-substituted lysine 30-mers. The VMD2 promoter was used to specifically target retinal pigment epithelial (RPE) cells. Single or double 1 μ l subretinal injections of NPs or naked DNA (both at 4.3 μ g DNA/ml) were performed at postnatal (P) day 30 BALB/c mice, with the second injection at P60.

Uninjected and 1µl saline-injected animals were used as controls. After 6, 24 and 72 hrs post-injection (PI), mice were first evaluated for retinal function and then eyes were assayed for the expression of eGFP, pro-inflammatory cytokines, and neutrophil and macrophage markers. We found that eGFP mRNA became apparent at PI-24 hrs with levels being 45% higher in the NP-injected eyes compared to naked DNA. At PI-72, expression levels increased 3.6 fold and were 48% higher in the NP-treated eyes. Direct eGFP fluorescence imaging demonstrated that NPs specifically transfect RPE cells *in vivo* at higher efficiency than naked DNA and that eGFP appears as early as 24 hrs PI. EGFP was detected in the RPE cell layer. Compared with the naked DNA injected animals, where eGFP signals were found mainly in the injection area, the eGFP signals in NP injected animals were more widely distributed, both inside and outside of the injection bleb. At PI-24 hrs, there were no signs of induction of immune response in all experimental groups. Markers for neutrophils and macrophages were not up-regulated. Similar results were obtained for pro-inflammatory cytokines (IL-6, IL-1 β , TNF- α and INF- γ) from single or double subretinal injections. At PI-6 hrs from single and double injections, a transient uniform up-regulation of inflammatory responses were observed in all cohorts, including saline, as evaluated by immunohistochemistry, qRT-PCR and Bio-Plex, suggesting a temporary induction of a response to the injection procedure itself rather than to the delivered NPs. The time course and magnitude of eGFP expression were similar after the first and second injections. We conclude that this study demonstrates the safety and efficacy of NP-mediated RPE gene transfer following multiple subretinal administrations.

Musculo-skeletal Gene & Cell Therapy I

466. Evaluation of rAAV6-Microtrophin Expression Driven by a Highly Active Muscle Specific Regulatory Cassette in Dystrophic Mice and the Non-Human Primate

Guy L. Odom,¹ Glen B. Banks,¹ Quynh Nguyen,² Eric Finn,¹ James M. Allen,¹ Jacqueline Wicki,¹ Stephen D. Hauschka,² Jeffrey S. Chamberlain.^{1,2}

¹Neurology, University of Washington, Seattle, WA; ²Biochemistry, University of Washington, Seattle, WA.

Duchenne muscular dystrophy (DMD), the most common inherited muscle disorder of children, is caused by mutations within the dystrophin gene and results in progressive muscle wasting. Several genetic intervention strategies are under investigation, and progress towards clinical gene therapy with adeno-associated viral (AAV) vector delivered transgenes remains promising. Highly truncated dystrophin coding sequences have previously been shown to be therapeutic in small and large animal models of DMD following rAAV gene transfer. However, given the potential for deleterious cellular immune responses to dystrophin in human patients, particularly those with large deletions in the dystrophin gene, the capacity of utrophin (a dystrophin paralog) to act as a therapeutic transgene is of high interest. To this end, we provide a comparative regulatory element study evaluating microtrophin expression and functionality in the highly dystrophic mouse model (*mdx/utrn*^{-/-}). We also tested microtrophin expression in a large non-human primate, macaca nemistrina. *mdx/utrn*^{-/-} mice were injected intravenously with rAAV6/ microtrophin vectors, carrying either the ubiquitously active CMV or under control of a novel muscle specific promoter (MSP) containing modified versions of the M-creatine kinase enhancer and promoter. Treated mice, displayed alleviation of most of the pathophysiological abnormalities associated with muscular dystrophy and no significant differences were observed between animals treated with the two types of vectors. Importantly, the MSP vector demonstrated a clear lack of expression in non-muscle cell types both *in vivo* and *in vitro*. We

have also generated rAAV6 vectors that express a macaca nemistrina derived microtrophin. Intramuscular injection of this non-human primate utrophin vector demonstrated widespread expression along the sarcolemma of monkey myofibers, where it co-localized with endogenous dystrophin. Consistent with studies in mice, no evidence of a dominant negative effect of the utrophin expression in wild type macaca nemistrina muscles was observed. These studies reveal that microtrophin can function not only as a therapeutic transgene in dystrophic models, but it can also serve as a sensitive reporter gene to develop systemic gene delivery protocols in large animal models. These rAAV/microtrophin vectors can also serve as a test system for the potential immunogenicity of microtrophin. Preliminary studies on the potential immunogenicity of this delivery system will be presented.

467. RNAi Therapy for Dominant Limb Girdle Muscular Dystrophy Type 1A

Jian Liu,¹ Lindsay M. Wallace,^{1,3} Sara E. Garwick-Coppens,¹ Michael A. Hauser,⁵ Jerry R. Mendell,^{1,2,4} Scott Q. Harper.^{1,2,3}

¹Center for Gene Therapy, The Research Institute at Nationwide Children's Hospital, Columbus, OH; ²Department of Pediatrics, The Ohio State University College of Medicine, Columbus, OH; ³Molecular, Cellular, and Developmental Biology Graduate Program, The Ohio State University, Columbus, OH; ⁴Department of Neurology, The Ohio State University College of Medicine, Columbus, OH; ⁵Departments of Medicine and Ophthalmology, Duke University Medical Center, Durham, NC.

Limb Girdle Muscular Dystrophy (LGMD) refers to a group of 19 disorders characterized by progressive wasting and weakness of pelvic and shoulder girdle muscles. Commonly, patients require wheelchair assistance, and individuals with some forms of LGMD may also have cardiac and respiratory muscle involvement. Modest improvements in a relatively limited set of muscles may dramatically improve patients' quality of life, but there is currently no effective treatment for LGMD. Gene therapy approaches may hold promise as future LGMD treatments. Over the last two decades, the feasibility of using gene therapy to treat muscular dystrophy in general, and LGMD in particular, has improved, but previous strategies have almost exclusively focused on replacing defective or missing genes underlying recessive disorders. These gene replacement strategies are not feasible for treating dominant muscular dystrophies, including the 7 dominant forms of LGMD (called LGMD1). Instead, patients with dominant LGMD1 would likely benefit from reduction of their pathogenic alleles. The recent emergence of RNA interference (RNAi) as a powerful tool to suppress dominant disease genes provided a mechanism to accomplish this. In this study, we developed the first RNAi-based pre-clinical treatment for LGMD1A, which is caused by dominant mutations in one allele of the myotilin (MYOT) gene. We generated several MYOT-targeted artificial microRNAs (miMYOT) that significantly reduced mutant MYOT mRNA and protein *in vitro*. We then delivered our lead miMYOT sequence to the T57I transgenic mouse model of LGMD1A using AAV6 vectors, and data from treated mice were just obtained at the time of abstract submission. Three months post-injection, we found that miMYOT vectors, but not controls, significantly reduced soluble mutant MYOT protein to levels undetectable by immunohistochemical staining in transduced areas and the protein aggregates that characterize LGMD1A were either absent or very small in treated muscles. We are currently quantifying these obvious histopathological improvements, and are also determining whether our miMYOT vectors will similarly improve overall muscle weakness in T57I mice using whole muscle specific force assays. These studies represent important first steps toward translating targeted RNAi gene therapy approaches for LGMD1A, and may have broader implications. Importantly, since dominant myopathies arise from mutations in at least 37 different

genes that collectively affect ~1 in 2,400 to 3,200 individuals, our RNAi strategies could be adapted to impact a large class of dominant muscle disorders.

468. Fukutin-Related Protein Knock-Down by Systemic AAV9-shRNA Delivery or by Transgenic Knock-In Mutation Resulted in Similar Muscle and Heart Pathology of LGMD 2I

Chi-Hsien Wang,¹ Yiumo M. Chan,² Bin Xiao,¹ Chunping Qiao,¹ Ru-Hang Tang,¹ Hui Zheng,¹ Elizabeth Keramaris-Vrantsis,² Juan Li,¹ Peijuan Lu,² Qilong Lu,² Xiao Xiao.¹

¹Department of Molecular Pharmaceutics, Eshelman School of Pharmacy, University of North Carolina-Chapel Hill, Chapel Hill, NC; ²McColl-Lockwood Laboratory for Muscular Dystrophy Research, Neuromuscular/ALS Center, Carolinas Medical Center, Charlotte, NC.

Fukutin-related protein (FKRP) has been speculated as a putative glycosyltransferase. The mutations of the FKRP not only cause late onset and milder limb-girdle muscular dystrophy 2I (LGMD2I) without central nervous system defect, but also cause severe allelic diseases such as congenital muscular dystrophy 1C, Walker-Warburg Syndrome and muscle-eye-brain disease. Since FKRP knockout mice are embryonic lethal, alternative methods are explored to generate viable animal models that closely recapitulate LGMD2I clinical phenotypes. Previously, we successfully knocked down the FKRP expression in the hind limb muscles for 10 months post i.m. injection (mpj) and recapitulated pathological and histological signs of LGMD 2I. Here, we investigated two different methods, AAV9-mediated systemic delivery of shRNA to knock-down FKRP (FKRP KD) in normal mice and genitic knock-in of the FKRP L276I missense mutation (L276I KI), to see if we can establish representative LGMD 2I animal models. To evaluate both mice models, the dystrophic pathologies were monitored. Firstly, central nucleation was observed in quadriceps of the 4 months old homo FKRP L276I KI mice. For the FKRP KD mice, it would only be found at 9 mpj. Glycosylation of the α -dystroglycan was reduced in the quadriceps of both groups at 9 months. We also found abnormal electrocardiogram (ECG) in the FKRP KD group, i.e., cardio conduction abnormality (left bundle branch block, LBBB) but there was no significant change in heart functions, e.g., percent of ejection fraction (EF%): 54.2 \pm 5.9 vs control: 54.0 \pm 1.6. Differently, the homo FKRP L276I KI mice showed both LBBB and right bundle branch block (RBBB). Furthermore, heart function impairment was revealed by echocardiography (Echo), i.e. significant decreases in EF% and percentage fractional shortening (FS%) in homo FKRP L276I KI mice (EF%: 73.7 \pm 10.5 vs. control 82.3 \pm 3.6; FS%: 42.5 \pm 8.4 vs. control 49.6 \pm 3.8). The echo readings of left ventricular internal dimensions in diastole (LVIDd) and systole (LVIDs) were also significantly increased in homo FKRP L276I KI mice (LVIDd: 3.3 \pm 0.4 vs. control: 2.8 \pm 0.3; LVIDs: 1.9 \pm 0.5 vs. control: 1.5 \pm 0.2), indicating dilated left ventricle. Moreover, the LV volumes in end-systole (LV-Vol; d), end-diastole (LV-Vol; s), and mass were significantly increased in homo FKRP L276I KI mice (LV-Vol; d: 44.0 \pm 12.9 vs 30.0 \pm 6.4; LV-Vol; s: 12.6 \pm 8.0 vs 5.9 \pm 1.8; LV Mass: 91.6 \pm 14.9 vs 75.2 \pm 14.4), suggesting enlarged left ventricle. In summary, using two different methods to reduce the FKRP expression in mice, we have obtained similar LGMD2I phenotypes. But an earlier onset of myopathies and severe heart failure were found in homo FKRP L276I KI mice. These animal models should be useful in studying LGMD 2I pathology as well as development of therapeutic approaches, such as gene therapy.

469. Regeneration of Large Segmental Bone Defects by Implantation of Gene Activated Fat Tissue

Volker M. Betz,¹ Oliver B. Betz,² Peter Augat,³ Stefan Rammelt,¹ Hans Zwipp.¹

¹Trauma Surgery, Technical University of Dresden, Dresden, Germany; ²Orthopedic Surgery, University of Munich, Munich, Germany; ³Institute for Biomechanics, Trauma Clinic Murnau, Murnau, Germany.

Background and Aim: The repair of bone defects can be induced experimentally with bone morphogenetic protein (BMP) producing fat-derived stem cells. However, this ex vivo gene therapy method requires the isolation and long-term culture of autologous cells which makes this approach expensive and time consuming. Therefore, we developed an expedited, cost-effective strategy for bone regeneration based on the use of gene activated fat tissue grafts. The goal of this study was to evaluate the repair of large segmental bone defects in rat femora after implantation of BMP-9 gene activated fat tissue. **Methods:** Fat tissue was harvested from 2 of 20 male Fischer 344 rats used for this study. The fat tissue fragments were incubated with an adenoviral vector carrying the cDNA encoding BMP-9 or they remained unmodified. According to their group affiliation, the segmental femoral bone defects of 18 rats were filled press fit with either BMP-9-activated fat tissue or unmodified fat tissue. An empty defect group and a group receiving fat tissue transduced with a non-osteogenic marker gene were not included since we have demonstrated in previous studies that these groups don't heal. Femora were evaluated by radiographs, microcomputed tomography, biomechanical torsional testing, and histology. **Results and Conclusion:** Radiographically and histologically, femora treated with BMP-9-activated fat grafts were bridged at 6 weeks after surgery. Bone volume and biomechanical stability of the femora of this group was similar to those of intact, contralateral femora. Control defects treated with unmodified fat tissue were filled with fibrous and adipose tissue, as evaluated by histology. The use of BMP-9 gene-activated fat tissue grafts represents an expedited and effective bone repair strategy that does not require the extraction and expansion of stem cells.

470. Site Directed Gene Repair of the Dystrophin Gene in Satellite Cells Mediated by PNA-ssODNs Restores Dystrophin Expression into Skeletal Muscles of a Mouse Model for Duchenne Muscular Dystrophy

Farnoosh Nik-Ahd,¹ Refik Kayali,¹ Carmen Bertoni.¹

¹Department of Neurology, University of California Los Angeles, Los Angeles, CA.

Gene editing mediated by single stranded oligodeoxynucleotides (ssODNs) has shown to be able to correct single point mutations and to restore dystrophin expression in several models for Duchenne muscular dystrophy (DMD). This technology takes advantages of specific repair mechanisms present in the cells that are able to recognize the presence of mismatches in genomic DNA. Oligonucleotides complementary to the target sequence but containing a mismatch at the base targeted for modification are used as templates for the correction process. Once introduced into the cell, they have been shown to anneal to the genomic DNA sequence targeted for repair and initiate the repair process leading to a single nucleotide exchange that is stably inherited throughout cell division. We have recently demonstrated that ssODNs made of peptide nucleic acid (PNA-ssODNs) are more effective in inducing single base alterations than oligonucleotides made of unmodified bases in muscle cells in culture as well as into skeletal muscle of dystrophin deficient mice. For therapeutic applications, gene correction strategies mediated by oligonucleotides are likely to require targeting not only mature

myofibers, but also muscle progenitor cells also known as satellite cells (SC) that actively participate to muscle regeneration and repair. We have tested the ability of PNA-ssODNs to correct the dystrophin gene defect in SC of the *mdx^{scv}* mouse. This strain has a point mutation in exon 10 of the dystrophin gene that creates a cryptic splice site for the dystrophin mRNA and is particularly useful to perform quantitative analysis of gene correction frequencies at both the mRNA and the genomic DNA levels. SC isolated from *mdx^{scv}* muscles were transfected with correcting PNA-ssODNs targeting the non-coding strand of the dystrophin gene defect and transplanted into skeletal muscles of immunosuppressed dystrophin deficient mice. As control, we used PNA-ssODNs lacking the mismatch. Restoration of dystrophin expression was assessed *in vitro* at the mRNA and protein levels. Gene correction was demonstrated at the genomic level by direct sequencing of PCR products derived from cells transfected with targeting oligonucleotides and maintained in culture. Dystrophin was clearly detected in muscles that received *mdx^{scv}* SC transfected with the correcting oligonucleotide but not in muscles transplanted with SC treated with control PNA-ssODNs. Expression of dystrophin was stable for up to six months after transplantation as demonstrated by immunostaining and western blot analyses. These results support the use of PNA-ssODN as a viable gene editing tool for the treatment of muscle diseases due to point mutations using cell-mediated regenerative approaches. Supported by a grant from the Muscular Dystrophy Association of the United States (MDA)

471. Losartan Enhances the Success of Myoblast Transplantation

Raouia Fakhfakh,¹ Yann Lamarre,¹ Daniel Skuk,¹ Jacques P. Tremblay.¹

¹Human Genetics Unit, Chul-Chuq, Quebec, QC, Canada.

Duchenne muscular dystrophy is a recessive X-linked genetic disease caused by dystrophin gene mutations. Cell therapy can be a potential approach aiming to introduce a functional dystrophin in the dystrophic patient myofibers. However, this strategy produced so far limited results. Transforming growth factor β (TGF- β) is a negative regulator of skeletal-muscle development and is responsible for limiting myogenic regeneration. The combination of TGF- β signaling inhibition with myoblast transplantation can be an effective therapeutic approach in dystrophin deficient patients. Our aim was to verify whether the success of human myoblast transplantation in immunodeficient dystrophic mice is enhanced with losartan, a molecule that down-regulates TGF- β expression. *In vitro*, blocking TGF- β activity with losartan increased proliferation and fusion and decreased apoptosis in human myoblasts. *In vivo*, human myoblasts were transplanted in mice treated with oral losartan. Immunodetection of human dystrophin in *Tibialis anterior* cross-sections 1 month post-transplantation revealed more human dystrophin-positive myofibers in these mice than in non-treated dystrophic mice. Thus blocking the TGF- β signal with losartan treatment improved the success of myoblast transplantation probably by increasing myoblast proliferation and fusion, decreasing macrophage activation and changing the expression of myogenic regulator factors.

472. The Polyproline Site in Hinge 2 of Microtrophin Does Not Lead to Structural Abnormalities like That for Microdystrophin

Glen B. Banks,¹ Guy L. Odom,¹ Eric E. Finn,¹ Jeffrey S. Chamberlain.¹

¹Department of Neurology, University of Washington, Seattle, WA.

Duchenne muscular dystrophy (DMD) is a progressive muscle wasting disease caused by mutations in dystrophin. A potential therapeutic option for DMD is delivery of rationally designed truncated (micro) dystrophins using recombinant adeno-associated

virus serotype 6 (rAAV6). However, there remains a possibility that immune responses against dystrophin could develop in some patients that would lead to elimination of transduced myofibers. Gene delivery of utrophin, a paralogue of dystrophin, may be able to circumvent this T-cell mediated immune response. The truncated utrophin (microtrophin^{AR4-R21/ACT}) that we previously designed was based on that of microdystrophin^{AR4-R23/ACT}. We had previously demonstrated in mice that microdystrophins carrying a polyproline site in hinge 2 could lead to the development of structural abnormalities in limb muscles, including small myofibers, myotendinous strain injury, ringed fibers and abnormal neuromuscular synapses. We improved the microdystrophin design by substituting hinge 2 for hinge 3 (PLoS Genetics, 2010). Here we examined whether the hinge structure of microtrophin^{AR4-R21/ACT} had a similar impact on transduced myofibers of dystrophic mice. We found that the polyproline site was conserved in hinge 2 of microtrophin^{AR4-R21/ACT}. However, microtrophin^{AR4-R21/ACT} could mitigate muscle degeneration in *mdx* mice without leading to myotendinous strain injury or ringed fibers. Microtrophin^{AR4-R21/ACT} was able to prevent synapse fragmentation, but was unable to completely restore the synaptic folds. Microtrophin^{AR4-R21/ACT} also led to muscle fiber hypertrophy and pronounced sarcolemmal festoons. Thus, the polyproline site did not adversely influence the function of microtrophin^{AR4-R21/ACT} like that for microdystrophin^{AR4-R23/ACT}.

473. Long-Term Engraftment of Mesenchymal Stromal Cells That Can Differentiate To Form Myogenic Cells in Dog with Duchenne Muscular Dystrophy

Yuko Nitahara Kasahara,¹ Hiromi Hayashita Kinoh,¹ Hironori Okada,¹ Jin-Hong Shin,¹ Akiyo Nishiyama,¹ Sachiko Ohshima Hosoyama,¹ Michiko Wada Maeda,¹ Akinori Nakamura,¹ Takashi Okada,¹ Shin'ichi Takeda.¹

¹Department of Molecular Therapy, National Institute of Neuroscience, National Center of Neurology and Psychiatry, Kodaira, Tokyo, Japan.

Background: Duchenne muscular dystrophy (DMD) is an incurable genetic disease with early mortality. Multipotent mesenchymal stromal cells (MSCs) could be potential therapeutics, because they can be transplanted to muscle tissue and differentiated to form myogenic cells *in situ*. We developed the strategies for effective cell transplantation in dystrophic dog. Methods: Canine CD271-positive (+) MSCs obtained from donor bone marrow cells were enriched by immunomagnetic isolation. The dog leukocyte antigens (DLA) were analyzed to determine DLA- identical mating pairs to achieve donor or recipient of allogeneic transplantation. Cardiotoxin (CTX) was injected into tibialis anterior (TA) muscles of normal Beagle dog 5 days before MSCs injection. CD271⁺ MSCs (2x10⁶ cells) transduced with an adenoviral vector expressing MyoD (Ad-MyoD) were injected into the TA muscles of recipient canine X-linked muscular dystrophy in Japan (CXMD) without immunosuppression. For intra-arterial injection, MyoD-transduced CD271⁺ MSCs (5x10⁶ cells) were administered into the femoral artery with transient avascularization using a tourniquet followed by the injection of papaverin hydrochloride. The treated muscles were biopsied and analyzed histologically. Autologous CD271⁺ MSCs (2x10⁶ cells) were transduced with AAV-microdystrophin and administrated into the TA muscles of DMD dog. Results: CD271⁺ MSCs obtained from the normal Beagle dog showed greater growth expansion compared with CD271-depleted MSCs. MyoD transduction of CD271⁺ MSCs caused myogenic differentiation *in vitro* and myotube formation with late myogenic markers expression. Without immunosuppression, CD271⁺ MSCs in the myogenic cell lineage were transplanted into DLA-identical CXMD, and formed clusters of muscle-like tissue at 8 and 12 weeks after the intra-muscular injection. The engraftment of CD271⁺ MSCs was also found at the site of CTX-injured muscle after

the intra-arterial injection. Interestingly, CD271⁺ MSCs engraftment was improved with the pre-treatment of papaverin hydrochloride. Immunohistological analysis suggested that CD271⁺ MSCs formed muscle-like tissues and exhibited upregulation of developmental myosin heavy chain as well as dystrophin without inflammatory cell infiltration. Furthermore, CD271⁺ MSCs derived from CXMD₁ also showed myotube formation *in vitro* by the expression of microdystrophin. We are currently conducting the transplantation of AAV-microdystrophin-transduced autologous MSCs into the CXMD₁ and will discuss the effects. Conclusion: MyoD-transduced CD271⁺ MSCs enabled more efficient realization of MSCs transplantation by the intra-muscular as well as intra-arterial injection. This strategy of MSCs propagation and treatment would be promising for the future DMD cell therapy.

474. Gene-Targeted Osteogenesis Imperfecta iPSCs Express Normal Collagen and Produce Bone after Mesenchymal Differentiation

David R. Deyle,¹ Iram F. Khan,¹ Gaoying Ren,¹ Peirong Wang,¹ Ulrike Schwarze,² Jordan Kho,³ Peter H. Byers,^{1,2} David W. Russell.¹

¹Department of Medicine, University of Washington, Seattle, WA;

²Department of Pathology, University of Washington, Seattle, WA;

³Program in Developmental Biology, Baylor College of Medicine, Houston, TX.

Osteogenesis Imperfecta (OI) is a common genetic disorder caused by dominant negative mutations in type I collagen genes, COL1A1 and COL1A2. We previously showed that an AAV vector can disrupt the dominant-negative mutant alleles in mesenchymal stem cells (MSCs) from individuals with severe OI by targeted insertion of a floxed IRES-Neo selection cassette and that the floxed IRES-neo cassette could be removed by Cre-mediated excision. However, we have found that gene-targeted MSCs that underwent Cre-mediated transgene removal had reduced proliferative capacity, limiting their clinical utility. Here we show that adeno-associated virus (AAV)-mediated gene targeting vectors can inactivate the mutant collagen gene in MSCs from OI patients and that these targeted MSCs can be reprogrammed into induced pluripotent stem cells (iPSCs) that can be expanded and differentiated into mesenchymal stem cells (iMSCs). To produce gene-targeted iPSCs, MSCs from OI patients were infected with AAV gene-targeting vectors, selected in G418, and pooled into polyclonal populations. G418-resistant MSCs were transduced with either 4 lentiviral reprogramming vectors or a floxed foamy viral (FV) reprogramming vector, and subsequent iPSC colonies were isolated and expanded. Based on Southern blot analysis, 3 of 4 iPSC clones were targeted at the COL1A1 locus and 16 of 21 iPSC clones were targeted at the COL1A2 locus. Sequencing of cDNA isolated from iPSC-derived embryoid bodies determined that both the mutant wild-type allele had been targeted and karyotype analysis showed that 2 of the 4 lines analyzed had normal cells. Gene-targeted iPSC lines expressed pluripotency genes and two lines were shown to have trilineage developmental potential during teratoma formation. iPSCs targeted at the mutant allele were differentiated *in vitro* to generate iMSCs that produced normal collagen. Differentiation studies showed that targeted iMSCs could form bone *in vitro* and *in vivo*. Cellular senescence and proliferation assays demonstrated that iMSCs were less senescent than gene-targeted MSCs. Also, iPSC clones generated using the floxed FV vector that were transiently exposed to Cre recombinase underwent removal of the IRES-neo targeting cassette and integrated FV genome leaving only the deleted LTR sequence behind, thereby creating transgene-free, gene-targeted iPSCs. Here we show that the combination of gene targeting and iPSC derivation can be used to produce a potentially therapeutic population patient-specific cells for transplantation. This approach not only could be applicable to OI, but to other genetics disorders as well.

475. Recombinant AAV6 Fails to Effectively Transduce Satellite Cells *In Vivo*

Patryk Konieczny,¹ Andrea Arnett,¹ Julian N. Ramos,¹ Zipora Yablonka-Reuveni,² Jeffrey S. Chamberlain.¹

¹Neurology, University of Washington School of Medicine, Seattle; ²Biological Structure, University of Washington School of Medicine, Seattle.

Recombinant AAV (rAAV) vectors are derived from non-integrating parvoviruses whose genomes are maintained in the host cell in the form of an episomal DNA. rAAV6 transduces muscle tissue with particularly high efficiency and, in the absence of immunity, leads to persistent expression of delivered genes for the lifetime of the muscle fiber. However, while wild-type muscles display numerous mature myofibers and little ongoing regeneration, dystrophic muscles have large numbers of activated and proliferating stem cells (satellite cells), and myofibers that are at different regenerative stages, which presumably differ in their surface receptors for rAAV6. As such, dystrophic muscles might be more difficult to target with rAAV6 than non-diseased tissues. In the present study, we employed a notexin-induced muscle regeneration system, single fiber-derived satellite cell cultures and MM14 myoblast cultures to ask whether muscle cells can be transduced with rAAV6 with similar efficiency during different stages of myofiber formation and regeneration. We show that both satellite cells and myoblasts can be transduced with rAAV6 *in vitro*, however less effectively than multinucleated myotubes. Sporadic transduction of satellite cells with rAAV6 was also seen *in vivo*. However, once satellite cells were activated and started to proliferate, the expression of the reporter gene was lost, presumably due to loss of the episomal vector DNA. In contrast, highly effective and stable transduction of muscles was observed once myotubes were formed. These data show that while rAAV6 is a useful therapeutic tool to treat skeletal muscles in muscular dystrophies, its application is limited to the delivery of genes into non-proliferating multinucleated myotubes and myofibers.

476. Molecular Treatment of Muscle Atrophy Caused by Focal Nerve Injury

Gabriela A. Niizawa,^{1,4} Hiroyuki Nakai,² Bing Wang,^{1,3} Paula R. Clemens.^{1,2,4}

¹Department of Neurology, University of Pittsburgh, Pittsburgh;

²Department of Microbiology and Molecular Genetics, University of Pittsburgh, Pittsburgh;

³Department of Orthopedic Surgery, University of Pittsburgh, Pittsburgh;

⁴Neurology, Department of Veterans Affairs Medical Center, Pittsburgh.

Muscle wasting due to nerve damage or dysfunction is a common clinical problem. Common causes of muscle loss include nerve injury, trauma, or compression. Although the primary disease process causing nerve injury, denervation, can be addressed or managed, the functional result may persist as a consequence of poor muscle repair or regeneration. The ability to promote muscle regeneration could provide significant clinical benefit. Molecular strategies such as gene transfer can promote muscle to regenerate, thus improving muscle bulk and strength as well as functional activity. The role of nuclear factor kB (NF-kB) in diverse causes of muscle atrophy has been extensively studied in cell culture and animal models. Pathologic NF-kB activation is sufficient to cause skeletal muscle atrophy because activated NF-kB inhibits formation of new muscle and enhances breakdown of existing muscle. However, the role of NF-kB activation in peripheral nerve trauma has been addressed in a more limited way. We established a murine model of muscle atrophy induced by sciatic nerve transection. Our preliminary results demonstrate that nerve transection causes a reduction in muscle weight and pathological changes including decreased muscle fiber diameter and increased numbers of muscle fibers with centrally placed nuclei in gastrocnemius and tibialis anterior muscle compared

with the sham-operated, contralateral control hind limb. Using the electromobility shift assay, we observed elevated levels of NF- κ B activation in denervated muscles due to sciatic nerve transection. We hypothesize that treatments aimed at decreasing pathological NF- κ B activation in muscle will ameliorate muscle atrophy caused by nerve injury. Therefore, we have developed serotype 8 adeno-associated viral vectors (AAV8) carrying various expression cassettes designed to inhibit pathological NF- κ B activation. We generated a vector carrying IkBSR, an engineered form of IkB α with point mutations that prevent the phosphorylation of IkBSR and keeps NF- κ B in its inactive state. We also generated a vector carrying cFLIP, which inhibits FADD activation of caspase 8 in the apoptosis pathway. We have shown that this vector inhibits NF- κ B activation in skeletal muscle. The promoter included in these AAV8 vectors is the truncated muscle creatine kinase (tMCK) to restrict recombinant gene expression to muscle. Because of the relatively short length of the tMCK promoter and the candidate gene sequences, we were able to employ a self-complementary AAV vector genome that has been shown to result in increased transgene expression level. These vectors will be tested for their ability to inhibit NF- κ B activation in skeletal muscle in the animal model of peripheral nerve injury and thus, we will explore the potential to develop treatments for peripheral nerve injuries that may further yield insights into the treatment of muscle atrophy in general.

477. AAV-5 Maximizes Growth Factor Transgene Expression and Differentiated Function in Chondrocyte Monolayer and Suspension Culture

Alan J. Nixon,¹ Laila Begum,¹ Kyla O. Ortved.¹

¹Comparative Orthopaedics Laboratory, Cornell University, Ithaca, NY.

Gene enhanced chondrocyte implantation improves cartilage repair. Viral vectors, particularly AAV, lengthen transgene expression to months, and limit the immune reaction surrounding viral transduction. Serotypes used in articular tissues vary from AAV-2, AAV2.5, AAV-3, and AAV-5. AAV-2 has been favored for chondrocyte transduction. Less is known about other AAV serotypes and the capsid pseudotypes. This study compared AAV-2 and AAV-5 for chondrocyte transduction efficiency and persistence, and effect of IGF-1 on cartilage matrix formation. scAAV2-eGFP, scAAV5-eGFP, scAAV2-IGF, and scAAV5-IGF vectors were used. Chondrocytes were isolated from horses 6-10 months old, and transduced with varying vg AAV-2 or AAV-5, and cultured in monolayer and suspension culture for up to 60 days. Relative population of GFP labeled chondrocytes in the cultures was determined by fluorescent microscopy. RNA was isolated at 2 and 4 wks, and collagen type II, aggrecan and IGF-1 gene expression determined by qPCR. Chondrocytes from 3D culture at 2 and 4 wks were sectioned for immunofluorescence detection of collagen type II. Concentrations of IGF-1 and collagen type II in the culture supernatants were determined by ELISA. AAV5-GFP resulted in more rapid expression of GFP in monolayer cultures, compared to AAV2-GFP. Additionally, expression persisted for longer. To better address expression over time, chondrocytes were transduced with AAV2-GFP or AAV5-GFP and cultured for 60 days in suspension culture on polyHEMA plates. AAV5 resulted in better expression of GFP which persisted longer than AAV2 transduced nodules. AAV-IGF-1 studies showed similar patterns of IGF-1 abundance in AAV5-IGF exposed cultures. In monolayer, IGF expression increased with increasing AAV5 vg/cell. Similar changes were evident in 3D cultures, with AAV5-IGF resulting in superior IGF expression. Longer term cultures, confirmed AAV5-IGF resulted in better IGF expression and peptide abundance than AAV2-IGF.

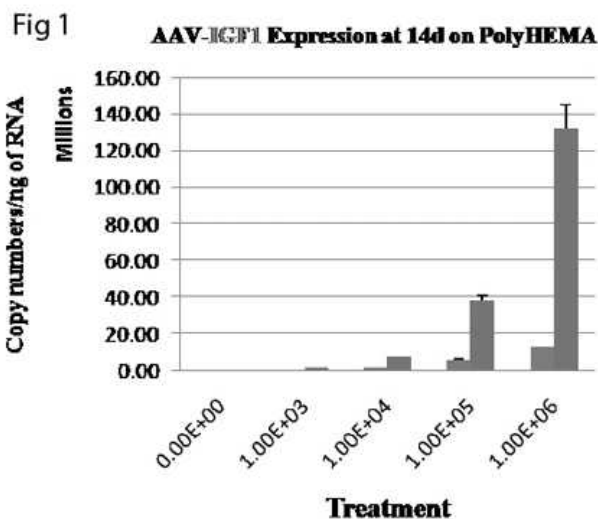

Collagen type II and aggrecan expression declined in monolayer cultures, but were maintained better in moderate dose ranges of AAV-IGF-1 in 3D culture. Collagen type II content in chondrocyte cultures was increased by higher doses of AAV2 and AAV5-IGF1.

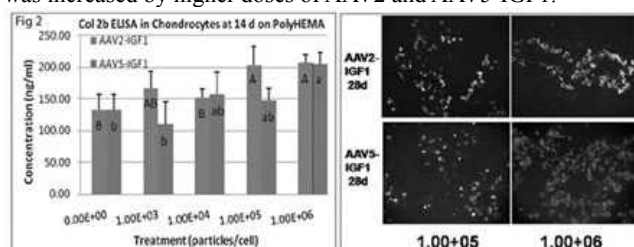

Aggrecan increases were evident in monolayer and suspension cultures after IGF-1 gene transduction. In summary, AAV5 is more efficient than AAV2 for gene delivery to chondrocytes. Transgene expression persisted longer, and supported chondrocyte specific matrix formation. AAV5-IGF vg/cell of 10^4 and 10^5 seem ideal to commence in vivo assessment.

478. Muscle Directed Gene Therapy with Capsid Modified Helper-Dependent Adenoviral Vectors

Kilian Guse,¹ Gautam Sule,¹ Masataka Suzuki,¹ Vincenzo Cerullo,² Akseli Hemminki,² Brendan Lee.¹

¹Department of Molecular and Human Genetics, Baylor College of Medicine, Houston, TX; ²Cancer Gene Therapy Group, University of Helsinki, Helsinki, Finland.

Adenoviral vectors are widely used in gene therapy, especially for liver-directed gene transfer approaches because of their high transduction efficiency in this tissue. The limiting factor of this approach is dose dependent acute toxicity, which is observed following intravenous administration of adenoviral vectors. Skeletal muscle represents an alternative target tissue for adenoviral gene therapy as a production platform for systemic expression of therapeutic proteins and for treatment of muscle disorders. Most importantly, intramuscular administration of adenoviral vectors is not associated with acute toxicity. However, wild type adenovirus serotype 5 vectors do not efficiently transduce adult muscle tissue because of low CAR expression on myotubes. Therefore, we evaluated whether capsid modified adenoviral vectors not dependent on CAR mediated cell entry show increased transduction in murine muscle tissue and whether helper-dependent adenoviral vectors with these capsid modifications could mediate long-term gene expression. First generation adenoviral serotype 5 vectors featuring the serotype 3 knob

(Ad5/3) and serotype 5 vectors with an RGD motif in the knob showed approximately 10-fold increased transduction compared to wildtype controls on myotubes *in vitro*. However, only Ad5/3 demonstrated increased transduction *in vivo* in muscle tissue of adult mice. Based on these data, we constructed helper-dependent adenoviral vectors featuring the 5/3 capsid modification, which demonstrated approximately 3-fold enhanced transduction *in vivo* in muscle tissue compared with the unmodified control vector. Furthermore, helper-dependent adenoviral vectors mediated stable marker gene expression for at least 4 months in muscle tissue of immunocompetent mice in contrast to first generation vectors decreasing significantly over this period. We are currently investigating whether the increase in marker gene expression translates into enhanced expression of secreted and intracellular therapeutic proteins. In conclusion, 5/3 capsid modified helper dependent adenoviral vectors show enhanced transduction in adult murine muscle tissue and are able to mediate long term gene expression, which might make these vectors suitable for muscle-directed gene therapy.

479. Exploring the Role of Deubiquitinating Enzyme A20 for Treatment of Muscular Dystrophy in mdx Mice

Rakshita Charan,¹ Gabriela Niizawa,^{1,2} Hiroyuki Nakai,³ Paula R. Clemens.^{1,2}

¹Department of Neurology, University of Pittsburgh, Pittsburgh, PA; ²Neurology Service, Department of Veteran Affairs Medical Center, Pittsburgh, PA; ³Department of Microbiology and Molecular Genetics, University of Pittsburgh, Pittsburgh, PA.

Duchenne muscular dystrophy (DMD) is one of the most common muscle disorders affecting about 1 in 3500 male births worldwide. It is caused by mutations in the gene dystrophin, the protein product of which is required for muscle structure and stability. Studies suggest that the lack of dystrophin protein leads to dystrophic pathology in skeletal muscle; an important pathologic mediator is nuclear factor kappa B (NF- κ B), a transcription factor that regulates several genes responsible for stress responses, cell survival and various inflammatory conditions. NF- κ B is pathologically activated in dystrophic muscle in DMD patients and in the mdx mouse model for DMD. NF- κ B activation in mdx mice is thought to activate protein degradation and cause chronic inflammation in skeletal muscle. Furthermore, pathological activation of NF- κ B downregulates myogenic regulatory factors and interferes with muscle regeneration. Attenuation of NF- κ B activation in mdx mice has been shown to improve muscle stability and strength. Thus, strategies to inhibit NF- κ B activation are being actively pursued as a therapeutic option for DMD. A20, a deubiquitinating enzyme, is known to attenuate NF- κ B activation by deubiquitinating RIP1. We sought to characterize A20 in skeletal muscle and examine its role as a potential therapeutic target to attenuate NF- κ B activation in DMD. Our studies show that siRNA blockade of A20 significantly increases NF- κ B activation in cultured mdx and control C57BL/10 myotubes *in vitro*. Since NF- κ B is known to play a role in muscle regeneration and differentiation, we studied the effect of blocking A20 on muscle differentiation in myoblasts obtained from these mice. We observe a delay in myoblast differentiation in the absence of A20 indicating a role for A20 in promotion of muscle differentiation. Further characterization of A20 localization *in vivo* in mdx muscle demonstrated expression predominantly in regenerating fibers; interestingly, most are fast-twitch muscle fibers. A time-profile assessment of A20 expression in mdx mice compared with control mice showed an increase in A20 protein expression during the 7-12 week time period in mice that corresponds with the ages when cycles of severe muscle degeneration and regeneration occur in mdx mice. This correlation between expression of an NF- κ B inhibitor attenuating NF- κ B activation and pathology of DMD is a promising observation to further explore the efficacy of A20 as a therapeutic target. We are

developing adeno-associated viral vectors carrying A20 expression cassettes in order to test the therapeutic benefit of A20 over-expression in the mdx model of DMD.

480. Interleukin-1 β and Tumor Necrosis Factor- α Knockdown in Chondrocytes by Short Interfering RNA Using a Dual Expression Long Hairpin Construct

Alan J. Nixon,¹ Michael S. Scimeca.¹

¹Comparative Orthopaedics Laboratory, Cornell University, Ithaca, NY.

Arthritis and more acute cartilage injuries result in structural derangements characterized by an imbalance in cartilage catabolic and anabolic processes, leading to matrix erosion and exacerbation of the debility associated with osteoarthritis (OA). IL-1 β and TNF α are key pro-inflammatory cytokines in osteoarthritis and are logical targets for arthritis attenuation and pain control. An aggressive and long-term approach to control may be to knockdown catabolic processes driven by IL-1 β and TNF α by gene silencing at the post-transcriptional level. Plasmid based short hairpin RNA gene approaches have not been efficient at dual expression of siRNAs targeting both IL-1 and TNF. Efficient long term knockdown of both IL1 β and TNF α may be provided by a single long hairpin (LHp) construct which can express multiple siRNAs. *Methods:* Two DNA fragments based on siRNA sequences previously verified to knockdown IL-1 and TNF were synthesized and ligated into the U6 promoter driven vector pSIREN shuttle. Ligation products were transformed into TOP10 E. coli. Isolated positive colonies were identified by PCR. Plasmids were purified from positive colonies and constructs were confirmed by sequencing. Confirmed plasmids were transfected into equine articular chondrocytes in 24 well plates using FuGene HD. Chondrocytes were allowed to grow for 48 hours post-transfection and begin expression of LHp RNA. At 48 hours post-transfection, chondrocytes were stimulated with 20 μ g/mL LPS to induce IL1 β and TNF α expression. After 36 hours of LPS stimulation, cells were lysed and total RNA purified. Expression of IL1 β and TNF α were determined by quantitative real time PCR and normalized to 18S rRNA. *Results:* Sequencing yielded four identical LHp plasmids for testing in chondrocytes. Overall, LHp plasmids had 40% lower IL1 β expression than positive control and all LPS treated cells had higher IL1 β expression than untreated controls.

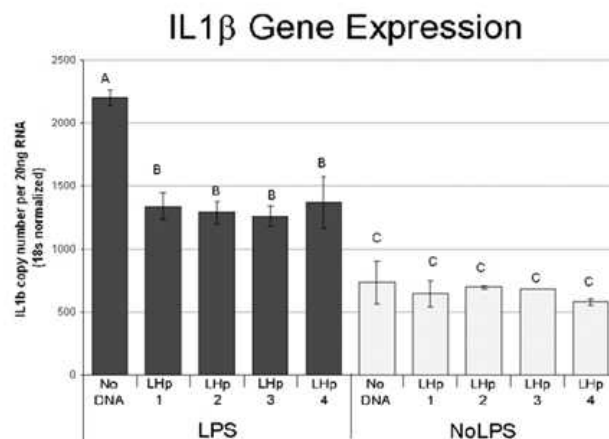

Additionally, LHp plasmids had 62% lower TNF α expression than positive control.

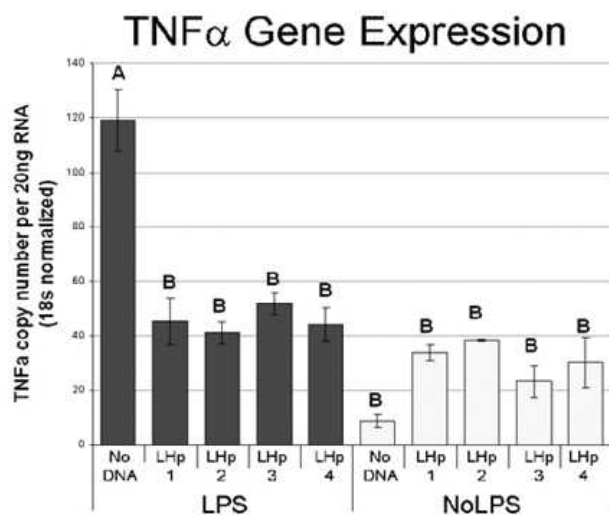

Summary: Synthetic DNA fragments carrying previously validated IL1b and TNF α siRNA were ligated into a LHp RNA expression vector. Four clonally isolated long hairpin plasmids were confirmed and tested in LPS stimulated chondrocytes. All four LHp plasmids knocked down IL1b expression ~40% and TNF α expression ~62%.

481. Low-Level Expression of a Near-Full Length Dystrophin Improves Muscle Force and Lifespan in a Strain of Severely Affected Dystrophin/Utrophin Double Knockout Mice

Dejia Li,¹ Yongping Yue,¹ Dongsheng Duan.¹

¹Department of Molecular Microbiology and Immunology, University of Missouri-Columbia, Columbia, MO.

Utrophin/dystrophin double knockout mdx (u-dko) mice display severe clinical symptoms and die prematurely as in Duchenne muscular dystrophy (DMD) patients. Here we tested the hypothesis that minimal level dystrophin expression can improve the clinical outcome of u-dko mice. It has been shown that mdx3cv (3cv) mice express a near-full length dystrophin protein at ~ 5% of the normal level. We crossed utrophin-null mutation (all utrophin isoforms are inactivated) to the 3cv background. The resulting uko/3cv mice expressed the same level of dystrophin as 3cv mice but utrophin expression was completely eliminated. Surprisingly, uko/3cv mice showed a much milder phenotype. Compared to uko/mdx mice, uko/3cv mice had significantly higher body weight and stronger specific muscle force. Most importantly, uko/3cv outlived uko/mdx mice by several folds. Our results suggest that a threshold level dystrophin expression may provide vital clinical support in a severely affected DMD mouse model. This finding may hold clinical implications in developing novel DMD therapies.

482. Osteoinduction in Muscle Tissue after Transduction with Bone Morphogenetic Protein-9: Implications for Bone Repair

Volker M. Betz,¹ Oliver B. Betz,² Irina Weinzierl,¹ Stefan Rammelt,¹ Peter E. Mueller,² Hans Zwipp.¹

¹Trauma Surgery, Technical University of Dresden, Dresden, Germany; ²Orthopedic Surgery, University of Munich, Munich, Germany.

Background and Aim: A large number of studies have demonstrated that bone formation can be induced by gene transfer technologies. Cells transduced with a gene encoding a growth factor produce physiological amounts of the growth factor protein over an extended period of time and thereby provide a long lasting regeneration

stimulus. It was shown that bone morphogenetic protein (BMP) overexpressing muscle stem cells heal large bone defects in animal models. However, such an ex-vivo gene therapy approach requires the isolation and in vitro expansion of cells which makes this method time-consuming and expensive. Therefore, we investigated if we can provoke an osteogenic response in pieces of muscle tissue by direct transduction with an adenoviral BMP-9 vector. If this should be the case, BMP-9 gene activated, autologous muscle tissue grafts could serve as expedited, osteoregenerative implants for the repair of large bone defects – a technology that does not require the isolation and expansion of cells and is therefore more suitable for clinical application. **Methods:** Muscle tissue was harvested from the hind limbs of 3 male, 4 months old Fischer 344 rats. We created tissue fragments of a standardized size using a 4 mm biopsy punch. Muscle tissue pieces were left untreated or were incubated with an adenoviral vector carrying either the non-osteogenic marker gene GFP (green fluorescent protein) or the BMP-9 gene. Tissue fragments were assigned to the following groups: 1) untreated muscle + basic media; 2) untreated muscle + osteogenic media; 3) GFP transduced muscle + osteogenic media; 4) BMP-9 transduced muscle + osteogenic media. Muscle fragments were held in culture for up to 30 days. BMP-9 expression was confirmed by Western Blot. Osteoinduction was evaluated using an Alkaline Phosphatase Assay, real-time PCR (upregulation of osteocalcin, osteopontin, bone sialoprotein and collagen I) a Calcium Content Assay and histology (detection of mineralization by alizarin red). **Results and Conclusion:** Treatment of muscle fragments with an adenoviral BMP-9 vector induced the expression of the bone-specific gene products alkaline phosphatase, osteocalcin, osteopontin, bone sialoprotein and collagen I. This was followed by the deposition of mineral, as detected by the Calcium Content Assay and histology. Muscle tissue transduced with BMP-9 (group 4) showed a significantly higher level of bone specific gene expression and a larger amount of calcium than muscle tissue of the other groups. The results of this study demonstrate that adenoviral BMP-9 transduction of cells on the surface of muscle tissue fragments leads to an osteoinduction within muscle tissue. BMP-9 gene activated muscle tissue grafts may have the potential to be used as expedited osteoregenerative implants for the repair of large bone defects.

483. PMO Delivery Systems with Bubble Liposomes and Ultrasound Exposure into Skeletal Muscles of the mdx Mice

Yoichi Negishi,¹ Yuko Ishii,¹ Shoko Sekine,¹ Yoko Endo-Takahashi,¹ Ryo Suzuki,² Kazuo Maruyama,² Yukihiko Aramaki.¹

¹Department of Drug and Gene Delivery Systems, School of Pharmacy, Tokyo University of Pharmacy and Life Sciences, Hachioji, Tokyo, Japan; ²Department of Biopharmaceutics, School of Pharmaceutical Sciences, Teikyo University, Sagami-hara, Kanagawa, Japan.

Background: Duchenne muscular dystrophy (DMD) is genetic disorders causing by mutations in the DMD gene that lead to an absence of functional protein. Previous reports have shown that a phosphorodiamidate morpholino oligomer (PMO) designed to skip the mutated exon 23 from the mRNA of murine dystrophin induce dystrophin expression in dystrophin-deficient mdx mice. However, efficient delivery method of PMO into the mdx mice still needs to be developed. Ultrasound (US) in combination with microbubbles has recently been acquired much attention in the safe method of gene or antisense oligonucleotides (AOs) delivery. However, microbubbles have problems with size, stability, and targeting function. Liposomes have been known as drug, antigen, and gene delivery carriers. To solve the above-mentioned issues of microbubbles, we have previously developed the polyethyleneglycol (PEG)-modified liposomes entrapping echo-contrast gas, “Bubble liposomes” (BLs), which can function as a novel gene delivery tool by applying them with US

exposure. In this study, to assess the feasibility and the effectiveness of BLs for a PMO delivery system into the *mdx* mice, we tried to deliver a PMO, which is designed to skip the mutated exon 23 from the mRNA of murine dystrophin, into skeletal muscles of the *mdx* mice by the combination of BLs and US exposure. **Methods:** A solution of BLs and PMO for mouse exon 23 was injected into tibialis (TA) muscle of *mdx* mice and US exposure (1 MHz, 2 W/cm², 60 sec., duty cycle 50 %) was immediately applied at the injection site. Two weeks after the treatment, exon 23 skipping levels were analysed by RT-PCR. The number of dystrophin-positive fibers after the treatment was also analysed by immunohistochemical analysis. **Results:** Mice were euthanized 2 weeks after the injection, the injected muscles were isolated and analyzed by RT-PCR and by immunohistochemistry. In the combination of BLs and ultrasound exposure, we found that the PMO significantly restored the dystrophin mRNA expression and dystrophin-positive fibers by skipping the mutated exon 23 in the injection site of *mdx* mice, compared to the PMO injection alone. **Conclusions:** These results suggest that PMO delivery into the muscle of *mdx* mice can be improved by the combination of BLs and US exposure. This US-mediated BLs technique may provide an effective noninvasive method for DMD therapy in the clinical field. **Acknowledgments:** This study was supported by Industrial Technology Research Grant Program (04A05010) in '04 from New Energy and Industrial Technology Development Organization (NEDO) of Japan.

Infectious Diseases and Vaccines II

484. Zinc Finger Mediated Disruption of CXCR4 in CD4 T Cells Allows Protection and Enrichment in Humanized Mice after HIV-1 Challenge

Jinyun Yuan,¹ Jianbin Wang,² Karen Crain,¹ Philip D. Gregory,² Michael C. Holmes,² Bruce E. Torbett.¹

¹Department of Molecular and Experimental Medicine (131), The Scripps Research Institute, La Jolla, CA; ²Sangamo BioSciences, Inc., Richmond, CA.

Individuals infected with HIV-1 can harbor viruses that utilize CCR5 or CXCR4. Moreover, in HIV-1-antiretroviral inhibitor (ART) experienced individuals up to 50% of viruses identified can use either chemokine receptor for entry. Thus, in ART experienced individuals with CXCR4 or dual tropic HIV targeting of CCR5 may not be sufficient. Previously we have demonstrated that CXCR4 gene disruption by a Zinc Finger Nuclease (CXCR4-ZFN) in T cell lines was superior to siRNAs for long-term protection from HIV-1 challenge. However, our studies did not address whether CXCR4-ZFN mediated disruption would be a useful strategy for primary CD4 T cells. We now provide evidence that CXCR4-ZFN-mediated disruption of CXCR4 alleles in primary CD4 T cells promotes protection from HIV-1 in tissue culture and does not alter cell expansion. More importantly, we demonstrate the durability of CXCR4-ZFN modified CD4 T cells, in the presence and absence of HIV-1, in humanized NOD-scid gamma (NSG) mice. Isolated, short-term activated CD4 T cells were transduced using an Ad5/F35 vector expressing the CXCR4-ZFN resulting in 20% average allelic disruption (n=4). When these primary cells were expanded for 1 month no discernable change was evident in the starting and ending CXCR4 allelic disruption frequency (n=2). Thus, disruption of CXCR4 expression did not appear to negatively (or positively) influence CD4 T cell expansion. To interrogate the therapeutic potential of this approach in a more physiological model, we employed human PBL NSG mice. CD4 T cells were modified and adoptively transferred to NSG mice, with unmodified, autologous PBLs, either not exposed or exposed to 400 ng (p24/mouse) of CXCR4-tropic NL4-3 virus. Four different experimental groups (7 mice/group, n=2) were established including Mock transduced CD4 T cells, with

or without HIV challenge, and CXCR4-ZFN modified CD4 T cells (17% allelic disruption), with or without HIV challenge. Peripheral blood was analyzed every other week for human CD45, CD3, CD4 and CD8 cells by flow cytometry out to 8 weeks. At 8 weeks post-infection, the CD4/CD3 T cell ratio in blood from the groups were: 1) Mock, no HIV challenge, 95%; 2) Mock, with HIV challenge, 1%; 3) CXCR4-ZFN modified CD4 T cells, no HIV challenge, 94%; and 4) CXCR4-ZFN modified CD4 T cells, with HIV challenge, 63%. Human peripheral blood cells from HIV-infected mice engrafted with Mock CD4+ T cells were 600 cells/ml (median). In contrast, 7,000 human cells/ml (median) were present in the blood of HIV-infected mice engrafted with CXCR4-ZFN modified CD4 T cells. CXCR4 allelic disruption frequency in CXCR4-ZFN modified CD4 T cells from mice without HIV-1 challenge averaged 3%, whereas in mice challenged with HIV-1 it was 61%. Thus, CXCR4-ZFN modified CD4 T cells survived and expanded in humanized mice when challenged with HIV-1. Overall, our findings suggest that CXCR4-ZFN modified CD4 T cells are durable, provide protection from HIV-1, and promote a competitive survival advantage in the presence of HIV infection. Funded by: HL091219

485. Protection of CD4+ T-Cells and Enhanced Immune Response Against SHIV-Challenge after Engraftment of Genetically-Modified HSCs in the Pigtailed Macaque-AIDS Model

Patrick Younan,¹ Patricia Polacino,^{2,3} On Ho,^{2,3} Brian Beard,¹ Grant Trobridge,⁴ Shiu-Lok Hu,^{2,3} Hans-Peter Kiem.^{1,2}

¹Fred Hutchinson Cancer Research Center, Seattle; ²University of Washington, Seattle; ³Washington National Primate Research Center, Seattle; ⁴Washington State University, Seattle.

Although Highly Active Anti-Retroviral Therapy (HAART) has reduced the morbidity and mortality associated with HIV infection, the inability of HAART treatment to eradicate the viral reservoir remains a significant obstacle to curing HIV-infected patients. Therefore, further advancement of novel, alternative therapies with the potential to eliminate latently-infected cells is critical for the development of potential cures to HIV-infection. The genetic modification of hematopoietic stem cells (HSCs) with transgenes that protect HSCs and as a result all of the hematopoietic lineages from HIV infection/propagation, is one such alternative therapy. Ongoing studies in our lab have demonstrated that lentivirus-mediated gene modification of CD34⁺ cells has the potential to limit HIV disease progression. CD34⁺ cells were isolated from two pigtailed macaques, and transduced *ex vivo* with either a control lentiviral construct expressing a drug selectable marker and GFP, or with a lentivirus that expresses a membrane bound HIV fusion inhibitor (C46) in addition to GFP and the selection marker. We and others have previously shown the C46 fusion inhibitor to be a potent inhibitor of HIV infection and simian-human immunodeficiency virus (SHIV). The gene-modified cells were re-infused into each respective macaque prior to *in vivo* selection. The macaques were then challenged with SHIV89.6P and clinical sequelae was monitored. The percentage of CD4⁺GFP⁺ cells substantially increased in the experimental macaque to approximately 90% of total CD4⁺ T cells by Day 22 after infection. The increase observed in the experimental macaque was nearly 1-log greater than the percentage of CD4⁺GFP⁺ T-cells observed in the control macaque. These results suggest that gene modified lymphocytes that express the C46 peptide are resistant to HIV infection *in vivo*. Furthermore, peripheral blood CD4⁺ T-cells increased by 8 to 10-fold following an initial drop in CD4⁺ T-cell levels two weeks after infection in the experimental macaque while the control macaque maintained CD4⁺ T-cells levels nearly equal to the lowest levels observed after infection. Importantly, the overall number of CD4⁺ T-cell in the experimental macaque has continued to recover to approximately 40% of pre-infection levels by week 20, whereas in the control macaque, CD4⁺

T-cell levels have dropped below 4% of pre-infection levels. Post-acute phase plasma viral load was 2-logs less in the experimental macaque as compared to the control macaque with seroconversion only being detected in the experimental macaque. Taken together, these results indicate that not only were C46-expressing CD4⁺ T-cells resistant to SHIV infection, but that there was also a heightened immune response in the experimental macaque. This data suggests that HSC-directed gene therapy can protect from SHIV infection in a clinically relevant nonhuman primate AIDS model.

486. LEDGF/p75 Based Gene Therapy for HIV/AIDS

Sofie Vets,¹ Janine Kimpel,² Dorothee von Laer,² Zeger Debyser,¹ Rik Gijssbers.¹

¹Division of Molecular Medicine, Katholieke Universiteit Leuven, Leuven, Belgium; ²Georg-Speyer-Haus, Goethe Universität of Frankfurt am Main, Frankfurt am Main, Germany.

Background The treatment of HIV-infected patients with a combination of antiretroviral drugs allows long-term suppression of HIV, but no cure. Hence, development of novel strategies such as gene therapy is imperative. During the last decade, the insight has grown that HIV engages cellular proteins (co-factors) to complete its replication. These co-factors provide attractive novel targets for antiviral therapy. We identified Lens Epithelium-Derived Growth Factor (LEDGF/p75) and validated it as an important co-factor of HIV integration. We now aim at developing a T-cell directed gene therapy for HIV, targeting the LEDGF/p75-HIV integrase interaction. A strategy that targets an essential co-factor instead of a viral protein may be less prone to viral resistance development. **Methods** LEDGF/p75 contains an N-terminal chromatin binding domain and interacts with IN via the C-terminal integrase-binding domain (IBD). Stable overexpression of the C-terminal part of LEDGF/p75 (LEDGF³²⁵⁻⁵³⁰) containing the IBD and stable knockdown of LEDGF/p75 (KD) with mi-RNA-based shRNAs inhibits HIV infection in 293T and HeLaP4 cells. As a control, we used LEDGF³²⁵⁻⁵³⁰-D366N, a mutant of LEDGF/p75 that lacks interaction with HIV IN. Here, primary human CD4⁺ T-cells were transduced with lentiviral vectors encoding IBD (LEDGF³²⁵⁻⁵³⁰), LEDGF/p75 KD or a combination and challenged with HIV virus. Human CD4⁺ T-cells were engrafted in a mouse model to show that cells expressing LEDGF³²⁵⁻⁵³⁰ or LEDGF³²⁵⁻⁵³⁰ with LEDGF/p75 KD are resistant to HIV-1 infection (NOD SCID $\gamma_c^{-/-}$ mice). Blood of the transplanted mice was collected weekly from the tail vein. Viral load in the serum of the infected mice was determined by p24 ELISA. Human CD4⁺ and human CD45⁺ cells were monitored by flow cytometry. **Results/Conclusion** LEDGF³²⁵⁻⁵³⁰ overexpression alone or combined with LEDGF/p75 KD inhibits HIV replication 20- to 40-fold, thereby protecting primary CD4⁺ T-cells from HIV infection *in vitro*. *In vivo* a 3- to 5-fold reduction in mean plasma viral load was observed comparing mice engrafted with LEDGF³²⁵⁻⁵³⁰ expressing CD4⁺ T-cells or combined with KD, to mice engrafted with LEDGF³²⁵⁻⁵³⁰-D366N CD4⁺ T-cells. In animals transplanted with LEDGF³²⁵⁻⁵³⁰-D366N cells, 70% of the CD4⁺ cells was lost due to the ongoing HIV replication. Mice transplanted with LEDGF³²⁵⁻⁵³⁰ cells or LEDGF³²⁵⁻⁵³⁰ combined with KD, demonstrated only a 20% decrease in CD4⁺ cells. These results indicate that LEDGF³²⁵⁻⁵³⁰ and LEDGF³²⁵⁻⁵³⁰ overexpression combined with LEDGF/p75 KD inhibit HIV replication and protect against HIV associated destruction of CD4⁺ T-cells *in vivo*.

487. Killing One Bird with Two Stones – Single shRNA Targeting Both Strands of HCV

Leszek Lisowski,¹ Menashe Elazar,² Kirk Chu,¹ Jeffrey S. Glenn,² Mark A. Kay.²

¹Departments of Pediatrics and Genetics, Stanford University School of Medicine, Stanford, CA; ²Departments of Gastroenterology and Hepatology, Stanford University School of Medicine, Stanford, CA.

Hepatitis C virus (HCV) is an enveloped RNA virus belonging to the Flaviviridae family. HCV infection afflicts more than 180 million people worldwide, with infection rates as high as 10-30% in some countries. In the US there are more than 3 million people with chronic HCV infection with an estimated 19,000 annual new infections. The current medical therapy is effective in less than half of patients with long-term infection increasing the risk for liver cirrhosis and hepatocellular carcinoma. HCV contains a single-stranded RNA genome of positive polarity, making it a particularly attractive target for RNAi based therapies. However, one of the most significant features of HCV RNA is its high degree of genomic variability caused by mutation-prone replication, which together with very high replication rate makes it a very difficult target for RNAi based therapy. One way to increase the efficiency of RNAi against HCV is to target highly conserved regions of the viral genome and to use multiple RNAi molecules to target multiple regions of the genome simultaneously. Furthermore, HCV, like other Flaviviridae, replicates through a negative strand intermediate, which is present in 20 to 100 times lower amounts than the positive strand and may represent a more potent and/or a synergistic target with shRNAs intended against the positive strand sequences. However, because both shRNA strands can potentially be loaded into the RISC complex and HCV infected cells contain both plus and minus HCV strands, standard RNAi screens cannot distinguish between plus and/or minus strand targeting. In addition it is not known if the HCV minus strand is bio-available for targeting. Thus, we undertook a novel strategy to identify shRNA sequences capable of efficient knockdown of HCV positive and/or negative strands. We first identified regions conserved between HCV 1b and 2a and designed 88 overlapping shRNAs staggered every 4bp. All shRNAs were cloned into rAAV constructs under the H1 promoter and tested against the positive and negative HCV genome using a luciferase reporter system, in which the corresponding HCV target was cloned into the 3'UTR of the luciferase gene. We identified a number of shRNAs effective against positive, negative, or both HCV targets. All the shRNA were further tested against replicating HCV-Luc in a transient transfection and against replicating wtHCV in Huh7.5 cells. In total we found over 10 shRNAs that were efficient at HCV knockdown as defined by over 80% decrease in HCV signal as compared to scrambled shRNA. Using asymmetrically designed shRNAs, where only one strand is able to perform RNAi cleavage, we can now distinguish which HCV strand is most amenable to targeting in a sequence specific manner. While we have now identified robust anti-HCV shRNAs and demonstrated their ability to reduce HCV infection, our general approach should allow us to select the most robust sequences and make a vector that produces multiple shRNAs to maximize efficacy against HCV infection as well as provide new insights into the mechanism of HCV strand replication.

488. Comparison of Mucosal and Systemic Vaccination with Helper-Dependent Adenoviral Vaccines Against Mucosal SHIV Challenge in Macaques

Eric A. Weaver,¹ Pramod Nehete,² Donna Palmer,³ Philip Ng,³ Jagannadha Sastry,² Michael A. Barry.¹

¹Mayo Clinic, Rochester, MN; ²MD Anderson Cancer Center, Houston, TX; ³Baylor College of Medicine, Houston, TX.

The vast majority of HIV-1 infections occur at mucosal surfaces, yet most vaccines have been developed and tested for their ability to drive systemic immune responses and not for mucosal responses. To test if systemic or mucosal vaccination is more robust, macaques were immunized with serotype-switched helper-dependent adenoviral (HD-Ad) vaccines by intramuscular (i.m.) or intravaginal (ivag.) routes prior to rectal mucosal challenge with SHIV. To mimic natural Ad5 immunity in humans, all of the macaques were immunized intranasally with Ad5 prior to vaccination with HD-Ads expressing only HIV-1 env (no gag, pol, or nef antigens were delivered). Four animals were immunized i.m. with HD-Ad6. Another set of four were immunized with HD-Ad6 by the ivag. route. They were then boosted with HD-Ad1, HD-Ad5, and HD-Ad2 and then challenged by the rectal route with 1000 TCID₅₀ of SHIV-SF162P3. ELISPOT results from PBMCs showed PBMC CD8 IFN- γ and CD8 perforin T cell responses were generated by both routes, but were stronger by the i.m. route than the ivag. route. Vaccination with HD-Ad5 after Ad5, Ad6, and Ad1 still boosted CD8 responses, despite the fact that the animals had previously been immunized with Ad5, Ad6, and Ad1 (which should have boosted immune responses not only against Ad5, but also against conserved species C Ad epitopes). The levels of CD8 IFN- γ or perforin T cell responses in PBMCs did not correlate to viral loads. Intracellular cytokine staining from colon biopsies at week 26 just prior to challenge showed that i.m. and ivag. immunization generated CD8 central memory (T_{cm}), CD8 effector memory (T_{em}), and CD4 T_{cm} and T_{em} cells in the colon that were predominantly single IFN- γ ⁺ or IL-2⁺, but not positive for both. Three ivag. and one i.m. immunized animals generated double-positive IFN- γ ⁺/IL-2⁺ CD4 T_{em} in the colon. After challenge, in controls, viral RNA in the plasma was above 10 million copies/ml. In the intramuscular group, viremia was lower than controls ($p = 0.045$). For the intravaginal group, viremia was lower than controls ($p = 0.019$) with 2 animals having viral loads approximately 100-fold lower than controls. Viral loads 13 weeks after challenge showed that all of the animals in the intramuscular group had fairly stable viral loads above 1,000 and up to 100,000 copies/ml. The animals with double-positive IFN- γ ⁺/IL-2⁺ CD4 T_{em} in the colon had viral loads below 1,000 and these loads appeared to be decreasing. These data suggest that mucosal immunization may be more effective at providing barrier protection at the site of HIV entry during sexual contact. These data also suggest that serotype-switching with HD-Ad vectors appears potent in the face of substantial anti-Ad immunity and when only the env gene is used as an immunogen.

489. Expression of Anti-HIV-1 Short Hairpin RNAs Using PolIII-Based Transcriptions Systems

Lisa J. Scherer,¹ Karl A. Haushalter,² Athena Anderson,³ John J. Rossi.¹

¹Molecular and Cellular Biology, City of Hope/Beckman Research Institute, Duarte, CA; ²Chemistry and Biology, Harvey Mudd College, Claremont, CA; ³Chemistry, Harvey Mudd College, Claremont, CA.

We previously described the use of a tRNA(Lys3) promoter to express shRNAs targeting HIV-1. tRNA promoters are both small and diverse, a potential advantage in gene therapeutic applications requiring multiplexing, particularly for vectors having size limitations.

Our published studies are consistent with the tRNA providing the structural basis for specific and accurate release of the attached shRNA from tRNA(Lys3)-tat/rev shRNA chimera by endogenous 3'tRNAse (tRNAse ZL). We have subsequently tested other tRNA isotypes and anti-HIV shRNA combinations thus demonstrating the general applicability of this design. Our initial observations show that mutations in the 3rd base pair of the tRNA(Lys3)A acceptor stem affect the efficiency of shRNA release, consistent with in vitro studies of tRNAse ZL activity, which holds true for all subsequent tRNA-shRNA combinations as well. Since over-expression of shRNAs particularly from U6 promoters has been linked to toxicity in vivo, these results raise the possibility of being able to adjust shRNA trigger release from the primary tRNA-shRNA transcript based on the identity of the tRNA acceptor stem 3rd base pair and thus balance efficacy and non-toxicity for each particular application. To test this concept we constructed two sets of tRNA-shRNA chimeras with all 16 permutations of the acceptor stem 3rd base pair and tested their activity in psiCHECK dual luciferase assays. Our results show that this series of chimeras can mediate a broad range of target knockdown that correlates with the level of shRNA expression by Northern analysis. Initial testing of combinations of different tRNA-shRNA chimeras targeting HIV-1 supports their potential use in multiplexing gene therapy strategies.

490. Epitopes Expressed in Different Loops of Adenovirus Fiber Induce Different Levels of Epitope-Specific Immunity

Anurag Sharma,¹ Anja Krause,¹ Wen Zhu,¹ Stefan Worgall.¹

¹Weill Cornell Medical College, New York, NY.

Incorporation of pathogen-derived antigenic epitopes into the adenoviral (Ad) capsid proteins is a useful strategy for the induction of anti-pathogen immunity. We have previously investigated recombinant replication-deficient adenoviral vectors that expressed epitopes on its surface as part of following capsid proteins: HI loop of fiber protein, HVR5 loop of hexon protein, RGD loop of penton, and C-terminus of protein IX. Despite presenting the epitope in least copy numbers, Ad vector with epitope on its fiber elicited the strongest anti-epitope immune response as compared to when same epitope is incorporated in hexon, penton or protein IX, indicating the importance of choice of incorporation site in Ad capsid proteins for generation of epitope-specific immune response. To further explore the alternate locations within the Ad fiber protein and in order to enhance the epitope-specific immune response by capsid-modified Ad vectors, we generated several fiber-modified Ad vectors incorporating *Pseudomonas aeruginosa* immune-dominant OprF epitope (Epi8) into loops CD (AdZ.F(CD)Epi8), DE (AdZ.F(DE)Epi8), FG (AdZ.F(FG)Epi8), HI (AdZ.F(HI)Epi8) or IJ (AdZ.F(IJ)Epi8) of fiber protein and HVR5 loop (AdZ.HexEpi8) of hexon protein, and investigated the induction of anti-epitope immune response by these viruses. All vectors expressed β -galactosidase (Z) as a transgene. A stable cell line (HEK 293-derived) constitutively expressing the Ad fiber protein was used to generate most of these viruses that were subsequently propagated in regular HEK 293 cells. The presence of the Epi8 epitope on the viral capsid was confirmed by western blot analysis of the purified viruses. The infectivity of purified viruses was tested on A549 cells. While AdZ.F(HI)Epi8, AdZ.F(FG)Epi8 and AdZ.HexEpi8 effectively infected A549 cells, AdZ.F(CD)Epi8, AdZ.F(DE)Epi8 and AdZ.F(IJ)Epi8 showed significantly diminished infectivity, indicating inhibition in receptor binding ($P < 0.05$). To evaluate the immunogenicity of these fiber-modified vectors, Balb/c mice were immunized intramuscularly with 10^{10} particle units of each vector and the serum anti-Ad and anti-OprF IgG antibodies were analyzed by ELISA. While equivalent titers of anti-Ad antibody were observed in all the groups after 2 weeks ($P > 0.05$), marked differences were observed in anti-OprF titers. AdZ.F(HI)Epi8 and AdZ.F(FG)

Epi8 inoculated groups showed significantly higher anti-OprF titers compared to AdZ.F(CD)Epi8, AdZ.F(DE)Epi8, AdZ.F(IJ)Epi8 or AdZ.HexEpi8 inoculated groups ($P < 0.05$, all comparisons). These results suggest the importance of location of epitope placement within the Ad fiber to induce anti-epitope humoral immunity. Moreover, the FG loop within the fiber protein seems to be a promising new site to insert epitopes for Ad vaccines.

491. The Analysis of Utility of Human Adenovirus Vectors for Killing Macrophages Infected with *Mycobacterium tuberculosis*

Nelson C. Di Paolo,¹ Shahin Shafiani,² Kevin Urdahl,^{2,3} Dmitry M. Shayakhmetov.¹

¹Division of Medical Genetics, Department of Medicine, University of Washington, Seattle, WA; ²Seattle Biomedical Research Institute, Seattle, WA; ³Department of Immunology, University of Washington, Seattle, WA.

Human adenovirus-based vectors (Ad) are commonly used in gene transfer studies aimed to develop novel approaches to correct or ameliorate human genetic diseases. Upon intravascular administration, Ad particles are rapidly trapped by residential macrophages in the liver and spleen and this interaction leads to the rapid death of these cells via an unknown mechanism. The Ad-mediated induction of the macrophage death is a highly efficient process, and it can be triggered even at a dose of 10 virus particles per cell. Numerous microbial pathogens, including *M. tuberculosis* (M.tb) – the causative agent of human tuberculosis, infect and reside in tissue macrophages thus effectively escaping host innate and adaptive immunity. Furthermore, the most virulent strains of M.tb express virulent factors that counteract macrophage apoptotic machinery, thus preventing elimination of bacilli from the host. In this study we analyzed whether Ad infection can trigger the death of primary alveolar macrophages infected with human virulent M.tb strain H37Rv *in vitro*. To allow for efficient infection of primary macrophages harvested from bronchial-alveolar lavage of non-human primates, we utilized a capsid-chimeric human serotype 5-based vector with the fiber knob-domain derived from the human serotype HA25 (Ad5/35L). Our studies revealed that infection of primary alveolar macrophages with Ad5/35L triggers rapid cell death via the necrotic mechanism. Moreover, we found that prior infection of macrophages with a virulent strain of M.tb does not confer protection from Ad-mediated cell death and, after the macrophage exposure to Ad5/35L, all the cells underwent necrosis irrespective of their M.tb infection status. Our data indicate that the molecular mechanisms underlying anti-apoptotic activity of M.tb and pro-necrotic activity of Ad are not overlapping. These data further suggest that the identification and pharmacological targeting of the molecular machinery that triggers the macrophage cell death after Ad exposure can be highly relevant for the development of novel approaches to the therapy of human tuberculosis via elimination of M.tb-infected macrophages *in vivo*.

492. An Enhanced DC-Targeting Lentivector Vaccine to HIV-1 Gag by PD-1 Blockade

Bingbing Dai,¹ Lili Yang,² Pin Wang.³

¹Chemical Engineering and Materials Science, University of Southern California, Los Angeles, CA; ²Division of Biology, California Institute of Technology, Pasadena, CA.

Programmed death 1 (PD-1) is a negative regulator of activated T cells that is upregulated on exhausted CD8+ T cells during chronic infection. In HIV infection, the level of PD-1 expression is inversely correlated with virus-specific CD8+ T cell function, and positively related with disease progression and plasma viral loads. However, the exhaustion of CD8+ T cells function has been shown to be reversible with PD-1 blockade, characterized by proliferation and

cytokine production. Therefore, we dedicated to develop a lentivector (LV)-based vaccine strategy with enhanced efficacy to HIV by blocking of the PD-1/PD-L1 inhibitory pathway. In previous study, we demonstrated in mice a dendritic cell (DC)-directed LV system encoding the Gag protein of human immunodeficiency virus (HIV) (LV-Gag) as a potential vaccine for inducing an anti-HIV immune response. We now showed that the targeting lentivirus vaccine, in combination with blocking of the PD-1 inhibitory signal using an antibody to PD-L1, induced an elevated HIV Gag-specific immune response. We found that the LV-Gag prime/LV-gag boost regimens synergized with PD-1 blockade at the boost injection would further improve virus-specific immunity. This combinatorial vaccination generated Gag-specific CD8+ T cells with improved ability to produce multiple cytokines, and to respond to a broader range of Gag-derived epitopes. These results indicated a potential lentivirus vaccine for enhancing CD8+ T cells function by PD-1 blockade.

493. Multiplexing Small Nucleolar RNAs To Inhibit HIV-1 Replication

Janet Chung,¹ Jane Zhang,^{1,2} John Rossi.^{1,2}

¹Molecular and Cell Biology, City of Hope, Duarte, CA; ²Graduate School of Biological Sciences, City of Hope, Duarte, CA.

The human immunodeficiency virus type 1 (HIV-1) contains a 9-kb RNA genome that generates various transcripts differ in splicing. Many HIV-1 transcripts are known to travel through and be involved in early transcriptional processes in the nucleolus of cells. We have previously shown that efficient inhibition of HIV-1 can be achieved individually with nucleolar localized ribozymes targeted at the U5 region of HIV-1, and decoys to the Rev binding element (RBE) and transactivation response (TAR) element. We have combined these therapeutic RNAs into a multicistronic microRNA cassette to be expressed either independently of or along with microRNA mimics targeting HIV-1 as a combinational approach to inhibiting HIV-1 replication. We will first verify whether the RNA expression of each unit was properly transcribed with a northern blot analysis followed by testing for the downregulation of viral activity. This is the first study to use combinations of nucleolar localizing anti-HIV RNAs for the inhibition of HIV-1 replication.

494. Engineering Immunity Against HIV — Lentiviral-Vector Mediated Delivery of Broadly Neutralizing Antibodies as Pre-Exposure Prophylaxis for HIV

Kenneth K. Yu,^{1,2} Kiefer Aguilar,¹ David Baltimore.¹

¹California Institute of Technology, Pasadena, CA; ²Keck School of Medicine of the University of Southern California, Los Angeles, CA.

Since its initial emergence in 1981, HIV/AIDS has claimed the lives of more than 20 million people world-wide. Today 33.3 million people are living with the virus. An effective vaccine is urgently needed. Anti-HIV broadly neutralizing antibodies (bNAbs) are a special class of antibodies that are capable of potentially neutralizing HIV isolates across multiple clades and subclades. Passive immunization with these anti-HIV bNAbs has been shown to protect animals against chimeric simian-HIV (SHIV). Skeletal muscles are an easily accessible tissue type that has intrinsically high protein-synthetic capacity. Thus, they offer an ideal target for genetic modification to produce broadly neutralizing antibodies. By reprogramming skeletal muscle cells *in vivo* with injected lentiviral vectors carrying bNAb genes, we propose to make a 'gene therapy vaccine' against HIV. We present the current progress on using lentiviral vectors to produce broadly neutralizing antibodies from muscle *in vivo*, in the context of a humanized-immune system mouse model of HIV infection.

Cancer - Immunotherapy II

495. Effective Eradication of Established Ovarian Murine Tumors with MUC16 Targeted T Cells Expressing IL-12 GeneAlena A. Chekmasova,¹ Samith Sandadi,² Yan Nikhamin,¹ David R. Spriggs,¹ Renier J. Brentjens.^{1,3}¹Department of Medicine, Memorial Sloan Kettering Cancer Center, New York, NY; ²Department of Surgery, Memorial Sloan Kettering Cancer Center, New York, NY; ³The Center for Cell Engineering, Memorial Sloan Kettering Cancer Center, New York, NY.

Despite multimodality therapy with surgery and chemotherapy, most patients with ovarian carcinomas have a poor prognosis. For this reason, alternative approaches to treating this disease are urgently needed. Autologous T cells may be genetically modified to target tumor antigens through retroviral transduction with chimeric antigen receptors (CARs). We have constructed SFG retroviral vectors encoding first (4H11mz) and second (4H11m28mz) generation CARs as well as IL-12 modified CAR (4H11m28mzIRESmIL12) targeted to the retained extra-cellular domain of MUC16, termed MUC-CD. This antigen is over-expressed on most ovarian carcinoma tumor cells. Previously we have shown the efficacy of MUC-CD targeted T cells via efficient in vitro cytolytic activity against MUC-CD expressing cell lines and eradication of established MUC-CD+ tumors in SCID-Beige mice. In order to mimic the clinical setting and generate the hostile tumor microenvironment, we utilized a syngeneic tumor model using ID8 mouse ovarian tumor cells retrovirally transduced to overexpress MUC-CD antigen. The C57BL6 mice were intraperitoneally (i.p.) injected with 1x10⁷ ID8(MUC-CD) tumor cells. If left untreated, these mice developed marked ascites and multiple nodular peritoneal tumors by 8 weeks following tumor cell injection. In this series of experiments, 5x10⁶ MUC-CD targeted transduced mouse T cells were injected i.p. on day 1 and/or 7 post tumor injection. We found a statistically enhanced long-term survival of mice treated with 4H11mz+ or 4H11m28mz+ transduced T cells injected 1 day after tumor injection when compared to untreated mice or mice treated with T cells modified to express an irrelevant control CAR (4H11mz compared to 19m28mz with 37% survival up to 120 days, p=0.0036 and 4H11m28mz compared to 19m28mz with 80% survival up to 120 days, p=0.0001). However, treatment of mice with advanced tumors (7 days after i.p. injection of ID8(MUC-CD) tumor cells) with 4H11m28mz+ T cells demonstrated only 27% long term survival (p=0.005, 4H11m28mz compared to 19m28mz), compared to IL-12 secreting 4H11m28mz T cells treated mice (100% long term survival up to 160 days, p=0.0028). For negative controls, tumor bearing mice were treated with T cells modified to express the irrelevant CD19-targeted 19m28mz or 19m28mzIRESIL12 CARs. To assess whether 4H11m28mzIRESmIL12+ T cells eradicate more clinically relevant tumor burdens, we next treated C57BL6 mice 14 days post i.p. ID8(MUC-CD) tumor injection. At this point, there is evidence of overt disease as assessed by FACS. No gross evidence of disease was found on day 120 after the mice were sacrificed. Additionally, FACS analysis of peritoneal washes was negative for the presence of MUC-CD+ tumor cells. This data supports the further translation of these pre-clinical studies to the clinical setting in the form of a phase I clinical trial in patients with persistent or relapsed ovarian carcinomas.

496. T Cells Redirected Against HER2 for the Adoptive Immunotherapy of HER2-Positive MalignanciesNabil Ahmed,^{1,2,3} Vita Salsman,^{1,2,3} Oumar Diouf,^{1,2,3} Aidin Ashoori,^{1,2,3} Claudia Gerken,^{1,2,3} Lisa Wang,^{1,2} Peter Anderson,⁴ Benjamin Musher,¹ Shanda Blackmon,³ Teresa Hayes,¹ John Hicks,^{1,2} Hao Liu,¹ Winfried Wels,⁵ Catherine Bollard,^{1,2,3} Cliona Rooney,^{1,2,3} Gianpietro Dotti,^{1,2,3} Adrian Gee,^{1,2,3} Malcolm Brenner,^{1,2,3} Helen Heslop,^{1,2,3} Stephen Gottschalk.^{1,2,3}
¹Baylor College of Medicine, Houston, TX; ²Texas Children's Hospital, Houston, TX; ³The Methodist Hospital, Houston, TX; ⁴MD Anderson Cancer Center, Houston, TX; ⁵Georg-Speyer-Haus Chemotherapeutische Forschungsinstitut, Frankfurt, Germany.

The human epidermal growth factor receptor 2 (HER2) is expressed in a broad range of adult as well as pediatric malignancies. The majority of these cancers express HER2 at low levels, rendering HER2 monoclonal antibodies like trastuzumab ineffective. Genetic modification of T cells is one attractive approach to overcome this limitation and we have constructed a 2nd generation HER2-specific chimeric antigen receptor (CAR) containing the HER2-specific single chain fragment FRP5, a transmembrane domain, and a CD28.ζ costimulatory/signaling domain (HER2-CAR). T cells expressing HER2-CARs (HER2-CAR T cells) had potent antitumor activity in preclinical animal models. Based on these preclinical findings we developed three Phase I/II clinical studies for patients with lung cancer, osteosarcoma, and glioblastoma multiforme. Due to the adverse event reported after the infusion of 10¹⁰ HER2-CAR T cells after nonmyeloablative conditioning in a patient with colon cancer, we designed our trials without lymphodepleting chemotherapy starting at T-cell doses of 10⁴ cells/m² or 10⁶ cells/m². Our clinical studies for patients with osteosarcoma and lung cancer have recently opened for accrual and we have infused so far 6 patients with HER2-CAR T cells. Patients received cell doses between 10⁴/m² to 1x10⁵/m² cells. Infusions were well tolerated without systemic side effects, and no increase of proinflammatory cytokines (IL-2, IFN-γ, GM-CSF, TNF-α) in the patients' plasma was observed post infusion. HER2-CAR T cells were detectable for up to 5 weeks post infusion and localized to sites of disease. In conclusion, HER2-CAR T cells have shown promising antitumor activity in preclinical animal models. We are currently evaluating the safety and efficacy of HER2-CAR T cells in three Phase I/II clinical studies. Initial safety data is encouraging, warranting further active exploration of HER2-CAR T-cell based therapies for cancer.

497. A Recombinant Dimeric Ad3 Fiber Protein Triggers Opening of Epithelial Junctions in Solid Tumors and Improves Trastuzumab/Herceptin and Cetuximab/Erbitux Therapy in Mouse ModelsInes Beyer,¹ Hongjie Wang,¹ ZongYi Li,¹ Roma Yumul,¹ Andre Lieber.¹¹Division of Medical Genetics, University of Washington, Seattle, WA.

The effectiveness of cancer therapeutics is decreased by the blocking of intratumoral diffusion and/or physical masking of target receptors on malignant cells. In immunohistochemical studies of tumor sections from breast cancer or non-small cell lung cancer xenografts, we observed colocalization of epithelial junction protein with Her2/neu or with EGFR - tumor-associated antigens that are the targets for monoclonal antibodies i.e. trastuzumab (Herceptin) and cetuximab (Erbitux), respectively. In epithelial cells, adenovirus serotype 3 binding to the junction protein desmoglein 2 (DSG2) triggers events reminiscent of epithelial-to-mesenchymal transition, leading to the transient opening of intercellular junctions. This opening improves access to receptors, e.g. Her2/neu and EGFR1, that are trapped

in these intercellular junctions. In addition to complete virions, penton recombinant dodecahedral particles (PtDds) and dimeric Ad3 fiber domains (Ad3K-K), can trigger DSG2-mediated opening of intercellular junctions. In *in vitro* studies we show a significant improvement of trastuzumab dependent cell killing of the Her2/neu positive breast cancer cell line BT474M1 subsequent to treatment with the dimeric Ad3K fiber. We also tested whether the application of Ad3K-K would result in the improvement of trastuzumab or cetuximab therapy *in vivo*. In mouse models with xenograft breast cancer tumors (BT474-M1, HCC 1954) and xenograft lung cancer tumors (A549), Ad3K-K improved the efficiency of the monoclonal antibody used and enabled control of tumor growth in subcutaneous tumor models. We are currently testing a combination of Ad3K-K and cetuximab therapy in an orthotopic lung metastasis model, where we expect to see a benefit in the overall survival and control of tumor growth in the group that received the co-therapy. Our results have potential implication for cancer therapy with T-cells or encapsulated chemotherapy drugs.

498. Genetic Editing of T Lymphocyte Specificity for Safe and Effective Adoptive Immunotherapy

Pietro Genovese,^{1,2} Elena Provasi,^{2,3} Angelo Lombardo,^{1,2} Zulma Magnani,³ Pei-Qi Liu,⁴ Andreas Reik,⁴ Victoria Chu,⁴ David E. Paschon,⁴ Lei Zhang,⁴ Jurgen Kuball,⁵ Attilio Bondanza,³ Giulia Casorati,³ Fabio Ciceri,³ Claudio Bordignon,³ Philip D. Greenberg,⁵ Michael C. Holmes,⁴ Philip D. Gregory,⁴ Luigi Naldini,^{1,2} Chiara Bonini.^{2,3}

¹HSR-Telethon Institute for Gene Therapy, Milan, Italy; ²Vita Salute San Raffaele University, Milan, Italy; ³San Raffaele Scientific Institute, Milan, Italy; ⁴Sangamo BioSciences, Richmond; ⁵Fred Hutchinson Cancer Research Center, Seattle.

Transfer of a T cell receptor (TCR) from a high-avidity tumor-specific T cell (CTL) to polyclonal T cells may overcome the challenges of expanding rare tumor-specific CTLs under conditions that preserve function and prevent exhaustion. Unfortunately, the full potential of this approach is limited by the co-expression in the same lymphocyte of the endogenous and exogenous TCR chains, resulting in competition for surface expression and acquisition of novel unpredicted specificities due to TCR mispairing between the 4 chains, which might lead to dangerous autoreactivity. Thus, we developed two sets of Zinc Finger Nucleases (ZFNs) to target double-strand breaks to the constant regions of the TCR α (*TRAC*) and β (*TRBC1* and *TRBC2*) genes and disrupt their coding potential by the induced Non Homologous End Joining (NHEJ) repair process. We used a stimulation protocol based on anti-CD3/CD28 antibody-conjugated beads and culture with low doses of IL-7/IL-15 to preserve cells with an early T cell differentiation phenotype. Upon stimulation, delivery of either ZFN set by Adenoviral vectors (Ad5/F35) resulted in functional inactivation of the target genes in primary T cells (>45%), as indicated by the generation of cells that lack surface expression of the CD3/TCR complex (CD3^{neg}). Once sorted, CD3^{neg} cells proved stable in culture for more than 50 days, maintaining an early T cell phenotype (CD62L⁺ CD28⁺ CD27⁺ IL7Ra⁺), and were permissive to further lentiviral vector (LV) transduction. For complete editing of T cell specificity, we selected a codon-optimized, cystein-modified TCR specific for the Wilm's Tumor Antigen 1 (WT1), involved in oncogenic transformation in several tumors, and developed a strategy for sequential disruption of each endogenous TCR chain followed by LV transfer of the respective WT1-specific chain. Using this approach we obtained a population of TCR-edited lymphocytes, carrying only the tumor-specific TCR that, in the absence of competition, was robustly expressed at physiological levels. Genetic editing did not affect the proliferative potential and the clonability of engineered cells nor their capacity to differentiate into effector and effector memory T

cells. TCR-edited lymphocytes were superior to conventional TCR-transferred cells in WT1 pentamer binding, specific recognition and lysis of WT1^{pos} targets, including primary acute myeloid leukemia blasts. Importantly, these cells showed sharply reduced non-specific reactivity, including alloreactivity, demonstrating the advantage of preventing TCR mispairing. Overall, our results demonstrate that full genetic editing of T cell specificity is feasible, and allows the rapid generation of effective and safe T cells for adoptive immunotherapy.

499. Primary Human CD8⁺ T Cells Engineered To Express a PD1-CD28 Chimeric Receptor Are Co-Stimulated through the Exploitation of Tumor Expressed PD-L1

Megan E. Prosser,¹ Christine E. Brown,¹ Michael C. Jensen.²

¹Department of Cancer Immunotherapeutics and Tumor Immunology, Beckman Research Institute of the City of Hope, Duarte, CA; ²Center for Immunity and Immunotherapies, Seattle Childrens Research Institute, Seattle, WA.

Adoptive immunotherapy is a promising therapeutic approach for the treatment of malignancies. However, several challenges must be addressed to enhance therapeutic efficacy, including the loss of effector function of adoptively transferred cells in the tumor microenvironment. Tumors elicit multiple mechanisms for immunosuppression of transferred cells including deficiency of costimulation and expression of inhibitory ligands. T cell activation requires both antigenic stimulation through the T cell receptor as well as a costimulatory second signal. This secondary costimulatory signal is commonly deficient within the tumor microenvironment resulting in T cell anergy. In addition, tumors often express the inhibitory ligand Programmed Death Ligand 1 (PD-L1) which interacts with Programmed Death 1 (PD-1) expressed on the T cell surface, resulting in T cell exhaustion, characterized inhibition of TcR signaling, and enhanced apoptosis. We hypothesize that the development of a PD1-CD28 chimera could exploit the PD-L1 tumor derived inhibitory mechanism to result in tumor-induced costimulation and maintenance of effector function of adoptively transferred CD8⁺ T cells, thereby addressing the two aforementioned immunosuppressive mechanisms. Preliminary assessment of this PD1-CD28 chimera in transformed cells reveals that fusion of the PD1 extracellular domain to the intracellular signaling domain of CD28 does not alter PD-L1 binding to the extracellular PD-1 moiety. Furthermore, the chimera results in increased phosphorylation of ERK and AKT suggesting increased signaling through CD28- and TCR- signaling pathways in transformed cells upon ligand binding. In addition, this PD1-CD28 chimera results in increased costimulatory cytokine production in both transformed T cell lines as well as primary human CD8⁺ T cells. The PD1-CD28 chimera also provides a proliferative advantage, as well as increased accumulation of cytotoxic granules for CD8⁺ T cells. This work suggests that genetically engineering T cells to express the PD1-CD28 chimera may exploit an intrinsic tumor immunosuppressive mechanism to result in costimulation and maintenance of effector function of adoptively transferred cells.

500. CD56-Specific T Cells Can Distinguish between Allogeneic and Autologous CD56⁺ Targets

Denise L. Kellar,¹ Sonny Ang,¹ Simon Olivares,¹ Helen Huls,¹ Laurence J. N. Cooper.¹

¹Division of Pediatrics, UT MD Anderson Cancer Center, Houston, TX.

Some candidate tumor-associated antigens (TAAs) are also expressed on T cells limiting the use of targeted T-cell therapy. CD56 is an attractive TAA with expression on many malignancies, yet CD56 upregulation on a subset of activated T cells could lead to

self targeting, i.e. autolysis. We show here that a chimeric antigen receptor (CAR) can be generated with specificity for CD56. Primary human T cells were electrotransferred with a CD56-specific CAR (CD56RCD28) and CAR⁺ T cells were selectively propagated on γ -irradiated CD56⁺ artificial antigen presenting cells (aAPC) in the presence of exogenous recombinant IL-2 and IL-21. Surprisingly, a subset of CD56RCD28⁺ T cells co-expressed the CD56 antigen. With these data, we tested if CD56⁺CD56RCD28⁺ T cells could evade autolysis. A CD19-specific CAR (CD19RCD28) was expressed on control T cells, representing a CAR without self-targeting capacity. There were no significant differences between percent CD56 expression on, nor the expansion rate of, CD19RCD28⁺ T cells compared with CD56RCD28⁺ T cells over 28 days inferring that CD56-specific T cells are not lysing themselves. CD56RCD28⁺ T cells are functional as demonstrated by CD56-specific redirected cytotoxicity against a panel of allogeneic CD56⁺ tumor cells including neuroblastoma, small cell lung carcinoma, and glioma. To investigate the origin and proliferative capacity of CD56⁺ T cells, we sorted the CD56RCD28⁺ T cells into CD56^{neg} and CD56⁺ fractions. The population of CD56⁺CD56RCD28⁺ T cells maintained CD56 expression and expanded over 14 days in a CAR-dependent manner implying that the CD56⁺CD56RCD28⁺ T cells did not predominately arise from CD56^{neg}CD56RCD28⁺ T cells gaining CD56 expression. Next, we determined if CD56RCD28⁺ T cells were capable of lysing autologous CD56⁺ lymphocytes with and without CAR. Significantly, the CD56⁺CD56RCD28⁺ T cells were resistant to autolysis by CD56RCD28⁺ T cells while autologous CD56⁺CAR^{neg} T cells, CD56⁺CD19RCD28⁺ T cells, and NK cells were lysed, confirming that CD56RCD28⁺ T cells cannot lyse CD56⁺ T cells co-expressing this CAR. CD56RCD28⁺ T cells did not upregulate expression of CD69, express CD107a or produce IFN- γ in the presence of autologous CD56⁺CD56RCD28⁺ T cells, but did exhibit all three characteristics of activation in the presence of autologous CD56⁺CAR^{neg} T cells, CD56⁺CD19RCD28⁺ T cells, and NK cells. This lack of activation in response to CD56 on CD56RCD28⁺ T cells infers that these T cells can avoid autolysis. To conclude, our data demonstrate that we can express a CD56-specific CAR on T cells despite the co-expression of CD56 and these genetically modified T cells can target tumor cells while evading autolysis. These data show clinical potential for CD56RCD28⁺ T cells against a multitude of CD56⁺ tumors and shed light on a unique phenomenon of evasion of CAR-mediated lysis which could impact T-cell based therapies.

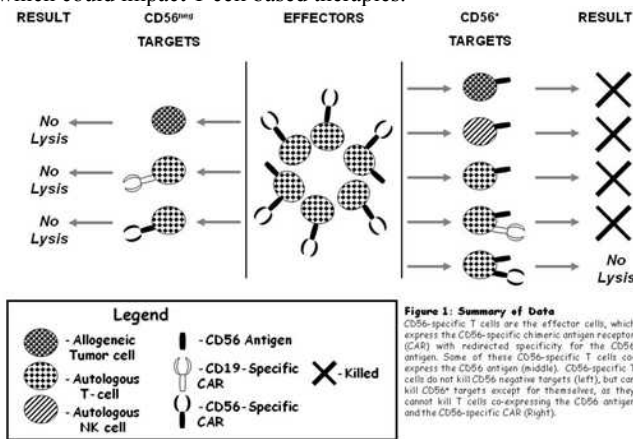

501. Chimeric γ -Cytokine Receptors That Support Engraftment of Human CD8⁺ Cytolytic T Lymphocytes

Michelle R. Hunter,¹ Vaidehi Mahadev,¹ Christine E. Brown,¹ Michael C. Jensen.²

¹Beckman Research Institute City of Hope National Medical Center, Duarte, CA; ²Center for Immunity and Immunotherapies, Seattle Children's Research Institute, Seattle, WA.

Therapeutic responses following adoptive transfer of cytotoxic T lymphocytes (CTLs) correlates with the duration and magnitude of their persistence. Iatrogenic lymphodepletion and exogenous IL-2 administration can improve CTL persistence following adoptive transfer, but their effects are not uniformly achieved and toxicities are significant. We hypothesized that the engineering of a cell intrinsic constitutive γ c cytokine receptor signaling could overcome these limitations. Here we describe chimeric human γ c cytokine receptors (C γ CRs) composed of an Interleukin-7 (IL-7) tethered to IL-7R α (CD127) extracellular/Tm domain and cytoplasmic domains capable of heterodimerization with γ c to induce STAT5 phosphorylation. We show that this design is modular in that the IL-2R β (CD122) cytoplasmic chain can be swapped for IL-7R α , enhancing the C γ CRs Shc activity. When expressed in primary human CD8⁺ CTLs by lentiviral transduction, these C γ CRs support cytokine independent viability and proliferation over prolonged periods of time *in vitro*. C γ CR⁺ CD8⁺ CTLs retain effector function as measured by TCR/CD3 complex-dependent cytolytic activity and cytokine secretion. Importantly, C γ CR⁺ effector CTLs exhibit cytokine-independent engraftment in NOG mice for a period of approximately 3 weeks after which time cell attrition occurred, and persistence of dysregulated/transformed cells was not observed. On going studies in the laboratory are focused on regulating the expression of C γ CRs with clinical compatible small molecule transgene expression regulatory elements.

502. Novel Immunotherapy of Spontaneous Canine Malignant Melanoma: Intra Tumor Immune Stimulation and Long Term Survival with Adenovector CD40 Ligand Therapy

Sara Westberg,¹ Arian Sadeghi,² Angelika Loskog,² Thomas Segall,³ Olle Korsgren,² Thomas Tötterman,² Henrik von Euler.⁴

¹University Animal Hospital, Swedish University of Agricultural Sciences (SLU), Uppsala, Sweden; ²Department of Immunology, Genetics and Pathology, Uppsala University, Uppsala, Sweden; ³Department of Pathology and Wildlife Diseases, National Veterinary Institute, Uppsala, Sweden; ⁴Center of Clinical Comparative Oncology, Department of Clinical Sciences, Swedish University of Agricultural Sciences (SLU), Uppsala, Sweden.

Introduction: Skin-derived Canine melanomas (CM) are usually benign, in contrast to the human equivalent. Most canine oropharyngeal, uveal, and mucocutaneous melanomas are aggressive with a high metastatic potential. Melanomas represent about 4% of all canine tumors, and are the most common malignant oral tumors. Surgery, radiotherapy and chemotherapy are widely used but seldom curative in advanced stages in both humans and dogs. It is proposed that malignant human melanomas and malignant CM share the same genetic factors leading to tumor development and metastatic spread. CM is a more accurate model for human malignant melanoma than traditional murine models since dogs are outbred, immune competent and share the same environment as humans. The homology of the human and the canine CD40L molecule is 85%. The similarities between human and canine melanoma thus make spontaneous canine melanoma an excellent disease model for exploring novel therapies. Herein, we report a pilot study of local Adenovector huCD40L immunogene (AdCD40L) treatment in 13 cases of malignant CM.

Materials and Methods: The group consisted of 9 oral, 3 skin and one conjunctival melanoma; in WHO-stage I;3, II;2, III;7 and IV;1. AdCD40L intratumoral injections (1-6, with a 7 days cycle) were followed by cytoreductive surgery in 8 cases, where 5 cases had immunotherapy only. Tumor tissue sampled pre and post treatment was investigated for immune cell infiltration. T-cell stimulation with AdCD40L transduced tumor cell lines was also performed. **Results:** After treatment, tumor tissue was infiltrated with lymphocytes suggesting immune activation. Best overall response was: 5 CR, 5 PR, 2 SD and 1 PD according to WHO-response criteria. At abstract submission median survival was 160 days (29-973) and 6 of the dogs were still alive. Two of the 7 deceased dogs were euthanized for causes other than CM. Transient fever and swelling at the injection site in some dogs was the only observed adverse event. A significant interferon gamma response was detected in co-cultures of dog T-cells and AdCD40L-transduced dog tumor lines. **Conclusions:** The AdCD40L vector is easy to administer intra- and peritumorally, shows only minor side effects and most importantly generates anti-tumor responses. The results of this pilot study warrant a prospective trial of malignant CM treated with a fixed numbers of AdCD40L injections and standardized follow-up protocols. Our results indicate that local AdCD40L immunogene therapy is beneficial and safe in malignant CM.

503. Improved Expansion and Anti-Tumor Activity of Tumor-Specific CTLs Using a Transgenic Chimeric Cytokine Receptor

Ann M. Leen,¹ Usha Katari,¹ Jacqueline Keirnan,¹ Cliona M. Rooney,¹ Malcolm K. Brenner,¹ Juan F. Vera.¹

¹Baylor College of Medicine, Texas Childrens Hospital, The Methodist Hospital, Houston, TX.

Survival and expansion of tumor-specific cytotoxic T lymphocytes (CTLs) is crucial for optimal in vivo efficacy of T cell therapies. Although IL2 administration may produce these effects, it is associated with toxicity and expansion of inhibitory T cell populations which limit benefit. Transgenic expression of the IL7 receptor can improve CTL survival and expansion, but is of benefit only with repeated exogenous administration of IL7 cytokine, which is expensive, relies on the availability of clinical grade product, and which may be at inadequate concentrations at the tumor site. We have therefore now manipulated T cell responses to IL4, a cytokine which is endogenously present in abundance in the microenvironment of several tumors and is otherwise associated with pro-tumorigenic actions including cancer cell proliferation, protection of tumor cells from apoptosis and repolarization of cytotoxic tumor-specific T cells to a suppressive Th2 phenotype. To reverse the inhibitory effects of IL4 on tumor-specific CTLs and instead enable them to utilize IL4 as a growth factor, we engineered a retroviral vector encoding the IL4Ra exodomain (cytokine-binding portion) fused with the endodomain (signaling domain) of the IL7R and linked with mOrange to allow transgene detection. To determine whether transgenic expression of chimeric IL4/7R improves CTL survival and expansion we used killing of Epstein Barr virus+ (EBV+) tumor by EBV-specific CTLs. After transduction, IL4/7R CTLs were detectable by flow cytometry (double positive mOrange, IL4R) in 13-76% of EBV-CTLs. The transgenic molecule was functional since addition of IL4 phosphorylated STAT5 only in EBV-CTLs/IL4/7R+ at levels similar to that achieved after IL2 administration. Both transgenic and control CTLs expanded in response to IL2 (increase from 1×10^6 to 3.5×10^7 and 5.3×10^7 cells, respectively), but only EBV-CTL/IL4/7R+ expanded in the presence of IL4 (1000U/ml) [from 1×10^6 to 2.9×10^7 vs 3.2×10^6 CTLs, respectively] over 1 week. As anticipated, the transgenic sub-population of EBV-CTL were positively selected in the presence of IL4 (increase from 13% to 80% in 1 week) compared to CTL cultured in IL2. Following expansion with IL4, transgenic CTL

remained polyclonal, with an effector-memory profile, and retained antigen specificity measured by IFN γ release, EBV-pentamer binding, and MHC-restricted killing of autologous EBV-LCLs. Importantly, CTL expansion remained strictly antigen and cytokine dependent, as withdrawal of either stimulus terminated expansion. These in vitro characteristics were replicated in vivo in a xenograft mouse model in which EBV-CTLs/IL4/7R expanded in response to IL2 or IL4 and maintained their anti-EBV-tumor activity. Finally, we cultured CTLs in the presence of supernatant harvested from IL-4-producing tumors. Only the transgenic CTL depleted the cytokine from the media. Hence, IL4/7R CTL may be able to utilize tumor-derived IL4 as a growth factor and serve as a sink that depletes the cytokine from the tumor microenvironment, thus starving the malignancy of a protein that would otherwise benefit tumor growth and survival.

504. Co-Delivery of PSA and PSMA DNA Vaccines with Electroporation Induces Potent Immune Responses

Bernadette Ferraro,¹ Neil J. Cisper,¹ Kendra T. Talbott,¹ Lindsey Philipson-Weiner,¹ Colleen E. Lucke,¹ Amir S. Khan,² Niranjay Y. Sardesai,² David B. Weiner.²

¹Department of Pathology and Laboratory Medicine, University of Pennsylvania School of Medicine, Philadelphia, PA; ²Research and Development, Inovio Pharmaceuticals, Blue Bell, PA.

Prostate cancer (PCa) remains a significant public health problem. Current treatment modalities for PCa can be useful, but may be accompanied by deleterious side effects and often do not confer long-term control. Accordingly, additional modalities, such as immunotherapy, may represent an important approach for PCa treatment. The identification of tissue-specific antigens engenders PCa an attractive target for immunotherapeutic approaches. Delivery of DNA vaccines with electroporation has shown promising results for prophylactic and therapeutic targets in a variety of species including humans. Application of this technology for PCa immunotherapy strategies has been limited to single antigen and epitope targets. We sought to test the hypothesis that a broader collection of antigens would improve the breadth and effectiveness of a PCa immune therapy approach. We therefore developed highly optimized DNA vaccines encoding prostate-specific antigen (PSA) and prostate-specific membrane antigen (PSMA) as a dual antigen approach to immune therapy of PCa. PSA-and PSMA-specific cellular immunogenicity was evaluated in a mouse model for co-delivery and single antigen vaccination. Mice received 2 immunizations spaced 2 weeks apart and immunogenicity was evaluated 1 week after the second vaccination. Both the PSA and PSMA vaccines induced robust antigen-specific IFN γ responses by ELISpot. Further characterization of cellular immunogenicity by flow cytometry indicated strong antigen-specific TNF α production by CD4+ T cells and IFN γ and IL-2 secretion in both CD4+ and CD8+ T cells. There was also a strong humoral response as determined by PSA-specific seroconversion. These data support further study of this novel approach to immune therapy of PCa.

505. Clinical and Manufacturing Update of the FANG™ Autologous Tumor Cell Vaccine

Phillip B. Maples,¹ Padmasini Kumar,¹ Yang Yu,¹ Fabienne Norvell,¹ Beena O. Pappen,¹ Nicolas Tacquet,¹ Alex W. Tong,¹ Gladice Wallraven,¹ Joseph Kuhn,² Minal Barve,³ Cynthia Bedell,³ John Nemunaitis,^{1,3,4,5} Neil Senzer.^{1,3,4,5}
¹Gradalis, Inc., Dallas, TX; ²General and Oncology Surgery Associates, Dallas, TX; ³Mary Crowley Cancer Research Centers, Dallas, TX; ⁴Baylor Sammons Cancer Center, Dallas, TX; ⁵Texas Oncology, P.A., Dallas, TX.

Gene modified cell-based cancer vaccines have demonstrated durable responses in selected patients. We have developed an autologous vaccine, FANG™, comprised of FANG™ plasmid transfected autologous tumor cells, which we believe will evoke a strong immune recognition /stimulation in vaccinated patients. The FANG™ nonviral vector system expresses both GM-CSF and a proprietary bifunctional shRNA to furin. Preclinical data demonstrated that blocking furin protein expression in turn blocked the activation of both TGFβ₁ and TGFβ₂. TGFβ overexpression is present in a wide range of cancers. The Phase I clinical trial (BB-IND 14205) has completed enrollment. We have successfully manufactured 39 FANG™ solid tumor vaccines under cGMP. Three other manufacturing processes did not meet specifications (one insufficient dose yield and two processes aborted due to contamination of incoming tumor tissue). Manufacturing data, including cell viability; GMCSF expression; furin, TGFβ₁ and TGFβ₂ knockdown and expression will be presented. We have treated 25 patients (9 currently on study) of which 9 patients have received 5 or more vaccine injections. The tumor types ranged from 6 colorectal, 4 melanoma, 4 ovarian, 3 hepatocellular, 2 breast, 2 sarcoma, 1 small cell lung cancer, 1 bile duct adenocarcinoma, 1 gall bladder, and 1 adenoid cystic carcinoma. The clinical results to date demonstrate that the FANG™ vaccines are safe and well tolerated. Side effects were limited to grades 1 and 2, primarily local reactions (erythema, bruising, tenderness, and induration). Possibly related were headache, iron deficiency anemia and generalized achiness. It is of interest to note that one patient with initially progressive gall bladder cancer completed the study regimen (after receiving 9 monthly injections) with stable disease. Immune and clinical response evaluations are ongoing and will be reported. Gradalis has received approval from FDA to begin a Phase II FANG™ clinical trial of ovarian cancer patients in an adjuvant setting at high risk for recurrence.

506. Highly Efficient Treatment of Ph⁺ Acute Lymphoblastic Leukemia with a DNA Vaccine and 6-Mercaptopurine in Mice

Yvonne Rott,¹ Stefanie Arndt,¹ Christina Marschke,¹ Melchior Lauten,¹ Manuel Schmidt,² Burghardt Wittig,^{2,3} Katrin Kalies,⁴ Jürgen Westermann,⁴ Joachim Köchling.¹
¹Department of Pediatrics, UKSH-Campus Lübeck, Universität zu Lübeck, Lübeck, Germany; ²Mologen AG, Berlin, Germany; ³Foundation Institute Molecular Biology and Bioinformatics, Freie Universität Berlin, Berlin, Germany; ⁴Institute of Anatomy, Universität zu Lübeck, Lübeck, Germany.

Acute lymphoblastic leukemia (ALL) is the most common malignancy in children. While risk adapted chemotherapy has tremendously improved the outcome of ALL in children with long term remission in 80%, only 40-50% of adult patients with ALL can be cured. Furthermore, an ALL relapse is still a major cause of death due to a malignant disease in children and adolescents. Especially, prognosis of patients with Philadelphia chromosome positive (Ph⁺) ALL still remains dismal and the risk of relapse is high. Therefore, new strategies are urgently needed to prevent a relapse and to treat minimal residual disease in those patients. Since 6-Mercaptopurine

(6-MP) is a standard component of ALL maintenance therapy, we compared the efficacy of a leukemia specific DNA vaccine with 6-MP to treat Ph⁺ ALL in Balb/c mice. Non-viral minimalistic immunogenically defined gene expression vectors (MIDGE) encoding a BCR-ABL^{p185} fusion specific peptide, GM-CSF and IL12 were used for *in vivo* transfection of murine skin. In addition, we used natural DNA-based double stem-loop immunomodulators (dSLIM), containing 6 CpG-motifs, as TLR-9 agonist. After the application of a lethal challenge dose of the syngeneic BCR-ABL^{p185} expressing leukemia cell line BM185, mice received either daily oral applications of 6-MP (50mg/m²/d) or were immunized twice with the DNA vaccine intracutaneously or received both 6-MP and the DNA-vaccine. Mice treated with 6-MP showed a significant longer tumor-free and overall survival compared to non treated mice (p<0.0001), but only 1 out of 10 mice survived. Compared to 6-MP the DNA vaccination resulted in a significant longer mean tumor-free survival (p= 0.007) and 19 out of 34 mice (56%) survived. Intriguingly, in combination 6-MP did not compromise the immune response. In contrast, the combined treatment with 6-MP and DNA vaccine resulted in a significant longer tumor-free and overall survival (p=0.033) compared to mice that were treated by the DNA vaccine alone, and all mice survived without developing leukemia. Immunization experiments and CTL assays revealed that BCR-ABL specific sequences are essential to prevent Ph⁺ ALL. In cell depletion studies we showed that both CD4⁺ T cells and natural killer cells and to a lower degree CD8⁺ cells contribute to the anti-leukemia effect of the DNA vaccine. In addition, we found a time dependent expression of BCR-ABL, GM-CSF and IL-12 mRNA at the vaccination site and within regional lymph nodes, indicating the migration of antigen presenting dendritic cells. In conclusion, we provide survival and functional data that 6-MP combined with a leukemia-specific DNA-vaccine acts synergistically in the treatment of Ph⁺ ALL. This promising approach might optimize maintenance therapy and decrease the relapse rate in patients with Ph⁺ ALL.

507. Berry Extract Enhances a Leukemia Specific DNA Vaccine in the Treatment of Minimal Residual Disease in Mice with Ph⁺ ALL

Yvonne Rott,¹ Melchior Lauten,¹ Hendric Ungefroren,² Michael Sagner,² Manuel Schmidt,³ Burghardt Wittig,^{3,4} Joachim Köchling.¹
¹Department of Pediatrics, UKSH-Campus Lübeck, Universität Lübeck, Lübeck, Germany; ²Department of Internal Medicine, UKSH-Campus Lübeck, Universität Lübeck, Lübeck, Germany; ³Mologen AG, Berlin, Germany; ⁴Foundation Institute Molecular Biology and Bioinformatics, Freie Universität Berlin, Berlin, Germany.

The outcome of patients with acute lymphoblastic leukemia (ALL) has been improved tremendously by risk adapted chemotherapy. However, the prognosis of patients with Philadelphia chromosome positive ALL (Ph⁺ ALL) still remains dismal and the risk of relapse is high. Not only leukemogenesis but also the incidence of relapse is dependent on the integrity of the immune system and there is evidence that the immune system plays an essential role for the eradication of remaining leukemic blasts. Thus, we suggest that anti-leukemia immune mechanisms might be enhanced by a leukemia specific DNA vaccine. Since chemotherapy compromises the immune system, compounds without immuno-suppressant activity should be developed for maintenance therapy. Anthocyanins are a group of naturally occurring phenolic compounds widely available in fruits and vegetables which possess several biological functions including anti-mutagenesis and anti-carcinogenesis. First, we evaluated the anti-leukemia efficacy of anthocyanins in several leukemia cell lines. Proliferation was significantly reduced in the murine Ph⁺ ALL cell line BM185 by anthocyanin-rich berry extract, cyanidin and dephinidin. In the leukemia cell lines HL-60 and K562 the efficacy of berry extract was superior compared to cyanidin and dephinidin.

Apoptosis was induced by upregulation of caspases 3, 8 and 9. Secondly, we compared the therapeutic efficacy of anthocyanins with a leukemia specific DNA vaccine to treat mice with minimal residual disease (MRD) of syngeneic Ph⁺ ALL. Non-viral minimalistic immunogenically defined gene expression vectors (MIDGE) encoding a BCR-ABL fusion specific peptide, GM-CSF and IL12 were used for *in vivo* transfection of murine skin. As TLR-9 agonist we used a DNA-based double stem-loop immunomodulator (dSLIM), containing six CpG-motifs. Following a lethal leukemia challenge mice received either daily oral applications of berry extract or intraperitoneal applications of cyanidin from day 1 – 21 or were immunized with the DNA vaccine on days 2 and 9. In addition, two groups received a combination of the DNA vaccine and berry extract or cyanidin. In contrast to the anti-leukemia activity *in vitro* the anthocyanins were not efficient to treat mice with Ph⁺ ALL *in vivo*. However, mice which received the DNA vaccine showed a significant longer tumor-free and overall survival compared to the control and a survival rate of 56%. Intriguingly, the combined treatment with DNA vaccine and berry extract but not with cyanidin further improved the outcome and lead to a significant longer tumor-free and overall survival compared to the DNA vaccine alone and a survival rate of 90%. In conclusion, we provide data that a leukemia-specific DNA vaccine and berry extract act synergistically in the treatment of mice with MRD. This approach may have implications to optimize maintenance therapy in patients with Ph⁺ ALL.

508. IL-21 Has an Anti-Apoptotic Effect on NK Cells during Activation

Vladimir Senyukov,¹ Cecele J. Denman,¹ Laurence J. N. Cooper,¹ Dean A. Lee.¹

¹Pediatrics, UT MD Anderson Cancer Center, Houston, TX.

Natural killer (NK) cells, as a key component of innate immunity, have recently shown clinical potential for adoptive immunotherapy against broad spectrum of oncological diseases. One of the major obstacles for adoptive NK cell immunotherapy is obtaining sufficient numbers of NK cells for effective therapy. To address this hurdle, we developed an artificial antigen presenting cells (aAPC) to expand primary NK cells *in vitro* using K562 cells gene-modified to express membrane-bound cytokine, and showed that mIL21 promoted stronger NK cells expansion than mIL15. To investigate this phenomenon we compared NK cell proliferation kinetics (by SFCE dilution) in parallel with daily assessment of apoptosis (by annexin V binding) in response to mIL15 and mIL21. We find that in the presence of mIL21 NK cells proliferated much faster than in response to mIL15 (fig. 1a). Moreover, in the presence of mIL15 as much as 90% of NK cells (versus 15% in presence of mIL21) became able to bind annexin V by the 3rd day after aAPC stimulation (fig1b). Furthermore, we have found that mIL21 up-regulated and supported CD160 expression by NK cells during expansion time (42% in presence of mIL21 vs 6% in response to mIL15 on day 3 and 83% vs 16% on day 7). CD160 is a GPI-anchored protein and its expression is down-modulated by GPI-specific phospholipase D and synthesis of which, in turn, is induced in NK cells in response to IL15 and IL2. It has been shown that CD160 signaling mediates PI3K-dependent survival and growth in CLL cells that was associated with up-regulation of Bcl-2, Bcl-xL, and Mcl-1. In addition to the herpes virus entry mediator that is a high affinity ligand for CD160 it has been shown that classical and nonclassical MHC class I molecules bind to CD160 with low affinity. The K562 cell line used to generate the aAPC is characterized as HLA-Cw3+/Cw5+, with low-level constitutive expression that can be augmented by IFN- γ . To verify if CD160 engagement with MHC class I is important for NK cell survival in this system we applied w6/32 antibodies to block HLA-C recognition. We stained fresh purified NK cells with CFSE and blocked Fc-receptors with human IgG to prevent CD16 involvement in NK cell activation. In parallel, irradiated

aAPC-mIL21 were incubated with w6/32 antibodies or with isotype-matched control antibodies and after washing cells were co-cultured with NK cells. We found that blocking of HLA class I recognition did not affect NK cell proliferation in response to aAPC-mIL21 (fig. 2a) but increased apoptosis (fig. 2b). This data suggests that IL21 might prevent activation-induced NK cell death through up-regulation of anti-apoptotic factors through a CD160-mediated mechanism. Future experiments will focus on identifying the mechanisms of suppressing apoptosis in this system.

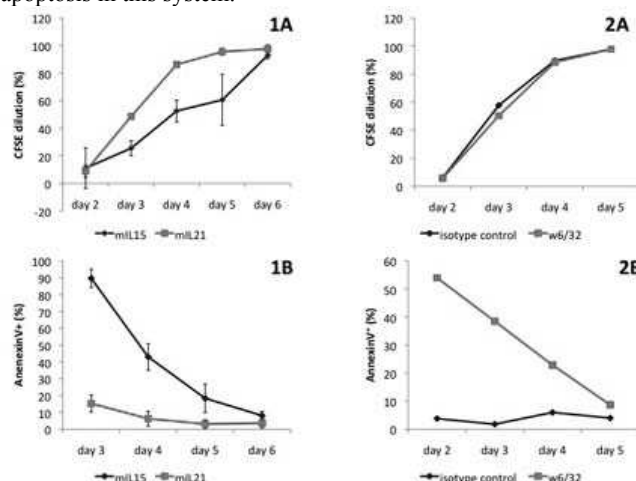

509. Dose Escalation of Therapeutic High-Capacity, Gutless Adenoviral Vectors in the Naïve Rat Brain: Pre-Clinical Safety and Toxicity Evaluation as a Prelude to a Phase I Clinical Trial for Glioma

A. K. M. G. Muhammad,¹ Mariana Puntel,¹ Weidong Xiong,¹ Kyle Kelson,¹ Alireza Salem,¹ Kurt M. Kroeger,¹ Chunyan Liu,¹ Catherine Farrokhi,¹ Liliana Lacayo,¹ Robert N. Pechnick,¹ Donna Palmer,² Philip Ng,² Pedro R. Lowenstein,¹ Maria G. Castro.¹
¹Cedars-Sinai Medical Center/UCLA, Los Angeles, CA; ²Baylor College of Medicine, Houston, TX.

Glioblastoma multiforme (GBM) carries a dismal prognosis with a median survival of 18-21 months post-diagnosis. We have recently demonstrated the therapeutic efficacy and high safety profile of intratumoral delivery of a novel, combined gene therapy consisting of first generation, or high-capacity adenoviral vectors (HC-Ads) encoding either the conditionally cytotoxic gene herpes simplex type 1-thymidine kinase (TK) or the immunostimulatory gene fms-like tyrosine kinase 3 ligand (Flt3L) transgenes in a syngeneic, orthotopic rat model of GBM. In anticipation of an upcoming dose finding, Phase I clinical trial for primary GBM, we herein performed a thorough assessment of the safety and toxicity of HC-Ads encoding TK and Flt3L upon administration into the naive rat brain. Lewis rats were injected intracranially with escalating doses of HC-Ad-TK and HC-Ad-TetON-Flt3L (1×10^8 , 1×10^9 , or 1×10^{10} vp of each) followed by systemic administration of gancyclovir and doxycycline. Rats were evaluated at 5 days, 1 month, 6 months and 12 months for biodistribution of HC-Ad vector genomes, HC-Ad vector induced behavioral deficiencies, neurotoxicity, peripheral blood cell counts and serum biochemistry, circulating levels of Flt3L, anti-adenovirus neutralizing antibodies, and anti-TK antibodies. Even at the highest dose tested, real-time quantitative PCR did not detect evidence of biodistribution of HC-Ad genomes to peripheral organs and a comprehensive panel of behavioral testing did not reveal any vector mediated abnormalities. Peripheral blood cell counts and serum biochemistry were within normal ranges during all time points, at all doses tested. Flt3L expression was tightly regulated, with

expression dynamics that coincided with the administration of the inducer doxycycline. However, a comprehensive neuropathological panel revealed evidence of neurotoxicity at the highest dose tested (1×10^{10} vp of each), i.e. loss of brain tissue, and high levels of inflammation. We did not detect any evidence of neurotoxicity or long-term inflammation at either lower dose tested. Taken together, these data indicate that 1×10^9 vp of each HC-Ad is the maximally tolerated dose (MTD) that can be safely administered into the brains of naïve Lewis rats. These well controlled, non-clinical safety and toxicity studies are required by the FDA in order to file of an IND and constitute a major milestone in the path towards implementation of the first ever Phase I clinical trial for GBM using gutless, HC-Ad vectors.

510. Role of STAT3 Signaling in TK/Flt3L Gene Therapy Mediated Brain Tumor Regression

Hikmat H. Assi,^{1,2} James Curtin,¹ Chunyan Liu,¹ Maria G. Castro,^{1,2} Pedro R. Lowenstein.^{1,2}

¹Gene Therapy Research Institute, Cedars Sinai Medical Center, Los Angeles, CA; ²Molecular and Medical Pharmacology, UCLA, Los Angeles, CA.

STAT3 signaling is constitutively active in high-grade tumors and its transcriptional activity is required by malignant cells for their proliferation well as promotion of an immunosuppressive tumor microenvironment. Recently pre-clinical models have investigated whether STAT3 antagonists can be used in combination with the immunotherapy to induce tumor cell death and enhance immune responses against GBM antigens. Owing to the multiple roles of STAT3 in both tumor cells and immune cells, we wished to investigate whether STAT3 signaling is involved in Ad-TK/Ad-Flt3L gene therapy-mediated T cell dependent brain tumor regression. We used adenovirus expressing STAT3 shRNA as well small molecule inhibitors to silence STAT3 and assessed its role in tumor cell proliferation as well as dendritic cell (DC) activity. We report that expression of STAT3 is up regulated in various syngeneic glioma mouse models. Treating GL26 or SMA560 glioma cells with the novel small molecule inhibitor CPA-7 blocks STAT3 *in vitro* and leads to cell death through a loss of Cyclin D, Bcl-x1 and survivin expression. We also show that STAT3 mediates the activation and maturation of DCs. Using bone marrow cells with GM-CSF we generated immature mouse DCs and examined the effects on DC maturation elicited by the TLR ligand CpG and the STAT3 inhibitor CPA7. Treatment of DCs with CPA-7 induced their maturation evidenced by increased expression of co-stimulatory molecules CD80, CD86 and CD40 as well as decreased antigen uptake indicative of a more mature phenotype. CPA-7 treatment enhanced the maturation activity of CpG. DCs treated with CPA7 in combination with CpG were able to better stimulate the proliferation of T cells in an allogeneic MLR when compared to DCs treated with CpG alone. We have previously demonstrated that intra-tumoral delivery of Flt3L and TK using adenoviral vectors drives T cell dependent tumor regression in intracranial syngeneic glioma (GBM) models in rodents (Ali et al, 2005; Curtin et al 2009; Candolfi et al, 2009). Intra-tumoral delivery of STAT3 shRNA, however, completely blocks Flt3L and TK mediated tumor regression compared with a scrambled non-specific shRNA. This was confirmed using the small molecule inhibitor CPA-7. Our data suggest that STAT3 signaling is involved in tumor cells' survival and DCs' functions, thus constituting an attractive therapeutic target for brain cancer.

511. An Enhanced Non Viral Vector (EEV) Giving Improved Responses in Immunogene Cancer Treatment over Standard Plasmid Vectors

Patrick F. Forde,¹ Lindsay J. Hall,¹ Marcel de Kruijf,¹ Gerald C. O'Sullivan,¹ Declan M. Soden.¹

¹Cork Cancer Research Centre, University College Cork, Cork, Ireland.

We compared the efficacy of an enhanced expression vector (EEV) with CMV standard plasmid vector for non viral immunogenetherapy of solid tumours. The EEV contains its own RNA replicase and transcribes mRNA cytoplasmically. The transgenes LacZ and GM-CSF/B71 were under the control of the CMV promoter. Comparison of the EEV with the standard vector in normal and growing tumours used quantitative RT-PCR, histological tools and *in vivo* murine tumour growth and survival curves. In all normal tissues (liver, spleen, and colon and oesophageal epithelium) there were significant increased RNA/DNA ratios for the EEV over the standard plasmid. The EEV gives superior results than standard vector in non viral immunogene therapy of solid growing tumours. The EEV was curative in two tumour models and has potential for clinical development. Antitumor responses of the EEV vector were both from immune cell recruitment to the tumour environment and the unrestrained RNA production in the cytoplasm.

512. A Novel Adjuvant Ling Zhi-8 Enhances the Efficacy of DNA Cancer Vaccine by Activating Dendritic Cells

Chi-Chen Lin,¹ Chia-Chiao Shih,¹ Ching-Liang Chu.²

¹Institute of Biomedical Sciences, National Chung Hsin University, Taichung, Taiwan; ²Yeastern Biotechnology Inc, Taipei, Taiwan.

DNA vaccine has been applied in cancer therapy, but the efficacy remains to be improved. The immunostimulatory effect of a fungal immunomodulatory protein Ling Zhi-8 (LZ-8) isolated from *Ganoderma lucidum* has been reported on human dendritic cells (DCs). In this study, we tested the adjuvanticity of LZ-8 for HER-2/neu DNA vaccine against p185^{neu} expressing tumor MBT-2 in mice. We found that recombinant LZ-8 activated mouse bone marrow-derived DCs via TLR4 and this stimulation was not due to any microbe contaminant. In addition, LZ-8 enhanced the ability of DCs to induce antigen-specific T cell activation *in vitro* and in a subunit vaccine model *in vivo*. Surprisingly, LZ-8 co-treatment strongly improved the therapeutic effect of DNA vaccine against MBT-2 tumor in mice. This increase of anti-tumor activity was attributed to the enhancement of vaccine-induced Th1 and CTL responses. Consistent with the results from DCs, the promoting effect of LZ-8 on DNA vaccine was diminished when the MBT-2 tumor cells were grown in TLR4 mutant mice. Thus, we concluded that LZ-8 may be a promising adjuvant to enhance the efficacy of DNA vaccine by activating DCs.

513. Prostate Cancer Immunotherapy Using Bi-Specific Tumor-Reactive T Cells

Robert C. Chan,¹ Ceidy Sanchez,¹ Anna Worth,¹ Ann M. Leen,¹ Malcolm K. Brenner,¹ Ganesh Palapattu,² Juan F. Vera.¹

¹Baylor College of Medicine, Texas Children's Hospital, The Methodist Hospital, Houston; ²Department of Urology, The Methodist Hospital, Houston.

Although localized prostate cancer (PC) can often be cured by surgery and/or radiation therapy, the therapeutic options for castrate-resistant disease (CRPC) are largely palliative, underscoring the need for alternative therapies. Like many other tumors, CRPC expresses tumor-associated antigens (TAAs), which are potential targets for immune destruction. However, tumors use multiple mechanisms of immune evasion including downregulation of target antigen

expression by direct deletion/mutation of TAA. Since an effective immune therapy therefore likely needs to recognize more than one TAA, we have generated bi-specific T cells which can recognize two different TAAs simultaneously. We constructed a humanized and codon optimized chimeric antigen receptor (hcCAR) targeting the tumor antigen Muc1, expressed in 90% of lymph node metastasis, and co-expressing a selectable marker (truncated CD19) to allow transgene detection. Transduction efficiencies ranged from 64-86.6%. The cytolytic activity of the transgenic T cells was tested in an 8 hr Cr⁵¹ release assay as well as in a 96 hr co-culture experiment using the Muc1(+) prostate cell lines PC3 and DU-145 as targets with 293T cells (Muc1 -ve) as a control. Transgenic T cells killed PC3 and DU-145 (32% ± 12% and 38.3% ± 9.98%, respectively, 20:1 E:T) unlike control T cells (14% ± 6% and 12% ± 2.94%). Killing was specific, since 293T cells were not killed by the transgenic T cells (12% ± 6.16%). These results were replicated in the co-culture experiments, clearly showing that T cells with single target antigen specificity were unable to completely eliminate the tumor. To determine the mechanism of failure, we measured Muc1 antigen expression on residual tumor cells, and found that the surviving malignant cells were Muc1 negative. Hence, heterogenous antigen expression can lead to tumor immune escape. To decrease the tumor escape by selection of antigen loss variants, we generated a second hcCAR targeting prostate cancer stem cell antigen (PSCA) which is another CRPC TAA of advanced stage disease. T cells transgenic for hcCAR/PSCA (detected using an antibody against the CH2-CH3 region present in the chimeric protein) killed the PSCA+ve cell line DU145 (48.67% ± 10.65% specific lysis at 20:1 E:T ratio) with no killing by control cells (12% ± 2.9%). Finally, to assess whether bi-specific T cells produced complete tumor elimination *in vitro*, we co-expressed hcCAR/Muc1 and hcCAR/PSCA in a single T cell. The transduction efficiency (double positive for CD19 and CH2-CH3) ranged from 40-61%. As before, single specific T cells did not eliminate tumor (36.2% – hcCAR/Muc1; 25.1% – hcCAR/PSCA; E:T – 10:1). However, co-expression of both CARs on a single T cell enhanced killing of tumor cells (74.2%, E:T 10:1), indicating that duplex targeting of CRPC-expressed tumor antigens may reduce tumor immune escape and increase clinical benefit.

Cancer-Oncolytic Viruses I

514. microRNA-Sensitive Oncolytic Measles Viruses for Cancer-Specific Vector Tropism

Mathias Felix Leber,¹ Sascha Bossov,¹ Vincent H. J. Leonard,² Karim Zaoui,¹ Christian Grossardt,¹ Marie Frenzke,² Tanner Miest,² Stefanie Sawall,¹ Roberto Cattaneo,² Christof von Kalle,¹ Guy Ungerechts.¹

¹Department of Translational Oncology, National Center for Tumor Diseases (NCT) and German Cancer Research Center (DKFZ), Heidelberg, Germany; ²Department of Molecular Medicine and Virology and Gene Therapy Track, Mayo Clinic College of Medicine, Rochester, MN.

Oncolytic measles viruses (MV) based upon the live attenuated vaccine strain have been engineered for increased tumor-cell specificity on the entry-level and tested preclinically for the treatment of a wide array of cancer types. Currently, measles virus vectors with natural vaccine strain tropism are under investigation in clinical trials including a phase I study for recurrent glioblastoma multiforme. Recent preclinical studies on several viruses have shown that their cellular tropism can be altered by inserting synthetic microRNA target sequences into their genomes. This modification inhibits virus spread in tissues expressing cognate microRNAs. MicroRNA-7 was shown to be downregulated in glioblastoma multiforme but highly expressed in healthy brain tissue. Here, we report the construction of an engineered, microRNA-sensitive

oncolytic MV carrying synthetic target sequences for neuron-specific microRNA-7 in the 3'-untranslated region of the viral fusion gene F. This modification prohibits translation of the F mRNA in presence of cognate microRNA thereby targeting a structural component of the virion. As expected, the insertion of microRNA target sites did not alter infectivity, spread and replication kinetics of the recombinant virus (designated MV-EGFP^{miR7}) in target glioblastoma cells. In cells expressing microRNA-7 virus spread and progeny production was strongly reduced leading to decreased viral titers. Even though highly attenuated in presence of cognate microRNA, MV-EGFP^{miR7} exhibited full oncolytic potency against glioblastoma cells *in vitro* and significantly retarded the growth of tumor xenografts *in vivo*. Importantly, microRNA-mediated attenuation protected genetically modified mice susceptible to measles virus infection from a potentially lethal intracerebral challenge. Moreover, fresh patient material from the invasion front of a glioblastoma multiforme was collected during surgery. Tissue blocks were prepared instantly and could be infected efficiently with unmodified vaccine strain virus; in clear contrast, replication and spread of microRNA-sensitive MV-EGFP^{miR7} was not supported. This is proof-of-concept that tropism restriction by differentially expressed microRNAs can be adapted to oncolytic measles viruses to regulate viral replication and gene expression. Thus, exploiting microRNA techniques might add another level of safety to next generation oncolytic measles viruses and elevate their therapeutic index without perturbing their potent oncolytic efficacy.

515. Envelope-Chimeric Entry-Targeted Measles Virus Escapes Neutralization and Achieves Oncolysis

Tanner S. Miest,¹ Koon-Chu Yaiw,¹ Marie Frenzke,¹ Johanna Lampe,¹ Andrew W. Hudacek,¹ Christoph Springfield,¹ Veronika von Messling,² Guy Ungerechts,¹ Roberto Cattaneo.¹

¹Department of Molecular Medicine, Mayo Clinic College of Medicine, Rochester, MN; ²INRS-Institut Armand-Frappier, University of Quebec, Quebec, Canada.

Measles virus (MV) is a promising vector for cancer therapy and multivalent vaccination, but high prevalence of pre-existing neutralizing antibodies may reduce therapeutic efficacy, particularly following systemic administration. MV has only one serotype, but here we show that its envelope glycoproteins can be exchanged with those of the closely related canine distemper virus (CDV), generating a chimeric virus capable of escaping neutralization. To target its entry, we displayed a single-chain antibody specific for human carcinoembryonic antigen (CEA) on the CDV attachment protein. To enhance oncolytic efficacy we armed the virus with a prodrug convertase gene capable of locally activating chemotherapeutic prodrugs. The new virus achieved high titers, was genetically stable, and was resistant to neutralization by sera from both MV-immunized mice and MV-immune humans. The new virus entered murine tumor cells through human CEA, and synergized with a chemotherapeutic prodrug in an immunocompetent mouse model of oncology. Importantly, the chimeric MV remained oncolytic when administered systemically even in the presence of anti-MV antibodies capable of abrogating the therapeutic efficacy of the parental, non-shielded MV. This work shows that targeting, arming and shielding can be combined to generate a tumor-specific, neutralization-resistant virus that can synergize with chemotherapeutics.

516. A Novel Therapeutic Regime To Eradicate Established Tumors with an Effective Induction of Tumor-Specific Immunity

James Tysome,¹ Xiaozhu Li,² Shengdian Wang,² Pengju Wang,³ Dongling Gao,³ Rathi Gangeswaran,¹ Dong Chen,⁴ Nick R. Lemoine,¹ Yaohe Wang.¹

¹Centre for Molecular Oncology and Imaging, Barts Cancer Institute, Queen Mary University of London, London, United Kingdom; ²Centre for Infection and Immunity, Institute of Biophysics, Chinese Academy of Sciences, Beijing, China; ³Sino-British Research Centre for Molecular Oncology, Zhengzhou University, Zhengzhou, China; ⁴Department of Pathology, Anzheng Hospital, Beijing, China.

Oncolytic viruses (OV) have been developed as a new approach for the treatment of cancer that is resistant to standard therapies. Although the clinical safety profiles of individual agents are encouraging, the efficacy of oncolytic viruses (OV) as monotherapy has been limited. Therefore, it is imperative to develop new strategies to improve the anti-cancer potency of these agents. Multiple doses of OV may not improve outcome due to the production of neutralizing antibodies by the host. However, several OV have been shown to induce tumor-specific immunity. Exploiting our knowledge of cancer cell biology, immunology and virology, we now have developed a novel therapeutic regime by sequential combination of oncolytic adenovirus and vaccinia virus, each of which have been used separately in the clinic. We demonstrated that three low doses of oncolytic adenovirus followed by three low doses of vaccinia virus resulted in a superior antitumor efficacy to the reverse combination, or six doses of either virus alone, against pancreatic and kidney tumor models in immune-competent Syrian hamsters. A complete response was seen in 62.5% of animals bearing either tumor type treated with the sequential combination *in vivo*, accompanied with an effective induction of tumor-specific immunity. Surprisingly, humoral immunity against the two viruses did not contribute to the enhanced efficacy of the sequential use of oncolytic adenovirus and vaccinia virus. Strikingly, depletion of T cells using our recently developed monoclonal antibody against Syrian hamster CD3 completely demolished the antitumor efficacy by the combination of oncolytic adenovirus and vaccinia virus. These findings demonstrate that sequential use of oncolytic adenovirus and vaccinia virus, both of which have been used individually in clinical trials, could be a promising approach for curing cancer in humans. These results have significance for the design of new regimens for cancer viro-immunotherapy and vaccines.

517. Armed and CD20-Retargeted Moraten Strain Measles Viruses for Combination Chemo- and Radiotherapy in Non-Hodgkin's Lymphoma

Tanner S. Miest,¹ Marie Frenzke,¹ Roberto Cattaneo.¹

¹Department of Molecular Medicine, Mayo Clinic College of Medicine, Rochester, MN.

Non-Hodgkin's lymphoma (NHL) comprises a common and diverse group of hematological malignancies. B-cell NHLs (B-NHL) are characterized by surface expression of CD20, a molecule unique to both normal and neoplastic B cells. Combination therapies for B-NHL target CD20 expression with monoclonal antibodies conjugated to ionizing radiation (Tositumomab ¹³¹I) and utilize chemotherapeutics like the purine analogue fludarabine phosphate (F-araAMP). We aim to combine CD20 specificity, ionizing radiation and chemotherapy with oncolytic viruses in the genetic background of a licensed measles virus (MV) vaccine strain, Moraten. This strain encodes functional P/V/C genes capable of antagonizing innate immunity, and has limited fusion capacity. We introduced hemagglutinin (H) mutations to ablate infectivity via natural MV receptors CD46 and SLAM, and expressed an anti-CD20 single-chain antibody and polyhistidine tag

on the carboxy terminus of H. The viruses expressed either purine nucleoside phosphorylase (PNP) to locally convert prodrugs into toxic metabolites, or sodium iodide symporter (NIS) to locally concentrate radioiodine. The viruses were named MV-vac2-PNP-H^{blind}-antiCD20 and MV-vac2-NIS-H^{blind}-antiCD20, and were rescued in parallel with their armed, natural tropism controls MV-vac2-PNP and MV-vac2-NIS. The previously described MV-NIS (Edmonston MVtag strain) was used as a control. MV-vac2-PNP and MV-vac2-NIS were dramatically less fusogenic than MV-NIS in cells expressing CD46 and/or SLAM, and grew to high titers. Both MV-vac2-PNP-H^{blind}-antiCD20 and MV-vac2-NIS-H^{blind}-antiCD20 were efficiently retargeted to CD20 and the anti-polyhistidine pseudoreceptor. *In vitro*, cells infected with MV-vac2-PNP and MV-vac2-PNP-H^{blind}-antiCD20 converted the prodrug MeP-dR into a toxic metabolite capable of killing uninfected cells. In a human B-cell lymphoma cell line, MV-vac2-NIS-H^{blind}-antiCD20 infection through CD20 lead to ¹²⁵I uptake, and cells infected with MV-vac2-NIS concentrated ¹²⁵I three to four-fold more efficiently than cells infected with MV-NIS. When injected intratumorally into human B-cell lymphoma xenografts, MV-vac2-NIS achieved tumor responses equal to MV-NIS despite being dramatically less fusogenic, while MV-vac2-NIS-H^{blind}-antiCD20 remained oncolytic when entering tumor cells through CD20. Future studies are aimed at testing synergy between our armed viruses and chemo- and radiotherapeutics *in vivo*, and characterizing the factors, notably cell-cell fusion, that influence differences in oncolytic efficacy and transgene function between the Moraten and Edmonston-MVtag strains.

518. Radiation Combined with Oncolytic Adenovirus Vector Suppresses Tumor Growth Better than Either Treatment Alone in the Syrian Hamster Model

Brittany A. Young,¹ Jacqueline F. Spencer,¹ Karoly Toth,¹ William S. M. Wold.¹

¹Molecular Microbiology & Immunology, Saint Louis University School of Medicine, St. Louis, MO.

Our laboratory and others have described the Syrian hamster model for evaluating the anti-tumor efficacy and toxicity and biodistribution of oncolytic adenovirus serotype 5 (Ad5)-based vectors. The advantages of this model are that hamster tumors and normal tissues are permissive for replication of Ad5 and of our Ad5-based oncolytic vector VRX-007. Also, the hamsters are immunocompetent. We have reported previously that intratumoral injection of VRX-007 suppresses the growth of subcutaneous tumors formed by injection of hamster HaK renal cancer cells, and that VRX-007 replicates in these tumors. We also reported that when the hamsters are immunosuppressed using cyclophosphamide, VRX-007 replication in the tumors and suppression of tumor growth are enhanced; this result implies that vector replication in the tumors may be important in suppressing tumor growth and that the immune response to the vector limits the anti-tumor efficacy of the vector. A number of labs including ours have reported, using the human xenograft-immunodeficient mouse model, that the combination of whole body x-ray irradiation plus oncolytic Ad vector therapy is better at suppressing tumor growth than either treatment alone. In this report we have investigated the combined effects of irradiation and VRX-007 in the HaK-tumor Syrian hamster model. We found that whole body irradiation increases the replication of VRX-007 in the liver following intravenous administration of VRX-007; therefore, whole body irradiation is not an optimal approach. We then designed a device that limits irradiation to the tumor. Using this device with immunocompetent hamsters bearing subcutaneous HaK tumors, we found that the combination of irradiation and intratumoral injection of VRX-007 is better at suppressing HaK tumor growth than either treatment alone. With the combination treatment, the tumor growth

was suppressed nearly completely for two months (the end of the study). The neutralizing antibody response to VRX-007 in both the vector-only and the combination groups was equally high (~1:7,000). When examined by Tissue Culture Infectious Dose 50 assay at two months post infection, no VRX-007 was found in the tumors or the livers. The mechanism by which tumor growth is suppressed for so long in the hamsters treated with the combination therapy remains to be explained.

519. A Novel CDC25B Promoter Based Oncolytic Adenovirus Suppresses Tumor Growth in an Orthotopic Human Pancreatic Cancer Model

Helga L. Weber,^{1,2} Gidekel Manuel,² David T. Curiel,³ Eduardo G. Cafferata,¹ Osvaldo L. Podhajcer.¹

¹Laboratory of Molecular and Cellular Therapy, Fundacion Instituto Leloir, IIBBA-CONICET, Buenos Aires, Argentina; ²Lab. Venture, Universidad Adolfo Ibañez, Santiago, Chile; ³Division of Human Gene Therapy, UAB, Birmingham.

Pancreatic Cancer is one of the most aggressive types of cancer, with an overall 5 year survival rate of approximately 3-5%. In the present study we constructed a novel conditionally replicative oncolytic adenovirus (CRAd) with the aim to target pancreatic cancer. Based on global gene expression studies from the literature we decided to clone the human version of the cdc25B promoter to regulate adenovirus E1A expression, since cdc25B gene is overexpressed in more than 70 % of pancreatic tumors (in addition to gastric and colon cancer) while faint or no expression was observed in chronic pancreatitis and pancreatic normal cells. After in vitro analysis of different promoter variants, we selected a 468 bp fragment extending from -426/+42 that includes two SP1 sites, a TATA box and an INR motif. Using luciferase activity as a reporter gene we observed that the 0.5 Kb Cdc25-Pr was in average 10-fold more active in pancreatic cancer cells (SW1990, BxPC3, HS766T, MIA Paca2 and Panc1) than in fibroblasts (WI-38, HFL-1 and HACAT) and human microendothelial cells (hMEC-1). These in vitro lytic effects correlated with cdc25B expression in the different cell types. Parallel studies demonstrated that pancreatic cancer cells exhibited 2-fold increased infection with adenovirus pseudotyped with a chimeric 5/3 (shaft/knob) fiber, compared with the parental adenovirus type 5 or pseudotyped with RGD residues. The novel AV-5/3-Cdc25(468) exhibited a strong in vitro lytic effect on pancreatic, gastric and colon cancer cells, even at MOIs of 0.1, while it showed a highly attenuated effect on different normal fibroblasts. Moreover, it showed a synergistic effect with gemcitabine, in highly resistant, SW1990 pancreatic cancer cells. In vivo administration of AV-5/3-Cdc25(468) combined with 15 mg/kg gemcitabine, on mice harboring ectopic SW1990 pancreatic tumors, almost abrogated tumor growth with 100% survival of treated mice after 100 days follow up. Moreover, mice harboring 15-days old SW1990 orthotopic tumors, injected intratumorally once or twice with the virus, in combination or not with gemcitabine, exhibited in average 70%-80% reduction in tumor size at day 45 compared to control PBS-treated mice. The persistence of the CRAd at the end of the experiment was confirmed by E4 DNA analysis. Interestingly, in mice treated with the CRAd+gemcitabine a return to normal levels of alanine transaminase, aspartate aminotransferase and pancreatic amylase was observed. These mice also exhibited more than 90% reduction in CA19.9 serum levels compared to control PBS-treated mice. In order to evaluate their safety, we analyzed CRAd replication on ex-vivo hamster tissue explants. With the exception of liver, Ad5/3-WT replicated in every Syrian hamster tissue tested, while AV-5/3-Cdc25(468) exhibited no replication nor in liver, neither in stomach, lung or pancreas. In conclusion, these data demonstrate that AV-5/3-Cdc25 (468) is an effective oncolytic agent for pancreatic cancer treatment.

520. The Effect of Combination Therapy of Oncolytic Virus hrR 3 and Antiangiogenic Therapy Bevacizumab in an Experimental Model of Pancreatic Carcinoma

Tevfik T. Sahin,¹ Hideki Kasuya,¹ Akiyuki Kanzaki,¹ Kazuo Yamamura,¹ Suguru Yamada,¹ Takashi Sugae,¹ Gewen Tan,¹ Yoko Nishikawa,¹ Tsutomu Fujii,¹ Shuji Nomoto,¹ Hiroyuki Sugimoto,¹ Akimasa Nakao.¹

¹Department of Surgery II, Nagoya University Graduate School of Medicine, Nagoya, Japan.

Aim: Tumors release proangiogenic growth factors in response to hypoxia or mutations. These act in a paracrine manner, stimulating endothelial cells to proliferate and migrate into the tumor. Vascular endothelial growth factor is an endothelial cell growth factor that facilitates neoangiogenesis. Overexpression of VEGF are found in 90% of pancreatic cancers and are linked with poor prognosis. The effect oncolytic herpes viruses (OHSV) on angiogenesis are not accurately determined. Some studies on wild type herpes simplex type1 (HSV1) have been shown to enhance VEGFA. Combination of OHSV hrR3 with antiVEGFA antibody bevacizumab is expected to be superior to either therapy alone. The aim of the present study is to evaluate the effect of combination of OHSV hrR3 with a novel VEGFA antibody bevacizumab in a BxPc3 xenograft experimental model. **Materials and Methods:** AsPC-11, BxPc3, MIA PaCa-2 were tested for expression of VEGFA both with western blot analysis and reverse transcriptase polymerase chain reaction. BxPc3 cell line had the highest expression of VEGFA and therefore chosen for the invitro experiment. Twenty BALB-C nu/nu mice were divided into 4 experimental groups. All animals were implanted 5 mm diameter of BxPc3 tumor xenograft on each side of their flank. After 2 week of observation; Control group (n=5) received no therapy; oncolytic viral therapy group (OVT) (n=5) received 5x10⁶ pfu hrR3 injected intratumorally per week for two weeks; bevacizumab treated group (BVT) (n=5) received 5mg/kg bevacizumab intraperitoneally two times a week for 3 weeks; Combination therapy group (CT) (n=5) received both bevacizumab and hrR3 virus injected intratumorally the same periods as other groups. Tumor diameters were evaluated every 3 days by caliper for 8 weeks. 2 weeks following the last dose of the viral administration; tumors at one side were resected for histopathological analysis which included conventional hematoxylin eosin stain, immunohistochemistry for VEGFA, Thrombospondin1, CD31 traced microvascular density, HSV1 antigen and colorimetric TUNEL for apoptosis. **Results:** All the animals in CT group were free of tumor. The tumor volumes of the animals in the combination therapy were significantly lower than other groups (p<0.05). Following the last dose of bevacizumab tumors started to increase in volume. In OVT there were no recurrences and the tumor volumes were stable. We were unable to show a statistically significant difference among OVT and BVT groups in terms of tumor volume. The CT and the OVT group had degenerated cells and low cellular density and expressed HSV antigen. Interestingly we found highest VEGFA expression in OVT group when compared to other groups (p<0.001). **Conclusion:** Oncolytic virus seems to induce the VEGFA and may be a proangiogenic stimulus. Combination therapy blocking VEGFA can be administered with OHSV; which can increase the effect of the virus. Therefore; combination of OHSV with an antiangiogenic agent is a safe and effective treatment modality.

521. Armed and Targeted Measles Virus for Virotherapy of Chemoresistant Pancreatic Cancer

Christian Grossardt,¹ Sascha Bossov,¹ Achim Temme,² Mathias F. Leber,¹ Stefanie Sawall,¹ Roberto Cattaneo,³ Christof von Kalle,¹ Guy Ungerechts.¹

¹Department of Translational Oncology, National Center for Tumor Diseases (NCT) and German Cancer Research Center (DKFZ), Heidelberg, Germany; ²Department of Neurosurgery, University Hospital Carl Gustav Carus, TU Dresden, Dresden, Germany; ³Department of Molecular Medicine and Virology and Gene Therapy Track, Mayo Clinic College of Medicine, Rochester, MN.

Pancreatic cancer is one of the most drug-resistant types of malignancy, with extremely poor prognosis and survival rate. Over the past 10 years, gemcitabine has been the front line chemotherapy to treat non-resectable and metastasized pancreatic cancer, ultimately not preventing a progressive disease. Measles viruses (MV) derived from vaccine strain have shown considerable oncolytic activity against lymphomas and a wide variety of solid adenocarcinomas from different entities and are a promising tool to treat pancreatic cancer. Since prostate stem cell antigen (PSCA), originally identified as a marker for prostate cancer, is also expressed on pancreatic adenocarcinoma but not on non-neoplastic tissue, we generated a fully retargeted MV for the treatment of pancreatic adenocarcinoma. Therefore, we fused a single chain antibody (scFv) specific for the extracellular domain of PSCA as a C-terminal extension to the MV attachment protein H which was blinded for the natural MV receptors CD46/SLAM. PSCA expression levels differ within heterogeneous tumor bulks and between human pancreatic cancer cell lines. We were able to show that cell lines with high- and low-level PSCA expression were susceptible to PSCA-retargeted MV. Furthermore, we engineered a PSCA-targeted MV armed with the prodrug convertase purine nucleoside phosphorylase (PNP) – MV-PNP-antiPSCA. PNP converts the prodrug fludarabine to the highly toxic and diffusible 2-fluoroadenine substantially enhancing the oncolytic efficacy of the virus on infected and bystander cells. Synergistic therapeutic effects were demonstrated in a subcutaneous BxPC-3 tumor xenograft model of pancreatic adenocarcinoma. The combined chemovirotherapy of intratumoral MV-PNP-antiPSCA application together with intraperitoneal administration of fludarabine yielded a potent synergistic oncolytic effect and resulted in a significant tumor regression compared to mice treated with virus or prodrug only. Importantly, with regard to future clinical trials no cross resistance of various gemcitabine-resistant pancreatic adenocarcinoma cell lines to MV mediated oncolysis and activated prodrug was detected.

522. Tumor-Selective Suicide Gene Therapy by Transcriptionally Targeted Replicating Retrovirus Vectors

Yi-Hui Lai,¹ Chien-Kuo Tai.¹

¹Department of Life Science, National Chung Cheng University, Min-Hsiung, Chia-Yi, Taiwan.

Replicating virus vectors are attractive tools for anticancer gene therapy, but the potential for adverse events due to uncontrolled spread of the vectors has been a foremost concern of investigators in the field of retroviral gene therapy. To design a tumor-selective replicating retrovirus vector (RRV), we replaced the 3' U3 region of the RRV ACE-GFP with a regulatory sequence consisting of the HBV enhancer II and the human alpha-fetoprotein (AFP) core promoter to produce a hepatocellular carcinoma (HCC)-targeting RRV ACE-GFP-EIIAFP. Similar to the vector ACE-GFP, ACE-GFP-EIIAFP exhibited robust GFP expression in various human HCC cells. Most importantly, ACE-GFP-EIIAFP showed tumor-specific replication in HCC cells but not in non-HCC tumor cells or primary normal liver cells. To examine the

structural stability of the ACE-GFP-EIIAFP vector genome during its replicative spread, we sequenced the promoter region of the vector collected from each replication cycle, and we found that the vector could retain the hybrid regulatory sequence in the genome over a long period. *In vitro* studies showed highly efficient cell killing to HCC cells by ACE-CD-EIIAFP which carries a suicide gene yeast cytosine deaminase after treatment with the prodrug 5-fluorocytosine (5-FC). For *in vivo* studies, ACE-CD-EIIAFP was injected intratumorally in a pre-established murine subcutaneous tumor model, and two weeks later 5-FC was administered intraperitoneally. Significant tumor suppression was observed in the therapeutic treatment and notably, no systemic spread of the vector to extratumoral tissues was detected by sensitive quantitative PCR. These results suggest that tumor-selective RRV encoding suicide gene may show great promise for cancer gene therapy.

523. BioKnife, a Urokinase-Targeted Oncolytic Sendai Virus, Eliminates Pleural Spread of Malignant Mesothelioma

Yosuke Morodomi,¹ Tokujiro Yano,¹ Hiroaki Kinoh,³ Yui Harada,² Satoru Saito,² Tsukihisa Yoshida,¹ Kensaku Ito,¹ Yasunori Shikada,¹ Riichiroh Maruyama,¹ Kumi Yoshida,² Yasuji Ueda,³ Mamoru Hasegawa,³ Yoshihiko Maehara,¹ Yoshikazu Yonemitsu.²

¹Department of Surgery and Science, Graduate School of Medical Sciences, Kyushu University, Fukuoka, Japan; ²R&D Laboratory for Innovative Biotherapeutics, Graduate School of Pharmaceutical Sciences, Kyushu University, Fukuoka, Japan; ³DNAVEC Corp, Tsukuba, Ibaraki, Japan.

Background: Malignant pleural mesothelioma (MPM) is highly intractable: therefore, novel therapeutics are much desired. It has been largely known that malignant tumors including MPM showing invasive and metastatic activity frequently express urokinase-type plasminogen activator (uPA) or its receptor (uPAR). We have recently developed a novel type of oncolytic virus based on Sendai virus, that shows fusogenic oncolysis via specific targeting to uPA/uPAR system (named as 'BioKnife: Kinoh H, et al. Gene Ther 2008, and Hasegawa Y, et al, Mol Ther 2010); therefore, we here investigated the therapeutic potential of the BioKnife to treat mesothelioma. Methods: Orthotropic mouse models of MPM were established by inoculation human MPM cell lines (MSTO-211H and NCI-H226) into the pleural cavity of nu/nu mice. BioKnife expressing green fluorescent protein (BioKnife-GFP) were administered to the pleural cavity of the tumor bearing mice. Results: The both human MPM cells exhibited multiple tumor nodules in the pleural cavity on day 7, and the all tumor bearing mice were dead within 50 days (MSTO-211H: uPAR high and uPA high) or 140 days (NCI-H226: uPAR high but uPA low). Dissecting fluorescent microscope demonstrated that GFP signal was detected specifically in the tumors but rarely in normal tissues, and immunofluorescent study revealed that extensive tunnel positive cells were detected in the tumors treated with BioKnife-GFP. Unexpectedly, repeated administration of BioKnife-GFP significantly prolonged survival of mice in both models (p<0.001), irrespective of the marked difference of uPA expression in these cells. Importantly, we here found that infection of BioKnife itself dramatically stimulated uPA expression from NCI-H226 via RIG-I/IRF3-dependent system, resulting the efficient oncolysis of this tumor. Conclusions: We here show that BioKnife was highly effective to eliminate uPAR-expressing MPM *in vivo*, irrespective of its base-line expression level of uPA. These results illustrate the potential of BioKnife as a novel therapeutic agent to treat MPM in clinical setting.

524. Complete and Sustained Tumor Regression of Human Malignant Mesothelioma Xenografts in Athymic Nude Mice Following Local Injection of Midkine Promoter-Regulated Oncolytic Adenovirus

Shuji Kubo,¹ Atsuko Tamamoto,¹ Nobutaka Okamura,¹ Yoshihiro Maeyama,¹ Masatoshi Tagawa,² Noriyuki Kasahara,³ Nobuyuki Terada,⁴ Haruki Okamura.¹

¹Laboratory of Host Defenses, Institute for Advanced Medical Sciences, Hyogo College of Medicine, Nishinomiya, Hyogo, Japan; ²Division of Pathology and Cell Therapy, Chiba Cancer Center Research Institute, Chiba, Japan; ³Department of Medicine, David Geffen School of Medicine, University of California Los Angeles, Los Angeles, CA; ⁴Department of Pathology, Hyogo College of Medicine, Nishinomiya, Hyogo, Japan.

Malignant mesothelioma is highly aggressive and generally non-curative. Therefore, new treatment paradigms are urgently needed. We have investigated the use of transcriptionally targeted oncolytic adenovirus as a novel therapeutic approach for this malignancy. We found that midkine (Mdk), a developmentally important heparin-binding growth factor, was significantly increased in six mesothelioma cell lines tested by quantitative RT-PCR, but was low or undetectable in normal cells. Mdk promoter is also highly activated in mesothelioma cells by luciferase reporter assay. On this basis, we constructed a conditionally replicating adenovirus (CRAd), in which the adenoviral E1 gene is driven by the Mdk promoter and is armed with the HSV-thymidine kinase (TK) suicide gene, and which also carries the enhanced green fluorescent protein marker gene. This oncolytic adenovirus, designated CRAd-Mdk-E1-iresTK, was seen to efficiently replicate, produce viral progeny, and spread in multiple established mesothelioma cell lines. Tumor-selective lytic spread of CRAd-Mdk-E1-iresTK was observed to mediate efficient killing of these mesothelioma cells, and its cytotoxic effect was significantly enhanced by treatment with the prodrug ganciclovir. Finally, intratumoral injections of the CRAd-Mdk-E1-iresTK caused complete regression of human mesothelioma xenografts in athymic mice. *In vivo* imaging demonstrated intratumoral spread of CRAd-Mdk-E1-iresTK-derived fluorescence signals, which then vanished after tumor eradication. In conclusion, the Mdk promoter is a feasible tumor-specific promoter for transcriptional targeting, and Mdk promoter-driven CRAd might be a promising general strategy for oncolytic virotherapy of Mdk-upregulated cancers.

525. Adenoviral-Mediated Interferon-alpha Gene Therapy for Pancreatic Cancer

Julia Davydova,¹ Leonard Armstrong,¹ Eric Brown,¹ Joohee Han,¹ Selwyn Vickers,¹ Masato Yamamoto.¹

¹Surgery, University of Minnesota, Minneapolis, MN.

Recently, interferon-alpha (IFN) therapy in conjunction with radiation and chemotherapeutics has emerged as a promising treatment for pancreatic cancer. However, despite encouraging results for survival rates in clinical studies employing this protocol, utilization of IFN-based regimen has been impeded by systemic toxicity of IFN and its unsustainable level in tumor sites. The employment of conditionally replicative adenoviruses (CRAd) constitutes a promising alternative for cancer treatment. We hypothesize that the development of a new modality combining chemoradiation therapy with an improved CRAd expressing IFN would significantly benefit both IFN-based treatment and oncolytic virotherapy of pancreatic cancer. The CRAd-mediated selective expression of IFN will avoid the systemic toxicity of current IFN chemoradiation regimens while sustained IFN expression via replication competent vector will yield extended response without vector dilution. In this work, we test this hypothesis by applying a new infectivity-enhanced CRAd expressing syngeneic IFN to treat pancreatic cancer. We designed a cyclooxygenase-2 (Cox2) promoter-

controlled CRAd expressing IFN in a replication-dependent manner. To increase CRAd potency, we enhanced the efficiency of cell lysis through overexpression of adenoviral death protein and equipped the vector with Ad5/Ad3 fiber. *In vitro* testing showed a robust treatment effect on highly aggressive metastatic pancreatic cancer cell lines. When compared to Ad5 wild type, this virus showed a comparable effect on S2VP10 cells, and was more powerful than Ad5wt when used on S2O13 cells. No oncolytic effect was observed in Cox2-negative BT474 cells, indicating cancer specificity. The cytotoxicity effect correlated well with IFN production in culture supernatant. The IFN concentration increased in a time- and dose-dependent manner after infection with oncolytic CRAd, indicating that IFN production depends upon viral replication. Of note, the replication-deficient IFN-expressing Ad required approximately three orders higher titers to successfully kill the pancreatic cancer cells when compared to replication-competent IFN-CRAd. To demonstrate *in vivo* antitumor effect, subcutaneous S2O13 xenografts in nude mice were treated with a single injection of IFN expressing viruses. Both therapeutic viruses rapidly attained statistical significance when compared to untreated control. A novel IFN-CRAd showed superiority over the nonreplicating counterpart by day 21 post treatment. Although the result is significant, the immunodeficient nature of the experimental animals limits demonstration of the IFN component's systemic immune-stimulatory antitumor effect. Therefore, we are currently assessing therapeutic potency and indirect antitumor effect of CRAd expressing hamster IFN in immunocompetent hamsters bearing syngeneic pancreatic cancer. These data indicate that infectivity-enhanced CRAd expressing syngeneic IFN is a powerful therapeutic modality for pancreatic cancer. This approach offers the potential to overcome the major obstacles of current IFN-chemoradiation and oncolytic virus therapies for pancreatic cancer patients.

526. Evaluation of the Effect of Herpes Oncolytic Virus R3616 on the Host Immune Responses

Kazuo Yamamura,¹ Hideki Kasuya,¹ Akiyuki Kanzaki,¹ Tefvik Tolga Sahin,¹ Tan Gewen,¹ Suguru Yamada,¹ Tsutomu Fujii,¹ Hiroyuki Sugimoto,¹ Shuji Nomoto,¹ Shin Takeda,¹ Akimasa Nakao.¹

¹Surgery II, Nagoya University School of Medicine, Nagoya, Japan.

Oncolytic virus therapy is becoming a promising anti-cancer therapeutic, and oncolytic viruses have been shown to elicit anti-cancer immunity. We evaluated the effects of the herpes oncolytic virus R3616 on the host immune response compared to a representative chemotherapy drug, 5-FU. R3616 or 5-FU was directly injected into the subcutaneous tumors of non-immunized mice. R3616 induced a greater number of tumor-infiltrating T cells, macrophages, and dendritic cells compared to 5-FU. MC26 cells plus R3616 or 5-FU as an adjuvant were used as means of immunization. After immunization, the adaptive immune response suppressed subcutaneous tumor growth and prolonged the survival rate of re-challenged mice. The group immunized with MC26 and R3616 had the greatest tumor suppression and the longest survival rate. We implanted MC26 tumors subcutaneously into each group of immunized mice, and then monitored the differences in the number of infiltrating CD8- and CD4-positive lymphocytes by immunofluorescence. The mice immunized with MC26 cells and R3616 showed the greatest number of infiltrating T cells in the implanted tumor among the immunized groups. These results indicate that the oncolytic herpes virus R3616 has the potential to elicit host anti-tumor immunity.

527. RdB-VSV-G, a Vesicular Stomatitis Virus Glycoprotein Epitope-Incorporated Oncolytic Adenovirus Shows Marked Enhancement in Oncolysis and Suppression of Tumor Growth

A.-Rum Yoon,¹ Jaesung Kim,¹ Renu Wadhwa,² Sunil Kaul,² Chae-Ok Yun.¹

¹Severance Biomedical Science Institute (SBSI), College of Medicine, Yonsei University, Seoul, Republic of Korea; ²National Institute of Advanced Industrial Science & Technology (AIST), Tsukuba, Ibaraki, Japan.

Oncolytic adenoviral (Ad) vectors are widely used as a hopeful therapeutic medicine for human cancer therapy. However, full utility of traditional oncolytic Ad has been limited in several reasons. One of the key problems is low infectivity of oncolytic Ads due to low expression of coxackies and adenovirus receptor (CAR) in cells. Thus current studies are focused to improve its limiting potential by overcoming correlation with cellular CAR expression and Ad infection in cancer gene therapy. With the aim of improving the efficiency of infections to cancer cells, we have generated a novel tropism-expanded oncolytic Ad, RdB-VSV-G, that contains the epitope of envelope protein VSV-G at the fiber knob between HI loop with CAR entry facility and an additional entry potential. Using immunoblot analysis for detection of Ad fiber, VSV-G epitope-incorporated Ad is capable of forming a fiber trimer, just like RdB with the wild-type fiber. The newly tropism-expanded Ad, RdB-VSV-G, showed a remarkable improvement in the cytotoxicity to a variety of mammalian cells. The supreme enhancement in cytotoxicity was observed in cells that were difficult to infect because of low CAR expression when compared with control Ad that lacked the VSV-G epitope. Furthermore, the cellular entry of RdB-VSV-G is mediated by both CAR and PS (phosphatidyl serine). In line with those results, treatment with RdB-VSV-G significantly enhanced anti-tumor effect *in vivo*. Greater survival advantage was observed for RdB-VSV-G-treated tumor bearing mice. In summary, we have developed an oncolytic Ad with significantly improved therapeutic profile for cancer treatment.

528. Oncolytic Measles Virus Fully Retargeted to the Melanoma Surface Antigen HMWMAA

Johanna K. Kaufmann,¹ Sascha Bossov,² Christian Großardt,² Stefanie Sawall,² Jörg Kupsch,³ Guy Ungerechts,² Dirk M. Nettelbeck.¹

¹Helmholtz University Group Oncolytic Adenoviruses, German Cancer Research Center & Heidelberg University Hospital, Heidelberg, Germany; ²Department of Translational Oncology, National Center for Tumor Diseases, German Cancer Research Center, Heidelberg, Germany; ³RAFT Institute for Plastic Surgery, Mount Vernon Hospital, Northwood, United Kingdom.

Advanced melanoma is a substantial clinical challenge with rising incidence and poor survival rates. No curative therapy is currently available. Therefore, novel treatment methods are urgently needed. Oncolytic measles viruses (MV) based on the Edmonston vaccine strain have been shown to be a promising tool for the treatment of various cancer types. We generated a fully retargeted melanoma-specific oncolytic MV that enters cells specifically through the High Molecular Weight Melanoma-Associated Antigen (HMWMAA), a molecule widely expressed on the surface of malignant melanoma cells. To this end, an optimized single-chain antibody against HMWMAA (RAFT3) was fused to the C-terminus of a mutated attachment protein hemagglutinin (H) unable to recognize its natural receptors. Specificity and biological function were demonstrated via fusion assay on HMWMAA-expressing cells after transient plasmid-mediated co-expression of retargeted H glycoprotein (H α HMWMAA) and the fusion protein F. Incorporation of

H α HMWMAA into virus particles was as efficient as for other retargeted control viruses using the producer cell line Vero- α His. In line with the fusion assays, infection experiments revealed specific entry of MV-H α HMWMAA into antigen-expressing cell lines. Viral spread could be detected as broad syncytia formation and infection efficacy correlated with HMWMAA surface expression levels of all cell lines tested. Virtually no off-target infection was detected. Cytotoxicity assays showed significant cell killing of melanoma cells after infection with the retargeted virus. We further evaluated the efficacy and specificity of MV-H α HMWMAA by one-step growth curves. After infection of melanoma cells, the retargeted virus showed only a slight growth retardation as maximal titers were 2-fold lower than those of an unmodified control virus. In contrast, replication of MV-H α HMWMAA was strongly attenuated by three orders of magnitude on non-target cells. With this, selectivity was significantly higher than that of an established control MV. We are currently arming MV-H α HMWMAA with an additional payload to further enhance the oncolytic efficacy. This highly melanoma-specific virus may be a promising tool for virotherapy of advanced melanoma.

529. Modification of the Early Gene Enhancer-Promoter Improves the Oncolytic Potency of Adenovirus 11

Han Hsi Wong,¹ Guozhong Jiang,¹ Rathi Gangeswaran,¹ Ming Yuan,¹ Hexiao Wang,¹ Vipul Bhakta,¹ Heike Muller,¹ Nick Lemoine,¹ Yaohe Wang.¹

¹Molecular Oncology and Imaging, Barts Cancer Institute, Queen Mary University of London, London, United Kingdom.

Replicating oncolytic adenoviruses based on serotype 5 (Ad5) have several shortcomings, including the downregulation of its receptor in cancer cells, high prevalence of neutralizing antibodies and hepatotoxicity. Another adenoviral serotype, Ad11, could overcome these obstacles. Here, we show that human cancer cell lines express higher levels of the Ad11 receptor CD46, resulting in much better infectivity than Ad5. Surprisingly, only 36% (9/25) of the cell lines were more sensitive to Ad11- than to Ad5-mediated cytotoxicity. Investigations revealed that it was the transcription of Ad11 *E1A*, not CD46 expression or virus infectivity, which determined the cell's sensitivity to Ad11 killing. Ad11 *E1A* mRNA levels have an effect on viral DNA replication, structural protein synthesis and infectious particle production. To test the hypothesis that increased *E1A* transcription would lead to improved Ad11 replication in Ad5-sensitive (but Ad11-less sensitive) cells, two Ad11 mutants (Ad11-Ad5-P and Ad11-Ad5-EP) were constructed where either the *E1A* promoter or enhancer-promoter, respectively, was replaced by that of Ad5. Ad11-Ad5-EP demonstrated increased *E1A* mRNA levels and replication, together with enhanced oncolytic potency *in vitro* and *in vivo*. This effect was found in both the Ad5-sensitive and Ad11-sensitive cancer cells, broadening the range of tumors that could be effectively killed by Ad11-Ad5-EP. These results imply that the novel Ad11 mutant developed in this study with the Ad5 *E1A* (instead of wild-type Ad11 *E1A*) enhancer-promoter is a promising backbone for the future development of more potent and tumor-selective oncolytic viruses.

530. Retargeting Oncolytic Adenoviruses to Tumors Expressing c-Met

Hany I. Sakr,¹ Shilpa Bhatia,¹ J. Michael Mathis.¹

¹Cellular Biology and Anatomy, LSU Health Sciences Center, Shreveport, LA.

The hepatocyte growth factor (HGF) receptor, or c-Met, is a unique heterodimer with tyrosine kinase activity. The physiologic actions mediated by c-Met are widespread, include altering cell proliferation, adhesion, and cell motility during tissue development, and repair.

The c-Met receptor can interact with multiple intracellular signaling pathways, and is up regulated in a majority of malignancies. This makes c-Met a relevant target for novel therapeutic interventions. Virotherapy employing oncolytic adenoviruses represents a promising biological intervention applicable to a wide array of neoplastic diseases. Using oncolytic adenoviruses, designed to divide in and specifically kill tumor cells, is a promising virotherapy approach for cancer treatment. Ideally, cancer-specific replication of oncolytic adenoviruses results in viral-mediated replication and lysis of infected tumor tissues. Release of virus progeny results in further propagation in surrounding tumor cells but not in those of normal tissues that would be refractory to virus replication. To date, achieving replicative specificity of oncolytic adenovirus agents has been accomplished primarily by incorporating tumor selective promoters. To achieve a novel alternative specificity of oncolytic adenoviruses, we used a high affinity c-Met ligand to retarget viral infectivity to metastatic disease over expressing the receptor. Specifically, we incorporated NK2, a competitive antagonist of the HGF - c-Met association, into the adenovirus fiber. In this approach, the NK2 ligand was genetically incorporated by ablating the adenovirus fiber (protein pIV) gene, and replacing it with a recombinant gene consisting of the tail domain from the fiber and a trimerization domain from T4 fibrin fused to NK2 (fiber-fibrin-NK2). This study demonstrates the ability to rescue viable adenoviral particles that display functional fiber-fibrin-NK2 as a component of their capsid surface. Importantly, this construct in the context of an oncolytic adenovirus, specifically infected cancer cell lines that over express c-Met, and induced cell lysis. These results suggest that a c-Met retargeted virus could be used to counteract tumor mitogenesis, motogenesis, and morphogenesis driven by this receptor. If successful, this approach could open new avenues for using adenoviral vectors in cancer gene therapy and hasten the shift from preclinical to clinical trials.

Cancer-Targeted Gene & Cell Therapy II

531. Stanniocalcin-1 Derived from Multi Potent Stromal Cell Changes Cell Metabolism Dramatically, Decreases Reactive Oxygen Species Stress and Promotes Survival of Cancer Cells with Uncoupling Protein 2 Upregulation

Shinya Ohkouchi,¹ Gregory J. Block,² Darwin J. Prockop,³ Toshihiro Nukiwa.¹

¹Department of Respiratory Medicine, Graduate School of Medicine, Tohoku University, Sendai, Miyagi, Japan; ²Institute of Stem Cell and Regenerative Medicine, University of Washington, Seattle, WA; ³Institute for Regenerative Medicine at Scott and White Hospital, Texas A&M Health Science Center, Temple, TX.

Previous studies have demonstrated that multipotent stromal cells (MSCs) enhance cell survival through upregulation and secretion of stanniocalcin-1 (STC1) in lactic acidosis and hypoxia. These situation induce lots of intracellular ROS, therefore we hypothesized MSCs derived STC1 decreases ROS induced cell death. This study shows that MSC derived STC1 promotes survival of lung cancer A549 cells by uncoupling oxidative phosphorylation, reducing intracellular reactive oxygen species (ROS), and shifting metabolism towards a more uncoupling metabolic profile. MSC derived STC1 upregulated uncoupling protein 2 (UCP2) in injured A549 cells in an STC1 dependent manner. Knockdown of UCP2 reduced the ability of MSCs and recombinant STC1 (rSTC1) to reduce cell death in the A549 population. rSTC1 treated A549 cells displayed decreased levels of reactive oxygen species, mitochondrial membrane potential, increased lactate production and increased oxygen consumption, all of which were dependent on the upregulation of UCP2. Our data suggest that

MSCs promote cell survival by regulating mitochondrial respiration via STC1. Furthermore, STC1 may provide promising avenues for treatment of reactive oxygen species and metabolic disorders.

532. Neuropilin-1 Expressing Mononuclear Cells (NEMs), a Novel Population of Bone Marrow Cells Recruited by AAV2-Sema3A, Contributes to Vessel Normalization and Inhibits Tumor Growth

Serena Zacchigna,¹ Alessandro Carrer,¹ Silvia Moimas,¹ Lorena Zentilin,¹ Mauro Giacca.¹

¹Molecular Medicine Laboratory, International Centre for Genetic Engineering and Biotechnology - ICGEB, Trieste, Italy.

Over the last several years, we have extensively exploited the properties of viral vectors based on the Adeno-Associated Virus (AAV) for the in vivo delivery of a variety of genes involved in blood vessel formation in various small and large animal models. AAV vectors have the capacity to transduce non-replicating cells with high efficiency, in the absence of inflammation and immune response, and thus promote expression of their transgenes in vivo for indefinite periods of time. In particular, we observed that the prolonged expression of VEGF-A165 and Sema3A, two Neuropilin-1 (Nrp-1) ligands, determined a massive infiltration of the expressing tissues by a population of bone-marrow derived mononuclear cells expressing Nrp-1. These Nrp-1 Expressing Mononuclear cells (NEMs) were found to be involved in vessel maturation through a paracrine effect ensuing in the activation and proliferation of tissue-resident mural cells (Zacchigna et al. J. Clin. Invest. 2008, 118, 2062). Consistent with the observation that NEMs quench angiogenic burden and promote vessel maturation, we observed that both AAV-Sema3A and NEMs exerted strong anti-tumoral effect. In particular, we exploited AAV2-mediated gene transfer to overexpress Sema3A at the site of inoculation of either B16.F10 melanoma or T24.1 fibrosarcoma cells in immunocompetent mice. We found that Sema3A markedly reduced tumor growth, without directly affecting tumor cell proliferation. Similarly, the direct injection of NEMs, isolated from either the bone marrow or AAV-Sema3A-injected muscles, and administered to B16-F10 tumor-bearing animals, markedly impaired tumor growth. Analysis of the vasculature of AAV2-Sema3A- or NEM-treated tumors revealed a more mature vascular network, associated to a higher degree of a-SMA+/NG2+ mural cell coverage, reduced vessel tortuosity and decreased vascular leakiness, indicating a role for NEMs in triggering vessel normalization. Tumors treated with Sema3A or NEMs were smaller, better perfused, less hypoxic and with a reduced level of activation of HIF-1a. Phenotypic characterization of purified NEMs revealed that they constitute a unique population of cells, having a CD11b+/Nrp1+/Gr1-/Tie2- phenotype. These cells constitute ~1.0% of total bone marrow cells and are characterized by a gene expression profile reminiscent of M1 polarized monocyte/macrophages.

533. Examining the Role of CD44 in the Tumor Tropism of Multipotent Mesenchymal Stem Cell (MSC) for Cancer Microenvironments

Erika L. Spaeth,¹ Brian Toole,² Ann Klopp,¹ Michael Andreeff,¹ Frank C. Marini.¹

¹Leukemia, MD Anderson Cancer Center, Houston, TX; ²Cell Biology and Anatomy, Medical University of South Carolina, Charleston, SC.

Multipotent mesenchymal stem/stromal cells (MSC) make excellent gene delivery vehicles because they are readily propagated in vitro, can be genetically modified, have high metabolic activity to support the production of therapeutic agents and have tumor tropic properties. We have shown the propensity of MSC to migrate to and incorporate into the tumor stroma. Once engrafted in the tumor, MSC are capable

of providing extracellular matrices, cytokines, growth factors and vascular networks for nutrient and waste exchange. We modulate the receptor surface expression of CD44 on MSC to alter the migration of towards tumor conditioned media *in vitro* and engrafted tumors *in vivo*. Blocking MSC-expressed CD44 with neutralizing antibody, soluble CD44 decoy receptor, or shRNA knockdown inhibited the migration of MSC toward tumor conditioned media *in vitro* by greater than 75%, 82% and 50%, respectively. *In vivo*, 60% inhibition of systemically injected MSC towards bilateral orthotopic engrafted xenograft tumors was achieved using a soluble CD44 decoy receptor. Additionally, using a CD44 luciferase promoter construct, we found that CD44 mRNA expression in MSC varies in response to stimulation by various tumor cell lines. Also, real time PCR analysis showed that tumor stimulated MSC alter their CD44 splice variant expression suggesting alternative variants may enhance migration. These results suggest that CD44 is significant to the tumor-tropic migration capacity of MSC. Furthermore, enhancing the surface expression of CD44 may heighten tumor-tropic migration thereby increasing the efficacy of the MSC as a potential drug delivery vehicle.

534. Survivin Downregulation in Human Breast Cancer Cell Line by siRNA Delivery Using Hydrophobically Modified Aliphatic Polymers

Hamidreza Montazeri Aliabadi,¹ Breanne Landry,¹ Parvin Mahdipoor,¹ Hasan Uludag.¹

¹Department of Chemical & Material Engineering, University of Alberta, Edmonton, AB, Canada.

Post-transcriptional silencing of 'aberrant' genes is a promising strategy for cancer therapy, and RNA interference (RNAi) has been recognized as a mechanism involved in this silencing. Delivering siRNA to intracellular targets, however, has been proven to be quite a challenge due to inability of anionic siRNA to cross cellular membranes. High molecular weight polyethylenimines (PEIs) are effective siRNA delivery agents; however, their toxicity has been an important obstacle for their clinical use. As an alternative, hydrophobic substitution on small molecular weight PEI with lipophilic moieties has been investigated as a promising approach for effective but non-toxic siRNA carriers. In this study, we report the hydrophobic modification of low molecular weight PEI with different lipophilic substituents for siRNA delivery to target survivin protein. Survivin is a member of IAP family and has been implicated in multiple essential functions, including cell division and apoptosis. Survivin is an attractive target for anti-cancer therapy, due to (a) low expression in most normal cells and upregulation in malignant tissue, (b) involvement in multiple signalling mechanisms controlling tumor maintenance, and (c) silencing survivin may block angiogenesis and tumor cell growth. We evaluated toxicity of a library of lipid-substituted PEIs, siRNA uptake, and survivin silencing in MDA-MB-231 breast cancer cells using flow cytometry, FlowTACS™ Apoptosis Detection Kit, nuclear staining, and MTT assay. Lipid substitution increased the toxicity of PEI2 for some of the higher substituents; however, this toxic effect was significantly less than the cytotoxicity displayed by the PEI25 (>50% cell viability for all lipid-substituted polymers at 10 g/mL). A significant increase in siRNA cellular uptake was observed when the siRNAs were delivered with lipid-substituted polymers, and significant down-regulation in the target protein expression was established by Caprylic Acid-substituted polymers. The survivin down-regulation was also confirmed by an increase in apoptosis rate and MTT assay to demonstrate a drop in cell viability after polymer/siRNA treatment. Polymer/survivin siRNA treatment prior to anticancer therapy decreased the IC50 of the evaluated drugs upto 49.31-fold.

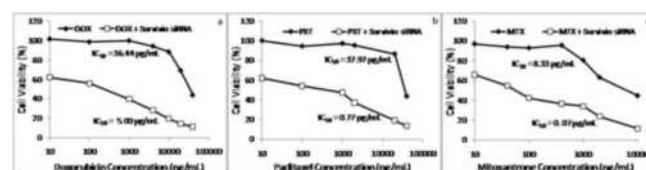

Our experiments indicate an effective down-regulation of survivin, a cell protective protein up-regulated in tumor cells. This was accomplished by the modification of a non-toxic but ineffective PEI with different hydrophobic moieties. The resultant polymers showed a significant capability for cellular delivery of siRNA, which in turn was translated into apoptosis induction by CA-substituted PEIs. This study introduces a promising delivery system for safe and effective siRNA delivery, which will be further investigated in preclinical animal models.

535. Bacterial Cell Therapy for Cancer

Michelle Cronin,¹ Sara A. Collins,^{1,2} Chwanrow Baban,¹ Akihito Inagaki,² Kei Hiraoka,² Noriyuki Kasahara,² Kevin Francis,³ Ali Akin,³ Cormac G. M. Gahan,⁴ Gerald C. O'Sullivan,¹ Mark Tangney.^{1,2}

¹Cork Cancer Research Centre, University College Cork, Cork, Ireland; ²David Geffen School of Medicine, University of California Los Angeles, Los Angeles, CA; ³Caliper Life Sciences, Alameda, CA; ⁴Alimentary Pharmabiotic Centre, Microbiology Dept., School of Pharmacy, University College Cork, Cork, Ireland.

The prime obstacle to achieving an effective treatment for cancer is that of eradicating tumours without harming healthy cells. Use of biological agents for delivery of therapeutic genes to patients has shown great promise. Bacteria present an attractive class of gene vector, possessing a natural ability to grow specifically within tumours following systemic administration. Pathogenic genera (Clostridium and Salmonella) have been examined in clinical trials. However, as disease-causing bugs, their inherent toxicity has outweighed therapeutic responses. Furthermore, the biology of bacterial tumour targeting is poorly understood. We aim to address these failings through technological development of non-pathogenic bacterial strategies. Lactic Acid Bacteria (LAB) have been utilised in food fermentations for centuries, and are ingested regularly by humans. Certain strains are known to colonise the gut (commensal bacteria), living symbiotically with humans. We have engineered a number of LAB and other commensal bacteria (Bifidobacterium, Lactococcus and E.coli) to express heterologous genes within tumours (external to tumour cells) following systemic administration. Luminescent reporter gene (bacterial lux) tagging of the various bacteria permitted real-time visualization of vector, in subcutaneous and orthotopic murine models (melanoma, breast, lung, glioma). Long-term persistence of these replication-competent vectors was observed in tumours (2-6 weeks) in both athymic and immunocompetent mice. Lower bacterial numbers were observed in immunocompetent animals and low level, delayed anti-vector immune responses (Th1 and Th2) were observed in tumours. Use of 3D luminescence imaging (IVIS) of lux-expressing bacteria enabled characterisation of intratumoural distribution patterns, and co-registration of bacterial lux and tumour derived firefly luciferase revealed an inverse relationship between tumour viability and bacterial load, even in the case of facultatively anaerobic strains. We have engineered strains to secrete heterologous proteins to high levels and these replication competent bacteria can mediate long-term production of soluble agents within tumour masses, presenting a powerful and safe approach to specific gene/cell therapy of primary tumours and secondary metastases.

536. p16-Mediated Inhibition of Hypoxia-Induced Cancer Cell Migration

Yi Lu,¹ Liyuan Li.¹

¹*Pathology and Laboratory Medicine, University of Tennessee Health Science Center, Memphis, TN.*

One general characteristic of fast-growing solid tumors including breast cancer is the development of intratumoral hypoxia. The activation of hypoxia-inducible factor-1 α (HIF-1 α) by intratumoral hypoxia stimulates a group of downstream genes including vascular endothelial growth factor (VEGF) that are responsible for tumor malignant progression. Loss of p16 expression occurs in many cancers including breast cancer. Our studies showed that, by ectopic expression via adenoviral-mediated gene transfer, p16 downregulates VEGF gene expression by neutralizing the transactivation of HIF-1 α , and suppresses breast cancer angiogenesis and metastasis. To investigate whether p16 directly affects one or more aspects of the metastatic cascade, MDA-MB-231 cells infected with lentivirus expressing Tet-on inducible p16 were used to study the p16 effects on growth, adhesion and migration of the breast cancer cells. We found that p16 inhibits MDA-MB-231 cell proliferation (45.6% inhibition) and hypoxia-induced cell migration (36% inhibition), but has no apparent effect on cell adhesion. The p16-mediated inhibition of hypoxia-induced cell migration parallels with p16's inhibition of HIF-1 α transactivation activity. These results indicate that p16's ability to suppress breast tumor metastasis may result from a combined p16-mediated actions including inhibition of cell proliferation, migration, and angiogenesis. This study suggests that p16 gene therapy may have clinical potentials to treat breast cancer due to p16's multiple-level anti-cancer capabilities: inhibiting proliferation, inducing apoptosis, blocking tumor angiogenesis, inhibiting cell migration and suppressing metastasis.

537. Lentivirus-Mediated DR5 Agonistic Chimeric Antibody Expression for Cancer Gene Therapy

Dexian Zheng,¹ Juan Shi,¹ Yanxin Liu,¹ Shilian Liu.¹

¹*Biochem Mol Biol, Institute of Basic Medical Sciences, Chinese Academy of Medical Sciences, Beijing, China.*

TNF-related apoptosis-inducing ligand (TRAIL), a member of the TNF superfamily, induces cancer cell death via death receptors on the target tumor cells without side effect on most normal cells. Up to date, five TRAIL receptors have been found in human, i.e., TRAIL-R1 (DR4) and TRAIL-R2 (DR5), which contain a conserved death domain motif so that named as death receptor (DR), TRAIL-R3 (DcR1), TRAIL-R4 (DcR2), and osteoprotegerin (OPG), which are without an intact death domain (named as decoy receptor, DcR), so that can not transfer any cell death signals. The agonists of death receptors (DR4/DR5) including soluble TRAIL and agonistic antibodies against DR4 or DR5 have been emerging as the anti-cancer therapeutics in clinical trails in recent years. We previously reported an adeno-associated virus-mediated TRAIL expression for cancer gene therapy, which demonstrated that rAAV2/5-sTRAIL may provide an effective form of therapy for lung and liver cancer. The rAAV2/5-sTRAIL transduction of the tumors resulted in a statistically significant reduction in lung cancer growth and prolonged survival of the tumor-bearing animals. Intraportal vein injection of rAAV-TRAIL into the liver of an orthotopic transplanted mouse model mimicking liver cancer metastasis also resulted in a significant suppression of tumor growth and prolonged survival, while toxicity to normal hepatocyte was not detected. These results strongly suggest that rAAV-TRAIL-mediated gene delivery could be a promising approach for the treatment of lung and liver cancers. Since high cost of engineering antibody limits the application of antibody therapy, an alternative approach is to produce antibody in vivo, which can provide high

concentration and full pure antibody for a long period of time. To this end, we have developed AAV-scFv of a mAb, AD5-10, to DR5 for lung and liver cancer therapy and now we report a lentivirus vector-mediated expression of the mouse-human chimeric antibody (Zaptuzumab), by linking the heavy chain and the light chain with 2A/Furin self-processing peptide in an unique open reading frame, with a strong tumoricidal activity to human colon cancer in nude mice. Lentiviral expression of Zaptuzumab showed specific binding activity to its antigen DR5 and possessed a significant apoptosis-inducing activity in various tumor cell lines. The lentivirus-mediated chimeric antibody expression showed a strong apoptosis-inducing activity in vitro and inoculated s.c. human colon HCT116 tumor in nude mice was suppressed significantly in vivo. Moreover, the tumoricidal efficacy of the viral expressed mouse-human chimeric antibody was synergized by mitomycin C and prolonged the life span of human lung A549 tumor-bearing nude mice. These data suggest that the lentivirus-mediated and 2A peptide-based anti-DR5 chimeric antibody expression may have clinical utility against cancer and may represent rational adjuvant therapies in combination with chemotherapy.

538. Study of Radioisotope Uptake and Efflux in NIS Expressing Cells Goes High-Throughput

Patrycja J. Lech,¹ David Dingli,¹ Stephen J. Russell.¹

¹*Department of Molecular Medicine, Mayo Clinic, Rochester, MN.*

NIS is a Na⁺/I⁻ symporter that mediates active I⁻ transport into thyroid follicular cells and salivary, gastric, intestinal and mammary tissue. NIS mediated I⁻ uptake in thyroid follicular cells has been successfully exploited for the diagnosis and treatment of thyroid cancer and its metastases using radioiodide for over 50 yrs. The profound clinical impact of NIS as an imaging and therapeutic gene has inspired its utility for the delivery of radiation doses selectively to cancer cells both in vitro and in vivo, where the NIS gene is either endogenously expressed (e.g. breast cancer) or transduced. This strategy is highly translational as it can use both diagnostic (^{99m}Tc, ¹²⁵I, ¹²⁴I) and therapeutic (¹³¹I, ¹⁸⁶Re, ¹⁸⁸Re, ²¹¹At) radioisotopes and can enhance current and developing treatment modalities such as radiotherapy, chemoradiotherapy and oncolytic virotherapy. Here we describe a high-throughput platform for NIS mediated radioisotope uptake by NIS expressing cells in a 96 well format. This platform is highly robust and reproducible and can be exploited to study and/or manipulate the kinetics and electrophysiological properties of NIS. Our current studies are focusing on the mechanism behind ¹²⁵I efflux following ¹²⁵I uptake, as a means of increasing radioiodide concentrations retained in NIS expressing cells in order to increase the therapeutic and diagnostic index of this tool. The cell line used in this platform is Mel624 stably transduced with VSV-G pseudotyped lentiviral vector encoding NIS and neomycin (Mel624-NIS). This cell line was chosen for its robustness and ability to remain adhered to the wells following three washes required to remove residual ¹²⁵I following uptake. The accumulation of ¹²⁵I in Mel624-NIS cells is 30-50 times higher than control Mel624-NIS cells treated with perchlorate (ClO₄⁻), a known competitive inhibitor of I⁻ accumulation via NIS. Currently, an individual can assay six 96 well plates per day (360-576 wells) taking into account the time it may take to prepare the buffers, dilutions, perform the ¹²⁵I uptake and quantify the ¹²⁵I in cells or media using a gamma counter.

539. Clinical Study of Gendicine Therapy with Radio-Frequency-Hyperthermia; a Case Report

Hiromasa Kurosaki,¹ Maiko Tobari,² Mariko Kurosaki,¹ Shinji Mori.¹

¹*Cancro Clinic, Tokyo, Japan;* ²*Shanghai Hospital of Civil Aviation, Shanghai, China.*

(Introduction) Gendicine is a cancer therapeutic drug composed of recombinant adenovirus-*p53* tumor-suppressor gene, and has already been shown to have a hyperthermia-sensitizing effect. (Case report) The patient was a 60-year-old woman who had received 6 courses of chemotherapy with paclitaxel and carboplatin following surgery for double cancer of the ovary and endometrium. Her CA19-9 level had been reduced from 2000 to 20 U/mL; however, it was gradually increased to 62 U/mL at 16 months after the surgery. PET-CT showed a swollen abdominal lymph node (13 mm × 10 mm), with a standardized uptake value (SUV) of 2.9.



The patient refused to receive second-line chemotherapy, and thus, after providing her informed consent, she was treated with Gendicine (6 vials for 6 weeks), followed by hyperthermia using radiofrequency 3 days after the start of Gendicine therapy. PET-CT, performed at 8 weeks after the end of Gendicine and thermal therapy, showed the lymph node to be reduced to 10 mm × 7 mm, with a SUV of 2.1.



Her CA19-9 level was also reduced from 62 to 33 U/mL. There were no adverse effects other than fever during the treatment period. As of one year after the end of Gendicine therapy, PET-CT showed no evidence of recurrence, and her CA19-9 level was stable (24 U/ml). As of two year after the end of Gendicine therapy, her CA19-9 level was high (50 U/ml) but PET-CT showed no evidence of recurrence. (Conclusion) Gendicine therapy combined with hyperthermia has the potential to treat advanced or refractory cancer.

540. Effects of siRNAs Targeting Endoglin in Human Microvascular Endothelial Cells In Vitro

Tanja Dolinsek,¹ Bostjan Markelc,¹ Gregor Sersa,¹ Simona Kranjc,¹ Maja Cemazar.¹

¹*Department of Experimental Oncology, Institute of Oncology Ljubljana, Ljubljana, Slovenia.*

Endoglin is an accessory protein of the TGF- β receptor complex. It participates in activation of a signaling pathway, which results in cell proliferation and migration. The expression of endoglin is highly elevated in endothelial cells of blood vessels within and surrounding tumors. The aim of our study was to evaluate the effect of different siRNA molecules targeting endoglin on the expression level and on the survival and proliferation of human microvascular endothelial cell line HMEC-1 in vitro. First, we determined that HMEC-1 cells have high expression level of endoglin using qRT-PCR. Using lipofection, different siRNAs against endoglin were transfected into HMEC-1 cells. To determine the silencing effect of selected siRNAs, levels of mRNA were measured with qRT-PCR and cell survival and proliferation were measured with Alamar blue assay. Effect of siRNAs on endothelial cell tube formation was also determined. After transfection of cells with three designed siRNAs, mRNA of endoglin after transfection of selected siRNA was reduced up to 96%. This silencing effect was reflected in reduced cell proliferation that was measured for 6 days as well as cell survival. In addition, silencing of endoglin reduced ability of HMEC-1 cells to form the tubes in vitro. The obtained results demonstrate that choosing the right siRNA is a crucial step for effective silencing of endoglin that result in changed behavior of HMEC-1 cells.

541. 293T Cells Transfected with a Degron-Conjugated Fusion Reporter Demonstrate Unexpected Increase in Reporter Activity

Rehan S. Ali,¹ Maximilian Diehn,² Edward E. Graves,¹ Ramasamy Paulmurugan.³

¹Department of Radiation Oncology, Stanford University, Stanford, CA; ²Institute for Stem Cell Biology and Regenerative Medicine, Stanford University, Stanford, CA; ³Canary Center for Early Cancer Detection, Stanford University, Stanford, CA.

BACKGROUND: Cancer stem cells (CSCs) are a highly resistant and tumorigenic subpopulation of tumor cells which are associated with tumor relapse. Direct visualization of CSCs would facilitate development of anti-CSC therapy, but their low numbers and lack of unique markers make them difficult to identify. A recent paper by Vlashi et al (JNCI 2009, 101(5), 350) outlined a possible approach using ZsGreen fused to a degron, a known proteasome target peptide. CSCs are hypothesized to have downregulated proteasome activity, and their reporter showed activity primarily in a small population of tumorigenic cells. However when we tried this approach, we observed an unusual increase in fusion protein stability when the degron was attached. **METHODS:** 293T monolayer cultured cells were stably transfected with Thymidine Kinase (TK)-enhanced Green Fluorescent Protein (eGFP) and TK-eGFP-degion plasmids, imaged using fluorescence microscopy (0.2s exposure), and analyzed via FACS. TK activity was assessed via a 3H-penciclovir in vitro cell uptake assay. Western Blot was performed using anti-TK antibodies. Proteasome activity was assayed using Z-LLE-AMC caspase-specific fluorescent substrate. Assays were performed in triplicate. **RESULTS:** Cells showed higher intracellular fluorescence intensity following transfection with TK-eGFP-degion, compared to TK-eGFP.

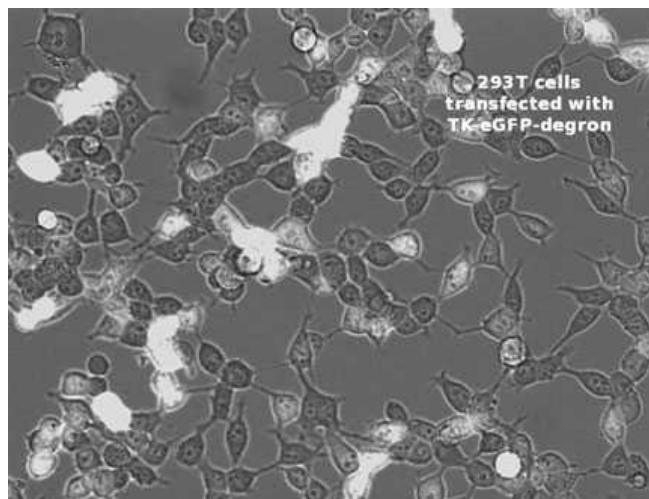
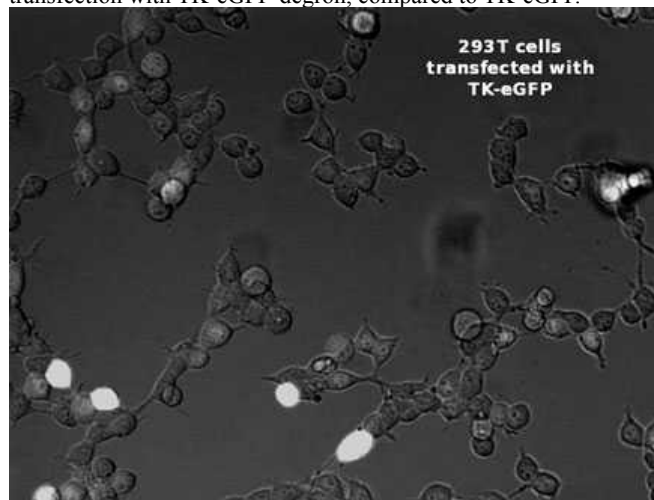

At x60 magnification, TK-eGFP signal was localized to the nucleus, whereas significant TK-eGFP-degion signal was also observed in the cytoplasm. FACS showed an increase in GFP-positive cell populations of 1.1% (n=10,000) with degion. TK activity showed no significant difference in 3H-PCV cell uptake between TK-eGFP (2.09% +/- 0.01%) and TK-eGFP-degion (2.21% +/- 0.13%). Western Blot band intensities showed 1.6 times more TK-eGFP-degion protein than TK-eGFP (2.1e5 +/- 0.20%, vs 1.3e5 +/- 0.18%). 293T proteasome activity was comparable to other cell lines (A549, MCF7, U87). **CONCLUSIONS:** The addition of a C-terminal degion to a TK-eGFP chimera does not impair the function of either TK or GFP in 293T monolayers. These results suggest that degion-mediated CSC-specific targeting strategies may not provide consistent results, and that the nature of the fusion protein may influence the outcome. We are currently repeating these studies, along with proteasome-inhibitor assays, with A549, MCF7 and U87 cell lines.

Gene Regulation II

542. MicroRNA-Based Transgene Regulation in the Retina

Anna Manfredi,¹ Marianthi Karali,¹ Agostina Puppo,¹ Elena Marrocco,¹ Annagiusti Gargiulo,¹ Enrico M. Surace,¹ Sandro Banfi,¹ Alberto Auricchio.^{1,2}

¹TIGEM, Naples, Italy; ²Department of Pediatrics, University of Naples Federico II, Naples, Italy.

MicroRNAs (miRNAs) are a class of small non-coding RNAs involved in the post-transcriptional regulation of gene expression. MiRNAs work by binding to complementary target sites in the 3' untranslated region (UTR) of mRNAs, thereby preventing their translation or accelerating their decay. Most miRNAs are expressed in a highly tissue-specific or developmental stage-specific manner. Endogenous miRNAs can be therefore exploited to regulate transgene expression following insertion of one or more copies of miRNA target sites (miRTs) in the 3'UTR of transgenes. The retina is a multilayer of highly specialized neurons and an ideal target for gene therapy. MiR-124a is strongly expressed in all layers of the neural retina but not in the retinal pigment epithelium (RPE), while miR-204 is expressed in the RPE and some retinal layers (i.e. Inner Nuclear Layer and Ganglion Cell Layer) but is absent from the photoreceptors (PRs). We have generated AAV2/5 vectors expressing EGFP and containing four copies of miR-124a or miR-204 complementary sequences (miRTs) immediately upstream of the WPRE element. These AAV2/5 vectors were administered sub-retinally to either adult C57bl/6 mice or Large White pigs. In both species, the use of miR-124a complementary sequences (miR124aT) resulted in restriction of

AAV2/5-mediated EGFP expression to the RPE, while the inclusion of miR204Ts restricted transgene expression to PRs, as expected. In addition, the use of miR204Ts efficiently restricted the AAV2/8-mediated expression of AIPL1- a gene mutated in Leber congenital amaurosis, a common form of childhood inherited blindness- to porcine PRs. In conclusion, we show that miRNA-based regulation of transgene expression can be applied in the retina to restrict the robust expression levels obtained using ubiquitous promoters to a specific cell type. Alternatively, it can be coupled with cell-specific promoters thus providing an additional layer of fine-tuning transgene expression.

543. Creation of Structural Variations in the Human Genome Using Engineered Zinc Finger Nucleases

Eunji Kim,¹ Hyung Joo Lee,¹ Jin-Soo Kim.¹

¹Department of Chemistry, Seoul National University, Seoul, Korea.

Many genetic diseases and cancer are associated with chromosomal rearrangements such as deletions, insertions, duplications, translocations, and inversions. Even among healthy individuals, thousands of different structural variations (SVs) or copy number variations resulting from different chromosomal rearrangements are observed. Despite the recent discoveries of and interest in numerous structural variations (SVs) in the human and other higher eukaryotic genomes, little is known about the etiology and biology of these SVs, partly due to the lack of molecular tools with which to create individual SVs in cultured cells and model organisms. Here, we present a novel method of inducing targeted genome rearrangements using engineered zinc finger nucleases (ZFNs). We found that ZFNs designed to target two different sites in a human chromosome could introduce two concurrent double-strand breaks, whose repair via non-homologous end-joining (NHEJ) gives rise to targeted deletions, duplications, and inversions of the genomic segments of up to a mega base pair in length between the two sites. We also found that ZFNs can induce incorporation of synthetic ODN cassettes into the targeted site and replace the cassettes with the large chromosomal DNA segments. High frequencies of ZFN-induced genomic rearrangements, ranging from 0.01% to 12%, allowed us to routinely isolate clonal populations of cells whose genomes contain SVs of interest. We propose that ZFNs can be employed as molecular tools to study mechanisms of chromosomal rearrangements and to create SVs in a predetermined manner so as to study their biological roles. In addition, our method opens up new possibilities for correcting genetic defects caused by chromosomal rearrangements and, thus, holds promise in gene and cell therapy.

544. VEGF-A Zinc Finger Activator Is Neuroprotective in Rodent Preclinical Models of Stroke

S. Kaye Spratt,¹ Philippe M. D'Onofrio,² Mark M. Magharious,^{2,3} Mahinthan Thayapararajah,² Richard Surosky,¹ Gary Lee,¹ Martin Giedlin,¹ Dale Ando,¹ Michael Fehlings,³ Paulo D. Koeberle.^{2,3}

¹Development, Sangamo BioSciences Inc, Richmond, CA; ²Dept. Surgery, University of Toronto, Toronto, ON, Canada; ³Department of Genetics and Development, Toronto Western Research Institute, and Spinal Program, Krembil Neuroscience Centre, University Health Network, Toronto, ON, Canada.

Vascular endothelial growth factor (VEGF) is most widely recognized for its role in angiogenesis; however recent studies have identified anti-apoptotic and neuroprotective functions for VEGF in the CNS. VEGF therapy for CNS injury has been hampered by the tendency of VEGF to promote vascular permeability, edema, and immune infiltration into tissues. Recently, engineered zinc finger

proteins that upregulate multiple isoforms of VEGF-A (VEGF-ZFP) in their natural biological ratios have been developed and this approach is promising because VEGF upregulation by ZFPs does not promote vascular permeability (Rebar et al, 2002). Highly reproducible models of optic nerve transection (axotomy), ophthalmic artery ligation and a pial strip traumatic injury model were used to determine if the VEGF-ZFP is neuroprotective in the adult CNS. AAV2 vectors encoding VEGF ZFPs (AAV.ZFP) or control vectors encoding GFP (AAV.GFP) were delivered by intraocular injections 3 days prior to retinal injury. Retinal ganglion cells (RGCs) were retrogradely labeled with Fluorogold in order to quantify survival from fixed flatmounted retinas. AAV.ZFP treatment increased RGC survival by 2-fold (n=6/group, p<0.01) after optic nerve transection. Similarly AAV.ZFP treatment significantly enhanced RGC survival at 14 or 21 days after ophthalmic artery ligation (n=6/group, p<0.01). Function of the retino-tectal pathway was assessed by pupillometry at 7, 14, or 21 days after retinal ischemia, and AAV.ZFP treated retinas demonstrated significantly greater pupillary responses than controls at all time points tested. RECA-1 immunostaining demonstrated no appreciable differences between retinas treated with AAV.ZFP or controls, suggesting that AAV.ZFP treatment did not affect retinal vasculature. Following pial strip injury of the forelimb cortex, brains treated with an adenovirus encoding the VEGF ZFP (Ad.ZFP) showed higher neuronal survival (n=5, p<0.05) adjacent to the devascularized infarct and accelerated wound contraction between 1 and 4 weeks after injury compared to control animals receiving Ad.GFP. Behavioral testing using the cylinder test for vertical exploration demonstrated that Ad.ZFP treated animals had significant improvements in contralateral forelimb function within the first two weeks after injury (n=8, p<0.05) than controls at week 1 (post-stroke) through to week 6 (post-stroke). The recovery was most pronounced early after injury. Our results demonstrate that delivery of the VEGF-ZFP activator following retinal and ischemic injury in preclinical models of stroke is neuroprotective. Improvements in retinal ganglion cell survival, significantly greater pupillary responses and short-term improvements in forelimb function were observed. These results suggest the therapeutic potential of ZFPs for the treatment of cerebrovascular insults in CNS trauma and stroke.

545. Regulation of AAV-Mediated Transgene Expression in Airway Epithelium *In Vivo*

Maria P. Limberis,¹ Melissa Fontana,² ShuJen Chen,¹ James M. Wilson.¹

¹Gene Therapy Program, Department of Pathology & Laboratory Medicine, University of Pennsylvania, Philadelphia; ²University of the Sciences in Philadelphia, Philadelphia College of Pharmacy, Philadelphia.

Gene transfer vectors based on the adeno-associated virus (AAV) have been shown to effectively transduce cells of the nasal and lung airway epithelium in mice and macaques. When engineering viral-based vectors as therapeutics for genetic lung diseases, persistent gene expression is necessary to maintain the therapeutic effect. To this vein, transgene expression for genetic lung diseases that include cystic fibrosis and α -1-antitrypsin deficiency is typically driven by constitutive AAV vectors. For disease states in which transient transgene expression is required, the regulation of vector-mediated gene expression is warranted. To regulate gene expression in airway cells *in vivo* we used an AAV-based inducible vector system that is activated by rapamycin. We previously showed that AAV2/9 efficiently transduces the respiratory epithelium that lines the mouse nasal airways. To test the performance of the inducible AAV vector system in airway, we intranasally co-injected 10¹¹ genome copies of the inducible AAV2/9 vector expressing firefly luciferase (ffLuc) and transcription factor in both nares of 6-8 wk-old C57Bl/6 male mice (n=5/group). Control mice included those injected with a) the

inducible AAV2/9 vector expressing fLuc; b) the AAV2/9 vector expressing transcription factor; and c) the constitutive AAV2/9 vector expressing fLuc (used to assess the maximally achievable fLuc expression). Twenty-one days after vector injection, the degree of gene expression 'leakage' of the inducible AAV vector system as well as the level of fLuc in mice injected with the constitutive AAV2/9 vector were assessed. Briefly, luciferin was delivered intranasally and using the Xenogen IVIS imaging system all control and vector-treated mice were imaged. Only mice injected with the constitutive AAV2/9 vector expressed fLuc ($\sim 1.6 \times 10^6$ photons/seconds; p/s) at levels significantly above baseline (10^3 p/s). No "leakage" of fLuc from the inducible AAV vector system was observed. All mice were then injected intraperitoneally with 1mg/kg rapamycin and fLuc expression was monitored daily (for up to 7 days). Twenty-four hours later we observed a ~ 1000 -fold increase in fLuc expression in the nasal airways of mice injected with the inducible AAV vector system. Indeed the level of fLuc expression ($\sim 1.6 \times 10^6$ p/s) was statistically no different to that conferred by the constitutive AAV2/9 vector ($P < 0.05$, ANOVA, SNK test). fLuc expression for the control groups remained similar to baseline. We observed a modest increase in fLuc expression in those mice injected with the constitutive AAV vector. The induction was repeated three weeks later and similar levels of increase in fLuc expression were observed. No adverse events to either of the two rapamycin inductions were observed in any of the treated mice. Here we demonstrate the utility of an AAV-based inducible vector system designed to regulate gene expression in airway epithelium *in vivo*, which is particularly applicable to disease states that require short-term high levels of gene expression.

546. Development and Characterization of a New Tet-ON AAV Vector for Tightly Controlled Transgene Expression

Davide Gianni,¹ Nancy H. Tran,² Dimphna H. Meijer,² Miguel Sena-Estevés.¹

¹Neurology and Gene Therapy Center, University of Massachusetts Medical School, Worcester, MA; ²Neurology and Neuroscience Center, Massachusetts General Hospital, Charlestown, MA.

The regulation of transgene expression is a critical aspect for gene therapy-based therapeutic approaches. In particular this aspect is of primary importance when the genes encoded in the vectors can potentially interfere with the cell metabolism and survival. Tetracycline (Tet)-mediated regulation of gene expression has been extensively investigated and several generations of Tet-responsive systems have been developed. However most of the systems in the context of viral vectors are affected by significant basal expression in the non-induced state (OFF state). Here we describe a new AAV vector system (Tet^D-AAV) carrying two different Tet-responsive elements (rtTA2^S-M2 activator and tTS^{Kid} repressor) in *cis* with the transgene in order to achieve low background expression in OFF state and sustained expression during induction. The *in vitro* characterization of gene expression regulation was performed with a Tet^D-AAV2 vector encoding Gaussia luciferase (Gluc) as reporter gene. The vector was tested on several cell lines including 293T, U87, GL261, SH-SY5Y and normal human astrocytes transduced at vector doses of 1e5 genome copies (gc)/cell. Gluc assays in the supernatant of transduced cells showed low Gluc levels in the OFF state and expression levels in the ON state comparable to those obtained with an AAV vector encoding Gluc under a CBA promoter and also carrying a WPRE element. This resulted in induction ratios of 400- to 1200-fold depending on the cell line with maximum transgene expression observed at a doxycycline (Dox) concentration of 1 μ g/ml. Additional *in vitro* characterization was performed replacing Gluc with human (h) or murine (m) interferon b (IFN-b) in the vector and verifying the effects of these cytokines on the growth kinetics of glioblastoma cell lines U87 and GL261 in culture. Our results clearly showed significant inhibition

of tumor cell growth in the presence of Dox ($p < 0.001$), but minimal effects in the absence of Dox (OFF state). As the IFN-b anti-tumoral effects are species-specific, we transduced U87 and GL261 cells with Tet^D-AAV2-mIFN-b and Tet^D-AAV2-hIFN-b, respectively, at 1e5 gc/cell to quantify IFN-b levels in culture medium in the ON and OFF states using ELISA assays. Our results showed that in the presence of Dox the Tet^D-AAV2-IFN-b vectors expressed IFN-b levels 2-10-fold lower than those obtained with AAV2 vectors encoding IFN-b under a constitutive promoter, but extremely low levels in the absence of Dox ($<$ detection limit for hIFN-b produced in GL261). In conclusion we have developed a new Tet-regulated AAV vector characterized by tight regulation of transgene expression in cultured cells. Ongoing *in vivo* studies will characterize the regulation characteristics of the new Tet^D-AAV vector by bioluminescence imaging after intraparenchymal infusion in the adult mouse brain.

547. Therapeutic microRNA Delivery Suppresses Mechanical Allodynia Induced by Mononeuropathic Pain in Rats

Chung-Ren Lin,^{1,2} Kuan-Hung Chen,¹ Chih-Hsien Wu,¹ Yi-Shen Chen.¹

¹Anesthesiology, Chang Gung Memorial Hospital-Kaohsiung Medical Center, Chang Gung University College of Medicine, Kaohsiung, Taiwan; ²Anesthesiology, National Taiwan University Hospital, Taipei, Taiwan.

BACKGROUND: Neuropathic pain is a pain that comes from problems with signals from the nerves. It is characterized by spontaneous pain, thermal hyperalgesia and mechanical allodynia and often occurs as a result of injury to peripheral nerves. To understand the molecular mechanisms underlying neuropathic pain, it is essential to elucidate how nerve injury alters gene expression and how the change contributes to the development and maintenance of chronic pain. MicroRNAs regulate gene expression in a wide variety of biological processes mainly at the level of translation. Recent studies have suggested that miRNA might play a role in neuropathic pain. **METHODOLOGY/PRINCIPAL FINDINGS:** In this study, we investigated the role of miR-183 in a rat spinal nerve ligation (SNL) model and explored the feasibility of treating neuropathic pain by replacing miR-183. Our results demonstrated that expression of miR-183 decreased significantly in SNL DRG neurons compared to controls. Intrathecal lentivirus-mediated delivery of miR-183 attenuated SNL-induced mechanical allodynia might through inhibiting the activation of Nav1.3 and BDNF. **CONCLUSIONS/SIGNIFICANCE:** These findings suggest that replacement of miR-133 may be a new strategy for the treatment of neuropathic pain.

548. Differential Regulation of Multiple Transgenes by Alternative Splicing

Eun-Young Choi,¹ Xiaohuai Zhou,¹ Richard J. Samulski.¹

¹Gene Therapy Center, University of North Carolina at Chapel Hill, Chapel Hill, NC.

Regulation of transgene expression is necessary in certain gene therapy strategies to achieve optimal results and avoid adverse effects from over-expression, especially given the long-term retention of the transgene in the target cells. In this regard, we are developing a novel regulation system to control transgene expression mediated by adeno-associated virus (AAV) vectors, which can provide long-term transduction of host cells. This regulation system is based on the alternative splicing mechanism of the mutant human b-globin intron-2, IVS2-654. We incorporated IVS2-654 into expression cassettes and demonstrated that the expression of the transgenes could be induced by the application of an antisense oligonucleotide (ASO) corresponding to the 5' splice site of the intron, leading to alternative splicing. Furthermore, we generated an optimized IVS2-

654 intron by modifying 5' alternative splice site for tight regulation, and by reducing the size to comply with the size limitation of AAV genomes. We found that the constructs containing the optimized intron had significant improvements in the level of induction of transgene expression. In addition, we generated constructs that contain different sequences at 5' alternative splice site of the intron. We determined the expressions of these constructs are independently controlled by their corresponding ASOs. We suggest that this system can be developed to independently regulate the expression of multiple transgenes, and can be applied to gene therapy of diseases that require treatment in a complex multi-step process for an extended period of time.

549. Hypoxia-Specific Gene Expression System Using Oxygen Dependent Degradation Domain of Activating Transcription Factor 4 for Cancer Specific Gene Therapy

Su Hee Cho,¹ Hyun Ah Kim,¹ Ji Hwan Park,¹ Min Hyung Lee.¹
¹Bioengineering, Hanyang University, Seoul, Republic of Korea.

Solid tumor contains hypoxic region, which is an excellent target for tumor specific gene therapy. In this study, the oxygen dependent degradation (ODD) domain from activating transcription factor 4 (ATF4) was evaluated for hypoxia specific gene expression. ATF4 is a basic leucine-zipper (bZip) transcription factor, which regulates amino acid metabolism, cellular redox state, and anti-stress responses. ATF4 is over-expressed in hypoxic areas of tumors. ATF4 is induced under hypoxia, which was mediated by the ODD domain. To evaluate the ATF4 ODD domain for hypoxia specific gene expression, pSV-Luc-ATF4 ODD was constructed. For the construction of pSV-Luc-ATF4 ODD, the luciferase cDNA without the stop codon was inserted into pSV vector. Then, the ATF4 ODD cDNA was chemically synthesized and inserted at the downstream of the luciferase cDNA. In vitro transfection assay was performed and the cells were incubated under hypoxia or normoxia. The results showed that luciferase expression was induced under hypoxia in the pSV-Luc-ATF4 ODD transfected cells. RT-PCR showed that the luciferase mRNA levels were not different between normoxia and hypoxia, suggesting that the induction of luciferase expression was post-translational event. For cancer therapy, pSV-TK-ATF4 ODD was constructed, in which the thymidine kinase (TK) expression was regulated by the ATF4 ODD. To evaluate the TK expression under hypoxia, *in vitro* transfection assay was performed and the cells was treated with the ganciclovir (GCV) under hypoxia and normoxia condition. The results showed that the cells transfected with pSV-TK-ATF4 ODD had lower cell viability under hypoxia than normoxia. It suggests that the ATF4 ODD domain stabilized TK under hypoxia and promoted degradation of TK under normoxia. However, the pSV-TK transfected cells did not show this effect. In conclusion, a post-translational regulation system using the ATF4 ODD domain may be useful for the development of the cancer specific gene therapy system.

550. DNA Methylation and Gene Expression in hESCs Grown in Defined and Xeno-Free Culture Systems

Joshua D. Tompkins,² Christine A. Hall,¹ Vincent C. Chen,¹ Sylvana Couture,¹ David Hsu,¹ Larry A. Couture,¹ Arthur D. Riggs.²

¹Center for Biomedicine and Genetics, City of Hope, Duarte, CA;
²Molecular and Cellular Biology, City of Hope, Duarte, CA.

Therapeutic applications for human embryonic stem cells (hESCs) will require the large-scale adaptation of cell lines to fully defined and xeno-free culture conditions. Therefore, it is crucial that we first understand the interaction of hESCs and their culture environments, as well as the consequences of altering such interactions on a genome-wide scale. In this study, we have comprehensively analyzed

gene expression and DNA methylation profiles of hESCs during adaptation (and reverse adaptation) to multiple substrate/medium combinations: MEFs/DMEM-F12 KSR medium, Matrigel/mTeSR1, and CELLstart/STEMPRO. These experimental conditions allow for the comparison of traditional hESC cultures to commercially available fully defined systems. Results indicate that markers of pluripotency exhibit consistent DNA methylation and expression patterns appropriate for the stem cell state in all culture environments. Yet, culture manipulation commensurately altered the expression of gene sets that appear fundamental to hESC adaptation. In particular, differential expression of genes encoding membrane spanning and secreted cell adhesion factors suggest a substrate-specific membrane reconfiguration. We further note, compensatory expression changes in genes controlling growth factor responses and metabolic pathways as a reaction to cellular signaling targeted by medium formulations. We find that despite hundreds of differentially expressed genes between cultures, that DNA methylation remains remarkably stable, and the overwhelming majority of culture induced methylation events are highly specific and fully reversible. However, DNA methylation changes were found to increase both with culture manipulation as well as with prolonged passage. These sites of disparate DNA methylation were linked to expression levels of a small number of key genes involved in not only cellular adhesion, but in controlling G-protein coupled signaling, of which the latter may be responsible for the larger scale of microenvironment associated expression changes. Genome-wide, we identify correlations between DNA methylation and gene expression including a novel association of gene silencing and DNA hypomethylation at promoter distal sites. These observations provide insight into the function of DNA methylation in hESCs. Taken together, our results demonstrate that hESC acclimation to defined culture conditions is marked by a corresponding response at the gene regulation level and convey that epigenetic fidelity should be considered when maneuvering hESC cultures, especially when considering downstream therapeutic purpose.

551. Evaluation of the X-Protein Truncate Expression Potential from the WPRE Element in Alipogene Tiparovec, an AAV-Based Gene Therapy Vector

Jacek Lubelski,¹ Florence Salmon,¹ Betty Au,¹ Larbi Afia,¹ Andrew Bakker,¹ Harald Petry.¹
¹Amsterdam Molecular Therapeutics, Amsterdam, Netherlands.

The woodchuck hepatitis virus posttranscriptional regulatory element (WPRE) is a hepadnavirus sequence that is widely used as a *cis*-acting regulatory module in various types of plasmids and viral gene therapy vectors. The WPRE is often essential to achieve sufficient levels of expression with integrative retroviral gene therapy vectors. WPRE has been under scrutiny in the last years because parts of its sequence overlap with that of the woodchuck hepatitis virus X protein (WHx) which has been suspected of being implicated in the development of liver tumours that is thought to be linked with the expression of a truncated X-protein. Here we have evaluated the potential of X-protein truncate expression upon transduction of two cell lines with Glybera™ (Alipogene tiparovec). Glybera™ is an adeno-associated virus based vector encoding the Ser^{447X} variant of the human lipoprotein lipase gene and containing a WPRE. Thus far there are no reports of WHx truncated expression alone from WPRE in an AAV based vector in relation to the generation of tumours. However, one report indicates the expression of an aberrant fusion protein comprising the WHx C-terminal truncate from a WPRE present in an AAV vector and the generation of tumours (Embury *et al.*, 2008). We have adopted the same methodology by trying to detect the WHx-protein expression with MAb 8429 (Millipore), a monoclonal antibody directed against the human HBx protein, targeting amino acids 50-88. This antibody was claimed by Embury *et al.*, to cross-

react with WHx. In order to confirm this assumption, plasmids harbouring HBx (positive control), WHx and WHx 82aa truncate under the strong CMV promoter were synthesized. These plasmids were used to express the corresponding proteins after transfection in HepG2 and C2C12 cells. Additionally, in order to determine if WHx was properly expressed, if not recognized by MAb 8429, it was also his-tagged. Here we show that the MAb 8429 directed against HBx failed to recognize either the full WHx protein or its truncate. The lack of cross reactivity of MAb 8429 with the WHx-protein invalidates the approach to detect WHx in our experimental settings. Therefore a polyclonal antibody was used, which adequately recognized the plasmid expressed WHx. Only with this antibody it became possible to investigate the expression of the WHx C-terminal truncate successfully. Subsequently, we demonstrated that no X-protein expression can be detected in the HepG2 and C2C12 cell lines using this appropriate tool after transduction with alipogene tiparvovec.

Oligonucleotide & RNAi Therapeutics I

552. Abstract Withdrawn

553. Efficient Delivery of siRNA to Brain Capillary Endothelial Cells with Endogenous Lipoprotein *In Vivo*

Hiroya Kuwahara,¹ Kazutaka Nishina,¹ Kie Yoshida,¹ Tomoko Nishina,¹ Wenying Piao,¹ Hidehiro Mizusawa,¹ Takanori Yokota.¹
¹Neurology and Neurological Science, Graduate School, Tokyo Medical and Dental University, Tokyo, Japan.

Brain capillary endothelial cell (BCEC) is a major functional component of blood-brain barrier and is associated with pathophysiologies of diseases including brain ischemia, multiple sclerosis, and neurodegenerative disorders. We explored a gene-silencing method in BCECs by introducing short-interfering RNA (siRNA) using endogenous lipoprotein *in vivo*. Cholesterol-conjugated 21/23-mer siRNA targeting *organic anion transporter 3* (*OAT3*) mRNA (Chol-siOAT3) was intravenously injected to mice after incorporation into extracted endogenous lipoproteins. Chol-siOAT3 was not delivered to neurons or glia, but was successfully delivered to BCECs with a significant reduction of *OAT3* mRNA expression level when injected after incorporation into high density lipoprotein (HDL).

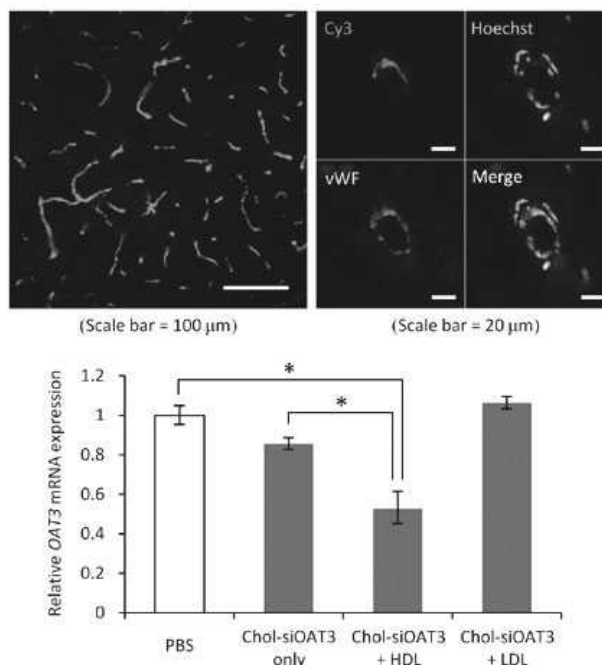

An efficient delivery was not achieved, however, when Chol-siOAT3 was injected without lipoproteins or after incorporation into low density lipoprotein (LDL). Investigations with apolipoprotein E (ApoE)-deficient and LDL receptor (LDLR)-deficient mice indicated that the uptake of HDL containing Chol-siOAT3 was mainly mediated by ApoE and LDLR in mice. These findings indicate that siRNA can be delivered to BCECs using endogenous lipoprotein and thus, this strategy is applicable as a new gene-silencing therapy for the diseases related to BCECs.

554. Chemically Modified Antisense Oligonucleotides Can Direct Transcriptional Regulation of Gene Expression

Stuart E. Knowling,¹ Anne-Marie Turner,¹ Kevin V. Morris.¹
¹Department of Molecular and Experimental Medicine, The Scripps Research Institute, La Jolla, CA.

Small non-coding RNAs have been shown to guide epigenetic silencing complexes to target loci in human cells. When these targeted loci are located at a gene promoter the result of such targeting can lead to long-term stable epigenetic silencing of gene transcription. To date, small RNAs have been shown to modulate transcriptional gene silencing of HIV-1 as well as several other genes but it has remained unknown as to what extent particular chemistries can be used to generate single stranded backbone modified oligonucleotides that are amenable to this form of gene targeting and regulation. We present data here suggesting that specific combinations of backbone modified chemistries can be used to generate single stranded antisense oligonucleotides which can functionally direct transcriptional gene silencing of HIV-1 and the proto-oncogene PLK-1. These data suggest that backbone chemically-modified oligonucleotide based approaches could be implemented as a means to epigenetically regulate a specific genes transcription, in this case HIV-1 and PLK-1 expression. Expanding upon these observations one could surmise that virtually any actively transcribed gene in the human cell could be susceptible to modulation by backbone chemically-modified oligonucleotides.

555. AAV Vector-Mediated Efficient and Sustained miRNA Antagonism In Vivo for Studying miRNA Function and Treating Hyperlipidemia

Jun Xie,^{1,2} Stefan Ameres,³ Randall Friedline,⁴ Jui-Hung Hung,⁶ Qing Xie,^{1,2} Li Zhong,^{1,5} Qin Su,¹ Ran He,¹ Mengxin Li,^{1,2} Xin Mu,^{1,2} Hongwei Zhang,^{1,2} Seemin Ahmed,^{1,2} Jennifer Broderick,³ Chengjian Li,³ Jsaon Kim,⁴ Zhiping Wen,⁶ Terence Flotte,⁷ Phillip Zamore,³ Guangping Gao.^{1,2}

¹Gene Therapy Center, UMass Med, Worcester;

²Microbiol&Physiol, UMass Med, Worcester; ³Biochem& Mol Pharmacol, HHMI, UMass Med, Worcester; ⁴Mol Med,

UMass Med, Worcester; ⁵Medicine, UMass Med, Worcester;

⁶Bioinformatics, UMass Med, Worcester; ⁷Pediatrics, UMass Med, Worcester.

miRNAs are small 20–24 nt RNAs that repress the expression of mRNAs with which they can partially base pair. miRNAs are predicted to regulate more than half of all protein-coding genes in mammals and play important roles in normal physiology and the pathogenesis of diseases. However, few miRNA-target interactions have been experimentally validated, especially *in vivo*. Understanding the function of individual miRNA species in mice would require the creation of hundreds of loss-of-function strains. To accelerate study of miRNA biology and develop miRNA-targeting biotherapeutics, we combined the efficient and durable somatic gene transfer of rAAVs with miRNA antagonists to inhibit specific miRNAs in mice. Here, we report proof-of-concept studies using rAAV vectors in mice to inhibit miR-122, a miRNA highly abundant in liver, and *let-7*, a miRNA with functions in cancer and development. We evaluated different promoters and designs of miRNA antagonists *in vitro*, and identified the most potent miRNA antagonist. We then created rAAV9 expressing inhibitory RNAs for miR-122 and *let-7*, to achieve efficient, sustained and specific inhibition *in vivo*. Each miRNA inhibitor increased the expression of the corresponding miRNA target genes in adult mice. High throughput sequencing of liver miRNAs from the treated mice confirmed that the targeted miRNA, but no other miRNAs, were depleted. Moreover, miRNA depletion *in vivo* was accompanied by the 3' addition of non-templated nucleotides as well as 3'-to-5' shortening of the miRNA, a degradation pathway previously observed *in vivo* in *Drosophila melanogaster* and *in vitro* in HeLa cells. To harness miRNAs as therapeutic targets, we tested the principle of using rAAV-delivered miRNA-122 inhibitor for treating familial hypercholesterolemia as an alternative approach to gene replacement therapy. rAAV producing inhibitory RNA to miR-122—but not to *let-7*—reduced serum cholesterol by 40% for 18 weeks in wild-type mice and reduced serum LDL by 50% in low density lipoprotein (LDL) receptor-deficient mice. Importantly, long term, rAAV-mediated inhibition of either miR-122 or *let-7* caused neither weight loss nor transaminase elevation. Our data suggest that rAAV-expressing miRNA inhibitors could enable stable therapy for hypercholesterolemia and other disorders caused by miRNA expression. In addition, rAAV-mediated miR-122 regulation in animal models may facilitate our understanding of the molecular mechanism by which miR-122-modulates cholesterol metabolism.

556. Short Hairpin RNAs Targeted to the S Segment of Rift Valley Fever Virus Inhibits Viral Replication and Alleviates NSS-Induced Pathogenic Effects

Tristan Scott,¹ Janusz Paweska,² Patrick Arbutnot,¹ Marco Weinberg.¹

¹Molecular Medicine, University of the Witwatersrand, Johannesburg, Gauteng, South Africa; ²Special Pathogens Unit, National Institute for Communicable Diseases, Johannesburg, Gauteng, South Africa.

Rift Valley Fever Virus (RVFV) is an endemic African disease which has demonstrated an incredible ability to spread geographically, with reported outbreaks in Saudi Arabia, Yemen and recently in central parts of South Africa. It is responsible for severe hepatitis, encephalitis and associated haemorrhagic fever for which no treatments or vaccines are available, opening up avenues for therapeutic development. RVFV is a tripartite RNA virus with a genome consisting of a Large (L), Medium (M) and Small (S) segments. The S segment is the genetic determinate for lethality for Bunyaviridae, encoding the non-structural S (NSS) gene, which is integral at inhibiting innate immunity, and the essential structural Nucleocapsid gene (NP). There are several recent studies showing that RNA interference (RNAi) can effectively inhibit high-replicating viruses, such as hemorrhagic fevers, *in vivo*. RNAi targeted to the S segment may be able to inhibit viral protein function and replication of RVFV. Short-hairpin RNAs (shRNAs) were generated against the NSS and the NP genes. The efficacy of the shRNAs were determined by testing against a full length mRNA in a dual-luciferase reporter system and demonstrated >80% knockdown against several strains of RVFV. The most effective and conserved shRNAs against all the strains were used to construct a single vector containing four shRNAs called a multi-expressing shRNA (me-shRNAs) system. Northern blotting analyses of mature siRNA products and knockdown of minimal targets (only the target site) in a dual-luciferase assay confirmed the processing of the individual and me-shRNAs. NSS and N proteins were reduced by the shRNAs as shown by western blot analysis. The shRNAs and the me-shRNA were tested against the NSS gene, resulting in a 2-fold derepression of NSS-induced transcriptional suppression and alleviation of its cytotoxic side effects. Inhibition of viral replication was demonstrated by transfecting huh7 cells with the single and me-shRNA and subsequent viral challenge with RVFV SA1981 strain. The shRNAs against the N gene reduced RVFV replication in cell culture over a 3 day study, resulting in 29.4% inhibition on day 2 and 15.5% inhibition on day 3. This is the first demonstration that RNAi can be used to inhibit *Bunyaviridae* like RVFV and shows that RNAi-based therapies should be developed further to treat high-replicating viruses.

557. Antisense Oligonucleotides Correct Aberrant PTS-Splicing: Therapeutic Potential To Treat Hyperphenylalaninemia and Brain Monoamine Neurotransmitter Deficiency

Sandra Brasil,^{1,2} Hiu Man Viecelli,³ David Meili,³ Anahita Rassi,³ Lourdes R. Desviat,¹ Belen Pérez,¹ Magdalena Ugarte,¹ Beat Thöny.³

¹Centro de Diagnóstico de Enfermedades Moleculares, Centro de Biología Molecular, Universidad Autónoma de Madrid, Centro de Investigación Biomédica en Red de Enfermedades Raras (CIBERER), Madrid, Spain; ²Metabolism & Genetics Group, Research Institute for Medicines and Pharmaceuticals Sciences (iMed.UL), Faculty of Pharmacy, University of Lisbon, Lisbon, Puerto Rico; ³Division of Clinical Chemistry and Biochemistry, Department of Pediatrics, University of Zurich, Zurich, Switzerland.

Antisense oligonucleotide therapy to modulate splicing mutations in inherited diseases is emerging as a treatment option also for metabolic defects. Here we report the effect of cellular antisense therapy to suppress pseudoexon activation in primary dermal fibroblasts from patients with mutations in the PTS gene encoding 6-pyruvoyltetrahydropterin synthase (PTPS), which leads to tetrahydrobiopterin and brain monoamine neurotransmitter deficiency, as well as hyperphenylalaninemia (OMIM 261640). Pathogenic inclusion of SINE or LINE-derived cryptic exons in different PTPS patients due to the intronic mutations c.84-322A>T, c.163+695_163+751del57, or c.164-712A>T was demonstrated by transcript analysis in fibroblasts and minigene *ex vivo* assays. Antisense morpholino oligonucleotides (AMOs) directed to the pseudoexons 3' or 5' splice sites were designed with the aim of preventing the pathological pseudoexon inclusion. At the time of AMO transfection, we investigated patients' cells for correct PTS-mRNA splicing and functional recovery of the PTPS protein. Transcriptional profiling after 24 hours post-transfection revealed a dose and sequence specific recovery of normal splicing. Furthermore, PTPS enzyme activity in all three patients' fibroblasts and the pterin profile were close to normal values after antisense treatment. Our results demonstrate proof-of-concept for pseudoexon exclusion therapy using AMO in inherited metabolic disease.

558. Mechanism of Uptaking Morpholino into Dystrophin-Deficient Muscle Fibers

Yoshitsugu Aoki,¹ Tetsuya Nagata,¹ Toshifumi Yokota,² Shinichi Takeda.¹

¹Department of Molecular Therapy, National Institute of Neuroscience, National Center for Neurology and Psychiatry (NCNP), Kodaira, Tokyo, Japan; ²Research Center for Genetic Medicine, Children's National Medical Center, Washington, DC.

Introduction: A promising therapeutic approach for Duchenne muscular dystrophy (DMD) is exon skipping using antisense oligonucleotides (AO) such as phosphorodiamidate morpholino oligomers (PMO). As we already demonstrated using exon 52 deficient mdx (mdx52) mice, short term systemic treatment of PMO targeting exon 51 induced highly efficient truncated but functional dystrophin in body-wide skeletal muscles (Mol Ther.2010;18:1995-2005). This result is encouraging for the ongoing multinational systemic exon-51 skipping clinical trial. However, the optimal therapeutic dose of PMO in DMD patients have not been established. Surprisingly, the mechanism of PMO entry into dystrophin-deficient fibers remain to be completely elucidated. **Purpose:** To verify the mechanism of PMO entry into dystrophin-deficient fibers using mdx52 mice. **Methods:** The combination of two AOs targeting the 5' and the 3' splice site was used for skipping exon 51. To research the relation between PMO entry and dystrophin deficient membrane, a total of

80-640 mg/kg of PMO was injected into the tail vein of mdx52 and C57BL/6J mice aged 5 wks singly. Muscles were isolated 2 weeks after the injection and analyzed by RT-PCR. Then, to determine the relationship between PMO entry and muscle regeneration, PMO (10 g) was injected into each tibialis anterior (TA) muscle of mdx52 mice aged 3 to 32 wks with oral administration of BrdU (0.8 mg/ml for 7 days). Muscles were obtained 2 weeks after the injection and analyzed by RT-PCR, immunohistochemistry and western blotting. **Results:** Specific exon 51-skipping and dystrophin expression were induced in a dose-related manner in mdx52 mice, while on the other hand, no exon 51-skipping was detected in C57BL/6J mice even at 640 mg/kg. Dystrophin positive fibers were detected with the greatest numbers when PMO was injected into TA muscle of mdx52 mice aged 5 wks when the ratio of centrally nucleated fibers were highly increased. Dystrophin positive fibers were classified into the two groups: BrdU-labeled regenerated and -unlabeled degenerated fibers in mdx52 mice.

Dystrophin positive fibers were seen highly in BrdU-labeled and moderately in BrdU-unlabeled fibers

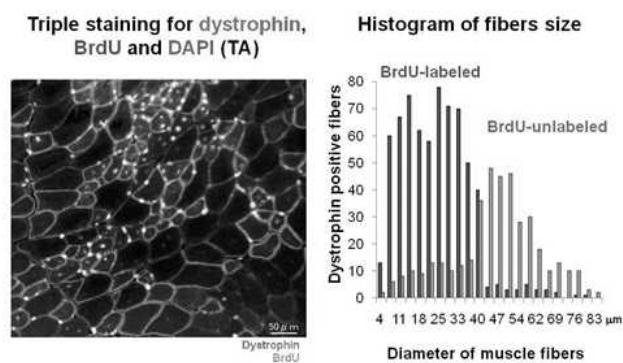

Conclusion: We suppose that there are two types of PMO entry into dystrophin-deficient fibers. **Interpretation:** BrdU-labeled regenerated fibers could uptake PMO regardless of dystrophin-deficiency and BrdU-unlabeled degenerated fibers could be 'fibers with leaky membrane'. Our study has a great potential to exploit an opportunity to optimize antisense therapy using PMO and to apply the treatment to other neuromuscular diseases.

559. Induction of Endogenous Pluripotency Factor Expression in Human Mesenchymal Stem Cells by Small Activating RNAs

Jon Voutila,¹ Pål Sætrum,² Paul Mintz,³ Guihua Sun,⁴ Jessica Alluin,⁴ John J. Rossi,⁴ Noriyuki Kasahara,^{1,5} Nagy A. Habib.³
¹Department of Molecular & Medical Pharmacology, University of California, Los Angeles, Los Angeles, CA; ²Department of Cancer Research & Molecular Medicine, Norwegian University of Science and Technology, Trondheim, Norway; ³Department of Surgery & Cancer, Imperial College London, London, United Kingdom; ⁴Department of Molecular and Cellular Biology, Beckman Research Institute, City of Hope, Duarte, CA; ⁵Department of Medicine, University of California, Los Angeles, Los Angeles, CA.

It is now recognized that small non-coding RNA sequences have the ability to mediate not only transcriptional and post-transcriptional silencing, but also transcriptional activation of specific target genes in human cells. Here we demonstrate that small activating RNA (saRNA) sequences can be employed to up-regulate the expression of endogenous pluripotency reprogramming factors such as Kruppel-like factor 4 (KLF4) and the c-MYC proto-oncogene. Using bioinformatics analysis, candidate saRNA oligonucleotides targeting the KLF4 and c-MYC promoters were designed, and screened for their ability to

upregulate expression of the targeted genes after transfection into primary human mesenchymal stem cells. This procedure identified saRNA sequences that consistently induced increases in mRNA expression and protein levels of KLF4 and c-MYC respectively in a time- and dose-dependent manner, as compared to transfection with a scrambled sequence control oligonucleotide. The functional consequences of saRNA-induced activation of each targeted reprogramming factor were further characterized by microarray gene expression profiling, and revealed significant increases in mRNA levels of their respective downstream pathway genes. Notably, the microarray profile after saRNA-mediated induction of endogenous KLF4 and c-MYC showed similar gene expression patterns for stem cell/pluripotency- and cell cycle-related genes, respectively, as compared to lentiviral vector-mediated overexpression of exogenous KLF4 and c-MYC transgenes. Notably, however, significant expression changes related to epithelial-mesenchymal transition-related genes were observed which were not seen after saRNA-mediated activation of either endogenous target gene but were common to lentiviral vector-mediated overexpression of either transgene. The use of promoter-targeted saRNAs for the activation of pluripotency reprogramming factors could have broad implications for stem cell research.

560. Bioreducible Polymer-Mediated siRNA Knockdown of BNIP3 in Primary Rat Ventricular Cardiomyocytes for the Prevention of Hypoxia-Induced Apoptosis

Arlo N. McGinn,¹ Tae Il Kim,³ David A. Bull,² Sung Wan Kim.³
¹Pharmacology and Toxicology, University of Utah, Salt Lake City, UT; ²Surgery, Cardiothoracic Division, University of Utah, Salt Lake City, UT; ³Center for Controlled Chemical Delivery, Pharmaceutics and Pharmaceutical Chemistry, University of Utah, Salt Lake City, UT.

Gene therapy for the limitation of myocardial remodeling post-infarction has been investigated for many years but has primarily focused on improving cardiomyocyte survival through transfection with pro-recovery growth and angiogenic factors. In addition to attempting to increase cell viability through the expression of paracrine factors, others have attempted to curb remodeling by targeting apoptotic pathways in an attempt to limit loss of cardiomyocytes post-infarction. We have recently investigated the effects of knock down of the proapoptotic protein BNIP3 on abrogating hypoxia-induced apoptosis. BNIP3 is a unique target in myocardial infarction as it has been shown to play a major role in inducing apoptosis under hypoxic conditions. Here we show that bioreducible polymer-mediated delivery of siRNA directed against BNIP3 can effectively reduce hypoxic death in primary rat ventricular myocytes. A novel bioreducible cationic poly(disulfide amine), arginine-conjugated poly(cystaminebisacrylamide-diaminohexane-arginine) [poly(CBA:DAH:R)] was developed in our lab to efficiently transfect multiple cell lines and improve uptake through the conjugation of cell-penetrating arginine groups to the bioreducible polymer. To limit hypoxia-induced cell death we designed small interfering RNA (siRNA) towards BNIP3, a proapoptotic protein specifically upregulated by hypoxia, and delivered the siRNA via a bioreducible polymer transfection system into primary rat ventricular myocytes isolated from 1-2 day-old neonatal rat pups. poly(CBA:DAH:R) transfection of primary ventricular cardiomyocytes was over 120X greater than linear polyethylenimine (PEI) 25K MW controls as measured by luciferase transfection efficiency assays. Additionally, MTT viability assays demonstrated that transfection with poly(CBA:DAH:R) did not cause significant toxicity at w:w ratios in excess of 20:1 (polymer:DNA). We determined that siRNA-mediated knockdown of BNIP3 significantly protected primary ventricular cardiomyocytes from hypoxic death at

1% O₂. BNIP3 knockdown reduced hypoxia-induced cell death by over 50% when compared to scrambled siRNA controls (P<0.001) and also showed increased numbers of viable cells. Measurement of mitochondrial membrane permeability revealed that knockdown of BNIP3 reduced loss of mitochondrial membrane integrity for up to 5 days under hypoxia (P<0.05). Overall, we have demonstrated the potential utility of BNIP3 knockdown in preventing cardiomyocyte death post-myocardial infarction and the utility in knocking down BNIP3 to increase cell survival under hypoxia. We also demonstrated that poly(CBA:DAH:R) can be used to transfect primary rat ventricular myocytes efficiently and without significant toxicity. This work indicates BNIP3 is an ideal candidate for further investigation as a gene therapy target for the prevention of left ventricle remodeling post-myocardial infarction.

561. Hepatitis C Virus Infection Down-Regulates MIR-29: Effects on Viral Fitness and Hepatic Stellate Cell Activation

Sarmistha Bandyopadhyay,¹ Robin C. Friedman,² Rebecca T. Marquez,³ Kyle E. Brown,¹ Christopher B. Burge,² Warren N. Schmidt,¹ Yulei Wang,⁴ Anton P. McCaffrey.¹

¹Internal Medicine, University of Iowa, Iowa City, IA; ²Department of Biology, Massachusetts Institute of Technology, Cambridge, MA; ³Department of Pharmacology, University of Kansas Medical Center, Kansas City, KS; ⁴Life Technologies, Foster City, CA.

Background: Liver damage caused by hepatitis C virus (HCV) leads to hepatic stellate cell (HSC) activation and fibrosis. MicroRNAs are known to be involved in HCV infection and HSC activation; however, this field is largely unexplored. **Methods:** Using TaqMan miRNA profiling, we identified 12 miRNA families showing differential expression between livers from chronically HCV infected patients and uninfected controls. To identify pathways affected by miRNAs, we developed a new algorithm (PACT, Pathway Analysis of Conserved Targets), based on the probability of conserved targeting. **Results:** Expression profiling combined with PACT analysis suggested a role for miR-29 during HCV infection in humans. Intriguingly, miR-29 was down-regulated in the vast majority of HCV-infected patients. miR-29 regulates expression of extracellular matrix (ECM) proteins and was previously implicated in cardiac fibrosis. HCV infection in culture down-regulated miR-29, confirming a relationship between miR-29 and HCV. Importantly, miR-29 over-expression reduced HCV RNA abundance in culture. Thus, HCV may down-regulate miR-29 to enhance viral fitness. miR-29 also appears to play a role in HSCs. Although hepatocytes substantially outnumber HSCs, these two cellular compartments contribute roughly similar amounts of miR-29 to bulk liver. Cell culture activation of primary HSCs and transforming growth factor- β (TGF- β) treatment of LX-2 immortalized HSCs both down-regulated miR-29. Over-expression of miR-29 in LX-2 cells decreased proliferation and collagen expression. Decreased miR-29 levels during HCV infection may de-repress ECM synthesis during HSC activation. **Conclusions:** Our results suggest that HCV infection down-regulates miR-29 in hepatocytes during chronic HCV infection. TGF- β released as a result of HCV-mediated liver damage may potentiate collagen synthesis by reducing miR-29 levels in HSCs. These results suggest that treatment with miR-29 mimics *in vivo* might inhibit HCV while reducing fibrosis.

562. In Vivo Comparison of the Long-Term Efficacy of AAV Expressed ShRNA and miRNA Targeting Apolipoprotein B100

Piotr Maczuga,^{1,2} Annemart Koornneef,¹ Richard van Logtenstein,^{1,3} Florie Borel,¹ Harald Petry,¹ Sander van Deventer,¹ Pavlina Konstantinova.¹

¹Amsterdam Molecular Therapeutics, Amsterdam, Netherlands;

²Department of Gastroenterology, Leiden University Medical

Center, Leiden, Netherlands; ³Department of Hepatology,

Academic Medical Center, Amsterdam, Netherlands.

Serum low-density lipoprotein cholesterol (LDL-C) levels are proportionate to the risk of atherosclerotic cardiovascular disease. In order to reduce serum total cholesterol and LDL-C levels, RNA interference was used to inhibit expression of the structural protein of LDL-C, apolipoprotein B100 (ApoB). Highly effective siRNAs against conserved regions of human, mice and macaque ApoB were expressed from H1 Pol III promoter in the form of shRNA (shApoB10) or incorporated into artificial miRNA backbone (miApoB10) under the control of the CMV Pol II promoter. Both shApoB and miApoB inhibited endogenous ApoB with more than 80% *in vitro* in murine hepatocytes, despite the fact that miRNA constructs express 20 times less siRNA molecules per cell. Adeno-associated virus (AAV) was used for long-term transduction of murine liver with shApoB10 expressed from the H1 promoter or miApoB10 expressed from the liver specific LP1 promoter. In both cases strong knock-down of ApoB mRNA and protein levels were observed 4 weeks post injection. This correlated with a reduction in total cholesterol levels, without obvious signs of toxicity. However, after 6 weeks the inhibitory effect of the shApoB10 started to wear off rapidly, while miApoB10 retained a more stable inhibitory profile. At 22 weeks post-injection, ApoB10 and plasma cholesterol were still decreased to 50% from baseline. Ongoing research aims to determine the mechanism underlying the differences seen between long-term AAV-shApoB and AAV-miApoB efficacy in murine livers. We hypothesize that the long-term stability of the miApoB is due to its lower toxicity and off-target properties compared to shApoB because expression of miApoB is specifically limited to hepatocytes. Our results demonstrate that the artificial miRNA have a greater intrinsic inhibitory activity than conventional shRNAs and are better approach for development of RNAi based gene therapy of hypercholesterolemia and associated cardiovascular disease. In the future we want to express artificial miRNA targeting ApoB from an inducible expression system. Regulated expression of sh/miRNA combined with the use of a tissue specific promoter and different AAV serotypes will contribute to better and safer gene therapy approach. Decrease in murine plasma cholesterol levels by AAV-shApoB10 and AAV-miApoB10.

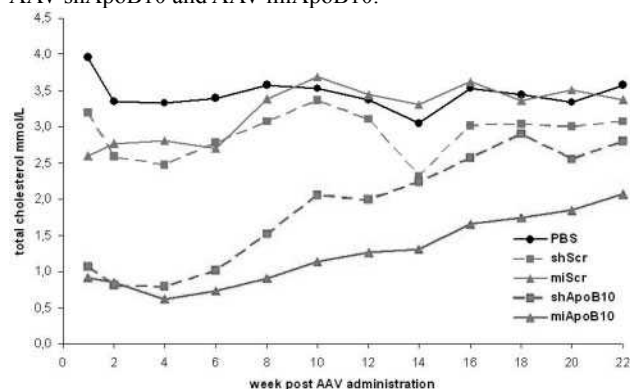

563. Developing Use of Inosine-Containing siRNAs To Improve Hepatitis B Virus Silencing Specificity

Justin Hean,¹ Carol Crowther,¹ Abdullah Ely,¹ Piet Herdewijn,² Patrick Arbuthnot.¹

¹Antiviral Gene Therapy Research Unit, University of the Witwatersrand, Johannesburg, South Africa; ²Laboratory of Medicinal Chemistry, Rega Institute for Medical Research, Leuven, Belgium.

Demonstration that hepatitis B virus (HBV) replication can be effectively silenced by harnessing RNA interference (RNAi) has prompted development of synthetic and expressed anti HBV RNAi activators for therapeutic application. Synthetic siRNAs have advantages of being amenable to chemical modification, compatibility with delivery using non viral vectors and 'drug-like' properties that facilitate dose regulation. Our group has previously reported incorporation of altritol modifications into siRNAs that successfully diminish immunostimulation and improve stability of HBV silencing sequences *in vivo*. After systemic administration of altritol siRNA lipoplex formulations, effective suppression of viral replication was achieved in a stringent transgenic mouse model that simulates human persistent HBV infection. Despite these encouraging results, potentially toxic unintended translational suppressive effects on cellular mRNA, caused by seed sequence hybridization, remain a concern of developing RNAi-based therapeutics. To address this and improve specificity of siRNA-target interaction, effects of modifications to nitrogen bases within the seed region of altritol siRNAs were assessed. Inosines have been substituted for guanine residues at various positions within the guide strand seed region. In addition to attenuating off target hybridization, these modifications diminish thermodynamic stability of the siRNA duplex at the 5' end of the antisense strands and further improve specificity by enabling intended guide strand selection. Modified siRNAs that target the conserved X open reading frame of HBV achieved highly efficient knockdown (>90%) of markers of viral replication in cultured cells. Position of the inosine residues within the seed region did not affect knockdown. Moreover, silencing efficacy was retained in siRNAs containing stabilizing altritol sugars. Efficacy was sustained without evidence of toxicity and induction of a non specific interferon response. These results indicate that incorporation of inosines into antiviral siRNA seeds, a novel modification, has potential for improving therapeutic application and is likely to have broad utility. To advance this approach, specificity of gene silencing and efficacy in murine models of HBV replication are currently being assessed.

564. Apolipoprotein B Knockdown by AAV-Delivered ShRNA Lowers Plasma Cholesterol in Mice

Annemart Koornneef,¹ Piotr Maczuga,^{1,2} Richard van Logtenstein,¹ Florie Borel,^{1,3} Bas Blits,¹ Tita Ritsema,¹ Sander van Deventer,² Harald Petry,¹ Pavlina Konstantinova.¹

¹R&D, Amsterdam Molecular Therapeutics, Amsterdam, Netherlands; ²Department of Gastroenterology and Hepatology, Leiden University Medical Center, Leiden, Netherlands;

³Department of Gastroenterology and Hepatology, Academic Medical Center, Amsterdam, Netherlands.

Serum low-density lipoprotein cholesterol (LDL-C) levels are proportionate to the risk of atherosclerotic cardiovascular disease. In order to reduce serum total cholesterol and LDL-C levels in mice, RNA interference was used to inhibit expression of the structural protein of LDL-C, apolipoprotein B100 (ApoB). We developed and screened 19 short hairpin RNAs targeting conserved sequences in human, mouse, and macaque ApoB mRNAs (shApoB) and subsequently narrowed our focus to one candidate for *in vivo* testing.

Adeno-associated virus (AAV) was used for long-term transduction of murine liver with shApoB. A strong dose-dependent knock-down of ApoB mRNA and protein was observed, which correlated with a reduction in total cholesterol levels, without obvious signs of toxicity. No evidence was found for oversaturation of the endogenous RNAi pathway, since liver-specific microRNAs mir-122, mir29-a, and let-7a were not significantly downregulated. In addition, mir-122 target genes AldoA, Bckdk, and Ndr3 were unaffected. AAV-shApoB was found to specifically reduce LDL-C in diet-induced dyslipidemic mice, while high-density lipoprotein cholesterol (HDL-C) remained unaffected. Finally, elevated lipid accumulation was shown in murine liver transduced with AAV-shApoB, a known phenotypic side effect of lowering ApoB levels. These results demonstrate a robust dose-dependent knock-down of ApoB by AAV-delivered shRNA in murine liver, thus providing an excellent candidate for development of RNAi-based gene therapy for the treatment of hypercholesterolemia.

565. Assessment of Zwitterionic Lipids as Vectors for Nucleic Acid Delivery

Juliane Nguyen,¹ Colin L. Walsh,¹ Francis C. Szoka.¹

¹*Depts. of Bioengineering, Therapeutic Science & Pharmaceutical Chemistry, UCSF, San Francisco, CA.*

Nonviral RNAi delivery technology provides great potential for the treatment of many human diseases which are not addressable by current medicine. Existing methods to deliver siRNA using cationic liposomes show high delivery efficiency but often cause unwanted toxic effects. Anionic liposomal systems display low cytotoxicity but their use in vivo is hampered by insufficient nucleic acid delivery, large sizes and low encapsulation efficiency. The objective of this research is to design a new class of lipids, which combine the advantages of both carrier systems into one vector: low cytotoxicity of anionic liposomes and high delivery efficiency of cationic liposomes. These lipids should display a neutral or negative surface charge at physiological pH and become positively charged at the lower pH of the endosomes. For this purpose we have synthesized a library of zwitterionic lipids that contain a cationic amine group and an anionic carboxylate group with pKa values of ~5-6. These zwitterionic lipids were characterized for encapsulation of nucleic acids (pDNA and siRNA), size, zeta potential, and ability to mediate gene silencing of FVII in vivo.

566. Multidrug Resistance Transporters and miRNAs Expression: Changes in Hepatocellular Carcinoma

Florie Borel,^{1,2} Harald Petry,¹ Peter Jansen,² Sander van Deventer,^{1,3} Pavlina Konstantinova.¹

¹*Amsterdam Molecular Therapeutics, Amsterdam, Netherlands;*

²*Department of Hepatology and Gastroenterology, Academic Medical Centre, University of Amsterdam, Amsterdam, Netherlands;*

³*Department of Hepatology and Gastroenterology, Leiden University Medical Centre, Leiden, Netherlands.*

ATP-binding cassette (ABC) transporters family is involved in multidrug resistance by decreasing the intracellular concentration of toxic compounds. This is a phenotype caused by overexpression of these transporters in tumor cells. Overcoming increased drug extrusion could lead to significant improvement of chemotherapy effectiveness for hepatocellular carcinoma (HCC) patients. In the current study we determined changes in expression pattern of ABC genes in HCC. We established the expression profile of 15 ABC transporters in 19 non-treated HCC patients obtained from Collection des Carcinomes Hepatocellulaires (France). We show that 12 ABC genes are significantly up-regulated in HCC compared to adjacent healthy liver. We next wanted to determine if these changes in ABC expression are associated with miRNA dysregulation. The miRNA

profile of a subset of 10 patients reveals significant changes between HCC and healthy liver, for instance the let-7 family is 3 times down-regulated in HCC. We have chosen a few down-regulated miRNAs which have bioinformatically predicted target in up-regulated ABC genes in order to validate them in vitro. ABC, sub-family C transporters Abcc1 and Abcc2, also known as multidrug resistance proteins MRP1 and MRP2, were up-regulated in HCC. Down-regulation of MRP1/MRP2 could result in improved response of the tumors to chemotherapy. We designed short hairpin RNAs: 6 targeting murine Abcc1 and 7 targeting murine Abcc2. In vitro assays in murine HCC cells showed endogenous mRNA knock-down of more than 50% with shAbcc11, shAbcc17, and shAbcc22, shAbcc23, shAbcc27, shAbcc28. The knock-down effect was sequence-specific and not due to shRNA off-targeting or toxicity. scAAV8 transduces almost completely the murine liver. scAAV8 expressing shAbcc11, shAbcc17, shAbcc22, shAbcc28 were therefore produced and injected in BL/6 mice and knock-down of Abcc1/Abcc2 was determined 2 weeks post-injection. Knocking-down multidrug resistance proteins may improve the effectiveness of the current anti-cancer therapies.

567. Antisense Drug Development for Skipping Human Dystrophin Exons In Vitro and In Vivo Systematically

Bo Wu,¹ Ehsan Benrashed,¹ Peijuan Lu,¹ Caryn Cloer,¹ Allen Zillmer,¹ Mona Shaban,¹ QiLong Lu.¹

¹*McColl-Lockwood Laboratory for Muscular Dystrophy Research, Carolinas Medical Center, Charlotte, NC.*

Antisense therapy has recently been demonstrated with great potential for frame-restoring of dystrophin mRNA in human muscle cells and in local muscles of Duchenne muscular dystrophy (DMD) patients. Therapeutic values of exon skipping critically depend on efficacy of the drugs, antisense oligomers (AOs), for targeted skipping of human dystrophin exons. Identification of AOs with highest efficiency and specificity is therefore crucial for AO drug development. In this study, we applied three cell culture systems, C2C12 myoblasts containing a GFP-reporter gene expressing human dystrophin exon 50, normal human myoblasts and a culture of DMD patient-derived skin fibroblasts, to screen AOs targeting human dystrophin exon 50. The GFP reporter system was most effective and sensitive for quantitative measurement of exon skipping efficiency. The efficacy of selected AOs was further investigated with Vivo-Morpholino chemistry in the hDMD transgenic mouse carrying the full-length human dystrophin gene. Our results suggest that a combination of in vitro cell culture based selection systems and a Vivo-Morpholino based evaluation in vivo systematically, provides stringent screening to identify effective AOs targeting human dystrophin exon for drug development to treat DMD patients.

568. Tracking Single Liposomes for Delivery of siRNA

Matthew R. Tiffany,¹ Francis C. Szoka.¹

¹*Bioengineering, Therapeutic Science & Pharmaceutical Chemistry, University of California, San Francisco, San Francisco, CA.*

The impetus for this work is based upon the observation that liposomes, and non-viral vectors as a whole, are inefficient at delivering their contents to the cytosol. For example, a single liposome encapsulates at least $\sim 10^2$ siRNA molecules, and at the very least 10^3 liposomes are bound per cell in a typical transfection. Thus the potential for delivery starts at 10^5 siRNAs per cell. In contrast, current estimates indicate that the cell needs $\sim 10^3$ siRNAs for effective silencing. The two log discrepancy between the amount dosed and the amount for a biological outcome suggests that either only a small fraction of molecules get delivered to the cytoplasm in

an active form or only a small fraction of liposomes deliver their contents. Internalization of liposomes is poorly understood at the single particle scale. First the liposome must interact with the cell at the plasma membrane where it can be endocytosed by a number of different mechanisms, potentially down a pathway resulting in non-productive delivery. Along this pathway the liposome experiences a drop in pH as the endosome transitions into a lysosome. It is believed that if the cargo does not escape from the liposome before the lysosome then delivery has failed. There are a variety of lipids that have been made to tune endosomal escape to a pH typically between 5 and 6. The most accepted mechanism of delivery involves mixing of cationic or zwitterionic vector lipids with the anionic lipids of the endosome. The oppositely charged lipid molecules undergo an electrostatic interaction resulting in charge neutralization and a bilayer phase change from lamellar to inverted hexagonal. This process allows the contents to release not only from the vector due to lipid mixing but also into the cytoplasm because of the phase inversion. We are studying the endocytosis and release of siRNA from liposomes using biochemical and optical techniques. To provide a consistent liposome-cell interaction we will use a melanoma cell adhesion molecule (MCAM) targeting scFv antibody. Our first aim is to determine the uptake kinetics of a control formulation (POPC:Cholesterol). We will then move into single particle tracking of control liposomes and determine endosomal pH change, modes of motion (active, simple, or constrained diffusion), fraction of successful delivery events, and contents release. Finally, we will repeat the studies with liposome formulations that are pH responsive (e.g. DOPE:Cholesterol hemisuccinate), including a new class of zwitterionic lipids. There is evidence demonstrating that pH responsive liposomes are better vectors than non-pH responsive liposomes on a population scale, however, what is lacking is a fundamental understanding of how, when and to what extent delivery occurs at the individual liposome level. This work is funded by the National Institute of Biomedical Imaging and Bioengineering project number 2R01EB003008-06.

569. RNAi-Mediated Gene Therapy of Human Diseases

Annemart Koornneef,¹ Piotr Maczuga,^{1,2} Florie Borel,^{1,3} Angelina Huseinovic,¹ Peter Jansen,^{1,3} Harald Petry,¹ Pavlina Konstantinova.¹
¹Amsterdam Molecular Therapeutics B.V., Amsterdam, Netherlands; ²Department of Gastroenterology, Leiden University Medical Center, Leiden, Netherlands; ³Department of Hepatology, Academic Medical Center, Amsterdam, Netherlands.

AAV vectors allow efficient, safe, long-term gene delivery in a wide range of tissues and therefore are excellent vectors for gene therapy. AAV vectors can efficiently deliver short hairpin RNAs (shRNAs) and microRNAs (miRNAs) that inhibit the production of a disease-related mRNA by RNA interference (RNAi). Our research is focused on treatment of two liver diseases: hypercholesterolemia and hepatocellular carcinoma. Additionally, we are developing RNAi-based gene therapy for Huntington's disease by AAV-delivered miRNA in the brain. **Hypercholesterolemia:** As a first proof-of-concept in vivo, the Apolipoprotein B (ApoB) gene expression was decreased in murine livers transduced with AAV-shApoB and AAV-miApoB. Transduction of murine livers with AAV-miApoB resulted in a reduction of murine plasma cholesterol and ApoB expression for up to 6 months while the inhibitory effect of AAV-shApoB started to wear off at 6 weeks. Ongoing research aims to determine the mechanism underlying the differences seen between long-term AAV-shApoB and AAV-miApoB efficacy in murine livers. We hypothesize that the long-term stability of the miApoB is due to its lower toxicity and off-target properties compared to shApoB because expression of miApoB is specifically limited to hepatocytes by a liver-specific promoter. Our results demonstrate a robust long-term knock-down of ApoB by AAV-delivered miApoB in murine liver, thus providing an

excellent candidate for development of RNAi-based gene therapy for the treatment of hypercholesterolemia and associated cardiovascular disease. **Hepatocellular carcinoma (HCC):** We are aiming to discover new targets for RNAi-mediated gene therapy of this devastating disease. The ATP-binding cassette transporters (ABC) are involved in tumor resistance by decreasing the intracellular concentration of toxic compounds. Therefore, we determined changes in expression of 15 ABC transporters in HCC by screening their profile in 19 paired HCC patient samples. Furthermore, we identified changes in expression of 79 cellular miRNAs between HCC and healthy liver. We are currently verifying the bioinformatically predicted miRNA targets in the ABC genes in vitro. The ABCC1 and ABCC2 genes were significantly up-regulated in the HCC patient samples. We designed shRNAs targeting ABCC1/2 and demonstrated a strong knock-down in vitro and we are currently trying to determine their efficacy in vivo using AAV-shRNA vectors. **Huntington's disease (HD):** HD is a dominant neurodegenerative disorder caused by poly-CAG expansions in the Huntingtin (Htt) gene. We are currently using artificial miRNAs to silence several target genes involved in HD in vitro. We are optimizing the miRNA molecules in order to obtain best efficacy and specificity against the target genes. For clinical applications, the miRNA expression should be switched on and off at desired points. Therefore, we are currently developing inducible miRNA expression system that can be used as an additional safety measure in the future RNAi-based gene therapy of genetic diseases.

570. Silencing the Human Eag1 Potassium Channel in Glioma Cells by Using Short Interfering RNA

Ludmylla C. Cunha,¹ Ana Paula P. Faria,¹ Bruno C. Gonzaga,¹ Elaine Del Bel,² Luis A. Pardo,³ Walter Stühmer,³ Ricardo Titze-de-Almeida.¹

¹Lab. Tecnologias para Terapia Gênica, FAV, UnB, University of Brasília - UnB, Brasília, Distrito Federal, Brazil; ²Lab. Neurofisiologia e Biologia Molecular, Dept. Morfologia Estomatológica e Fisiologia, FORP, University of São Paulo - USP, Ribeirão Preto, São Paulo, Brazil; ³Molecular Biology of Neuronal Signals, Max-Planck-Institute for Experimental Medicine, Göttingen, Germany.

Ether a go-go (Eag) potassium channels are natively expressed in mammalian brain regions. Most cancer cell lines and tumor tissues also express Eag1, the prototypic Eag potassium channel. In the present study we set up a protocol to silence Eag1 from glioma cells in culture. For that, we used dsRNA sequences synthesized by Qiagen targeted to the previously described mRNA Eag1 interfering sequence GTCCACTTGGTCCATGTCCAG. The dsRNA was transfected (150pmol) into glioma cells (U251MG) in culture using Lipofectamine® (Invitrogen). The negative control dsRNA was the commercial scramble All-Star® (Qiagen). The cell culture media used in our study were Optimem® (Gibco) and DMEM® (Gibco), for the first 6 hs and for the remaining 24h of incubation, respectively. We used commercial kits for RNA extraction (RNeasy Plus MiniKit®, Qiagen) and reverse transcription (SuperScript™ First-Strand Synthesis System for RT-PCR, Invitrogen). The relative expression ($2^{-\Delta\Delta CT}$) of Eag1 was determined by using a quantitative PCR protocol (qPCR) with SYBR Green® (Applied Biosystem 7500 Fast Real-Time PCR System). The forward and reverse primers for Eag1 were 5'-TCTGTCTGTTTGGCCATATGATGT-3' and 5'-CGGAGCAGCCGGACAA-3'. For the housekeeping gene transferrin, we used the primers 5'-GACTTTGGATCGGTTGGTGC-3', and 5'-CCAAGAACCGCTTTATCCAGAT-3'. The PCR mixture contained the following reagents: SYBR Green mix, 5,0 µL; cDNA, 250ng; 0,4 µL of each primer 10µM/µL; milliQ water up to 10µL. The qPCR cycles used in our study were: initial denaturation step at 95°C for 5min, followed by 40 cycles of amplification (denaturation

at 95°C for 1min, annealing and extension at 60°C for 1min). Each sample run in triplicate wells in the same plate. The siRNA used in our study decreased the *Eag1* content in glioma cells in culture. The relative expression of *Eag1* in the treated group was 0.7 fold in comparison to the negative control. In conclusion, glioma cells in culture expresses *Eag1* and this expression may be controlled by RNA interference sequences. A further study would clarify the time-course of this inhibition, the dose-response curve, and the effects on cell proliferation.

Stem Cell Therapies II

571. Characterization of Surface Markers and DNA Regulatory Gene Expression during Neutrophil Differentiation from Human Induced Pluripotent Stem Cells

Hongmei Wang,¹ Colin Sweeney,¹ Harry Malech.¹

¹Laboratory of Host Defenses, NIAID, NIH, Bethesda, MD.

We employed an effective method of deriving mature neutrophils from human induced pluripotent stem cells (iPSC) through a series of discontinuous culture steps over 30 days. For the first 18 days embryonic body formation was allowed to occur in the presence of bone morphogenic protein-4 (BMP-4), stem cell factor, flt-3 ligand, IL6 and thrombopoietin. The 18 day embryoid bodies were dissociated and cultured on OP9 stroma cells with the same factors plus IL3, but without BMP-4. At day 24 floating cells were collected and suspended in medium containing only G-CSF, with fully mature neutrophils developing by day 30. We analyzed hematopoietic surface marker expression during differentiation. On day 0, none of the surface markers that we later document below as appearing at stages of hematopoiesis were detected on the undifferentiated iPS, except for CD90 (Thy-1). CD90 was expressed in 100% of undifferentiated iPS cells with high intensity and it declined gradually until negative by the end of the hematopoietic myeloid differentiation. Surface expression of CD45 very gradually increased so that 4% of cells were weakly positive by day 18, but upon OP9 cell co-culture the CD45 expression could be detected on 100% of cells by day 20, though with intensity increasing thereafter. CD34 was modestly expressed in about 15% of the cells at day 9 of culture but decreased to 7% of cells by day 18. These day 9 CD34 positive cells that were CD45 negative could represent hemangioblast, precursors of both hematopoietic and endothelial cells. By day 22 over 30% of cells expressed CD34 and these were also dimly positive for CD45 suggesting that these represent hematopoietic stem cells. After day 22, CD34 declined rapidly as myeloid specific antigens CD15, CD16b, CD11b and CD33 were increasingly expressed. For further analysis, cells were sorted into subpopulations based on surface antigens and real-time PCR was performed to analyze specific transcription factors. GATA-2 and AML-1/Runx1 were up-regulated in the day 22 CD34+CD45+ presumptive hematopoietic stem cells compared with undifferentiated iPS cells, but were rapidly down-regulated with the later appearance of CD15 surface expression. The myeloid-associated transcription factors C/EBP α and PU.1 were highly expressed at the early stages of neutrophil differentiation and retained at high levels in CD33+ cells as well as CD15+ neutrophils. The late-acting transcription factor C/EBP ϵ was only detected in CD15+CD33+ cells, which is consistent with previous reports that C/EBP ϵ is exclusively expressed in the neutrophil lineage. Our study provides the first detailed characterization profile of surface marker phenotype correlated with DNA regulatory protein gene expression during neutrophil differentiation from human iPSC cells. This begins to define this system which uses human iPSC to model the complete process of myeloid differentiation, and which will be helpful to identify specific stages for further manipulating this differentiation process.

572. Clonal Cell Tracking Based on Multi-Colour RGB Marking with LeGO Vectors

Kristoffer Weber,¹ Michael Thomaschewski,¹ Michael Warlich,^{1,2} Tassilo Volz,² Kerstin Cornils,¹ Birte Niebuhr,³ Maïke Täger,³ Mark Lütgehetmann,² Jörg-Matthias Pollok,⁴ Carol Stocking,³ Maura Dandri,² Daniel Benten,² Boris Fehse.¹

¹Research Dept. Cell and Gene Therapy, UMC Hamburg-Eppendorf, Hamburg, Germany; ²Internal Medicine I, UMC Hamburg-Eppendorf, Hamburg, Germany; ³Molecular Pathology, Heinrich-Pette-Institute, Hamburg, Germany; ⁴Hepatobiliary and Transplant Surgery, UMC Hamburg-Eppendorf, Hamburg, Germany.

Stable and unambiguous marking of individual cells allows the analysis of *in vivo* fates on a clonal level, e.g. in transplant settings. Moreover, single-cell marking of tumor cells could facilitate the detection of the origin of metastases or malignant relapses of primary tumors and thus contribute to a better understanding of tumor biology and the potential role of tumor stem cells. However, even after the introduction of fluorescent proteins, unequivocal cell marking remains a demanding challenge, since only a limited number of colors are available. Here we introduce a novel technique that significantly broadens the use of stable cell-marking based on fluorescent proteins. To this aim we adapted a continuous color mixing method known from computer or TV screens as red/green/blue (RGB) color mixing. In analogy, our novel method named RGB marking takes advantage of the physical principle that any spectral color can be generated by mixing the named three basic colors at different intensities. We show here that stable individual coloring of different target cells based on the RGB principle may be achieved by lentiviral gene transfer. To do so, we transduced target cells simultaneously with three lentiviral vectors encoding the fluorescent proteins mCherry, Venus and Cerulean. We made use of our recently developed modular LeGO vector platform. For all three vectors we adapted multiplicities of infection to mark single cells by different combinations of inserted vectors, resulting in the generation of numerous mixed colors. We found that RGB marking remained stable after cell division, a *sine qua non* for the analysis of clonal cell fates *in vitro* and *in vivo*. Based on our new technique we were able to monitor the clonal expansion of transplanted primary hepatocytes in the uPA model of liver regeneration. We also demonstrated the possibility to RGB-mark hematopoietic stem progenitor cells, including short-term repopulating colony-forming units-spleen (CFU-S). Finally, we showed color constancy of RGB-marked tumor cell clones over extensive periods of time, and even after serial transplantation in a mouse liver tumor model. We conclude that RGB marking represents a powerful approach for cell clonality and tracking studies, particularly in models of organ regeneration and malignant transformation.

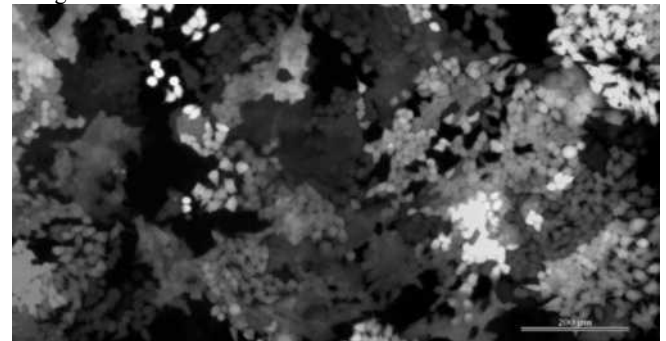

Figure 1: RGB marking generates a large number of easily distinguishable fluorescent colors, allowing clonal tracking *in vitro* and *in vivo* (RGB marked 293T cells *in vitro*).

573. Enhancement of Tumor-Killing Activity of TRAIL-Expressing MSCs by Using Trichostatin A

Ryosuke Uchibori,¹ Hiroyuki Mizuguchi,² Tomonori Tsukahara,¹ Masashi Urabe,¹ Hiroaki Mizukami,¹ Akihiro Kume,¹ Keiya Ozawa.¹

¹Division of Genetic Therapeutics, Center for Molecular Medicine, Jichi Medical University, Shimotsuke-shi, Tochigi, Japan;

²Department of Biochemistry and Molecular Biology, Osaka University, Suita-shi, Osaka, Japan.

Background: Mesenchymal stem cells (MSCs) have a tendency to accumulate at the tumor sites and are particularly attractive for use in cell-based cancer gene therapies. Tumor necrosis factor-related apoptosis-inducing ligand (TRAIL) has been shown to exert cytotoxic activity selectively against many tumor cells but not normal cells. Death receptor 5 is a receptor for TRAIL. Some studies have reported that histone deacetylase inhibitors (HDACis) such as trichostatin A (TSA), sodium butyrate, and suberoylanilide hydroxamic acid (SAHA) sensitized various tumor cells to TRAIL through upregulation of DR5 expression. In this study, we assessed therapeutic efficacy of TRAIL-expressing MSCs with the simultaneous administration of TSA. **Methods:** A cDNA fragment encoding the extracellular domain (amino acid residues 114-281) of human TRAIL (TRAILex) was amplified by PCR. To modify its structure to change soluble form and to enhance the tumor-killing activity, secretory signal sequence (N-terminal 28 amino acids of human fibrillin-1) fused with the isoleucine-zipper sequence was cloned into TRAILex. The resulting plasmid was denoted pSCZT. The SCZT-expressing adenovirus vector (AdK7) was generated by *in vitro* ligation method. MSCs were transduced with AdK7-SCZT (MSC-SCZTs). The human colon adenocarcinoma SW480 cells were treated with TSA, and DR5 expression was measured by quantitative PCR. MSC-SCZTs were cocultured with luciferase-expressing SW480 cells, and tumor killing activity of MSC-SCZTs was measured by luciferase assay. To assess the accumulation of MSCs at the tumor sites, SW480 cells were subcutaneously injected into the nude mice, and luciferase-expressing MSCs were injected into the left ventricular cavity of tumor-bearing mice. Bioluminescence from MSCs was periodically measured by *in vivo* imaging system (IVIS). MSC-SCZTs were injected into the left ventricular cavity of tumor-bearing mice, and tumor volume was periodically measured. **Results:** TSA significantly increased DR5 expression of SW480 cells. TSA sensitized SW480 cells to SCZT and enhanced tumor-killing activity of MSC/SCZTs. *In vivo* imaging revealed that administration of luciferase-expressing MSCs caused marked accumulation of the bioluminescence signal at the sites of tumors. Moreover, the simultaneous administration of TSA significantly enhanced the tumor-suppressive activity of MSC-SCZTs. **Conclusion:** Our results suggest that MSCs have potential use as effective delivery vehicle for therapeutic genes in the treatment of tumors. Furthermore, HDACis including TSA would work synergistically in enhancing TRAIL-induced apoptosis in tumors.

574. Reprogramming of Adult Human Extrahepatic Biliary Cells into Functional Pancreatic Beta Cells

Feorillo Galivo,¹ Raymond Hickey,¹ Kathryn Schubert,¹ Rohan Manohar,² Eric Lagasse,² Markus Grompe.¹

¹Oregon Stem Cell Center, Oregon Health & Science University, Portland, OR; ²McGowan Institute for Regenerative Medicine, Department of Pathology, University of Pittsburgh Medical School, Pittsburgh, PA.

Islet cell transplantation (ICT) is a promising alternative to insulin therapy for type I diabetes mellitus that can render a patient insulin-free and improve overall quality of life. Although still largely experimental, ICT is limited by lack of donors, requirement

for 2 or more pancreases and life-long immunosuppression. Recent studies indicate that cells of non-pancreatic origin, such as liver and embryonic cells can be potential sources of renewable beta cells. Given their interrelated ontogenies, we hypothesize that adult liver, gallbladder (GB), biliary ducts, and pancreas share molecular/epigenetic signatures and their fundamental differences can be traced to differential expressions of multiple factors during development that determine their fates in an adult organism. Studies showing successful transdifferentiation of liver, intrahepatic biliary cells, and exocrine pancreatic cells into functional insulin-producers suggest that an adult cell can be directly transformed into another cell type of similar developmental origin without reverting to a pluripotent state. These direct cell conversions were accomplished by introducing factors relevant to the target cell's ontogeny. For the same reason, we focus on the GB and the cystic duct (CD) as potentially renewable and expandable sources of autologous pancreatic beta cells. Normal tissue biopsies of GB and CD from human patients were enzymatically treated to obtain disaggregated cells for expansion and subsequent reprogramming *in vitro*. To convert GB and CD cells into beta cells, these were transduced with replication-defective recombinant adenoviruses encoding for various transcription factors of significant roles in pancreatic beta cell differentiation and which were also shown to be operative in reprogramming of insulin-producing cells. Our initial studies focused on the effects of Pdx1, NEUROG3, and MAFA on the gene transcription profiles of the reprogrammed cells in terms of pancreatic endocrine genes. Adenoviral transduction had very low efficiency and was improved by pre-treating with DEAE-Dextran prior to incubation with human gallbladder and cystic duct cells. Despite the low overall viral transduction, RNA transcripts of Pdx1, NEUROG3, and MAFA were significantly increased in transduced cultures. More importantly, a significant induction of insulin expression was detected in transduced cells relative to mock and Ad-GFP controls. Likewise, upregulation of glucagon, pancreatic polypeptide, and somatostatin genes was observed which can be enhanced by adding MAFB, NKX6.1, and PAX4-encoding adenoviruses. These preliminary results indicate possible reprogramming of human gallbladder and cystic duct into pancreatic islet cells. However, to fully assess the important determinants for full reprogramming, we are optimizing culture conditions, vector transduction, posttranscriptional and whole cell functionality assays, and testing combinations and stoichiometries of various regulators of pancreatic development.

575. iPS Cell Formation Invokes Shared Biological and Transcriptome Changes with Tumorigenesis

John Riggs,¹ Paul S. Knoepfler.¹

¹Stem Cell Program, University of California Davis, Davis, CA.

There is growing concern about potential oncogenic events occurring during iPS cell formation. We noted striking similarity between the methods employed for the production of induced pluripotent stem (iPS) cells and oncogenic foci (OF), a type of *in vitro* produced sarcoma cancer cell. To test the hypothesis that iPS cells and OF are highly related cell types, we produced them in parallel from the same parental fibroblasts. The end result is a system of iPS cells and cancer cells of identical genetic backgrounds. We observed that strikingly similar transcriptional changes occur during iPS cell and OF production relative to the common starting fibroblasts. The vast majority of genes repressed during iPS formation are also repressed in OF, including essentially identical cohorts of differentiation genes. In addition iPS cells and OF share strong overlap in activated genes that form modules predominantly related to metabolism. However, iPS and OF cells are distinct in specific ways. iPS cells only form teratoma when injected into immunodeficient mice, while OF only form malignant sarcoma. In addition, iPS cells activate a module of core pluripotency-related genes, while OF do not. In contrast,

OF uniquely activate novel cellular damage and specific metabolic pathways. Attempts to reprogram OF and other tumor cell lines into iPSC cells were only partially successful. We conclude that formation of OF and iPSC cells are highly related, yet distinct processes. Our findings support a model in which iPSC cell formation and tumorigenesis are parallel processes that diverge in only very specific ways and may share a common transitional progenitor cell stage relative to parental fibroblasts. These studies have critical implications for understanding stem cell biology, tumorigenesis including cancer stem cells, and regenerative medicine.

576. Genetic Modifications at Safe Harbor Loci in Hematopoietic Stem Cells for Gene Therapy

Laurent Poirot,² Roman Galetto,² Frédéric Lemaire,¹ Frédéric Cédron,¹ Sylvain Arnaud,² Agnès Gouble,² Carole Desseaux,² Julianne Smith,² Frédéric Pâques.¹

¹Collectis, Romainville, France; ²Collectis Therapeutics, Romainville, France.

Gene therapy for monogenic inherited diseases has generally relied on non-specific integration of genetic material into the genome of the target cells with potential risk of insertional mutagenesis. In contrast, targeted approaches offer the possibility of precisely editing genomic sequences. They therefore present less risk of adverse consequences but rely on the availability of accurate genomic tools. Meganucleases are natural highly specific endonucleases capable of inducing high frequency of homologous recombination at their target site. Redesigning their protein-DNA interface allowed us to engineer dozens of custom meganucleases with chosen specificity and ability to induce high levels of gene targeting. We are developing a number of custom meganucleases targeting defined loci in the human genome where insertion of a gene expression cassette would have a better therapeutic benefit/risk ratio (called safe harbor loci). The definition of a potential safe harbor depends on the indication and on the cell type where the modification is made. We characterize potential safe harbor meganucleases by measuring their ability to induce mutagenesis by non-homologous end joining or homologous recombination-mediated gene targeting in model cell lines. In addition, we have set up initial assays to examine the safety and capacity for the locus to support transgene expression, essential characteristics for defining a safe harbor locus. Because they can be manipulated *ex vivo*, cells of the blood lineage are an attractive target for gene therapy. Among them, we focus our efforts on hematopoietic stem cells (HSCs) since they can differentiate into a variety of cell types and therefore could be of interest in a variety of indications such as immune deficiencies, hemophilia or thalassemia. We will present our latest results on safe harbor meganucleases and on genetic modifications of HSCs.

577. Efficient Generation of Vector/Transgene Free Human Induced Pluripotent Stem Cells from Intractable Disease Patients Using Non-Integrating Sendai Virus Vectors

Noemi Fusaki,^{1,2} Hiroshi Ban,¹ Toshiaki Tabata,¹ Akihiro Iida,¹ Mamoru Hasegawa,¹ Hironobu Ihn,³ Takumi Era.⁴

¹DNAVEC Corporation, Tsukuba, Ibaraki, Japan; ²PRESTO, Japan Science and Technology Agency (JST), Kawaguchi, Saitama, Japan; ³Department of Dermatology and Plastic Surgery, Kumamoto University, Kumamoto, Japan; ⁴Department of Cell Modulation, Institute of Molecular Embryology, and Genetics (IMEG), Kumamoto University, Kumamoto, Japan.

[Introduction] Since the development of reprogramming somatic cells into induced pluripotent stem cells (iPSCs), a major limitation of current reprogramming strategies is the integration of vectors used to transduce the reprogramming factors. As a result, it is necessary to select 'elite' iPSCs with silenced foreign genes of low copy number

from numerous iPSC colonies. Many methods have been developed to overcome the issue, however, they are suffering from low efficiency or need tedious repetitive transfection. We have developed a novel and highly efficient method for generating human iPSCs by using Sendai virus (SeV) vector, an RNA replicon vector that carries no risk of integrating into host genome. Here we applied this excellent method to generate patient-specific iPSCs. Patient-specific iPSCs with intact genome would provide novel and considerable opportunities in the basic and pharmaceutical studies of the diseases, drug discovery and toxicology, and in regenerative medicine of coming age. We have established 33 patient-derived iPSCs out of 48 intractable diseases and others are ongoing under the grant of Ministry of Health, Labour and Welfare, Japan. [Methods and Results] Skin biopsy samples from 70 patients of 48 diseases were collected under the informed consent in the Hospital of Kumamoto University. Examined intractable diseases included inherited (neural, muscular, metabolic and other types), skin, bone and connective tissue-derived diseases and disorder of chromosomes. Fibroblasts from these patients were transduced with SeV vectors carrying the OCT3/4, SOX2, KLF4 and c-MYC gene and then cultured on MEF feeder cells. We have successfully established iPSCs from all of the fibroblasts tested and they showed gene expression of human ES markers and viral/factor-free nature. Clonal variation between the same patient-derived iPSCs was analyzed by the expression of specific genes and, very importantly, revealed that it was little in contrast to retrovirally generated iPSCs. We suggest that SeV vector is the most suitable tool for the study of disease specific iPSCs without any noise of integration.

578. Towards Targeted Transgene Integration in Induced Pluripotent Stem Cells

Ruan van Rensburg,¹ Oleg Denisenko,² Karol Bomsztyk,² Ines Beyer,¹ ZongYi Li,¹ Andre Lieber.¹

¹Division of Medical Genetics, University of Washington, Seattle, WA; ²UW Medicine Lake Union, University of Washington, Seattle, WA.

Achieving transgene integration into preselected genomic sites is currently one of the central tasks in stem cell gene therapy. A strategy to mediate site-specific integration involves site specific endonucleases. As their disruption has no functional consequences, two genomic sites within the *MBS85* and *CCR5* genes (*AAVS1* and *CCR5* zinc finger nuclease site, respectively) have recently been suggested as potential target regions for integration. Transgene integration can be affected by DNA accessibility of endonucleases and expression of the transgene is subjected to the epigenomic regulation of the region that contains the target site. We therefore studied the transcriptional and chromatin status of the *AAVS1* and *CCR5* sites in eight human induced pluripotent cell lines and pooled cord-blood derived CD34+ cells. Matrix chromatin immunoprecipitation assays demonstrated that the *CCR5* site and surrounding regions possessed a predominantly closed chromatin configuration and is transcriptionally inactive. In contrast, the *AAVS1* site was located within a transcriptionally active region and possessed an open chromatin configuration in both iPSC cells and hematopoietic stem cells. In addition, transductional studies comparing fiber-modified adenovirus vectors indicate that Ad5/35 effectively transduces iPSC cells and that of the tested promoters, the ubiquitin gene promoter allows for efficient transgene expression in transduced cells. Based on these results, we are currently developing a range of adenovirus vectors to facilitate targeted integration into the *AAVS1* site on iPSC cells.

579. Scalable Expansion of Undifferentiated Human Embryonic Stem Cells in Serum-Free and Defined Suspension Culture

Vincent C. Chen,¹ Sylvana Couture,¹ Jingjing Ye,¹ Joshua Tompkins,¹ David Hsu,¹ Melissa Carpenter,² Robin Wesselschmidt,¹ Larry Couture.¹

¹Center for Applied Technology Development, Beckman Research Institute of City of Hope, Duarte, CA; ²Carpenter Group, Seattle, WA.

We have extensive experience in cGMP banking of various cell lines in support of human clinical trials, including various viral vector producer lines, human feeder lines, and transformed neural stem cell (NSC) lines. Over the past several years we have focused our attention on the development of cGMP processes for banking and differentiation of human embryonic stem cells (hESCs) in support of planned and anticipated clinical studies. We have developed an adherent hESC line suspension culture adaptation process and a scalable suspension culture system using defined reagents. We have demonstrated that this system will support extensive passaging and expansion of several hESC lines. To develop the process, we assessed different serum-free, defined media and a broad spectrum of additive factors, including kinase inhibitors, cytokines, and adhesion modulators in small-scale rotary culture. Promising conditions were further tested in small-scale spinner culture. Our data shows that hESC cultured in the presence of a ROCK inhibitor and increased bFGF supported undifferentiated growth of hESC lines as small aggregates in suspension. Ultra-structural staining, immunohistochemistry, and confocal microscopic analyses of these cellular aggregates reveal high expression of pluripotent markers on the cells comprising the aggregates. Suspension culture parameters were further improved by assessing changes in agitation rate, seeding density, and passage interval to optimize cell growth while minimizing differentiation rates. Under optimized culture conditions, we demonstrated that hESCs can be serially passaged for more than 15 times in spinner flasks and expanded in large-scale to over 1×10^7 fold increase. The expanded cells retained a normal karyotype, low differentiation as measured by SSEA-4, Tra-1-60 and Tra-1-81, and Oct-4, high viability (>85%), and EB forming capability. Epigenetic analysis of the suspension culture showed high similarity to fingerprints from hESC cultured on mouse embryonic fibroblasts (MEFs). The cells can be cryopreserved in serum-free medium and thawed into adherent or suspension cultures with high viability (>85%). We have successfully used this method under cGMP conditions to generate cell banks of 200-400 vials of the hESC lines HES-2, H1, and H9. Taken together, our suspension culture system provides a powerful approach for scale-up expansion of hESCs and is suitable for process transfer to our GMP facility for banking and bulk differentiation of hESC lines in support of clinical studies as a national resource.

580. CXCR1 Mediated Migratory Capacity of Human Umbilical Cord Blood-Derived Mesenchymal Stem Cells toward Gliomas

Seong Muk Kim,¹ Dal-Soo Kim,² Chang Hyun Jeong,¹ Sin-Soo Jeun,¹ Wonil Oh,² Jong Wook Chang.²

¹The Catholic University of Korea, Seoul, Korea; ²MEDIPOST Co., Ltd., Seoul, Korea.

The use of tumor-tropic mesenchymal stem cells (MSCs) as a delivery vehicle of antitumor agents is a promising approach in cancer gene therapy. However, achieving a sufficient number of tumor-targeted MSC may be a limitation of this strategy. Interleukin-8 (IL-8) released by glioma cells mediate the tropism of MSC toward tumors. Here, we show that transfection of the IL-8 receptor, CXCR1, on human umbilical cord blood-derived MSCs (UCB-MSCs) enhanced the migratory capacity of MSC toward gliomas. We showed that

UCB-MSCs have the migratory ability toward the glioma cell lines and primary glioma cells. IL-8 treatment increased the migration of UCB-MSC in a dose-dependent manner and inhibition of IL-8 by treatment with the anti-IL-8 or IL-8 siRNA transfection into glioma cells blocked the migration capacity of UCB-MSC toward glioma cells. Furthermore, CXCR1-transfected UCB-MSCs (CXCR1-MSCs) showed a superior migratory capacity toward glioma cells compared with primary MSCs *in vitro* migration experiment, and also exhibited enhanced migration toward tumors in mice bearing intracranial human glioma by the histological and *in vivo* imaging analysis. Our findings indicate that overexpression of CXCR1 may be a useful tool for MSC-based gene therapy to achieve desirable sufficient quantity of therapeutic MSC that localize within tumors.

581. Engraftment and Fate of Endothelial Progenitor Cells Transplanted to Rat Hindlimb Ischemia Monitored by a Novel MRI Cell Tracking System

Tetsuji Yamaoka,¹ Carlos G. Agdelo,¹ Hidehiro Iida,² Yoichi Tachibana.¹

¹Department of Biomedical Engineering, National Cerebral and Cardiovascular Center Research Institute, Suita, Japan;

²Department of Bio-Medical Imaging, National Cerebral and Cardiovascular Center Research Institute, Suita, Japan.

Over the past decade, there has been increasing interest in developing cell transplantation therapy for various diseases. In particular, the transplantation of autologous cells such as mesenchymal stem cells and endothelial progenitor cells (EPCs) is much safer than the allogeneic transplantation and is promising in clinical use. However, the mechanism of cell transplantation therapy remains a matter of debate and even the engraftment ratio and survival period of the transplanted cells are still unclear. In the present study, EPCs in blood and bone marrow have been used for treating rat ischemic limbs. Main aim of this study is to quantify the engraftment, migration, and rejection of the transplanted EPCs by use of our original magnetic resonance imaging (MRI)-based cell tracking system. Bone marrow cells were harvest from femurs and tibiae of F344 rats (4 weeks old, male) after granulocyte colony-stimulating factor (G-CSF) induced mobilization of bone marrow derived EPC. CD34 and FLK 1 positive bone marrow cells were isolated by means of magnetic beads coated with antibodies CD34 and FLK1 and were cultured for 2 months in fibronectin-coated dishes with EBM-2 medium supplemented with growth factors for preparing enough number of cells. Histological identification of EPC was performed by staining with fluorescent carbocyanine DiI and FITClabeled Ulex europaeus agglutinin (UEA)-1. An MRI contrast agent based on water soluble polymer was synthesized by using 1,1'-carbonylbis-1H-imidazole (CDI) method. The aminated polymer was reacted with mono-N-succinimidyl 1,4,7, 10-tetraazacyclodecane-1,4,7, 10-tetraacetate (DOTA) and small amount of FITC, giving FITC-polymer-DOTA. Then it was reacted with a gadolinium chloride solution which is a paramagnetic metal ion used as a contrast agent, giving FITC-polymer-Gd. The FITC-polymer-Gd conjugate was introduced into the EPCs by electroporation under a mild and optimized condition. The stability and biocompatibility of the contrast agent was analyzed, and 1×10^7 labeled EPC was transplanted to rats with hindlimb ischemia. By our system, we successfully visualized the EPC engraftment and their migration. Interestingly the fate of EPC in the ischemia rats differed very much from that in the normal (non-ischemia) rats.

582. Ultrasound Gene Delivery to Mesenchymal Stem Cells: Targeting Tumor Therapy

Tom Haber,¹ Marcelle Machluf.¹

¹*Biotechnology and Food Engineering, Technion – Israel Institute of Technology, Haifa, Israel.*

INTRODUCTION: Gene therapy of stem cells such as mesenchymal stem cells, is an exciting therapeutic concept that offers the promise of therapy for an array of disorders and malignancies. MSC have been demonstrated to migrate to tumors and ischemic tissue thus can be used as a carrier of therapeutic DNAs. Ultrasound (US) is a non-viral approach used to deliver genes into cells and tissue. Non-viral vectors are emerging as substitutes to the viral ones since they are considered safer, easier to prepare and lack immunogenic response introduced. Ultrasound Contrast Agents (USCA) are gas-filled microbubbles that are used for medical applications. The assumption that cavitation is the major bioeffect attributed to gene delivery, suggested the addition of USCA to the medium to decrease the threshold for cavitation, thus increase transfections. In the present study, we aim to design and characterize a gene delivery system based on Therapeutic US (TUS) waves for the transfection of MSC. The transfected cells will be then used as gene delivery vehicles for the therapy of cancer. **EXPERIMENTAL METHODS:** In-vitro transfection: Mesenchymal stem cells were seeded in 6-well plates. Plasmid DNS (pDNA) encoding for Luciferase or GFP was added to the cells and cells were exposed to TUS different parameters with and without USCA. The transfection level was detected 3 days post transfection using illuminometer, and transfection efficiency was measured 2 days post transfection using FACS. The effect of TUS on the viability of the cells was measured using AlamarBlue assay. Effect of TUS on Cells' surface markers analysis: rMSCs (Ps. 7) were exposed to TUS of different parameters and analyzed for different cell surface markers such as: CD31, CD34, CD90 and CD44. The cells were then analyzed for the expression by using FACS. Cells not exposed to TUS served as control. Effect of TUS on cells' morphology-Microscope analyses: Cells were cultured, exposed to TUS application, fixed and stained with Phalloidin-FITC for actin filaments, with DAPI for nuclei and with Dil for membrane stain. Effect of TUS on cells' membrane permeability and integrity: Fluorescent conjugated dextran was added to the cells before and in different time points after the TUS application. The cells were exposed to TUS different parameters with and without USCA. The transfection efficiency was measured using FACS in order to understand the kinetics of membrane permeability in different TUS parameters. **RESULTS AND DISCUSSION:** TUS of 2W/cm², 30% DC operated for 20 or 30 min led to the transfection of MSC, when using 10 or 12 mg/ml of cDNA. Adding USCA resulted in higher transfection efficiency. TUS did not affect significantly the viability of the cells and did not alter the stemness of the cells. When dextran was added at different time points post TUS, transfection was negligible and lower compared to adding the dextran before the TUS. In-situ Time-laps imaging revealed that during TUS application the nucleus undergoes reversible morphological changes. **CONCLUSION:** Our study demonstrates that TUS can efficiently transfect MSC while maintaining their viability. These results suggest that transfected MSC may be used as a carrier of therapeutic DNAs in order to migrate to tumors and ischemic tissue.

583. Universal Stem Cell Gene Therapy Platform: Combining Ex Vivo Strategies and Injectable Tissue/Organ-Specific Extracellular Matrix (ECM) Hydrogels

Roger Bertolotti.¹

¹*CNRS, Gene Therapy and Regulation Research, Faculty of Medicine, University of Nice - Sophia Antipolis, Nice, France.*

Tissue/organ-specific extracellular matrix (ECM) hydrogels are emerging promising natural scaffolds for regenerative medicine. Non-invasive catheter/syringe-based delivery of solubilized ECM relies on an adjustment of the gelation properties/kinetics restricting the liquid-solid phase transition to the final location within the recipient tissue/organ. Such an injectable scaffold recapitulates the native ECM environment, thereby providing relevant cells with their tissue-specific matrix interactions. These ECM hydrogels are currently successfully used to recruit endogenous repopulating cells in animal models and will be soon experimented for the delivery of transplanted cells for basic regenerative medicine (e.g. myocardium regeneration, Singelyn & Christman, 2010). Such exciting data prompted us to devise a strategy for ex vivo gene therapy whereby therapeutic homing of engineered stem cells is achieved by tissue/organ-specific ECM hydrogel vehicles. Organs like liver are very attractive targets since in vivo gelation of injected ECM hydrogel will entrap engineered hepatic stem cells in regenerative structures that will compete with the original mutated tissue during the involution phase of the enlarged organ. Apoptotic involution will most likely equally affect both resident and transplanted cells, thereby securing an efficient engraftment of therapeutic cells even if they do not have a selective advantage over their mutant cognates. Our tissue/organ-specific ECM hydrogel strategy is thus discussed in terms of 1) hydrogel-based delivery and entrapment of ex vivo engineered stem cells into regenerative structures in which they can generate wild-type tissue with the revascularizing support of infiltrating endogenous vascular cells, 2) of reconstitution of tissue/organ-specific niches for engraftment of stable pools of therapeutic stem cells in order to secure long-term wild-type cell turn-over, and 3) of substitution in appropriate cases of ECM-linked growth/differentiative factors for transient topical regenerative gene therapy. Such an ECM hydrogel strategy stands thus as a perfect complement to basic stem cell gene therapy which is driven by the homing ability of many tissue-specific stem cells (e.g. engraftment of hematopoietic stem cells into their bone marrow niche, homing of endothelial progenitor cells into ischemic foci or tumor-tropism of neural stem cells). Of note, our proposed universal platform for autologous stem cell gene therapy has a transient regenerative gene therapy arm aimed at magnifying the homing ability of therapeutic stem cells. Synergistic combinations based on the use of ECM hydrogels are thus discussed in light of the main features of our proposed universal platform which relies on 1) long-term gene therapy mediated by endonuclease-boosted gene targeting (gene repair/alteration or targeted transgene integration) and cybridization (mitochondrial DNA transfer), 2) on transient gene therapy aimed at optimizing stem cell regenerative ability (see above) or at epigenetic gene control (e.g. potential genesis of fully pluripotent transgene-free iPS cells) and 3) on patient-specific iPS cells for most ex vivo applications.

584. Regenerative Cell Therapy for Liver Diseases with Skin Adipose Tissues-Derived Stem Cells

Sin-Ting Wang,¹ Chi-Chen Lin.¹

¹*Institute of Biomedical Science, Taichung, Taiwan.*

Liver diseases have long been the major threats to the health of people in Taiwan for decades. Unfortunately, current therapeutic options for many acute and chronic liver diseases are still very

limited and the outcome is usually unsatisfactory. Stem cell-based therapy, due to its regenerative and reparative natures, may serve as a promising therapeutic strategy for many liver diseases in the future. In the previous publication of our collaborators, it has been demonstrated that AT-MSCs may be further differentiated into hepatocyte-like cells; more importantly, it has also been shown that, human AT-MSC-derived hepatocytoid cells or even the original AT-MSCs, when injected into nude mice with acute liver injury via tail vein, may migrate to the damaged liver tissues and integrate with the recipient liver tissues and the recipient mice even showed improved liver function. Although this previous study of our collaborators has demonstrated the possibility of using AT-MSCs as a candidate stem cell-based therapy for liver diseases, **there are still many important questions need to be addressed. First of all, it is still unclear about the mechanisms governing the process of homing and migration of these AT-MSC cells to liver tissues.** Since chemokine receptor has been reported as an important mediator for stem cell homing, we hypothesize that it may also play an important role in the AT-MSCs homing to liver. **Secondly, it is important to determine whether AT-MSCs (without further differentiation efforts) can be used directly in cell therapy for liver diseases.** We then conducted several series of experiments and have found the following results: (1) chemokine receptor CCR4 is highly expressed by AT-MSCs at mRNA and protein level, (2) CCR4 is functional in AT-MSCs measured by chemotaxis assay, (3) induced by injection of galactosamine (an inhibitor of hepatic RNA synthesis) and bacterial lipopolysaccharide, the liver tissue in mouse showed increased expression of CCR4 ligands CCL22 and CCL17.

Cell Processing and Vector Production

585. Scalable Manufacturing of Recombinant Adeno-Associated Virus Using Suspension HEK293 Cells

Joshua C. Grieger,¹ Stephen M. Soltys,¹ Joy R. Burleyson,¹ Richard J. Samulski.^{1,2}

¹Gene Therapy Center, University of North Carolina, Chapel Hill, NC; ²Pharmacology, University of North Carolina, Chapel Hill, NC.

Adeno-associated virus (AAV) has shown great promise as a gene therapy vector in multiple aspects of pre-clinical and clinical applications. Many developments including new serotypes as well as self complementary vectors are now entering the clinic. With these ongoing vector developments, continued effort has been focused on scalable manufacturing processes that can efficiently generate high titer, highly pure and potent quantities of AAV vectors. Utilizing the relatively simple and efficient transfection system of HEK293 cells, originally developed in our lab, as a starting point, we have successfully adapted an adherent HEK293 cell line from a qualified clinical master cell bank to grow in serum-free suspension conditions in shaker flasks and wave bioreactors that allows for rapid and scalable AAV production. Using the triple transfection method, the suspension HEK293 cell line generates greater than 1×10^5 vector genome containing particles (vg)/cell or greater than 1×10^{14} vg/L of cell culture prior to purification. To achieve these yields, a number of variables were optimized such as selection of a compatible serum-free suspension media that supports both growth and transfection, selection of a transfection reagent and conditions, cell density, and other components essential for vector production. A universal purification strategy based on ion exchange chromatography methods was developed that results in high purity vector preps of AAV serotypes 1-6, 8, 9 and various chimeric capsids tested. This production approach also results in high full to empty particle ratios. After purification, greater than 1×10^{13} vg was attained from 1L of cell culture from shaker flasks and wave bioreactor bags.

586. Use of the Counterflow Centrifugal Elutriation in the Preparation of Apheresis Products for Use in Cell Therapy Applications

Chy-Anh T. Tran,¹ Monica Coronado,¹ Agnes Gardner,¹ Lijing Li,¹ Anitha Rao,¹ Lan-Feng Cao,¹ Qing Liu,¹ John A. Zaia,¹ David L. DiGiusto.¹

¹Virology, City of Hope, Duarte, CA.

Cell separation by counterflow centrifugal elutriation has been described for the preparation of Monocytes for dendritic cell vaccine applications but its use in other cGMP cell manufacturing operations has been limited. We have developed protocols that employ the Elutra™ cell separation device to wash and formulate apheresis products for subsequent ex-vivo cell processing procedures. G-CSF-mobilized peripheral blood progenitor cell products (HPC-A) were collected from 7 healthy donors (after obtaining informed consent) and processed within 24 hours of collection. Five fractions were collected for each product as per manufacturer's instructions. Each fraction was analyzed for cell count, viability and differential. The cellular composition of each fraction was also evaluated by flow cytometry using antibodies to CD34, CD3, CD14, CD19, CD15, CD56. Our data demonstrate that >99% of red blood cells and platelets were removed with high recoveries ($93.1 \pm 10.3\%$, N=6) of CD34+ cells. There was also an enrichment of CD34+ cells in two of five fractions (F4+F5) which was combined to form a single CD34+ fraction in our latest method. In some tissues, the CD34-enriched fractions were formulated, stained with antibody to CD34 and washed using the Elutra device and then transferred directly to a magnetic bead selection device (CliniMACS) for further purification. Cell purities from the column were extremely high ($98.8 \pm 0.6\%$, N=11) and yields were typical for the device ($56 \pm 11.7\%$, N=11). We also observed a selective enrichment of cells with a regulatory T-cell (Treg) phenotype (CD4+/CD25+/CD127lo) in two of the five fractions generated from elutriation of non-mobilized peripheral blood apheresis products. Both processes were highly automated and closed from receipt of apheresis product through formulation of target-enriched cell fractions. The elutriation profiles can be modified to accommodate a variety of cell targets and applications that require a washed, concentrated leukocyte product for downstream processing. Therefore elutriation is a feasible method for the initial manipulations associated with primary blood cell therapy products and supports cGMP/cGTP compliant cell processing.

587. Alternative Vector Titration Methods for scAAV Vectors Eliminate Systemic Errors Caused by Template Self-Annealing during qPCR Thermocycling

Paolo Fagone,¹ Susan Sleep,⁴ James A. Allay,⁴ J. Fraser Wright,⁵ Amit C. Nathwani,³ Andrew M. Davidoff,² Arthur W. Nienhuis,¹ John T. Gray.¹

¹Hematology, St. Jude Children's Research Hospital, Memphis, TN; ²Surgery, St. Jude Children's Research Hospital, Memphis, TN; ³Haematology, University College London, London, United Kingdom; ⁴Children's GMP, LLC, Memphis, TN; ⁵Pathology and Laboratory Medicine, Children's Hospital of Philadelphia, Philadelphia, PA.

Precise and accurate quantitative titration of clinical gene therapy vector preparations is critical for the proper interpretation of vector potency and efficacy. In the process of quality control analysis of our clinical grade self-complementary AAV vector for treatment of Hemophilia B, we observed that some vector quantitation assays generated consistently lower titer values than others amongst multiple independent lots of vector product. Specifically, our qPCR genome titration assay typically generated values 5-15 fold lower than those determined by UV spectrophotometry. We hypothesized

that the terminal hairpin present in this type of vector genome might facilitate template re-annealing to the exclusion of primer binding, and thus inhibit the efficiency of PCR amplification. To investigate this phenomenon we created a set of DNA preparations derived from both linearized plasmid and scAAV vector genomic DNA, incubated them with or without restriction endonucleases to liberate the terminal hairpin from the PCR amplicon, and carefully quantitated the products on agarose gels. When these DNAs were used as input for quantitative PCR amplification, we observed that in fact the terminal hairpin did cause a systemic under-reporting of the DNA copy number by as much as 10-fold, with PCR amplicons in close proximity to the terminal hairpin being more dramatically inhibited than those distal. We subsequently developed new assays for more accurate quantitation of AAV vector genomes, for which details will be presented. The first utilizes detergent treatment and restriction endonuclease digestion prior to direct amplification by qPCR, a method that severs the hairpin from the amplicon and that can be adapted to pre-existing qPCR assays. The other assay utilizes fluorescence quantitation of vector genomic DNA on agarose gels after capsid disruption and electrophoresis of vector sample. Both methods have been adapted such that they can be performed directly on intact particles without DNA purification. We have qualified these assays by performing them on carefully prepared scAAV and ssAAV vector preparations, and show that our new qPCR method generates titer values within 30% of the UV determined value, and with inter-assay standard deviation of less than 20% (n=4). The gel method generates titer values within 20% of the UV determined value, and with inter-assay standard deviation of less than 15% (n=3). Additionally, we found that dot blot hybridization titration assays were not inhibited by the terminal hairpin of scAAV vectors, and yielded titer values similar to those determined by the gel method, provided samples were carefully processed to remove contaminating protein.

588. PK-7 and RD2-MolPack-Chim3.14, Two Packaging Cell Clones for Semi-Stable and Stable Production of HIV-Based Lentiviral Vectors

Anna Stornaiuolo,¹ Bianca Piovani,¹ Francesca Salvatori,¹ Eleonora Zucchelli,¹ Claudio Bordignon,¹ Raul Ziliotto,¹ Gian-Paolo Rizzardi,¹ Chiara Bovolenta.¹
¹MolMed SpA, Milano, Italy.

Over the last two decades, several attempts to generate packaging cell lines for stable production of lentiviral vectors (LV) have been made. Despite different technologies disclosed, as of today none of the available packaging cells is employed in clinical trials or corners the market yet. Hence there is the need of new systems for large scale LV manufacturing which must meet safety, quality, cost containment and process feasibility demands. As MolMed SpA is a leader on cellular and gene therapy product development counting on a cGMP facility formally authorized for the production and release of medicinal products for human use, we generated two packaging cell lines for semi-stable (PK-7 clone) and stable (RD2-MolPack-Chim3.14 clone) production of HIV-based LV. We conceived a new strategy based on the use of integrating vectors for viral genes insertion into packaging cells. To obtain the PK-7 clone, we transiently transfected HEK-293T cells with a plasmid encoding the adeno-associated virus (AAV) Rep-78 protein and then infected them with a hybrid baculovirus-AAV vector, in which the baculoviral backbone contains an integration cassette expressing the HIV-1 structural *gag*, *pol*, the regulatory *rev* and the *hygro*-resistance genes flanked by the AAV inverted terminal repeats (ITR) sequences. This system allows the Rep78-mediated integration of the ITR-flanked cassette into HEK-293T genome. We have established by multiple approaches that PK-7 cells: 1) contain 2 copies, head-to-tail oriented, of the ITR-flanked cassette into Chrom2q32.1 location. 2) can be transfected as efficiently as the parental cell line (>95%) also in medium containing 5% FBS.

3) produce LV after transient transfection of the VSV-G envelope plasmid and the SIN-eGFP-transfer vector with a titer ranging from 1×10^6 to 1×10^7 TU/ml, depending on the culture condition even after 1 year of continuous culture (ca 420 doublings). From PK-7 we obtained the RD2-MolPack-Chim3.14 packaging clone through the sequential integration of the SIN-LV expressing the HIV-1 regulatory *tat* and the chimeric RD114-TR envelope gene and the Tat-dependent LV vector expressing the anti-HIV Vif dominant negative transgene Chim3. This clone grows in suspension for longer than 3 months of continuous culture (analysis is still ongoing at the present time) generating LV with a titer of 1×10^6 TU/ml. We demonstrated by Southern blot analysis the integrity of each vector used to construct RD2-MolPack-Chim3.14 and the integrity of Chim3-LV in transduced target cells, indicating that LV supernatants can be safely produced from this clone. In conclusion, PK-7 and RD2-MolPack-Chim3.14, as an example of a prototype PK-7-based stable packaging cell line, must be highly regarded for large-scale production of LV in clinical application. It is conceivable in fact that their use will increase safety, cut the costs and reduce manufacturing time.

589. Evaluation of Biopotency of rHIV Lentiviral Vectors Produced for Ex Vivo Hematopoietic Gene Therapy

Sabine Charrier,¹ Otto-Wilhelm Merten,¹ Frédéric Barnay-Toutain,¹ Armelle Viorneri,¹ Stéphanie Bucher-Laurent,¹ Muriel Audit,² Mehdi Gasmil,¹ Anne Galy.¹
¹Genethon, Evry, France; ²Genosafe, Evry, France.

The production of VSVg-rHIV lentiviral vectors under good manufacturing practices (GMP) was implemented to support clinical gene therapy trials for Wiskott Aldrich Syndrome (WAS) and in this context, we developed specific analytical methods to control the biopotency of the final product. The vector manufacture is based on transient transfection in cell factory stacks at the scale of 50L, and involves several membrane-based and chromatographic steps leading to about 200 fold volumic concentration, about 3 log of reduction in protein and DNA contaminants, and a final product titer of $1-2 \times 10^9$ infectious particles per mL. In-process characterization and controls have been recently published (Merten et al. Hum. Gene Ther. 2010). Batches of WAS vector produced under GMP are non-toxic and biologically-active. In particular, controls performed on umbilical cord blood CD34+ cells show efficient stable transduction with an average of 0.3 to 1 copy of vector per cell. To better evaluate the biopotency of large-scale purified rHIV vectors on hematopoietic cells, we developed a specific qPCR technique to analyze the integration of the vector at the clonal level. One cycle of infection of cord blood CD34+ cells with optimal concentrations of a purified VSVg rHIV is able to transduce about 50% of clonogenic hematopoietic progenitor cells with an average of 1 copy per cell and 94% of these cells have less than 3 copies of vector per cell, which can be considered to be a safe level of transduction. Two consecutive rounds of infection increased the frequency of transduced clones while retaining low levels of vector copies per cell. Altogether, these data contribute to the characterization of purified rHIV vector biopotency in the context of *ex vivo* hematopoietic applications and are essential for the manufacture of patient cell-specific gene therapy products in clinical trials.

590. Using Pulmozyme DNase Treatment as an Alternative to Benzonase for Lentiviral Vector Supernatant Production

Aaron Shaw,¹ Daniela Bischof,¹ Aparna Jasti,¹ Aaron Ernstberger,¹ Troy Hawkins,¹ Kenneth Cornetta.¹

¹Medical and Molecular Genetics, Indiana University School of Medicine, Indianapolis, IN.

In the production of lentiviral vector supernatant products for clinical studies the purity of the final product is of vital importance. To remove plasmid and producer cell line DNA, investigators have incubated the vector supernatant product with Benzonase, a bacterially derived DNase. As an alternative we investigated the use of Pulmozyme, an FDA approved human DNase produced by genetically modified Chinese Hamster Ovary (CHO) cells for the treatment of cystic fibrosis. By standard practice this incubation occurs after vector harvest; however, we were interested in evaluating the effectiveness of treating prior to addition of the harvest medium. A GFP-expressing lentiviral vector was prepared by transient calcium phosphate transfection of HEK 293T cells in T25 flasks. At the end of a 16 hour transfection, DNase was added to the culture and incubated for one to four hours. The medium was then changed and after an additional 24 hours the vector was harvested and filtered (0.45 μ M). To analyze the effectiveness of DNase treatment, Q-PCR was used to determine the amount of Vesicular Stomatitis Virus-G (VSV-G) viral envelope plasmid DNA remaining in the supernatant. Infectious titers were determined by flow cytometry to assess any adverse effects of DNase treatment on titers. The optimal dose of Benzonase for plasmid DNA removal of lentiviral supernatant was previously determined to be 50 units per milliliter (U/mL), treating for one hour at 37° C. In duplicate experiments, one hour treatments with 25-100 U/mL of Pulmozyme reduced plasmid DNA to a level equivalent to parallel samples treated with 50 U/mL of Benzonase. All were at least two logarithms less than the untreated control. Since there was no significant difference between 25-100 U/mL, we then evaluated Pulmozyme concentrations ranging from 1-25 U/mL. A dose response was observed; maximal effectiveness was observed in most, but not all, incubations with Pulmozyme at 15 or 20 U/mL. Consistent efficiency was observed at 25 U/mL. We then tested whether longer treatments with Pulmozyme of 5-25 U/mL could reduce the effective dose, but did not observe further reduction when incubating for greater than one hour. For all experiments there was no significant reduction in infectious titer when comparing the untreated control with Pulmozyme, regardless of dose or incubation time. Based on these results, the experimental conditions were scaled up to five layer cell factories, in triplicate, using the predetermined optimal dose of 25 U/mL of Pulmozyme or 50 U/mL of Benzonase. We were unable to observe any significant difference in the effectiveness of removing residual DNA from supernatant when treating them post-harvest versus treating them prior to addition of harvest medium, or by treating for longer than one hour. Our preliminary results indicate that 25 U/mL of Pulmozyme is just as effective as 50 U/mL of Benzonase and that treating pre- and post-harvest are comparable. This offers the possible advantage of less residual DNase in our final lentiviral vector supernatant product.

591. Large Scale Production of Suspension Cells for Clinical Application Using a Novel Cell Bioreactor

Juan F. Vera,¹ Lara Brenner,¹ Natalia Lapteva,¹ Ann M. Leen,¹ John Wilson,¹ Helen E. Heslop,¹ Cliona M. Rooney.¹

¹Baylor College of Medicine, Texas Children's Hospital, The Methodist Hospital, Houston.

The cost effective production of clinical grade cell products remains a major pitfall for broad cell therapy implementation. We previously

demonstrated that gas-permeable cultureware ("GP" or "G-Rex"), developed by *Wilson Wolf Manufacturing*, support the production of large cell numbers with minimal manipulation (*Vera et al, JIT, 2010*). O₂ and CO₂ exchange across the silicone membrane at the base of the GP device allows an increased depth of medium above the cells, which provides more nutrients while waste products are diluted. These culture conditions increase cell output by 3-20-fold compared with conventional commercial products such as bags, flasks, and 24-well tissue culture plates by improving cell viability and prolonging cell division. We originally tested two GP devices with bases of 10cm² (GP40) and 100cm² (GP500) that hold a maximum of 40ml and 500ml of media respectively, and supported the expansion of all suspension cells tested while reducing the required number of technician interventions approximately 4-fold with a corresponding decrease in the time required as well as the costs associated with cell production. To determine the minimum volume of media needed to achieve maximal cell expansion in this system without requiring culture re-feeding, we evaluated increasing media volumes using small-scale 5 cm² GP prototypes each capable of holding a maximum media volume of 100ml, designed specifically to identify optimal seeding density:media volume ratios. Each prototype received an initial seeding density of 1x10⁵ suspension cells (in this case EBV-transformed B lymphoblastoid cell lines – EBV-LCL) per cm² in media volumes ranging from 0.25 to 20mls per cm². Cells were counted every 3 days and after 2 weeks in culture we achieved maximal cell output (12.3x10⁶ EBV-LCL/cm²), which was attained using 10ml media/cm². To determine if increasing the GP surface area would increase cell production in a linear fashion, we tested a novel device with a footprint of 600cm² and a maximum volume capacity of 10ml media/cm². The device was seeded according to the optimal culture conditions identified during pilot testing (seeding density of 1x10⁵ cells:10ml per cm²) and cell counting was performed every 3 days to assess expansion. In addition we measured glucose in the media to identify whether there was a correlation between nutrient consumption and cell expansion. After 14 days of culture without interim feeding or re-seeding we achieved 6.2±.05x10⁹ EBV-LCLs (103 fold expansion), in line with that predicted by our small scale experiments. Further we found an inverse correlation between the level of glucose in the media and cell numbers. Thus, glucose measurement can be used as a surrogate for assessing cell growth and expansion without necessitating culture resuspension. In summary, we have identified optimal culture conditions for achieving maximal cell output using GP technology, which is applicable for both small and large scale clinical grade cell production.

592. Manufacturing Complex Recombinant Biopharmaceuticals Using a Lentivector-Based Production System

H. Trent Spencer,¹ Gabriela Denning,² Richard E. Gautney,² Kyle Harris,² Andre J. Roy,³ Lajos Barayni,³ Boro Dropulic,³ Christopher B. Doering.¹

¹Aflac Cancer Center and Blood Disorders Service, Department of Pediatrics, Emory University School of Medicine, Atlanta, GA; ²Expression Therapeutics, LLC, Tucker, GA; ³Lentigen Corporation, Gaithersburg, MD.

The commercial development of complex recombinant protein-based biologics often is limited by productivity of the protein of interest from heterologous production cell lines. Standard production cell line development includes a genetic modification step typically performed using plasmid transfection. However, stable integration of plasmid DNA into chromosomes is an inefficient and random process that results in single-site integration frequently within heterochromatic regions. These factors hinder commercialization and drive high pricing strategies for protein-based biologics. Recombinant fVIII is an established biopharmaceutical agent used in the treatment

of patients with hemophilia A. However due to manufacturing complexities inherent to the fVIII protein itself, product costs are higher than any other marketed biologic and treatment availability is limited. Previously, we utilized bioengineering of the fVIII transgene itself to improve fVIII biosynthesis on a cellular productivity level (Doering *et al. Molecular Therapy*, 2009, 17:7) and demonstrated the utility of lentivector-based expression to further improve expression (Spencer *et al. Molecular Therapy*, ePub Nov. 16, 2010). In order to 1) characterize the lentivector expression platform, 2) directly compare its' efficiency to plasmid-based systems currently used in commercial manufacturing, and 3) develop a master cell line for the manufacturing of this novel fVIII biopharmaceutical, baby hamster kidney-derived (BHK-M) cells were either transfected or transduced with fVIII encoding plasmid or lentivector, respectively, and clones stably expressing fVIII were identified and characterized. A total of 24 high expressing clones were selected from each group for analysis of fVIII expression, transgene copy number, and fVIII transcript expression. Lentiviral-mediated fVIII expression was significantly greater than that of plasmid-mediated fVIII expression ($P < 0.001$). The median lentiviral-mediated fVIII expression was 21 units/10⁶ cells/24 hr as compared to only 6.6 for plasmid-mediated fVIII expression. Analysis of fVIII mRNA levels and proviral copy number for indicated a strong correlation between fVIII and mRNA expression ($P < 0.001$), but not between fVIII expression and copy number ($P = 0.53$). Mean transcript levels were greater in lentiviral-derived fVIII expression (5650 transcripts/cell) as compared to plasmid-derived fVIII expression (2560 transcripts/cell), respectively. Conversely, no significant difference was observed between the levels of integrated copy numbers (1.8 versus 2.1 copies/diploid genome), respectively, suggesting that differences in fVIII expression levels likely were due to positional effects. Together these data validate the utility of the lentiviral-mediated expression platform for the manufacturing of recombinant biologics and demonstrate that the mechanism involves integration of lentivectors at highly transcriptionally active sites.

593. SFM rHSV-Based Production of rAAV Vectors in Suspension BHK Cells

David R. Knop,¹ Darby L. Thomas,¹ Charlotte Butts.¹

¹Process Development, Applied Genetic Technologies Corporation, Alachua, FL.

The excellent safety profile, long-term expression, and recent clinical data generated by human application of adeno-associated virus (AAV) vectors have made them the vehicle of choice for gene delivery studies. Adenovirus, baculovirus, and herpes virus-based helper systems for recombinant AAV (rAAV) production have increasingly supplanted transfection-based rAAV manufacture. These systems often rely on animal-derived products (ADP), which constitute an undesirable risk of process variability as well as contamination with pathogens capable of afflicting broad host ranges. We have previously reported a serum-dependent, recombinant herpes simplex virus type 1 (rHSV) co-infection of suspension-adapted Baby Hamster Kidney (sBHK) cells for the production of multiple rAAV serotypes in disposable bioreactors (Thomas *et al.*, 2009, *Hum Gene Ther*, 20:861-870), routinely achieving in excess of 5×10^4 DNase-resistant particles (DRP)/cell. Here we report the manufacture of rAAV using a rHSV co-infection of sBHK cells in the context of a serum-free medium (SFM) production platform. Previously, we employed fetal bovine serum (FBS) and trypsin for rHSV manufacturing, and FBS for rAAV vector manufacturing. In this study, we adapted the Vero-based complementing cell line (V27) used for rHSV helper vector production to SFM and employed a recombinant, ADP-free dissociation agent for cell passaging. rHSV vectors propagated on the SFM V27 cell line achieved the same specific yield (pfu/cell) as their serum-dependent precursors both before and after cryopreservation in various storage media. The

sBHK-based rAAV production platform was also adapted to SFM and tested for rAAV productivity before and after cryopreservation in different storage media. The specific yield of rAAV (DRP/cell) was unaltered relative to the serum-dependent line both pre- and post-banking. The rAAV production platform reported here dispenses with FBS and trypsin, making rHSV-based rAAV manufacturing more attractive from a regulatory perspective by minimizing potential patient exposure to adventitious mammalian pathogens.

594. Fully-Automated Cell Selection, Cultivation and Genetic Modification in a Closed Environment for the Flexible Manufacturing of Cellular Products

Ian C. D. Johnston,¹ Martin Biehl,¹ Melanie Fahrendorff,¹ Volker Huppert,¹ Stefan Miltenyi.¹

¹Miltenyi Biotec GmbH, Bergisch Gladbach, Germany.

Manufacturing of cellular products for cellular therapies and *ex vivo* genetic manipulation of these cells are carried out manually or at best by using semi-automated processes. If cellular therapies and gene therapies are to become routine clinical procedures, a standardized production of cellular therapeutic agents and their genetic modification is required. A functionally closed and highly automated manufacturing procedure would lead to large improvements in product performance and both product and operator safety. A new cell processing device has been developed to automate and standardize the manufacturing process of cellular therapeutic agents. After sterile docking of the patient sample to the tubing set all cell handling procedures are performed in a fully automated and controlled fashion until output of the patient-ready product. The automated procedures include density gradient separation directly from bone marrow or apheresis products, temperature-controlled centrifugation, magnetic cell separation (MACS) and cell culture steps. The central component of a novel functionally closed tubing system is a new type of centrifugation chamber which enables in-process liquid exchange and cell fractionation while also allowing cell cultivation in a controlled atmosphere and visual inspection of the cells via integrated microscope camera. Chamber inlet and outlet ports allow controlled adding and removal of fluids during the centrifugation process. To control and automate all cell handling procedures, a central controller has been developed which also documents all process parameters. As an example of a fully integrated process, viral antigen (Ag)-specific T cells were isolated based on their secretion of IFN- γ using the Cytokine Capture System (CCS). Ag-specific stimulation of the leukapheresis sample, labeling with the CCS cytokine capture reagents, washing steps, cytokine capture on the surface of the target cells, magnetic enrichment and expansion of the isolated cells are performed fully automated in a closed system. The Ag-specific T cells were magnetically enriched to similar purities compared to the semi-automated process, but cell loss during labeling and washing steps was markedly reduced using the fully automated procedure. Fully automated magnetic cell selection processes have been demonstrated for adult stem/progenitor cells, Ag-specific T cells and T cell subsets with a performance (purity, yield) comparable to semi-automated reference systems. Work is currently in progress to integrate genetic modification of target cells (e.g. stem/progenitor cells, T cells) with retro- and lentiviral vectors into the manufacturing process using novel reagents. The fully-enclosed nature of the process also provides handling advantages when working with BSL-2 vectors and will reduce clean room requirements. Conclusions: This integrated cell processing device meets all current technical requirements for manufacturing cellular therapeutic agents by the complete automation of process steps in a functionally closed environment. These safe, robust and standardized cell manufacturing processes will enable innovative cellular and gene therapies for routine use.

595. Measurement of Viral Titer by Fluorescence Nanoparticle Tracking Analysis

Andrew Malloy,¹ Duncan A. Griffiths,² Patrick Hole,¹ Bob Carr.¹
¹NanoSight Ltd., Amesbury, Wiltshire, United Kingdom;
²NanoSight USA, Costa Mesa, CA.

Measurement of viral titer and sample aggregation is a ubiquitous requirement in viral vector development. Nanoparticle Tracking Analysis (NTA) is a new methodology which provides total viral titer in minutes and real time measurement of sample aggregation. The ability to measure these parameters at key points throughout the downstream purification process allows manufacturers to monitor and optimize the sample purification. The technique images viruses individually in liquid suspension and then calculates size from their Brownian motion on a virus-by-virus basis. By individually counting and sizing the viruses, a high resolution number vs size distribution is generated which relates the number of virus monomer to aggregates. Total virus count or concentration is simultaneously derived from this measurement. Fluorescence based measurements allow speciation of appropriately labeled sub-populations within the sample. Fluorescent labeling of the virus capsids, envelope, or DNA allows distinction of virus from cell debris making the technique suitable for working in crude harvest materials. Operating under light scatter the technique is inherently non-specific and hence suited to working in purified samples. As all particles, virus or otherwise, are measured, this can be combined with the fluorescence measurements to provide a measure of contaminant or empty capsid concentrations. The technique is designed to work alongside traditional technologies such as infectivity assays, as these assays provide valuable, yet limited information. Infectivity assays have no ability to pick up aggregation within a sample and do not give a measure of total viruses within a sample. When this data set is merged with the NTA data, the user can monitor infective vs non-infective viruses vs sample aggregation to better understand the quality of a viral preparation.

596. Where Human Gene Transfer Is Illegal: Local Regulation of rDNA Clinical Research

Jan P. Vleck,¹ Gary M. Johnson,² Ethan Mascoop.³
¹IBC Services, Western Institutional Review Board, Olympia, WA;
²MetroWest Medical Center, Framingham, MA; ³Framingham Board of Health, Framingham, MA.

“The use of humans as experimental subjects in recombinant DNA research, as defined and regulated by the NIH Guidelines, shall not be permitted in the Town of Framingham.” [Board of Health, Rules and Regulations Relative to the Use of Recombinant DNA Technology within the Town of Framingham]¹. A local regulation outlawing the use of human subjects in recombinant DNA (rDNA) research was discovered during preparation for a commercially-sponsored, multicenter, Phase II human gene transfer trial at a hospital in Framingham, Massachusetts. Penalties for violation including fines and closure of the “laboratory”. The hospital succeeded in obtaining a variance allowing the research.

Selected Requirements of the Framingham BOH Regulation

conform to NIH Guidelines	intestinal flora surveillance
BOH-approved procedure manual	investigate and report all worker illness
emergency response plan	ban on P3, P4 research
at least 2 BOH-appointed IBC members	ban on use of human subjects
IBC minutes to BOH	institutional registration with BOH
local screening for purity and antibiotic resistance	fine \$200/day and lab closure

Local Context. A controversial 1976 Harvard University plan for a P3 research laboratory in downtown Cambridge prompted various local actions to regulate use of rDNA. In Framingham, the Town Board of Health is charged with “registering recombinant DNA technologies.”² MetroWest Medical Center (MWMC) is an independent regional health care system serving the Framingham area. Opening the trial. On September 14, 2010 MWMC registered an

IBC with NIH OBA in preparation for opening its first gene transfer trial. IBC review was scheduled for October 19. On October 7, a local ban on human gene transfer, probably from the early 1980s, was discovered. MWMC considered several options. Abandon the trial. This was not acceptable. Move the trial. Logistical and public relations considerations made it untenable to relocate to a MWMC hospital in neighboring Natick. Modify the regulatory status. This could both address public health concerns, and increase the feasibility of future HGT research in Framingham. This option was chosen. On October 8, the IBC roster was re-registered to add two Town residents unaffiliated with MWMC (one the Director of Public Health). MWMC submitted background safety information to the BOH and requested a permanent variance allowing FDA regulated, industry sponsored rDNA clinical trials. On October 28, the BOH approved a single-study variance as a test of procedural competence and safety. Legal notice of the BOH decision and amendments to the regulation was printed in the local paper. The BOH filed its actions with the Massachusetts Department of Environmental Protection. On November 10, the IBC approved the research. The local newspaper ran two stories.^{3,4} The first screening visit occurred January 11, 2011. Discussion: A local regulation outlawing human gene transfer research caused a 3-week delay in IBC approval for this regional community hospital site in a multi-center trial. The strategy of seeking a regulatory variance, going public in the local newspaper, and expanding public participation in the IBC was successful.

1. <http://www.framinghamma.gov/DocumentView.aspx?DID=2812>, accessed 01-11-2011 [Home/Government/Departments/Board of Health/Rules and Regulations/Recombinant DNA Technologies Regulation]
2. <http://www.framinghamma.gov/index.aspx?NID=852>, accessed 01-11-2011 [Home/Government/Departments/Board of Selectmen/Selectmen Appointed Committees/Board of Health]
3. Morton, M. MetroWest Medical seeks update to Framingham’s DNA regulation. The MetroWest Daily News. <http://www.metrowestdailynews.com/lifestyle/health/x370073169/MetroWest-Medical-seeks-update-to-Framinghams-DNA-regulation>, posted 10-29-2010, accessed 01-11-2011
4. Morton, M. MetroWest Medical Center approved to for [sic] HPV treatment trial. The MetroWest Daily News. <http://www.metrowestdailynews.com/lifestyle/health/x600431471/MetroWest-Medical-Center-approved-to-for-HPV-treatment-trial>, posted 11-14-2010, accessed 01-11-2011

597. Challenges in the Production of Large and Complex Plasmid Vectors for Gene Therapy

Ying Cai,¹ Stephen Rodriguez,¹ Luke Clifford,¹ Henry L. Hebel.¹
¹VGXI, Inc, The Woodlands, TX.

Regulatable gene therapy appears as a promising approach by adjusting or switching on/off gene expression on demand. However, along with advantages of safety and flexibility, the size and complexity of the vector are increased to accommodate various control elements. A number of obstacles arise during production of such plasmids at pre-clinical or clinical grade, such as: low yield, instability, shear-sensitive, and abundance of impurities. To address these challenges, VGXI devised process development programs for each stage of plasmid production. Extensive screening and bioreactor simulation ensured the selection of a high quality and high yield clone for seed banks. Large plasmids with aberrant sequences typically have high recombination ratios, and the quality of the desired plasmid form is associated with growth temperature. We have found the normal growth temperature of 37°C led to an unacceptable high level of recombinants. Reducing grow temperature improved product quality, but resulted in several fold reduction of initially low copy number plasmids. To accommodate both quality and yield, a novel fed-batch strategy was developed, which not only minimized undesirable forms

but also increased yield titer up to 4-fold. Downstream processing also faced unusual barriers because large plasmids share similar physical/chemical characteristics contaminating genomic DNA. Alkaline lysis is of particular concern as large plasmids are inefficient at renaturing. Special attention to process shear is required to maintain structural integrity. We have optimized downstream process conditions at every step. For a plasmid of size greater than 12 kb, the product demonstrated high purity suitable for pre-clinical or clinical applications.

Clinical Gene & Cell Therapy Oral Abstract Session

598. A Gene Therapy Approach to HIV: Adoptive Transfer of Zinc Finger Nuclease (ZFN) Modified Autologous CD4 T-Cells to Aviremic HIV-Infected Subjects with Suboptimal CD4 Counts (200-500 Cells/mm³)

Shelley Wang,¹ Jay Lalezari,² Ronald Mitsuyasu,³ Steven Deeks,⁴ Winson Tang,¹ Gary Lee,¹ Michael Holmes,¹ Phillip Gregory,¹ Marty Giedlin,¹ Dale Ando.¹

¹Sangamo Biosciences, Richmond, CA; ²Quest Clin Research, San Francisco, CA; ³UCLA, Los Angeles, CA; ⁴UCSF, San Francisco, CA.

Background: A significant number of HIV+ patients on HAART are aviremic but continue to have CD4+ T-cells <500 cells/mm³. Previous attempts to use adoptive transfer to protect CD4+ T-cells from HIV infection have shown limited cell persistence. ZFN mediated disruption of CCR5 in CD4+ T-cells and selective expansion has been shown to protect against R5 HIV infection in both *in vitro* and *in vivo* T-cell and stem cell models. This study assesses the following effects of a single infusion of autologous CCR5-disrupted CD4+ T-cells administered intravenously to HAART-treated aviremic HIV subjects: 1) safety and tolerability, 2) cell persistence, 3) increases in CD4+ cell count, and 4) homing to gut mucosa. **Methods:** Nine aviremic HIV infected subjects with CD4+ counts between 200 and 500 cells/mm³ were enrolled, three each at dose levels of 1X10¹⁰, 2X10¹⁰ and 3X10¹⁰ total cells. Autologous CCR5 disrupted CD4+ T-cells were successfully expanded *ex vivo* with a mean CCR5 disruption efficiency of 26% (range 14-36%). After infusion, subjects were followed weekly for one month and then monthly for 11 months. **Results:** The median follow-up to date for cohort 1 is 9 months (range 7-11). CCR5-disrupted CD4+ T-cell infusions were safe and well tolerated with only mild and reversible infusion related adverse effects such as fever and chills. CD4 T-cell counts increased at all time points post infusion in all subjects. The average CD4+ T-cell counts at Day 28 increased by 155 cells/mm³ (range 86-211). The number of CCR5-disrupted T-cells in the peripheral blood as measured by PCR was 3.9-, 0.3- and 4.6-fold of the predicted number (2.5% total CD4 in 4.7L of blood) at Day 14 and persisted for the duration of follow-up (7 to 11 months). The percentage of CCR5 disrupted CD4 cells detected in the peripheral blood was as high as 19% in one subject at Day 28. CCR5 disrupted cells were detected in the rectal mucosa of all cohort 1 subjects at Day 14 and at 3 months. **Conclusions:** CCR5 disrupted CD4+ T-cells can be consistently manufactured from patients with suboptimal CD4+ counts to generate amounts greater than the intended 10-30 billion cell dose. Reinfusion to HIV-infected subjects is safe and well tolerated with disrupted cells being detected at frequencies up to 4.6-fold higher than the predicted input 14 days after infusion. This level of gene marking is approximately 1-log greater than has been observed previously in adoptive transfer studies with co-stimulated CD4+ T cells. Improvements in CD4+ T-cell counts were seen in all 3 subjects as was homing of these modified cells to the gut mucosa, suggesting that the modified CD4+ T-cells may distribute normally. These preliminary data suggest that

the CCR5 disrupted CD4 T cells persist at significant levels post infusion and can bolster CD4 cell counts even in HIV patients with undetectable viral load.

599. Clinical Trial Results: Intralesional Injection of a Tumor Selective Oncolytic Vaccinia Virus

Herbert J. Zeh,¹ Mark O'Malley,¹ Heather Jones,¹ David H. Kirn,² Moon Anne,² Hwang H. Tae,³ David L. Bartlett.¹

¹Surgery, University of Pittsburgh, Pittsburgh, PA; ²Jennerex Biotherapeutics, Inc., San Francisco, CA; ³Dong-A University, Busan, Korea.

Introduction: The WR strain of vaccinia virus (VV) has numerous potential advantages as an oncolytic virus. We have created a tumor selective mutant of VV (vvDD) by deleting the thymidine kinase (TK) gene and the vaccinia growth factor (VGF) gene. These gene products are non-essential in tumor cells with E2F and/or EGFR pathway activation mutations (including ras), but essential for replication in normal, non-dividing cells. After extensive pre-clinical work, we embarked on a phase I trial of vvDD as an intralesional injection in patients with accessible tumors. **Methods:** Patients with metastatic breast cancer (n=4), colorectal cancer (n=10), and pancreatic cancer (n=2) were treated with a single percutaneous injection of vvDD. A standard phase I dose escalation was performed with a starting dose of 3X10⁷ plaque forming units (pfu), and a maximum feasible dose of 3X10⁹ pfu. Up to 3 lesions were injected. Patients were observed in the hospital for 24 hours, then followed closely with serial samples for viral shedding analysis and analysis of response. Cutaneous tumors allowed the direct observation of the response and biopsies for viral recovery, while CT scans were used for internal lesions. Patients were stratified for prior vaccinia exposure, but only one patient had not been previously vaccinated. **Results:** There were no dose limiting toxicities. Grade 3 toxicities possibly related to the treatment, included pain after injection. This was predominately abdominal pain after deep injection of hepatic metastases. Grade 1 and 2 adverse events included fever, chills, swelling and erythema at the injection site, diffuse rash (not systemic vaccinia), and thrombocytopenia. We did not see evidence of viral shedding by vaccinia titers. 4 patients underwent biopsies of their tumors on day 8, and 2 patients had recoverable virus. These 2 patients also had evidence of viral spread from the injected lesions to other metastatic deposits. 2 patients had complete resolution of their injected lesions, and 1 patient had evidence of a distant lesion responding. The virus did not spread to normal skin. **Conclusions:** We have demonstrated the safety of vvDD as a single injection into tumors, with evidence of replication, tumor response, and recoverable virus in distant tumors. The vaccinia replication was specific for tumor, with complete sparing of the normal skin. Future plans include systemic delivery of this tumor selective virus.

600. Safety and Efficacy of Re-Administration of AAV2.hRPE65v2 in Subjects with Leber Congenital Blindness Due to RPE65 Mutations

Jean Bennett,^{1,2} Albert M. Maguire,^{1,2} Federico Mingozzi,² Eric A. Pierce,^{1,2} Daniel C. Chung,^{1,2} Jeannette Bennicelli,¹ Junwei Sun,² J. Fraser Wright,^{1,2} Kathleen Marshall,² Jennifer M. Wellman,² Katherine A. High.^{1,2}

¹Ophthalmology, University of Pennsylvania, Philadelphia, PA;

²Center for Cellular and Molecular Therapeutics, The Children's Hospital of Philadelphia, Philadelphia, PA.

Gene therapy has the potential to reverse disease or prevent further deterioration of vision in patients with incurable inherited retinal degeneration. We and others previously demonstrated that adeno-associated virus (AAV)-mediated delivery of RPE65 via subretinal injection results in improved vision/retinal function in animal models of and in humans with Leber Congenital Amaurosis due to RPE65

mutations (LCA2) after one subretinal injection. We carried out preclinical studies to determine whether treatment of the second eye in the same manner would be safe and efficacious, given the potential for a complicating immune response after the first injection. Here, we evaluated the safety and efficacy of re-administration of rAAV2-hRPE65v2 to the contralateral eye in subjects in our clinical trial at The Children's Hospital of Philadelphia. Readministration was carried out to date in two adults with LCA2, ages 26 and 47yo, 1.7- 2 years after they had received a single unilateral subretinal injection of AAV2-hRPE65v2. AAV re-administration (1.5E11 vg) was well tolerated and there has been no inflammation and no evidence of cytotoxic immune response in either individual to date (with the longest period of follow-up currently 2 months post injection). Gains in retinal/visual function in the initially injected eye have been maintained, and improvements in retinal/visual function in the eye receiving the second injection are evident. While longer periods of follow-up and evaluations in these and additional subjects (in process) will be required to determine with certainty that re-administration is safe in this setting, the current data indicates that the results of preclinical animal studies were predictive that subretinal re-administration of AAV2 in humans is both safe and efficacious.

601. CUPID – A Phase 2 Trial of Intracoronary Gene Therapy of Sarcoplasmic Reticulum CA2+ ATPase (SERCA2a) in Patients with Advanced Heart Failure

Krisztina M. Zsebo,¹ Mariell Jessup,² Barry Greenberg,³ Donna Mancini,⁴ Daniel Pauly,⁶ Roger Hajjar,⁵ On Behalf of the CUPID Investigators.¹

¹Celladon Corporation, La Jolla, CA; ²Hospital of the University of Pennsylvania, Philadelphia, PA; ³University of California, San Diego, CA; ⁴NewYork-Presbyterian Hospital/ Columbia University Medical, New York, NY; ⁵Mount Sinai School of Medicine, New York, NY; ⁶University of Florida, Gainesville, FL.

Background— Heart failure is a common clinical syndrome that results in significant morbidity and mortality. One of the consistent pathophysiologic abnormalities associated with heart failure is a decreased level of SERCA2a activity. **Methods and Results—** Thirty-nine patients with advanced heart failure, as determined by NYHA class III/IV, VO2 max \leq 20 mL/kg/min and left ventricular ejection fraction \leq 35% despite optimal medical treatment, were randomized to receive intracoronary AAV1-mediated SERCA2a gene delivery (MYDICAR®) versus placebo. Patient's symptoms (NYHA class, Minnesota Living With Heart Failure Questionnaire [MLWHFQ]), functional status (6-Minute-Walk test and VO2 max), NT-proBNP levels and echocardiographic measures were evaluated over 12 months plus a 2 year telephonic follow-up. In the MYDICAR high-dose group at 6 and 12 months, patients versus placebo demonstrated improvement or stabilization in NYHA class, MLWHFQ, 6-Minute-Walk test, VO2 max, NT-proBNP levels and left ventricular end-systolic volumes. Significant increases in time to clinical events (e.g. hospitalizations, deaths, LVADs, transplants) and decreased frequency of cardiovascular events per patient were observed on high dose MYDICAR. There was an 88% reduction in rate of recurrent hospitalizations adjusted for competing risk of terminal events HR(CI)=0.12 (0.03,0.49), p=0.003. No increases in adverse events, disease-related events, laboratory abnormalities or arrhythmias were observed in MYDICAR-treated patients compared to placebo. **Conclusions—** In this phase 2 study, genetically targeted SERCA2a enzyme replacement was found to be safe and associated with benefit in clinical outcomes, symptoms, functional status, NT-proBNP and cardiac structure.

602. Dose-Dependent Activation of Capsid-Specific T Cells after AAV Serotype 8 Vector Administration in a Clinical Study for Hemophilia B

E. Basner-Tschakarjan,¹ F. Mingozzi,¹ Y. Chen,¹ A. C. Nathwani,² E. G. D. Tuddenham,³ C. Rosales,⁴ J. McIntosh,⁴ A. Riddell,³ P. Rustagi,⁵ B. Glader,⁵ M. A. Kay,⁵ J. Allay,⁶ J. Coleman,⁷ S. Sleep,⁷ J. Gray,⁶ U. Reiss,⁶ A. W. Nienhuis,⁶ A. M. Davidoff,⁶ K. A. High.¹
¹Children's Hospital of Philadelphia, Philadelphia; ²UCL Cancer Institute and NHSBT, London, United Kingdom; ³KD Haemophilia Centre and Thrombosis Unit, Royal Free NHS Trust, London, United Kingdom; ⁴UCL Cancer Institute, London, United Kingdom; ⁵Stanford University School of Medicine, Stanford; ⁶St. Jude Children's Research Hospital, Memphis; ⁷Children's GMP, LLC, Memphis.

In a clinical study of gene transfer for hemophilia B an adeno-associated virus vector serotype 8 (AAV8) carrying a self-complementary liver-specific expression cassette for the factor IX (FIX) transgene was administered intravenously in 4 affected subjects. Vector infusion was well tolerated in all subjects. One of two subjects from the low vector dose cohort (2x10¹⁰ vg/kg) showed detectable FIX levels in plasma, while the other subject did not due to pre-existing humoral immunity to the AAV8 vector. IFN- γ ELISPOT in these two subjects showed no activation of capsid T cell responses in peripheral blood. This result correlated with the flow cytometry analysis of phenotype markers, CD107a and intracellular IFN- γ and TNF- α . Similar to the low dose cohort, one of two subjects from the mid-dose cohort (6x10⁶) had detectable levels of FIX transgene expression in plasma after gene transfer, while the other subject had pre-existing neutralizing antibodies to the AAV8 vector. In these subjects, IFN- γ ELISPOT on peripheral blood mononuclear cells (PBMC) showed a robust activation of capsid specific T cells (spot forming units/ 10⁶ PBMC up to ~1,700). Polyfunctional analysis of capsid specific T cells revealed the expansion of a population of capsid-specific CD4+ T cells secreting mainly IFN- γ in PBMC as early as week 1 post-vector infusion. This was followed by the expansion of a population of capsid-specific CD8+ T cells starting around week 4 post-vector infusion; at this time point the population of capsid-specific CD8+IFN- γ + T cells reached a frequency of ~1% of total CD8+ T cells. (These results stand in contrast to published studies that show an absence of activation of capsid-specific T cells in mice and non-human primates after AAV8 injection [Nature Med 12:967-71]). Of note, no humoral or cellular immune response to the FIX transgene was detected in any of the four trial subjects. Follow up of these subjects, as well as further dose escalation, is ongoing. We conclude that infusion of AAV8 vectors can trigger activation of T cells in a dose-dependent manner. This extends findings previously demonstrated for AAV2 (Nat Med 12:342-7, 2007). However, at the doses infused thus far, activated capsid-specific T cells have not affected FIX transgene expression levels or resulted in liver enzyme elevation. Additional studies will determine the safety of further dose escalation, and whether there are serotype-specific differences in capsid processing and presentation that affect biological consequences of T cell activation.

603. ProSavin® a Gene Therapy Approach for the Treatment of Parkinson Disease: Phase I Clinical Trial Update

Kyriacos Mitrophanous,¹ Bechir Jarraya,^{2,3} Scott Ralph,¹ Helene Lepetit,² James Miskin,¹ Jean-Marc Gurruchaga,² Gilles Fenelon,² Sabrina Boulet,¹ Caroline Jan,² Gilles Bonvento,² Pierre Brugiere,² Susan Kingsman,¹ Stuart Naylor,¹ Philippe Hantraye,^{2,3} Philippe Remy,² Stephane Palfi.^{2,3}

¹Oxford BioMedica (UK) Ltd, Oxford, United Kingdom; ²Henri Mondor Hospital, Paris, France; ³CEA-CNRS MirCen, Fontenay aux Roses, France.

Parkinson's disease (PD) is a debilitating neurodegenerative condition that results from the destruction of dopamine-producing (dopaminergic) neurons in the substantia nigra. The loss of dopamine, a key neurotransmitter involved in coordinating motor control, results in movement abnormalities such as bradykinesia (slowness of movement), rigidity and postural instability. L-Dopa and dopamine agonists provide the primary standard of care for PD and are highly efficacious in the early stages of disease. However their long term use is associated with severe motor side effects that seriously impact on the quality of life. These side effects are believed to be caused by the fluctuating nature of dopaminergic stimulation that arises from oral drug administration. We have developed a lentiviral vector (ProSavin®) derived from the equine infectious anaemia virus expressing the three key dopamine biosynthetic enzymes (tyrosine hydroxylase, aromatic L-amino acid decarboxylase and GTP cyclohydrolase-1), with the aim of providing a continuous source of dopamine in the striatum. ProSavin was previously demonstrated to mediate dopamine production and behavioural correction in rat and non-human primate models of PD. A phase I, open label clinical study has been initiated in which nine PD patients have received ProSavin in three cohorts in the dose escalation part of the trial. All the patients have completed at least 3 months follow up and the first cohort are now approaching their third year post treatment. ProSavin has been demonstrated to be safe and well tolerated at both doses. There were no "OFF" state dyskinesias, no immune responses to ProSavin and no serious adverse events. Furthermore, encouraging signs of efficacy have been observed on a number of endpoints including UDRS Part III, patient diary and quality of life measures. An update on the trial and future plans for ProSavin® will be presented.

604. Gene Therapy with Lentiviral Vector Transduced CD34⁺ Cells for the Treatment of Wiskott-Aldrich Syndrome

Samantha Scaramuzza,¹ Francesca Ferrua,² Maria Carmina Castiello,¹ Luca Biasco,¹ Marita Bosticardo,¹ Costanza Evangelio,² Maria Pia Cicalese,² Miriam Casiraghi,² Anna Ripamonti,¹ Stefania Giannelli,¹ Monica Salomoni,³ Andrea Finocchi,⁴ Alessandra Biffi,^{1,2} Fabio Ciceri,⁵ Anna Villa,^{1,6} Maria Grazia Roncarolo,^{1,7} Luigi Naldini,^{1,7} Alessandro Aiuti.^{1,4}

¹San Raffaele Telethon Institute for Gene Therapy (HSR-TIGET), Milan, Italy; ²Pediatric Immunohematology and BMT Unit, Scientific Institute HS Raffaele, Milan, Italy; ³MolMed SpA, Milan, Italy; ⁴Univ. of Rome "Tor Vergata", Rome, Italy; ⁵Div. of Hematology, Scientific Institute HS Raffaele, Milan, Italy; ⁶IRGB-CNR, Cagliari, Italy; ⁷Università Vita Salute, San Raffaele, Milan, Italy.

Wiskott-Aldrich Syndrome (WAS) is an X-linked immunodeficiency characterized by thrombocytopenia, autoimmunity and lymphomas. Gene therapy with *ex vivo* transduced autologous hematopoietic stem cells (HSC) could represent a valid therapeutic alternative to allogeneic HSC transplant. We previously demonstrated that a lentiviral vector (LVV) encoding for human WAS under the control of an homologous 1.6 kb promoter efficiently corrected human and

mouse cells. We set up and validated a transduction protocol for CD34⁺ cells derived from bone marrow (BM) or mobilized peripheral blood (MPB) using a clinical grade purified LVV. We obtained robust transduction of patients' progenitor cells, expressing WASp after differentiation to megakaryocytes, without evidence of toxicity. Studies in immunodeficient mice showed that human transduced CD34⁺ cells were able to normally engraft and differentiate towards lymphoid and myeloid cells. Analyses of vector integrations showed polyclonal integration patterns *in vitro* and in engrafted cells *in vivo*; vector mobilization to host cells and germline transmission of the LVV were excluded by several molecular assays. On the basis of these results and preclinical studies in the WAS-KO mouse, a phase I/II gene therapy protocol was opened in April 2010. Patients will receive preconditioning with anti-CD20 mAb and reduced intensity busulfan and fludarabine; ATG will be included in case of autoimmune manifestations. The first enrolled patient was a 5.7 year old boy lacking an HLA-compatible donor. He was treated with autologous BM and MPB derived transduced CD34⁺ cells, showing a vector copy number (VCN) of 1.4 and 1.9 respectively, with high gene transfer efficiency (88-92% in clonogenic progenitors). The patient did not experience toxicity, recovered well from transient neutropenia and is currently well, independent from platelet transfusions, 6 months after gene therapy. Engraftment analyses revealed the presence of transduced cells at substantial levels in peripheral blood granulocytes and monocytes (VCN: 0.3-0.4) and at higher levels in T, B and NK lymphocytes (VCN range 0.5-1.0) as expected from the selective advantage. Engraftment was present in multiple lineages of the bone marrow (VCN range 0.2-0.9), including CD34⁺ cells and clonogenic progenitors (25% transd.). WASp expression was detected in peripheral blood monocytes, platelets and all lymphocyte lineages. Long-term studies will provide key information on the safety and efficacy of gene therapy for WAS patients using LVV transduced HSC in combination with reduced intensity conditioning.

605. The Infusion of Suicide Gene-Modified Donor T Cells after Hematopoietic Stem Cell Transplantation Prompts Thymic Renewal in Adult Patients by an IL-7 Dependent Mechanism

Luca Vago,^{1,2} Giacomo Oliveira,¹ Maddalena Noviello,¹ Corrado Soldati,³ Domenico Ghio,³ Immacolata Brigida,⁴ Alessandro Aiuti,⁴ Maria Tessa Lupo Stanghellini,² Jacopo Peccatori,² Attilio Bondanza,¹ Alessandro Del Maschio,³ Claudio Bordignon,^{5,6} Fabio Ciceri,² Chiara Bonini.¹

¹Experimental Hematology Unit, San Raffaele Scientific Institute, Milan, Italy; ²Hematology and BMT Unit, San Raffaele Scientific Institute, Milan, Italy; ³Department of Radiology, San Raffaele Scientific Institute, Milan, Italy; ⁴Pediatric Immunohematology and Bone Marrow Transplant Unit and San Raffaele Telethon Institute for Gene Therapy (HSR-TIGET), San Raffaele Scientific Institute, Milan, Italy; ⁵"Vita-Salute" San Raffaele University, San Raffaele Scientific Institute, Milan, Italy; ⁶Molmed SpA, Milan, Italy.

In haploidentical Hematopoietic Stem Cell Transplantation (HSCT), the infusion of donor lymphocytes genetically modified to express the Herpes Simplex Virus Thymidine kinase (HSV-Tk) suicide gene allows GvHD control, while rapidly providing an effective and polyclonal T cell repertoire against pathogens and underlying malignancies (Ciceri and Bonini *et al.*, *Lancet Oncology*, 2009). In the TK007 phase I/II clinical trial 28 adult patients (median age: 50 years) with hematologic malignancies received purified HSV-Tk-transduced cells after T cell-depleted HSCT, and 22/28 experienced a rapid and stable T cell immune reconstitution. Even though their engraftment is necessary to achieve these effects, HSV-Tk+ cells represent the minority of lymphocytes circulating in treated patients. Therefore, we hypothesized an indirect role of HSV-Tk+ cells in prompting T cell development from graft progenitors by a thymus-dependent pathway.

T cell reconstitution of treated patients demonstrated recovery of naïve HSV-Tk^{neg} T cells. The newly reconstituted CD4+ naïve T cells were almost entirely comprised by CD31+ recent thymic emigrants. Accordingly, CT scans documented an increase in thymic volume and single joint T cell Receptor Excision Circle counts rose following HSV-Tk cell add-backs. Comparison with a cohort of patients subject to T-cell replete HSCT further suggested a unique direct role of HSV-Tk+ cells in promoting thymopoiesis. Interestingly, serum levels of IL-7 markedly rose after Tk-cell add-backs, suggesting that the genetically manipulated T cells may mediate the release of this stromal cytokine, in turn supporting the generation and maturation of T cells. Notably, in the absence of HSV-Tk cell engraftment, no increase in IL-7 serum levels was observed and patients did not achieve the immune reconstitution. The newly generated HSV-Tk^{neg} T cells granted persistent immune competence against infectious agents, which was not compromised in those patients in whom the suicide gene was activated to control GvHD. These data show that the infusion of suicide gene-modified T cells induces IL-7 release, boosts the function of the adult thymus and prompts the recovery of a polyclonal, fully competent, T cell repertoire. A phase III clinical trial (TK008 study) to assess the efficacy of HSV-Tk+ cells in the context of haploidentical HSCT for leukemia started in Italy, and is currently expanding to multiple centers throughout Europe and US.

RNA Virus Vectors

606. Assessing the Impact of Lentiviral Vector Integration on Splicing of Cellular Genes at the Genome-Wide Level

Stefania Merella,¹ Jacopo Sgualdino,¹ Daniela Cesana,¹ Fabrizio Benedicenti,¹ Simone Leo,² Gianluigi Zanetti,² Luigi Naldini,¹ Eugenio Montini.¹

¹San Raffaele Telethon Institute for Gene Therapy, Milan, Italy;

²Center for Advanced Studies, Research, and Development in Sardinia, Pula, Italy.

Oncogenesis induced by insertional mutagenesis with gene therapy vectors occurs mainly by activation of proto-oncogenes found at or nearby the insertion site. This activation often occurs by an enhancer-mediated mechanism or by a process of splicing capture which generates chimeric transcripts comprising portions of vector and cellular mRNAs. Although the activation of oncogenes may be reduced by the use of self-inactivating (SIN) design and moderate cellular promoters, how to reduce genotoxic splicing capture events and aberrant transcript formation triggered by vector integration is still unclear. We developed a modified Linear Amplification-Mediated (LAM) PCR technique, named cDNA LAM PCR (cLAM-PCR), aimed at retrieving, from the whole transcriptome of LV-transduced cells aberrantly spliced mRNAs that contain lentiviral vector (LV) sequences fused with cellular transcripts in a high-throughput fashion. The sequences of cLAM-PCR products were obtained by 454 pyrosequencing and analyzed by a purposely build high-throughput computational pipeline. Our pipeline is based on a map-reduce parallelization model, running in a private computer cluster and use a dynamic analysis process composed by different steps implemented as map-reduce applications. Thus, chimeric LV-genome sequences are recognized, the nucleotide position of the fused sequence is identified (the splice site), and the remaining portion mapped on the appropriate genome assembly by BLAST. Results obtained with different LV constructs show that integrated LVs can perturb the processing of cellular transcripts by interacting with the cellular splicing machinery and fusing with its own splice sites to cellular splice sites both upstream and downstream the integration site. So far, 70 different fusion transcripts could be identified in total, 84% of which were fused to known splice sites of gene exons, 6% were fused to uncharacterized cryptic splice sites located in introns and the

remaining 10% were fused to genomic sequences not corresponding to any annotated gene. We identified several established and previously unknown splice sites within the LV backbone that participate in the aberrant splicing process with variable efficiency. Quantitative PCR on different portions of the LV backbone allows measuring the relative contribution to the aberrant splicing process of each LV splice site identified. The amount of transcription occurring in regions outside the expression cassette reaches up to the 3% of the entire transgene expression. The cLAM-PCR technique, coupled to high-throughput sequencing and the computational power of our specialized data analysis pipeline allows gaining insights into the biology of vector-mediated splicing alteration. Since this process could induce neoplastic transformation by the generation of aberrant oncogenic protein, its in-depth characterization is instrumental in the development of next-generation LV with a higher safety profile.

607. Read-Through/Splicing-Capture Mechanism Is the Major Determinant of Enhancer Genotoxicity of Vectors with Active LTRs

Daniela Cesana,¹ Marco Ranzani,¹ Cynthia Bartholomae,² Monica Volpin,¹ Stefania Merella,¹ Fabrizio Benedicenti,¹ Lucia Sergi Sergi,¹ Christof von Kalle,² Manfred Schmidt,² Luigi Naldini,¹ Eugenio Montini.¹

¹San Raffaele Telethon Institute for Gene Therapy, Milan, Italy;

²National Center for Tumor Diseases, Heidelberg, Germany.

We recently developed and validated a new in vivo genotoxicity assay based on systemic vector injection into newborn tumor-prone Cdkn2a^{-/-} mice to address the genotoxic potential of different VSV-G pseudotyped lentiviral vectors (LV). Treatment with an LV with self-inactivating (SIN) Long Terminal Repeats (LTRs) and harboring the strong Spleen Focus Forming Virus (SF) enhancer/promoter sequences in internal position driving GFP expression (SIN.LV.SF.GFP), caused a significant acceleration (p<0.006) in the time of tumor onset (N=17, 186 days median survival) with respect to mock-controls (N=80, 233 d). These data confirm the higher sensitivity to vector genotoxicity of this new in vivo platform since this vector was neutral in the previously validated Cdkn2a^{-/-} transduction/transplantation mouse model. Injection of an LV containing the same SF sequences within the LTR (LV.SF.LTR) caused a significantly earlier tumor onset even with respect to the SIN.LV.SF.GFP-treated mice (N=11, 138 d, p<0.0001). These results provide a further confirmation that the position of the enhancer/promoter sequences has a strong impact on the genotoxic potential of integrative vectors. To understand the reasons at the base of the different genotoxic potential between vectors with the enhancer in internal position or within the LTR, we deleted from the SIN.LV.SF.GFP the Open Reading Frame (ORF) downstream the SF promoter (LV.SF) and tested the effect of this modification in the new in vivo platform. Strikingly, LV.SF induced a dramatic acceleration in the time of tumor onset (N=9, 112 d; Vs Mock p<0.0001) similar to the LV.SF.LTR. This data indicate that the presence of the ORF downstream the enhancer/promoter sequences and not the position or the number of enhancers per se has a major role in increasing the safety profile of the SIN design. To get more insights into the mechanism responsible for this difference in genotoxicity, we retrieved the vector integration sites from tumors. Analysis of >5000 LV integrations showed the presence of several Common Insertion Sites in all the different vector treatment groups, such as the well known cancer genes Braf, Sfi1, Mef2c and Map3k8. Thus, all genotoxic vectors tested promoted tumor onset acceleration by insertional mutagenesis. Furthermore, the LV.SF.LTR and the LV.SF produced with high frequency chimeric LV/Braf transcripts by a read-through/splicing-capture mechanism using available splice donor signals present in the vector or in the surrounding cellular genome. On the other hand, no LV/Braf transcripts could be detected in SIN.LV.SF.GFP induced-tumor indicating that the presence of an

and Gas6, its human homologue. Gas6 enhances native infectivity for pseudotypes of multiple viral envelope proteins, including the wild-type Sindbis virus, Ross river virus, and baculovirus envelope proteins. Gas6 mediates binding of the virus to target cells by bridging virion envelope phosphatidylserine to Axl, a TAM receptor tyrosine kinase present on target cells. Phosphatidylserine is a surface marker of apoptotic cells, and Gas6 was originally known to mediate clearance of apoptotic cells by phagocytes by bridging exposed phosphatidylserine on apoptotic cells to Axl on phagocytes. Our results demonstrated that envelope viruses and vectors can enter target cells using an apoptotic mimicry pathway, which is a novel alternative molecular mechanism of viral entry that can broaden host ranges and enhance infectivity of enveloped viruses and viral vectors. Our results also provided insight into the role of envelope lipid in binding and tropism of envelope viruses and vectors.

610. An Integrated Approach To Discover New Liver Cancer Genes and Test the Genotoxicity of Vectors for Liver Gene Therapy

Marco Ranzani,¹ Alessio Cantore,¹ Daniela Cesana,¹ Cynthia Bartholomae,² Francesca Sanvito,³ Mauro Pala,⁴ Fabrizio Benedicenti,¹ Monica Volpin,¹ Pierangela Gallina,¹ Lucia Sergi Sergi,¹ Alessandro Bulfone,⁴ Claudio Doglioni,³ Christof von Kalle,² Manfred Schmidt,² Giovanni Tonon,⁵ Luigi Naldini,¹ Eugenio Montini.¹

¹San Raffaele Telethon Institute for Gene Therapy, Milan, Italy;

²National Center for Tumor Diseases, Heidelberg, Germany;

³Mouse Pathology San Raffaele Hospital, Milan, Italy; ⁴Bio)

flag Ltd, Pula, Italy; ⁵Functional Genomic of Cancer Unit, San Raffaele Scientific Institute, Milan, Italy.

Efficient liver gene transfer and long term transgene expression may allow the treatment of several hepatic and systemic diseases. However, vector integration may occasionally lead to transformation of hepatocytes, as reported for AAV vectors in mice. Therefore, sensitive preclinical models to assess the genotoxicity of vector integration in liver are needed. We devised and validated sensitive genotoxicity assays based on *Cdkn2a* or *Pten* deficient and wild type (WT) mouse strains. As a positive control of insertional mutagenesis in hepatocytes, a lentiviral vector (LV) carrying Enhanced Transthyretin enhancer/promoter (ET) in the Long Terminal Repeats (LV.ET.LTR) was generated and used to induce hepatocellular carcinoma (HCC) in mice. Systemic LV.ET.LTR injection induced HCCs in 30% of *Cdkn2a*^{-/-} mice ($p < 0.01$), 25% of *Pten* liver-null mice ($p < 0.05$) and 75% of WT mice in combination with CCl₄ treatment ($p < 0.01$). By the retrieval of vector integrations from LV-induced HCCs, we identified 4 putative liver cancer genes: the well characterized *Braf* and *Sos1* from *Ras* pathway, *Fign* whose functions are poorly understood, and the *Dkl1-Dio3* imprinted region. Forced expression of the newly identified cancer genes in the mouse liver induced HCCs, thus validating their causative role in hepatocarcinogenesis. Gene expression analysis and data-mining of human cancer “omics” databases showed that these loci are frequently upregulated and/or amplified in human HCCs and that their activation leads to specific expression signatures that can distinguish different human tumor stages. Therefore, the newly identified cancer genes play a relevant role also in human hepatocarcinogenesis and the experimental models recapitulate molecular features of human HCCs. We exploited these mouse models to test the safety of self-inactivating (SIN) LVs developed for the therapy of hemophilia B. A SINLV that express factor IX transcript under the control of ET was injected in *Cdkn2a*^{-/-} (N=39) or WT mice (N=24). The HCC incidence was monitored till 1 year after treatment. The therapeutic vector did not induce HCCs as assessed by histopathological analysis neither in tumor prone nor WT mice + CCl₄. Conversely, the mice injected with matched doses of LV.ET.LTR developed HCCs at frequency similar to previous

experiments. Analysis of integration to compare SINLVs and LV.ET.LTR integration pattern are currently ongoing. This study provides encouraging results on the biosafety profile of SINLVs-based liver gene therapy and uncovers the role in hepatocarcinogenesis of some previously known and other completely new oncogenes that altogether may be novel candidate therapeutic targets and diagnostic markers for human HCCs.

611. Lentiviral Vector Common Integration Sites in the ALD and MLD Clinical Trials and in a Preclinical Model Reflect a Benign Integration Bias and Not Oncogenic Selection

Alessandra Biffi,¹ Cynthia C. Bartolomae,² Daniela Cesana,¹ Natalie Cartier,³ Marco Ranzani,¹ Martina Cesani,¹ Fabrizio Benedicenti,¹ Tiziana Plati,¹ Merella Stefania,¹ Alessia Capotondo,¹ Jacopo Sgualdino,¹ Patrick Aubourg,³ Gianluigi Zanetti,⁴ Christof von Kalle,² Manfred Schmidt,² Luigi Naldini,¹ Eugenio Montini.¹

¹San Raffaele Telethon Institute for Gene Therapy, Milan, Italy; ²National Center for Tumor Diseases, Heidelberg, Italy; ³INSERM, University Paris-Descartes, Paris, France; ⁴Center for Advanced Studies, Research, and Development in Sardinia, Pula, Italy.

HIV-derived lentiviral vectors (LV) have shown good efficacy and safety data in preclinical models and in a recent Hematopoietic Stem Cell (HSC)-based clinical trial for X-linked adrenoleukodystrophy (ALD). However, a careful analysis of LV integration sites in ALD patients' derived cells showed that a relevant number of Common Insertion Sites (CIS) were present. This observation raises concerns because the detection of CIS is a well established hallmark of insertional mutagenesis in mice and clinical trials. Indeed, in γ retroviral-based clinical trials, different patients developed malignancies triggered by vector integrations at CIS recurrently targeting the same proto-oncogenes. Thus, it is possible that the occurrence of CIS in the ALD clinical trial is a still silent effect of genotoxicity caused by LV integrations that confer a selective advantage. To understand if CIS generated by LV integrations are the product of genotoxicity, we generated our own dataset of LV integrations from transduced human HSC after transplant in immunodeficient mice. This integration profile was compared to LV integrations found in the ALD clinical trial, in other gene therapy trials that reported insertional mutagenesis, as well as in retroviral and transposon-mediated oncogene tagging studies in mice. LV CIS in hematochimeras were the same found in ALD patients and clustered in megabase-wide chromosomal regions of high LV integration density. Conversely, cancer-triggering integrations at CIS found in tumor cells from clinical trials and oncogenes tagging studies in mice, do not form clusters, target always a single gene and are contained in narrow genomic intervals. Further statistical analysis show that genotoxic CIS, but not LV CIS, have a higher targeting frequency with respect neighboring genes. Moreover, integration site analysis was also performed on a patient enrolled in the recent clinical trial for the cure of metachromatic leukodystrophy (MLD) in Milan, Italy (6-months follow-up). The 5000 unique LV integration sites obtained from transduced in vitro cultured CD34 cells and in different tissues and cell types at 30, 90 and 120 days after transplant, provide a photograph of the early phases of engraftment and multi-lineage repopulation. A preliminary analysis of the MLD integration profile show strong similarities to our experimental model and the ALD clinical trial. CIS genes, which are largely overlapping are also clustered in the same megabase-wide chromosomal regions. These findings imply that LV CIS in our experimental model, the ALD and MLD clinical trials are produced by an integration bias towards specific genomic regions rather than by oncogenic selection.

612. Defining the Lentiviral Integrome in Human Hematopoietic Cells

Alessandra Recchia,¹ Claudia Cattoglio,² Danilo Pellin,³ Ermanno Rizzi,⁴ Giorgio Corti,⁴ Clelia Di Serio,³ Nirav Malani,⁵ Frederic Bushman,⁵ Gianluca De Bellis,⁴ Fulvio Mavilio.¹

¹Center for Regenerative Medicine, University of Modena and Reggio Emilia, Modena, Italy; ²University of California at Berkeley, Berkeley, Berkeley, CA; ³CUSSB, Vita-Salute San Raffaele University, Milano, Italy; ⁴Institute of Biomedical Technologies, CNR, Milano, Italy; ⁵University of Pennsylvania School of Medicine, Philadelphia.

Retroviral integration is a non-random process, whereby pre-integration complexes of different viruses recognize components or features of the host cell chromatin in a specific fashion. By using deep sequencing technology, we mapped >60,000 MLV and HIV integration sites in the genome of human CD34+ hematopoietic stem/progenitor cells and >16,000 sites in peripheral blood T-lymphocytes, and defined genome-wide integration maps in both cell types. MLV integrations cluster around regulatory elements (promoters, enhancers, and evolutionarily conserved non-coding regions) of genes involved in hematopoietic functions, and to chromatin regions bearing epigenetic marks of active or poised transcription. On the contrary, HIV integrations are clustered in regions marked by histone modifications associated to the body of transcribed genes (H3K36me3 and H2BK5me1), and are under-represented in regulatory regions. Although >90% of the genes targeted by HIV integration are expressed by Affymetrix analysis, expressed genes are not equally targeted. By a rigorous statistical analysis, we define a set of <400 genes that are targeted by HIV at significantly higher frequency than matched random controls after normalization for gene length, and a smaller set of genes that are targeted at significantly lower frequency. Functional clustering analysis shows that highly targeted genes are involved in chromatin remodeling and transcription, and are enriched in housekeeping functions. This analysis identifies a set of “high-risk” genes in hematopoietic cells, the function of which is more likely to be influenced by lentiviral vector integration in clinical gene therapy. Many of these genes are over-represented in collections of lentiviral vector integrations from patients treated by gene therapy, indicating that lentiviral “common integration sites” are determined by the HIV target site selection rather than clonal dominance in vivo. (Funded by grants from the European Commission, EC-HEALTH-2009-222878-PERSIST, and Telethon)

613. Foamy Virus Vectors with Strong Viral Enhancers Display Low In Vitro Immortalization Potential in Primary Murine Hematopoietic Progenitor Cells

Paritha I. Arumugam,¹ Danielle L. Lynn,¹ Johannes C. M. van der Loo,¹ Thomas R. Bauer,² Dennis D. Hickstein,² David Russell,³ Punam Malik.¹

¹Exp. Hematology/Cancer Biology, CCHMC, Cincinnati, OH; ²Exp. Transplantation/Immunology, NCI/NIH/DHHS, Bethesda, MD; ³Div. of Hematology, University of Washington Medical Center, Seattle, WA.

Insertional mutagenesis induced by strong viral promoter/enhancers from the murine stem cell virus (MSCV) or the spleen focus forming virus (SFFV) virus long terminal repeat (LTR) of γ -retrovirus vectors (RV) has now been shown to result in leukemia or myelodysplastic syndrome (MDS) in clinical trials for X-SCID, chronic granulomatous disease and Wiscott-Aldrich syndrome. Experimental systems designed to study vector genotoxicity show that a self-inactivating (SIN) design of lentivirus vectors (LV) or RV with an internal viral promoter/enhancer lowers the vector genotoxicity compared to vectors carrying intact LTRs in the provirus. However, a recent

β -globin LV trial showed strong enhancers can dysregulate genes, independent of the vector type/design. Another factor influencing vector genotoxicity is the integration preference of the vector subtype. Herein, we used an in vitro immortalization assay with primary murine hematopoietic progenitors to detect immortalized mutants (IVIM) arising from insertional transformation by SIN foamy virus vectors (FV), as compared to LV and RV. We studied the genotoxicity of a series of FV carrying SFFV and MSCV viral enhancers or cellular promoter/enhancers from the elongation factor-1 α (EF-1 α) and phosphoglycerate kinase (PGK) genes, and compared them to analogous RV and LV. RV with intact SFFV and MSCV LTRs served as positive controls; a promoter-less FV and mock transduction were negative controls. Murine lineage negative bone marrow progenitors were transduced, expanded as bulk cultures for 2 weeks, and then cloned. The replating frequency of the IVIM clones was assessed at 2 and 5 weeks. The SFFV RV had 3-fold higher transforming potential compared to MSCV RV. When normalized for vector copy, the SFFV, MSCV FV showed a 200- and 413-fold lower transforming potential, respectively, compared to the conventional SFFV RV in generating IVIM clones. The SFFV LV and MSCV LV showed a 20- and 14-fold reduction in generating IVIM clones, respectively. The PGK and EF-1 α FV showed \geq 1000-fold lower genotoxicity than SFFV RV. There were no detectable IVIM clones in the negative controls. All IVIM mutants expressed progenitor cell markers at high levels and variable levels of myeloid markers. Our results show that the risk of enhancer-mediated in vitro immortalization of primary murine bone marrow progenitor cells was significantly reduced with a FV backbone even when strong viral enhancers from the SFFV or MSCV were placed internally; immortalization was nearly completely abrogated in FV with EF-1 α and PGK. These results indicate that FV have lower transforming potential compared to analogous RV and LV vectors. In this assay, genotoxicity from FV was reduced by one and two orders of magnitude compared to analogous LV and analogous RV with intact LTRs, respectively. FV backbone appears to be a safer alternative for gene therapy applications to treat inherited hematopoietic disorders.

AAV Genome & Host Interactions

614. High-Throughput Genome-Wide siRNA Screening Unravels Cellular Factors Critical for AAV Transduction

Miguel Mano,¹ Rudy Ippodrino,¹ Jasmina Lovric,¹ Lorena Zentilin,¹ Mauro Giacca.¹

¹Molecular Medicine Laboratory, ICGEB - International Centre for Genetic Engineering and Biotechnology, Trieste, Italy.

Over the last few years, viral vectors based on AAV have gained increasing popularity due to several favourable characteristics, including the excellent safety profile, lack of inflammatory response, prolonged transgene expression, relative genetic simplicity and high efficiency of transduction of post-mitotic tissues such as muscle, heart, brain and retina. Nonetheless, it has become evident that significant improvements need to be achieved before attaining broader clinical application. Given the molecular simplicity of AAV vector particles, all the determinants of permissivity to vector transduction appear to reside among the molecular features of the host cell. For this reason, the identification of the cellular proteins that regulate vector transduction is an essential requisite to improve in vivo transduction, expand the number of permissive tissues and achieve AAV-mediated gene correction at a clinically applicable level. To systematically identify the host cell factors involved in the internalization, intracellular trafficking, processing of AAV genome and, eventually, AAV gene expression, either positively or negatively, we have performed a high-throughput screening using a genome-wide siRNA library (18175 human gene targets).

Differences in AAV transduction in HeLa cells were assessed using a recombinant ssAAV2 vector expressing the firefly Luciferase reporter gene. Analysis of the results obtained from this primary screening identified 1528 genes affecting transduction by AAV vectors by more than 4-fold (184 genes by more than 8-fold). Of these genes, 993 are inhibitors of AAV transduction, whereas 535 are required for efficient transduction by AAV vectors. The effect of these genes on AAV transduction was further confirmed in a secondary screening based on high-content microscopy of cells transduced with a recombinant AAV vector expressing DsRed. Gene ontology analysis of the inhibitor genes revealed a clear overrepresentation of genes related to DNA recombination and repair and cell cycle control, whereas in the subset of genes required for infection an overrepresentation of genes involved in endocytosis, intracellular trafficking and transcription was observed. Consistent with our previous results, among the genes that restrict transduction by AAV vectors, we found members of the MRN complex and other genes involved in cellular DNA damage response, as well as genes involved in the ubiquitin-proteasome system. In addition, a significant number of genes were identified, which have not previously been associated with AAV transduction. Work in progress aims at investigating the mechanisms of action of the identified genes and exploiting this information to develop RNAi or pharmacological strategies to improve AAV transduction *in vivo*.

615. Enhanced Transgene Expression and Site-Specific Integration of Adeno-Associated Virus Depends on Methylation Status of the Target Cell

Diptiman Chanda,¹ Jonathan A. Hensel,¹ Jerome T. Higgs,¹ Rajat Grover,¹ Niroop Kaza,¹ Selvarangan Ponnazhagan.¹

¹Department of Pathology, University of Alabama at Birmingham, Birmingham, AL.

Long-term expression of transgenes following vector-mediated delivery is often curtailed due to host defense mechanisms against viral infection. One such event in the eukaryotic cells occurs via DNA methylation and histone modification. Unmethylated CpG regions of microbial DNA are immunogenic and also form targets for DNA methyltransferase activity and recruitment of polycomb and other protein complexes resulting in repression of viral replication as well as transgene expression. Adeno-associated virus (AAV) is a non-pathogenic human parvovirus, which is being tested in many clinical gene therapy applications. Wild-type AAV (wt-AAV) has anti-oncogenic properties mainly in HPV-induced carcinogenesis. There are at least four CpG islands in the 4.6 kb wt-AAV2 genome, which are larger than 400 base-pairs. Moreover, like other gene therapy vectors, recombinant AAV (rAAV) are mostly designed using the cytomegalovirus (CMV) immediate early gene promoter, which also contains a significant number of CpG motifs. Therefore, methylation status of AAV inside the target cell could affect transgene expression. In the present study, we determined the influence of host cell methylation on transgene expression of rAAV and on integration of wt-AAV. When HeLa cells were maintained in a hypomethylating agent, 5-Aza-2' deoxycytidine (5-Aza) for 72 hours and followed by infection with either recombinant AAV-GFP or wt-AAV showed significantly higher GFP expression and wt-AAV integration respectively when compared to untreated HeLa cells. The enhanced GFP expression was found to be not due to transduction of additional AAV particles following 5-Aza treatment, rather due to the methylation status of the AAV genome. The enhanced GFP expression following 5-Aza treatment was exclusively linked to AAV viral infection and not AAV plasmid transfection, suggesting the role of genomic organization of AAV, flanked by GC-rich terminal repeat hairpin structures. Previous studies have demonstrated that the leading 510 nucleotides at the 5' end of AAVS1 sequence in the human chromosome 19 are a key to AAV integration and contain homology to the Rep binding site (RBS) and the terminal resolution

site (TRS) of AAV. AAVS1 sequence analysis also indicated the 510 nucleotides are a part of a 662 base pairs CpG island starting at 203 nucleotides and ending at 864 nucleotides when the first 1020 base pairs of AAVS1 is analyzed. In order to further characterize the role of methylation on AAV integration, we methylated *in vitro* a 8.2 kb AAVS1 fragment using CpG methylase and methyl donor, S-adenosyl methionine and transfected this methylated fragment into C18 cells. These cells were infected with wt-AAV after introduction of methylated AAVS1 and when tested failed to show any site-specific integration. Overall, results of the present study showed the influence of host methylation status in AAV-based genetic therapies.

616. rAAV Hairpin Structure Does Not Contribute to Chromosomal Integration

Marcela P. Cataldi,^{1,3} Douglas M. McCarty.^{1,2}

¹Center for Gene Therapy, The Research Institute at Nationwide Children's Hospital, Columbus, OH; ²Dept. of Pediatrics, The Ohio State University, Columbus, OH; ³MCDB Graduate Program, The Ohio State University, Columbus, OH.

The palindromic terminal repeats (TR) of adeno-associated virus (AAV) form DNA hairpins (HP) that are essential for replication and for priming the conversion of single-stranded virion DNA to double-strand. In recombinant AAV (rAAV) gene-delivery vectors, they are targets for DNA repair pathways leading to circularization, concatemerization and, infrequently, chromosomal integration. Recombination with chromosomal DNA poses a risk for genotoxicity, raising the question as to whether the hairpin structures formed by the TRs are more likely to integrate than other forms of DNA ends. Because we cannot generate rAAV viral vectors without HP ends, we investigated the contribution of AAV TR to chromosomal integration by comparing DNA molecules with the TR sequences constrained in the hairpin conformation to molecules with linear duplex ends, with or without TR sequences. In order to measure integration efficiency, 293 cells were transfected with a high dose of each of these AAV genome-like molecules carrying a GFP-expression cassette, and continuously passaged until a stable percentage of GFP-expressing cells was reached, which represented the percentage of cells with DNA molecules integrated into the host genome after loss of episomal DNA by dilution. The results show no significant difference in terms of integration efficiency between the three DNA molecules, suggesting that AAV TR in a hairpin conformation is not more or less likely to integrate than open blunt ends with or without AAV TR sequences. In addition, we found that a previously reported decrease in gene expression mediated by silencing of HP-containing molecules is not observed when molecules are transfected at high doses, suggesting that the pathway that specifically recognizes the hairpin structure and leads to DNA silencing is saturated under these experimental conditions.

617. Assessment of Oncogenic Insertional Activation Potential from rAAV Vector

Lucia E. Rosas,¹ Jessica L. Grieves,^{1,2} Douglas M. McCarty.^{1,3}

¹Center for Gene Therapy, The Research Institute at Nationwide Children's Hospital, Columbus, OH; ²Department of Veterinary Biosciences, Ohio State University College of Veterinary Medicine, Columbus, OH; ³Department of Pediatrics, Ohio State University College of Medicine, Columbus, OH.

Although recombinant adeno-associated virus (rAAV) gene delivery vectors have generally proven safe in animal models of human disease, their potential for low frequency integration into host chromosomal DNA raises concerns about genotoxicity and oncogenesis. Interactions between a rAAV vector expressing β -glucuronidase and a host common integration site have been associated with hepatocellular carcinoma (HCC) in MPS VII mice. We

have evaluated the incidence of HCC in tumor-prone C3H/HeJ mice treated with 2×10^{12} vg/kg self-complementary rAAV2-8 vectors at approximately 1 year after IV injection. Two different scAAV vector constructs were compared to saline injected controls. The first was a conventional scAAV vector expressing GFP from a CMV promoter (CMV-GFP). The second was designed to maximize insertional activation of host genes near the integration site to provide a sensitive assay for interactions between integrated rAAV and host genes, and contained the CBA promoter with no protein coding sequences, and no transcription termination signal (CBA-null). The incidence of HCC was significantly increased in C3H/HeJ males treated with either of the scAAV vectors compared to saline controls. Induction of cell cycling at the time of infection by 40% partial hepatectomy led to a further increase in HCC in CBA-null treated animals, but not CMV-GFP. Induction of DNA double-strand breaks at the time of infection by treatment with camptothecin (25mg/kg IP) did not increase the incidence of HCC in vector treated animals compared to saline controls. Vector genome (vg) copy numbers were analyzed by qPCR in tumor and normal liver tissue from vector treated animals. Tumors from animals injected with CBA-null vector were more frequently associated with significant amounts of vector DNA than animals receiving CMV-GFP. Vector junctions from several tumors from the CBA-null treated mice were amplified by inverse PCR and sequenced. Two junctions were located in the 5' non-translated regions of known oncogenes (FGF10 and H-ras1) in a direct orientation relative to the transcription of the CBA promoter. Reverse-transcription-qPCR analysis of RNA levels from the FGF10 associated tumor showed significantly increased levels of FGF10 mRNA compared to normal liver or an unrelated tumor. Characterization of vector integration sites from CMV-GFP treated animals is ongoing. The results suggest that unrestrained promoter activity in a rAAV vector can increase the incidence of HCC by insertional activation in a tumor prone animal. However, HCC incidence was not significantly increased by treatment with this vector in C3H/HeJ females, which are not tumor prone, or in C3H/SCID mice at 6 months post-injection.

618. Investigating the Axonal Transport of AAV Serotype 9 in a Microfluidic System

Michael J. Castle,¹ Eran Perlson,² Erika L. F. Holzbaur,¹ John H. Wolfe.¹

¹University of Pennsylvania, Philadelphia, PA; ²Physiology and Pharmacology, Tel Aviv University, Tel Aviv, Israel.

Though recombinant Adeno-Associated Virus (AAV) vectors are effective tools for long-term gene transfer in the brain, they typically transduce only a small region surrounding the injection site. These vectors thus have limited value for experimental applications that require widespread gene expression, or for clinical treatment of brain disorders requiring global correction. Some AAV serotypes undergo axonal transport to distal brain regions following intraparenchymal injection, although the pattern of distal transduction varies considerably among serotypes, and this transport is not observed along all neuronal pathways. This phenomenon provides a promising way to distribute gene transfer more widely in the brain. Unfortunately, knowledge of the cellular mechanisms underlying the axonal transport of AAV is limited, impeding the development of novel AAV vectors and treatment strategies that are designed to utilize this transport to enhance distribution of gene transfer. This study aims to investigate the intraneuronal trafficking of AAV9, a serotype that is strongly transported in both the anterograde and retrograde directions *in vivo*. A microfluidic system was developed that allows for specific infection at either the cell bodies or axon endings of cultured E18 rat cortical neurons, facilitating the direct examination of anterograde and retrograde axonal AAV transport. Dye-conjugated AAV9 particles developed for use in this system can be imaged in live cells, revealing the trafficking events following virus entry. Quantitative analysis of

this transport indicates that dye-labeled AAV9 moves in both the retrograde and anterograde directions, at average velocities typical of dynein- and kinesin-mediated fast axonal transport. Although both retrograde- and anterograde-directed AAV9 particles pause frequently and for extended durations, these populations are both highly directed, with movement in the reverse direction uncommon. Retrograde-directed AAV9 is composed of multiple compartment populations, including (but likely not limited to) a slow-moving lysosome-colocalized population and a faster-moving late endosome (Rab7)-colocalized population. Anterograde-moving AAV9 particles appear to be a distinct population as well, with anterograde transport observed only after AAV9 has accumulated in the cell body, suggesting that a change of compartment is taking place (e.g., transfer into a synaptic vesicle precursor compartment via the Golgi apparatus). Identification and characterization of this anterograde compartment, as well as of additional compartments composing the population of retrograde-directed particles, is ongoing. By beginning to elucidate the intraneuronal trafficking of AAV9, this work provides valuable insight into the cellular mechanisms underlying AAV transport *in vivo*, and is a first step toward the development of novel vectors and treatment strategies designed for widespread gene expression.

619. AAV Vector-Mediated Activation of Canonical and Alternative NF- κ B Pathways *In Vivo*: Implications for Innate and Adaptive Immune Responses and Gene Therapy

Giridhara R. Jayandharan,^{1,2} George V. Aslanidi,¹ Ashley T. Martino,¹ Stephan C. Jahn,¹ George Q. Perrin,¹ Roland W. Herzog,¹ Arun Srivastava.¹

¹Department of Pediatrics, University of Florida College of Medicine, Gainesville, FL; ²Department of Haematology, Christian Medical College, Vellore, Tamil Nadu, India.

We have reported that infection of HeLa cells with AAV2 vectors *in vitro* results in activation of the alternative pathway of NF- κ B, a central regulator of cellular immune and inflammatory responses. In the present studies, we examined the role of NF- κ B in AAV2-mediated gene transfer to liver in mice. *In vivo*, AAV2-mediated gene transfer results in activation of canonical and alternative NF- κ B pathways. AAV2 vectors with wild-type (WT) or tyrosine triple-mutant (TM) capsids activated canonical NF- κ B pathway within 2 hrs, resulting in expression of pro-inflammatory cytokines and chemokines (Fig. 1A). This transient process is Toll-like receptor 9 (TLR9)-dependent, and likely reflects the initial sensing of the vector genome by antigen-presenting cells. Western blot analyses (Fig. 1B) of liver homogenates prepared 9 hrs post-vector delivery, showed abundance of nuclear p52 protein component of alternative NF- κ B pathway, likely resulting from gene transfer to hepatocytes. Administration of NF- κ B inhibitor, Bay11, prior to gene transfer, effectively blocked activation of both pathways. This maneuver prevented pro-inflammatory innate immune responses and also dampened anti-AAV2 capsid antibody formation (Fig. 1C). Importantly, Bay11 did not interfere with long-term transgene expression mediated by both WT and TM AAV2 vectors (Fig. 1D). These studies suggest that transient immuno-suppression with NF- κ B inhibitors prior to vector administration eliminates inflammation, and also limits adaptive responses. This strategy could further improve the use of AAV vectors in human gene therapy.

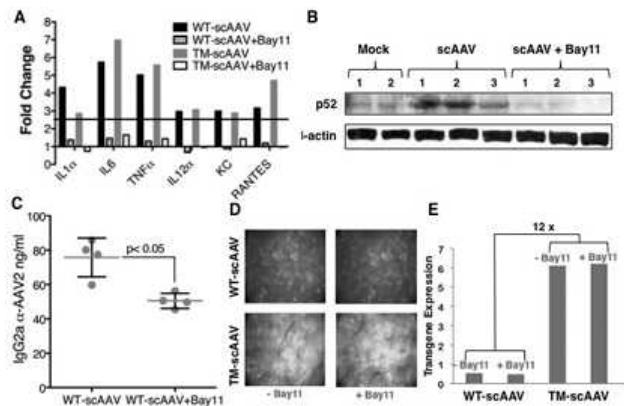

Fig. 1: (A) AAV2-induced innate immune response in mice *in vivo*. Gene expression profiling was performed, and data for fold changes in gene expression at the 2 hrs time-point comparing AAV2 vectors with Bay11 (hatched or open bars) with AAV2 vectors without Bay11 (black or grey bars) are shown. (B) Western blot analysis of liver homogenates from mice 9 hrs following mock-injections ($n=2$), or injections with scAAV2 vectors, with and without prior administration of Bay11 ($n=3$ each). The samples were analyzed by using anti-p52 antibody for detection NF- κ B signaling in response to AAV2 exposure. (C) Humoral response to AAV2 vectors in the absence or presence of NF- κ B inhibitor. Anti-AAV2 IgG2a levels were determined in peripheral blood from mice at day 10 following injections with scAAV2 vectors, with and without prior administration of Bay11 ($n=4$ each). (D) Transgene expression in murine hepatocytes 10 days post-injection of 1×10^{11} vgs each of WT-scAAV2-EGFP or TM-scAAV2-EGFP vectors/animal via the tail-vein. (E) Quantitative analyses of data from (D).

620. “Fragmented” AAV Vectors Rely on a Novel Homologous Recombination Repair Mechanism for Efficient Large Gene Delivery *In Vivo*

Matthew L. Hirsch,¹ Chengwen Li,¹ R. J. Samulski.¹

¹Gene Therapy Center, University of North Carolina, Chapel Hill, NC.

Cellular mechanisms to repair chromosomal DNA double strand breaks (DSBs) are typically divided into either homologous recombination (HR) or non-homologous end joining (NHEJ). The DNA repair pathway usually reflects the cellular environment including the availability of cognate recombination proteins, dNTP pools and the accessibility of a homologous template. Based on these observations NHEJ prevails as the DSB repair mechanism in arrested and differentiated mammalian cells whereas HR occurs primarily in dividing cells. However, overlaps in the DNA repair response between NHEJ and HR have been noted especially when exogenous DNA, such as ssDNA viral genomes, are present within the cell. In this work, we characterize a recently described adeno-associated virus vector (AAV) transducing reagent and its ability to undergo non-canonical HR *in vitro* and *in vivo*. AAV typically packages a ssDNA genome flanked by inverted terminal repeats (ITR), however, observations have demonstrated the production of genomes with a single ITR at the 3' terminus and a free 5' single-strand end. As both polarity genomes are encapsidated, the transduced ssDNA genome “fragments” are capable of 5' annealing followed by self-primed synthesis from the 3' ITR to generate a larger DNA molecule in an error-free manner. In contrast to previously documented natural ITR-ITR mediated concatemerization of wild type AAV genomes, we determined that the DNA repair mechanism for “fragmented” AAV is unique, being completely independent of the NHEJ DNA-PK complex. Rad51c, which mediates strand annealing during HR,

is necessary for “fragmented” AAV transduction suggesting that at least part of the HR pathway occurs in non-dividing cells *in vitro* and *in vivo*. In addition to elucidating a non-canonical mechanism of HR, “fragmented” AAV vectors were also directly compared to AAV trans-splicing vectors for whole body large gene transduction in a mouse model. Remarkably, transduction efficiencies of both large gene delivery strategies were comparable at high titer infection, however, at low particle administration “fragmented” AAV particles demonstrated statistically enhanced large gene transduction. From these studies, the collective results elucidate a new DNA repair mechanism utilized by AAV genomes that may be important in various steps of *de novo* viral replication but more importantly offer an efficient therapeutic transduction strategy for large gene delivery.

621. Assessment of Genotoxic Potential of Different AAV Serotype Vectors in Liver-Directed Gene Transfer

Li Zhong,^{1,2} Nirav Malani,⁴ Mengxin Li,^{1,3} Troy Brady,⁴ Jun Xie,^{1,3} Peter Bell,⁵ Haven Jones,^{1,3} James M. Wilson,⁵ Frederic D. Bushman,⁴ Guangping Gao.^{1,3}

¹Gene Therapy Center, UMass Medical School, Worcester, MA;

²Medicine & Pediatrics, UMMS, Worcester; ³Microbiology &

⁴Physiol Systems, UMMS, Worcester; ⁵Microbiology, UPENN

School of Medicine, Philadelphia, PA; ⁵Pathology, UPENN School of Medicine, Philadelphia.

Controversy exists in regards to whether the integration of recombinant adeno-associated virus (rAAV) genome into host chromosomes could lead to tumor transformation. In our previous studies, we analyzed the frequency of liver tumorigenesis in male mice with B6C3F1 background, carrying mutation in the X-linked ornithine transcarbamylase (*Otc*) gene after AAV vectors were delivered to their liver via portal vein injection. The results indicated that the mice treated with LacZ vectors showed increased risk of liver tumor formation. To further address whether the expression of LacZ and/or LacZ gene alone or in combination with AAV vector has an increased tumorigenic potential in mouse liver, we assessed the genotoxic risk of these AAV vectors in liver-directed gene transfer. The samples of liver tumor and adjacent normal liver were collected from the OTC mice, which were injected AAV2, 7 and 8 vectors expressing either the murine *Otc* or LacZ gene at 12-month post-injection. The AAV ITR junctions within PCR amplicons were prepared. The PCR products were cloned into pCR4-TOPO cloning vector and subjected to conventional sequencing analysis. The intermolecular/intramolecular recombination between AAV vector genome was observed dominantly and a few cases of integration clones were identified in both liver and tumor samples. Genome-wide characterization of the sequences at rAAV integration sites by pyrosequencing was carried out. 1677 unique AAV integration sites were identified in our study, which is the most in one single study to date. The data did not show much difference in the integration rates among all groups. However, the genomic heatmap data revealed that the integration for AAV8-LacZ vector in tumor sample was more likely happened to genes, exons, CpG islands, oncogenes, high density areas for gene and CpG islands, and nearness to oncogene transcript 5' end. The AAV8-OTC vector also preferred to integrate in genes and exons, but not in CpG islands, oncogenes and high density areas for gene and CpG islands. The result implied that the LacZ gene alone or expression of LacZ, but not AAV8 vector, may stimulate/augment the tumor formation in murine liver. For AAV2-OTC and AAV7-OTC vectors, there was no significant difference in integration pattern between liver and tumor samples. Overall, our study supported that AAV vectors alone, including different serotypes, did not cause insertional activation of oncogenes and tumor formation. However, the LacZ gene or expression of LacZ may increase the genotoxic risks of the vectors, which may warrant further investigations for its molecular and cellular mechanisms in

future studies. These studies allow us to gain insights into various aspects of the safety issue of AAV vectors, and are informative to help us to design the gene therapy trial in order to anticipate and further minimize the risk for adverse events.

Physical Methods of Delivery

622. High-Resolution, Overlapping Deposition of Multiple Plasmid DNA Species on a Cell Culture Substrate for Patterned Electroporation to a Cell Monolayer

Marven Lamarre,¹ Howard H. Lou,¹ Woo Y. Lee,¹ Philip L. Leopold.¹

¹*Stevens Institute of Technology, Hoboken, NJ.*

Engineered models of normal and pathologic tissues are becoming more popular for basic and pre-clinical research. Many normal tissues result from complex developmental patterns including gradients of one or more growth factors that target cell monolayers. A system for modeling individual or multiple gradients of gene expression in the context of a cell monolayer would be a valuable addition to our current engineered tissues. We hypothesized that high resolution patterns of DNA could be inkjet-printed onto filters prior to establishment of a cell monolayer and gene transfer by electroporation. To test this hypothesis, a commercial piezoelectric-based multi-nozzle inkjet printer was used to print a 6.7 kb DNA plasmid onto poly-lysine coated polycarbonate filters bearing 2 micron pores. The fidelity of the printed pattern was evaluated by pre-staining of plasmids with DNA-intercalating dyes, DAPI or YOYO-1, and imaging the staining pattern by widefield or confocal microscopy. A organic solvent-based ink was formulated and optimized with a plasmid DNA concentration of 0.3 mg/ml) as well as by considering the physical and chemical properties of the ink such as viscosity, surface tension, and volatility. With ink optimization, DNA patterns could be printed with 5 micron spatial resolution. DNA was observed on the printed side of the filter and extended 2 to 5 microns into the filter pores (10 micron thickness), but was not present in high abundance on the non-printed side of the filter. The amount of DNA deposited per area on the filter could be controlled by printing multiple layers in the same pattern. The deposition of different amounts of DNA was analyzed by quantitative analysis of the observed fluorescence intensity. Furthermore, multiple DNA plasmids could be printed from multiple cartridges, resulting in complex combinatorial patterns of DNA deposited with high resolution on the filter. Using confocal fluorescence microscopy, the second species of plasmid printed on top of an initial deposition of plasmid co-localized with the first species on the printed surface of the filter, but not in the underlying pores suggesting that the two plasmids would have equal access to overlying cells. Plasmid-bearing filters served as good substrates for cell culture offering the opportunity to conduct electroporation directly into an established cell monolayer. In addition to modeling growth factor gradients in engineered tissues, this technology may have applications in high throughput gene expression screening for analysis of plasmids or siRNAs, individually or in combination, especially where cell-cell or cell-substrate contacts are critical.

623. Effective Gene Transfer Using Microbubble-Assisted Ultrasound Therapy in Canine Livers

Misty L. Noble,¹ Andrew A. Brayman,² Christian S. Kuhr,³ Scott S. Graves,⁴ George W. Keilman,⁵ Liping Chen,¹ Keith R. Loeb,⁴ Rainer F. Strob,⁴ Carol H. Miao.^{1,2,6}

¹*Seattle Children's Research Inst, Seattle, WA;* ²*Applied Physics Laboratory, University of Washington, Seattle, WA;* ³*Benaroya Research Inst, Seattle, WA;* ⁴*Fred Hutchinson Cancer Research Center, Seattle, WA;* ⁵*Sonic Concepts Inc, Bothell, WA;* ⁶*Dept of Pediatrics, Univ of Washington, Seattle, WA.*

Ultrasonic excitation of microbubbles (MBs) can create temporary openings in cell membranes allowing for passive transport of large molecules, like proteins and plasmid DNA (pDNA) into cells. Our previous studies showed that ultrasound (US) can significantly enhance gene transfection in mice and rats when MBs and pDNA carrying a reporter luciferase gene are injected into the portal vein while US is applied to the liver lobes. Canine studies are underway to attempt translation of our findings to large animals. We first performed sonographic wash-in/wash-out studies to scale the volume of pDNA and MB injected into the dog livers. The best retention of the pDNA/MB complexes was achieved when a hepatic vein is occluded prior to a bolus portal vein injection of the pDNA/MB solution. The MBs distributed evenly into the specific liver lobe and persisted for several minutes. In subsequent experiments, the inferior vena cava was occluded, and pDNA/MB solution was injected into a liver lobe via a segmental portal vein branch while US (1.1 MHz, 20 cycle pulses, 50 Hz pulse repetition frequency) was applied on the surface of the liver lobe for 4 min. Treated and control lobes were sectioned (~2 g/section) and processed for luciferase expression after 24 hrs. The first study, performed using a small diameter transducer (16 mm) to deliver 2.7 MPa peak negative pressure (PNP), showed about a 20-fold increase in luciferase activity in the treated lobe compared with an untreated control lobe (247 vs. 13 RLU/mg protein). Subsequently, a dual element planar transducer (H105) with much larger effective beam diameter (58 mm) was designed and constructed specifically for dog studies. The dual element configuration apodizes the field and greatly reduces the near field transaxial pressure variations, so treated tissues are exposed to a remarkably uniform field. The next study was performed using this transducer but was set to deliver a lower pressure amplitude (2 MPa PNP). Luciferase expression was comparable to that obtained in the first study (288 vs. 13 RLU/mg protein). With the same transducer delivering 2.7 MPa PNP, gene expression was greatly enhanced 48-fold and 161-fold in lobes that had received 1.5 mL and 3 mL of Definity® MBs, respectively. Luciferase expression in some liver sections was enhanced over 600-fold relative to control lobe samples. Transaminase levels were slightly elevated, indicating minimal perturbation of liver function. These experiments represent an important developmental step towards US mediated gene delivery into larger animals and clinical trials, and demonstrate that large tissue volumes can be acoustically treated effectively with suitable transducer technology.

624. Localized Gene Modification of Muscle Tissue Using Autologous Fat Grafts as a Vehicle for Viral Vector Delivery

Ergun Kocak,¹ Katherine H. Carruthers,¹ Matthew J. During.²

¹*Plastic Surgery, The Ohio State University Medical Center, Columbus, OH;* ²*Molecular Virology, Immunology, and Medical Genetics, The Ohio State University Medical Center, Columbus, OH.*

Background: The specific targeting of selected tissues remains a challenge in gene therapy methods utilizing viral vectors. Methods that improve the targeting of tissues may improve clinically applicable

gene therapy treatment regimens. We set out to develop a method for gene modification of host tissues that would yield sustainable and clinically detectable production of gene products by targeted tissues with minimal effect on non-targeted tissues. **Methods:** Gene delivery was carried out using a recombinant adeno-associated viral vector, termed rAAVrec2 (previously derived using a PCR shuffling technique from human and non-human primate viral isolates.) This vector was used to deliver the luciferase gene into the pectoralis major muscle in wild-type C57BL/6 mice. Viral vector was delivered by one of two surgical methods: (1) viral vector suspended in saline was directly injected into the belly of the pectoralis muscle using a micro syringe and 30 gauge hypodermic needle and (2) autologous fat tissue, obtained from a donor mouse, was injected with the same viral vector and allowed to incubate *ex vivo* for 15 minutes before it was processed into smaller fragments and surgically implanted into the belly of the pectoralis muscle. Following the procedure, animals were serially imaged to detect luciferase activity using the *in vivo*, real-time imaging system IVIS 100 (Caliper Life Sciences, MA). Tissues were collected and processed at 4-5 weeks post injection of viral vector and histologically examined with immunohistochemical staining techniques. **Results:** Direct injection of viral vectors into muscle tissues lead to clinically detectable luciferase activity on IVIS imaging that was confirmed by histological analysis; however, these animals also demonstrated strong enzymatic activity in the mid-abdominal region that was shown by histology to be consistent with hepatic luciferase expression. Mice whose muscles were gene-modified using autologous fat grafts as a vehicle for delivery of the viral vectors also showed luciferase activity on IVIS imaging, but had no evidence of signal on whole-body imaging. Histological analysis of liver sections from these mice confirmed absence of hepatic luciferase expression. Further examination of histological sections of gene modified muscle indicated that both the adipose and nearby muscle cells were responsible for the luciferase activity. **Conclusions:** Using fat grafts as a vehicle, we have developed a method for gene delivery into muscle tissue that leads to highly specific gene modification of targeted tissues with minimal infection of non-target tissues.

625. Optimization of High Intensity Therapeutic Ultrasound and Microbubbles for Gene Delivery into Rat Liver

Shuxian Song,¹ Misty L. Noble,¹ Samuel Sun,¹ Liping Chen,¹ Andrew A. Brayman,³ Carol H. Miao.^{1,2,3}

¹Seattle Children's Research Institute, Seattle, WA; ²Department of Pediatrics, University of Washington, Seattle, WA; ³Center for Industrial and Medical Ultrasound, Applied Physics Laboratory, University of Washington, Seattle, WA.

The use of ultrasound (US) combined with microbubbles (MBs) has been explored widely *in vitro* and *in vivo* as a potentially effective and relatively safe physical method for gene delivery. We previously reported efficient gene transfer with US exposure and MBs in a mouse model. We subsequently investigated scaling-up gene delivery in the rat model using an unfocused high intensity therapeutic ultrasound system and targeted injection of plasmid and MBs into a specific liver lobe. For developing safe and effective application to larger animal models with the new system, we evaluated both the luciferase reporter gene transfer efficacy as well as liver damages under various MB concentrations and different acoustic parameters. In studies of MB doses using Definity® contrast agent and an acoustic pressure amplitude of 2.7 MPa at 1 MHz, the luciferase expression levels were significantly enhanced over the range of 0-30 Vol% MB concentrations (15~350 fold vs. plasmid only negative control) with a plateau rapidly being reached between 0.5 and 30 Vol%. These results differed from those of earlier mouse experiments obtained using a focused US system, in which much higher threshold MB concentrations (~5%) were needed for significant enhancement of

gene transfer efficiency. In US-treated rats, a maximum level was observed at the MB concentration of 10 Vol%, while in the mouse model, the peak was at 15 Vol%. This nominal difference is mostly likely due to more efficient acoustic exposure from the bigger unfocused transducer used in the rat experiments. Application of pulse-train US exposure regimens improved tissue distribution of plasmid DNA/MBs and produced reporter gene expression levels comparable to the positive control treated with standard US condition even though the acoustic energy was reduced 30-50%. We evaluated the liver damages by transaminase assays and histological staining. Only minor increases in transaminase levels were observed after US treatment under various conditions, indicating that US treatment of one specific liver lobe produced minimum impact on total liver function. More detailed analysis of microscopic damages carried out by H&E staining showed hemorrhage and focal coagulative necrosis in the treated lobe, which resolved over time. Less liver damage was produced with lower MB concentrations and lower 'extents' of acoustic exposure; e.g., lower acoustic pressures, lower acoustic pulse repetition frequency and shorter overall exposure time. These attempts on optimization of the new US/MB system for rat livers indicated that efficient gene transfer and minimum liver damage could be achieved by using lower MB concentrations and pulse-train US procedures with lower acoustic energy and sustained plasmid DNA/MB distribution.

626. Gene Delivery Using a Novel Physical Mode of Transfection Based on Electro spray

Michael Maguire,¹ Heather Kavanagh,¹ Eoin Judge,² Natasha McCormack,¹ James Egan,² Shirley O'Dea.¹

¹Institute of Immunology, Biology Department, National University of Ireland Maynooth, Maynooth, Kildare, Ireland; ²National Heart and Lung Transplant Unit, Mater Misericordiae University Hospital, Dublin, Ireland.

BACKGROUND: Gene delivery to many cell types *in vitro* and to tissues *in vivo* remains a significant challenge. Limitations of lipid- and virus-mediated transfection methods include toxicity, high cost and complexity *in vitro* and efficacy, targeting and immunogenicity *in vivo*. Our group is pioneering 'electrospray' as a physical means of transfection that overcomes many of these issues *in vitro* and *in vivo*. Electro spray is a method of generating a very fine spray of a fluid by electrostatic charging. We have developed a system, 'ProFactor', capable of creating a continuous electro spray that is controlled by software. The electro spray is formed from colloids of a solution containing plasmid DNA. The colloids attain high velocities and sufficient force to penetrate through the cell membrane and transfect the cell. ProFactor comprises a spray head (patent pending) and a conduit. The spray head is capable of generating the electro spray and can be deployed both *in vitro* and *in vivo*. Here we determined the ability of ProFactor to transfect lung cells *in vitro*. **METHODS:** Human lung cell lines (BEAS-2B and DLKP) or primary mouse airway epithelial cells (MAECs) were seeded into 24-well cell culture plates. Cells were electro sprayed with solutions containing either green fluorescent protein (pMGFP) or *Gaussia* luciferase (pGLuc) reporter plasmids. Typically 750 ng DNA was delivered per well. After 48 hrs, GFP or luciferase expression were determined by flow cytometry or luminometry respectively. Cell viability was determined by ethidium bromide/acridine orange (EBAO) staining. **RESULTS:** In BEAS-2B and DLKP cells electro sprayed with pMGFP, analysis of GFP expression at 48 hrs by flow cytometry demonstrated that transfection efficiencies of 30-65% were achieved. Efficiencies of 15% were achieved with pMGFP in primary MAECs. With the pGLuc plasmid, luciferase activity at 48 hrs was increased 42-fold in DLKP cells and 10-fold in primary MAECs. Cell viability throughout was similar to controls and typically >95%. **CONCLUSIONS:** ProFactor currently delivers molecules into cells cultured in a multi-well (24-

well) format. To date, we have focused on DNA transfection and have used *ProFactor* to deliver plasmid DNA to a range of cell types *in vitro*. We typically achieve transfection efficiencies of 30-65% with low-to-no toxicity. We have also successfully transfected cells with siRNA molecules. Advantages of *ProFactor* over existing transfection methods such as lipofection and viral delivery include: fewer steps, lower cost, lower toxicity and no additional reagents, expertise or specialist facilities required. *ProFactor* will be automated in the near future and will be compatible with other multi-well formats including 96-well plates and larger high throughput formats. An *in vivo* device using the same technology is also currently being tested in large animals.

627. Optimization of Image-Guided Hydrodynamic Gene Delivery to Liver of Large Animals

Kenya Kamimura,¹ Takeshi Suda,¹ Tsutomu Kanefuji,¹ Guisheng Zhang,¹ Dexi Liu.¹

¹Department of Pharmaceutical Sciences, School of Pharmacy, University of Pittsburgh, Pittsburgh, PA.

Hydrodynamic delivery of pCMV-Luc plasmids (100 g/ml) to the liver using the technique of image-guided insertion to place the catheter into the desirable site of hepatic vein and computer-assisted injection device to control the injection speed and volume was performed in 15 large pigs (40-45 Kg) in order to identify parameters critical for gene delivery efficiency and safety. The experimental procedure involves an insertion of a balloon catheter from the jugular vein to the hepatic vein of the selected liver lobe with a pressure transducer inserted within the balloon catheter to the site of injection and connected to a laptop computer for display and pressure recording. Plasmid DNA injection was driven by the pressure in a CO₂ tank using a computer-controlled injection device that we have built earlier. With fixed injection pressure at 300 psi, 10.5 Fr balloon catheter, and the injection volume 2 times greater than that of the liver lobe, the injection from the proximal site (near the joint of major trunk of hepatic vein and inferior vena cava) of the hepatic vein resulted in a sustained pressure at 100 mmHg extending the entire injection period, compared to an intravascular pressure of 200 mmHg, and 150 mmHg, respectively, when the balloon catheter was placed at the distal site (inside the first branch of the main trunk of the hepatic vein), or the middle site (between distal and proximal sites). The level of reporter gene expression was determined 24 hr after the injection by 15 liver samples collected evenly from the each targeted lobe. The amount of luciferase protein was the highest at 20 ng luciferase/mg of protein with intravascular pressure of 150 mmHg, 2.4 fold higher than that of 100 mmHg (8.4 ng/mg), and no statistical difference (14.3 ng/mg) was seen at 200 mmHg with balloon catheter located at the distal site. When three injections were performed on the same animal (injection to the right lateral, right medial, and left lateral lobes separately) with balloon catheter inserted at the middle site, the level of luciferase for the entire liver was the highest when the ratio of injection volume to liver volume is 2.5 (114.4 ng/mg), 7-times higher than that achieved by using one half of the injection volume. Results from serum biochemistry analysis revealed an increase of serum concentration of AST, ALT, and LDH reaching to peak level at 104, 60, 700 U/L, respectively in 24 hrs and returning to normal level of 30, 30, and 400 U/L in 7 days, respectively. No change of cardiovascular condition was seen during and after hydrodynamic injection. These results suggest that for image-guided hydrodynamic gene delivery to the liver of human-size animals, (1) the relative position of the catheter in the hepatic vein could be important for gene delivery efficiency and intravascular pressure; (2) sequential injection to each of the liver lobes to deliver plasmid to the entire liver is safe and effective; and (3) the optimal injection volume is 2.5 fold of the liver volume. *This work was supported in part by NIH grants RO1EB002946, RO1EB007357, and RO1HL075542.*

628. Abstract Withdrawn

629. Sustaining Cardiac Expression of Adenovirus Delivered Genes with a Dexamethasone Releasing Hydrogel

Karen Kadner,¹ Sharma Vinod,² Deon Bezuidenhout,¹ Peter Zilla,¹ Neil Davies.¹

¹Surgery, University of Cape Town, Cape Town, South Africa; ²Medtronic Inc, Minneapolis.

We have developed polyethylene glycol (PEG) hydrogels that can polymerise spontaneously *in vivo* to allow for controlled release of dexamethasone. These dexamethasone loaded gels have the potential to reduce the inflammatory and immune responses to viral vectors. In this study we investigated their efficacy in the context of focal cardiac delivery of adenovirus (ADV) vector encoding for the green fluorescent protein (GFP) towards our goal of viral vector delivery and sustained gene expression for the treatment of pathologies of the heart. Dexamethasone was successfully modified by acrylation, solubilized by PEGylation, and covalent incorporated into PEG gels. 1.5 X 10⁹ pfu of ADV-GFP were delivered to rat hearts by direct cardiac injection. The virus was delivered in 100 µl of either saline or PEG gel pre-components containing 125 µg acrylated covalently bound dexamethasone. The gels were crosslinked *in situ* via a matrix metalloproteinase sensitive peptide that allows for enzymatic degradation over 1-2 weeks. The dexamethasone is released in its original form by hydrolysis over that period. The rats were sacrificed after 1 week and assessed for GFP expression, macrophage content, T-lymphocyte and cardiac tissue damage. There was a 7.7 fold greater expression of GFP in the dexamethasone containing group (p<0.05). Macrophage and T-lymphocyte responses were also significantly reduced when normalized to GFP expression [5 fold (p<0.05) and 20.2 fold (p<0.1) reduction for macrophages and T-lymphocytes respectively]. Similarly there was significantly less fibrosis within the cardiac tissue relative to GFP expression in the dexamethasone group [9.7 fold reduction (p<0.1)]. Thus, we have demonstrated proof of principle for drug releasing PEG gels to aid in sustained gene expression via viral vector delivery. The chemistry of these gels can be further refined to allow for release of other anti-inflammatory and immunosuppressant drugs.

Gene Targeting

630. PhiC31 Integrase Fusion Proteins: Targeted Insertion towards Specific Genomic SitesNadja Noske,¹ Nina Harms,¹ Anja Ehrhardt,¹¹*Department of Virology, Max-von-Pettenkofer Institute, Munich, Germany.*

Non viral integration systems are promising and attractive tools for the development of new gene therapeutic strategies. Based on site-directed recombination between the attB and attP sites the bacteriophage derived PhiC31 system provides outstanding opportunities for transgene integration into the host genome. The recombination process mediated by the PhiC31-integrase enables a biochemical synopsis organisation between four molecules of the enzyme, the introduced attB site and a genomic pseudo attP site, resulting in the unidirectional insertion of the therapeutic gene. However, due to the fact that there are up to 100-1000 pseudo attP sites existing in the genome, the optimization of activity and directing integration into specific target sites are important goals for the usage in therapeutic applications. For the improvement of specificity we constructed several fusion proteins of the integrase and different DNA binding domains (DBD) like the synthetic polydactyl zinc finger E2C and the AAV Rep78 protein in order to target the specific genomic region for integration. As an internal control we also set up an eGFP-integrase fusion. The motifs were either added N- or C-terminal to the integrase separated by a short single TS or a long GGS(5) amino acid linker. Immunoblot and flow cytometry analysis revealed that the fusion proteins were well expressed after transfection into 293- and Hela cells. Excision and integration activity retained up to 70% of the wildtype integrase (WT) in 293-cells and nearly 50% in Hela-cells when the binding motifs eGFP and E2C were attached to the C-terminus of the integrase separated by the 45-bp long GGS(5) interdomain, whereas the short TS-linker constellations led to a catalytic inactivation of the integrase. By using the AAV Rep78 motif, we achieved up to 80% activity in 293-cells, and up to 60% in Hela-cells, as detected in colony forming assays. As a further step we generated fusion mutants lacking the native DBD of the integrase (deltaDBD). As expected, these were catalytically inactive when measuring recombination efficiencies between wild type PhiC31 integrase recognition sites in the excision assays. However, after performing initial colony forming assays to measure integration events mediated by the deltaDBD fusion constructs, we observed 30% activity of the WT in 293-cells. We have also started to build up on our previous study in which we identified hyperactive variants of the integrase showing up to 5.5-fold increased integration efficiency (Liesner et al., Human Gene Therapy 2010). In this previous study we also characterized several critical amino acids involved either in DNA attachment or in the catalytic process. We now show that one identified mutant that lost its native DNA binding property could be restored to up to 10% activity in Hela-cells when fused to the AAV Rep78 motif. Utilizing PCR-based integration site analysis we are in the process to investigate the targeting efficiency mediated by this specific fusion motif. In combination with hyperactive PhiC31 variants this approach could lead to a more specific and efficient PhiC31 integrase system.

631. Sustainable Gene Transfer by Selection of Genomic Target Site and *In Situ* Tailoring of Cassette Design in Human Lymphocytes and Stem CellsAngelo Lombardo,^{1,2} Daniela Cesana,¹ Pietro Genovese,^{1,2} Daniele Colombo,^{1,2} Bruno Di Stefano,³ Elena Provasi,^{2,4} Margherita Neri,^{1,2} Zulma Magnani,⁴ Michael C. Holmes,⁵ Philip D. Gregory,⁵ Angela Gritti,¹ Vania Broccoli,³ Chiara Bonini,⁴ Luigi Naldini.^{1,2}¹*San Raffaele Telethon Institute for Gene Therapy, San Raffaele Institute, Milan, Italy;* ²*Vita-Salute San Raffaele University, Milan, Italy;* ³*Stem Cell and Neurogenesis Unit, San Raffaele Institute, Milan, Italy;* ⁴*Experimental Hematology Unit, San Raffaele Institute, Milan, Italy;* ⁵*Sangamo BioSciences Inc., Richmond, CA.*

Site-specific integration may overcome the major hurdles of current gene transfer approaches, i.e. insertional mutagenesis and uncontrolled transgene expression. However, suitable genomic sites for transgene integration and the dynamic interplay between the integrated transgene and the targeted locus have remained elusive. Here we address these issues by studying the transcriptional/epigenetic impact of different GFP expression cassettes targeted into two putative suitable loci, *CCR5* and *AAVS*, by Zinc Finger Nuclease-induced homologous recombination. We achieved efficient (up to 6%) integration in both sites across a panel of human primary cell types, including T lymphocytes, NSC and iPSC. Molecular analysis on FACS-sorted populations and 130 single-cell derived clones revealed insertion at the intended site in >90% of events. Interestingly, GFP expression was reproducibly higher from the *AAVS1* locus than from the *CCR5* gene. Next, we measured the expression level of the genes in a 400Kb region centered on the insertion site and showed that promoters of housekeeping genes (PGK or EF1A) induced little perturbation, while the SFV promoter strongly up-regulated (up to 200-fold) expression of neighboring genes at distances of up to 200Kb from the insertion. Strikingly, transcriptional perturbation was locus-dependent -being absent at the *AAVS1* site. Because integration into *AAVS1* occurs within intron 1 of the *PPP1R12C* gene, exogenous *cis*-acting elements could interfere with its endogenous transcription. Analysis of cell clones containing mono- or bi-allelic insertion of the cassettes revealed that *PPP1R12C* transcription was negatively affected by the presence of splicing acceptor (SA) sites present in the EF1A-Intron and PGK cassettes. Inserting these cassettes in opposite orientation or eliminating the SA sites allowed for robust transgene expression while maintaining normal *PPP1R12C* expression in primary cells. Finally, epigenetic analysis of the two loci before and after bi-allelic integration showed loss of repressive histone marks that characterize the tightly regulated expression of *CCR5* and an increase of the pre-existing transcription/elongation histone marks in the constitutively expressed *PPP1R12C*, in agreement with the expression data. Only when *PPP1R12C* expression was abrogated (*via* inclusion of a SA site in the cassette), histone modifications were substantially rewritten downstream of the insertion site to acquire marks of repressive/silenced chromatin. Overall, transcriptional and epigenetic comparison of these different sites before and after integration uncover essential features of the locus and the cassette design that allow achieving benign targeted insertion in human primary cells.

632. Genome-Wide Determination of Induced DNA Double-Strand Breaks Reveals High Specificity of Zinc Finger Nucleases

Richard Gabriel,¹ Angelo Lombardo,² Anne Arens,¹ Jeffrey C. Miller,³ Pietro Genovese,² Christine Kaepfel,¹ Ali Nowrouzi,¹ Cynthia C. Bartholomae,¹ Jianbin Wang,³ Geoffrey Friedman,³ Michael C. Holmes,³ Philip D. Gregory,³ Hanno Glimm,¹ Manfred Schmidt,¹ Luigi Naldini,² Christof von Kalle.¹

¹National Center for Tumor Diseases and German Cancer Research Center, Heidelberg, Germany; ²Vita Salute San Raffaele University, Milan, Italy; ³Sangamo BioSciences, Inc., Richmond, CA.

Zinc finger nucleases (ZFNs) facilitate precise and effective gene modification in living cells by targeting DNA double strand breaks (DSB) to predetermined genomic loci. Due to the rapid repair and therefore transient persistence of DSBs in living cells, detection of ZFN activity at potential off-target loci is experimentally challenging. Thus, to date analyses of ZFN off-target activity have had to rely on *in vitro* binding assays and bioinformatics predictions. Here we took advantage of integrase-defective lentiviral vectors (IDLV) that are captured and ligated into DSBs during non-homologous end-joining (NHEJ) repair, thereby stably tagging these otherwise undetectable transient events. Integration site (IS) analysis of captured IDLV by LAM-PCR allows a comprehensive assessment of the genome sequences cleaved by a given ZFN dimer in a chosen cell type. Mapping of >1500 unique IS in human cells treated with ZFN revealed that the intended target site was by far the most frequently IDLV-tagged genomic locus, as shown by clusters of IDLV IS (CLIS) surrounding the on target ZFN cleavage site. CLIS were also detected at a few additional off-target loci, and a mismatch-selective endonuclease assay allowing detection of NHEJ repair at preselected genomic sites confirmed these off-target hotspots of ZFN activity independently. Deep-sequencing confirmed that off-target sites were restricted to genomic loci harboring a high homology to the intended ZFN target and demonstrated that cleavage of DNA requires binding of both ZFNs in specific spatial arrangements that appear to permit FokI dimerization. High-throughput IS mapping of ZFN activity established a consensus for the actual cleavage *in vivo* testifying to the high specificity of ZFN action on the human genome and could potentiate clinical application of this technology.

633. Targeted Gene Integration in Human Epidermal Stem Cells by Zinc-Finger Nuclease-Mediated Homologous Recombination

Annarita Miccio,¹ Angelo Lombardo,² Andrea Coluccio,¹ Francesca Miselli,¹ Michael Holmes,³ Philip D. Gregory,³ Luigi Naldini,² Alessandra Recchia,¹ Fulvio Mavilio.¹

¹Center for Regenerative Medicine, University of Modena and Reggio Emilia, Modena, Italy; ²San Raffaele-Telethon Institute for Gene Therapy, Milan, Italy; ³Sangamo BioSciences Inc, Richmond, CA.

Transplantation of autologous, genetically corrected Epidermal Stem Cells (EpSC) has been successfully used to treat junctional epidermolysis bullosa, a genetic skin adhesion disorder. Despite the therapeutic efficacy of this approach, safety concerns were raised by the use of a gamma-retroviral vector to express the therapeutic gene, encoding the $\beta 3$ chain of laminin 332 (LAMB3). Targeted transgene integration overcomes the issue of potential random insertional mutagenesis associated with retroviral vectors, and thus may provide a safer alternative. We developed a gene-targeting platform based on the use of Zinc-finger nucleases (ZFN) and integrase-defective lentiviral vectors (IDLV) to insert a transgene by homologous recombination (HR) into the AAVS1 locus on chromosome 19. We evaluated the targeting efficiency in a keratinocyte cell line (HaCaT) by IDLV-

mediated delivery of an AAVS1-specific ZFN pair together with an HR construct driving the insertion of a GFP expression cassette into the site of cleavage. We achieved high efficiency of targeted insertion of single copies or concatamers of the GFP cassette into the AAVS1 locus (up to 30% of the infected cells), as analyzed by PCR, Southern blotting and sequencing on individual HaCaT clones. Evidence of HR-mediated targeted integration was also obtained at a lower but significant frequency in primary human keratinocyte cultures, where the efficiency of gene delivery by IDLVs appears to be a limiting factor. Overall, these experiments provide proof of principle for the feasibility of ZFN-mediated transgene integration in safe and predetermined genomic locations in human keratinocytes, opening new possibilities for the treatment of genetic skin diseases. Moreover, our studies reveal the need to develop improved methods for delivering both ZFN and donor DNA to keratinocytes for high efficient gene transfer (Funded by grants from the European Commission, EC-HEALTH-2009-222878-PERSIST, and Telethon).

634. Zinc-Finger Nuclease-Mediated Gene Correction Using Single AAV Vector Transduction and Enhancement by FDA Approved Drugs

Brian L. Ellis,² Matthew L. Hirsch,¹ Jenny Barker,² Richard J. Samulski,¹ Matthew H. Porteus.²

¹Gene Therapy Center, University of North Carolina, Chapel Hill, NC; ²Biochemistry and Pediatrics, University of Texas Southwestern Medical Center, Dallas, TX.

A potential therapeutic strategy for the treatment of monogenic diseases employs genetic engineering to precisely correct the mutation(s) at the genome level. Recent advancements in this technology have demonstrated efficient gene correction using a targeted DNA double-strand break in conjunction with an exogenous DNA repair substrate. Such a strategy would likely be applied *ex vivo* and would rely on safe and efficient DNA delivery to the target cell. Among viral gene delivery vectors, adeno-associated virus (AAV) has demonstrated clinical success, however a major drawback of these vectors is the small DNA packaging capacity (<5kb). To overcome this limitation in the context of zinc-finger nuclease (ZFN) gene correction, a novel expression cassette was validated in which 2 ZFN subunits were connected by a self-cleaving 2A peptide and expressed from a single promoter. Given this arrangement, a 1kb nucleotide repair substrate (gfpR) was also included on the same vector while not exceeding the AAV packaging capacity. Initially, we analyzed transduction by AAV serotypes 1-9 on 17 different primary cell types and found, in general, AAV6 = AAV1 > AAV2. Transduction using AAV6 packaged with the ZFN-gfpR expression cassette demonstrated efficient cellular cleavage of the ZFN to monomer subunits that stimulated gene targeting near 1% of treated cells, depending on cell type. In these experiments, the repair substrate was deemed limiting as the correction efficiency was enhanced 3-fold when the donor fragment was provided in excess by a separate AAV vector. Further enhancements of the AAV gene correction efficiency were demonstrated using FDA approved drugs involved in proteasome and histone deacetylase inhibition. Collectively, these experiments provide a novel reagent for efficient gene correction using AAV single vector delivery and demonstrate drug enhancement of this process into values deemed therapeutic for several genetic diseases.

635. Improved Technology for Estimating the Abundance of Gene Corrected Clones from Integration Site Data

Troy L. Brady,¹ Shoshannah L. Roth,¹ Nirav Malani,¹ Frederic D. Bushman.¹

¹*Microbiology, University of Pennsylvania, Philadelphia, PA.*

Gene therapy using integrating vectors can stably correct genetic diseases, but vector insertion near growth-promoting genes may alter gene expression and promote cell division, potentially contributing to adverse events. Even in the absence of adverse events, detection of vector insertions provides insight into the *in vivo* dynamics of clonal populations. Monitoring modified cell populations is thus an important part of patient management. Some methods for detecting vector integration sites use restriction enzymes and ligase to attach PCR adapters to genomic DNA from gene-modified cells. The use of restriction enzymes introduces recovery bias in which only the fraction of vector insertions within an optimal distance from a restriction enzyme cleavage site are recovered efficiently. This results in a skewed recovery of vector sites and inaccurate estimations of clonal abundance. In addition, cross-contamination of amplified integration sites can occur during sample processing, further complicating the reconstruction of clonal populations. Here we present recent advances in integration site recovery methods that reduce recovery bias, provide simple abundance estimations, and suppress cross-contamination between samples. The use of bacterial transposases, such as MuA, instead of restriction enzymes has proven to be an attractive alternative for both detecting vector sites with less bias and for estimating clonal abundance. Reconstruction experiments and statistical modeling studies have been carried out to document the robustness of these methods. In addition, we have devised a multi-adaptor approach that suppresses cross-contamination between samples. By using a different PCR adaptor for each sample processed, amplification of contaminating amplicons is suppressed, greatly reducing their recovery during sequencing. This method has been adapted for use with LM-PCR and the Mu method and is adaptable to most other recovery methods as well. We will report how less biased recovery methods in conjunction with a multi-adaptor approach facilitate reconstruction of gene-modified cell populations in animal models and human subjects.

636. Using a Novel Negative Selection Based on shRNA Strategy To Enrich for Homologous Recombinants

Feng Gu,¹ Roli Hirata,¹ David Russell.¹

¹*Division of Hematology, University of Washington School of Medicine, Seattle, WA.*

Gene targeting is a precise method, which can be used to examine a gene's function or to correct a mutation and treat genetic diseases. In mammalian cells, integration into the homologous chromosomal region occurs at a relatively low rate compared to random integration, so the identification of homologous recombinants can be difficult. Several strategies have been reported to address this problem, in particular negative selection approaches that can eliminate random integrants. We have found that AAV vectors can be used for efficient human gene targeting. However, random integration can still occur which can greatly increase the number of clones that must be screened to identify homologous recombinants. We therefore sought to develop a method for selectively eliminating random AAV vector integrants, keeping in mind the small packaging capacity of AAV (~4.7 kb). Short hairpin RNAs (shRNAs) can be used to knock down the expression of specific genes, and their expression cassettes are relatively small. Here we have developed a novel negative selection method for gene targeting based on shRNA expression by AAV vectors. In this case the targeting cassette incorporates a *Neomycin (Neo)* gene to select

for both targeted or random integrants, as well as anti-*Neo* shRNA cassettes placed outside of the targeting homologies. Most random integrants will carry the shRNA cassettes and therefore have reduced *Neo* expression, so they will not be G418-resistant. Only homologous recombinants, which don't harbor the shRNAs, should survive G418 selection. We first compared various H1 and U6 promoter constructs to identify the smallest shRNA expression cassette with high level expression. Our results showed that an 85 bp fragment of the mouse U6 promoter achieved a significant knockdown of *Neo* expression, but smaller promoters were significantly weaker. Nine different shRNAs directed against different portions of *Neo* gene were then compared and three were identified with high knockdown activity (Neo51, Neo65, Neo171). To test for enrichment of homologous recombinants by these shRNAs, we incorporated them into AAV targeting vectors designed to insert a *Neo* gene into exon 3 of the human X-linked *HPRT1* gene (*Hypoxanthine-guanine Phosphoribosyl Transferase*). *HPRT*⁻ cells can be directly selected by growth in the presence of the cytotoxic base analogue 6-Thioguanine (6-TG) to identify targeted recombinants. Random and targeted integrants can be identified by G418 resistance. Preliminary experiments showed that a single shRNA outside of one homology arm could produce a 5-10-fold enrichment in G418-resistant targeted clones. Here we will present our results with vectors incorporating two anti-*Neo* shRNAs (one on either end of the vector genome).

637. Evaluation of a Reporter System for Site-Specific I-SceI-Mediated Genome Editing in Canine Hematopoietic Stem Cells

Nina M. Muñoz,¹ Brian C. Beard,¹ Byoung Y. Ryu,² Grant D. Trobridge,¹ Andrew M. Scharenberg,² Hans-Peter Kiem.^{1,3}

¹*Fred Hutchinson Cancer Research Center, Seattle, WA;* ²*Seattle Children's Research Institute, Seattle, WA;* ³*University of Washington, Seattle, WA.*

To assess hematopoietic stem cell (HSC) targeted gene correction approaches in the clinically relevant canine model, we developed a fluorescent reporter system in which target cells contain integrated I-SceI homing endonuclease cleavage sites. In this system, the gene target vector consists of a non-functional EGFP gene with a recognition site for I-SceI upstream of the EGFP start codon. The target vector also encodes MGMP140K to allow for *in vivo* selection of gene-modified cells using O6BG and BCNU following transplantation. The repair template consists of a C-terminal truncated non-functional mutant EGFP and targeted gene correction by homologous recombination with the target vector results in functional EGFP expression. Transduction of canine osteosarcoma D17 cells harboring integrated gene targets with integrase-deficient lentiviral vectors (IDLV) that separately deliver the repair template and I-SceI homing endonuclease result in gene correction rates of 4-10%. To establish genome editing in CD34+ cells, we have successfully performed two allogeneic stem cell transplants in DLA-identical settings using CD34+-selected cells transduced with the gene target vector. The first recipient canine shows stable gene marking and donor chimerism, and two treatments with O6BG and BCNU resulted in a 8-fold increase in the gene marking levels, which has remained stable >600 days after the transplant. The second recipient is recovering normally 200 days after the cell infusion and has been treated once with O6BG and BCNU. *Ex vivo* gene correction studies using primary CD34+ cells from the first recipient have shown that lentivirus-mediated delivery of I-SceI induces cleavage and NHEJ repair of the target sequence. This demonstrates that the introduced target can be cleaved and repaired in long term repopulating cells; however, concomitant delivery of I-SceI and the repair template with lentiviral vectors has not lead to gene correction indicated by functional EGFP expression or sequence analysis. In summary, we have established a color change reporter system to study I-SceI-mediated gene correction

in a canine model, and found that lentivirus-mediated delivery of I-SceI causes the cleavage of the target gene but not gene correction in long term repopulating cells from the first recipient canine. Our current efforts are aimed at evaluating different conditions for gene correction in primary cells from both transplanted canines.

Cancer-Targeted Gene & Cell Therapy II

638. Non-Viral Delivery of STICKY-SIRNA™ Targeting the Cell Cycle Inhibits Lung Tumor Metastasis

Anne-Laure Bolcato-Bellemin,¹ Marie-Elise Bonnet,¹ Jean-Paul Behr,² Patrick Erbacher.¹

¹*Polyplus-Transfection, Illkirch, France;* ²*Laboratoire de Chimie Génétique, Université de Strasbourg, Illkirch, France.*

Cancer is a leading cause of death worldwide, accounting around 13% of all death. Among cancers, lung cancer is the most common in term of incidence and mortality. Metastasis, due to uncontrolled cell growth, is responsible for more than 90% of deaths from lung cancer. Thus, developing new treatments to inhibit cell metastasis will improve patient prognosis and quality of life. Since the discovery of RNA interference and its potency for therapeutic applications, this technology has been widely used to suppress target gene expression involved in many diseases such as cancer. However, to date, delivery still remains a major obstacle for siRNA-based drugs to be a success. Polyethylenimine (PEI) has been widely used for in vivo gene delivery. We have recently developed novel interfering RNA (STICKY-SIRNA™) in order to improve the delivery and silencing efficiency of PEI polyplexes. Our modified siRNA mimics the structure of long double-stranded nucleic acid through reversible concatemerization and shows higher silencing efficiency compared to non oligomerized siRNA. Moreover, no production of pro-inflammatory cytokines, including interferon- β , nor hepatic enzymes were observed after systemic delivery of these modified siRNA2. Cyclin B1 is essential for the initiation of mitosis. Its deregulation is involved in neoplastic transformation. Recent papers have shown that suppression of cyclin B1 could be an attractive strategy for antiproliferative cancer therapy. We have analyzed the impact of suppression of cyclin B1 by delivering STICKY SIRNA™ with linear polyethylenimine in different cancer cell lines (TSA-Luc, B16-F10 and 3LL-Luc). We have shown that cyclin B1 STICKY SIRNA™ arrested the cell cycle in G2/M phase in all cancer cell lines tested. Consequently, the ability of STICKY SIRNA™ to suppress cell metastasis in the lung was investigated. By injecting cyclin B1 STICKY SIRNA™ with linear polyethylenimine intravenously, tumor lung metastasis progression was blocked by more than 50%. The survival rate of the mice was also significantly increased. We have also shown that combination of STICKY SIRNA™ delivery with antiproliferative drugs (i.e. cisplatin) increase tumor growth inhibition by more than 70%. Taken together our data showed that the delivery of STICKY SIRNA™ with linear polyethylenimine could become a powerful tool for antitumor therapy. 1 Bolcato-Bellemin et al., PNAS, 2007, 104, 16050-5. 2 Bonnet et al., Pharm Res, 2008, 25, 2972-82.

639. Early Efficacy Study of Ad-p53 in Combination with Gemcitabine and Intraperitoneal Cisplatin Plus Regional Thermotherapy in Advanced Pancreatic Cancer with Ascites

Yuan Qin,¹ Dong Ren,² Yufei Fan,² Xiaolin Liu,² Dinggang Li.¹

¹*Oncology, Beijing Haidian Hospital, Beijing, China;* ²*Oncology, Beijing Yanhua Hospital, Beijing, China.*

Background: Pancreatic cancer has about an annual incidence of 43,000 pts/yr, with advanced or metastatic disease in over 50%

of inflicted patients. For patients with pancreatic cancer after the diagnosis of malignant ascites, the median survival is reported to be 9 weeks. Recombinant human Ad-p53 injection (Gendicine®) is the first gene therapy medication, which was approved by the State Food and Drug Administration of China (SFDA) for head and neck squamous cell carcinoma (HNSCC) patients in 2003. Gendicine® is administered normally through intratumoral injection. We reported our experience using combination of chemotherapy (gemcitabine plus cisplatin) plus Ad-p53 and regional thermotherapy to treat advanced pancreatic cancer with ascites. **Methods:** Between 12/2005 and 12/2009, after receiving abdominocentesis and ascites drainage, we had 17 patients (with untreated, non-resectable, advanced or metastatic pancreatic carcinoma and malignant ascites) administered of Ad-p53 intraperitoneal perfusion (IP) at 1×10^{12} VP on days -1, 6 and 13. Then, these patients received cisplatin intraperitoneal perfusion at 30mg/m² and gemcitabine at 800–1,000 mg/m² IV for a duration of 30 minutes each session on days 1, 8, and 15 every 28 days. These patients also received 1 hour duration of regional hyperthermia treatment, every 28 days. The equipment used was 41–42°, SR 1000 tumor hyperthermia system from Beijing Xianke Establish Science & Technology CO., LTD. We applied hyperthermia on upper abdomen of these patients, twice a week (d1, 4, 12, 15 and 19). We followed up to assess these patients for evidence of response (RECIST), toxicity (CTCAE v3.0), progression-free (PFS) and overall survival (OS). **Results:** 1. Seventeen patients enrolled for our assessment. Median age was 66 years (range, 34 to 72 years), and male-to-female ratio was 10:7. Among the 17 patients, 6 patients had locally advanced diseases, and 11 patients had metastatic disease. 2. Performance status was 0 for 2 patients, PS 1 for 8 patients and PS 2 for 7 patients. 3. Forty two cycles were administered. 4. Findings: These patients were inflicted with common grade 3 and 4 toxicities (10% to 20%) with symptoms including nausea, vomiting and thrombopenia. Grade 3 lethargy and grade 3 or 4 neutropenia occurred in 29% and 35% of patients, respectively. Grade 2 abdominal pains were found in 48% of patients and grade 1 or 2 fever was found in 53% of patients. No grade 3 GI hemorrhage/ diarrhea, or pneumonitis occurred. Seven partial responses were observed. Median overall and progression-survival times (all patients) were 17.5 and 14.2 weeks, respectively. **Conclusion:** Ad-p53 plus Gemcitabine and intraperitoneal cisplatin in combination with regional thermotherapy was well tolerated in our patients with advanced pancreatic cancers with ascites. Results from our clinical findings find the combined chemotherapy and thermotherapy was effective in prolonging progression-survival times of patients of pancreatic cancers with ascites.

640. Imaging and Treatment of Pancreatic Cancer Using an Oncolytic Vaccinia Virus Carrying the Human Sodium Iodide Symporter

Dana Haddad,^{1,2} Nanhai Chen,³ Qian Zhang,³ Chun-Hao Chen,¹ Yong A. Yu,³ Lorena Gonzalez,¹ Jochen Stritzker,^{2,3} Jason Aguilar,³ Susanne G. Carpenter,¹ Joshua Carson,¹ Joyce Au,¹ Arjun Mittra,¹ Mithat Gonen,¹ Pat B. Zanzonico,⁴ Aladar A. Szalay,^{2,3,5} Yuman Fong.¹

¹*Department of Surgery, Memorial Sloan-Kettering Cancer Center, New York, NY;* ²*Department of Biochemistry, University of Wuerzburg, Wuerzburg, Bavaria, Germany;* ³*Genelux Corporation, San Diego, CA;* ⁴*Departments of Medical Physics and Radiology, Memorial Sloan-Kettering Cancer Center, New York, NY;* ⁵*Department of Radiation Oncology, University of California San Diego, San Diego, CA.*

Introduction: Oncolytic viruses show great promise for treating cancer. However, to assess therapeutic efficacy and potential toxicity, a non-invasive imaging modality is needed. This study aimed to determine if a vaccinia virus, GLV-1h153, carrying the human sodium iodide symporter (*hNIS*) kills pancreatic cancer and facilitates deep

tissue imaging via enhanced radioiodide uptake. **Methods:** GLV-1h153 was modified from parental vaccinia virus to carry *hNIS* via homologous recombination. GLV-1h153 was tested against human pancreatic cancer cell line Panc-1 for replication and killing via cytotoxicity and plaque assays. Expression and transportation of *hNIS* in infected cells was evaluated using Western blot and immunofluorescence. Cellular uptake of radioiodide was determined using radiouptake assays. In vivo efficacy, safety, and biodistribution were then investigated in pancreatic xenografts in nude mice, with infection in tumors verified via histology and optical imaging. Finally, deep tissue imaging was assessed via ^{124}I administration and positron emission tomography (PET). **Results:** GLV-1h153 infected, replicated in, and killed Panc-1 cells. GLV-1h153 provided dose-dependent levels of *hNIS* protein expression in infected cells with successful transport to the cell membrane, thus enhancing *hNIS*-specific radiouptake ($P < 0.05$). In vivo, GLV-1h153 was safe and effective in regressing pancreatic cancer xenografts after both intratumoral (IT) and intravenous (IV) injection ($P < 0.001$). Finally, GLV-1h153 facilitated imaging of virus replication in tumors via PET with a mean % injected dose of 3.82 ± 0.46 two days after IT injection ($P < 0.05$) (Figure). **Conclusion:** GLV-1h153 is an effective oncolytic agent against pancreatic cancer and induces the expression and transport of *hNIS*, enhancing radiouptake and thus facilitating deep tissue imaging via PET. Therefore, GLV-1h153 is a promising new candidate for treating pancreatic cancer and non-invasively imaging viral therapy.

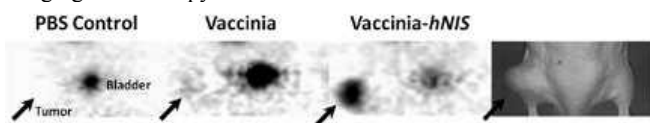

641. TK.007 Mediates Superior Killing Efficiency and Bystander Effect in Cancer Suicide Gene Therapy

Ellen Preuss,^{1,3} Alexander Muik,^{2,4} Kristoffer Weber,³ Jürgen Otte,¹ Dorothee von Laer,⁴ Boris Fehse.³

¹Frankfurter Stiftung für Krebskranke Kinder, Frankfurt am Main, Germany; ²Georg Speyer Haus, Frankfurt am Main, Germany; ³Research Dept. Cell and Gene Therapy, Clinic for Stem Cell Transplantation, University Medical Centre Hamburg-Eppendorf, Hamburg, Germany; ⁴Virology Section, Medical University Innsbruck, Innsbruck, Austria.

The Herpes simplex virus thymidine kinase/ganciclovir system (HSVtk/GCV) is currently the most widely used suicide gene/prodrug combination in clinical suicide gene therapy. We recently introduced a novel gene variant, TK.007, which demonstrated superior performance compared to other HSVtk variants in adoptive immune therapy settings. Now, we have systematically investigated the applicability of TK.007 for cancer suicide gene therapy. To do so, we transduced tumour cell lines derived from different neoplasias (glioblastoma, melanoma, lung cancer, colon cancer) with Lentiviral Gene Ontology (LeGO) vectors encoding TK.007 or the wild-type, splice-corrected (sc)HSVtk together with an eGFP/neo marker. Transduced cells were selected to high purity by G418 application. Functional activities of TK.007 and scHSVtk were directly compared by treatment of those selected cells with GCV at various doses. We found significantly more efficient tumour-cell killing for TK.007 at no less than ten times lower ganciclovir doses in all investigated tumour tissues. Moreover, using two specifically adapted assays we detected a significantly, app. 10-times stronger bystander effect for TK.007 compared to scHSVtk. Superior in vitro efficacy of TK.007 was finally confirmed in a xenograft glioblastoma (G62) mouse model in NOD/SCID mice. In this in vivo model, treatment of subcutaneous scHSVtk-positive tumours with low (10 mg/kg) or standard (50 mg/

kg) ganciclovir doses resulted only in short-term, transient growth inhibition. In striking contrast, in the TK.007 group all animals achieved continuous complete remission after standard-dose and even after low-dose ganciclovir treatment. Taken together our data demonstrates a strong supremacy of TK.007 over the today widely used splice-corrected HSVtk gene. We therefore suppose that TK.007 is an excellent candidate for cancer suicide gene therapy.

642. Human Antrum Mucosal Protein 18 Gene Transfer for the Prevention of Radiation-Induced Oral Mucositis in Mouse Model

Changyu Zheng,¹ Ana P. Cotrim,¹ Abraham N. Sunshine,¹ Fernando Velasquez,¹ Anastasia Sowers,² James B. Mitchell,² Bruce J. Baum.¹
¹MPTB/NIDCR, NIH, Bethesda, MD; ²RBB/NCI, NIH, Bethesda, MD.

A common side effect of treating head and neck cancers with radiation is oral mucositis. At present clinically, there is no FDA-approved agent available to prevent or reduce the severity and duration of this condition. Human antrum mucosal protein 18 (hAMP 18) is a gastric antrum mucosal protein with mitogenic and motogenic properties for epithelial cells. Based on its physiological properties, we hypothesized that the secretion of hAMP 18 into saliva from vector-transduced salivary epithelial cells could prevent oral mucositis resulting from radiation therapy. A serotype 5 adenoviral vector encoding hAMP18 was constructed: AdLTR₅EF1a-hAMP18 (a hybrid vector with potentially longer transgene expression; see Zheng et al, Mol Ther, 2008). Either this experimental vector, or a control vector (Adcontrol; lacking a transgene cassette), was administered to the submandibular glands of female C3H mice (8 weeks old; 10^{10} particles/gland) by retrograde ductal instillation. One day after vector delivery, mice received head and neck irradiation in fractionated doses (8 Gy fractions for 5 days), and blood, saliva, submandibular glands and tongue were collected on day 10. Results from 3 separate experiments (total $n=48$ mice) showed that the hAMP18-expressing vector, clearly prevented the formation of ulcers on mouse tongues, while Adcontrol treatment was without benefit. Transgenic hAMP18 protein was found in serum and aqueous submandibular gland extracts, but not in saliva, using Western blot analyses. The growth of the model squamous cell carcinoma, SCC VII, was unaffected by hAMP18 gene transfer \pm radiation. This initial proof of concept study suggests that transgenic hAMP18 secreted from vector-transduced salivary glands potentially may provide a novel means to prevent radiation-induced oral mucositis.

643. Combined, but Not Individual, Adenoviral Delivery of p19Arf and Interferon-beta Induces Massive Cell Death in a Mouse Model of Melanoma

Bryan E. Strauss,¹ Christian A. Merkel.¹
¹Viral Vector Group, Lab. of Genetics and Molecular Cardiology/LIM 13, Heart Institute-University of Sao Paulo School of Medicine, Sao Paulo, Brazil.

Background: Our previous work has shown that viral vectors that employ a p53-responsive promoter to drive transgene expression offer several advantages. We have observed high-level expression, even higher than the CMV promoter, and we have shown that these vectors can be reliably used to transfer p53 or its functional partner, p19Arf. Our strategy creates positive feedback between the therapeutic gene and the viral expression mechanism. Malignant melanoma cells typically retain wild-type p53 in a non-functional state due in part to the loss of p19Arf. Data have shown that interferon- β (IFN β) can activate the transcription of p53 and interact with the Arf pathway as well. By using a p53-driven adenovirus, we sought to combine the action of p53, p19Arf and IFN β for the treatment of malignant

melanoma in an immune-competent mouse model. **Methods:** p53-responsive AdPG adenoviral vectors containing p19Arf or IFN β were produced and expression verified by immunofluorescence and ELISA. *In vitro* evaluation of the antiproliferative effect of single or co-transduction of B16F10 cells (B16, p53 wild-type) was done by FACS after annexin/PI staining. C57/BL6 mice were injected subcutaneously with B16 cells and tumors were allowed to develop (~0.5 cm²). At this point, three consecutive intra-tumor injections (3 day interval between injections) of individual or combined adenoviral vectors were performed. Animals were then sacrificed and tumors collected and analyzed. **Results:** We observed reliable expression of the transgenes in a p53-dependent manner. Strikingly, the co-transduction with p19Arf and IFN β vectors resulted in massive cell death consistent with apoptosis, whereas the transfer of individual genes was much less effective. *In situ* gene therapy of subcutaneous tumors in an ectopic mouse model showed that p19Arf slowed, but did not prevent, tumor progression. In contrast, IFN β gene transfer, either alone or in combination with p19Arf, resulted in greatly reduced tumor volumes. Moreover, the number of TUNEL-positive cells was greatly enhanced only when the combination of p19Arf and IFN β was used as compared to either the controls or the single gene transfer conditions. **Conclusion:** The combination of IFN β and p19ARF proved to be more effective in inhibiting proliferation of B16 cells than either treatment alone, both *in vitro* and *in vivo*. The use of p53-responsive vectors for the restoration of p19ARF expression in the presence of IFN β may represent a potential strategy for melanoma tumor suppression. Work is underway to evaluate the potential of IFN β to activate the immune system and prevent metastases in this treatment model. This work was supported by FAPESP.

644. Imaging Nitroreductase (*nfnB*) Reporter Gene Expression in Living Animals

Thillai V. Sekar,¹ Srabani Bhaumik,² Jeannette Depuy,² June Klimash,² Ramasamy Paulmurugan.¹

¹Dept. of Radiology, School of Medicine, Stanford University, Palo Alto, CA; ²GE Global Research, GE, Niskayuna, NY.

Gene directed enzyme prodrug therapy (GDEPT) is a promising suicide gene therapy approach to enhance selective cancer chemotherapy. Nitroreductase (NTR)/CB1954 GDEPT system has been thoroughly investigated and is currently in phase I clinical trial. However there is no non-invasive imaging method available to evaluate the therapeutic efficacy of this system in living animals. Here, we developed a safe, sensitive and reproducible non-invasive imaging method to monitor NTR transgene expression that would allow quantitative assessment of both therapeutic efficacy and diagnostic outcome of NTR/CB1954 prodrug therapy. The bacterial Nitroreductase gene (*nfnB*) cloned from *E. coli* (K12) strain, in a eukaryotic expression vector under a constitutive CMV- promoter was used for the study. NTR gene expression efficiency was evaluated in transient and stably transfected mammalian cell lines (LS174T, SKOV3, MCF7 and 293T). A novel fluorescent imaging dye CytoCy5S (a Cy5-labeled quenched substrate of NTR enzyme) was investigated on these cancer cell lines *in vitro* and in NTR-transfected tumor-bearing animals *in vivo*. The substrate CytoCy5S produced Cy5-fluorescent signal only from cells transfected to express nitroreductase enzyme. For this study we used different optical imaging systems both *in vitro* (Incell Analyzer 1000, Nikon Eclipse TE2000-U fluorescent microscope, Olympus IX81 time-lapsed microscope and FACS) and *in vivo* (IVIS and eXplore Optix) to evaluate NTR gene function. Quantitative evaluation of fluorescent signal in stably transfected 293T cells after exposure to 100 ng/ml CytoCy5S for 60 min showed a log-order elevation in fluorescent signal compared to corresponding control cells.

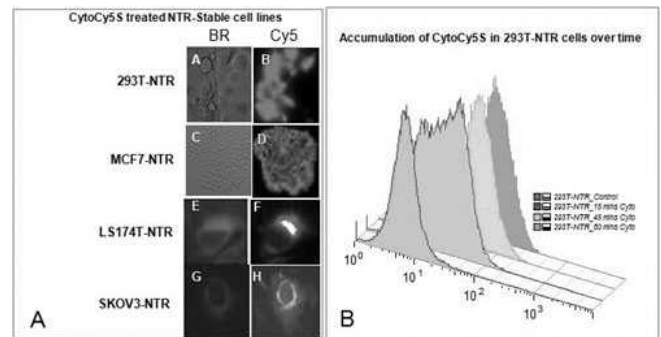

(A) Images of 293T, MCF7, LS174T and SKOV3 cell lines stably expressing NTR reporter gene imaged 1 hour after exposed to CytoCy5S, BR- bright field. (B) The kinetics of fluorescent CytoCy5S conversion and entrapment within the cells over time is recorded by FACS analysis.

The conversion and entrapment is dynamically recorded using a time-lapsed microscopy. Systemic and intratumoral delivery of CytoCy5S to NTR-expressing tumors in animals indicate steady and reproducible signals even 16 hours after-delivery.

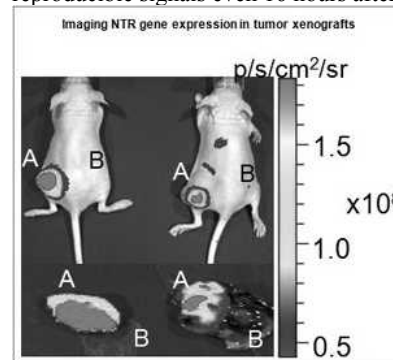

Tumor xenografts of 293T-NTR (A) and 293T (B) imaged 1 hour after CytoCy5S injection. The excised xenografts of 293T-NTR (A) and 293T (B) shows high signal when imaged *ex vivo*.

The animals imaged at different time points following substrate injection via different routes showed a gradual increase in the signal level over time from NTR-bearing tumor site and not from NTR-negative control tumors. Significant level of fluorescent signal is detected even after 8 days post-implantation of NTR positive stable cells. This is the first study to address visual monitoring and quantitative evaluation of NTR activity in small animals using CytoCy5S, and establishes the capability of NTR to function as an imageable reporter gene.

645. Dual-Therapeutic Reporter Genes Fusion for Enhanced Cancer Gene Therapy and Imaging

Ramasamy Paulmurugan,¹ Thillai V. Sekar,¹ Srabani Bhaumik.²
¹Radiology, Stanford University, Palo Alto, CA; ²GE Global Research, Niskayuna, NY.

Gene directed enzyme prodrug therapy (GDEPT) is a promising suicide gene therapy approach to enhance selective cancer chemotherapy. Herpes simplex virus thymidine kinase (TK) with ganciclovir (GCV), cytosine deaminase (CD) with 5-fluorocytidine (5-FC) and nitroreductase (NTR) with 5-(azaridin-1-yl)-2,4-dinitrobenzamide (CB1954) are three most promising suicide gene/prodrug combinations that are currently in different phases of clinical trials. TK and CD sensitize prodrugs GCV and 5-FC respectively and block DNA synthesis, whereas the NTR activated prodrug CB1954 intercalate with DNA and develop cytotoxicity. In this study we expressed TK and NTR in fusions to establish two different mechanisms of cell killing effect with their respective prodrugs in combinations to achieve efficient therapeutic value by lowering the toxicities associated with each prodrug. The TK and NTR fusions in two different orientations (NTR-TK and TK-NTR) linked with a flexible 10aa linker (GGGSGGGGS) were constructed and tested

by the study. The functional activities of TK and NTR were tested in HEK-293T cells stably expressing the fusion constructs of both orientations using ^3H -PCV-uptake (TK) and, CytoCy5S (NTR) fluorescent substrate based cell sorter analysis and fluorescent microscopy. Different dye based staining procedures (Calcein, PI and EtBr) were used for measuring the cell deaths and cell cycle arrests. The results showed functional NTR only from cells expressing TK-fused at the NH₂-terminus of NTR gene. TK was fully functional in TK-NTR fusion and ~60% active in cells expressing NTR-TK fusion.

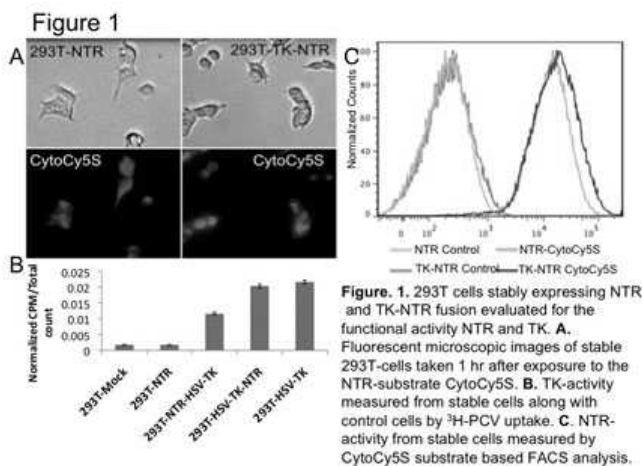

Figure 1. 293T cells stably expressing NTR and TK-NTR fusion evaluated for the functional activity NTR and TK. **A.** Fluorescent microscopic images of stable 293T-cells taken 1 hr after exposure to the NTR-substrate CytoCy5S. **B.** TK-activity measured from stable cells along with control cells by ^3H -PCV uptake. **C.** NTR-activity from stable cells measured by CytoCy5S substrate based FACS analysis.

The HEK-293T cells stably expressing equal amount of functional NTR proteins from both NTR alone and TK-NTR-fusion constructs were used for further therapeutic evaluations using prodrugs GCV and CB1954 separately or in combinations. By combining TK-NTR fusion we achieved significantly ($p < 0.02$) higher levels of therapeutic efficiency with low doses of each prodrugs (GCV: 1 g/ml + CB1954 5 M) than the similar effects normally achieved using individual genes with their respective prodrugs at 10 g/ml (GCV) and 25 M (CB1954).

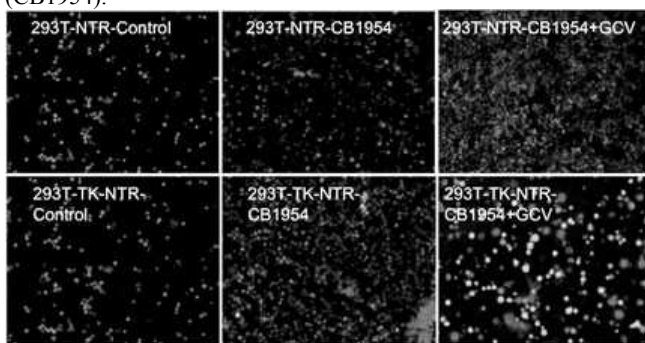

Figure 2. 293T cells stably expressing NTR and TK-NTR fusion evaluated for prodrug (CB1954 and GCV) mediated therapeutic effect. The 293T-NTR and 293T-TK-NTR cells were treated either with CB1954 (10 μM) alone or CB1954 (10 μM) in the presence of 1 $\mu\text{g}/\text{ml}$ of GCV for three days and measured for live and dead cells by using Calcein AM (live cells)/EtBr-dimer (dead) dye based staining system.

Similarly the cell cycle arrest started at early time points when compare to cells exposed to each prodrug separately. The in vitro evaluation of NTR with CytoCy5S fluorescent substrate along with the well-established microPET imaging of TK using substrate ^{18}F -FHBG would add further values for the pre-clinical and clinical evaluation of this GDEPT fusion system before its translational human applications.

Neurologic & Ophthalmic Gene & Cell Therapy

646. Dramatic Phenotypic Improvement after Adeno-Associated Virus Gene Therapy in a Feline Model of Sandhoff Disease

Aime K. Johnson,¹ Allison M. Bradbury,² Julian Arthur,³ Victoria J. Jones,² Misako Hwang,² Stanley G. Leroy,⁴ Nancy E. Morrison,² Jacob A. Johnson,¹ Peter W. Christopherson,⁵ Nancy R. Cox,² Henry J. Baker,² Thomas N. Seyfried,³ Miguel Sena-Esteves,⁴ Douglas R. Martin.²

¹Department of Clinical Sciences, Auburn University College of Vet Med, Auburn, AL; ²Scott-Richey Res Ctr/Dept Anat, Phys, Pharm, Auburn University College of Vet Med, Auburn, AL;

³Department of Biology, Boston College, Chestnut Hill, MA; ⁴Gene Therapy Center, University of Massachusetts Medical School, Worcester, MA; ⁵Department of Pathobiology, Auburn University College of Vet Med, Auburn, AL.

Deficiency of lysosomal hexosaminidase (Hex) causes storage of GM2 ganglioside in the central nervous system, resulting in progressive neurological deterioration and death, often in infancy. AAV gene therapy has been extraordinarily successful in the GM2 mouse model, (*Proc Natl Acad Sci USA*, 103:10373, 2006), resulting in substantial clearance of storage material and extension of life span from ~4 months (untreated) to 24 months (AAV-treated). The mouse brain is ~1000 times smaller and much less complex than the human brain, however, and it is imperative to test AAV gene therapy in an authentic GM2 animal model with a larger, more complex brain before initiation of human clinical trials. In the current study, monocistronic AAV2/rh8 vectors expressing feline Hex α and β subunit cDNAs (2e12 g.c. per vector) were injected bilaterally into the thalamus and deep cerebellar nuclei of 1-month old GM2 cats (disease onset ~2 months). In treated brains collected 16 weeks post-injection, Hex activity was distributed throughout the entire anterior-posterior axis of the cerebrum (2.7-46.8 fold normal) and cerebellum (6.9-32.9 fold normal). GM2 ganglioside storage was drastically reduced or absent in many areas of the treated brain. Little evidence of an inflammatory cellular infiltrate was observed in H&E-stained brain sections, though serum antibody titers to the AAV vectors were pronounced (~1:65,000). Long-term therapeutic experiments in 1-month old GM2 cats were performed using the same vector dose and route of delivery. Currently, 4 AAV-treated GM2 cats are 12, 11, 9 and 9 months of age (untreated humane endpoint, 4.5 ± 0.5 months, $n=11$). Though treated GM2 cats demonstrate varying degrees of hind limb weakness, all are ambulatory and self-sufficient, with little or no evidence of the debilitating whole body intention tremors and balance difficulties typical of untreated GM2 cats. In addition, treated GM2 cats demonstrate normalization of MRI brain lesions found in untreated cats. As anticipated, evidence of disease correction in the periphery has been minimal, with extensive vacuolation and undetectable Hex activity in peripheral blood mononuclear cells. Other than serum antibody titers, no evidence of vector toxicity has been documented. GM2 cats treated with a ten-fold lower dose are currently 7.6, 7.1, 7.1 and 6.7 months of age. Though still ambulatory and self-sufficient, GM2 cats treated with the low dose of AAV demonstrate obvious intention tremors. These translational studies provide strong support for the initiation of AAV-based clinical trials for human GM2 gangliosidosis.

647. Intracarotid Delivery of AAV9 Vector Is a Powerful Method for Gene Delivery to the Primate Brain

Krystof Bankiewicz,¹ Ernesto Aguilar Salegio,¹ John Bringas,¹ Adrain Kells,¹ Kevin Foust,² John Forsayeth,¹ Brian Kaspar.²
¹Neurological Surgery, University of California, San Francisco, San Francisco, CA; ²The Research Institute at Nationwide Children's Hospital, Ohio State University, Ohio, OH.

Introduction: Neurological gene therapy is now the most prominent field of clinical application of this powerful technology. Over the recent years delivery of AAV vectors into the central nervous system (CNS) has gained considerable interest in the field of gene therapy. In an effort to reduce the invasiveness of direct parenchymal injections and still provide adequate transduction of neuronal populations within non-human primate (NHP) brain, we infused AAV9-GFP via the internal carotid artery (ICA). **Method:** Cynomolgus NHPs (n=3; No. 1664, 1825, 1412) were used in this study. Delivery of AAV9-GFP was performed via the right ICA. Animals received a single ICA infusion of AAV9-GFP (1e13 vg/mL) in a total infusate volume of 11, 21 or 40 mL. Biochemical screening of serum and CSF samples was performed prior, during and after vector treatment. All NHPs were monitored daily and euthanized 21 days after AAV9 administration. **Results:** ICA delivery of AAV9-GFP resulted in the global distribution and expression of the GFP transgene within the NHP brain with widespread levels of transduction of neuronal as well as glial populations. Interestingly, no GFP+ neurons were found in the brain of the NHP (No. 1825) with positive antibody titer against the AAV9 capsid, although some GFP+ glial cells still remained present. **Conclusion:** Delivery of therapeutic genes via the ICA route is a very powerful avenue for global gene delivery to the CNS particularly in conditions where a widespread gene deficit is present. The presence of circulating antibodies against AAV9 capsid effectively neutralized transgene expression.

648. Zinc Finger Nuclease-Mediated Editing of Dominant Retinal Mutations in Mice

Ivette M. Sandoval,¹ Brandee A. Price,¹ Fung Chan,¹ Alecia K. Gross,² David L. Simons,¹ Jiuli Zhang,² Steve Zhang,³ David E. Paschon,³ William W. Hauswirth,⁴ Matthew H. Porteus,² Philip D. Gregory,³ Theodore G. Wensel,¹ John H. Wilson.¹
¹Biochemistry and Molecular Biology, Baylor College of Medicine, Houston, TX; ²Pediatrics, Stanford Medical School, Stanford, CA; ³Sangamo BioSciences Inc, Richmond, CA; ⁴Ophthalmology, University of Florida, Gainesville, FL; ⁵Vision Sciences, University of Alabama at Birmingham, Birmingham, AL.

Zinc finger nucleases (ZFNs) are artificial proteins engineered to introduce double-strand breaks at specific DNA sequences. To test their potential for therapeutic gene repair in neurodegenerative diseases of the retina, we generated knock-in mouse lines that allow ready detection of individual gene-repair events. Mice were designed so that one copy of the mouse rhodopsin gene, which encodes the most abundant protein in rod photoreceptor cells, was substituted by a mutant form of the human rhodopsin gene with an EGFP fusion at the C-terminus. Three of these knock-in mouse lines encode point mutations (P23H, Q64X, and Q344X) that are known to cause Autosomal Dominant Retinitis Pigmentosa (ADRP) in humans. Morphological, biochemical, and functional characterization shows that the heterozygotes of our knock-in mice are very similar to wild type. These mice display very little cell death over time, as expected because of the rods express low levels of mutant protein, due to hairpin elements in the 5'UTR of the mRNA. P23H-hRho-GFP mice express the full length mutant protein, whose fluorescence revealed substantial mislocalization to the inner segment and nuclear region of photoreceptors. Treatment with rAAV-ZFNs led to ablation of

GFP fluorescence, presumably due to DNA repair by the error-prone nonhomologous end joining (NHEJ) pathway, which usually causes frame shifts and premature termination. In contrast, retinas of Q64X-hRho-GFP and Q344X-hRho-GFP mice have very few fluorescent rods because the rhodopsin gene product is truncated prior to the C-terminus. Treatment with rAAV-ZFNs plus rAAV containing DNA without the truncation mutations, designed to serve as a template for repair by homologous recombination (HR), resulted in an approximate 10,000-fold increase in GFP-positive rods at 6 weeks post injection. Our results demonstrate that ZFNs can be designed and used to introduce targeted DSBs into the genomes of photoreceptor cells; moreover, these terminally differentiated neurons are capable of repairing DSBs by either NHEJ or HR. With further optimization, this approach could be advanced to therapeutically beneficial levels and provide a new way to the treat retinal and other neurological diseases caused by dominant mutations.

649. rAAV-Mediated, Systemically Delivered and miRNA-Regulated CNS Gene Transfer Effectively Correct Metabolic and Psychomotor Defect, Alleviate Neuropathology, and Prolong Survival of *ASPA*^{-/-} Mice with Canvan Disease

Seemin Ahmed,^{1,2} Sylvia Szucs,⁵ Hongwei Zhang,^{1,2} Qin Su,¹ Ran He,¹ Miguel Sena-Estevés,^{1,3} Terence Flotte,^{1,4} Reuben Matalon,⁵ Guangping Gao.¹

¹Gene Therapy Center, UMass Med Sch, Worcester;

²Microbiol&Physiol, UMass Med Sch, Worcester; ³Neurol, UMass Med Sch, Worcester; ⁴Pediatrics, UMass Med Sch, Worcester;

⁵Pediatrics, Univ. of Texas Med Branch, Galveston.

Canavan disease (CD) is a rare, inherited, and fatal childhood leukodystrophy. Caused by autosomal recessive mutations in the aspartoacylase gene (*ASPA*), the *ASPA* deficiency in CD patients leads to elevated N-Acetyl-Aspartic Acid (NAA) and spongy degeneration of white matter (WM) throughout the entire CNS, producing severe psychomotor retardation and early death. The *ASPA*^{-/-} KO mouse model authentically mimic the neuropathology and clinical manifestation of CD patients. Currently, there is no effective treatment available for CD. rAAV gene therapy is an attractive strategy for treating CD. An earlier attempt in the CD gene therapy by direct injections of rAAV2 into brain parenchyma generated limited success, possibly due to the compartmentalization of NAA biosynthesis and catabolism, inadequate transduction efficiency of rAAV2 and limitations of localized intraparenchymal vector delivery. However, recent reports and our study revealed that i.v. delivery of some novel rAAVs are highly efficient in transducing the CNS by crossing the blood-brain-barrier. Additionally, we exploited endogenous miRNAs to regulate expression of i.v. delivered rAAV, resulting in 100-fold reduction of transgene expression in the peripheral tissues (e.g. liver, muscle, heart, etc) but not in the CNS. In a proof-of-concept gene therapy study, we harnessed those i.v. deliverable novel rAAVs to target the CNS globally to treat diffused WM degeneration in CD mice. Single i.v. injections of *ASPA* vector to the neonatal CD mice corrected metabolic defect, psychomotor malfunction and other disease phenotypes, and prolonged survival. While untreated CD mice started showing growth retardation, psychomotor malfunction in the 2nd wk after birth and uniformly died soon after weaning, the treated mice began to gain weight 2 wks after vector injection and nearly caught up with their heterozygous littermates within 7 -8 weeks. Unlike CD mice, the mobility of the treated animals was similar to Wt littermates. Preliminary data from rotarod test on the treated mice showed no significant differences in the latency time among the treated CD mice and their age-matched Wt littermates, suggesting that gene therapy might have cured the ataxia, a typical neuromuscular symptom of CD. Biochemical characterization indicated reduction of NAA levels in the urine samples and restoration of *ASPA* activity

in their brain and kidney tissues. More importantly, mitigation of the biochemical and clinical phenotypes was well correlated with globally ameliorated histopathology in not only the brain, spinal cord but also in the peripheral tissues such as kidney, suggesting that CD is not just a CNS disorder. Our findings hold great promise for future clinical development of effective and safe gene therapeutics for CD.

650. Suppression of HTT in the Rhesus Macaque: Behavioral, Histological and Molecular Analysis of RNAi as a Therapy for Huntington's Disease

Jodi L. McBride,¹ Mark R. Pitzer,¹ Ryan L. Boudreau,² Brett D. Dufour,¹ Sergio R. Ojeda,¹ Beverly L. Davidson.²

¹Neuroscience, ONPRC, Beaverton, OR; ²Internal Medicine, U of Iowa, Iowa City, IA.

To date, a therapy for the neurodegenerative disorder, Huntington's disease (HD), remains elusive. HD is characterized by cell loss in the basal ganglia, with particular damage to the putamen, an area of the brain responsible for initiating and refining motor movements. Accordingly, patients are plagued by a hyperkinetic disorder characterized by involuntary movements of their arms and legs. Currently, there are no treatments that significantly impact the symptoms, nor time course of the disease. RNA interference (RNAi) has offered renewed therapeutic potential for this disorder, as suppressing the disease-causing gene prevents formation of the toxic mutant protein responsible for HD. While allele-specific RNAi would be ideal, no prevalent polymorphism resides on the mutant gene alone that would allow for specific targeting of the HD gene (HTT). Therefore, efforts have been underway to assess the safety and efficacy of partially silencing both mutant and wildtype alleles. Our lab has previously shown that non-allele specific RNAi is safe and neuroprotective in rodent models of HD. Before RNAi can be tested in the clinic as a therapy for HD, it is imperative that the safety of RNAi be tested in a larger animal whose brain size and neurophysiology more closely resemble that of a human. Here, we have assessed the safety and efficacy of a partial reduction of HTT in the rhesus macaque brain. Eight macaques were injected into the putamen with an adeno-associated viral vector encoding either a microRNA targeting HTT (AAV-miHD1, n=4) or a control miRNA (AAV-miSAFE, n=4). Additional monkeys were injected with AAV expressing the control gene, green fluorescent protein (AAV-eGFP, n=4). Behavioral assays of gross (motor rating scale and activity collars) and fine (Lifesaver Test of manual dexterity) motor skills showed no significant differences in AAV-miHD1 treated animals compared to controls ($p > 0.05$ between groups on all assays), suggesting that a partial suppression of the HD gene in the putamen does not lead to behavioral deficits. Six weeks post-injection, animals were euthanized and brains were removed for histological and molecular analyses. QPCR analyses of putamen samples showed a significant 45% reduction in rhesus HTT expression in AAV-miHD1 treated monkeys compared to AAV-miSAFE and AAV-eGFP control monkeys ($p < 0.01$), with no significant loss of DARPP-32 expression, a phosphoprotein expressed in putamen projection neurons, between groups ($p > 0.05$). Histological examination of brain sections showed no significant increase in GFAP+ astrocytes, nor Iba1+ microglia in AAV-miHD1 injected animals compared to controls. Nissl and NeuN-stained tissue sections through the putamen revealed normal neuroanatomical architecture and no loss of neurons in the putamen in animals from all 3 treatment groups. AAV-HDS1-treated animals showed no significant increase in CD4 or CD8 expression in the putamen. These results indicate that a partial reduction of HTT is well tolerated in the rhesus putamen, supporting RNAi as a potential therapy for HD.

651. Robust Motor Neuron Transduction Following Intrathecal Delivery of AAV9.GFP to Pigs

Thais Federici,¹ Jason S. Taub,¹ Steven S. Gray,² Stacey Foti,² Josh Grieger,² Chalonda R. Handy,¹ Eleanor M. Donnelly,¹ R. Jude Samulski,² Nicholas M. Boulis.¹

¹Department of Neurosurgery, Emory University, Atlanta, GA;

²Gene Therapy Center, University of North Carolina, Chapel Hill, NC.

Introduction: AAV9 has recently been shown to penetrate the blood-brain barrier via intravascular administration, making it a good candidate for diffuse gene delivery. However, the potential side effects of systemic delivery are unknown. Intrathecal vector administration may be more invasive than intravenous injections, but it requires far less vector and it can be performed on an outpatient basis, making it an ideal route of delivery for clinical translation. Methods: Twelve domestic farm pigs (< 15 kg) underwent a single level lumbar laminectomy with intrathecal catheter placement for vector delivery. Animals received either a local lumbar 1.5 ml vector injection, or three 0.5 ml injections at the cervical, thoracic, and lumbar regions of the spinal cord. A total of 1.5 ml of two concentrations of AAV9.Cbh.GFP (7.5 x 10E11 vg – 3 x 10E12 vg) was locally or diffusely delivered (n = 3/group). Animals were perfused and the tissue was harvested thirty days after treatment. Gene expression was assessed by anti-GFP immunohistochemistry along with diaminobenzidine (DAB) staining. Results: There was no observed morbidity associated with the laminectomy or intrathecal catheter placement required for subarachnoid vector delivery. AAV9.Cbh.GFP was capable of penetrating the pia, reaching motor neurons of the ventral horn and exiting motor rootlets, with limited off-target transduction. While a single lumbar injection resulted in gene expression limited to the lumbar segment of the spinal cord, three consecutive boluses via a temporary catheter resulted in diffuse transduction of motor neurons throughout the cervical, thoracic, and lumbar spinal cords. Analysis is ongoing to assess for toxicity and appropriate dosaging. Conclusions: We now present the first successful robust transduction of motor neurons in the spinal cord of a large animal via intrathecal gene delivery using an AAV serotype 9. Similarity in size and morphology between the swine and human spines and spinal cords renders the pig optimal for biodistribution studies. However, while intrathecal delivery in pigs requires a laminectomy, this procedure would be performed percutaneously in humans. These promising results can be translated to many neurologic disease processes requiring diffuse gene delivery.

652. Passive Immunization with an AAV Vector Expressing an Anti-Cocaine Antibody Shields the Brain from Systematically Administered Cocaine, Suppressing Cocaine-Induced Hyperlocomotion

Martin L. Hicks,¹ Jonathan B. Rosenberg,¹ Bishnu P. De,¹ Esther Z. Frenk,¹ Odelya E. Pagovich,¹ Jianping Qiu,¹ Stephen M. Kaminsky,¹ Neil R. Hackett,¹ Lisa M. Eubanks,² Kim Janda,² Sunmee Wee,² George Koob,² Ronald G. Crystal.¹

¹Weill Cornell Medical College, New York, NY; ²The Scripps Research Institute, La Jolla, CA.

Cocaine addiction is a worldwide problem for which there is no effective therapy. Based on the concept that anti-cocaine antibodies could bind and sequester cocaine in the serum, we hypothesized that an adeno-associated virus (AAV) gene transfer vector expressing high levels of an anti-cocaine antibody would prevent cocaine from reaching its cognate receptors in the brain, suppressing the behavioral stimulatory effects associated with cocaine. To test this hypothesis, we constructed AAVrh.10 α Coc, an AAVrh.10 vector that expresses a full length, high affinity, anti-cocaine antibody derived from the Fab fragment of the antibody GNC92H2. The vector, AAVrh.10 α Coc,

was administered intravenously (IV; 10^{11} genome copies) into mice and anti-cocaine antibody levels quantified by ELISA. At 12 wk, the anti-cocaine antibody reciprocal titers were $6.0 \times 10^4 \pm 9.6 \times 10^3$, with high affinity (determined by radioimmunoassay) for cocaine of 25 nM. To assess the ability of AAVrh.10 α Coc to shield the brain from administered cocaine, ^3H -cocaine was used to trace drug distribution. A cocaine challenge that induced high brain levels of cocaine within 1 min after administration in naive mice was reduced by 73% in AAVrh.10 α Coc treated mice ($p < 0.005$). The cocaine sequestered in the serum of AAVrh.10 α Coc-treated mice was 14.4-fold greater than that observed in naive mice ($p < 0.001$), with 78% of the serum cocaine bound to IgG in the AAVrh.10 Coc-treated mice. Consistent with these data, AAVrh.10 α Coc-treated-Balb/c mice prevented cocaine-induced hyperlocomotor activity. When naive mice challenged with 12.5 μg IV cocaine were placed in photobeam equipped activity chambers, they exhibited hyperactivity, with an ambulatory activity of 1810 ± 150 beam breaks over 15 min. In marked contrast, when mice vaccinated with AAVrh.10 α Coc 12 wk prior were challenged with 12.5 μg IV cocaine were placed in photobeam equipped activity chambers, they had ambulatory activity of 1310 ± 110 beam breaks ($p < 0.01$, vaccine + cocaine vs naive + cocaine) that was indistinguishable from naive mice administered PBS (1320 ± 120 beam breaks; $p > 0.4$ vaccine + cocaine vs naive + PBS). In summary, an AAVrh.10 vector expressing an anti-cocaine antibody can elicit persistent, high titers of anti-cocaine antibody that shields the CNS from parenteral administration of cocaine sufficient to prevent the cocaine from eliciting a hyperactive phenotype in the mice, a strategy that may be applicable to treating cocaine addiction.

653. Persistent Suppression of Ocular Neovascularization with a Single Intravitreal Administration of AAVrh.10BevMab, an Adeno-Associated Viral Gene Transfer Vector Coding for Bevacizumab

Yanxiong Mao,¹ Szilard Kiss,² Julie L. Boyer,¹ Andrew Carbone,¹ Jason G. Mezey,^{1,3} Stephen M. Kaminsky,¹ Donald J. D'Amico,² Ronald G. Crystal.¹

¹Genetic Medicine, Weill Cornell Medical College, New York, NY; ²Ophthalmology, Weill Cornell Medical College, New York, NY; ³Biological Statistics and Computational Biology, Cornell University, Ithaca, NY.

Pathological ocular neovascularization is the hallmark of age-related macular degeneration (AMD) and diabetic retinopathy (DR), two leading causes of blindness in the industrialized world with the prevalence of each expected to increase dramatically. Vascular endothelial growth factor (VEGF) plays an important role in the pathogenesis of both AMD and DR. Bevacizumab, a monoclonal antibody directed against all isoforms of human VEGF-A is efficacious for these disorders, but requires monthly intravitreal administration, with associated discomfort, cost and risk for adverse events. We hypothesized that a single intravitreal administration of an adeno-associated virus (AAV) vector coding for bevacizumab would result in persistent expression of bevacizumab in the eye and consequent suppression of VEGF-induced retinal neovascularization. To test this concept, we constructed an AAV rhesus serotype rh.10 vector coding for the heavy and light chains of bevacizumab (AAVrh.10BevMab) and assessed its ability to suppress neovascularization in a transgenic mouse model that overexpresses the human VEGF165 in photoreceptors (rho/VEGF mice). Western analysis demonstrated that AAVrh.10BevMab expressed bevacizumab, with specificity for only the human forms of VEGF. Intravitreal administration of AAVrh.10BevMab directed bevacizumab expression in the retinal pigmented epithelium. There was long-term ocular expression of bevacizumab, with levels of 4.5×10^2 pg bevacizumab/ μg total protein at 6 months after administration. The AAVrh.10BevMab-

treated homozygous rho/VEGF mice had significantly reduced levels of ocular neovascularization throughout the time of assessment, with a $90 \pm 4\%$ reduction in the neovascularization at 6 months following a single administration, the last time point examined. Thus, a single intravitreal administration of an AAVrh.10 vector encoding bevacizumab effectively suppresses VEGF-driven ocular neovascularization on a persistent basis, suggesting an alternative therapeutic option without the costs and risks associated with the multiple administrations required for the current conventional bevacizumab monoclonal drug delivery for AMD and DR.

AAV Experimental Therapeutics

654. Directed Evolution of AAV in Pig Airway Epithelia *In Vivo*

David D. Dickey,¹ Jamie Bergen,² Boulos Nassar,¹ Benjamin Steines,¹ Katherine J. D. A. Excoffon,³ David V. Schaffer,² Joseph Zabner.¹

¹Internal Medicine, University of Iowa, Iowa City, IA; ²Department of Chemical and Biomolecular Engineering, University of California, Berkeley, Berkeley, CA; ³Department of Biological Sciences, Wright State University, Dayton, OH.

We have previously developed an animal model of cystic fibrosis (CF) in pigs. The CF pig model demonstrates many of the disease characteristics of humans with CF, including lung disease. We therefore hypothesized that directed evolution of adeno-associated viruses could be used to generate a gene therapy vector for the lungs of the CF pig, and that this vector would be different from what is selected in human airway epithelial cultures. We used DNA shuffling and error-prone PCR of the *cap* genes of AAV1, AAV2, AAV4, AAV5, AAV6, AAV8, and AAV9, along with an AAV2 surface loop peptide insertion library to create a library of approximately 10^7 unique AAV capsid variants. This virus library was pre-selected *in vitro* in pig airway epithelial cultures for two rounds, followed by mutagenesis for further diversification, and then subjected to three rounds of selection *in vivo* in pigs. After three rounds of selection, viral recovery was increased 24-fold, suggesting an improvement in infection. We also used the virus library for 6 rounds of selection in cultures of pig and human airway epithelia, to determine whether there were different selective pressures *in vivo* and *in vitro* in pigs and humans. We recovered unique isolates from each selection protocol that were distinct from the isolates recovered from human airway. These results suggest that there are different selective pressures for successful viral infection *in vivo* in pigs and *in vitro* in pig and human airway epithelial cultures.

655. ERK Inhibition Substantially Improves Early Stage Mortality in Acute Pancreatitis: The First Report of AAV Vector-Mediated Gene Modulation in an Exocrine Pancreatic Disease

Zuobiao Yuan,¹ Deborah Williard,¹ Erik Twait,¹ Duraisamy Kempuraj,¹ Isaac Samuel.¹

¹Surgery, VA Medical Center and University of Iowa Carver College of Medicine, Iowa City, IA.

We present the first report where the adeno-associated virus (AAV) is used for *in vivo* gene modulation in an exocrine pancreatic disease. Using the AAV vector, we expressed the dominant negative (DN) form of extracellular regulated kinase (ERK) and observed a significant improvement in mortality in an original murine model of acute pancreatitis. In our novel model, acute pancreatitis is induced by ligation of the distal pancreatic duct (PD) and is associated with systemic inflammation, multiorgan dysfunction, and substantial mortality, along with ERK activation in the pancreas and other organs. Diseased-treated mice received AAV8.DN.ERK (3e12 VGP i.p.;

n=20) 2 wks prior to midline laparotomy and duct ligation (PD+DN.ERK). Diseased-controls received either AAV8.GFP (3e12 VGP i.p. 2 wks before ligation; n=17) or no virus (n=32).

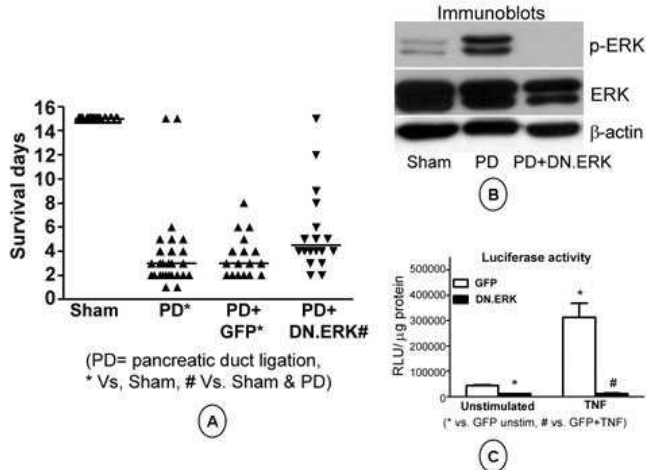

Sham-operated controls had no mortality until elective euthanasia after 15 days. Diseased-controls (PD or PD+GFP) showed median mortality of 3 days irrespective of GFP expression. AAV8.DN.ERK pretreatment (PD+DN.ERK) significantly diminished the mortality with a median mortality of 4.5 days, i.e., 50% longer median life expectancy ($p < 0.05$; Gehan Wilcoxon test). By postoperative day 3, diseased groups had 59-65% mortality, while the DN.ERK-treated group had a mere 20% mortality (Fig. 1A). We confirmed expression of DN.ERK in the pancreas by real time PCR and immunoblotting; we saw marked attenuation of ERK activation in pancreata of DN.ERK pretreated mice (Fig. 1B). For functional evidence of DN.ERK expression, separate mice were pretreated with AAV8.NF- κ B.Luciferase and coinfectd with either AAV8.GFP or AAV8.DN.ERK; after 2 wks the pancreas was excised, acinar cells were isolated in primary culture, and stimulated with 10 ng/ml TNF- α . Luciferase assay showed a significant limitation of TNF- α -stimulated increases in NF- κ B-dependent gene transcription in mice expressing DN.ERK, compared to GFP controls ($p < 0.05$; ANOVA)(Fig. 1C). In separate studies using AAV8.GFP i.p., immunoblotting detected peak GFP expression in the pancreas after 2 wks that plateaus in 3 wks; GFP was also expressed in the liver but not the lung or kidney. Immunohistochemistry confirmed GFP expression in pancreatic acinar cells and H&E stain showed absence of pancreatic edema or white blood cell infiltration. Conclusions: Using an original experimental model and a novel gene modulation technique, we have shown that ERK plays an important role in the pathogenesis of acute pancreatitis and its associated mortality. The substantial improvement in survival during the first 3 days (80% survival in the treated group versus 35-41% survival in diseased groups) following ERK inhibition in this model emphasizes a distinct role for ERK in the early phase of disease pathogenesis.

656. Transduction of Non-Human Primate Retina with Intravitreally Administered AAV Vectors of Different Serotypes: Investigations into Inflammation and Possibility of Treatment of Contralateral Eye

Michael J. Lukason,¹ Elizabeth A. Barry,¹ Timothy MacLachlan,² Samuel C. Wadsworth,¹ Abraham Scaria.¹

¹Molecular Biology, Genzyme, Framingham, MA; ²Translational Sciences, Preclinical Safety, Novartis Institutes for BioMedical Research, Cambridge, MA.

We have demonstrated previously that intravitreal (IVT) administration of adeno associated virus serotype 2 (AAV2) vectors

in the monkey eye is an effective method for transducing retinal cells with transgene expression observed predominantly in transitional epithelium, retinal ganglion cells and muller cells. However we did observe a mild inflammatory response to high doses (2E10 vg) of AAV2 vector. We wanted to test the possibility that the vitreous humor might affect the ability of the virus to diffuse freely and this might affect the extent of retinal transduction and might affect the generation of inflammation. To address this, AAV2-EGFP vector was intravitreally administered to the right eye of Cynomolgus monkeys to either the central vitreous or the peripheral vitreous. We found that the exact IVT site of vector injection did not change the level and location of EGFP expression nor were there any differences observed in the occurrence of the vitreal inflammation, which was very mild and transient in this experiment. GFP expression was detected in transitional epithelium, optic nerve, retinal ganglion cells, and also including the macular cells surrounding the fovea. This gene transfer occurred in spite of the presence of preexisting anti AAV2 titers in the serum at the start of the study. It has been reported that high titers of systemic anti-AAV antibodies can inhibit retinal transduction of AAV vectors delivered by the IVT route. Three months following IVT AAV2 administration to the right eye, high levels of anti-AAV2 antibodies were measured in the serum and in the aqueous humor of treated eyes but were absent in the contralateral untreated eyes. Re-administration of AAV2 to the previously treated eye did not result in detectable transgene expression. However, administration of AAV2 to the previously un-treated contralateral eye was successful in 1 out of 6 eyes. We also determined that administering an AAV5 pseudotyped vector to the contralateral eye resulted in successful transgene expression in cells in the macular region in 2 out of 3 eyes. This data suggests that AAV vectors can be administered intravitreally to subjects with pre-existing systemic anti-AAV antibodies and that treatment of the contralateral eye with a different serotype vector is possible.

657. AAV5 Mediated Exendin-4 Transduction of Salivary Glands in Mouse and Rat Obese Models Results in Robust Systemic Secretion of Exendin-4 and Improvement of Metabolic Parameters

Giovanni Di Pasquale,¹ Ilaria Dicembrini,² Changyu Zheng,¹ Drew Michael,¹ Laura Raimondi,³ Andrea Cozzi,³ Andrea Loreto,³ Elena Manni,³ Silvia Berretti,³ Claudio Pagano,⁴ Roberto Vettor,⁴ Josephine M. Egan,⁵ Bruce J. Baum,¹ Carlo Maria Rotella,² John A. Chiorini,¹ Edoardo Mannucci.²

¹Molecular Physiology and Therapeutics Branch, NIDCR/NIH, Bethesda; ²Section of Endocrinology, Department of Clinical Pathophysiology, University of Florence, Florence, Italy; ³Section of Pharmacology, University of Florence, Florence, Italy; ⁴Section of Endocrinology, University of Padova, Padova, Italy; ⁵National Institute on Aging, NIH, Baltimore, MD.

Glucagon-like peptide 1 (GLP-1), a hormone mainly produced in a nutrient-dependent manner by gastrointestinal endocrine L cells, enhances glucose-dependent insulin secretion and inhibits food intake, gastric emptying, and glucagon release, thus promoting the maintenance of normal glucose homeostasis. In type 2 diabetic patients, chronic administration of native GLP-1, via continuous infusion or repeated subcutaneous injection, reduces fasting and postprandial blood glucose and decreases HbA1c in association with a modest, but significant weight loss. Exendin-4 (Ex-4), isolated from the salivary secretion of the lizard Gila Monster, is a GLP-1 receptor agonist which, because of its molecular structure, is considerably more resistant than native GLP-1 to degradation by dipeptidyl-peptidase-4. Exenatide (the synthetic form of Ex-4) significantly improves glycaemic control and causes weight loss in type 2 diabetic patients, requiring a twice daily subcutaneous administration. In this project we studied the effect of exendin-4 expressed by an AAV5-Ex-4 vector in

salivary glands (SGs) of obesity/metabolic syndrome animal models such as Diet Induced Obesity (DIO) mice and Zucker fa/fa rats. SGs are recognized as a promising potential target for gene therapy in some endocrine disorder, exhibiting several important features of endocrine glands, such as highly efficient protein production and ability to secrete proteins into the bloodstream primarily through a constitutive secretory pathway. Additionally, SGs are well encapsulated and not life-threatening organs. In both animal models we could observe Ex-4 secretion at pharmacological circulating levels. Ex-4 expression was associated with a significantly reduction of weight gain from five weeks after vector administration until the end of the study. Effects on daily food intake between treated and control animals were detected only transiently in DIO mice, which showed a reduced meal size, suggesting enhancement of satiety, but not in Zucker fa/fa rats. Metabolic effects of AAV5-Ex-4 mediated gene therapy included a significant reduction HbA1c levels and glycosuria in treated Zucker fa/fa rats versus control animals during the study. In conclusion AAV5-mediated transgene expression of Ex-4 in SGs determines a sustained reduction of body weight, blood glucose and HbA1c in different animal models of obesity and diabetes, with no relevant side effects. Further studies on this approach, with different animal models, are needed, in order to verify the possible application of AAV-5-mediated gene therapy with Ex-4 in humans.

658. Enhancing Systemic Delivery of Recombinant Adeno-Associated Viruses through Kupffer Cell Depletion

Matthew L. Hillestad,¹ Adam J. Guenzel,¹ Michael A. Barry.¹

¹*Molecular Medicine, Mayo Clinic, Rochester, MN.*

Intravenous injection of recombinant adeno-associated virus vectors (rAAV) into small animals can mediate robust transgene expression in tissues throughout the organism. However, to achieve this level of systemic gene delivery, one must deliver very large doses of rAAV which may not be practical or safe in humans. To optimize systemic delivery of rAAV, we evaluated the effects of liver Kupffer cells on depletion of intravenously-administered rAAV8 vectors in mice. Tail vein injection of rAA8 produced co-localization of the vector with liver Kupffer cells within 4 hours of injection. Elimination of Kupffer cells by predosing before AAV injection increased liver transduction by single-stranded rAAV8-luciferase vector up to 90-fold in male mice and up to 200-fold in female mice. Predosing with self-complementary rAAV-Cre recombinase vector in cre-activated luciferase mice increased liver transduction 63-fold in males and 16-fold in female mice. These data indicate that liver Kupffer cells deplete a significant fraction of rAAV after intravenous injection. This suggests that manipulation of the host or the vector to decrease the interactions AAV with liver Kupffer cells will improve vector pharmacology and allow lower doses of vector to be used for systemic muscle gene therapy.

659. Development of an Effective AAV Vector-Based Gene Therapy To Treat the PRKAG2-Tg Mice, an Animal Model of Autosomal Dominant Progressive Cardiomyopathy

Kei Adachi,¹ Christopher S. Naitza,¹ Xueyin N. Huang,² Ferhaan Ahmad,² Hiroyuki Nakai.¹

¹*Department of Microbiology and Molecular Genetics, University of Pittsburgh School of Medicine, Pittsburgh, PA;* ²*Department of Medicine, University of Pittsburgh, Pittsburgh, PA.*

Familial cardiomyopathies exhibiting autosomal dominant inheritance are often progressive leading to cardiac failure. A series of the causative genes have been identified; however, challenges remain in the development of curative molecular therapy due to the autosomal dominant nature of the disease. Recombinant AAV

serotype 9 (rAAV9) has recently gained increasing attention due to its outstanding ability to transduce the heart following systemic vector administration via the periphery. This has significantly broadened the applications of rAAV vectors in cardiac gene therapy. In our laboratory, we seek to develop new rAAV-based approaches to treat autosomal dominant progressive cardiomyopathy using a PRKAG2 transgenic (Tg) mouse model. Dominant mutations of the gamma 2 subunit of the AMP-activated protein kinase (AMPK) coded by the PRKAG2 gene cause familial glycogen storage cardiomyopathy associated with cardiac hypertrophy, ventricular pre-excitation, progressive heart failure and sudden death. It has been suggested that inappropriate activation of the AMPK alpha catalytic subunit due to mutations in the gamma 2 regulatory subunit is in part responsible for the cardiomyopathy. To establish an effective therapy, we have been decided to take two approaches: 1) forced expression of a dominant negative AMPK alpha 2 catalytic subunit (DNalpha2) in the heart by rAAV9, and 2) expression of shRNA against AMPK gamma 2 subunit by rAAV-mediated RNA interference. Here we show that neonatal injection of rAAV9 expressing DNalpha2 decreased AMPK activity and mildly improved the PRKAG2-Tg phenotypes in vivo, and rAAV expressing PRKAG2 shRNA embedded in miR30 effectively knocked down FLAGtag-fused human PRKAG2 (FLAGhPRKAG2) protein in vitro. In the in vivo experiment, the PRKAG2-Tg and wild type mice were injected intraperitoneally with 2 x 10¹¹ particles of AAV9-CMV-DNalpha2 or AAV9-CMV-lacZ at birth. Echocardiography and molecular analyses of the heart tissues were performed at 6 weeks of age. We observed that the levels of Thr172-phosphorylated form of AMPK, which reflects AMPK activity, were reduced in the DNalpha2 vector-transduced heart by the rAAV-mediated overexpression of DNalpha2. As a result, the DNalpha2 vector-treated mice exhibited an increase in heart rate toward norm and showed a decrease in left ventricular internal dimensions in systole and diastole. In the in vitro experiment, 293 cells were co-transfected with FLAGhPRKAG2 and PRKAG2 shRNA plasmids, resulting in over 80% reduction of the PRKAG2 protein levels. In addition, the same extent of knockdown was observed in 293 cells that stably expressed FLAGhPRKAG2 when the cells were infected with rAAV2-PRKAG2 shRNA at an MOI of 10⁵. We are currently investigating therapeutic effects of rAAV9 shRNA vector-mediated knockdown of PRKAG2 in vivo toward establishing gene therapy approaches to treat this animal model.

660. Rescuing Adeno-Associated Virus from the Late Endosome/Lysosome Long after Infection Improves Apical Transduction of Human Airway Epithelia

Nicholas W. Keiser,¹ Ziying Yan,¹ Diana Lei-Butters,¹ John F. Engelhardt.¹

¹*Department of Anatomy and Cell Biology, University of Iowa, Iowa City, IA.*

Recombinant adeno-associated virus (rAAV) represents a promising potential gene therapy vector for genetic disorders that affect the respiratory epithelium, such as cystic fibrosis (CF). However, the most commonly-studied rAAV serotype (rAAV2) is inefficient at transducing polarized human airway epithelia (HAE) from the apical membrane, and CF clinical trials using this vector failed to produce efficient gene expression in vivo. Interestingly, rAAV2 transduction from the basolateral membrane is highly efficient. In contrast, rAAV1 is efficient at transducing HAE with no polarity bias. Differences in intracellular trafficking of rAAV virions have been thought to underlie the transduction differences observed with these two serotypes. We hypothesized that rAAV2 trafficking from the apical membrane results in accumulation of the virus in an endosomal compartment that is unable to process the virion, and that this compartment would differ from that used during apical trafficking of rAAV1. Co-infection experiments with differently-labeled fluorescent rAAV1 and rAAV2

particles suggested that whereas rAAV1 trafficking pathways from both membranes converge, rAAV2 utilizes two completely different endosomal trafficking pathways from the apical and basolateral membranes. In order to identify the specific apical and basolateral trafficking pathways of rAAV2, we performed staining for various endosomal markers on polarized HAE infected with fluorescently-labeled virions. Entry through the apical membrane was found to be markedly slower than through the basolateral membrane. We determined that rAAV2 particles entering through the apical membrane move to the early endosome, and then a majority of these particles move rapidly to the late endosome/lysosome, where they remain for long periods of time. Treatment with proteasome inhibitors has been shown to augment rAAV2 transduction by enhancing viral trafficking to the nucleus. We hypothesized that proteasome inhibitors might rescue rAAV2 from the lysosome following apical entry. We found that fluorescently-labeled rAAV2 particles had trafficked significantly farther towards the nucleus following proteasome inhibitor treatment. Furthermore, treatment with proteasome inhibitors two weeks following apical infection of HAE rescued transduction to levels seen with basolateral infection, which is highly efficient. We conclude that inefficient rAAV2 apical transduction is caused by the routing of viral particles into the late endosome/lysosome, where they are unable to be effectively processed and remain dormant for long periods of time. Treatment with proteasome inhibitors rescues functional virions from this compartment, allowing them to move into the nucleus and transduce the cell. These results provide promising evidence that rAAV2 gene therapy in the airway may be successful if the basic trafficking biology of the virus is altered.

661. New Proteins Providing Host Defense Functions Against rAAVs

Jerome Denard,¹ Cyriaque Beley,² Robert Kotin,³ Philippe Moullier,¹ Thomas Voit,² Luis Garcia,² Fedor Svinartchouk.¹
¹Genethon, Evry, France; ²Université Pierre et Marie Curie; Institut de Myologie, Paris, France; ³National Heart, Lung, and Blood Institute; NIH, Bethesda, MD.

Gene therapy holds great promise for the treatment of diseases caused by defective genes. However the efficiency of the corrective genes delivery into the target organs and tissues remains one of the major challenges of this treatment strategy. The recombinant adeno-associated viral (rAAV) delivery system derived from non-replicative and non-pathogenic parvoviruses is an attractive candidate for achievement of long-term therapeutic gene transfer. The rAAV vector genome persists as episomal chromatin in the nucleus of non-dividing cells and is capable of infecting a wide range of host cell types including dividing and non-dividing cells. Several AAV serotypes with differences in tropism have been used as vectors for gene therapy. Mechanisms underlying the distinct biological performance of different AAV serotypes have been attributed to capsid-mediated interactions with cells, viral entry, trafficking, uncoating and genome processing. Little is known about interactions of vectors with blood and tissue proteins under systemic delivery conditions. AAV neutralization was imputed to interactions with circulating antibodies which present a potent obstacle for successful gene therapy in human. In the present work we describe new data concerning rAAV interaction with proteins of the innate immunity system. We show that even in the absence of neutralizing antibodies, some human and dog proteins interact with AAV vectors and neutralize vector infectivity. One of the proteins will be described in more details. Interactions of this protein with rAAVs are species specific and do not depend on the degree of the protein homology: AAV serotypes captured by human and dog protein do not interact with their mouse homologs. Moreover, in the macaque, which is generally considered as one of the most relevant models for human preclinical trials, the homology of human protein (98% of identity) does not interact with AAV. Interestingly, several

AAV serotypes can escape capture by this protein and one of them, AAV9, has proved its efficiency in dogs under systemic delivery for whole body transduction. Altogether, the present chapter will describe new biomarkers in gene therapy, which are predictive of in vivo efficacy and safety as well as being critical factors impacting on regulatory toxicology studies design and interpretation.

662. AAV Gene Therapy Augments Chemotherapy in Multi-Modal Treatment of Ovarian Carcinoma

Chelsea M. Bolyard,¹ Matthew D. Stachler,² Jeffrey S. Bartlett,³ Douglas M. McCarty.¹

¹Gene Therapy, Nationwide Children's Hospital, Columbus, OH; ²Pathology, Brigham and Women's Hospital, Boston, MA; ³Pediatrics, Ohio State University, Columbus, OH.

Purpose. Ovarian cancer (OvCa) is the leading cause of death due to gynecological malignancy, and a leading cause of death due to cancer in developed countries. Several novel chemotherapeutics have shown promise in treating OvCa, including the DNA-damaging agent doxorubicin, histone-deacetylase inhibitor depsipeptide, and proteasome inhibitor PS-341. We investigate how gene therapy can be combined with these drugs to enhance cell killing. Our lab has shown that AAV can be modified to display targeting ligands on the capsid, facilitating transduction into tumor-associated vasculature. This can be augmented in several ways. The self-complementary AAV genome is expressed more robustly than the single-stranded genome. Also, AAV2 transduction can be increased by treatment with HDAC inhibitors and proteasome inhibitors. Thus, drug therapy has a dual effect in our study: to induce apoptosis, and to enhance AAV transduction. We will examine the ability of TNF α -Related Apoptosis-Inducing Ligand (TRAIL) gene therapy to augment chemotherapy killing of OvCa cells. This will be done by delivery of TRAIL using the targeted self-complementary AAV vector, after drug treatment. **Methods.** We assess the ability of AAV-TRAIL to enhance drug killing of OvCa. Because our in vivo model of gene therapy targets the tumor-associated vasculature, our in vitro work focuses on the paracrine effects of TRAIL. In a preliminary experiment, human embryonic kidney 293 cells were transfected with the rAAV-TRAIL construct (or GFP control). Conditioned media was then removed from the 293 cells, and titrated onto chemotherapy-treated ovarian cancer (OvCa) cell lines. To transition this to our in vivo model, we will first transduce human endothelial cells (HUVEC) with the targeted AAV (displaying RGD or VR2a targeting peptide) expressing either TRAIL or GFP control, and add these transduced HUVEC to a co-culture with OvCa cells. Both the HUVEC and the OvCa will be pre-treated with drug therapy. In this strategy, the OvCa cells are sensitized to the drug while the HUVEC continue to produce TRAIL. We will choose the most potent drug/virus killing combinations, and begin animals studies using the murine model of late-stage ovarian carcinoma. **Results.** We have determined that TRAIL can act in a paracrine manner, and can increase OvCa cell killing over drug-treatment alone. These data are summarized in Table 1.

TRAIL-conditioned media increases killing of drug-treated OvCa.

	OVCAR-3	SKOV-3	OV-4	PA-1
Depsipeptide	64-77%	49%	26%	9-22%
PS-341	-	57-74%	7-15%	8-32%
Doxorubicin	41-73%	49-67%	10-12%	3-32%

Data expressed in reduction of viability over baseline killing with drug treatment alone.

Conclusions & Implications. We have determined that TRAIL can be delivered within the context of the AAV genome, and that the TRAIL secreted from transduced cells maintains paracrine activity. Secondly, we have determined that the effects of chemotherapeutics can be potentiated by subsequent TRAIL treatment. Subsequent experiments will determine the in vivo effects of this promising therapy.

663. Therapeutic Expression of Factor IX in a Murine Hemophilia B Model Using a Novel Human Stem Cell Derived AAV Serotype

David M. Markusic,¹ Laura J. Smith,² Irene Zolotukhin,¹ Arun Srivastava,¹ Saswati Chatterjee,² Roland Herzog.¹

¹*Pediatrics, University of Florida, Gainesville, FL;* ²*Virology, Beckman Research Institute of City of Hope, Duarte, CA.*

Hemophilia B is a coagulation disorder resulting from mutations in the Factor IX (F.IX) gene leading to loss of protein function. Liver directed AAV gene transfer of F.IX results in long-term correction of disease and tolerance to F.IX protein in murine and canine hemophilia B models. We have previously shown that mutation of surface exposed tyrosine residues (444,500, and 730) to phenylalanine on the AAV2 capsid (AAV2-M3) results in improved hepatic gene transfer efficiency and long-term correction of disease in a murine hemophilia B model. Although this AAV2-M3 capsid has improved liver gene transfer, the high prevalence of neutralizing antibodies to the AAV2 capsid in the human population limits the clinical use of this vector. Therefore, we are also investigating other AAV serotypes that lead to efficient hepatic gene transfer. Interestingly, one of our labs isolated multiple novel AAV serotypes from human CD34+ hematopoietic stem cells and identified several candidate serotypes (HSC-15 and HSC-17) that provided highly effective liver gene transfer in immune deficient mice (Mol Ther 18 S1). We packaged AAV vectors expressing human F.IX from a liver specific promoter (ApoE/hAAT) using either AAV8 or HSC-15 to compare gene transfer efficiency in immune competent wild-type mice in a C3H/HeJ background. C3H/HeJ mice (n=4) were injected in the tail vein at a dose of 1×10^{11} , 1×10^{10} , and 2×10^9 vg of HSC-15 ApoE/hAAT hF.IX vector resulting in average hF.IX expression levels of 661 ± 142 , 173 ± 94 and below detection levels ng/ml respectively, which improved expression over our optimal AAV2-M3 capsid. To test if we could further improve liver gene transfer efficiency, two putative surface exposed tyrosine residues at positions 446, and 731 were mutated to phenylalanine in HSC-15 resulting in three different mutant capsids (446, 731, and 446/731). Hemophilia B mice (n=3-4) were injected with 1×10^{11} vg in the tail vein with AAV8, HSC-15, and the three HSC-15 tyrosine mutants vectors and followed over time for hF.IX expression. At one month mice were bled and F.IX activity was determined. Average F.IX activity was 62%, 11%, 6%, 5%, 3% respectively, which correlates with F.IX expression levels obtained in C3H/HeJ wild type mice. Single or double tyrosine mutations in the HSC-15 capsid resulted in decreased hepatic gene transfer compared to wild type HSC-15 and injected animals were not further followed. At two months average F.IX activity was 83% (AAV8) and 16% (HSC-15). Correcting for dose, HSC-15 AAV vectors provide approximately four-fold greater liver gene transfer in hemophilia B mice than previously described AAV2-M3 vectors. If future studies show a low prevalence of neutralizing antibodies to HSC-15 in human sera and gene transfer efficiency scales up in a large animal model this may be a potential new serotype to consider for human liver gene transfer.

664. Single Amino Acid Mutations on the External Surface of AAV2 Improve Transduction of Liver and Retina and Reduce Neutralization

Abraham Scaria,¹ Gary White,¹ Michael Lukason,¹ Elizabeth DuFresne,¹ Jennifer Sullivan,¹ Samuel Wadsworth.¹

¹*Molecular Biology, Genzyme Corporation, Framingham, MA.*

It was previously shown by in vitro studies (Lochrie et al, 2006) that some single amino acid changes on the external surface of AAV2 can affect transduction of HeLa cells and neutralization by pooled human intravenous immunoglobulin G (IVIG). We have constructed and characterized a few of these mutations in vivo both by intravenous delivery to the mouse liver and by intravitreal delivery to

the eye. Of the mutations we have analyzed so far, the AAV2-R471A mutation significantly outperforms the others in transgene expression following intravenous administration with expression levels in the range of that observed with AAV8 based vectors. We also find that the R471A mutant gives rise to transgene expression much faster than the wild type AAV2 based vector. We used passive transfer of IVIG into the mouse to test the performance of AAV vectors in the liver. Even though R471 does not map to any of the known neutralization epitopes of AAV2, we find that this mutant also reduces neutralization by IVIG in vitro and in vivo. Intravitreal administration of the R471A vector gave faster transgene expression in the eye compared to AAV2 and the levels of expression although slightly higher, were not as significantly improved as in the liver studies. R471 has not been shown to be involved in heparin binding or binding to any known AAV2 receptor. However we find that the single amino acid mutation improves transduction in the liver and the retina and helps the vector avoid neutralization by human IVIG. The mechanism of improved transduction is currently under investigation.

665. Variables Affecting AAV8-Mediated Liver Transduction Efficiency in Rats

Gabriella Cotugno,^{1,2} Patrizia Annunziata,^{1,2} Marianthi Karali,¹ Sandro Banfi,¹ Alberto Auricchio.^{1,2}

¹*Telethon Institute of Genetics and Medicine (TIGEM), Naples, Italy;* ²*Medical Genetics, Dept. of Pediatrics, "Federico II" University, Naples, Italy.*

Liver-directed gene transfer has been widely explored for the treatment of several inherited and acquired diseases, affecting liver itself or requiring systemic delivery of a therapeutic protein (i.e. hemophilia, lysosomal storage disorders and others). Efficient and specific transduction of hepatocytes is crucial to obtain therapeutic efficacy and avoid transgene-directed immune-responses. Vectors based on adeno-associated virus vectors serotype 8 (AAV2/8) represent promising tools for liver gene transfer resulting in efficient, long-term liver transgene expression after a single systemic administration. Preliminary results from an ongoing clinical trial using AAV2/8 in hemophilia B patients confirm this. We have evaluated the impact on AAV2/8-mediated rat liver transduction of the following: i) age at vector administration, ii) presence of lysosomal storage in hepatocytes and iii) choice of regulatory elements to be included in the transgene expression cassette. We have found that AAV2/8-mediated liver transduction and genome copy number/hepatocyte is higher in animals treated at post-natal (p) day 30 than at p5 suggesting that vector dilution occurs in newborn rat liver. We observed that transgene expression occurs in hepatocytes but not Kupffer cells when the liver-specific thyroxine binding globulin promoter (TBG) is included in the expression cassette. However, minimal levels of transduction were evident in spleen and kidney of rats treated systemically with AAV2/8-TBG vectors at p5 but not at p30. The impact on rat liver transduction of additional regulatory elements such as WPRE or the hematopoietic specific microRNA miR-142-3p is being evaluated. No significant differences in the levels of AAV2/8-mediated liver transduction were observed due to the presence of lysosomal storage. These data may be relevant to the design of liver-directed therapies for hepatic or systemic diseases using intravascular administration of AAV2/8.

666. Micropatterning AAV and Extracellular Matrix Proteins for Tissue Engineering

Kellie I. McConnell,¹ John H. Slater,¹ Jennifer L. West,¹ Junghae Suh.¹

¹*Bioengineering, Rice University, Houston, TX.*

Complex tissue development requires precise control over the spatial organization of gene expression. Tissue engineering strategies

have expanded to overcome significant barriers, but creating spatially controlled gene expression profiles in an engineered construct is still difficult. We are working to develop a platform that allows for both viral gene delivery vectors and adhesive proteins to be co-patterned to control both cellular attachment and gene expression. Our approach is based on the micropatterning of adeno-associated virus (AAV). This gene delivery vector can be tailored to deliver genes into target cells with high efficiency. We are capable of localizing both cellular adhesion and gene expression using polydimethylsiloxane (PDMS) stamps to pattern alkanethiol solutions onto gold-coated substrates. We patterned alkanethiol solutions with a variety of functional groups in order to create different surface chemistries, including -CH₃ (hydrophobic), -COOH (negatively charged), -NH₂ (positively charged), and -OH (hydrophilic) to determine the optimal surface conditions for virus immobilization. Patterns were printed onto gold-coated glass coverslips and then backfilled with an -OEG terminated alkanethiol to create a protein resistant background. Patterns were then exposed to either virus or ECM protein followed by virus. We are able to pattern AAV in combination with a variety of cell adhesion proteins, including human fibronectin (HFN), collagen I, elastin, and laminin. Interestingly, we observe a synergistic effect between the patterning of HFN and AAV for the delivery of genes to HeLa cells. Future work will involve the creation of more complex patterns to aid in the spatial organization of gene expression in developing tissue engineered constructs.

667. Gene Transfer to the Murine Cornea In Vivo

Daniel C. Chung.¹

¹*Scheie Eye Institute, University of Pennsylvania, Philadelphia, PA.*

This study investigates the transduction efficiency of a panel of recombinant adeno-associated viral (AAV) vectors, AAV1, 2, 5, 6, 7, 8 and 9 for gene transfer to mouse cornea in vivo. The viral vectors encode a bioluminescent marker, luciferase. Small plastic rings are placed on the cornea to contain the vector. The right eye receives vector to an intact corneal epithelial layer. The epithelial layer of the contralateral eye is gently removed prior to application, and approximately 10 μ l of vector are placed in each eye, and left for 3 minutes, prior to removal. After 14 days, eyes are evaluated for bioluminescence in a Caliper Lumina II bioluminescence imaging system. Mice are euthanized and the cornea is cryoprotected and cryosections are obtained. The sections are then evaluated by immunohistochemistry for the presence of luciferase. Transduction efficiency is calculated by photon counts obtained by the Caliper Lumina II imaging system, and then through quantification of histological sections. Transduction efficiency was poor in eyes that did not undergo epithelial cell debridement. Results reflect the findings of the left eye only. Transduction efficiency was similar for AAV8, 5 and 9, followed by AAV7, 6, 2, and 1. Our results suggest that several AAV serotypes provide adequate transduction efficiency for corneal gene transfer. The removal of corneal epithelium prior to AAV application greatly improves transduction efficiency. Further studies will be needed to confirm cellular tropism, duration of expression and safety.

668. Neutralizing Factors Against Cardiotoxic AAVs in Sera from Different Animal Models

Kleopatra Rapti,¹ Vedell Louis-Jeune,¹ Erik Kohlbrenner,¹ Kiyotake Ishikawa,¹ Dennis Ladage,¹ Roger J. Hajjar,¹ Thomas Weber.¹

¹*Cardiovascular Research Center, Mount Sinai School of Medicine, New York, NY.*

Chronic heart failure is one of the leading causes of morbidity and mortality in the Western world. Current therapies, such as

pharmacological treatment and implanting devices, are able to slow down the progression of the disease but they are unable to reverse it. Hence, new treatment modalities are urgently needed. Cardiac gene therapy has emerged as a promising, new technology that could possibly help to fill in this void. Adeno-Associated Viruses (AAV) hold great potential as gene delivery vectors owing in part to their lack of pathogenicity, their comparatively low immunogenicity and their ability to sustain long-term gene expression even in the absence of genome integration. Despite their comparatively low immunogenicity, a significant fraction of the population has neutralizing antibodies against one or several AAV serotypes. These antecedent neutralizing antibodies present a considerable challenge to therapeutic gene transfer with AAV vectors. The underlying reason for the high seroprevalence for neutralizing antibodies against AAV vectors most likely is the fact that the commonly used serotypes 1 through 9, are isolates from human tissues or primates. Thus far, neutralizing antibodies against AAV vectors in animal models has not been considered to be a matter of concern mainly because of the primate origin of the AAV serotypes used and the fact that rodents, the most commonly used animal models, are maintained in pathogen free conditions. In this study, we provide evidence for the existence of neutralizing factors in animal serum against the cardiotoxic AAVs, serotypes 1, 6 and 9, and the most studied AAV, serotype 2. We observed that sera from several species: mouse, rat, rabbit, pig, canine and sheep could inhibit AAV transduction in a serotype- and species-dependent fashion. We also provide evidence that the inhibition of transduction is due, at least in part, to the presence of anti-AAV immunoglobulins. Our study suggests that neutralizing antibodies and/or other neutralizing factors are present in common animal models of cardiovascular disease and that they are an important factor to be considered in both the design and interpretation of in vivo experiments.

669. rAAV8 Mediated Negative Vaccine Therapy in NOD Mouse Model

Yuanqing Lu,¹ Linda Theisen,¹ Christian Grimstein,¹ Matthew Parker,² Clive Wasserfall,² Mark Atkinson,² Sihong Song.¹

¹*Pharmaceutics, University of Florida, Gainesville, FL;*

²*Pathology, University of Florida, Gainesville, FL.*

Background. Type 1 diabetes (T1D) is a chronic autoimmune disease. Insulin and glutamic acid decarboxylase (GAD) are two of the major auto-antigens which have been used for vaccine therapy for T1D in both animal studies and clinical trials. Considerable room for improvement of the effect of vaccine therapy of T1D remains. Vector system plays key role in the vaccination. We have recently discovered that recombinant adeno-associated virus serotype 8 (rAAV8) can induce transgene-specific tolerance, therefore, it could be a promising vector for negative vaccine therapy. **Method.** Vector expressing a fusion protein containing insulin B9-23 and GAD500-585 fragments has been constructed and packaged with rAAV1 and rAAV8 helper plasmid. 2×10^{11} pv/mouse of AAV8-CB-B923GAD500, AAV1-CB-B923GAD500 and 200 μ l of saline solution were injected into 4-week-old and 3-week-old female NOD mice. Blood glucose was monitored weekly. Serum GAD levels were measured by ELISA assay. Regulatory T cells (Treg) populations were analyzed by flow cytometric assay. **Results.** Moderate preventive effect of AAV8-CB-B923GAD500 on the development of diabetes in NOD mice was observed but AAV1-CB-B923GAD500 was not. Low level and transient serum GAD has been detected. No change of Treg has been detected. **Discussion.** rAAV8 is a potential promising vector for negative vaccine therapy. The effect of vaccination in this study may be hampered by the rapid clearance of the short therapeutic peptide. Other strategies are needed to improve the outcome of rAAV8 mediated negative vaccine therapy in T1D.

670. Effects of the MRI Contrast Agent Gadoteridol on the Integrity and Distribution of rAAV2 and rAAV5 in the Rat Striatum

Susan M. Osting,¹ Shelby T. Power,¹ James J. Raschke,² Antoinette D. Bennett,³ Mavis Agbandje-McKenna,³ Marina E. Emborg,^{2,4} Corinna Burger.¹

¹Neurology, University of Wisconsin, Madison; ²Wisconsin National Primate Research Center, University of Wisconsin, Madison; ³Dept. of Biochemistry and Molecular Biology, University of Florida, Gainesville, FL; ⁴Medical Physics, University of Wisconsin, Madison.

Real-time magnetic resonance imaging (MRI) is proposed as a method to optimize Intracerebral targeting and track infusate distribution in gene therapy trials for nervous system disorders. MRI visualization requires that MRI-contrast agents, such as gadoteridol (Prohance, Bracco Diagnostics Inc.), is co-infused with the viral vector suspension. Here we investigated possible effects of gadoteridol on the integrity of rAAV and the distribution and level of expression of transgene in the rat striatum. Animals were injected with rAAV2-GFP or rAAV5-GFP (10E11 genome copies/ml), alone or co-infused with gadoteridol (1mM and 2mM; 2 µl total injection volume). Three weeks after injection, the animals were euthanized and their brain tissue processed. GFP-immunoreactive densitometry and area analyses revealed an increase in the transduction efficiency of rAAV5-GFP in the presence of gadoteridol when compared to equal titers of viral vector injected alone. Evaluation of Nissl staining did not show differences in the striata between the animals injected with rAAV-GFP alone and with gadoteridol. Similarly, GFAP and OX-42 immunohistochemistry did not show differences on inflammation in the different treatment groups. We are currently completing electron microscopy studies to determine the integrity of viral particles in the presence or absence of the contrasting agent.

671. Cost-Effective and Facile Method of rAAV Production in Suspension-adapted HEK 293 Cells

Huiren Zhao,¹ Thomas Wolfe,¹ Marissa van der Valk,¹ Plewa A. Cherylene,¹ Jackie Sheng,¹ Ki Jeong Lee.¹

¹Department of Protein Science, Amgen, Inc., Thousand Oaks, CA.

Recombinant adeno-associated virus is the most promising gene transfer vector in both pre-clinical studies and clinical trials. However, the scale-up of AAV production using adherent HEK293 cells is expensive and laborious. Here we report a method for the production of rAAV by using suspension-adapted HEK 293 cells. The optimizations were carried out in 20 ml of Freestyle 293 medium in 125 ml Erlenmeyer flasks. Cells were transfected with pHelper, cis vector encoding EGFP and AAV packaging plasmid. The production of rAAV was compared with the existing method using adherent HEK 293 cells transfected with calcium phosphate. Western blot for capsid proteins was used for evaluation of AAV production since it is convenient and there is a good correlation between titer and capsid protein. Our results showed that suspension-adapted HEK293 produces more AAV than suspension cell line 293-6E that has truncated ENBA1 (EBNA1t) and showed enhanced recombinant protein expression. We optimized cell density at the time of transfection, total amount of DNA, additives, and harvest time. Scale-up to a 1L production culture using optimized conditions generated similar amounts of rAAV particles to that from a 6700 cm² cell stack of adherent HEK 293 cells. Activity *in vivo* of rAAV from suspension cells was as efficacious as that produced from adherent cells. We concluded that generating rAAV in suspension culture using our optimized conditions produced equivalent amounts of viral vector with comparable biological activity while the new process dramatically reduced the cost and work load in rAAV production.

672. P53-Dependent NF-κB Activity Influenced the Anti-Tumor Effect of AAV-Mediated BATF2 Overexpression in Lung Cancer Cells

Zhao Lu,¹ Jing Niu,¹ Wei Wu,³ Dexi Chen,² Wei Ding.¹

¹Department of Biochemistry and Molecular Biology, School of Basic Medical Sciences, Capital Medical University, Beijing, China; ²Department of Internal Medicine, Beijing You-An Hospital, Capital Medical University, Beijing, China; ³Department of Epidemiology and Health Statistics, School of Public Health and Family Medicine, Capital Medical University, Beijing, China.

BATF2 (basic leucine zipper ATF-like transcription factor 2, also named SARI-suppressor of AP-1 and regulated by interferon) was discovered as a novel human-specific tumor suppressor gene with substantial anti-tumorigenic activities. BATF2 was found to induce apoptosis and inhibit the growth of a variety of cancer cells through the suppression of interferon-beta induced AP-1 activities. Currently, the functional characterization of BATF2 in association with other signaling molecules involved in the known anti-tumor mechanisms was poorly reported. In this study, we cloned BATF2 with a N-terminus 3×FLAG tag and produced the CMV-driven BATF2 overexpression recombinant AAV2 viral vectors. In either transfected or infected cancer cells with the overexpression of BATF2, including HeLa, MCF-7, A549, and H1299, increased apoptosis and inhibition of cell growth were observed as shown in TUNEL and MTT assays, especially in H1299 cells. Using the luciferase reporters for AP-1 and NF-κB, we found that both the AP-1 and NF-κB transcription activities were inhibited with the overexpression of BATF2 except in H1299 cells, where no significant changes of NF-κB activity was detected. By siRNA knockdown of P53 in A549, the reduction of NF-κB was largely compromised. These results indicated that BATF2 was able to modulate both AP-1 and NF-κB pathways to impact the survival of tumor cells and the coordinated regulation of the AP-1 and NF-κB by BATF2 was influenced by the function of P53. Our findings suggested that the anti-tumor effect of BATF2 was associated with the coordination of AP-1 and P53-dependent NF-κB activity, and this could be an important consideration for the optimized application of BATF2 as a candidate for potential cancer gene therapies.

Adenovirus and Other DNA Virus Vectors III

673. Single Oral Vaccination with Human Adenovirus 40 Vector Elicits Systemic Immune Responses

Satoshi Yamasaki,¹ Eric Brown,¹ Julia Davydova,¹ Selwyn M. Vickers,¹ Masato Yamamoto.¹

¹Department of Surgery, University of Minnesota, Minneapolis, MN.

Human adenovirus serotype 40 (Ad40) presents significant tropism for intestinal mucosa and may overcome systemic self-antigen tolerance by activating intestinal innate immunity. Ad40-based vectors thus have an advantage for inducing systemic immune responses via intestinal mucosa binding, making them prime candidates as oral vaccine carriers. Here, Ad40 vectors, in which the regions E1A and E1b19K were replaced by a luciferase reporter gene, were successfully generated and amplified in Ad5 E1-expressing human retinoblastic cells. The binding of this Ad40 vector to microfold cell (M cell) models *in vitro* was superior to that of a standard Ad5 vector. After a pepsin treatment, the luciferase activities of Ad40 and Ad5 vectors were detected in *in vitro* M cell models, although their levels were decreased. After 48 hours of intraduodenal administration to C57BL/6 mice, Ad40 vectors showed a higher DNA copy number in the ileum with Peyer's patches (PPs), mesenteric lymph nodes (MLNs), and spleen when compared with Ad5 vectors. Furthermore, the luciferase protein expressed by Ad40 vectors was detected in the

ileum around PPs' domes, but not within PPs' domes, MLNs nor spleen. Based on these observations, intestinal M cells and PPs are probably entry sites of Ad40 vectors, not those of Ad5 vectors, after intraduodenal administration. Thus, Ad40 vectors may be superior to a standard Ad5 vector as an enhancer of systemic immunity via intestinal mucosa binding, although the protection against gastric fluid is important for both Ad40 and Ad5 vectors to maintain effective transduction after oral administration. To confirm that the Ad40 vector can be a suitable mediator for oral vaccine, the immune reactions of an ovalbumin (Ova) expression Ad40 vector (Ad40-Ova) are evaluated with those of an Ova expression Ad5 vector (Ad5-Ova). Fourteen days after intraduodenal administration, Ad40-Ova activated Ova-specific IFN- γ -secreting CD8⁺ T-splenocyte responses and Ova-specific immunoglobulin was detected in the serum, while Ad5-Ova induced an expansion of both CD4⁺ and CD8⁺ Ova-specific IFN- γ -secreting T-splenocytes and serum Ova-specific immunoglobulin. These data support an Ad vector based intraduodenal delivery system that is able to stimulate systemic immunity via intestinal mucosa binding and Ad40-based vectors may have implications for the design of oral vaccines which are different from those of standard Ad5-based vectors.

674. Novel Adenovirus Vector Generating System Enabling Adenoviral Library with 10¹⁰ Diversity

Yoshiaki Miura,¹ Eric Brown,¹ Julia Davydova,¹ Kazunori Aoki,² Masato Yamamoto.¹

¹Department of Surgery, University of Minnesota, Minneapolis, MN; ²Section for Studies on Host-Immune Response, National Cancer Center Research Institute, Tokyo, Japan.

Adenovirus has very high transduction efficiency compared to other non-viral and viral gene transfer systems. Its application for library and its screening have been dreamed of for years. However, the presentation of the library in the form of adenovirus has been considered to be impossible to date. In conventional methods, 1 g DNA transfection of the plasmid-derived adenovirus sequence generates only 1-2 plaques in 7 days. This step exists as a definite bottle neck against efficient library construction with adenovirus platform. We hypothesize that the usage of rescue-virus combining with exploitation of fiber-complementing producer cell system would overcome this bottle neck and result in sufficient library diversity exploitable for expression-screening/identifying new class of adenoviral vector. The vector recovery with our new rescue virus system using single original loxP site without mutation in rescue virus and shuttle plasmid was drastically improved from previously reported adenovirus library systems, and the optimization of the timing of shuttle plasmid transfection and rescue virus infection further augmented the recover by one order of magnitude. Also, the vector generation with fiber complementing cell line enabled even better vector recovery. The vector generation from this method was 10⁹ copy in only 2 days. In order to estimate the diversity of the adenoviruses generated with this system, we set up dilution experiments. The shuttle plasmid library with random library in HI-loop were mixed with GFP-expressing shuttle plasmid at various ratios (10⁴:1-10⁹:1), and recombined with rescue virus in adenovirus producer cells (6cm culture dish). 2 days later, the CVLs were recovered and 1/50 volume was treated with DNaseI and then examined for copy number by Q-PCR with Taqman probe, which detects only GFP-positive adenovirus. GFP-positive adenoviruses were detected in 10⁷ dilution dish, meaning that the library included 5x10⁸ different viruses per 6cm dish at minimum. We then directly selected the vectors with intended targeting ability from a random peptide library displayed in the HI-loop of CAR-binding ablated fiber for proof of principle. This library was first generated and amplified with fiber complementing cell line, and then the resultant adenoviral

library was screened with pancreatic cancer cell line (Panc1). The expansion of the selected clones was observed after the several rounds of screening steps. Aggregation of these designs easily enabled >10⁸ library production from single 6cm dish, compared to 10⁶ level with previously reported systems. Thus, regular laboratory scale experiment can easily generate 10¹⁰ diversity adenovirus library. This level of library size easily feasilizes the biologically meaningful library screening with adenovirus as a expression platform, which has been impossible with existing technologies. In addition, this strategy can be easily applicable for rapid and high efficiently production of adenovirus vector. In this meaning, our system provides a breakthrough for generating a library in adenovirus platform.

675. Oncolytic Adenoviral-Mediated Inhibition of Established Bone Metastases: A Safe and Effective Systemic Therapeutic Approach for Breast Cancer

Zebin Hu,¹ Helen Gerseny,¹ Zhenwei Zhang,¹ Stuart Stock,² Prem Seth.¹

¹Department of Medicine, NorthShore Research Institute, University of Chicago, Evanston, IL; ²Department of Molecular Pharmacology and Biological Chemistry, Northwestern University, Chicago, IL.

Purpose: In recent years, oncolytic adenoviruses have shown some promise as a novel class of anti-tumor agents. However, their utility in targeting bone metastases is relatively less studied. We have examined the hypothesis that systemic therapy of recombinant oncolytic adenoviruses expressing soluble form of TGF β receptor II fused with human IgG fragment (sTGF β RIIFc) can be developed for the treatment of established breast cancer bone metastases. **Experimental Design:** MDA-MB-231-luc2 human breast cancer cells were injected in the left heart ventricle of nude mice to establish bone metastasis. Mice with hind limb tumors were administered (on days 8 and 11) two oncolytic adenoviruses- Ad.sTBRFc or mhTERTAd.sTBRFc. Skeletal tumor growth was monitored weekly by bioluminescence imaging (BLI) and radiography, and body weights were measured twice a week. At the termination time on day 28, hind limb bones were analyzed for tumor burden, synchrotron microcomputed tomography, and osteoclast activation. In a separate experiment, the effect of intravenous delivery of viruses on liver enzyme and liver pathology was also examined. **Results:** Intravenous delivery of Ad.sTBRFc and mhTERTAd.sTBRFc in skeletal tumor bearing mice induced significant anti-tumor activity evaluated by multiple assays. There was significant inhibition of tumor growth measured by *in vivo* BLI and radiography.

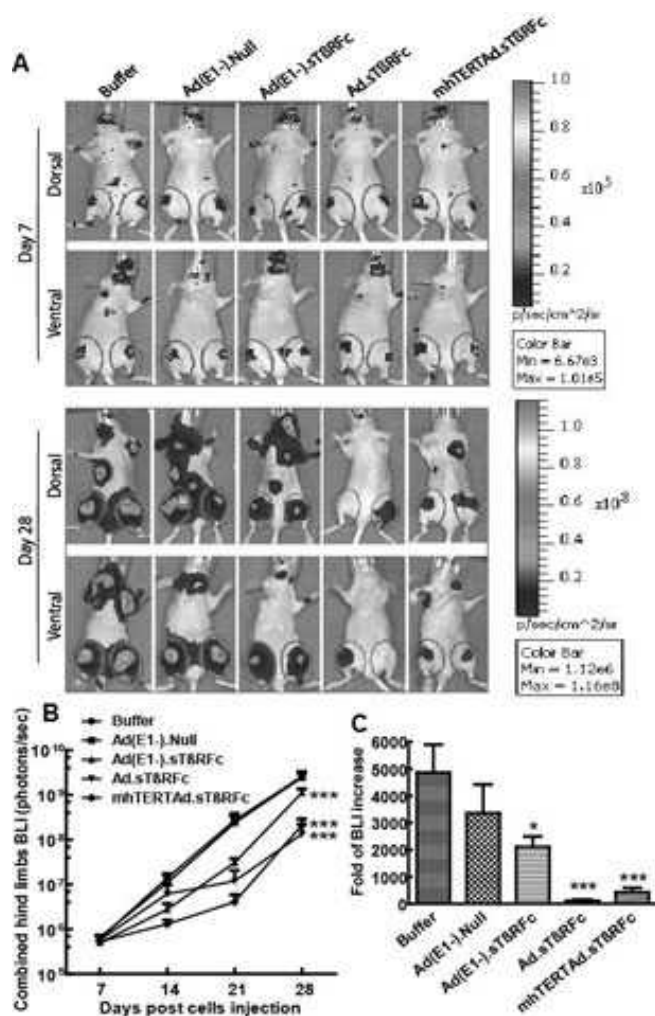

Significant reduction of tumor burden and osteoclast activation, and increased body weight gains were observed. Oncolytic adenoviruses were safer than *dl309*, a wild type virus. Slight elevation of liver enzyme activity was observed by Ad.sTbRfC that subsided with time.

Fig. 1 Hu et al

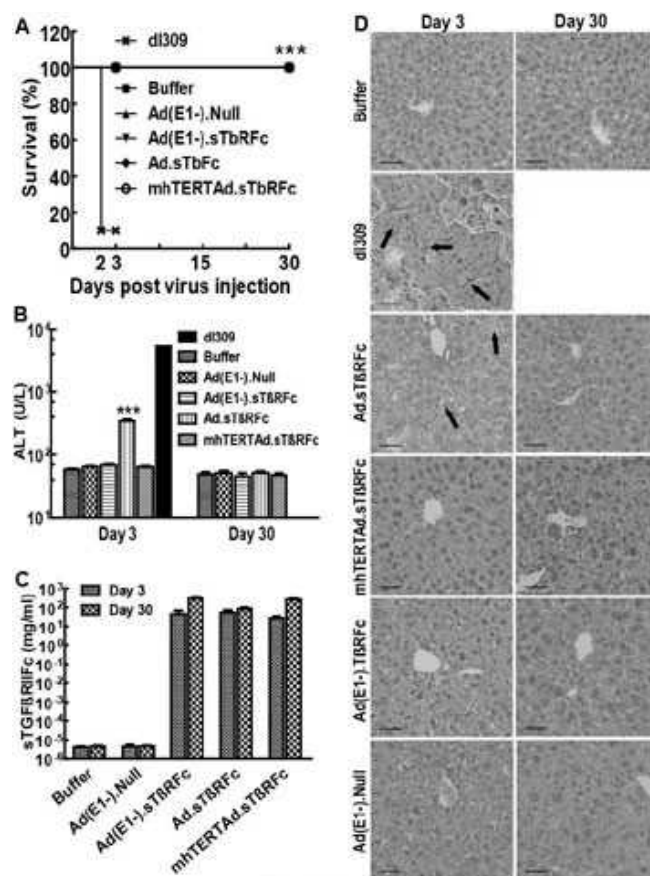

Fig. 2 Hu et al

Conclusions: Systemic delivery of oncolytic viruses Ad.sTbRfC and mhTERTAd.sTbRfC induced significant inhibition of bone metastases and can be developed as a safe and effective approach for the treatment of established bone metastasis of breast cancer.

676. The dNTP Binding Efficiency of Adenovirus DNA Polymerase Contributes to Virus Replication Efficiency and Host Cell Tropism

Cristina Capella-Gonzalez,¹ Michael J. Beltejar,¹ Baek Kim,¹ Stephen Dewhurst.¹

¹Microbiology and Immunology, University of Rochester, Rochester, NY.

Mutations in the viral DNA polymerase of HIV-1 that reduce the efficiency of dNTP substrate utilization result in a selective loss of viral replicative activity in resting cells (which contain low dNTP concentrations), but not in rapidly dividing cells such as cancer cells (which contain high levels of dNTPs). This suggests a potential new approach to the development of oncolytic, conditionally replicating adenoviruses. With this in mind, a series of site-directed mutations were introduced into the DNA polymerase of adenovirus type-5 (Ad5), in regions known to interact with the dNTP substrate or the template strand DNA – including highly conserved domains (motifs A and B and IxGG motif) and key consensus sequences within these domains (Kx3NSxYG within motif B). The introduction of even conservative mutations in these motifs, that are known to have only a modest (5-fold) effect on polymerase function in *in vitro* biochemical assays, had a dramatic effect on viral replicative capacity when studied in the context of an intact, full-length adenovirus genome. Indeed, such mutations completely abrogated virus replication in 15 out of the 20 viral molecular clones constructed. The five replication-competent molecular clones that were recovered were as follows: I664V, I664M,

R665K (IxGG motif mutants) and C687S and M689V (motif A mutants). All replicated efficiently in HEK293 cells, but the I664M, R665K, and C687S mutants exhibited restricted replication in both A549 cells (a human lung carcinoma cell line) and Wi-38 cells (a primary human lung fibroblast cell line). The I664V mutant exhibited replication kinetics essentially identical to those of WT Ad5 in all of the cell lines tested, while the M689V mutant showed restricted replication in cancerous cells (A549), but efficient replication in primary cells (Wi-38) - even though dNTP concentrations in Wi-38 cells (0.1-0.2 μ M) are substantially lower than in A549 cells (1-7-3.3 μ M) or HEK293 cells (1.0-2.3 μ M). Of note, the M689V mutant was also able to establish persistent, productive infection of Wi-38 cells, as reflected by the prolonged expression of an encoded GFP reporter gene - unlike the WT virus, which rapidly killed the Wi-38 cells. We conclude that (i) even modest changes in the enzymatic activity of Ad5 DNA polymerase are sufficient to completely abrogate virus replication, and (ii) that a subset of polymerase mutations can alter virus host cell tropism, and virally-mediated cell killing. These findings have implications for the future development of adenovirus vectors, for both gene transfer and oncolysis applications.

677. In Vitro & Vivo Gene Targeting with Adenoviral Vector Conjugated Magnetic Nanobeads for Cardiac Regeneration

Yue Zhang,¹ Wenzhong Li,¹ Gustav Steinhoff,¹ Nan Ma.¹
¹Uni Rostock, Medicine Facult, Rostock, Germany.

Objectives: we try to test the concept whether delivery of magnetic nanoparticles (MNB) /Adenovirus-VEGF gene could regenerate infarcted hearts in the rat model under the control of external magnetic fields. **Methods:** Adenovirus vector-gene was conjugated to MNBs with the Sulfo-NHS-LC-Biotin linker. *In vitro* transduction efficacy of MNBs/Adenovirus was compared with Adenovirus alone in (MSCs) mesenchymal stem cells under magnetic field stimulation. *In vivo*, in the rat myocardial infarction (MI) model, MNBs/Adenovirus-VEGF complexes were injected intravenously and an epicardial magnet was employed to attract the circulating MNBs/Adenovirus complexes. **Results:** *In vitro*, Compared with Adenovirus alone, MNBs/Adenovirus complexes had a 30- to 50-fold higher transduction efficiency under the magnetic field. *In vivo*, the epicardial magnet effectively attracted MNBs/Adenovirus complexes and resulted in strong therapeutic gene expression in the ischemic zone of the heart. Also compared to Adenovirus group, MNBs/Adenovirus group significantly improved left ventricular function (n=8-10, p<0.05) assessed by pressure-volume loops after 4 weeks. Although there was no significant difference in infarct size between two group (n=8-10, p<0.05), wall thickness of remote area was significantly reduced in MNBs/Adenovirus (n= 6) compared with Adenovirus (n =8). Meanwhile MNBs/Adenovirus group hearts exhibited higher capillary density than Adenovirus group. **Conclusion:** Magnetic targeting enhances transduction efficiency and improves heart function *in vitro* and *in vivo*. This novel method to improve gene therapy outcomes offers the potential into clinical applications.

678. Oncolytic Viruses: A Novel Therapy Against Triple-Negative Breast Cancer

Sepideh Gholami,¹ Chun-Hao Chen,¹ Joshua S. Carson,¹ Dana Haddad,¹ Song Taejin,¹ Joyce Au,¹ Jun Kwong,¹ Yuman Fong.¹
¹Department of Surgery, Memorial Sloan-Kettering Cancer Center, New York, NY.

BACKGROUND: Triple-negative breast cancer (TNBC) is one of the most aggressive cancers, and so-called, as it lacks the expression of common targets for breast cancer therapy: estrogen, progesterone, and HER-2 receptor. Moreover, overexpression of MAPK has been correlated with increased resistance to chemotherapy and recurrence

in patients with TNBC. The objective of this study was to determine the cytotoxic effects of an oncolytic herpes virus on TNBC and to discover the potential correlation of the MAPK pathway in sensitizing TNBC to oncolytic viral therapy. **METHODS:** The cytotoxic effect of a replication-competent herpes virus (NV1066) containing a GFP protein expression cassette was tested on human TNBC cell lines MDA-MB-231, HCC1806, HCC38, HCC1937, and HCC1143 at various multiplicities of infections (MOIs). Proliferation assays were performed to assess cell doubling time. Cytotoxicity was determined using a standard lactate dehydrogenase assay. Viral replication was assessed via standard plaque assay. Pre- and post-viral infection cell lysates were analyzed by Western blotting with antibodies against proteins of interest involved in significant oncogenic signaling pathways. **RESULTS:** All cell lines exhibited similar proliferation rates with an average doubling time of 48 hours. NV1066 infected, replicated in, and killed all TNBC cell lines. GFP expression confirmed viral infection and replication by 24 hours and was proportionate to both viral dosages and cytotoxicity results. At an MOI of 0.1, greater than 90% cell kill was achieved in cell lines MDA-MB-231, HCC1806, and HCC38 by day 6 post-infection. Even in less sensitive cell lines HCC1937 and HCC1143, NV1066 achieved greater than 70% cell kill by day 7 post-infection at an MOI of 1.0.

Figure 1

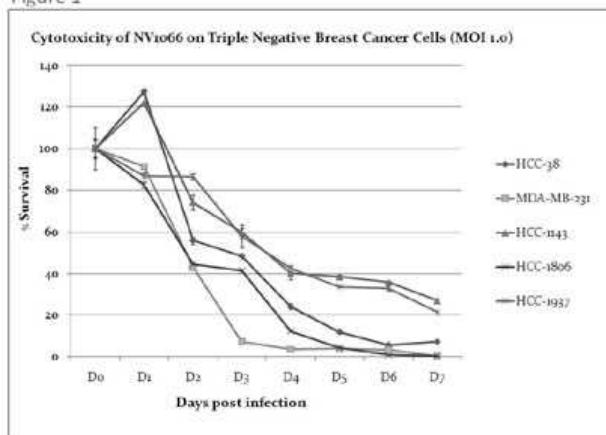

In the most sensitive cell line MDA-MB-231, p-MAPK signaling after 48 hours of infection with NV1066 was inversely correlated to viral replication measured in plaque-forming units (R=-0.78, p<0.05).

Figure 2

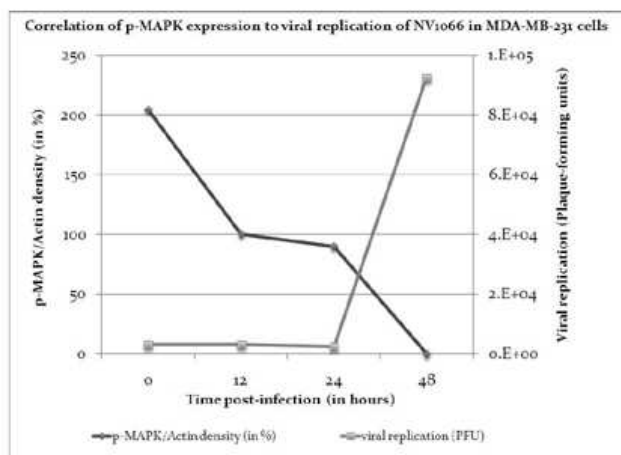

CONCLUSION: To our knowledge, this is the first study to demonstrate efficacy in a viral therapy against TNBC cells. Our results support that NV1066 can infect and kill TNBC. As overexpression of p-MAPK has been correlated with resistance to chemotherapy, the down-regulation of p-MAPK by NV1066 suggests a potential role for NV1066 as an adjuvant therapy in chemoresistant TNBC.

679. Generation of Complex High-Capacity Adenoviral Vectors with Modified Capsids for Applications In Vitro and In Vivo

Martin Hausl,¹ Richard Voigtlander,¹ Zsolt Ruzsics,¹ Anja Ehrhardt.¹

¹*Virology, Max von Pettenkofer-Institut / LMU, Munich, Germany.*

First-generation adenoviral vectors (FG-AdVs) are easy to produce and therefore represent the best option to analyse capsid-modifications or new expression systems. On the other hand high-capacity adenoviral vectors (HC-AdVs) lacking all viral coding sequences are the most attractive option for therapeutic approaches due to reduced toxicity and immunogenicity and high capacity for sequences of interest. Therefore, there is a great interest in a method for adoption and combination of vector-modifications as well as expression systems evaluated in FG-AdVs towards HC-AdVs. Recently we developed a novel platform based on homologous recombination of bacterial artificial chromosomes (BACs) allowing arbitrary modifications. On the basis of the plasmid pHCA-eGFP encoding a HC-AdV genome containing an eGFP expression cassette we showed smooth access to the platform exchanging regular plasmid backbone with BAC backbone. Full potential of BAC technology was demonstrated utilizing a recombination pipeline based on alternating resistances for rapid incorporation of 9 different DNA fragments into one HC-AdV BAC. The resulting BAC pBHCA-2indsys encodes two expression cassettes enabling liver-specific and mifepristone-inducible expression of Renilla luciferase as well as two expression cassettes allowing doxycycline-inducible and stem cell-specific expression of eGFP-Firefly Luciferase reporter construct. For generation of respective HC-AdV we currently utilize column-purified unmodified helper-virus and a fiber-modified variant, constructed by traceless exchange of the fiber with fiber chimera fib5/35. Generated HC-AdV-2indsys will be tested for functionality in hepatocytes and an oct4-expressing cell line. For in vivo applications we modified hexons of the helper-virus to allow repeated administrations. Therefore, we synthesized hexons with precisely exchanged hypervariable regions (HVRs) with respective sequences of other serotypes (Ad12, Ad41, Ad44, Ad48, Ad50). Additionally we generated modified hexons by complete exchanges of domains DE1 and FG1 containing sequences, which encode the HVRs from Ad4, Ad7, Ad12, Ad13, Ad41. Western blot analysis demonstrated intact interaction of modified hexons with adenoviral 100K-protein as well as efficient nuclear uptake and trimerization. Subsequently we replaced the original hexon of a helper-virus BAC with an eGFP/Fluc reporter cassette incorporated in the E3 region with modified hexon sequences. Although rescue of hexon modified adenoviruses is challenging, we could show successful reconstitution of 4 of the above mentioned hexon-modified helper-viruses containing precise as well as complete exchanges of HVRs. During amplification we noted a prolonged time until observing complete cytopathic effect, suggesting impaired virus assembly. Currently, purified viruses are analysed in detail with respect to titers (viral particles and transducing units), biodistribution after intravenous injection in mice and potential to escape neutralizing antibodies in human sera in neutralizing antibody assays.

680. Dual-Expression Adenoviral Vectors in Vaccine Development

Xiangyang Zhou,¹ Juliana C. Small,¹ Dongming Zhou,¹ Raj K. Kurupati,¹ Heng Chen,¹ Ang Bian,¹ Hildegund C. Ertl.¹

¹*The Wistar Institute, Philadelphia, PA.*

We have previously reported on a dual-expression chimpanzee adenoviral vector (AdC7) that we developed to express nucleoprotein (NP) of influenza A virus in E1 locus under the control of CMV promoter and gag of SIV in E3 locus under the control of chicken beta actin (CB) promoter. Both expression cassettes contained the CMV enhancer as well. By using the vectors *in vitro* and *in vivo*, the results showed expression and immunogenicity of the transgene product encoded by the cassette in E1, to be low. In order to enhance immunogenicity, the vectors were modified by removing the CMV enhancer and promoter in front of the NP gene in E1 locus and SIVgag under control of CB promoter without CMV enhancer in E3 locus showed significantly improved immunogenicity for both transgene products. The data suggest that duplication of even small sequences such as an enhancer has to be avoided in the design of dual expression adenoviral vectors, which could be very useful in vaccine development.

681. Ad-TβRIIΔcyt Treatment Decreases Liver Steatosis and Fibrosis by Decreasing mRNA Expression of CB1 Cannabinoid Receptor and TGF-β and Increasing MMP-1

Mayra G. Mena,¹ Ana S. Sandoval,¹ Jazmin Santillan,¹ Juan Armendariz.^{1,2}

¹*Institute of Molecular Biology in Medicine and Gene Therapy, CUCS, Universidad de Guadalajara, Guadalajara, Jalisco, Mexico;* ²*O.P.D. Hospital Civil de Guadalajara "Juan I. Menchaca", Guadalajara, Jalisco, Mexico.*

Introduction: Transforming growth factor β (TGF- β) is the main profibrogenic cytokine; consequently strategies to block its signal pathway have been developed. Gene therapy using a truncated receptor type II for TGF- β (T β RII Δ cyt) had showed to reduce hepatic fibrosis; but its effect on the expression of cannabinoid receptors (CB1 and CB2) which participate in the progression of liver cirrhosis or steatosis has not been elucidated. **Objective:** Evaluate the effects of Ad-T β RII Δ cyt on fibrosis, steatosis and gene expression of profibrogenic molecules and cannabinoid receptors in rat liver. **Material and Methods:** Cirrhosis was induced in male rats administrating carbon tetrachloride (CCl₄) for 8 weeks. Cirrhotic rats were divided into groups (n=6): cirrhotic control, cirrhotic with therapeutic gene (Ad-T β RII Δ cyt) and cirrhotic with irrelevant gene (Ad-GFP). At the 4th week of CCl₄ intoxication, 2x10¹⁰ pi/kg of Ad-T β RII Δ cyt or Ad-GFP was administered via iliac vein. Sacrifice was made at day 2, 3 and 28 after treatment. Fibrosis index, steatosis, hydroxyproline content, gene expression of TGF- β , collagen α 1 (I), PAI-1, MMP-1, CB1 and CB2 were analyzed, as well as, ALT and AST serum levels. **Results:** Treatment with Ad-T β RII Δ cyt decreased 22%, 28% and 35% of fibrotic tissue; while liver steatosis was reduced 47%, 43% and 42%; at day 2, 3 and 28 respectively (p<0.001). Ad-T β RII Δ cyt suppressed expression of profibrogenic molecules: TGF- β (11-fold at day 28), collagen α 1 (I) (11-fold at day 3 and 5-fold at day 28) (p<0.05) and PAI-1 (13-fold at day 2 p<0.05 and 19-fold at day 3 p<0.01) and increased expression of MMP-1 (13.1-fold p<0.01) compared to cirrhotic rats. CB1 gene expression showed a clear tendency to decrease (50% less expression) and CB2 mRNA levels increase to the double compared to cirrhotic controls, even no statistical significance was achieved. Hydroxyproline content decreased 3 fold times (p<0.01) at day 28 after treatment compared to cirrhotic group. Liver function improved significantly in the Ad-

TβRIIΔcyt-treated rats compared to cirrhotic group (AST; 490±126.4 versus 180±58.1 p<0.001 and ALT 469±290.2 versus 102±60.4 p<0.05) at day 28. **Conclusion:** Expression of TGF-β-truncated receptor II prevents fibrosis progression in the liver and improves liver function reducing gene expression of pro-fibrogenic molecules (TGF-β, Col-1, PAI and CB1). Significant reduction in steatosis was also observed when Ad-TβRIIΔcyt therapy was employed and there was a tendency of CB1 to decrease, which suggest that the two phenomena might be related.

682. Development of a Virus-Associated RNA-Deleted Adenovirus Vector

Mitsuhiro Machitani,¹ Kazufumi Katayama,¹ Fuminori Sakurai,¹ Hayato Matsui,¹ Tomoko Yamaguchi,² Takayuki Suzuki,² Kenji Kawabata,^{1,2} Hiroyuki Mizuguchi.^{1,2,3}

¹Biochemistry and Molecular Biology, Graduate School of Pharmaceutical Sciences, Osaka University, Suita, Osaka, Japan; ²Laboratory of Stem Cell Regulation, National Institute of Biomedical Innovation, Ibaraki, Osaka, Japan; ³The Center for Advanced Medical Engineering and Informatics, Osaka University, Suita, Osaka, Japan.

A major limitation of the use of adenovirus (Ad) vectors is the innate immune response, which causes inflammatory cytokine production and tissue damage. To overcome this limitation, it is necessary to develop safer Ad vectors that are less likely to induce this response. The adenoviral genome encodes two noncoding small RNAs, virus-associated (VA)-RNA I and VA-RNA II, which are transcribed by RNA polymerase III and promote adenovirus amplification. Recently, we reported that VA-RNAs are produced in the cells transduced with conventional first-generation (E1-deleted) Ad vector (FG-Ad) and trigger innate immune responses through intracellular nucleic acid sensors. In this study, we have developed a VA-RNA-deleted Ad (AdΔVR) vector from which the transcriptional control elements of the VA-RNA-expression were deleted. First, pAdΔVR-EGFP, a plasmid encoding the *PacI*-flanked AdΔVR vector genome with an EGFP-expression cassette in place of the E1 region, was digested with *PacI* and transfected into 293 cells according to the conventional method for preparing Ad vectors. However, no propagation of the Ad vector was observed. Next, we prepared 293 cells inducibly expressing VA-RNA I under the control of a tetracycline-dependent H1 promoter (VR293 cells). VR293 cells with appropriate induction of VA-RNA I-expression allowed the propagation of the AdΔVR-EGFP vector. The AdΔVR-EGFP vector showed efficient transduction in the cultured cells, comparable to that of the conventional FG-Ad vector expressing EGFP. Furthermore, although the FG-Ad vector shows E1-independent replication in some cultured cells, the AdΔVR vector exhibited significantly lower levels of viral replication than the FG-Ad vector. Given these results, the AdΔVR vector may be a safer alternative to the FG-Ad vector.

683. Pre-Clinical Characterization of Endothelial Cells as Carriers of Oncolytic Adenoviruses

Bart Thaci,¹ Ilya V. Ulasov,¹ Maciej S. Lesniak.¹

¹Neurosurgery, The University of Chicago, Chicago, IL.

Background Cancer remains the second most common cause of death in the developed world. New targeted therapies are being tested in clinical trials. Oncolytic adenoviruses are one of the promising new agents, but delivery to tumors is still unsatisfactory. Systemic delivery of oncolytic adenoviruses to tumors via cell based carriers is very attractive and needs to be optimized. In this work, we show that endothelial cells can deliver fiber modified, survivin driven adenovirus to glioma cells. **Material and methods** Human umbilical vein endothelial cells were screened for surface receptors via flow cytometry. Transduction efficacy of fiber modified viruses (Ad.

Luc-Pk7; Ad.Luc-RGD; Ad.Luc-5/3) was compared to wild-type fiber adenovirus by measuring luciferase expression. Survivin and CXCR4 activity was analyzed via qRT-PCR. Adenoviral replication was quantified by measuring E1A region copy numbers and progeny titer after infection with replication competent CRAΔ.Survivin.5/3. To show that endothelial cells can deliver adenovirus to tumor cells: endothelial cells were infected with CRAΔ.Survivin.5/3 and washed thoroughly before plated in different ratios with U87 glioma cells. Viability was visualized via Crystal Violet assay. **Results** Fiber modifications increased adenoviral transduction 2.5-3.5 folds. Longer incubation time (4h vs. 1 h) during infection enhanced transduction four folds. Survivin expression in endothelial cells was 20 fold higher than CXCR4 and was dependent on the presence of growth factors. It dropped four fold when using starved media instead of growth factor replenished media. The same did progeny titer levels, while E1A copy numbers were affected even more (up to 10 fold). Endothelial cells were able to deliver oncolytic adenovirus and effectively kill glioma cells after co-culture. **Conclusion** Endothelial cells can be used as cell carriers for oncolytic adenoviruses. Increasing expression of survivin in endothelial cell can enhance adenovirus delivery.

684. miR122 Targets Insertion in Wild-Type Serotype 5 Adenovirus To Ablate Liver Replication

Sergio Lavilla-Alonso,¹ Erko Ylösmäki,¹ Kalle Saksela.¹

¹Virology, Haartman Institute - University of Helsinki, Helsinki, Finland.

Adenovirus -based oncolytic therapies present important limitations regarding tissue selectivity and toxicity, an issue well-documented for the commonly used adenovirus serotype 5 (Ad5). Basic research has shown a specific micro-RNA (miR) pattern for many tissues, like the virtually exclusive expression of miR122 by liver. We have shown that this feature can be utilized to selectively ablate adenovirus replication in cells of hepatic origin by genomic insertion of miR122 targets to different reduce E1A gene expression. In this study we have examined in more detail the optimal number of miR122 targets, studied the cell type-specific inhibitory potential of miR122 via careful cell viability analyses, and extended these studies to more relevant experimental systems. These results will provide a rational basis for proceeding towards *ex vivo* and *in vivo* studies to test the applicability of this system for clinical gene therapy purposes.

685. TRAIL-Expressing Oncolytic Viral DNA/Liposome Hybrid Vector for Lung Cancer Gene Therapy

Oh-Joon Kwon,¹ Eunah Kang,¹ Jaerim Kim,¹ Kyungmin Nam,¹ Sung Wan Kim,^{2,3} Chae-Ok Yun.¹

¹Brain Korea 21 Project for Medical Sciences, Institute for Cancer Research, Yonsei Cancer Center, Severance Biomedical Science Institute, Yonsei University College of Medicine, Seoul, Republic of Korea; ²Department of Pharmaceutics and Pharmaceutical Chemistry, University of Utah, Salt Lake City, UT; ³Department of Bioengineering, College of Engineering, Hanyang University, Seoul, Republic of Korea.

Adenovirus (Ad) as cancer molecular therapeutics has been extensively exploited with modification of Ad genetic information, and administration methods *in vivo* for effective delivery. However, delivery efficacy *in vivo* has been limited due to Ad envelopment by pre-existing neutralizing antibody, the liver uptake, and hepatotoxicity of Ad. In this study, as an alternative approach of cancer virotherapy, oncolytic viral DNA delivery via lipid envelopment was investigated for orthotopic lung cancer gene therapy. For synergistic therapeutic effect, multifunctional oncolytic Ad DNA expressing TRAIL as a model of therapeutic protein was generated. Lipid hybrid vectors encapsulating oncolytic Ad DNA, DOTAP:DOPE/H5mT-Rd19/

stTR and PEG:DOTAP:DOPE/H5mT-Rd19/stTR, were prepared to compose of cationic liposome and TRAIL-expressing oncolytic adenoviral DNA. The diameter and zeta potentials of Ad DNA/lipid hybrid vector were characterized, resulting in 152.9 ± 6.3 and 131.5 ± 4.2 nm for DOTAP:DOPE/H5mT-Rd19/stTR and PEG:DOTAP:DOPE/H5mT-Rd19/stTR, respectively, at the optimal DNA: lipid ratio of 1: 6. TRAIL-expressing oncolytic Ad DNA/lipid hybrid vector (DOTAP:DOPE/H5mT-Rd19/stTR) administered intravenously, showed highly effective antitumor effect *in vivo*, compared with naked oncolytic Ad or naked viral DNA on A549 orthotopic lung cancer. Furthermore, biodistribution analyzed by quantitative-PCR and histological analysis showed that preferential viral replication was occurred in lung cancer organ, indicating that the delivery of oncolytic viral DNA expressing therapeutic protein can be a powerful replacement of naked Ad delivery.

DNA Vectorology & Gene Targeting - II

686. Zinc Finger Nuclease Generation for Fanconi Anemia

Mark J. Osborn,¹ Morgan L. Maeder,² J. Keith Joung,² Bruce R. Blazar,¹ Jakub Tolar.¹

¹Department of Pediatrics, University of Minnesota, Minneapolis, MN; ²Department of Pathology, Massachusetts General Hospital, Charlestown, MA.

Fanconi anemia (FA) is a group of inherited bone marrow failure syndromes caused by defective DNA repair and characterized by physical abnormalities, aplastic anemia and an increased risk of malignancies. Hematopoietic cell transplantation (HCT) is an available treatment option for the bone marrow related component of the disease, although there are significant side effects as a result of the procedure. Our long-term goal is to develop safer treatment modalities for FA by correcting the genetic defect in patient derived cells thereby providing a source of autologous, gene corrected cells. We sought to take advantage of the zinc finger nuclease (ZFN) technology as a means to achieve this. To determine whether favorable ZFN target sites were available we analyzed the 5' portion of the FANCA gene using the Zinc Finger Targeter (ZiFiT) Software. This gene was chosen because the mutations described in FANCA are the most common. Moreover, because the reported mutations are scattered throughout the length of the gene we intend to insert a cDNA sequence upstream of all known mutations, thus our reagents will be applicable to all FANCA patients. ZiFiT analysis identified an ideal site for ZFN production by the Oligomerized Pooled ENgineering (OPEN) platform, a method that typically results in the recovery of multiple unique proteins specific for the target site and we successfully recovered four proteins each for the individual half sites of the FANCA target sequence. Zinc finger proteins then were characterized in a bacterial 2-hybrid screen that is a quantifiable assay directly measuring binding affinity of a ZFN candidate for the target sequence. Generally, a 3+ fold activation level above controls is considered a positive indicator of protein function. Our proteins showed a range of activation of 3.1-3.6 fold for the left and 4.95-5.98-fold for the right arrays above controls. To demonstrate the capacity of the ZFN pairs to function as a fully functional heterodimer we tested our candidates in a single stranded annealing assay (SSA). This assay employs the use of two duplicated, truncated halves of the firefly luciferase gene that are interrupted by the ZFN target site, which renders the gene non-functional until successful ZFN-mediated cleavage has occurred. Upon SSA, the gene is repaired using the duplicated halves as templates and gene expression is restored. We observed 4-12 fold activation when the FANCA ZFNs were employed as compared to the SSA template alone. These data demonstrate the functionality of the full FANCA ZFN expression system in a mammalian cellular-based system. These candidates are currently under testing to directly

correct the FANCA phenotype. Our unique strategy, one of the first to describe the successful implementation of the OPEN ZFN generation protocol to synthesize reagents for a human gene involved in disease, will insure gene regulation mediated by an endogenous promoter, is superior to gene replacement strategies in that an intergenic 'safe harbor' sequence is targeted, and is designed to be applicable to FANCA mutations regardless of where they are located.

687. Gene Repair in a Murine Model of SCID-X1

Gabrielle M. Curinga,¹ Michelle Brault,¹ Jordan Jarjour,¹ Jit Kim,³ Byoung Ryu,¹ Andrew M. Scharenberg,¹ David J. Rawlings.^{1,2,3}
¹Center for Immunity and Immunotherapies and Northwest Genome Engineering Consortium, Seattle Children's Research Institute, Seattle, WA; ²Departments Immunology, University of Washington School of Medicine, Seattle, WA; ³Department of Pediatrics, University of Washington School of Medicine, Seattle, WA.

X-linked severe-combined immune deficiency (SCID-X1) is characterized by the inability to mount an effective immune response due to a lack of peripheral T and natural killer cells and dysfunctional (in humans) or absent (in mice) B lymphocytes. SCID-X1 results from inactivating mutations in the gene encoding interleukin 2 receptor-g (*IL2RG*), referred to as the common gamma chain (γ_c); essential for T and NK development and B cell cytokine-dependent survival signals. SCID-X1 is fatal in the first 1-2 yrs of life if not definitively treated by hematopoietic cell transplantation. Importantly, wild type (WT) lymphoid progenitors display a strong selective advantage compared SCID-X1 cells, providing an ideal context for optimizing conditions for gene repair. To this end, a Sce SCID "knock-in" mouse was developed by introducing both stop codon and an I-SceI homing endonuclease (HE) cleavage site into exon 6 of the murine *Il2rg* gene. With the long-term goal of rescuing the SCID-X1 phenotype *in vivo* using gene repair in this model, we completed key benchmarking studies designed to determine: a) if hematopoietic stem cells (HSC) or lymphoid progenitors tolerate I-SceI HE expression; b) whether the endogenous γ_c locus is accessible to HE cleavage; and c) the relative number of repaired HSC required for phenotypic rescue. Transduction of WT, lineage depleted (*lin*⁻), HSC using lentiviral (LV) vectors demonstrated that transient I-SceI expression is well tolerated, although it may confer a mild proliferative disadvantage. Furthermore, I-SceI demonstrated efficient cutting at the endogenous γ_c locus with nearly 25% Sce-SCID *lin*⁻HSC displaying non-homologous end-joining; and this assay likely substantially underestimates cleavage rates as it cannot assess cleavage leading to seamless repair. Finally, transplant experiments with mixed populations of WT and Sce-SCID *lin*⁻ HSC indicate that as few as 0.5%- 1% of engraftable cells must be repaired to rescue T and B cell development. Taken together these data represent crucial steps towards benchmarking gene repair in murine SCID-X1. Current work showing optimization of parameters to achieve repair in *lin*⁻HSC, ES and IPS cells using integrase deficient LV vectors encoding I-SceI; and demonstration of T cell differentiation *in vitro* will also be presented.

688. Novel Dual AAV Vectors To Express an nNOS-Recruiting Mini-Dystrophin Gene for Duchenne Muscular Dystrophy Gene Therapy

Yadong Zhang,¹ Dongsheng Duan.¹

¹Department of Molecular Microbiology and Immunology, School of Medicine, University of Missouri, Columbia, MO.

Duchenne muscular dystrophy (DMD) is a lethal childhood muscle disease. We recently demonstrated that a 7kb synthetic mini-dystrophin gene that can restore neuronal nitric oxide synthase (nNOS) may yield superior protection in the murine models of DMD (J Clin Invest. 2009;119: 624-35). Adeno-associated virus (AAV)

holds great promise in treating all affected muscles in the body. However, AAV application in DMD gene therapy is limited by the 5 kb maximal virion packaging capacity. We have previously developed a series of dual AAV vector strategies for doubling AAV packaging capacity. These include overlapping, trans-splicing and hybrid vector approaches. In dual AAV vectors, a fully functional expression cassette is split into two parts and each part is individually packaged in an AAV virion. Reconstitution is achieved through homologous recombination and/or AAV inverted terminal repeats-mediated viral genome concatamerization. In this study, we first developed two GFP-dystrophin fusion constructs. In one construct, GFP is fused in-frame to the 5'-end of the 7 kb mini-dystrophin gene. In another construct, GFP is fused in-frame to the 3'-end of the 7 kb mini-dystrophin gene. A series of overlapping and hybrid dual AAV vectors were engineered to express the GFP-mini-dystrophin fusion gene. Dual AAV vectors were packaged in Y445F tyrosine mutant AAV serotype-6 vectors. Initial studies in dystrophin-deficient mdx4cv mice revealed robust mini-dystrophin expression and successful recruitment of nNOS to the sarcolemma. Additional studies are currently underway to test functional rescue with these new dual AAV mini-dystrophin vectors (Supported by NIH and MDA).

689. Helper-Dependent Adenovirus with Doxycyclin-Inducible Expression of Zinc-Finger Nucleases for Targeted Transgene Integration in Hematopoietic Stem Cells

Xiaoying Yao,¹ Hongjie Wang,¹ Ruan van Rensburg,¹ Michael Holmes,² Philip Gregory,² Andre Lieber.¹
¹Division of Medical Genetics, University of Washington, Seattle, WA; ²Sangamo Biosciences, Richmond, CA.

Our final goal is to achieve targeted integration of a 26kb β -globin LCR driven β -globin gene cassette (delivered by a helper-dependent adenovirus Ad5/35 vector) in hematopoietic stem cells with subsequent erythroid-specific transgene expression that is protected from epigenomic silencing. A new concept to increase targeted integration involves the placement of site-specific double stranded DNA breaks, which can potentially increase the frequency of gene addition of transgenes delivered in the context of helper-dependent adenoviruses. Site-specific DNA breaks can be catalyzed by zinc-finger nucleases (ZFN). We constructed helper-dependent Ad5/35 vectors expressing ZFNs specific to the Chemokine (C-C motif) receptor 5 (CCR5) gene on human chromosome 3. It has previously been shown that disruption of this target locus has no functional consequence. To avoid potential genotoxic side effects of CCR5 ZFN expression, we placed the ZFN genes under the control of Doxycyclin (Dox) inducible expression systems that are shielded by chromatin insulators and transcription stop signals. An HD-Ad5/35-ZFN vector was produced at high titer. The vector conferred CCR5-ZFN expression only in the presence of Dox. Transient expression of CCR5-ZFN in the HSC model cell line Mo7e conferred knock-out of 50.6% of CCR5 alleles. However, transduction of human CD34+ cells with the HD-Ad5/35-ZFN vector only yielded knock-out in less than 1% of CCR5 alleles. This low efficiency was largely due to the low activity of the minimal CMV promoter linked to tet operator motifs in CD34+ cells. Replacing this promoter with the Ubiquitin or EF1a gene promoter yielded more efficient Dox-inducible transgene expression in CD34+ cells. Based on these findings, we are currently generating a new series of HD-Ad5/35 vectors expressing CCR5 ZFNs. We have also optimized DNA fluorescent in situ hybridization on hematopoietic progenitor colonies to detect site-specific integration of the globin LCR expression cassette into the CCR5 site. Data on CCR5 disruption and transgene integration in CD34+ cells upon transduction with HD-Ad5/35-ZFN and HD-Ad5/35-LCR vectors will be reported.

690. Optimisation of the 2A Co-Expression System for Gene Therapies

Ekaterina Minskaia,¹ Garry Luke,¹ Martin D. Ryan.¹
¹Biomolecular Sciences, University of St. Andrews, St. Andrews, United Kingdom.

39% of all human proteins currently analysed are either secreted from the cell, located within the lumen/membranes of cytoplasmic vesicular structures, or, are plasma membrane proteins. Given that such a high proportion of proteins are initially translocated into the endoplasmic reticulum (ER), many therapeutic strategies rely on the ability to co-express multiple proteins – some, or all of which, might need to be targeted to such sites. This directly applies to *in vivo* gene therapy strategies, or, when therapeutic proteins may need to be co-expressed with selectable markers (e.g. *ex vivo* gene therapies). 2A and '2A-like' sequences are powerful tools that allow multiple proteins to be translated and co-expressed from a single transcript mRNA (comprising a single ORF) under the control of only one promoter. A single ORF is created in which the 2A oligopeptide is positioned between sequences encoding two, or more, genes: 2As mediate a co-translational 'cleavage' at their own C-termini. However, we have shown there is a major problem with co-expression of certain proteins targeted to, or transiting through, the ER: the 'cleavage' activity of 2A is greatly inhibited. We have demonstrated that in such cases sequences immediately upstream of 2A are responsible for these lower levels of 'cleavage' and hence aberrant sub-cellular localisation of some proteins. Such inhibition of 2A-mediated cleavage can be overcome by the use of different lengths of the sequence between the C-terminal region and 2A. We will present our latest findings ('cleavage' data, sub-cellular localisation etc.) on the optimisation of the 2A co-expression system for such proteins. Our work utilised the pDisplay system in which we have inserted a series of 'test' proteins – GFP, HA (influenza virus haemagglutinin) and NA (influenza virus neuraminidase), followed by 2A sequences of various lengths and origin. In addition, a cassette system was created such that residues in the C-terminal 20aa of GFP were systematically mutated with each residue replaced by alanine.

691. A Modular Self-Assembling Peptide Scaffold for Tissue Engineering and Targeted Gene Delivery

Joshua Z. Gasiorowski,¹ Joel H. Collier.¹
¹Department of Surgery, University of Chicago, Chicago, IL.

Our long-term goal is to develop versatile engineered tissues using biomaterials and non-viral gene therapy. Our approach is to embed into a patient a scaffold that acts as a DNA carrier, permits adult stem cell infiltration, and supports cell growth. A delayed, triggered release and delivery of non-viral differentiation vectors specifically within the material could drive *de novo* generation of minimally immunogenic engineered tissue *in vivo* using the patient's own cells. To that end, we developed and synthesized the peptide, Q11 (QQKFQFQFEQQ), which self-assembles into fibrils when solubilized in water and forms a hydrogel that supports cell growth upon exposure to salt containing buffers, such as PBS. Ligands synthesized on the termini of Q11 are functionally presented on the surface of the fibrils. Additionally, there is no antibody response raised against Q11 peptide injected into mice. A previously published study showed that the sequence FQGII non-covalently binds to double stranded DNA molecules in a cell-free assay. We synthesized the FQGII sequence onto the N-terminal end of Q11 (FQGII-Q11). The FQGII-Q11 peptide mixed with Q11 peptide formed fibrillar structures in water and a hydrogel after exposure to PBS or cell culture media. When incubated at 37°C in PBS, hydrogels that contained FQGII-Q11 retained plasmid DNA (pDNA) longer than gels exclusively made of either Q11 or collagen. However, while FQGII-Q11 gels bathed in media retain plasmids,

the gels display triggered release of the DNA when subjected to an electrical field. Various concentrations (1-20mM total peptide) of Q11 and FQGII-Q11 peptides were cast and gelled with pDNA within the wells of a larger agarose gel. We demonstrated that pDNA optimally migrates out of 10mM Q11-based gels and into the agarose when either a continuous voltage or repeated square wave pulses was applied. These data suggest that FQGII-Q11 gels non-covalently associate with pDNA and retain it within the gel until an electrical trigger induces release. Square wave pulses were also used to electroporate cells encapsulated within the Q11-based gels. Three gel types were created: Q11 alone, Q11 + FQGII-Q11, or collagen I. Each gel type was bathed in media with serum and contained encapsulated HEK293 cells and an EGFP non-viral vector. Needle electrodes were used to subject the gels to various square wave pulse parameters. While a minimal number of HEK293s were GFP positive after 48hrs in the Q11 alone or collagen I gels, Q11 gels that also contained FQGII-Q11 resulted in 10-15% GFP positive HEK293 cells. Owing to the modular properties of these self-assembling peptides, we synthesized a RGD-Q11 cell adhesion peptide that can co-fibrillize with other Q11 peptides. Electroporated gels that contained RGD-Q11, FQGII-Q11, and Q11 improved HEK293 transfection efficiency to 50% after 48hrs. We have subsequently transfected NIH 3T3 fibroblasts and the pluripotent mouse stem cell line, C3H10T1/2 with the same technique. Further experiments are being conducted to optimize these materials and parameters. Ultimately, this method may prove useful to target differentiation genes to adult stem cells that specifically infiltrate the biomaterial in vivo, resulting in therapeutic engineered tissues.

692. Analysis of 2A-Mediated 'Cleavage'

Valerie Odon,¹ Garry Luke,¹ Martin D. Ryan.¹

¹*Biomolecular Sciences, University of St. Andrews, St. Andrews, United Kingdom.*

Many therapies require the co-expression of multiple therapeutic proteins, possibly in combination with selectable marker(s). For multimeric protein complexes or proteins with linked functions (e.g. pathways), functionality requires co-expression of each gene of interest within the same cell. Various strategies have been adopted to achieve such co-expression: multiple promoters, alternative RNA splicing, the use of internal ribosome entry sequences (IRESes) etc., but we have pioneered the use of 2A and '2A-like' oligopeptide sequences. Here, multiple genes (stop codons removed) may be concatenated via 2A 'linkers', to create a single long open reading frame (ORF). When ribosomes translate the 2A oligopeptide sequence, the nascent peptide interacts with the ribosome to produce a co-translational ribosome 'skipping' event in which the synthesis of a specific peptide bond (at the C-terminus of 2A) is skipped – producing a discontinuity in the polypeptide backbone: critically at each 2A site. Crucially, multiple discrete protein products can be derived from a single transgene. Although first characterised from the positive-stranded RNA virus Foot-and-Mouth Disease virus (Picornaviridae), we have identified and determined the ribosome skipping – or 'cleavage' - activity of 2A-like sequences from other picornaviruses, positive / double-stranded RNA insect viruses and mammalian rotaviruses. A motif present at the C-terminus of the 2A oligopeptide (-D[V/I]ExNPGP-) is very highly, though not completely, conserved and has enabled us to identify other putative 2A-like sequences. The sequence upstream of this motif shows, however, no conservation between 2As of different viruses. We have proposed that this region interacts with the exit tunnel of the ribosome to bring about a pause in processivity and we assume that this can be accomplished by a number of alternative interactions. Since these 2A and 2A-like sequences function in all eukaryotic systems tested to date (but not prokaryotic), they have been used extensively in biomedicine and biotechnology for protein co-expression. Furthermore, since these sequences act co-translationally, artificial polyprotein systems may comprise internal signal sequences

to localise different protein translation products to different sub-cellular sites. We have performed extensive site-directed mutagenesis (SDM) on a range of 2A-like sequences and have created a series of 'hybrid' 2As comprising different consensus motifs juxtaposed with different upstream contexts as part of our detailed analyses of the mechanism of 2A-mediated 'cleavage'. Here we present analyses of the 'cleavage' activities of a range of new, naturally-occurring, 2As together with SDM data and artificial, hybrid, 2A-like sequences.

693. A Molecular Tool for Gene Integration and Generation of Isogenic Mammalian Cell Lines

Samantha A. Stuckey,¹ Francesca Storici.¹

¹*School of Biology Biology, Georgia Institute of Technology, Atlanta, GA.*

We have developed a plasmid construct (pI-CLONE) which serves to integrate desired DNA sequences into a defined genomic locus of mammalian cells, generating Isogenic CLONES, and which provides for a cell phenotype following integration. pI-CLONE contains a promoter-less green fluorescent protein (GFP) gene, which is disrupted by the open reading frame of the red fluorescent protein (RFP) gene and also contains a rare and unique restriction enzyme site into which potentially any DNA sequence of choice can be cloned. The principle of this system is that this construct can be used to target a homologous GFP locus already present on the chromosome of the cell line of choice and generate a fusion between the targeted GFP gene and the promoter-less RFP gene. Upon recombination, the RFP can be expressed and yields red fluorescent cells that can be identified using fluorescent microscopy, expanded and sorted to obtain monoclonal cell lines containing the desired insert at the defined GFP locus. We initially tested the pI-CLONE construct for recombination with a targeted plasmid containing the GFP gene disrupted by the I-SceI endonuclease recognition site in human embryonic kidney (HEK 293) cells. The results showed that recombination had occurred between the two plasmids and that the pI-CLONE construct could be utilized to integrate sequences into chromosomal DNA. We then transfected pI-CLONE into a modified HEK 293 cell line containing a GFP locus disrupted by the I-SceI recognition site and we observed red fluorescent cells, indicative of recombination between the plasmid sequence of pI-CLONE and the targeted chromosomal DNA. By using this system, various isogenic mammalian cell lines can be generated by cloning the sequences of choice into pI-CLONE and transfecting these constructs into the same cell line containing the GFP gene. When the functions of different genes or DNA motifs are compared with one another, it is extremely important to use isogenic cell lines, differing only for the specific gene or motif each integrated in the same genomic locus, as DNA topology, sequence context and genetic background can have a huge influence on gene expression, regulation, chromatin remodeling, etc. Thus, this new system could be an invaluable tool for studies of functional analysis and potentially for applications in gene therapy and genetic engineering.

System for generating isogenic CLONES

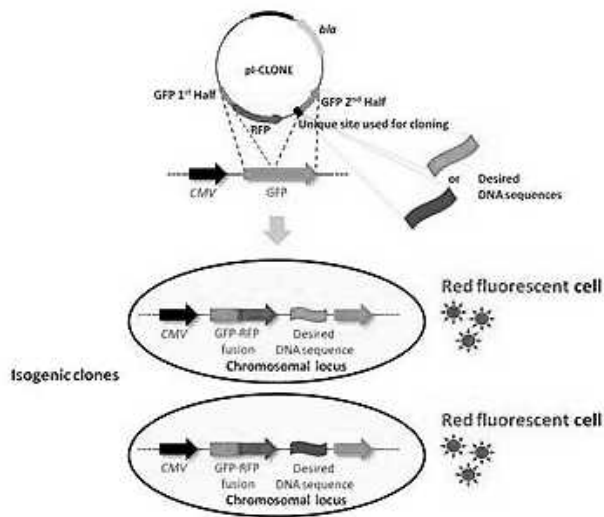

694. Customized Antibiotic Free Non-Viral Plasmid Vectors for Therapy and Vaccination

Jeremy M. Luke,¹ Justin M. Vincent,¹ Clague P. Hodgson,¹ James A. Williams.¹

¹Research & Development, Nature Technology Corporation, Lincoln, NE.

We have developed minimal regulatory agency compliant antibiotic-free (AF) DNA medicine plasmid vectors that incorporate and express a 150 bp antisense RNA that represses expression of a host strain chromosome-encoded sucrose counter-selectable marker (*SacB*). These sucrose selectable vectors combine AF selection with highly productive fermentation manufacturing (>1 g/L plasmid DNA yields). Plasmid-mediated transgene expression was dramatically improved by incorporation of transient expression enhancers. These include the nuclear localizing SV40 72 bp enhancer (incorporated upstream of the CMV enhancer), mRNA translational enhancer HTLV-I R region (incorporated as part of Exon 1 and Intron 1 downstream of the CMV promoter) and Protein Kinase R (PKR)-inhibiting Adenoviral VA RNAI (VA1) RNA translational enhancer. The resultant NTC8685 vector is a dramatically more potent minimal AF DNA medicine vector for therapy or vaccination applications. A variety of *Escherichia coli* host strains are popular for production of plasmid DNA. However, host strains differ in specific characteristics such as epigenetic modification of the plasmid DNA via *dcm* methylation. We used isogenic *dcm* +/- strain pairs to produce plasmid DNA. Interestingly, *dcm*+ plasmid increased immunogenicity while *dcm*- plasmid further increased transgene expression. Thus it is critical to lock the plasmid methylation pattern (*i.e.* production strain) early in product development and *dcm*- strains are superior for DNA therapies. For DNA vaccination, plasmid-mediated immunostimulation was augmented using vector backbone-encoded agonists of the retinoic-acid-inducible gene 1 (RIG-I) innate immune receptor. RIG-I is a critical cytoplasmic double stranded RNA (dsRNA) pattern receptor required for innate immune activation in response to viral infection. Activation of RIG-I leads to type I interferon and inflammatory cytokine production through IPS-1 activation. Expression of RIG-I agonist immunostimulatory RNA from DNA vaccine vector backbones activated innate immunity and improved adaptive immune responses to an encoded influenza antigen. Thus DNA vaccine potency may be augmented by incorporation of RIG-I activating immunostimulatory RNA into the vector backbone.

695. pFARs, Plasmids Free of Antibiotic Resistance Markers, Display High-Level Transgene Expression in Muscle, Skin and Tumour Cells

Corinne Marie,¹ Gaëlle Vandermeulen,² Mickaël Quiviger,¹ Magali Richard,¹ Véronique Préat,² Daniel Scherman.¹

¹Unité de Pharmacologie Chimique et Génétique et d'Imagerie, INSERM U1022, CNRS UMR8151, Université Paris Descartes, Faculté de Pharmacie, Chimie-ParisTech, Paris, France;

²Louvain Drug Research Institute, Unité de Pharmacie Galénique, Université Catholique de Louvain, Brussels, Belgium.

Background Nonviral gene therapy requires a high yield and a low cost production of eukaryotic expression vectors that meet defined criteria such as biosafety and quality of pharmaceutical grade. To fulfil these objectives, we designed a novel antibiotic-free selection system. **Methods** The proposed strategy relies on the suppression of a chromosomal amber mutation by a plasmid-borne function. We first introduced a nonsense mutation into the essential *Escherichia coli* *thyA* gene, resulting in thymidine auxotrophy. The bacterial strain was optimised for the production of pFARs that are small and novel plasmids devoid of antibiotic resistance markers and encoding an amber suppressor t-RNA. Finally, the potentiality of pFARs as eukaryotic expression vectors was assessed by monitoring luciferase activities after electrotransfer of LUC-encoding plasmids into various tissues. **Results** The introduction of pFARs into the optimised bacterial strain restored normal growth to the auxotrophic mutant and allowed an efficient production of monomeric supercoiled plasmids. The electrotransfer of LUC-encoding pFAR into muscle led to high luciferase activities, demonstrating an efficient gene delivery. In transplanted tumours, transgene expression levels were superior after electrotransfer of the pFAR derivative, as compared with a plasmid carrying a kanamycin resistance gene. Finally, in skin, whereas luciferase activities decreased within three weeks after intradermal electrotransfer of a conventional expression vector, a sustained luciferase expression was observed with the pFAR plasmid. **Conclusions** Thus, we designed a novel strategy for the efficient production of biosafe plasmids and demonstrated their potentiality for nonviral gene delivery and high-level transgene expression in several tissues.

696. The p5 Promoter Sequence of AAV Genome Regulates the Direction of Transgene Insertion into the AAVS1 Site

Masashi Urabe,¹ Satsuki Miyata,¹ Akira Onishi,¹ Tomonori Tsukahara,¹ Hiroaki Mizukami,¹ Akihiro Kume,¹ Keiichi Ozawa.¹

¹Division of Genetic Therapeutics, Jichi Medical University, Shimotsuke, Tochigi, Japan.

The adeno-associated virus (AAV) integrates its genome into a particular location in human chromosome, termed AAVS1 (19q13.4) through the activity of specific replicase/integrase protein, Rep. The Rep78 or Rep68 protein binds to both the AAVS1 and the viral inverted terminal repeat (ITR) and mediates site-specific integration of the AAV genome. A transgene linked with the ITR sequence can be targeted into the AAVS1 in the presence of the Rep. Besides the ITR sequence, the p5 promoter that drives the transcription of Rep68/78 mRNA is a cis element for the AAVS1 integration and efficiently directs the site-specific integration as well. Both the ITR and the p5 promoter sequences include two consensus sequences, Rep binding site (RBS) and the terminal resolution site (trs). The Rep protein binds the RBS and then nicks at the trs, which is the first event in the integration. To examine which consensus sequence can be best for AAVS1-specific integration, we molecularly dissected the ITR and p5 consensus sequence into two portion, RBS and trs, and constructed a series of plasmids harboring chimeric cis elements consisting of RBS derived either from the ITR or the p5 promoter and trs either from the

ITR or the p5. Following co-transfection of HeLa cells with a chimeric RBS/trs plasmid and a Rep68 plasmid, AAVS1-specific integration of RBS/trs plasmid was detected with semi-quantitative PCR using an AAVS1-specific primer and either a transgene- or backbone-specific primer. Any RBS/trs plasmids examined were delivered into AAVS1. However, the direction of AAVS1-specific integration of RBS/trs plasmid was considerably different. Particularly the combination of the RBS and the trs sequence both from the p5 promoter sequence more tightly regulate the direction of the plasmid insertion. These findings indicate that the mechanism underlying the AAVS1-specific integration via the ITR and the p5 promoter sequence differs and provide important information for developing a gene insertion technology based on AAV integration.

697. Improvement of Gene Targeting at the Human rDNA Locus by Zinc Finger Nucleases

Youjin Hu,¹ Di Xiao,¹ Xionghao Liu,¹ Lingqian Wu,¹ Desheng Liang.¹

¹State Key Laboratory of Medical Genetics, Central South University, Changsha, Hunan, China.

Viral and non-viral gene delivery systems have been mainly used in gene therapy study. A significant drawback of non-viral vector is the lack of chromosomal integration that makes it difficult to obtain sustained transgene expression, and viral random integration may have genotoxic side effects by misregulating expression of nearby genes or by disrupting cellular genes, therefore, non-viral vector has been considered as a very important alternative choice. pHrneo is a human ribosomal DNA (hrDNA) targeting vector previously constructed by our group, which can target the exogenous gene into the hrDNA locus. However, the low targeting efficiency limits its further application. Zinc finger nucleases (ZFNs) that consists of Zinc finger protein and the cleavage domain of the FokI type II restriction endonuclease can stimulate homologous recombination significantly through creating DNA double-strand breaks (DSBs) near the target sites. In the present study, two pairs of ZFNs targeted to an endogenous site of the human *rRNA* gene (pHrneo target-site) were designed by modular-assemble assay. The affinity of zinc finger protein binding to the targeting site was confirmed by chromatin immunoprecipitation. The cleavage capacity at the target site was assayed by the IVTT in-vitro cleavage assay. The DSBs created by ZFNs were detected using immunofluorescence staining. The targeting efficiency of pHrneo carrying a GFP cassette was improved by ~26 times when co-transfected with the ZFNs in the HT1080 cells.

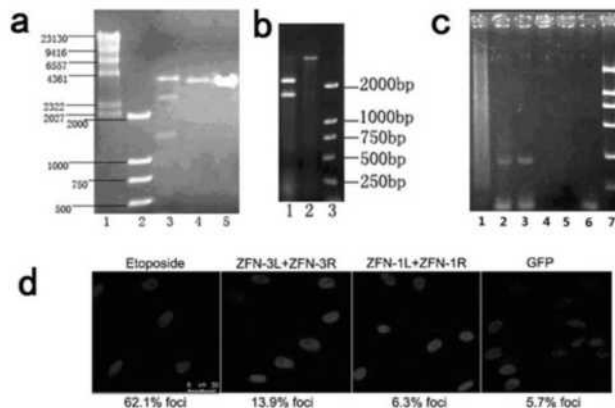

For the first time, our findings show that the created DSBs at 1kb away from the target site can effectively stimulate the improvement of target efficiency, indicating that many more target sites can be used for improving the gene targeting by ZFNs. Figure 1. Gene targeting in HT1080 cells. After co-transfected with pHrneo-GFP and ZFNs, targeted HT1080 cells were selected by adding G418, and several

clones were selected on day12. **a**, Clones selected after transfected with pHrneo-GFP; **b**, clones selected after cotransfected with pHrneo-GFP and ZFN-3; **c**, characterization of the selected clones by PCR. About 1.4kb band appeared in the lane corresponding to the clones underwent site-specific integration.

698. Nonviral-Mediated Endostatin Delivery Results in Inhibition of Fibrosarcoma Growth

Jianxiong Peng,^{1,2} Lingqian Wu,¹ Xionghao Liu,¹ Desheng Liang.¹

¹State Key Laboratory of Medical Genetics, Central South University, Changsha, Hunan, China; ²Faculty of Laboratory Medicine Xiangya School of Medicine, Central South University, Changsha, Hunan, China.

The antitumor effect of endostatin is extensively studied and transgene has become an alternative method to deliver endostatin. To evaluate the anti-tumor efficacy of *endostatin* when expressed transiently and stably, a human ribosomal DNA (hrDNA) targeting vector plasmid containing recombinant human *endostatin* was constructed.

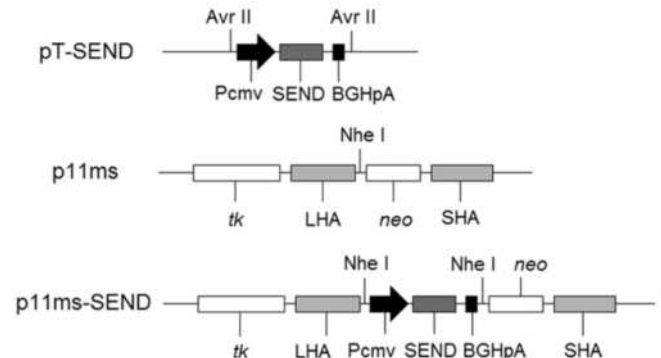

In the case of transient expression of *endostatin in vivo*, the plasmid mixed with liposome or amino-modified silica nanoparticles (SiNP) was injected into the implanted human fibrosarcoma (HT1080) in nude mice. In the stable expression group, the HT1080 cells with *endostatin* stable transgene were implanted into the mice (*ex vivo*). The bioactivity of the human endostatin secreted by the cells clones with stable transgene and durable expression was assayed *in vitro*. The expression of *endostatin in vitro* and *in vivo* was confirmed by RT-PCR, western blot and immuno-histochemistry. The antiangiogenic action of *endostatin* was assessed by micro-vessel density stained with CD 34.

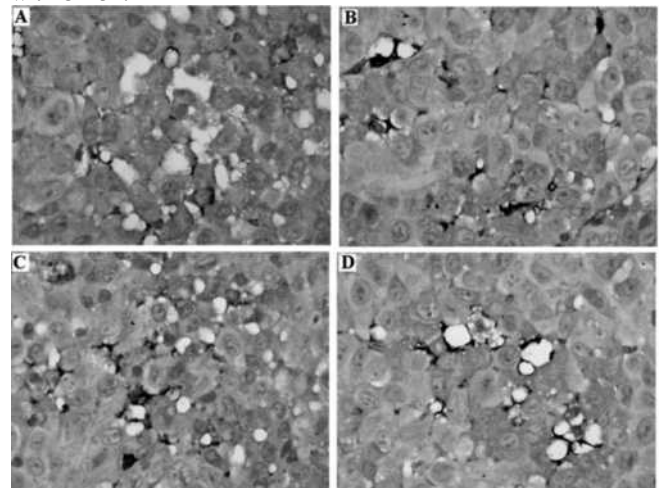

Comparing with the control, the tumor volume was reduced by 93% in stable expression group, and 56% and 42% respectively in DNA-SiNP and DNA-liposome group. Tumor forming rate was 35% in the

stable expression group and 94% in the control. It is concluded that, by using a nonviral delivery system of the hrDNA targeting vector, the cells integrated with stable transgene could continuously secret functional endostatin and the stable *endostatin* transgene showed more efficacy than the transient one in inhibition of tumor growth *in vivo*. Figure 1. Construction of the recombinant human endostatin-hrDNA targeting plasmid (p11ms-SEND): a SEND expression cassette with Pcmv and BGHpA was cut from pT-SEND by Avr II and inserted to the Nhe I site of p11ms to construct p11ms-SEND. The pT-SEND and p11ms vectors were constructed by our group; Pcmv: cytomegalovirus promoter; SEND: human insulin signal sequence (S) and human *endostatin* (END) fusing gene; BGHpA: bovine growth hormone polyadenylation sequences; *tk*: thymidine kinase gene; LHA: long homologous arm (NT_029490: 359770-361392); *neo*: neomycin resistance gene; SHA: short homologous arm (NT_358269-359769). Figure 2. Micro-vessel density change in various implanted tumors with *endostatin* transient and stable expression. A: HT1080 cells (control); B: HT1080 cells infused with *endostatin* liposome-DNA; C: HT1080 cells infused with *endostatin* SiNP-DNA; and D: HT1080 cells with *endostatin* stable expression.

699. The Role and Fate of Excess Polycations in Chitosan-Based Gene Delivery

Marc Thibault,¹ Melina Astolfi,¹ Marc Lavertu,¹ Vincent Darras,¹ Michael D. Buschmann.¹
¹Chemical Engineering, Ecole Polytechnique, Montreal, QC, Canada.

Transfection efficiency of chitosan-pDNA polyplexes is critically modulated by its structure and by parameters of polyplex preparation such as the ratio of the polycation's amine to DNA phosphate (N:P). Efficient N:P ratios are found empirically and usually involve the use of excess polycation versus DNA, where a significant amount of the polycation remains free in solution, unassociated with the polyplexes. The mechanism by which excess polycation increases transfection efficiency remains unclear. The purpose of this study was to clarify the role of the excess polycation during transfection. We hypothesized that excess polycations is essential for the intracellular lysosomal escape of the polyplexes. The experimental design incorporated endpoint transfection using chitosan-pDNA polyplexes formulated at different N:P ratios in rescue experiments where free chitosan was added to polyplexes and intracellular trafficking was monitored. The essential role of excess chitosan was first highlighted by demonstrating that the low transfection of polyplexes seen at low N:P ratio can be dramatically rescued by addition of free chitosan before or at various time-points after polyplex addition. The kinetics of rescue, combined with intracellular trafficking data of polyplexes at N:P 5, and polyplex uptake data strongly suggested that the role of excess chitosan was mainly downstream of uptake. Live cell imaging further revealed prolonged colocalization of low N:P polyplexes within lysosomes compared to both rescued or N:P 5 samples. Taken together, these data demonstrate that excess polycation is required for optimal chitosan-based transfection by promoting a sustained intracellular release of internalised polyplexes from endo-lysosomal vesicles into the cytoplasm.

700. Rep of AAV Inhibits HSV Amplification by Degradation PML-NBs Proteins That Necessary for ICP0 Mediated Viral Processes

Jinzhong Chen,¹ Ran Wang,¹ Jinjin Wang,¹ Limin Wan,¹ Jing-lun Xue.¹

¹State Key Laboratory of Genetic Engineering, Institute of Genetics, School of Life Sciences, Fudan University, Shanghai, China.

AAV need helper virus to finish its replicate cycle. Viral early proteins such as ICP0 or E1B are the key factor for initiating AAV replication. On another hand, AAV was reported that presented antiviral activity to adenovirus, HSV and so on. Our work established a Vero derived cell line (Vero-Rep) that integrated with a p5 droved rep expression frame. The rep expression of the cells was increased after HSV infection. The replications of HSV with ICP0 were decreased while the replications of the HSV strain without ICP0 were not changed anymore.

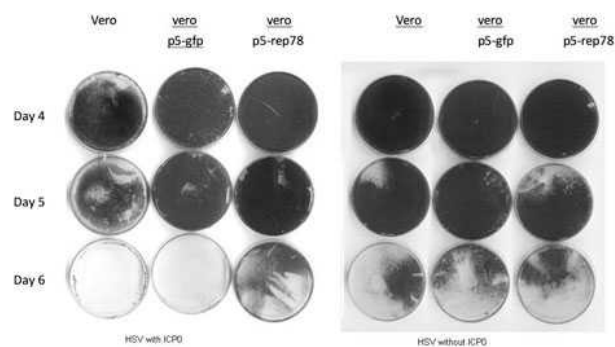

After HSV infection, the PML-NBs of Vero-Rep cell were fade away more early than that of Vero cell. The protein level of PML-NBs (such as PML, SP100, TTRAP) was decreased with expressing rep78.



pcDNA3.1	+	-	+	-	+	-
rep78	-	+	-	+	-	+
Sp100	+	+	-	-	-	-
ttrap	-	-	+	+	-	-
PML	-	-	-	-	+	+

The results suggested that rep interfere the early viral processes which depend on the PML-NBs and result in decreasing the viral replication.

Physical Methods of Delivery II

701. Piezoelectric Permeabilization of Mammalian Dermal Tissue for In Vivo DNA Delivery Leads to Enhanced Protein Expression and Increased Immunogenicity

Kate E. Broderick,¹ Thomas Kardos,¹ Jay R. McCoy,¹ Michael P. Fons,¹ Stephen Kemmerer,¹ Niranjan Y. Sardesai.¹
¹Research and Development, Inovio Pharmaceuticals, San Diego, CA.

Electropermeabilization of mammalian cells is a technique that has been used for the delivery of therapeutics, such as DNA plasmids or DNA vaccines. Typically, delivery via electropermeabilization occurs through injection of the substance into the tissue of interest followed by the insertion of electrodes at the site and the application of brief electrical pulses. Here we detail a novel and innovative contactless electropermeabilization method to deliver DNA plasmids to dermal tissue in vivo. This process has the advantage of eliminating the insertion of additional needles that serve as electrodes to facilitate the application of electric pulses in conventional electroporation processes. Plasmid encoding GFP was injected into guinea pig skin and pulsed with the novel contactless electropermeabilization method. Three days following treatment, robust GFP expression was observed on the skin of pulsed animals. Strong humoral immune responses were also achieved when a DNA vaccine expressing the influenza antigen NP was delivered and pulsed using the novel device in comparison to naked injection alone. This delivery method has the advantage of being contactless and suggests that gene transfer via this mode warrants further development.

702. Combination Chemo-Antiangiogenic Therapy for Metastatic Colorectal Carcinoma

Lalitha Belur,¹ Kelly M. Podetz-Pedersen,¹ Brent Sorenson,¹ Daniel Saltzman,¹ S. Ramakrishnan,¹ R. Scott McIvor.¹
¹Genetics, Cell Biology and Development, University of Minnesota, Minneapolis, MN.

The liver is the primary site for metastasis of colorectal cancer, with disseminated disease reported in as many as 50-70% of patients. We have previously shown that treatment of murine CT26 colorectal cancer leads to a decrease in hepatic metastases, resulting in increased survival of animals treated with an antiangiogenic Sleeping Beauty (SB) transposon plasmid. Here we use a combination of antiangiogenic and chemotherapeutic approaches to treat hepatic colorectal metastases, thereby targeting both tumor cell and endothelial cell compartments with the hope of achieving improved antitumor efficacy. Balb/c mice were administered syngeneic CT26 colorectal tumor cells via the spleen, allowing the cells to seed into the liver through the portal circulation, followed by splenectomy, thereby confining tumor formation to the liver. Mice were allowed to develop tumors, followed by weekly intraperitoneal treatments with 100 mg/kg 5-fluorouracil (5-FU). Animals were then hydrodynamically injected with 25 microgram of an antiangiogenic transposon plasmid containing an angiostatin-endostatin fusion gene (pT2/SAE). Mice were sacrificed at 30 days and evaluated for tumor burden. Animals that were treated with 5-FU alone showed a significant decrease in tumor burden in comparison with untreated animals, based on the number of tumor metastases as well as liver weight (i.e. tumor burden; $p < 0.05$). Furthermore, animals that received both 5-FU and pT2/SAE transposon plasmid exhibited a substantial and significant antitumor effect; Tumor burden (liver weight) was one-fourth that of untreated controls, and there were significantly fewer tumor nodules ($p < 0.0001$) in the 5FU/SAE treated animals as well. These results demonstrate that combined treatment of colorectal hepatic metastases by conventional chemotherapy along with an antiangiogenic transposon

plasmid was effective in decreasing tumor burden compared to either treatment alone. Histological studies as well as survival studies to evaluate the effect of the SB transposase on sustained expression of SAE are currently in progress.

703. Nanosecond Electric Pulses Modulate the Expression of Electrotransferred Genes

Aude Silve,¹ Marie Gilbert,¹ Vanessa Joubert,¹ Julien Villemejeane,¹ Luis M. Mir.¹
¹UMR 8203, CNRS Institut Gustave Roussy, Villejuif, France.

Nanosecond electric pulses, contrary to the classical electroporating electric pulses (usually longer than 100 μ s) are able to modify not only the cell external membrane but also the internal membranes of the cells. They can induce thus internal cell signalling pathways that may affect cell physiology in various ways that are still under exploration. For example using very short and intense electric pulses of 10 ns and 20 to 50 kV/cm, it is possible to generate calcium peaks in the cell cytosol. In an attempt to analyse whether the expression of genes coded by plasmids can be affected by nanosecond electric pulses, we introduced a plasmid coding for luciferase into cells in vitro using classical gene electrotransfer procedures. A few (1 to 20) nanosecond pulses were applied between 15 and 45 min after the electrotransfer. They induced no modification of the cell membrane permeability to DNA. Luciferase expression was measured 24 h after the gene electrotransfer. We report that luciferase expression can be increased or decreased (by at least a factor of 3) depending on the applied pulse parameters and on the exposure system used. The exposure conditions are critical, as they dictate the number of pulses necessary to modulate gene expression as well as the enhancing or inhibiting influence of the effects of the nanosecond pulses.

704. The Amaxa Nucleofector System and Standard Electroporation: A Comparison of the Efficiency of DNA Nuclear Localization

Marta H. Ekstrom,¹ David A. Dean.¹
¹Department of Pediatrics, University of Rochester, School of Medicine and Dentistry, Rochester.

Nuclear localization of plasmids is an essential step in all non-viral transfections. Further, it has been shown that the more DNA that localizes to the nucleus, the greater the levels of gene expression. A number of methods have been developed to introduce DNA into a cell, including electroporation. One proprietary electroporation system, the Amaxa Nucleofector, claims that it promotes cellular and nuclear entry of DNA, accounting for high transfection efficiencies. While the application of electric impulses in electroporation causes non-permeant membranes to transiently "open" for DNA entry, electrical field theory shows that permeable membranes (such as the nuclear envelope which contains nuclear pores) cannot be electroporated. Thus it is unclear how the Nucleofector can achieve enhanced nuclear localization. To determine whether Nucleofection increases the amount of transfected DNA that localizes to the nucleus, we compared the subcellular localization of labeled DNA in several different cell types using standard electroporation and optimized Amaxa protocols. Using fluorescence microscopy to visualize the localization of Cy3-labeled DNA in TC7 and A549 cells, there was no observed difference in the number of cells with nuclear DNA nor the amount of DNA localized to the nucleus when comparing the Nucleofected cells to cells transfected using standard electroporation. Another method used to compare the two systems looked at transcriptionally active plasmids by transfecting GFP-MS2 stably expressing cells with DNA plasmids containing repeats of the RNA hairpin loop sequence with which the GFP-MS2 protein binds. Active transcription, observed as punctate redistribution of the GFP-MS2 fusion proteins, showed no significant difference between cells that were Nucleofected as

compared to those transfected using standard electroporation. While the Amaxa Nucleofection system achieves comparable transfection results to standard user-optimized electroporation, our data does not support the claim of increased nuclear localization of transfected DNA with this system.

705. Development of Electromotor-Driven Injector for Hydrodynamic Gene Delivery

Takeshi Yokoo,¹ Kenya Kamimura,¹ Takeshi Suda,¹ Masafumi Oda,² Guisheng Zhang,³ Dexi Liu,³ Yutaka Aoyagi.¹

¹Division of Gastroenterology and Hepatology, Graduate School of Medical and Dental Sciences, Niigata University, Niigata, Japan; ²Center for Cooperative Research, Niigata University, Niigata, Japan; ³Department of Pharmaceutical Sciences, School of Pharmacy, University of Pittsburgh, Pittsburgh, PA.

An electromotor driven injector (*HydroJector-EM*) for hydrodynamic gene delivery has been developed. Different from the previously built injection device (*HydroJector*)¹ that uses the pressure from a gas tank for injection, the new system employs a pulse width modulation control to produce a time-pressure curve using a program stored in a computer. *HydroJector-EM* is shown capable of performing hydrodynamic injection following various pressure profiles preloaded. The controllability and gene delivery efficiency of the new device were assessed *in vivo* using rat liver as a model. Experimentally, the tip of an injection catheter was placed via the inferior vena cava (IVC) of the rats (200 g) at the vicinity of the IVC and hepatic vein conjunction, and pCMV-Luc plasmids in saline (5 g/ml) were injected under the temporal occlusions at supra- and infra-hepatic IVC. Pressure was detected through the portal vein by inserting a catheter with a connection to a transducer. When an intravascular pressure profile was set as an exponential curve reaching 30 mmHg in 8.5, 10, or 20 sec, *HydroJector-EM* followed the time-pressure curve and injected approximately 14, 12, and 15 ml, respectively. The level of luciferase gene expression reached the highest level at 74 pg luciferase/mg of extracted proteins with the injection time of 10 sec. Such a level of reporter gene expression is similar to that following a standard manual hydrodynamic injection or using *HydroJector*-based injection. These results suggest that *HydroJector-EM* can achieve the efficient hydrodynamic gene delivery through the precise control of the pressure. Assessment of this new injection device for hydrodynamic gene delivery in large animals will provide evidence in support of its clinical application. This work was supported in part by JSPS grant 22890064 and SUMITOMO FOUNDATION grant 100033. Reference: 1. Suda T, Suda K and Liu D (2008) Computer-assisted hydrodynamic gene delivery. *Mol Ther* 16:1098-1104.

706. Protein Transfer into Human Cells by VSV-G Induced Nanovesicles

Philippe E. Mangeot,¹ Sandra Dollet,¹ Mathilde Girard,² Claire Ciancia,¹ Marc Peschanski,² Vincent Lotteau.¹

¹INSERM, INSERM U851, Lyon, France; ²ISTEM, Institute for Stem Cell Therapy and Exploration of Monogenic Diseases, Evry, France.

The present study describes the use of VSV-G-induced nanovesicles for the delivery of exogenous proteins into human cells. VSV-G overexpression in human cells promotes the release of fusogenic-vesicles, gesicles, embarking proteins from producer-cells and able to transfer them to recipient-cells. This method allowed the delivery of cytoplasmic, nuclear or surface proteins in human cells. The transfer of a protein and its function by gesicles is rapid, transient and not imputable to a transfer of mRNA or DNA. Among other examples, gesicles were efficient in delivering TetR transcriptional regulators in recipient cells as well as the mCAT-1 protein, the receptor for the

murine leukemia virus. Delivery of mCAT-1 into human primary fibroblasts notably allowed generation of induced pluripotent stem cell in BSL2 upon transduction of reprogramming factors with ecotropic retrovectors.

707. A Proteoliposome Containing Apolipoproteins A-I Mutant (V156K) Enhances Rapid Tumor Regression Activity of Human Origin Oncolytic Adenovirus in Carcinogen Induced Tumor-Bearing Zebrafish

Jung-Heun Park,¹ Seori Jin,¹ Kyung-Hyun Cho.¹

¹School of Biotechnology, Yeungnam University, Gyeongsan, Korea.

We recently reported that the efficiency of adenoviral gene delivery and the stability of the virus were significantly enhanced when a proteoliposome (PL) containing apolipoproteins (apo) A-I was used in several cell and zebrafish models. In the current study, we tested tumor removal activity of oncolytic adenovirus (Ad) using a PL containing either WT or V156K. Oncolytic Ad with or without PL was injected into tumors of zebrafish (36 weeks old, n=7), which were exposed to N-nitrosodiethylamine (DEN) solution (final 100 ppm) for at least 24 weeks. Three epidermal injections of each PL-Ad or Ad alone (5.7 x 10⁶ virus particles, 36 ng of protein in 100 nL per injection) were performed into the tumor site with a 24-hour interval. At 24 hours post-injection, the V156K-PL-Ad-injected zebrafish had up to a 15% reduction in tumor tissue. WT-PL-Ad showed a weaker oncolytic effect (4% reduction). However, injection of Ad alone showed almost no tumor removal activity. Histologic analysis revealed that tumor tissue increased the number of hematoxylin-stained cells, indicating cell division was active and rapid. The hematoxylin and eosin-stained area was decreased in V156K-PL-Ad-injected zebrafish, while WT-PL-Ad-injected fish had darker and increased stained areas. The swimming pattern was more active and rapid after removal of the tumor by V156K-PL-Ad injection. Conclusively, the anti-tumor effect of oncolytic Ad was strongly enhanced by a PL containing V156K-apoA-I without causing side effects.

708. Delivery of VEGF165 To Enhance Healing of Ischemic Skin Flaps in Rats Using a Multi Electrode Array (MEA)

Gaurav Basu,¹ Harre Downey,¹ Siqi Guo,¹ Richard Heller.¹

¹Frank Reidy Research Center for Bioelectrics, Old Dominion University, Norfolk, VA.

Electroporation (EP) is a direct non-viral *in vivo* method of gene delivery of proteins with therapeutic potential. Several groups, including ours, have shown the efficiency of EP for the delivery of plasmid DNA to cells in a variety of target tissues including skin and muscle. The skin is an attractive target for plasmid delivery since it is easily accessible, less invasive and also provides a significantly greater surface for administering the gene of interest. Several studies have shown that delivery of Vascular Endothelial Growth Factor (VEGF) successfully increases angiogenesis, collateral vessel formation, and blood flow in animal models of ischemia. Therapeutic delivery of angiogenic growth factors is an attractive approach for the treatment of ischemia which has been demonstrated by the use of virally mediated gene delivery which may have side effects. The delivery of VEGF to ischemic areas have been promising however, the level of VEGF expression needs to be regulated to avoid adverse affects, such as hemangioma formation, while inducing formation of blood vessels. In previous studies, we demonstrated the efficiency of non-viral VEGF165 delivery to skin flaps utilizing a four plate electrode which significantly accelerated healing and flap survival. The use of plate electrodes has its limitations with regard to the area of treatment, high muscle twitching and discomfort. Recently our

group developed a non-penetrating multi electrode array (MEA) comprising of 16 non-penetrating and non-invasive electrodes. The MEA was shown to efficiently deliver a reporter gene with much reduced muscle twitching compared to the four plate electrode. In this study, we evaluate the efficacy of the MEA in the delivery of angiogenic growth factor VEGF165 for the treatment of ischemic skin flaps in rats. We use a plasmid encoding the human VEGF165 isoform under the control of the hEF1-HTLV promoter (pVEGF). An intradermal injection of pVEGF in ischemic skin flaps followed EP using the MEA significantly enhanced wound healing and increased flap survival compared to injection of plasmid alone. Our study is evaluating several parameters with regard to the MEA aided delivery of VEGF165 to ischemic skin flaps. These parameters include determining the percentage of flap to be treated to obtain efficient healing, optimal treatment time points and optimal plasmid dose. We are continuing to further evaluate the delivery of pVEGF165 using electrodes as a potential therapeutic approach to treat ischemic skin flaps.

709. Synthesis and Evaluation of Stearylated Hyaluronic Acid Material for Active Liposomal Delivery to Liver Endothelial Cells

Naoyuki Toriyabe,¹ Yasuhiro Hayashi,¹ Mamoru Hyodo,¹ Hideyoshi Harashima.¹

¹Faculty of Pharmaceutical Sciences, Hokkaido University, Sapporo, Hokkaido, Japan.

[Purpose] Recently, it is becoming apparent that liver endothelial cells are involved with liver diseases such as chronic hepatitis and hepatic cirrhosis, however, development of specific delivery system for liver endothelial cells still remains a major challenge. In this study, new lipid-hyaluronic acid conjugate was synthesized and evaluated for efficiently deliver cargos to liver endothelial cells. [Method] Hyaluronic acid (HA) was condensed with stearylamine (SA) to make HA-SA conjugate with amide linkage in the presence of EDC and NHS. HA modified and non-modified radiolabeled liposomes were injected in mice intravenously and evaluated the accumulation in the liver. Finally, intrahepatic distribution of HA modified liposome was evaluated by confocal imaging. [Result] When the incorporation ratio of SA was around 50 to 100%, HA-SA was difficult to dissolve any solvents thus difficult to use. HA modified liposomes rapidly and significantly accumulated in the liver compared to non-modified liposomes. From confocal imaging analysis, HA modified rhodamine labeled liposomes colocalized with lectin signal, which suggests that HA modified liposomes is highly accumulated in endothelial cells. [Conclusion] Stearylated hyaluronic acid is a useful material for delivering bioactive liposomal cargo to liver endothelial cells.

710. Sonoporation of Plasmid DNA Driven by Glucagon Promoter to Pancreatic Islet α -Cell for Diabetes Gene Therapy

Jeong H. Park,¹ Minhyung Lee,² Hye S. Jung,³ Chang S. Yoon,³ Tae K. Kim,¹ Min J. Kwon,¹ Soon H. Lee,¹ Kyung S. Ko,¹ Byung D. Rhee,¹ Mi K. Kim.⁴

¹Internal Medicine, College of Medicine, Inje University, Busan, Korea; ²Medial Engineering, Hanyang University, Seoul, Korea; ³Paik Institute for Clinical Research, Inje University, Busan, Korea; ⁴Internal Medicine, Maryknoll General Hospital, Busan, Korea.

Gene therapy approaches for diabetes has mainly aimed insulin secreting pancreatic islet β -cells. Genes of growth factors and signaling molecules have been used to transfect remaining β -cells of diabetes for proliferation or re-arming against apoptosis. In advanced diabetic state, the absolute number and the amount of insulin secretion from the β -cells are known to be much reduced, so not the optimal

target for the exogenous gene transfection, especially therapeutic genes are driven by the insulin promoter for the β -cell specificity. On the contrary, glucagon secreting α -cells which are the main cellular component of diabetic islets are well known to be proliferated and overly active in diabetic state. Recent several reports showed that α - and β -cells are very closely linked anatomically and physiologically via vascular and paracrine connections. Our study was performed to verify that the gene transfection into α -cells of primary islets could influence the pathophysiology of diabetic β -cells in islets. We cloned α -cell specific plasmid DNA driven by glucagon promoter expressing GFP and GLP-1. UTMD (Ultrasound Microbubble Destruction, Sonoporation) was employed to deliver plasmid DNA into cultured α -cell line and the primary mouse and rat islets. Merged images from immunohistochemical double (insulin, glucagon) staining showed the expression of GFP only in the α -cells. Transfection of GLP-1 plasmid DNA driven by glucagon promoter to the α -cells of isolated primary mouse and rat islets showed the increased expression of Ki-67 and the several signaling molecules involved in the anti-apoptotic defense and the proliferation in the β -cells of transfected islets, presumably via paracrine action. In conclusion, α -cells of diabetes islets could be the alternative target for the gene therapy approaches toward β -cells, and might be better technique due to the increased number and abnormally enhanced glucagon promoter activity of α -cells in diabetic state.

711. Non-Invasive Electro-Gene Delivery to the Skin Using a Multiple Electrode Array

Siqi Guo,¹ Amy Donate,¹ Gaurav Basu,¹ Kathryn Lundberg,¹ Loree Heller,¹ Richard Heller.¹

¹Frank Reidy Research Center for Bioelectrics, Old Dominion University, Norfolk, VA.

Skin contains a large number of potent antigen-presenting cells as well as an abundant blood supply, which may help transgenic products distribute into distant organs through circulation. These advantages make delivery of therapeutic genes to the skin very attractive, particularly, for i) the treatment of local diseases; ii) the correction of systemic or metabolic disorders; iii) vaccination against infectious diseases as well as non-infectious diseases like cancer. Comparing to the most current skin electro-gene delivery systems utilizing invasive electrodes, we are particularly interested in the development of effective gene delivery to the skin using non-invasive electrodes. Previously, we demonstrated the effectiveness of skin electroporation (EP) and reported the gene-expression pattern using a non-invasive multielectrode array (MEA). In this study, we have further evaluated a similar designed MEA with different electrode gap and determined the characterization of expression of a therapeutic protein (Factor IX) delivered to guinea pig skin using EP with MEA. Evaluation of the MEAs with different electrode gaps has included transgenic expression, DNA distribution and the correlation between the expression level and amount of area treated. We observed that the pattern of gene expression, DNA distribution and gene-expressing location were similar between MEAs with 2mm and 3mm gap electrodes. We found two types of gene expression after EP skin delivery with the MEA. One is local expression around DNA injection site with the duration of 1-2 days; another is epidermal expression distant from DNA injection site with the duration around 2 weeks. Only the latter pattern is specifically related to MEA EP. Currently, we are performing experiments to observe whether we can achieve the effective level of factor IX in the circulation by delivering DNA to the skin using EP with the MEA.

Genetic and Metabolic Diseases Gene & Cell Therapy III

712. Hematopoietic Stem Cell Gene Therapy with a Lentiviral Vector for the Multi-Systemic Lysosomal Storage Disorder Cystinosis

Frank Harrison,¹ Brian A. Yeagy,¹ Donald B. Kohn,² Daniel R. Salomon,¹ Stephanie Cherqui.¹

¹Department of Molecular and Experimental Medicine, The Scripps Research Institute, La Jolla, CA; ²Department of Microbiology, Immunology and Molecular Genetics and Pediatrics, University of California, Los Angeles, Los Angeles, CA.

Cystinosis is an autosomal recessive metabolic disease that belongs to the family of lysosomal storage disorders. Cystinosis results from a genetic defect in the gene CTNS encoding the lysosomal cystine transporter protein, cystinosin. Cystine accumulates in every tissue compartment and leads to multi-organ dysfunction and failure including blindness, diabetes, myopathy, end stage renal failure and central nervous system defects. Using the murine model for cystinosis, Ctns^{-/-} mice, we showed that syngeneic bone marrow cell (BMC) or hematopoietic stem cells (HSC/Sca1+) but not mesenchymal stem cell (MSC) transplantation could correct cystinosis (Blood, 2009). Organ-specific cystine content was reduced by 57% to 94% in all tissues tested in the BMC or HSC-treated mice. Abundant bone marrow-derived cells were observed in all tissues. Most of these cells were not lymphoid lineage, but part of the intrinsic structure of the organ. The natural progression of renal dysfunction was prevented and deposition of corneal cystine crystals was significantly improved in the treated mice. The present work represents preclinical studies using the latest generation of lentiviral vectors to deliver the CTNS gene to autologous HSC in the Ctns^{-/-} mice. Optimization of the HSC transduction protocol has been done using lentiviral vectors expressing either GFP or luciferase reporter genes. At MOI=10, GFP expressing cells in peripheral blood ranged between 50-90%, which was stable up to 1-year post-transplant. Stable luciferase expression was also observed in multiple tissues up to 1-year post-transplant in live mice using the IVIS imaging system. Ex vivo transduced HSC using a lentiviral vector expressing the CTNS gene led to significant decreases of cystine levels 4 months post-transplant in all the tissues tested except the kidney: 52.3% brain, 38.8% eye, 21.6% kidney, 51.5% liver, 53.0% muscle and 53.4% spleen. No toxicity or clonal dominance has been observed to date. Additional experimental groups currently underway will have the same testing at 8 and 12 months after transplantation. This work represents a preclinical proof of concept for using genetically modified HSC transplantation for cystinosis in a clinical trial. The key point here is that our results clearly demonstrate that in the mouse model of cystinosis, delivery of a functional CTNS gene by HSC transplantation works extremely well. In fact, beyond our original expectations given the fact that cystinosis is a multi-systemic disease and cystinosin is an intracellular, transmembrane, lysosomal protein as opposed to a secreted enzyme like many lysosomal storage disorders. Therefore, another level of innovation in this work is a potential proof of concept for bone marrow cell transplantation to reverse multi-systemic disease caused by other dysfunctional intracellular transmembrane proteins.

713. Towards Lentiviral Gene Therapy for the Treatment of Pompe Disease

Merel M. Stok,¹ Helen H. de Boer,¹ Trudi T. P. Visser,¹ Arnold J. J. Reuser,¹ Elza E. D. van Deel,¹ Dirk-Jan D. J. Duncker,¹ Niek N. P. van Til,¹ Gerard G. Wagemaker.¹

¹Erasmus Medical Center, Rotterdam, Netherlands.

Pompe disease is an autosomal recessive lysosomal storage disease, characterized by progressive muscle weakness and death within the

first year of life in its most severe form. Pompe disease is caused by mutations in the gene encoding acid alpha-glucosidase (GAA) and its deficiency results in elevated levels of glycogen. Enzyme replacement therapy is the current option for treatment, but is not beneficial to all patients, may result in antibodies against the recombinant enzyme and the costs are high. Therefore, we have developed an alternative single intervention therapy, based on transplantation of modified autologous hematopoietic stem cells (HSC). The use of autologous HSC has the intrinsic advantage to induce immune tolerance to the recombinant transgene product and minimizes the risk of transplantation related mortality and morbidity. We used an *ex vivo* lentiviral vector mediated gene therapy strategy to modify syngeneic hematopoietic stem cells in an adult mouse model of Pompe disease. We evaluated the effectiveness of the native sequence of the transgene and a codon-optimized transgene. Using the strategy outlined above, life-long high levels of (human) alpha-glucosidase were achieved in leukocytes and affected tissues of Pompe mice using relatively mild conditioning with the spleen focus forming virus (SF) promoter driving the native sequence. Also, with the native sequence, glycogen storage was reduced significantly in heart, diaphragm, but not in skeletal muscle. We found near normalization of heart morphology and function. Most importantly, after a robust challenge of the treated animals with rhGAA protein, an immune response was absent, contrary to a vigorous response in wild-type or GFP treated control mice. To improve efficacy further, the use of the SF promoter driving a codon-optimized GAA gene (GAAco) resulted in even higher levels of GAA activity relative to those by the native sequence in all affected tissues (including skeletal muscle) and an almost complete reduction of glycogen storage. Heart morphology and function as well as skeletal muscle function were maintained, while initial results also indicate lower glycogen levels in brain tissue. Thus, *ex vivo* hematopoietic stem cells lentiviral vector mediated gene therapy results in correction of the Pompe phenotype in the relevant mouse model and would be suitable for further clinical exploration.

714. Chimerism of Bone Marrow Reduces the Glycolipid Storage in Fabry Disease Mice

Takayuki Yokoi,^{1,2,3} Hiroshi Kobayashi,^{1,2,3} Yoshikatsu Eto,³ Nobuyuki Ishige,⁴ Teruyuki Kitagawa,⁴ Makato Otsu,⁵ Hiromitsu Nakauchi,⁵ Hiroyuki Ida,^{1,2,3} Toya Ohashi.^{1,2,3}

¹Department of Pediatrics, The Jikei University School of Medicine, Tokyo, Japan; ²Department of Gene Therapy, Institute of DNA Medicine, The Jikei University School of Medicine, Tokyo, Japan; ³Institute of Genetic Diseases, The Jikei University School of Medicine, Tokyo, Japan; ⁴Tokyo Health Service Association, Tokyo, Japan; ⁵Division of Stem Cell Therapy, Center for Stem Cell and Regenerative Medicine, University of Tokyo, Tokyo, Japan.

Fabry disease (FD) is one of lysosomal storage disorders (LSDs), characterized by deficient activity of lysosomal enzyme, Alpha-galactosidase A. This results in glycolipid, globotriaosylceramide (GL3), storage in various organs. Hematopoietic stem cell (HSC) transplantation and Hematopoietic stem cell-based gene therapy is a candidate to offer the permanent correction for FD. However, the minimum requirement of enzyme activity to reduce the glycolipid storage is still unknown. In this study we used a mouse model of FD to establish what level of engraftment and enzyme activity is required to reduce the glycolipid storage. Lethally irradiated FD mice were transplanted with normal bone marrow cells (C57BL/6.Ly5.1) mixed with those of FD mice (C57BL/6.Ly5.2) at various ratios. Chimerism remained stable at 8 weeks after transplantation and differentiation of transplanted cells to granulocytes, monocytes, B cells and T cells were equally. Enzyme activity increased to reduce glycolipid significantly in spleen and lung by 30% chimerism and in heart by 50% chimerism. The results indicate that the possibility of developing effective and efficient conditioning protocols for LSDs. And Stem cell gene therapy

may require only a low level of normal or gene-corrected cells for a permanent and therapeutic outcome.

715. Lentiviral Transduction of MPS1 Bone Marrow Cells Results in High Production of alpha-L-Iduronidase In Vivo

Henk Rozemuller,¹ Petra Moerer,² Niek P. van Til,³ JaapJan Boelens,¹ Tom J. de Koning,⁴ Anton C. Martens,² Gerard Wagemaker,³ Nico M. Wulffraat.¹

¹*Pediatrics, University Medical Center, Utrecht, Netherlands;*
²*Immunology, University Medical Center, Utrecht, Netherlands;*
³*Hematology, Erasmus University Medical Center, Utrecht, Netherlands;*
⁴*Metabolic Diseases, University Medical Center, Utrecht, Netherlands.*

Mucopolysaccharidosis type I (MPS1, Hurler syndrome) is caused by a deficiency of the enzyme alpha-L-iduronidase (IDUA) and is characterized by glycosaminoglycan (GAG) accumulation causing multi-organ failure. Although enzyme replacement therapy or hematopoietic stem cell (HSC) transplantation constitutes significant improvement of disease phenotype, there is still a lack of effect of those therapies on the central nervous system and the skeleton. Aim of this study is to obtain improved correction of disease in MPS1 mice, including central nervous system and skeletal defects, by overexpression of IDUA in hematopoietic cells. Lentiviral vectors with the spleen focus forming virus- (SF) and phosphoglycerate kinase- (PGK) promoters driving codon optimized human IDUA cDNA (IDUAco) expression were constructed. These vectors were used to transduce male lineage-negative (Lin-) MPS1 bone marrow cells with an average of 1 to 2 vector copies per cell, which was confirmed by quantitative PCR (Q-PCR). Transduced bone marrow cells were subsequently transplanted in 3-week-old 6 Gy irradiated MPS1 female mice. Since matched donor HSC transplantation in MPS1 patients is currently the preferred treatment, control MPS1 mice were transplanted with syngeneic wildtype Lin- cells. Blood and urine samples were collected monthly. On average 80% male cell chimerism was observed in peripheral blood containing 30% IDUA positive cells up to 7 months after transplantation. IDUA levels in blood were 500- and 80-fold of normal wild type levels for the SF-IDUAco and PGK-IDUAco, respectively, or normalised in wildtype bone marrow transplanted MPS1 mice. Analysis of GAG secretion in urine revealed normalization to wild type levels for all transplantation groups. At month 7, the mice were sacrificed and assessment of GAG levels in spleen, liver, lung, heart, and kidney demonstrated significant reduction of GAGs to normal levels. Most importantly, GAG accumulation was significantly decreased in brain in accordance with high levels of IDUA. CT analysis of the skeleton revealed significant improvement of the bone thickness. We conclude that the IDUAco vectors provide long-term expression of high levels of IDUA, resulting in concomitant reduction in GAG secretion in urine, reduction of GAG in other organs, including brain, and in a significant improvement of the skeletal deformations. This warrants further development towards clinical application.

716. Optimisation of Lentiviral Transduction Conditions of Haematopoietic Stem Cells for Treatment of Mucopolysaccharidosis Type IIIA (MPSIIIA)

Ana Sergijenko,¹ Alex Langford-Smith,¹ Kia Langford-Smith,¹ Rob Wynn,² J. Ed Wraith,³ Simon Jones,² Fiona Wilkinson,¹ Brian Bigger.¹

¹*University of Manchester, Manchester, United Kingdom;* ²*Royal Manchester Children's Hospital, Manchester, United Kingdom;* ³*St. Mary's Hospital, Manchester, United Kingdom.*

MPSIIIA is caused by a mutation in the *SGSH* gene, leading to disruption of the substrate degradation pathway in lysosomes and a phenotype of severe neurodegeneration. We have shown that lentiviral gene therapy using transplanted haematopoietic stem cells (HSCs) corrects the neurological phenotype in a mouse model of MPSIIIA. The aims of this project are to generate a clinically applicable vector, develop a more efficient transduction protocol for HSCs, and assess vector safety. Lentivirus production was optimised to reduce production cost by using less DNA (10.5 ug/ plate) and a PEI transfection reagent. Transduction of HSCs was also optimised. The addition of MG132 with cytokines and BSA improved transduction by 10%, and addition of valproic acid (VA) increased stem cell numbers by 35%. High titres (2×10^8 IU/ml) of three lentiviral vectors encoding *GFP* gene driven by a ubiquitous (*PGK*) or monocyte specific (*CD11b* and *CD18*) human promoters were made and tested *in vitro* in a number of cell lines, and then *in vivo*, by transplanting transduced lineage depleted cells into wild type mice. Flow cytometry showed that over 80% of donor cells were transduced. Blood and bone marrow cells were further stained for flow cytometry to assess promoter specificity. Improved *SGSH* encoding cDNAs were made. It was shown that HSCs transduced with *GFP* encoding virus had 3 fold more copy numbers than cells transduced with *SGSH-long* (cDNA + 3' and 5' UTRs). The copy number was increased when using a codon-optimised *SGSH* (*SGSH-CO*) (cDNA only) and remained high when a stop mutated *SGSH-CO-X* was used, suggesting that vector size, not *SGSH* toxicity is important in HSC transduction. *SGSH-CO* produced more *SGSH* activity than the non-codon-optimised *SGSH*. We are currently assessing *PGK-SGSH-CO*, *CD11b-SGSH-CO*, and *CD18-SGSH-CO* in a clinically relevant lentiviral backbone in MPSIIIA mice, with 6 and 12 month follow up to assess therapy and safety. We have shown that addition of MG132 and VA to HSCs increased stem cell numbers and percentage of transduced HSCs. We have also shown that vector size is important in HSC transduction, that *SGSH* activity is increased by codon optimisation, and therapy is more specific when using cell lineage promoters. This is a promising clinical therapy for MPSIIIA.

717. Disease Improvement with Neonatal Intracranial AAV and Systemic Lentiviral Gene Therapy in Sanfilippo Syndrome Type B Mice

Coy D. Heldermon,¹ Elizabeth Qin,² Kevin K. Ohlemiller,³ Erik D. Herzog,⁴ Carole Vogler,⁵ Mark S. Sands.²

¹*Medicine, University of Florida, Gainesville, FL;* ²*Internal Medicine, Washington University in St. Louis, St. Louis, MO;*
³*Otolaryngology, Washington University in St. Louis, St. Louis, MO;*
⁴*Biology, Washington University in St. Louis, St. Louis, MO;*
⁵*Pathology, St. Louis University, St. Louis, MO.*

Sanfilippo Syndrome type B (MPS IIIB) is a lysosomal storage disease resulting from the deficiency of N-acetyl glucosaminidase (NAGLU). We have previously shown that intracranial AAV-based gene therapy improves several aspects of the disease such as lifespan. In an attempt to correct the disease in the mouse model, MPS IIIB mice were treated at 2-4 days of age with intracranial AAV2/5-NAGLU (AAV), intravenous lentiviral-NAGLU (MND)

or both (AAV/MND). Compared to untreated MPS IIIB animals, all treatments resulted in significant improvements in the clinical phenotype. AAV, MND and AAV/MND treatment results in improved motor function compared to untreated controls using a rocking rotarod paradigm. Auditory-evoked Brainstem Response measurements of hearing also demonstrate improvement in all treatment groups. Circadian rhythm analysis reveals an improvement in time to activity onset and percent of activity during daylight in the AAV group, little improvement with MND alone, and near normalization with AAV/MND treatment. Each treatment group had a significantly increased lifespan compared to the untreated group (median survival=322 days), with the combination arm the most profound (median survival=612 days, $p<0.0001$), relative to AAV (463 days, $p<0.001$) and MND (358 days, $p=0.009$). In summary, intracranial AAV and systemic MND gene therapy result in disease improvement in MPS IIIB mice both alone and in combination. The combination treatment is most effective at correcting circadian activity, rotarod performance, hearing, and lifespan.

718. Aortic Dilatation in Mucopolysaccharidosis VII Mice Cannot Be Ameliorated by Deficiency of Cathepsin S or Matrix Metalloproteinase Activity, but Can Be Markedly Ameliorated by Marked Reductions in Expression of an As-yet-Unknown Gene That Prevents Upregulation of Inflammatory Pathways

Guilherme Baldo,¹ Ruth Howe,¹ Susan Wu,¹ Russell Knuteen,² Meera Ramamoorthy,¹ Robert Q. Meecham,² Katherine Ponder.²
¹Internal Medicine, Washington University School of Medicine, St. Louis, MO; ²Cell Biology, Washington University School of Medicine, St. Louis, MO.

Mucopolysaccharidosis VII is due to deficient activity in β -glucuronidase (GUSB) activity, and results in accumulation of the glycosaminoglycans dermatan, heparan, and chondroitin sulfate. Mice have marked dilatation (~2-fold normal diameter) and aortic regurgitation. Histologically the aortas from MPS I mice have fragmented elastin fibers, and increases in RNA and enzyme activity for cathepsin S and matrix metalloproteinase 12 (MMP12), leading us to hypothesize that one or both of these elastin-degrading enzymes led to elastin degradation and dilated aortas. To test this hypothesis, MPS VII mice were crossed with Cathepsin S and MMP-12 deficiency mice, all of which were on a 57BL/6 background. Although aortas from triple-deficient mice were less dilated at 1.9 \pm 0.6 mm at 6 months of age than were purebred MPS VII mice (3 \pm 0.7 mm), they were dilated as compared with normal mice without any mutations (1.4 \pm 0.2 mm). We conclude that deficiency of both cathepsin S and MMP-12 are not sufficient to prevent elastin fragmentation and aortic dilatation in the MPS VII model. Cathepsin activity assay was performed under conditions where other cathepsins would also have activity. Cathepsin activity was 5-fold normal in triply-deficient aortas, which was lower than the value of 15-fold normal in mice that were just deficient in GUSB. We conclude that other cathepsins are active in the aorta in MPS VII, and that it might be necessary to inhibit a broad spectrum of cathepsin to prevent aortic dilatation. It is the process of crossing MPS VII mice with cathepsins S mice, we identified several that were expected to have dilated aortas based on the GUSB $-/-$ status and the $+/+$ status other genes that were being studied, but were near-normal in diameter. These aortas had cathepsin activity that was only 3-fold normal, which was lower than the activity in the cathepsin S-deficient MPS VII mice. We conclude that these mice had another mutation that conferred protection from aortic dilatations by reducing cathepsin activities. Microarray demonstrated that several genes were upregulated in the purebred MPS VII mice as compared with the normal mice such as CCL4 (MIP1 β at 27-fold normal), PU.1 at 65-fold, and OSM1 at 104-fold, and CXCL1 at

174-fold normal. These genes are consistent with the hypothesis that GAGs bind the toll like receptor, which activates signal transduction pathways that result in the upregulation of these genes. MPS VII mice with unexpectedly small aortas due to this putative mutation had marked reduction in all of these genes to <10% of that in purebred MPS VII mice. We are currently trying to identify the putative gene that confers protection. Our hypothesis is that it relates to signal transduction in MPS VII, and might be an excellent target to inhibit in patients with MPS VII or other types of MPS.

719. Upregulation of Inflammatory Pathways and Proteases May Lead to Aortic Valve Insufficiency in MPS VII Dogs and Can Be Prevented with Neonatal Retroviral Gene Therapy

Guilherme Baldo,¹ Paul Bigg,¹ Susan Wu,¹ Yuli Liu,¹ Mark Haskins,² Henri Bai,¹ Meg Sleeper,² Katherine P. Ponder.¹

¹Internal Medicine, Washington University in Saint Louis, Saint Louis; ²Pathobiology, University of Pennsylvania, Pennsylvania, PA.

Mucopolysaccharidosis type VII (MPS VII) is a lysosomal storage disorder due to deficiency of β -glucuronidase (GUSB), which leads to storage of glycosaminoglycans (GAGs) and multisystemic clinical manifestations that include heart and valve disease. The pathogenesis of MPS VII valve disease is unknown, although recent studies in other organs suggest that undegraded GAGs could bind to the LPS-receptor [Toll-like receptor 4 (TLR4)], triggering inflammatory cascades and upregulating destructive proteases. In this study we aimed to address the causative mechanisms of aortic valve (AV) disease in MPS VII dogs using a microarray approach, and to determine the effects of neonatal i.v. injection with a gamma-retroviral vector (RV) expressing GUSB on correcting this aspect of the disease. Echocardiographic analyses at 6 months of age demonstrate moderate thickening (score +1.4; 0=normal and 3=severe) and regurgitation (score +2) of the AV in MPS VII dogs, which was statistically worse than in normal dogs (score +0.3 and +0.67, respectively, $p<0.05$). Histological and biochemical analysis revealed a reduction in the collagen signal and a massive GAG storage (65-fold normal) in MPS VII AV. Activities of cathepsins, which are proteases that can degrade collagen and other extracellular matrix proteins, were 27-fold normal ($p<0.001$). Microarray results revealed 196 genes that were ≥ 2 -fold normal in MPS VII as compared with normal AV with $p<0.01$, and 112 genes that were ≤ 0.5 -fold normal. Pathway analysis clearly demonstrated an important inflammatory component on the disease, with the TLR4/TREM signaling pathway being one of the most upregulated ($p=2.8 \times 10^{-7}$). When compared to known disease processes, MPS VII AV microarray results showed upregulation of 60 genes that are known to be increased in rheumatoid arthritis ($p=1.7 \times 10^{-16}$). Some upregulated genes included TLR4 (2.1-fold), tyrosine kinase SYK (4.3-fold), cytokines (TNF α 2.6-fold, IL8 6-fold, IL-15, 3.8-fold, IL-27 4-fold) and cathepsin S (4.8-fold), K (3.4-fold), B (3.7-fold) and MMP-12 (7.6-fold). RV-treated dogs had minimal AV thickening (score +0.5) and regurgitation (score +0.3) at 6 months, and benefits were maintained for up to 10 years. Serum GUSB activity was 3-fold normal and AV GUSB activity was 30% normal. RV treatment reduced, but did not prevent, GAG elevation in the valves (7-fold normal; 10% of MPS VII) and as well as cathepsin activities (3-fold normal; 11% of MPS VII). Our results suggest that GAG storage may activate important inflammatory pathways in the AV and increase the expression of proteases that degrade collagen and lead to valve dysfunction in MPS VII. RV gene therapy can markedly reduce AV disease in MPS VII dogs at 10 years, but the failure to completely normalize GAG levels may result in destructive changes over time. The resemblance to rheumatoid arthritis might indicate that drugs used for this disease, such as TNF α and SYK inhibitors, might also be effective in MPS VII patients to reduce valvular manifestations.

720. Intra-Cerebroventricular or Intravenous Injection of AAVrh10 Serotype Expressing Mouse GALC Results in Increased Life-Span and Widespread GALC Activity in CNS of a Mouse Model of Globoid Cell Leukodystrophy

Mohammad A. Rafi,¹ Han Zhi Rao,¹ Paola Luzi,¹ David A. Wenger.¹

¹Neurology, Thomas Jefferson University, Philadelphia, PA.

Globoid cell leukodystrophy (GLD) or Krabbe disease is a neurodegenerative disorder caused by the deficiency of the lysosomal enzyme galactocerebrosidase (GALC). This deficiency results in the accumulation of certain galactolipids including psychosine which is cytotoxic for myelin-producing cells. Twitcher (twi), the naturally occurring mouse model of GLD with the W339X mutation in the C57BL background was used in this study. Bone marrow transplantation (BMT) of young twi mice can prolong their lives to about 100 days from 40 days in untreated mice. In an attempt to evaluate the therapeutic potential of the newly developed AAVrh10 serotype in treating twi mice, we have recently cloned mouse GALC cDNA into AAV2 genome (pCB7) under CMV-enhancer/chicken b-actin hybrid promoter and packaged into AAVrh10 serotype capsid (AAV2/rh10-mGALC, titer: 7.6×10^{11}). The viral particles were injected intra-cerebroventricularly (i.c.v.) into the brain or intravenously (i.v.) into the tail vein of the neonatal mice (at 2 and 4 day of age, respectively). Their clinical features and weight gains were monitored twice a week. Mice treated with either i.c.v. or i.v. had less twitching and increase mobility compared to untreated affected mice. The average life span for both treatments was about 51 days compared to 35-40 day life expectancy in the untreated mice. However, histochemical staining using X-gal and immunohistochemical staining using anti-GALC antibody on frozen brain sections demonstrated even GALC expression in i.v.-treated mice; while in i.c.v.-treated mice high levels of GALC expressing cells could be found near the site of injection, hippocampus, choroid plexus, and cortical regions. Two normal neonatal mice also were injected i.c.v. with viral particles, sacrificed at 33 days and analyzed for GALC activity in brain. GALC activity measured in the whole brain (including cerebellum) was 15.4 nmol/h/mg protein compared in to 2.7 in an age-matched uninjected normal mouse brain. GALC activity measured in different brain sections of the other i.c.v.-injected normal mouse confirmed increased GALC activity in all sections with the highest level of activity in mid-brain area. A combination of the i.c.v. and i.v. injections is being carried out at this time. While the i.c.v. injection targets only the central nervous system, a combination of this approach with systemic delivery of the AAV2/rh10-mGALC via tail vein will most likely result in more beneficial outcome.

721. Lentiviral Mediated Neonatal Gene Therapy for Krabbe Disease Model Mouse

Hiroshi Kobayashi,^{1,2,3} Masamichi Ariga,² Yohta Shimada,¹ Sayoko Izuka,¹ Takayuki Yokoi,^{1,2} Takahiro Fukuda,⁴ Takeo Iwamoto,⁵ Yoshikatsu Eto,^{1,2,3} Hiroyuki Ida,^{1,2,3} Toya Ohashi.^{1,2,3}

¹Department of Gene Therapy, Institute of DNA Medicine, Jikei University School of Medicine, Tokyo, Japan; ²Department of Pediatrics, Jikei University School of Medicine, Tokyo, Japan; ³Department of Genetic Disease and Genome Science, Jikei University School of Medicine, Tokyo, Japan; ⁴Department of Neuropathology, Jikei University School of Medicine, Tokyo, Japan; ⁵Division of Biochemistry, Research Core Facilities, Jikei University School of Medicine, Tokyo, Japan.

Krabbe disease (Globoid Cell Leukodystrophy, GLD) is progressive demyelinating disorder due to genetic deficiency of b-galactocerebrosidase (GALC) results in the degeneration of myelin-forming cells (oligodendrocytes and Schwann cells) caused

by an accumulation of galactosylsphingosine (psychosine). We paid attention to immaturity of the blood-brain barrier and increased advantage in gene transfer into the hematopoietic stem cell in the neonatal period of the rodent, and performed gene therapy for the neonatal model mice of GLD (Twitcher mice). Methods: We constructed a lentiviral vector, SMPU-R-MND-GALC-IE, to transduce cells with the normal human GALC cDNA. We used a minimal HIV-1-based vector backbone, SMPU, with the addition of a minimal RRE sequence. We used the U3 region from the MND retroviral vector LTR as an internal promoter to drive expression of the human GALC cDNA. We placed an enhanced green fluorescent protein (eGFP) reporter gene downstream of the GALC cDNA with the ECMV internal ribosome entry site (IRES) preceding the eGFP gene to facilitate its translation. The vector was packaged with an HIV-1 packaging plasmid lacking accessory proteins (p8.9) and with the VSV-G protein. We injected the neonatal mice of homozygote for GLD, and followed up the body weight and life span. And we tried the combination of neonatal gene therapy and substrate reduction therapy (subcutaneous injection of L-cycloserine). Results: We have succeeded to improve the nutrition of the treated model mice reflected in the body weight {day32, average 5.69g in the disease control group (n=8) vs. 7.79g in the gene therapy group (n=7), p=0.008 by t-test}, the accumulation of galactosylsphingosine {5 week-old, average 12.72 pmol/mg in the full brain of the disease control (n=4) vs. 7.62 pmol/mg in the gene therapy group (n=4) } but not succeeded to improve the life span sufficiently (average 34.0days in the disease control group vs. 37.6days in the gene therapy group, p=0.03 by t-test). And we have succeeded in pathological improvement of sciatic nerve in the gene therapy group of 2 week-old. By the combination with substrate reduction, we have detected improvement in the nutrition at 5-week old (7.85g in the combination therapy group vs. 5.1g in the disease control group, p=0.045). Discussion: In neonatal gene therapy with intra venous injection of lentiviral vector for neonatal GLD model mouse, it is expected that efficient gene transduction for not only central nervous system but also peripheral nervous system. For the improvement the prognosis including life span, we should need vector of higher titer or combination therapy with other methods such as substrate reduction.

722. Efficacy of a Combined Intracerebral and Systemic Gene Delivery Approach for the Treatment of a Severe Lysosomal Storage Disorder

Carmine Spampinato,¹ Elvira De Leonibus,¹ Paola Dama,¹ Annagiusti Gargiulo,¹ Alessandro Fraldi,¹ Cristina N. Sorrentino,¹ Alberto Auricchio,^{1,2} Andrea Ballabio,^{1,2} Enrico M. Surace.¹
¹TIGEM-Telethon Institute of Genetics and Medicine, Naples, Italy; ²Pediatrics, Federico II University, Naples, Italy.

Sulfatases are involved in a number of different biological functions as diverse as degradation of complex molecules such as glycosaminoglycans (GAGs) and sulfolipids, production of steroid hormones and cell signalling. Eight inborn errors of metabolisms are due to sulfatase deficiencies caused by mutations of the corresponding genes. In the Multiple Sulfatase Deficiency (MSD), a very severe lysosomal storage disorder, the activities of all sulfatases are profoundly impaired due to mutations in the SUMF1 (Sulfatase Modifying Factor 1) gene. SUMF1 activity is an essential limiting step for the conversion of a conserved cysteine into a formylglycine residue. This post-translation modification is required to confer to sulfatases their catalytic activity. In our lab we have generated a MSD mouse model, which carries a null mutation in the Sumf1 gene (Sumf1^{-/-}). The severity of the phenotype make MSD unsuitable to be treated by enzyme replacement or bone marrow transplantation, hence the importance of testing the efficacy of novel treatment strategies. In the present study we show that Adeno-associated virus vector serotype 9 (AAV9) injected into the cerebral ventricles of MSD

neonatal mice resulted in efficient and widespread transduction of the brain parenchyma. In addition, we compared a combined, intracerebral ventricles and systemic, administration of an AAV9 vector encoding SUMF1 to the single administrations – either directly in brain, or systemic alone - in MSD mice. The combined treatment resulted in a global transduction of therapeutic gene and a significant improvement in both growth rate and lifespan that in some cases reached 1 year of age. Assessment of sulfatase activities levels revealed activation of ARSA, ARSC, and IDS in the brain, liver, heart and lung of combined treated mice at both one and three months after vector delivery (the liver and the heart being the organs with highest levels of sulfatases activity). Toluidine blue, and Alcian blue staining demonstrated a significant reduction of both vacuolization and GAGs accumulation in all organs tested, in particular the liver, heart, and lung presented almost a complete clearance of pathological storage. Furthermore, behavioral abilities were improved by the combined treatment. These results underscore that the “combined” mode of AAV9 administration is an efficient option for the treatment of severe whole-body disorders.

723. Intrathecal Administration of Type 9 AAV Vector Expressing Arylsulfatase A Is Effective for Reduction of Sulfatide Storage but Not for Correction of Neurological Deficits in Adult Metachromatic Leukodystrophy Model Mice with Overt Neurological Symptoms

Noriko Miyake,¹ Koichi Miyake,¹ Atsushi Sakai,² Motoko Yamamoto,¹ Ayumi Endo,¹ Hidenori Suzuki,² Takashi Shimada.¹
¹Department of Biochemistry and Molecular Biology, Division of Gene Therapy Research Center for Advanced Medical Technology, Nippon Medical School, Tokyo, Japan; ²Department of Pharmacology, Nippon Medical School, Tokyo, Japan.

Metachromatic leukodystrophy (MLD) is a lysosomal storage disease caused by the deficiency of arylsulfatase A (ASA) and characterized by severe neurological symptoms due to widespread demyelination in the both central and peripheral nervous systems. Recently, we have succeeded to treat ASA knockout MLD model mice by systemic neonatal gene delivery of type 9 adeno-associated viral (AAV) vector expressing ASA (AAV9/ASA). However, intravenous systemic gene delivery by AAV9/ASA is non-effective to treat neurological symptoms in adult MLD model mice because of the established blood brain barrier (BBB). Moreover, it is unclear whether overt neurological symptoms can be reversed by gene therapy approaches. In the present study, we examined the possibility of intrathecal (IT) administration of type 9 AAV vectors for the treatment of adult MLD mice, which have already neurological symptoms. IT administration is a promising strategy to cross the BBB for gene transfer into the central nervous system. AAV type 9 vector expressing ASA and green fluorescence protein (GFP) (4×10^{11} vg/body in 10ul) was IT injected via a suboccipital puncture into 1 year-old MLD model mice with neurological symptoms (n=5). Broad distribution of GFP expression was seen throughout the brain 3 months after IT injection of AAV9 vector. In addition, a large number of nerve fibers in the dorsal spinal cord and many neural cell bodies in the dorsal root ganglia were efficiently transduced. Immunohistochemical analysis showed efficient ASA expression was detected in the brain, with the cerebellum having highest activities. Alcian blue staining and quantitative analysis of sulfatide contents by biochemical assay showed decrease of the amount of stored sulfatide in AAV9/ASA treated MLD mouse in cerebellum compared to non-treated MLD mouse (cerebellum: 15.1 ± 2.6 vs. 24.5 ± 2.8 , $p < 0.05$; cerebral cortex: 9.2 ± 0.4 vs. 9.5 ± 0.8 , mg/mg protein, $p > 0.05$). However, in the behavior test, AAV9/ASA treated mice did not show a significant improvement in their ability to traverse narrow balance beams, as compared to non-treated MLD mice (Latency: 15.4 ± 3.7 vs. 12.2 ± 4.2

sec, $p > 0.05$; Slips: 12.6 ± 3.3 vs. 9.4 ± 3.8 times, $p > 0.05$). These data indicate that IT injection of AAV9/ASA is effective for suppression of sulfatide storage at least in cerebellum, but correction of neurological symptoms was not observed under the experimental condition. Two factors may contribute to the failure of gene therapy of adult MLD mice. One is that IT administration of AAV vector resulted in efficient gene transfer into cerebellum and spinal cord, but not other CNS area. Another factor is that one-year-old may be too late to treat MLD mice. Therefore, to treat adult MLD mice, it may be necessary to start gene therapy before onset of neurological symptoms using a strategy achieving more widespread transduction in the brain.

724. Alternative Splicing of the Human Iduronate 2-Sulfatase Gene and Implications in Gene Therapy

Ni-Chung Lee,¹ Wuh-Liang Hwu,¹ Lung-Ji Chang,² Yin-Hsiu Chien.¹

¹Department of Medical Genetics and Pediatrics, National Taiwan University Hospital, Taipei, Taiwan; ²Department of Molecular Genetics and Microbiology, University of Florida, Gainesville, FL.

Mucopolysaccharidosis type II (MPSII; Hunter syndrome) is a lysosomal storage disorder caused by a deficiency in the enzyme iduronate 2-sulfatase (I2S). Clinical manifestations of MPSII include visceromegaly, bone dysplasia, cardiac disease, and mental retardation. At present, the therapeutic approach for MPSII is enzyme replacement therapy. Unfortunately, two thirds of the patients have brain involvement, and enzyme replacement is not effective to the brain. Looking for an alternative therapy, both gene therapy and cell therapy are good candidates. Recently, we noticed two prominent alternatively spliced forms of the I2S gene in healthy donors. To evaluate functions and potential role of these I2S isoforms in Hunter syndrome, we constructed lentiviral vectors expressing the type I (full-length), type II and type III I2S mRNA. MPSII patients' skin fibroblasts were first immortalized with lentiviral vectors encoding telomerase and cell cycle regulatory genes. The immortalized MPSII fibroblast cell lines were then infected with lentiviral vectors encoding the various forms of I2S gene. Functional assay of the parental diseased versus lentiviral gene-modified fibroblasts demonstrated that only the full-length type I mRNA, but not the two shorter forms, expressed enzyme activity. We further characterized the differential distributions of these three spliced mRNAs in human cells by quantitative RT-PCR. We found that in human skin fibroblasts, the type I I2S mRNA was the most abundant species. However, the pattern of expression was not uniform in human peripheral blood mononuclear cells (PBMCs). In around half of the PBMC samples, type I mRNA was the most abundant form; while in others, type II appears to be the most abundant form. Currently the functional role for the I2S gene alternative splicing in human blood cells is not clear. Further understanding of the fundamental role of alternative splicing of I2S gene in hematopoietic cells and other tissues including the brain is important for future human gene and cell therapy treating Hunter disease.

Cardiovascular Gene & Cell Therapy

725. Preliminary Results of Molecular Cardiac Surgery Mediated Transfer of scAAV6- β ARKct in a Reproducible Model of Ischemic Cardiomyopathy

Anthony S. Fargnoli,¹ Michael G. Katz,¹ Elena Marusich,¹ Jason Abramowitz,¹ James J. Pilla,¹ Joseph Rabinowitz,² Walter J. Koch,² Charles R. Bridges.¹

¹Cardiovascular Surgery, University of Pennsylvania, Philadelphia; ²Translational Medicine, Thomas Jefferson University, Philadelphia.

Background: Targeting β AR signaling for cardiomyopathy with gene therapy is well positioned for the clinic, as the deleterious effects of β AR dysfunction are associated with elevated levels of the G protein-coupled receptor kinase-2 (GRK2). Inhibition of GRK2 via β ARKct transfer reverses heart failure in small animal models. However, achieving analogous results in the large animal has been problematic, since rigorous performance endpoints have not been met. A key rate limiting problem is inefficient delivery, whereby much less than 1 genome copy (GC) per myocyte is reported. Here we utilize molecular cardiac surgery with recirculating delivery (MCARD), an perfusion system featuring complete cardiac isolation in situ. MCARD achieves transfer of greater than 40 GC per cell, whilst minimizing collateral exposure. We first established a reproducible ovine model of ischemic cardiomyopathy, and then evaluated the effects of MCARD mediated β ARKct transfer. Methods: The model was generated at time zero with 6 subjects undergoing a baseline MRI followed by infarct creation. Intraoperative, two obtuse marginal branches of coronaries were ligated. Animals were divided into two groups, Control and MCARD respectively. All subjects then had MRI follow ups at 3 and 12 weeks post infarction. The Control group had no intervention. Conversely, the MCARD group received 1x10¹⁴ GC of scAAV6- β ARKct at 4 weeks post infarction. Left ventricular (LV) parameters: End diastolic volume (EDV), End Systolic Volume (ESV), Ejection Fraction (EF%) derived from MRI were measured offline with software. Western blot was performed on cardiac tissues at 12 weeks terminal. Results: Echo confirmed LV changes and +2 mitral regurgitation post infarction. The 3 week MRI results for the Control group indicated the onset of heart failure [3 weeks; baseline]: EDV [60 \pm 4; 43 \pm 2], ESV [37 \pm 4; 17 \pm 2] and EF% [39 \pm 5; 62 \pm 4] all p<0.05. At 12 weeks, the control group further declined compared with 3 weeks: [EDV 71 \pm 6], [ESV 47 \pm 7] and [EF% 36 \pm 6]. Prior to gene therapy, the MCARD animal's baseline and 3 week results were [EDV 35; ESV 15; EF 57] and [EDV 56; ESV 36; EF 36] respectively. This animal's 12 week results (i.e. 8 weeks Post β ARKct transfer) revealed an EF of 44%. (Figure 1A) This demonstrated an unprecedented level of improvement from 3 weeks results. The volumes were EDV 77 and ESV 43. Western blot analysis (Figure 1B) revealed robust cardiac expression in the: LV regions, RV, and Atria. Conclusion: Preliminary results indicate that MCARD mediated β ARKct therapy shows improvement in EF. Although promising, further experimentation is required to substantiate this conclusion.

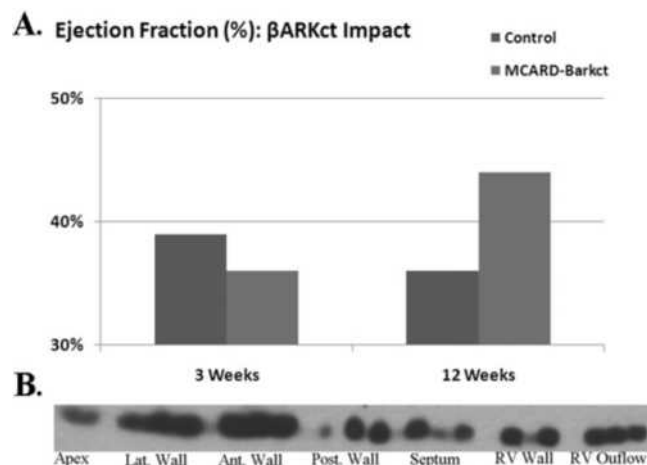

726. Retroviral Vector Gene Therapy Delays Mitral Valve Regurgitation in Mucopolysaccharidosis VII Dogs But Does Not Prevent Disease Long Term Due to Failure to Completely Prevent Induction of Inflammatory Pathways

Paul W. Bigg,¹ Guilherme Baldo,¹ Meg Sleeper,² Susan Wu,¹ Yuli Liu,¹ Henry Bai,¹ Patricia O'Donnell,¹ Venkata Rokkam,¹ Mark E. Haskins,² Katherine P. Ponder.¹

¹Internal Medicine, Washington University School of Medicine, St. Louis, MO; ²Pathobiology, University of Pennsylvania School of Veterinarian Medicine, Philadelphia, PA.

Mucopolysaccharidosis VII (MPS VII) is due to deficient activity of the lysosomal enzyme β -glucuronidase (GUSB) that contributes to the degradation of the glycosaminoglycans dermatan, chondroitin, and heparan sulfate. MPS VII results in cardiovascular manifestations due to valvular disease. The goal of this study was to determine the pathogenesis of mitral valve (MV) disease in MPS VII dogs, and if neonatal gene therapy with a retroviral vector (RV) could prevent it. MV regurgitation (MR) and irregular MV thickening were present at 6 months in untreated MPS VII dogs, and severe at 1 to 2 years, while MV prolapse was seen in some but not all dogs. MV abnormalities were markedly reduced at 1 year in MPS VII dogs that received neonatal IV injection of a gamma RV at 3 days after birth. This gene therapy approach transduces liver cells, which secrete mannose 6-phosphate-modified GUSB into blood, which can be taken up elsewhere via the M6P receptor. However, some MV thickening and regurgitation were observed at 10 years after gene therapy. Collagen, which is critical for the structural integrity of the MV, was markedly reduced in untreated MPS VII dogs with histochemical stains, and was only partially reduced in RV-treated dogs. All MPS VII dogs had vascularization in the spongiosa. mRNA for collagen III was markedly reduced to 16% normal in MPS VII MV, while several mRNAs for enzymes of the cathepsin and the MMP families that can degrade extracellular matrix proteins were increased. mRNA for Cathepsin K, a potent collagenase, was 4-fold normal, consistent with a 20-fold increase in cathepsin enzyme activity. Cathepsin mRNA and enzyme activity were reduced, but not normalized, in RV-treated dogs. A hypothesis for the mechanism of disease in MPS is that GAGs bind to the toll-like receptor 4 (TLR4 = lipopolysaccharide receptor), which activates signal transduction pathways. Indeed, genes that are upregulated by the TLR4 pathway such as GPNMB (93-fold), TREM2 (12-fold), TYROBP (5-fold), TNF α (4-fold), CCL4 (MIP1 β ; 6-fold), IL-6 (3-fold), IL-8 (5-fold), SMPDL3A (7-fold; generates ceramide), PLA2G7 (4-fold; phospholipase), and SYK (3-fold) were upregulated. We conclude that MV regurgitation is caused by

abnormal collagen structure, or by irregular MV thickening that reduces close opposition of the leaflets. Collagen abnormalities may involve reductions in collagen III and/or increases in collagenases, which may be induced by activation of inflammatory pathways by binding of GAGs to TLR4. Since neonatal gene therapy is not totally effective at preventing MV disease in MPS VII, inhibition of TLR4, TNF α , SYK, or cathepsin K are reasonable targets to achieve a more-profound effect on MV disease.

727. MicroRNAs 99b, 181a and 181b Potentiate Pluripotent hES Cell Endothelial Differentiation and Comprise Part of an Endothelial Cell-MicroRNA Signature Panel

Nicole M. Kane,¹ Lynsey Howard,¹ Raya Khanin,³ John McClure,¹ Christopher R. Breen,¹ Graeme Milligan,² Andrew H. Baker.¹
¹Institute of Cardiovascular & Medical Sciences, University of Glasgow, Glasgow, United Kingdom; ²Institute of Neuroscience & Psychology, University of Glasgow, Glasgow, United Kingdom; ³Computational Biology Center, Memorial Sloan Kettering Cancer Center, New York.

MicroRNAs (miRNAs) have emerged as important regulators of cell differentiation, development and disease by post-transcriptionally regulating gene expression through induction of mRNA degradation or by blocking translation. However, despite recent studies demonstrating the dysregulation of miRNAs in a number of cardiovascular complications, there is relatively little evidence demonstrating their functional role in early human development of vascular cells, how they control endothelial cell (EC) fate commitment and the mechanisms involved in these differentiation processes (1). Here, we differentiated human embryonic stem (hES) cells to ECs using a serum- and feeder- free protocol (2). Loss of miRNA biogenesis by lentiviral-mediated suppression of DICER impaired hES-EC differentiation indicating functional role for miRNA in EC commitment. We next performed a miRNA microarray to screen hES-EC miRNA profiles during defined early stages of differentiation and identified and validated several novel EC-associated miRNAs expressed in a time and EC differentiation-dependent manner, namely 99b, 181a and 181b. We report these miRNAs are expressed at similar levels in hES-EC cells differentiated for 10 days and adult venous ECs. To define the role of miRNAs 99b, 181a and 181b in EC differentiation we employed self-inactivating (SIN) vesicular stomatitis virus-pseudotyped lentiviral vectors to modulate miRNA expression in pluripotent hES cells prior to directed EC differentiation. miR overexpression was achieved by inducing expression of the pre-miR sequence under the control of the constitutive spleen focus forming viral promoter. miR knockdown was achieved by expressing specific shRNAs to produce short, single-stranded sequences that competitively bind their endogenous microRNA target and inhibit its function, or a scramble sequence control, under the control of the H1 promoter. Cells were infected with a multiplicity of infection (MOI) of 25 and modulation of each miRNA confirmed by TaqMan. miRNA overexpression potentiated the transcript and protein expression of EC-specific markers, *Pecam1* and *VE Cadherin*, at day 10 and 14 of differentiation as compared to uninfected and scramble sequence controls. Conversely, knockdown did not evoke suppression of endothelial marker protein expression indicating that the expression of miRNAs 99b, 181a and 181b are capable of potentiating differentiation but are not the sole regulators inducing and governing differentiation. These results indicate that miRNAs 99b, 181a and 181b comprise part of an endothelial-miRNA signature panel as evidenced by expression profiles in adult and hES-EC cells. These miRNAs are also capable of potentiating EC differentiation from pluripotent hES cells, but are not essential for successful EC differentiation. 1. Kane *et al.*, *Pharmacol Ther* **129**, 29 (2011). 2. Kane *et al.*, *Arterioscler Thromb Vasc Biol* **30**, 1389 (2010).

728. In Vivo Functional Selection Using an AAV Library Encoding the Mouse Secretome Identifies Ghrelin as a Powerful Cardioprotective Molecule

Giulia Ruozi,¹ Serena Zacchigna,¹ Antero Macedo,¹ Matteo Dalferro,¹ Antonella Falcione,¹ Lorena Zentilin,¹ Mauro Giacca.¹
¹Molecular Medicine Laboratory, International Centre for Genetic Engineering and Biotechnology - ICGEB, Trieste, Italy.

The need to develop novel biotherapeutics for myocardial ischemia and heart failure is increasingly pressing. In our efforts to identify novel genes controlling prenatal cardiomyocyte proliferation, regulating cardiomyocyte survival or promoting new blood vessel formation that might be exploited therapeutically, we have devised an innovative, in vivo functional selection strategy. According to this strategy, a cDNA library corresponding to the mouse secretome (1600+ genes) is directly selected in vivo under ischemic conditions upon subsequent rounds of delivery with vectors derived from the Adeno-Associated Virus (AAV). These vectors appear particularly suitable for in vivo screening, as they can be produced at high titers, transduce the heart at high efficiency and drive persistent transgene expression. To support the feasibility of the in vivo functional selection strategy, we initially tested a pool of 50 AAV2 vectors expressing different hormones and growth factors. After intracardiac injection of this vector pool, animals were subjected to myocardial infarction, and, after 15 days, persisting vector DNA was recovered, re-cloned into AAV and used for subsequent cycles of selection. From this initial set of experiments, we were already able to observe an unexpected, marked enrichment for surviving cardiomyocytes transduced with AAV2-ghrelin, a neuro-hormone involved in endocrine metabolism. The cardioprotective potential of ghrelin was further characterized by a series of morphological and functional assays. In vitro transduction with AAV2-Ghrelin resulted in the marked survival of cardiomyocytes after treatment with the pro-apoptotic drugs isoproterenol and doxorubicin. In vivo, AAV2-Ghrelin preserved cardiac function and reduced infarct size upon myocardial infarction, as assessed by echocardiography, histological and morphometric analysis. Interestingly, this effect was paralleled by a decreased number of apoptotic cells at early time points after infarction, and by the reduced expression of a few novel markers of heart failure, such as miR-21 and MMP-2. In conclusion, these results support the feasibility of our innovative in vivo selection approach and identify ghrelin as a novel and powerful molecule, with a protective function in cardiac apoptosis and providing benefit after cardiac damage.

729. Investigation of miRNA Targeting Sequences for Selective Regulated Gene Therapy in Cardiomyocytes

Carolyn Haggerty,¹ Caroline Fattah,¹ Stuart A. Nicklin.¹
¹Institute of Cardiovascular & Medical Sciences, University of Glasgow, Glasgow, United Kingdom.

The heart is a target for gene therapy in disorders including heart failure and myocardial infarction. Regulated gene delivery would improve efficacy and safety either via a tissue or a disease-specific approach. These approaches could be mediated by microRNAs (miRNAs) which post-transcriptionally control gene expression in a spatial, temporal and disease-regulated manner. Cardiac remodelling and hypertrophy are associated with a signature of up and down-regulated miRNAs. Initially expression cassettes under the control of a disease-regulated miRNA, miR-133, tested the concept that its down-regulation would regulate transgene expression in hypertrophied cardiomyocytes. Expression cassettes were generated in which destabilized luciferase was transcribed from the chicken beta-actin cytomegalovirus (CAG-CMV) promoter and miR-133 targeting sequences (TS) inserted into the 3' untranslated region.

Following transfection into H9c2 cardiomyocytes, CAG-CMV (no miR-133_TS) induced luciferase expression in the presence or absence of AngII. In the absence of AngII, CAG-CMV+miR133_TS only reduced luciferase expression by 50%. To further ensure selective cardiac transgene expression, tissue-specific regulation using miRNA targeting sequences was also investigated. Two groups of miRNA_TS expression constructs, with either a mixture of tissue-specific miRNAs; miR-122 (liver), miR-126 (endothelial) and miR-206 (skeletal muscle) or only miR-206, with a variable number of miRNA_TS copies (x3, x6 and x9), were tested for both approaches (Figure 1).

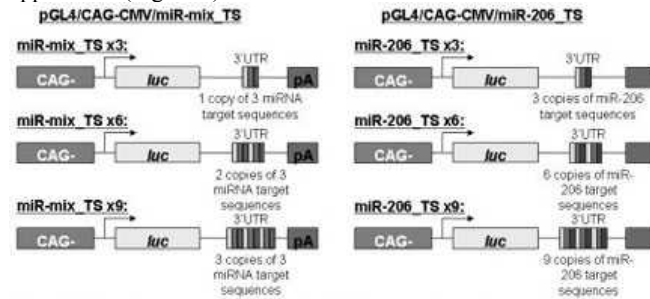

Figure 1. Schematic diagram of tissue-specific miRNA expression cassettes

Constructs were transfected into cells selected for high or low expression of specific miRNA: HepG2 (miR-122), A549 (miR-126), L6 & C2C12 (miR-206), HeLa's and H9c2 cardiomyocytes were used as negative and positive controls respectively. Luciferase expression in HeLa cells was not affected by the presence of miRNA_TS, however all miRNA_TS constructs in H9c2 cardiomyocytes had reduced luciferase due to high miR-206 levels in this myoblast cell line. Increased luciferase repression was observed with constructs containing more target sequence copies. In L6 cells, miRNA-206_TS x9 significantly decreased luciferase expression by 81% (+/-13, $P < 0.005$) with a similar effect for miR-mix_TS x9, 67% (+/-20, $P < 0.05$) reduction, which may be attributed to high miR-206 levels in these cells. The miR-mix_TS x9 construct produced the greatest luciferase repression, 94% (+/-3, $P < 0.001$), in C2C12 cells presumably due to very high miR-206 and high miR-122 levels. In summary, insertion of tissue-specific miRNA targeting sequences into an expression cassette provided regulated luciferase expression in a tissue-specific manner and to a lesser extent in a disease-regulated manner for hypertrophied cardiomyocytes. Incorporating miRNA target sequences into expression cassettes may enable the development of regulated tissue-specific gene therapy in cardiovascular disease.

730. Myocardial Infarction-Induced Acute Inflammation Impairs Therapeutic Efficacy of Bone Marrow Cells

Xiaoyin Wang,¹ Viola C. Lam,² Daniel J. Haddad,¹ Yan Zhang,³ Brian C. Clifford,¹ Kranthi Pinnamaneni,¹ Maya J. Bartel,³ Richard E. Sievers,³ Larry Carbone,⁴ Scott Kogan,⁵ Yerem Yeghiazarians,^{3,6} Michelle Hermiston,² Matthew L. Springer.^{1,3,6}

¹Cardiovascular Research Institute, University of California, San Francisco, San Francisco, CA; ²Dept. of Pediatrics, University of California, San Francisco, San Francisco, CA; ³Division of Cardiology, University of California, San Francisco, San Francisco, CA; ⁴Laboratory Animal Resource Center, University of California, San Francisco, San Francisco, CA; ⁵Dept. of Laboratory Medicine, University of California, San Francisco, San Francisco, CA; ⁶Eli and Edythe Broad Center of Regeneration Medicine and Stem Cell Research, University of California, San Francisco, San Francisco, CA.

Delivery of bone marrow cells (BMCs) to infarcted myocardium has been reported to be therapeutic in most animal experiments, but results in similar clinical trials of autologous BMC therapy have

been less robust. We have demonstrated that donor MI impairs BMC therapeutic efficacy in mice. However, the mechanism of this impairment remains unknown. Acute MI leads to a localized host inflammatory response. We hypothesized that MI leads to an increased or activated inflammatory state in the bone marrow that impairs the therapeutic efficacy of BMCs. To investigate this, we implanted BMCs from healthy or post-MI donor mice under ultrasound guidance. Donors and recipients were subjected to MI by permanent left coronary artery ligation. MI recipients were always identical from experiment to experiment. Donor bone marrow at 3 days post-MI showed several characteristics consistent with increased inflammation, including fewer CD11c+ dendritic cells, increased MHC Class II expression on B cells, and more Ly6Chigh inflammatory myeloid cells. Donor BMCs harvested at varying times post-MI were increasingly impaired over the first 3 days but were less impaired when harvested after day 5, consistent with the time course of an inflammatory response (see figure). Recipient EF is shown measured at 28 days post-recipient-MI in groups injected with BMCs harvested at various times after donor MI. Serum from donors at 1 and 3 days post-MI but not 7 days showed an increase in several cytokines and related proteins including G-CSF, IL-1 β , IL-1Ra, IL-6, MCP-1, TIMP-1 and TREM-1. Notably, anti-inflammatory treatment of donor mice post-MI with dexamethasone prevented the BMC impairment. BMCs harvested from sham-operated mice in which skin and bone were still wounded with no artery ligation were not substantially impaired. Our findings suggest that MI-induced acute inflammation impairs BMC therapeutic efficacy.

731. AAV8-Mediated Long Term Expression of Human LCAT Significantly Improves Lipid Profiles in hCETP; Ldlr^{-/-} Mice

Heather H. Zhou,¹ Zhu Chen,² Donald Chu,¹ Jose Castro-Perez,² Weihua Ni,¹ Aiwu Zhang,¹ Mihajlo L. Krstanovic,² Dan Xie,² Vinit Shah,² Steven J. Stout,² David G. McLaren,² Alice C. Stefanni,² Sang Ho Lee,³ Andrew S. Plump,² Brian K. Hubbard,² Thomas F. Vogt.¹

¹Translational Models, Merck Research Laboratories, Rahway; ²Atherosclerosis, Cardiovascular Diseases, Merck Research Laboratories, Rahway; ³In Vivo Pharmacology, Merck Research Laboratories, Rahway.

Lecithin:cholesterol acyltransferase (LCAT) is a major enzyme in HDL metabolism and potentially promotes reverse cholesterol transport and ameliorates atherosclerosis. To assess therapeutic potential of increased LCAT functionality, we employed adeno-associated viral vector serotype 8 (AAV8)-mediated gene transfer to achieve sustained high level expression of human LCAT in hCETP;Ldlr^{-/-} mice during a 32-week study. The AAV8-hLCAT treated mice had a concomitant and marked increase in HDL throughout the 32-week study when compared to AAV8-luciferase or saline treated control mice. Plasma lipid analyses at study termination revealed increased HDL particle size as well as HDL cholesterol level. Ex vivo LCAT activity had marked increase with humanized substrate specificity. Furthermore, LDL cholesterol, triglycerides and apoB were significantly reduced in AAV8-hLCAT treated mice. Lipid analysis via LC/MS method demonstrated that plasma HDL cholesterol ester increased in a fashion that fits human LCAT specificity, whereas no major lipid change in liver, bile and feces was revealed. The observed lipid profiles are novel among mouse models of LCAT overexpression, resemble previous findings in higher species, and are potentially antiatherosclerotic. Our data suggest that achievement of sustained overexpression of LCAT in the liver may provide a therapeutic opportunity for dyslipidemia and atherosclerosis.

732. Use of a Helper-Dependent Adenoviral Vector and a Rabbit Model To Test Atheroprotective Gene Therapy with Interleukin-10

Liang Du,¹ Nagadhara Dronadula,¹ Shinji Tanaka,¹ David A. Dichek.¹

¹Division of Cardiology, Department of Medicine, University of Washington, Seattle, WA.

Despite major advances in medical and surgical therapies, atherosclerosis remains a leading cause of death and disability. Vascular gene therapy (in which genes that protect against atherosclerosis are expressed in the blood vessel wall and either prevent or reverse atherosclerosis) could potentially complement or replace current therapies for human atherosclerosis, while avoiding their systemic side effects. However, development of vascular gene therapy is limited by lack of a useful vector. Helper-dependent adenovirus (HDAd) shows promise to overcome this barrier because—unlike first-generation Ad—HDAd achieves durable transgene expression in the artery wall with minimal inflammation. To begin to test whether HDAd—delivered to the artery wall—can limit atherosclerosis, we cloned the rabbit IL-10 gene, constructed an HDAd that expresses rabbit IL-10 (a potent atheroprotective cytokine that is effective in germ-line transgenic mice and in systemic somatic gene transfer models), and tested its activity in vitro and in an in vivo rabbit model of early carotid atherogenesis. HDAd-IL-10 expressed immunoreactive, biologically active IL-10 in vitro [suppressing LPS-stimulated cytokine expression by rabbit peripheral blood leukocytes in vitro by over 95% ($P < 0.01$)]. In studies using other HDAd for in vivo vascular gene transfer, HDAd-mediated gene expression declined substantially between 3 days and 2 wks. However, in contrast, artery wall expression of IL-10 from HDAd increased significantly between 3 d and 2 wk after infusion (4-fold; $P = 0.003$) and remained stable for at least 8 wk.

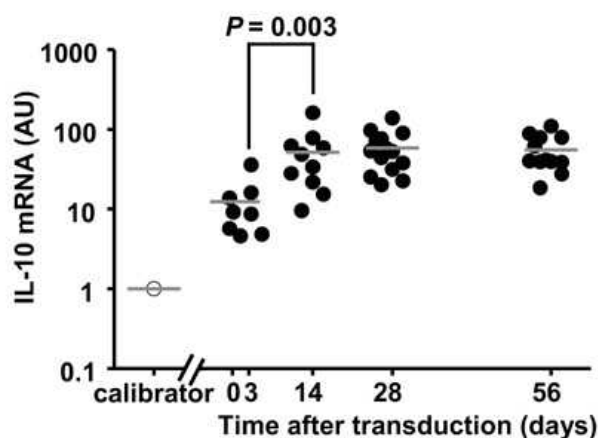

Rising, persistent IL-10 mRNA levels were associated with relative persistence of HDAdIL-10 genomes compared to HDAdNull genomes at 4 wk after infusion (3-fold; $P = 0.01$). Despite persistent IL-10 expression, HDAdIL-10 had no significant effects ($P > 0.07$ for all) on intimal lesion size, intimal macrophage content, or artery wall expression of either vascular adhesion molecules (ICAM-1 and VCAM-1) or atherogenic cytokines (including TNF- α , MCP-1, IL-6, IL-1- β , and IFN- γ). Lack of an atheroprotective effect of locally expressed IL-10 could be due to inadequate protein expression in vivo (IL-10 protein was barely detectable in vivo by western blotting) or lack of suitability of this particular animal model to reveal IL-10 therapeutic effects. IL-10 remains a promising agent for vascular gene therapy and HDAd remains a promising vector; however, proof of efficacy of HDAdIL-10 is elusive. Future preclinical studies will be aimed at increasing IL-10 expression levels, unraveling the mechanism through which IL-10 expression persists so

durably, and improving the sensitivity of this animal model to detect atheroprotective effects.

733. Uniform Field-Controlled Magnetic Targeting Enables Efficient Site-Specific Delivery of Endothelial Progenitor Cells to Stented Arteries in the Rat Carotid Model of Restenosis

Michael Chorny,¹ Ilia Fishbein,¹ Richard Adamo,¹ Robert J. Levy.¹
¹Department of Pediatrics, The Children's Hospital of Philadelphia, Philadelphia, PA.

Introduction Restoration of functional endothelium is critical for preventing thrombosis and vessel reobstruction of stented arteries. Thus, approaches aimed at facilitated reendothelialization have a potential to significantly improve the outcomes of endovascular stenting procedures. However the translation of cell delivery strategies into clinic has proven difficult due to challenges in achieving efficient cell localization to the target region. In order to address this limitation via magnetic cell targeting, a delivery strategy applicable to non-superficial blood vessels, as well as non-toxic, strongly magnetizable nanoparticles (MNP) endowing cells with magnetic responsiveness need to be designed. We hypothesized that the distribution and retention of endothelial progenitor cells (EPC) in the stented arterial segment can be significantly improved by a targeting approach based on the magnetizing effect of a deep-penetrating, uniform magnetic field. **Methods** MNP were formulated from polylactide with inclusion of nanocrystalline magnetite. Rat bone marrow-derived EPC stably transduced with luciferase using a lentiviral vector with the CMV promoter were loaded with MNP by incubation in the presence of a high-gradient magnetic field. Rat carotid arteries were injured by a Fogarty catheter prior to deployment of a magnetizable 304-grade stainless steel stent. MNP-loaded cells (10^5 per animal) were magnetically separated and delivered to stented arteries via the aortic arch under a uniform field (1200 G). MNP-loaded cells applied under non-magnetic conditions were used as controls. Reporter gene expression was assayed by bioluminescence after 1 and 7 days ($n \geq 4$). **Results** Magnetically targeted delivery of EPC resulted in their efficient localization to the stented arteries with $50 \pm 30\%$ (mean \pm SD) of the initially measured reporter signal detectable 7 days post treatment. The respective ratios of 180 and 1270 were measured at 1 and 7 day time points between the average reporter signals in the magnetic and non-magnetic treatment groups ($p = 0.016$, Mann-Whitney Rank Sum Test). **Conclusions** Uniform field-mediated targeting enables efficient site-specific delivery and protracted retention of EPC in stented arteries in the rat carotid model.

734. Enhancing MSC-Based VEGF Gene Therapy in Rat Myocardial Infarction Model Using Facial Amphipathic Bile Acid-Conjugated Polyethyleneimine

Sun Hwa Kim,¹ Hyeong-Ho Moom,¹ Minhyung Lee,² Ji Hoon Jeong,³ Donghoon Choi.¹

¹Severance Integrative Research Institute for Cerebral & Cardiovascular Disease, Yonsei University Health System, Seoul, Korea; ²Department of Bioengineering, Hanyang University, Seoul, Korea; ³Department of Pharmaceutics, Sungkyunkwan University, Seoul, Korea.

In primary cultured cells including bone marrow-derived mesenchymal stem cells (MSCs), most transfection techniques achieve very low efficiencies, generally no more than a few percent. Thus, preparing effective transfection methodologies is crucial to the success of stem cell-based gene therapy (1). A class of bile acids such as deoxycholic acid has an unusual structural feature in which two to three hydrophilic hydroxyl groups face to the same direction and hydrophobic steroidal hydrocarbons orient to the opposite direction

(2). The facially amphiphilic bile acids and their derivatives are known to interact with membrane and promote the cellular uptake of polar molecules (3). Herein, the facial amphipathic deoxycholic acid (DA) was conjugated to branched PEI_{1,8} and used in order to provide enhanced transfection efficiency of plasmid DNA in primary cultured cells MSCs. When the cell treatment is combined with gene therapy, low-transfection efficiency is one of the major limitations. For successful MSC-based myocardial gene therapy, the synthesized deoxycholic acid-PEI conjugates were used as a vector for plasmid hypoxia-inducible VEGF (HI-VEGF) to provide optimal HI-VEGF-engineered MSCs. The PEI-DA conjugates exhibited about 10-fold higher VEGF expression in rat MSCs, compared to conventional gene carriers.

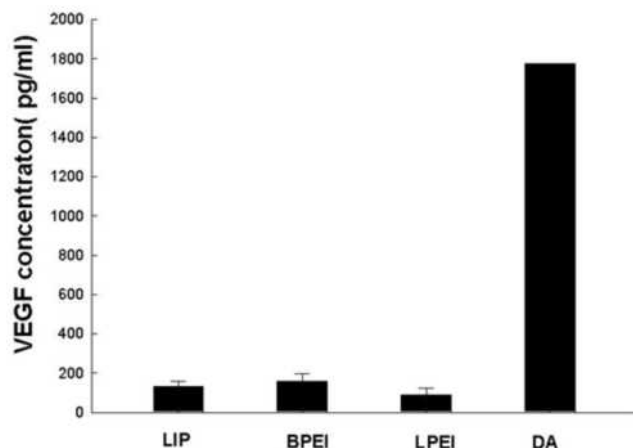

Bile acid-conjugated PEI could be a promising transfection reagent of MSCs to prepare genetically engineered MSCs for salvaging myocardial ischemia and infarction. In an effort to reduce ischemic myocardial damage, we investigated the effects on infarcted myocardium of transplantation of enetically modified mesenchymal stem cells (MSCs) that specifically expressed vascular endothelial growth factor (VEGF) under hypoxic conditions. Intramuscular administration of HI-VEGF-MSCs resulted in a substantial attenuation of left ventricular remodeling in rat myocardial infarction. The transplantation of HI-VEGF-MSCs could also improve cardiac function after infarction. This study demonstrates that cell-based gene therapy using genetically engineered MSCs to express VEGF in response to hypoxic stress can be a promising therapeutic strategy for the treatment of ischemic heart disease. References: [1] Haleem-Smith, H. *et al. Mol. Biotechnol.* **30**:9, 2005. [2] Cheng, Y. *et al. J. Am. Chem. Soc.* **114**:7319, 1992. [3] Swenson, ES. *et al. J. Adv. Drug. Deliv. Rev.* **8**:39, 1992.

735. Genetically Modified Stem Cells for the Treatment of Myocardial Infarction Using Novel Lysine-Based Nonviral Carrier System

Mohamed I. Nounou,¹ Cori Wijaya,¹ Dongling Li,¹ Sameer Saifuddin,¹ Yi Zheng,² Guilherme Silva,² Bradley McConnell,¹ Malavosklish Bikram.¹

¹Department of Pharmacological and Pharmaceutical Sciences, University of Houston, Houston, TX; ²Department of Cardiology Research, Texas Heart Institute, St. Luke's Episcopal Hospital, Houston, TX.

Despite advancement in the various surgical and pharmacological techniques, ischemic heart disease or coronary artery disease remains a leading cause of death in the US. Gene therapy is a promising alternative to conventional treatment strategies since the delivery of angiogenic cytokines such as vascular endothelial growth factor (VEGF) can stimulate neovascularisation in a process known as therapeutic angiogenesis. Moreover, advances in stem cell biology

have challenged the notion that infarcted myocardium is irreparable. The pluripotent ability of stem cells to differentiate into specialized cell lines began to garner intense interest within cardiology for the regeneration of infarcted regions of the heart. In this study, we have used gene therapy to generate genetically modified stem cells that are able to produce angiogenic cytokines to promote myocardial infarction (MI) revascularization. To transfect the cells, reducible novel lysine copolymers (LLCs) were designed and synthesized as an alternative to the non-degradable poly(L-lysine) (PLL) for nonviral gene delivery. The transfection efficiencies of the polyplexes as determined with luciferase and ELISA assays showed that LLC produced over 20 times higher transfection efficiencies and lower cytotoxicities in human mesenchymal stem cells (hMSCs) as compared to the PLL control. The hMSCs transfected with the LLC/VEGF gene were then injected into the infarcted area of the heart of SCID mice. The MI was created by ligation of the left anterior descending artery. At time points (1, 2, or 4-weeks) following cell injection, cardiac hemodynamic analysis was performed and then mice were sacrificed for immunohistochemistry analysis. Hemodynamic studies showed that hearts, injected with LLC/VEGF transfected hMSCs, had 1.5 times cardiac contractility, as compared to cell controls. Moreover, immunohistochemistry staining of tissue sections showed well defined tubular like structures that were stained positive for human cardiac troponin T (TnT) and smooth muscle actin (α -SMA) (Figure 1).

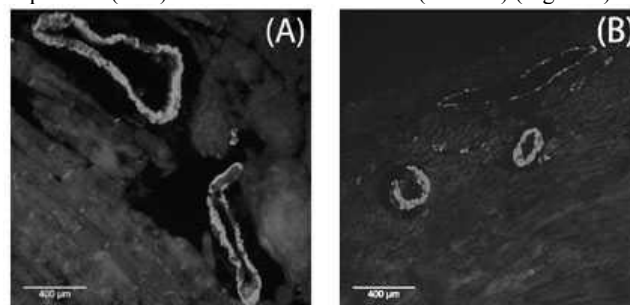

Figure (1): Immunohistochemistry staining of myocardial tissue sections after 4 weeks of treatment with (A) hMSCs transfected with the VEGF gene using LLCs and (B) untransfected hMSCs alone with the human-specific markers TnT and α -SMA stained with Alexa Fluor-488 (green) and Alexa Fluor-594 (red) respectively. These data indicated potential differentiation of hMSCs into myocardial-like cells. In conclusion, the use of gene therapy to genetically modify stem cells with VEGF gene using the safe and efficient LLC copolymers is considered a promising therapeutic tool for the treatment of MI.

736. DNA Vaccine for High Blood Pressure – Anti-Angiotensin II Therapy in Spontaneously Hypertensive Rats

Hiroshi Koriyama,¹ Hironori Nakagami,² Futoshi Nakagami,¹ Yasufumi Kaneda,³ Ryuichi Morishita.¹

¹Division of Clinical Gene Therapy, Osaka University Graduate School of Medicine, Suita, Osaka, Japan; ²Division of Vascular Medicine and Epigenetics, United Graduate School of Child Development, Osaka University, Kanazawa University and Hamamatsu University School of Medicine, Suita, Osaka, Japan; ³Division of Gene Therapy Science, Osaka University Graduate School of Medicine, Suita, Osaka, Japan.

[Aim] Japan, as one of the most rapidly aging countries, is suffering an enormous medical cost due to numerous patients whose hypertension cannot be ameliorated sufficiently even by using several antihypertensive drugs such as calcium blocker and angiotensin receptor antagonist. Thus, this next generation treatment for hypertension is considered to improve curative effect and also to reduce the medical cost effectively through the enhancement of

adherence, by one or two dose of vaccine per year, which can reduce or stop the use of antihypertensive drugs. A number of studies, both basic and clinical, on extending the scope of application of vaccination from infectious diseases to non-communicable diseases such as cancer, Alzheimer's disease and hypertension have been reported. This research aims to design DNA vaccines for high blood pressure and to establish the vaccine treatment for hypertension through basic experiment on spontaneously hypertensive rats (SHR) model with prospect for future clinical application. [Method] We used Hepatitis B core (HBc) protein, which forms a sphere-like structure by self aggregation. The presented peptide, which is likely to be recognized by immune system, introduces high titer antibody and therefore is used for designing vaccines. Through this system, the plasmid vector that encodes HBc-Angiotensin II fusion protein as well as a control plasmid vector that encodes only HBc was designed. For higher immunogenicity, the Immunostimulatory Sequence (ISS) which contain the CpG oligonucleotide was introduced in the HBc-Ang II plasmid vector and the HBc plasmid vector. HBc-AngII vector, HBc vector or saline was injected to back skin of SHR three times in every two weeks by needle less injection (Shimajet). Anti-angiotensin II antibody titer and blood pressure were measured every two weeks. Blood pressure was measured by tail cuff method. After the injection of the plasmid was discontinued, the maintenance of decreased blood pressure and of the antibody titer was examined. [Results] Four weeks after the first injection, production of anti-angiotensin II antibody and decrease in systolic blood pressure were detected in SHR in HBc-Ang II group in comparison with HBc group or saline. Twelve weeks after the first injection, a significant decrease of systolic blood pressure of SHR is still maintained in comparison with both of the control groups (HBc and saline). [Conclusion] It is demonstrated that injection of Angiotensin II DNA vaccine to SHR produces the anti-Angiotensin II antibody and decreases systolic blood pressure.

737. Hyperhomocysteinemia-Induced Endothelial Dysfunction Does Not Accelerate Progression of Atherosclerosis in Hypercholesterolemic Mice

Frank Jacobs,¹ Eline Van Craeyveld,¹ Stephanie C. Gordts,¹ Ilayaraja Muthuramu,¹ Jan Emmerechts,¹ Marc Hoylaerts,¹ Paul Herijgers,² Bart De Geest.¹

¹Center for Molecular and Vascular Biology, K.U. Leuven, Leuven, Belgium; ²Division of Experimental Cardiac Surgery, K.U. Leuven, Leuven, Belgium.

Background: Hyperhomocysteinemia is an independent risk factor for ischemic cardiovascular diseases but its causal role in atherothrombosis remains controversial. **Objectives:** (1) To analyse the effects of selective lowering of plasma cholesterol, plasma homocysteine, or both, on endothelial function and on progression of atherosclerosis in male hyperlipidemic and hyperhomocysteinemic C57BL/6 low density lipoprotein receptor (LDLr)^{-/-}/cystathionine- β -synthase (CBS)^{-/-} deficient mice. (2) To evaluate whether selective homocysteine lowering has anti-thrombotic effects in a model of arterial thrombosis. **Methods:** A folate-depleted, methionine-enriched diet supplemented with 0.2% cholesterol (w/w) and 10% coconut oil (v/w) was started at the age of 12 weeks. Three weeks later, gene transfer was performed with E1E3E4-deleted adenoviral vectors for hepatocyte-restricted overexpression of CBS (AdCbs) or of the LDLr (AdLDLr), or with the control vector Adnull (3). In a fourth group, both AdCbs and AdLDLr were co-administered. **Results:** Three weeks after start of the diet, plasma homocysteine and plasma cholesterol levels were $82 \pm 14 \mu\text{mol/L}$ and $680 \pm 27 \text{mg/dL}$, respectively. AdCbs and combined AdCbs/AdLDLr transfer resulted in a 5.6-fold ($p < 0.0001$) and a 4.5-fold ($p < 0.0001$) decrease of homocysteine levels, respectively, at day 14 and these effects were stable for the entire duration of the experiment. AdLDLr and AdCbs/

AdLDLr transfer induced a stable 6.2-fold ($p < 0.0001$) decrease of cholesterol levels. Six weeks after transfer, endothelium-dependent relaxation was severely impaired in hyperhomocysteinemic mice compared to conditions of normal homocysteine levels. Maximal relaxation to the highest dose of acetylcholine was significantly ($p < 0.001$) decreased in control ($61 \pm 6.5\%$) mice and AdLDLr ($65 \pm 5.8\%$) injected mice compared to AdCbs ($97 \pm 1.8\%$) and AdCbs/AdLDLr ($97 \pm 1.9\%$) treated mice. Intimal area was quantified in the aortic root and the brachiocephalic artery at 13 weeks after intervention. Intimal area in AdLDLr and AdCbs/AdLDLr mice was more than 100-fold ($p < 0.001$) smaller than in control mice and AdCbs mice. No differences in intimal area or a trend of difference was observed between control mice and AdCbs mice. To evaluate whether homocysteine levels affect arterial thrombosis susceptibility, carotid artery thrombosis was induced by photochemical injury. The average time to first occlusion and to stable occlusion were 1.9-fold ($p < 0.01$) and 2.1-fold longer ($p < 0.01$), respectively, in AdCbs treated mice than in control mice. Comparison of time to total occlusion between control mice and AdCbs mice by logrank test yielded a highly significant difference ($p < 0.0001$). **Conclusions:** The current study does not support a causal role for homocysteine in atherosclerosis progression and does not endorse the paradigm that endothelial dysfunction precedes atherosclerosis initiation and progression. However, endothelial function and homocysteine levels predict susceptibility to arterial thrombosis.

738. Effects of Tetrahydrobiopterin and Arginine on Nitric Oxide Synthesis and ROS Production in Ad-iNOS Transduced Rat Aortic Smooth Muscle and Endothelial Cells

Scott P. Forbes,¹ Richard F. Adamo,¹ Ricardo Corrales,¹ Michael Chorny,¹ Robert J. Levy,¹ Ilia Fishbein.¹

¹Pediatrics, The Children's Hospital of Philadelphia, Philadelphia, PA.

Gene therapy with viral vectors encoding for nitric oxide (NO) synthase (NOS) enzymes has been recognized as a potential therapeutic approach for the prevention of restenosis. The optimal activity of NOS utilizing an inducible isoform of the enzyme (iNOS) was shown to depend on the availability of tetrahydrobiopterin (BH4) and arginine (Arg) via the prevention of NOS uncoupling and subsequent reactive oxygen species (ROS) formation. We previously demonstrated an enhanced antirestenotic activity of vascular Ad-iNOS gene therapy in rats co-treated with BH4 and Arg. In the present study we investigated the effects of combined BH4 and Arg supplementation on NO production and ROS prevalence in rat aortic smooth muscle (RASMC) and endothelial cells (RAEC) transduced with free and substrate immobilized Ad-iNOS. Following transduction of RAEC and RASMC with steel mesh tethered Ad-iNOS and supplementation with Arg and BH4 NO production was measured by the Griess assay. A significant increase in NO production was found with the combinational treatment of 3.0 mM Arg and 10 μM BH4, with a greater than four-fold increase in RAEC. Transduction of rat aortic cells with increasing MOIs of free Ad-iNOS resulted in a dose-dependent increase in ROS formation as measured by dihydrorhodamine 123. ROS production was suppressed by the addition of 10 μM BH4 in both the presence and absence of 3.0 mM Arg, Arg alone had no effect on levels of ROS. Supplementation of free Ad-iNOS transduced RAEC and RASMC with increasing concentrations of Arg (0, 0.1, 0.4, 1.0 and 3.0 mM) and/or BH4 (0, 0.1, 0.5, 2.0 and 10 μM) demonstrated that BH4 increases NO production in a dose-dependent manner in both RAEC and RASMC. In addition, the combinational supplementation of Arg and BH4 resulted in a dose-dependent increase in NO production; this increase in NO production was inhibited by 200 μM aminoguanidine. Under supplementation conditions of 3.0 mM Arg and 10 μM BH4 NO production was saturated at a MOI

of 200 for free Ad-iNOS. Measurement of cellular viability by ethidium homodimer-1 fluorescence after free Ad-iNOS transduction demonstrated an increase in the number of apoptotic cells due to the cytotoxic effects of Ad-iNOS transduction. Our finding, that Arg and BH4 supplementation regulates iNOS function in transduced rat aortic cells, indicates the therapeutic potential of such supplementation in gene therapy with iNOS for the prevention of restenosis.

739. Helper-Dependent Adenovirus Is a Promising Vector for Atheroprotective Gene Therapy

Bo Jiang,¹ Liang Du,¹ Kun Qian,¹ David A. Dichek.¹

¹Department of Medicine, University of Washington, Seattle, WA.

Background: Long-term stable expression of transgenes *in vivo* has been achieved by helper-dependent adenovirus (HDAd) in a variety of organs and animal models. First-generation (FG)Ad has been used widely for gene transfer to arteries; however, the utility of FGAd for gene therapy is limited by transient expression and inflammatory responses. We previously reported the promise of HDAd for gene transfer to arteries of chow-fed rabbits; however, the performance of HDAd in a model of atherogenesis has not yet been defined. To begin to develop vascular wall-targeted gene therapy that would durably prevent development of atherosclerosis, we tested HDAd in a rabbit model of early atherogenesis and compared it to FGAd. **Methods:** We used 3 HDAd: HDNull (lacks a transgene), HDuPA (expresses rabbit uPA) and HDDeGFP (expresses eGFP) and 3 FGAd: FGNull, FGGuPA (expresses rabbit uPA from the same expression cassette as in HDuPA), and FGB-gal. The vectors were tested in a model of carotid artery atherogenesis in cholesterol-fed rabbits. We measured level of transgene expression and determined the pattern of transgene expression within the artery wall. We also measured intimal area, vascular inflammation [expression of adhesion molecules (ICAM-1 and VCAM-1) and atherogenic cytokines (MCP-1, TNF- α , and IL-6)], as well as lipid and macrophage accumulation in intimal lesions. To test dose-responsive effects, in some experiments HDAd was infused at 2 doses: 2 x 10¹¹ and 7.5 x 10¹¹ particles/ml ("low-dose" and "high-dose", respectively). **Results:** Both FGAd and HDAd transduced luminal endothelial cells almost exclusively and highly efficiently. Transgene expression by FGGuPA was initially (at 3 d) higher than was obtained with an equivalent dose of HDuPA. However, by 4 wks, uPA mRNA and activity were both significantly higher in arteries infused with HDuPA than in arteries infused with FGAduPA (2–3-fold; $P < 0.005$). Expression of uPA from HDuPA at 3 d and 4 wks was increased significantly by co-infusion of FGNull, suggesting that the expression cassette in HDAd can express at higher levels than observed under baseline conditions. Infusion of HDNull at a high dose caused a small amount of intimal growth and vascular inflammation (measured as increased adhesion molecule and cytokine expression) 4 wk after infusion; however, 4-week intimal areas of HDNull-infused arteries were significantly smaller than 4-wk intimal areas of arteries infused with the equivalent dose of FGNull (50% smaller; $P = 0.01$). When HDNull was infused at a lower dose, it did not increase either intimal growth or vascular inflammation compared to arteries infused with medium only ($P > 0.3$). **Conclusions:** HDAd can efficiently transduce endothelium of atherosclerosis-prone arteries. Expression from HDAd is initially lower than is obtained with FGAd; however, HDAd transgene expression is more persistent than is obtained with FGAd. In addition, HDAd causes less intimal growth than FGAd. When HDAd is infused at a lower dose, it achieves efficient gene expression in luminal endothelium but does not cause significant intimal growth or vascular inflammation. We conclude that HDAd is a superior vector to FGAd for vascular gene transfer aimed at preventing atherosclerosis.

740. Anti-Apoptotic Effects of Antibody-Protein A-HSP27 Fusion Proteins in a Rat Myocardial Infarction Model

Nahyun Kim,¹ Jung Ah Shin,¹ Min-Ji Cha,² Andrew Jackson,³ Ki-Chul Hwang,² Priti Kumar,³ Sang-Kyung Lee.¹

¹Department of Bioengineering, Hanyang University, Seoul, Korea; ²Division of Cardiology, Yonsei Cardiovascular Research Institute, Seoul, Korea; ³Department of Internal Medicine, Yale University, New Haven.

Cardiovascular disease is one of the leading causes of death in the world. Therapy for this disease, such as myocardial infarction, requires additional pharmaceutical agents as well as conventional surgery. HSP27 (Heat shock protein 27) has been considered as the therapeutic protein for the treatment of ischemic heart disease because of its protective effects of hypoxia-induced apoptosis. Angiotensin II Type 1 Receptor (AT1) was expressed immediately after ischemia-reperfusion in heart of rat myocardial infarction model. To achieve cardiomyocyte-targeted protein delivery after ischemia-reperfusion, we employed the immunoglobulin binding dimer ZZ, a modified domain of protein A of *Staphylococcus aureus*, in conjunction with AT1 receptor antibody. Using AT1 receptor antibody, we were able to achieve specific delivery of ZZ-GFP fusion protein into the heart of rat myocardial infarction model. Also, AT1 receptor antibody-ZZ-HSP27 (Heat shock protein 27) complex was intravenously injected in a ligation/reperfused rat myocardial infarction model and therapeutic efficacy was observed by measuring the inhibition of apoptosis and the area of fibrosis. These results may be applicable as a cardiomyocyte-targeted protein delivery system to inhibit apoptosis caused by ischemic injury.

741. Engineered Monocytes To Treat Ectopic Calcification

Meiting Wu,¹ Hsueh-Ying L. Yang,¹ Cameron Rementer,¹ Anthony Blau,² Cecilia M. Giachelli.¹

¹Bioengineering, University of Washington, Seattle, WA; ²School of Medicine/Hematology, University of Washington, Seattle, WA.

Ectopic calcification (EC) refers to abnormal deposition of calcium salts, often taking the form of bone, in soft or hard tissues as a result of disease or trauma. EC occurs in blood vessels, heart valves, joints and sites of amputation, and can lead to debilitating clinical symptoms. In arteries, calcification causes loss of compliance, increased systolic pressure, and increased stress on the heart, in addition to increasing the susceptibility of atherosclerotic plaques to rupture. Calcification of heart valves leads to aortic stenosis, a common problem in the aging population, and is the major mode of failure of bioprosthetic replacement valves. In joints, EC is a hallmark of arthritis and frequent complication in patients who have orthopedic fractures, hip arthroplasty and traumatic brain and spinal injury. Importantly, ~60% of high-energy, wartime extremity injuries, especially amputations, are complicated by EC. There are currently no local or systemic therapies aimed at treating EC, and surgical approaches have been ineffective for the most part. A treatment aimed at preventing and/or regressing EC yet sparing normal bone would have enormous health benefits for a wide variety of patients who suffer from this problem. In this study, we report on the development of a bioengineered cell therapy approach to control monocyte-derived macrophage differentiation to osteoclasts, the main bone resorbing cells in the body. Oligomerization of receptor activator of nuclear factor κ B (RANK) is known to be essential for osteoclast differentiation from monocyte/macrophage precursors. We engineered a macrophage cell line, RAW264.7, to express a fusion protein comprising the intracellular RANK signaling domain and FK506-derived dimerization domains that bind to the chemical inducer of dimerization (CID), AP20187 (Ariad Pharmaceuticals, Inc), or a control construct. Virally infected cells

containing these constructs were treated with AP20187 and dose-dependent, multinucleated osteoclast formation was observed in cells containing the RANK construct, but not the control construct. However, cells transduced with either construct were induced to form osteoclasts in response to the natural ligand, RANK ligand. In CID-inducible RANK construct transduced cells, withdrawal of AP20187 led to rapid death of the osteoclasts. The activation of a major signaling pathway downstream of RANK, NF- κ B, was observed in both RANKL- and AP20187- treated cells transduced with the CID responsive RANK construct, but not control cells. Furthermore, preliminary in vitro mineral resorption data shows that AP20187-induced osteoclasts have similar resorption activity to RANKL-induced osteoclasts. Future studies using engineered cells to regress EC in vivo are in progress.

742. HGF Plasmid Electroporation for Acute Myocardial Infarction Treatment

Leonardo Pinto Carvalho,¹ Eduardo G. Yasumura,¹ Vivian Samoto,^{1,2} Priscila M. A. Denapoli,¹ Vera Saleme,³ Raquel Sirvente,³ Christina M. Takiya,² Sang W. Han.¹

¹Interdisciplinary Center for Gene Therapy, Federal University of São Paulo, São Paulo, Brazil; ²Department of Histology, Federal University of Rio de Janeiro, Rio de Janeiro, Brazil; ³INCOR, São Paulo, Brazil.

Background: Efficient cardiovascular gene transfer using non-viral vectors is the main obstacle of gene therapy by currently available methods. Electroporation has been used successfully to transfer gene to many organs, but there are few data on their effects and use in cardiac tissue with therapeutic genes. The use of hepatic growth factor (HGF) in ischemic tissues has led to caliber and stable vessel formation. HGF has also anti-fibrotic action by degrading collagen extracellular matrix. **Methods:** Male 8 week-old Wistar rats were anesthetized and respiration of the animals was maintained with a breathing apparatus. In the left parasternal area an incision was made in the fourth intercostals space to expose the heart and 200 μ g of up-HGF plasmid in 100 μ L of PBS was intramyocardial injected. Immediately, a pair of needle electrode was inserted between the plasmid injected area and 3 pulses of 80 V/cm and 20 ms duration were applied. The heart was then re-introduced in the chest and after 30 seconds of normal heart rate recovery, heart was again exteriorized and acute myocardial infarction produced by electrocauterization of anterior descending artery from its origin to the apex. Elettrocardiography (EKG) and echocardiography (ECH) was carried out before and after 4 weeks of gene transference. Histological analysis was also obtained with picosirius stain and biotinylated Griffonia (bandeiraea) simplicifolia lectin I immunohistochemistry. **Results and conclusion:** Electroporation transfection analysis proved not affect cardiovascular function with an efficiency and innovative heart gene transference. Infarction method was easily performed and results in a homogeneous infarction area with lower mortality rate (10%) in comparison to ligation method. Infarcted hearts also showed left ventricle transmural fibrosis area, cardiac axis deviation to the left and electrical conduction decline. Treated group showed normalization of fractional shortening (40%) versus 32% of infarcted group. Heart rate corrected QT interval and RR interval demonstrated no variation in HGF treated group. These data corroborated with macroscopic and histological analysis which showed collagen reduction and increased of blood vessel number in comparison with infarcted group.

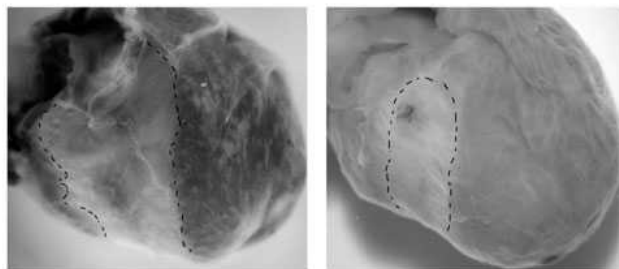

Results indicate that heart electrical discharge generated for transfection is tolerable and HGF gene expression was sufficient to improve animals' cardiac function. These data open a new perspective of studies for gene therapy treatment of cardiac ischemia in midsize animals thus enabling its use in clinical trials.

743. RNA Inhibitors of Intimal Hyperplasia

William H. Thiel,¹ Bojana Stanic,¹ Jennifer Streeter,¹ Xiuying Liu,¹ Francis J. Miller, Jr.,¹ Paloma H. Giangrande.^{1,2,3}

¹Internal Medicine, University of Iowa, Iowa City, IA; ²Molecular & Cellular Biology Program, University of Iowa, Iowa City, IA;

³Department of Radiation Oncology, University of Iowa, Iowa City, IA.

Bypass surgery is often performed at sites of major stenosis to restore blood flow to ischemic organs (e.g. heart, brain). Unfortunately, this procedure leads to activation and proliferation of vascular smooth muscle cells (VSMCs) in the intima of the vascular wall (intimal hyperplasia) which ultimately results in restenosis in a large fraction of patients. Drug eluting stents (DES), which release global inhibitors of cell proliferation (paclitaxel, rapamycin), have significantly reduced/retarded the risk of restenosis following bypass grafting. However, their use has also been associated with a reduction in endothelial cell (EC) remodeling which is associated with an increased risk of stent thrombosis. The identification of VSMC targeting agents which direct existing drugs or novel reagents (siRNAs) specifically to VSMCs is expected to lower the risk of stent thrombosis and significantly enhance the long term efficacy of surgical bypass grafting for the treatment of cardiovascular disease. We applied novel cell-based selection methods to identify VSMC-specific synthetic RNA ligands (aptamers) for targeting cell-growth inhibitors to VSMCs. After several rounds of positive (VSMCs) and negative selection (ECs) we enriched for RNA aptamer sequences that preferentially internalize into VSMCs but not ECs. The VSMC-specific RNA aptamers have been tethered to siRNAs that silence genes (cell cycle regulators, redox genes) implicated in VSMC proliferation and migration following vascular injury. Importantly, we show that silencing of several redox genes (e.g. NADPH oxidase subunits) results in reduced proliferation and migration of VSMCs in culture. In conclusion, we have developed and characterized several RNA reagents that may modulate VSMC remodeling following vascular injury. Future work will focus on evaluating these reagents for efficacy and safety in murine models of vascular injury.

Neurologic & Ophthalmic Gene & Cell Therapy II

744. Human MiniPromoters To Drive Selected Expression in the Brain, Spinal Cord, and Eye; an Expanded Collection

Kathleen G. Banks,¹ Stéphanie Laprise,¹ Andrea McLeod,¹ Douglas J. Swanson,¹ Li Liu,² Elodie Portales-Casamar,¹ Magdalena I. Swanson,¹ Steven J. M. Jones,^{3,4,5} Robert A. Holt,^{4,5,6} Wyeth W. Wasserman,^{1,3} Daniel Goldowitz,^{1,3} Elizabeth M. Simpson.^{1,3,6}
¹Centre for Molecular Medicine and Therapeutics at the Child & Family Research Institute, University of British Columbia, Vancouver, BC, Canada; ²Department of Anatomy and Neurobiology, University of Tennessee, Memphis, TN; ³Department of Medical Genetics, University of British Columbia, Vancouver, BC, Canada; ⁴Canada's Michael Smith Genome Sciences Centre, BC Cancer Agency, Vancouver, BC, Canada; ⁵Department of Molecular Biology and Biochemistry, Simon Fraser University, Burnaby, BC, Canada; ⁶Department of Psychiatry, University of British Columbia, Vancouver, BC, Canada.

Gene Therapy, alone or in concert with cell therapy, generally employs widely-expressed or ubiquitous promoters. However, if suitable cell-type or region-specific promoters were available, they would reduce off-target effects and thereby enlarge the choice of therapeutically-valuable proteins that could be employed. Ideally, such promoters would be human DNA, and thus less likely to be epigenetically silenced, and able to deliver proteins at physiological levels. Most challenging, such promoters would be small and therefore amenable to use in viral and plasmid constructs. The Pleiades Promoter Project is a large-scale functional-genomics endeavour focused on generating novel MiniPromoters to drive selected expression in the brain, spinal cord, and eye. This project integrates genome-wide bioinformatics, in vivo mouse testing, and histological examination of expression, to develop human MiniPromoters of 4 kb or less. Using this approach we have already developed 27 novel brain MiniPromoters (Portales-Casamar et al., PNAS, 2010). Here we present an expansion of that collection, adding novel MiniPromoters with unique expression patterns. Of greatest interest may be the new subregional promoters for the thalamus. Overall, 33% of the MiniPromoters tested expressed in the brain, and 50% of those showed expression related to the gene from which they were designed. In addition, we will announce the start of a new genomics initiative called CanEuCre. This project will test 50 MiniPromoters directly in adeno-associated virus (AAV) in the mouse brain. Importantly, we are offering an opportunity for basic and clinical researchers to nominate new genes or regional targets for MiniPromoter design. The Pleiades MiniPromoters are a key resource to facilitate research on brain development and function, and gene- and cell-based therapies. All the resources of both Pleiades and CanEuCre projects are publically available; for plasmids contact Dr. Simpson (simpson@cmmt.ubc.ca), for mice and ESCs contact MMRRRC (<http://www.mmrrc.org/>), and for sequence and expression data see the Pleiades web site (www.Pleiades.org). *D.J.S. and L.L. contributed equally to this work.

745. Comparison of AAV-Mediated Transduction of Different Brain Structures on Enzyme Distribution and Lysosomal Storage Correction in the CNS of GM1-Gangliosidosis Mice

Cara M. Weismann,¹ Miguel Sena-Esteves.¹
¹Neurology and Gene Therapy Center, University of Massachusetts Medical School, Worcester, MA.

GM1 gangliosidosis is an autosomal recessive lysosomal storage disease resulting from reduction/loss of lysosomal acid β -galactosidase (bgal) activity and characterized by accumulation of GM1 ganglioside in the central nervous system (CNS). Previously

we have shown that adeno-associated virus (AAV)-encoded mouse bgal (mbgal) is distributed in adult GM1 mouse brain by diffusion, axonal transport and possibly via CSF flow. The thalamus is a highly interconnected structure in the brain and thus an appealing target for AAV-mediated gene delivery to achieve widespread axonal distribution of lysosomal enzymes throughout the brain. Recently we have shown that bilateral AAV-mediated thalamic gene delivery in adult GM1 mice leads to widespread distribution of mbgal throughout the cerebrum and nearly complete correction of GM1-ganglioside levels. However, this approach only partially corrected storage levels in cerebellum and spinal cord. Work from other laboratories has shown that AAV-mediated gene delivery to other structures in the brain results in widespread distribution of lysosomal enzymes throughout the brain and cerebellum. In the present study we compared the effect of AAV-mediated gene delivery to 1) thalamus, 2) striatum, 3) ventral tegmental area (VTA), 4) internal capsule, 5) external capsule, and 6) deep cerebellum nuclei (DCN), on mbgal distribution and clearance of lysosomal storage in cerebrum, cerebellum and spinal cord. One month following stereotaxic injection of 1E10 gc of AAV2.rh8-mbgal vector (in 1 μ l), we analyzed mbgal distribution and effect on lysosomal storage throughout the CNS by X-gal and Filipin staining of sequential tissue sections, respectively. X-gal staining on the thalamic injection showed mbgal enzyme distribution throughout almost the entire cerebrum as seen in our previous work. Striatal injections resulted in efficient distribution of mbgal to anterior regions of the brain extending to the olfactory bulbs, but considerably less enzyme was present in regions posterior to the injection site. Injection in the external or internal capsule resulted in an enzyme distribution pattern localized mostly to the injection site. As previously reported by others, injection in the ventral tegmental area resulted in efficient enzyme distribution to bilateral sub-cortical structures such as striatum and brain stem, but lower levels in the cerebral cortex. Finally, injection in deep cerebellar nuclei gave distribution throughout the cerebellum as well as indications of CSF flow by enzyme presence in the meninges between the olfactory bulbs. Currently, we are evaluating the effect of each target on lysosomal storage throughout the CNS.

746. Transport of AAV Vectors within the Brain Is Serotype Dependent

Adrian P. Kells,¹ Ernesto Aguilar Salegio,¹ John Forsayeth,¹ Krystof S. Bankiewicz.¹
¹Neurosurgery, University of California San Francisco, San Francisco, CA.

Introduction: Targeting of sub-cortical nuclei with AAV serotype 2 vectors has proven useful in gaining widespread distribution of gene delivery within the central nervous system. In this study we examined whether AAV vectors of different serotypes exhibit distinct patterns of axonal transport and transduction after localized parenchymal infusions in the rodent brain. Method: Three vectors, AAV serotypes 2, 6 and 9, encoding green fluorescent protein (GFP) were infused into adult Sprague Dawley rats (n=3/serotype/structure). A total infusate volume of 3 μ l was delivered unilaterally into the striatum (AP=+1.2, ML=+2.4, DV=-5.0) or thalamus (AP=-2.8, ML=+1.6, DV=-5.5). Rats were monitored daily and euthanized 5 weeks after serotype administration. Results: Robust levels of GFP expression were found in the brain with all three vectors, however the distribution pattern was found to vary greatly between serotypes. AAV serotypes 2 and 6 transduced only neuronal populations, whereas AAV9 transduction consisted of a mixture of neuronal as well as glial. The most striking difference between vectors was the distribution of GFP positive cells in regions distal to the infusion site. As we have previously reported, AAV2 was anterogradely distributed along known axonal projections. Conversely, AAV6 underwent retrograde transport while AAV9 does not appear to be actively trafficked along axonal projections. Conclusion: Serotype dependent trafficking of AAV vectors within

the central nervous system significantly broadens the potential clinical use of different AAV vectors to achieve specific patterns of gene delivery to meet clinical requirements. Broad distribution from a single infusion site is also of considerable benefit for clinical application.

747. Biochemical and Histological Improvements Correlate with Post-Rescue Functional Gains after Combined AAV5 Gene Therapy and Copper in a Mouse Model of Menkes Disease

Anthony Donsante,¹ Patricia M. Verfas,² Elisabeth J. Rushing,³ Stephen G. Kaler.¹

¹Unit on Human Copper Metabolism, Molecular Medicine Program, NICHD, NIH, Bethesda, MD; ²Division of Veterinary Research, NIH, Bethesda, MD; ³Armed Forces Institute of Pathology, Washington, DC.

Menkes disease (MD) is an X-linked disorder of copper metabolism. Patients with MD have defects in a copper transporter, ATP7A, which is necessary for absorption of copper from the diet and delivering copper to the brain from the blood. In addition, ATP7A provides copper to enzymes metallated in the trans-Golgi network and appears to have a role in modulating NMDA receptor activity in the central nervous system (CNS). MD affects male infants early in life, presenting with neurodevelopmental delays, seizures, and death by three years of age. Treatment for MD is currently limited to daily copper injections over the first three years of life. While this therapy significantly extends lifespan when implemented within the first month of life, neurodevelopmental outcomes are often mutation-dependent. Thus, there is a need to develop more effective therapies for this disorder. We recently showed that a mouse model of Menkes disease (mo-br) could be rescued using a combination of intracerebroventricular (ICV) AAV5-mediated gene therapy and ICV copper replacement. Serial measurements of motor function (wire hang and rotarod tests) from 25 to 298 days of age showed significant deficits in these tests in the treated mo-br mice relative to wild type controls at the earlier time points. Surprisingly, these mice exhibited improvements on these tests as they aged. To begin understanding the source of the deficit and subsequent improvement, we performed biochemical and histological analysis of younger and older treated mo-br mice. Ultrastructural analysis at 300 days of age showed no overt abnormalities in CNS architecture. We are currently quantitating mitochondrial abnormalities in Purkinje cell neurons, which have previously been associated with deficits on the rotarod test. Combination treated mo-br mice exhibited delays in axonal development at 12 days of age, as assessed by Bielschowsky's silver stain. However, when myelination was examined at 300 days of age, no overt differences were evident between treated mo-br mice and wild type controls, suggesting that normal myelination eventually occurred. Biochemical analyses showed a similar correlation: copper measurements at 300 days were 82% of normal compared to 47% at 12 days of age. We also assayed brain catechol ratios (DOPAC:DHPG), an indirect measure of dopamine- β -hydroxylase (DBH) activity, a copper dependent enzyme whose activity is reduced in MD. DOPAC:DHPG was lower at 300 days in the treated mo-br mice than at 12 days of age (2.45 \pm 0.13 vs. 7.46 \pm 1.03, respectively), indicating improved DBH activity. These results suggest that improvements in the rotarod and wire hang tests may be due to sustained delivery of copper to the CNS, leading to improved activities of copper-dependent enzymes and functional gains.

748. Compacted DNA Nanoparticles Efficiently Transfect Retinal Pigment Epithelial Cells and Provide Long-Term Expression

Adarsha Koirala,¹ Rasha S. Makkia,¹ Mark J. Cooper,² Muna I. Naash.¹

¹Cell Biology, University of Oklahoma Health Sciences Center, Oklahoma City, OK; ²Copernicus Therapeutics Inc., Cleveland, OH.

In this study we evaluated the ability of unimolecular-compact DNA nanoparticles (NPs) to generate efficient and stable transgene expression in mouse retinal pigment epithelial (RPE) cells. Our goal is to develop a non-viral gene delivery system that would treat RPE-associated genetic disorders. We constructed two vectors encoding eGFP driven by the vitelliform macular dystrophy-2 (VMD2) promoter: i) VMD2-eGFP (plasmid based on pBluescript DNA) and ii) VMD2-eGFP-S/MAR (with the addition of Scaffold Matrix Attachment Region). The vectors were compacted with CK30PEG10K into rod-like DNA NPs (diameter 8-11 nm). NPs, naked DNA (4.3 g in 1 l) or 1 l of saline (vehicle) were injected into the subretinal space of 30 day old wild-type BALB/c mice. eGFP expression levels and localization were evaluated by quantitative real time PCR (qRT-PCR), immunohistochemistry (IHC), live fundus imaging and Western blotting over a period of 2-years post-injection (PI). At PI-2 days, qRT-PCR calculated relative to HPRT from whole eyes treated with VMD2-eGFP-S/MAR NPs showed 2-3 fold higher eGFP expression levels when compared to that from VMD2-eGFP NPs. Both NPs showed a gradual reduction in eGFP expression with time; however expression from VMD2-eGFP-S/MAR NPs was sustained at a level comparable to that of endogenous RPE65 up to PI-13 months. Both NPs directed RPE-specific eGFP expression detected by direct fluorescence confocal microscopy. We were able to track the presence of eGFP fluorescence from VMD2-eGFP-S/MAR NPs up to 2 years post treatment. Over 60 % of the cells in the whole mount of the RPE cell layer from the S/MAR containing NPs were eGFP positive even at PI-2 years. On the contrary, eyes injected with the VMD2-eGFP NPs exhibited a gradual reduction in eGFP expression and by PI-90 days, no eGFP was detected by qRT-PCR and only few eGFP positive RPE cells were observed in whole mount of the RPE cell layer. Overall, our results demonstrate significant clinical potential of compacted DNA NPs to provide highly efficient and sustained therapeutic expression of genes to RPE cells. These DNA NPs are currently being evaluated for sustained rescue of visual defects in the RPE65^{-/-} model of Leber's Congenital Amaurosis.

749. Peripheral Delta Opioid Receptor-Mediated Analgesia and Neuropathic Pain: Modulation of Receptor Expression in Primary Afferents Using Herpes Simplex Virus

Husam K. Mohammad,¹ Srinivasa Raja,² Steven P. Wilson,¹ Sarah M. Sweitzer.¹

¹Pharmacology, Physiology and Neuroscience, University of South Carolina School of Medicine, Columbia, SC; ²Anesthesiology, Johns Hopkins University School of Medicine, Baltimore, MD.

There is growing recognition of an important role for peripheral mu opioid-mediated analgesia in chronic neuropathic pain, a disabling condition that is often refractory to current analgesic therapies. In contrast, understanding the role of delta opioid receptors (DOR) in modulating pain is complicated by contradictory findings that DOR agonists can have antinociceptive effects while DOR antagonists decrease opioid tolerance. To understand the role for peripheral DOR in antinociception, we examined the effects of virally mediated over-expression or knockdown of the DOR in primary afferent neurons on neuropathic pain-associated behaviors and peripheral opioid analgesia, in a L5 nerve transection model in mice. On day 7 post-

nerve transection mechanical allodynia and thermal hyperalgesia were verified, and a recombinant herpes simplex virus type 1 encoding the cDNA sequences for the DOR (HSV-DOR), anti-sense DOR (HSV-aDOR), the DOR endogenous ligand preproenkephalin (HSV-PPE), or *E. coli lacZ* gene (HSV-lacZ) was administered subcutaneously in the hindpaw. Infection with HSV-DOR had no effect on mechanical allodynia or thermal hyperalgesia and did not change the dose-response curve for loperamide, a peripherally acting opioid agonist compared to HSV-lacZ. Interestingly, co-infection of HSV-DOR with HSV-PPE to over-express the endogenous ligand of DOR resulted in prolonged mechanical allodynia and thermal hyperalgesia and a right-ward shift in the loperamide dose-response curve. However, infection with HSV-aDOR to knock-down DOR expression in primary afferent neurons reversed mechanical allodynia and thermal hyperalgesia and produced a left-ward shift in the loperamide dose-response curve. These findings suggest that therapeutic approaches that increase the expression or activation of DORs in afferent neurons may not attenuate allodynia or hyperalgesia and may decrease opioid analgesia. In contrast, knock-down of DOR expression and hence intracellular signaling may reverse neuropathic pain-associated behaviors and enhance peripheral opioid analgesia. Future studies are warranted to understand the cellular and molecular mechanisms by which peripheral DORs contribute to neuropathic pain-associated behaviors and peripheral opioid analgesia.

750. The Equine Infectious Anaemia Virus-Based Lentiviral Vector Is an Effective Platform for Gene Therapy for Ocular Diseases

James Miskin,¹ Peter Widdowson,¹ Katie Binley,¹ Scott Ellis,¹ Jackie de Belin,¹ Julie Loader,¹ Georgina Ferrige,¹ Diana Angell-Manning,¹ Marie Carlucci,¹ Michelle Kelleher,¹ Kyriacos Mitrophanous,¹ Stuart Naylor.¹

¹Oxford BioMedica (UK) Ltd, Oxford, United Kingdom.

The development of lentiviral vector-based gene therapies to treat diseases of the eye is an attractive option due to the vector's innate ability to express therapeutic genes for extended periods, either to correct inherited disease, or to interfere with disease aetiology. The accessibility of the eye both for administration and for evaluating therapeutic benefit, combined with anatomical separation from the rest of the body preventing spread of the vector, are also significant advantages. Oxford BioMedica is developing gene therapy products using its proprietary Equine Infectious Anaemia Virus (EIAV)-based lentiviral vector system which is able to integrate large therapeutic genes into target cells, thereby ensuring treatment of the patient over years to decades. Three ocular products; RetinoStat®, StarGen™ and UshStat®, aimed at treating age-related macular degeneration, Stargardt macula dystrophy and Usher Syndrome 1B respectively, have been extensively characterized in regulatory safety and biodistribution studies following subretinal administration to both rabbits and primates. All three products exhibited a transient time- and dose-dependent inflammation reaction in the absence of prophylactic anti-inflammatory medication in both species examined. Therapeutic concentrations of vector could be administered subretinally, accompanied by minimal anti-inflammatory medication, without causing long-term detrimental morphological or functional changes within the eye. Biodistribution studies of vector demonstrated that the lentiviral vector products did not escape the ocular compartment, and as a result little or no antibody responses were observed in these studies. In conclusion, the EIAV-based lentiviral gene therapy platform has been shown to be an effective and safe system for the delivery and integration of relatively large genes into target retinal cells resulting in stable and long-term therapeutic expression. The nonclinical data has been used to support a successful IND submission

for RetinoStat® which is expected to enter clinical trial in early 2011. First in Man studies for StarGen™ and UshStat® are also expected to initiate within 2011.

751. Corneal Gene Delivery: Chitosan Oligomer as a Carrier of CpG Rich, CpG Free, or S/MAR Plasmid DNA

Eytan A. Klausner,^{1,2} Zhong Zhang,² Suet P. Wong,³ Robert L. Chapman,² Michael V. Volin,⁴ Richard P. Harbottle.³

¹Pharmaceutical Sciences, South College School of Pharmacy, Knoxville, TN; ²Pharmaceutical Sciences, Midwestern University Chicago College of Pharmacy, Downers Grove, IL; ³Molecular Medicine, Imperial College London, London, United Kingdom; ⁴Microbiology and Immunology, Midwestern University Chicago College of Osteopathic Medicine, Downers Grove, IL.

Corneal gene therapy can potentially treat acquired and inherited corneal disorders that otherwise lead to blindness. In a previous study on the development of effective vectors for corneal gene delivery, we showed that a particular formulation of chitosan-DNA nanoparticles based on ultrapure chitosan oligomers injected into rat corneas, led to transgene expression 5.4 times higher than obtained using polyethylenimine-DNA nanoparticles, the gold standard in non-viral gene therapy. Here we study the same formulation as a carrier of 6 different plasmids for corneal gene delivery. Size (range from 71.4 ± 3.6 to 114.4 ± 5.8 nm), zeta potential (range from 44.9 ± 0.9 to 49.2 ± 2.1 millivolt), ability to condense plasmid DNA as visualized using gel retardation assay, and luciferase transfection efficiency in COS-7 cell cultures did not substantially vary for nanoparticles based on different plasmids. One day post-injection of nanoparticles into rat corneas we found that pCpG-Luc, a CpG-free plasmid DNA that has an EF1α promoter and is commercially available, led to transgene expression 7.1 times higher than gWiz-Luc, a commercially available plasmid DNA with a CMV promoter used in our previous study; 116.8 times higher than pEPI-CMV, a commercially available plasmid that has a scaffold/matrix attachment region (S/MAR) sequence and a CMV promoter; and 76.8 times higher than pEPI-UbC, an experimental plasmid DNA that has an S/MAR sequence and a ubiquitin C promoter. Total transgene expression in rat corneas throughout days 1 to 7 (calculated as the area under the curve of the luciferase transgene expression versus time curves) of chitosan-DNA nanoparticles based on pCpG-Luc plasmid DNA was 7.8 times higher than that for nanoparticles based on gWiz-Luc plasmid DNA. Total transgene expression following injection of chitosan-DNA nanoparticles based on all other plasmids was very low. Rat cornea fluorescence after injection of chitosan-DNA nanoparticles based on pCpG-GFP plasmid DNA, a plasmid similar to pCpG-Luc but encodes for GFP, led to strong GFP fluorescence in the corneal stroma, but not in the epithelium or endothelium. Fluorescein isothiocyanate-conjugated anti-GFP staining colocalized with phycoerythrin-conjugated anti-vimentin staining in the cornea stroma indicated that the cells expressing the transgene are fibroblasts, i.e. keratocytes. This study reveals the potential of comparing various commercially available and experimental plasmids as an approach to enhance transgene expression. The study further indicates that the use of a combination of approaches that each enhances transgene expression has the potential to increase transgene expression beyond the use of each approach separately. The delivery system designed here represents the next step in the development of effective vectors for corneal gene therapy.

752. rAAV-Mediated shRNA Knock-Down of Alpha-Synuclein in the Rat Substantia Nigra Results in Aberrant Dopamine Handling

Ronald J. Mandel,¹ Aaron C. Rising,¹ Tahsin Khundkar,¹ Fredric P. Manfredsson.²

¹Neuroscience, University of Florida, Gainesville, FL; ²Division of Translational Science & Molecular Medicine, Michigan State University College of Human Medicine, Grand Rapids, MI.

Parkinson's Disease (PD) is a relatively common progressive neurodegenerative disorder generally affecting the aging population. PD patients generally present with unilateral motor-symptoms such as resting tremor which progresses bilaterally over time with increasing severity. Motor-symptoms arise from the progressive degeneration of dopaminergic neurons in the substantia nigra pars compacta (SNc) resulting in the loss of dopaminergic innervation in the terminal fields of the caudate/putamen. Although a majority of PD cases are sporadic, several familial forms of PD have been identified. α -synuclein (α -syn) was the first such gene to be identified where it was shown that different mutations in the encoding gene results in PD. α -syn is an abundant protein in the CNS which has been associated with the pathogenesis of several neurodegenerative disorders. Although the function of α -syn is largely unknown, the protein has been shown to be associated with synaptic vesicles and is thought to play a role in vesicle maintenance and neurotransmitter release. Paradoxically, α -syn knockout mice have revealed no overt pathogenesis. However, evidence exists for altered dopamine (DA) release, altered DA levels, and changes in DA vesicle number in these animals. Clinical and experimental data has shown that over-expression of wt or mutant α -syn can induce PD-like neurodegeneration in humans and animals. This has led to the suggestion that down-regulation of α -syn might provide a therapeutic modality for synucleinopathies. However, recent data show that virally delivered shRNAs targeting α -syn in the rodent substantia nigra results in significant dopaminergic cell-loss and resultant motor behaviors corresponding to levels of knock-down. In this project we sought to further characterize the effects of α -syn knockdown in the rodent basal ganglia. Recombinant adeno-associated virus type 2/5 expressing either α -syn shRNA and GFP as a transduction marker, or GFP alone, was stereotaxically injected in the substantia nigra (SN) or globus pallidus (GP) of adult rats. A subset of animals was sacrificed at 7 and 14 days following the injections. Histological analysis of these animals indicates the presence of apoptosis in the SNc of α -syn shRNA treated animals as early as 7 days following injection. In addition, evaluation of low-dose amphetamine-induced rotational behavior at later time-points demonstrated significant contraversive behavior of animals treated with α -syn shRNA in the SN, an indication of increased levels of cytosolic DA. However, high concentration amphetamine rotational behavior resulted in significant ipsiversive behavior of the SN injected animals when compared to the GP group. Together, these behavioral data indicates that the effect of α -syn shRNA is specific to the DA neurons of the SN. Our data, in concordance with previously published reports, agree with the fact that some level of α -syn is required for the survival of dopaminergic neurons, and is consistent with the hypothesis that loss of α -syn results in aberrant dopamine handling.

753. Neuroprotective Gene Expression with AAV8 for Oxygen-Glucose Deprivation in Organotypic Hippocampal Culture: A Model of Ischemic Stroke

Juliana Adão-Novae,¹ Rafael Linden,¹ Hilda Petrs-Silva.¹

¹Biophysics, Universidade Federal do Rio de Janeiro, Rio de Janeiro, Brazil.

Ischemic brain injury is one of the leading causes of disabilities and it is related with acute and chronic cognitive impairment. However, no therapy is currently available for promoting recovery. Ischemic stroke is the result of a transient or permanent reduction in cerebral blood flow that promotes neuronal death. Diverse models have been used to study the mechanisms underlying neuronal degeneration and to evaluate potential neuroprotective effects of different treatments. Among the *in vitro* systems used to study ischemia-induced injuries, organotypic hippocampal cultures, combined with oxygen-glucose deprivation (OGD), offer great advantages because they mimic closely the *in vivo* condition. The hippocampus is one of the most sensitive regions of the brain to the effects of global cerebral ischemia. Within the hippocampus, distinct sub-areas show differential cell death vulnerability: CA1 pyramidal neurons are vulnerable, whereas granular cells of dentate gyrus (DG) are resistant. The protein CHIP (C-terminus of Hsc70-interacting protein) has dual function as both co-chaperone with HSP/HSC70 and 90 and E3 ubiquitin ligase, serving as a molecular link between cellular protein folding and degradation. In addition to their role in proteostasis, is believed to be a central player in the regulation of cellular death decision. Here we analyzed the effect of CHIP superexpression in modulating neuronal death *in vitro* after OGD. Organotypic hippocampal cultures were obtained from 6–8-day-old Lister Hooded rats by dissecting hippocampal and making transverse slices (400 μ m). Slices were placed on an insert in a six well culture. In order to superexpress CHIP, tissue was infected with adeno-associated virus vector serotype 8 (AAV-8) in the first day of culture. After 14 days *in vitro*, OGD was achieved by combining hypoxia with aglycemia. The inserts were transferred to a sterilized 6-well plate and incubated with 1 ml of OGD medium lacking glucose for 15 minutes to deplete glucose from intracellular stores and extracellular space. After that, medium was exchanged for one with the same composition but previously bubbled with N₂ for 30 minutes and the plate transferred to an anaerobic chamber at 37°C with 95% N₂/5% air atmosphere for 60 minutes. Control slices were maintained in an incubator with 5% CO₂ atmosphere at 37°C. After deprivation period, slice cultures were incubated in culture medium under normoxic conditions for 24 h, corresponding to the recovery periods. Cellular damage caused a marked fluorescence in CA1 area, indicating a high incorporation of propidium iodide. We observed an increase of approximately 67% in CA1 cell death, a significant increase compared to control cultures. AAV-8 was able to superexpress CHIP in organotypic hippocampus culture demonstrated by immunohistochemistry. This superexpression promoted a decrease of approximately 85% of CA1 death compared to hypoxia condition. Our results are indicative of an important neuroprotection effect of CHIP in an *in vitro* ischemic model, suggesting a possible relationship between proteostasis and neuron stress. These results may represent a potential gene therapy for ischemic brain disorders.

754. Direct Comparison of Administration Routes for AAV 8 Mediated Ocular Gene Therapy

Tsutomu Igarashi,^{1,2} Koichi Miyake,² Nagisa Asakawa,^{1,2} Takashi Shimada,¹ Hiroshi Takahashi.²

¹Department of Ophthalmology, Nippon Medical School, Tokyo, Japan; ²Department of Biochemistry and Molecular Biology, Division of Gene Therapy Research Center for Advanced Medical Technology, Nippon Medical School, Tokyo, Japan.

Ocular disorders are promising targets for gene therapy which is becoming a well-established field. Viral gene therapies for the treatment of Leber's congenital amaurosis (LCA) are in clinical trials, and many other gene therapy approaches are being rapidly developed for application to diverse ophthalmic pathologies. The most widely used vectors for ocular gene delivery are based on adeno-associated virus (AAV), because they elicit minimal immune responses and mediate long-term transgene expression in a variety of retinal cell types. In fact, AAV type 2 vectors were used for gene transfer in clinical trials. Recently, we demonstrated that direct sub-retinal (SR) injection of AAV type 8 is highly efficient for gene delivery into the SR. It was reported that the level of AAV mediated gene expression in the SR is influenced by routes of vector injection. In this study, we compared different routes of vector administration in transduction efficiency and expression pattern. AAV type 8 vectors expressing luciferase (LUC) or enhanced green fluorescence protein (GFP) were injected into SR, vitreous (VT) and sub-conjunctiva (SC) (each; n=10). Transduction efficiency and expression pattern were examined at 1, 2, 4, 12, 24 weeks post injection by using *in vivo* imaging system (IVIS). Sustained and stable high expression was observed in AAV8/LUC treated mice injected into VT and SR but not SC (VT:SR:SC=374:350:25 (1×10⁵ photons/second)). Histological analysis showed that strong GFP expression was detected in AAV8/GFP treated mice injected into SR compared to VT, and no expression of GFP was seen in mice injected into SC. These results suggest that injection of AAV8 vector into SR as well as VT is a useful route for ocular gene therapy. It may be important to choose appropriate route depend on the ocular disorders and target cells.

755. Interplay between SNCY and LRRK2: Development of a Double Transgenic Mouse Model for PD

Xiaomin Su,¹ Hong Cao,¹ Howard J. Federoff.¹

¹Neuroscience, Georgetown University, Washington, DC.

A genetic confluence between rare highly penetrant familial forms of Parkinson's disease (PD) and sporadic PD informed by extensive GWAS implicate two genes, SNCA (α -synuclein) and LRRK2 (leucine rich repeat kinase 2), as etiopathogenetic. A number of α -synuclein or LRRK2 transgenic mouse models have been developed but they could not fully capture the features of PD, in that there is no overt progressive loss of dopaminergic neurons or full complement of α -synuclein pathology. Some evidence suggests that α -synuclein and LRRK2 share common pathogenic mechanisms. It is likely that the interplay between these two PD-related genes may produce a more fully representative genetic model for PD. We are developing a transgenic mouse model which harbors both mutant SNCA and LRRK2 genes. The Federoff laboratory previously developed an α -synuclein transgenic mouse model expressing a doubly mutated form of α -synuclein (A53T and A30P) under control of the rat tyrosine hydroxylase promoter (DMSYN+/+). In this study the 8-weeks old DMSYN+/+ mice received unilateral striatal infusion of lentiviral vector containing mutant LRRK2G2019S or LRRK2 kinase dead (LRRK2KD) as control. Rotation behavioral test was performed on these animals prior to and 6 weeks post surgery. Then these mice will be sacrificed and subject to neurochemical, immunohistochemical and molecular analysis. The development of the SNCA-LRRK2

mouse model may yield important insights to the pathophysiological interaction of α -synuclein and LRRK2, and possibly provide predictive value for evaluating therapeutic responses.

756. Chemotherapeutic Drugs Enhance rAAV2 Transduction Efficiency and Improve rAAV2-CNTF Induced Photoreceptor Survival Both *In Vitro* and *In Vivo*

Qian Huang.¹

¹Experimental Center, 1st People's Hospital, Shanghai Jiaotong University, Shanghai, China.

Recombinant adeno-associated virus (rAAV) is ideal for gene therapy of retinal neovascular diseases. The advantages of retinal gene therapy are attributed to its lack of pathogenicity, ability to infect multiple types of retinal cells and easy administration via sub-retinal injection. However, its low transfection ability is a big hurdle for its feasibility in the clinical setting. In this study, we utilized chemotherapeutic agents to enhance rAAV2 transfection and rAAV2-carrying transgene expression in human retina pigmented epithelium (hRPE) cells, and in SD and RCS animal models. Our results revealed that 0.1 g/ml of doxorubicin (DXR), 0.14 g/ml of cytarabine (Ara-C), 1 g/ml of etoposide (VP-16), and 20 g/ml of cisplatin (DDP) significantly enhanced rAAV2 transfection and rAAV2-carrying transgene expression *in vitro* and *in vivo*, accompanied with long term maintenance of normal retinal morphology and photoreceptors survival. We further demonstrated that pre-treatment with DXR for 24 h most effectively increased rAAV2 transfection in hRPE cells. The enhancing roles of chemotherapeutic drugs in transgene expressions were mediated by activation of PI3K and MAPK signaling pathways. Importantly, co-injection of rAAV2-CNTF with DXR resulted in ~2 fold increase in rat retina photoreceptor layer, demonstrating a further protection for photoreceptors. Our results provide the first evidence that low concentrations of chemotherapeutic drugs not only dramatically accelerated rAAV2 transfection, but also enhanced rAAV2-carrying gene expression in retina *in vitro* and *in vivo*, with no remarkable toxicity.

Musculo-skeletal Gene & Cell Therapy II

757. Systemic Reversal of Dominant Muscle Disease in a Mouse Model of Muscular Dystrophy

Sergio Bortolanza,^{1,2} Davide Gabellini,^{1,2} Joel R. Chamberlain.³

¹Dulbecco Telethon Institute, Seattle, WA; ²Division of Regenerative Medicine, San Raffaele Scientific Institute, Seattle, WA; ³Medicine, University of Washington, Seattle, WA.

Dominantly inherited genetic disease associated with a gain-of-function mechanism poses a particular challenge for gene therapy development. A straightforward therapeutic scheme would be to eliminate the genetic product that triggers pathogenic processes. We have chosen to pursue an RNAi-based approach aimed at targeted knockdown of *FRG1* mRNA in the FRG1 mouse model of facioscapulohumeral muscular dystrophy. The FRG1 mouse displays a variety of typical physical and molecular features of FSHD patients. Using the FRG1 mouse model we can harness the endogenous cellular RNAi pathway to degrade mRNA from genes expressing a toxic product in a targeted fashion. We have packaged extended short hairpin RNA (shRNA) expression cassettes targeting *FRG1* mRNA into adeno-associated virus serotype 6 (AAV6) shuttles for systemic delivery *in vivo*. AAV6 was selected as our gene transfer vector because of its predominant muscle tropism, high efficiency transduction of muscle cells, and long-term expression of transgenes. Intravenous tail vein injection of 5 x 10¹² vector genomes of the AAV6 *FRG1* shRNAs into dystrophic mice resulted in a significant improvement in muscle function as measured by treadmill running

with a concomitant reversal of phenotypic changes making the mice indistinguishable from wild-type mice. We also observed improvements in histological features, including a reduced fiber size, central nucleation, adipose accumulation, and fibrosis. Accompanying molecular changes included reduction of *FRG1* mRNA by 40-60% relative to saline-injected controls. Our data indicate that RNAi-mediated mRNA knockdown is a feasible approach to dominant genetic disease therapy and can be applied after onset of symptoms of a dominant muscular dystrophy in mice to reverse the course of the disorder. Application of this method to target relevant components involved in muscle disease offers a route to clinical application of RNAi for treatment of FSHD and other dominant muscle disorders.

758. Blocking the NF- κ B Pathway Enhances Mini-Dystrophin Efficiency in Dystrophin/Utrrophin Deficient Mice

Qing Yang,^{1,2} Ying Tang,¹ Anmin Chen,² Fengjin Guo,² Freddie H. Fu,¹ Johnny Huard,¹ Bing Wang,¹

¹Orthopaedic Surgery, University of Pittsburgh, Pittsburgh, PA;

²Orthopaedic Surgery, Tongji Hospital, Huazhong University of Science and Technology, Wuhan, Hubei, China.

Chronic inflammation, promoted by an up-regulation of the NF- κ B (NF- κ B) pathway plays a key role in the progressive muscle wasting and degeneration of Duchenne muscular dystrophy (DMD) patients. Higher immune alertness in dystrophic muscle, due to chronic inflammation and immune effector cell infiltration, challenges recombinant adeno-associated viral (rAAV) vector-directed DMD gene therapy in dystrophin/utrophin deficient (*dys*^{-/-}:*utro*^{-/-}, dKO) mice, a reliable mouse model of DMD. In our previous study, AAV-mediated systemic delivery of mini-dystrophin for the treatment of the dKO mice was effective at partially ameliorating the muscle pathology and increasing function in these mice, yet it was ineffective at reversing the course of muscle wasting due to the dystrophic muscle fibrosis, necrosis, and wasting which occurred in this chronically inflamed environment; therefore, in this study we combined mini-dystrophin replacement and anti-inflammation. We accomplished this by using two AAV vectors; one carried a mini-dystrophin gene and the other carried a short hairpin RNA (shRNA) to block the NF- κ B pathway. The goal was to investigate if blocking inflammation could enhance mini-dystrophin efficiency. A single intraperitoneal (i.p.) injection was performed in the dKO neonates using a combination of the two AAV9 vectors which included AAV9-NF- κ B/p65-shRNA_ZsGreen (7 x 10¹¹ v.g. particles/injection) and a low dose of the AAV9-CMV-hDys Δ 3849 vector (5 x 10¹⁰ v.g. particles/injection). An injection of the low dose AAV9-mini-dystrophin vector (5 x 10¹⁰ v.g. particles/injection) served as the control. Mice were sacrificed 10 weeks after AAV vector injection for muscle histology analysis. The ZsGreen monitored the shRNA efficiency of AAV delivery in skeletal and cardiac muscles (Green). By monitoring the ZsGreen expression, we found that the shRNA was delivered to the skeletal, cardiac and diaphragmatic muscles very efficiently. The efficient transduction of the diaphragm and cardiac muscles was of particular interest because these are the muscles whose failure causes the pre-mature death of DMD patients. A higher level of mini-dystrophin gene expression was observed in the skeletal and cardiac muscles of the dKO mice treated with both the mini-dystrophin and NF- κ B/p65-shRNA compared to the mice treated with mini-dystrophin alone. In this study, we found that enhanced mini-dystrophin expression could be achieved by combining the dystrophin gene replacement with shRNA silencing to block the NF- κ B pathway using two AAV vectors. However, the simultaneous injection of two rAAV vectors was complex and would be inefficient for clinical application. This prompts us to develop a single AAV vector which will carry both the mini-dystrophin and NF-

κ B/p65-shRNA cassettes. This approach may offer a more synergistic effect via the combination of gene replacement and anti-inflammation in a single-step procedure.

759. Human Involucrin Promoter Resists Spreading Methylation and Supports Compartment Specific Gene Expression in Engineered Skin Grafts

Wei Li Di,¹ Ekaterina Semenova,¹ Fernando Larcher,² John Harper,¹ Adrian Thrasher,¹ Waseem Qasim.¹

¹Institute of Child Health, UCL, London, United Kingdom;

²Cutaneous Disease Unit, CIBERER, Madrid, Spain.

The production of gene modified skin grafts through durable gene transfer to keratinocyte stem cells (KSC) offers the possibility of therapeutic benefit for inherited skin diseases. Ex-vivo gene corrected skin grafts can act both as a local barrier and as a source of secreted protein with systemic effects. Sin-lentiviral vectors can mediate stable gene transfer to KSC and these cells can then be used to generate epidermal skin sheets suitable for grafting. We have previously reported pre-clinical gene correction for the inherited skin disease, Netherton Syndrome (NS), a defect of the serine protease inhibitor LEKTI, which arises due to mutations in SPINK5. Lentiviral vectors incorporating an internal SFFV retroviral promoter, in combination with a codon optimised SPINK5 (SPINKco) transgene supported high levels of LEKTI reconstitution and robust correction of skin architecture (whereas protein expression from non-codon optimised SPINK5 constructs had been suboptimal). However, subsequent experiments have uncovered unanticipated silencing phenomena, with loss of LEKTI expression from the SPINKco transgene over time. We report how the inadvertent introduction of CpG sites during the codon optimisation of SPINK5 rendered the vector susceptible to silencing due to the spreading of DNA methylation across the promoter/transgene boundary. In contrast, substitution of the methylation-prone retroviral promoter with a minimal human involucrin promoter (INVOp) (which encodes very few CpG sites) supported durable, methylation-resistant gene expression. Using three dimensional skin equivalent organotypic cultures in vitro, and a human: murine skin graft model in vivo, we demonstrate that INVOp mediates highly compartment specific reconstitution of LEKTI expression and supports architectural correction in NS. The findings highlight unexpected consequences relating to the use of synthetic gene constructs optimised to support increased protein production through increased GC content designed to enhance mRNA stability. Fortunately, in the context of skin gene modification, the use of INVOp not only addressed the issue of spreading methylation, but also allowed gene expression to be targeted to the uppermost epidermal layers where LEKTI is highly expressed. Lentiviral vectors encoding INVOp offer a suitable platform for sustained gene expression in human skin grafts.

760. AAV2 Mediated VEGF Gene Transfer Leads to Increased Bone Formation and Remodeling of Bone Allografts

Mette J. Koefoed,^{1,2} Alexandra G. Pedersen,¹ Kjeld Soballe,² Thomas G. Jensen,¹ Michael Ulrich-Vinther.²

¹Department of Human Genetics, Aarhus University, Århus C, Denmark; ²Department of Orthopedics, Aarhus University Hospital, Århus C, Denmark.

Bone allografts are widely used clinically although they often heal insufficiently leading to a high risk of fracture a few years after implantation due to a lack of vascularisation and remodeling. These problems may be alleviated using allografts coated with freeze-dried AAV vectors carrying genes for osteogenic stimuli (Nat Med 11: 291-297, 2005; Mol Ther 12: 212-8, 2005). The aim of this

study was to evaluate the kinetics of the gene delivery from bone allografts and the potential effects of a dual approach stimulating both neovascularisation and new bone formation using AAV2 mediated gene transfer of Vascular Endothelial Growth Factor (VEGF) and Basic Fibroblast Growth Factor (bFGF2). We used a murine femoral fracture model to study the effects of AAV vectors freeze-dried to the surface of processed allografts. Allografts coated with AAV-luciferase were implanted in the right femur of the mice and bioluminescence imaging was used to assess the expression kinetics. Further, the effects of VEGF and bFGF2 on new bone formation were measured. Mice (n=48) were divided in 4 groups receiving either VEGF, bFGF2, a combination of the two and finally a GFP-control group. Bone formation was evaluated after 10 weeks using micro-CT and histology. Bioluminescence imaging demonstrated gene expression specifically localized to the site of insertion of the graft in the right femur of the mouse. The signal was detected at a significant level on day 9 and reached a plateau around day 50, which was still maintained on day 178. Interestingly, VEGF coated allografts led to an almost two fold increase in new bone volume compared to controls (VEGF: 31.7 +/- 11.6 mm³, GFP: 16.4 +/- 8.6 mm³, p < 0.05). Furthermore, both histology and 3D reconstructions of the micro-CT data showed the formation of new bone covering the entire surface of the VEGF treated allografts in contrast to the controls, which were dependent on bone bridging at the host-graft boundaries leaving the mid part of the graft unaffected. Finally, the VEGF group showed clear signs of remodeling both at the ends and along the side of the graft. In conclusion allografts with freeze-dried AAV vectors mediating VEGF expression promotes new bone formation and remodeling not seen in the normal allograft healing. This makes it a promising tool for enhancement of allograft integration and longevity. The positive effect of VEGF gene transfer points to blood vessels as a critical step in the healing process.

761. Gene-and-Stem Cell Therapy for Vertebral Bone Fracture

Dmitriy Sheyn,¹ Ilan Kallai,² Wafa Tawackoli,¹ Yoram Zilberman,² Amir Lavi,² Susan Su,¹ Anthony Oh,¹ Xiaoyu Da,¹ Zulma Gazit,^{1,2} Gadi Pelled,^{1,2} Dan Gazit.^{1,2}

¹Cedars-Sinai Medical Center, Los Angeles, CA; ²The Hebrew University of Jerusalem, Jerusalem, Israel.

Introduction: Vertebral compression fractures are the most common fragility fractures accounting for approximately 700,000 injuries per year. Since open surgery involves morbidity and implant failure in the osteoporotic patient population, new minimally invasive solution are being developed. These methods include injection of synthetic non-biological material that does not resorb and remains a permanent foreign-body fixture. Therefore there is a clear clinical need for a biological solution for vertebral bone repair. We have previously shown that BMP-transfected adipose-derived stem cells (ASCs) are capable of inducing spinal fusion *in vivo*. We hypothesized that direct injection of ASCs, transiently expressing BMP6, to a vertebral bone defect would accelerate bone regeneration leading to fracture repair. **Methods:** Porcine ASCs were isolated and labeled with a lentiviral vector that encodes for two reporter genes, Luciferase (Luc) under constitutive and tissue-specific (Osteocalcin) promoters. Labeled ASCs were transiently transfected with a BMP6 plasmid using nucleofection. 24-hours later bone void defects were created in coccygeus vertebra of Nude rats. The cells were suspended in fibrin gel and injected into the bone void. A control group was injected with fibrin gel only. The regeneration process was monitored *in vivo* using μ CT, while cell survival and differentiation were monitored using bioluminescent imaging (BLI). The operated vertebrae were harvested after 12 weeks, and analyzed using histology and immunohistochemistry against porcine vimentin. **Results:** *In vivo* BLI detected the Luc-expressing cells at the implantation site for 12

weeks (Fig. 1). The gradual decay of the signal probably indicates cell death and growth arrest due to MSC differentiation. μ CT scans showed that starting from 4 weeks post surgery, considerable defect repair was seen in the group treated with ASC-BMP6. Complete repair was achieved 12 weeks post cell injection (Fig. 2). ASCs contributed to new bone formation, shown by immuno-staining against porcine vimentin.

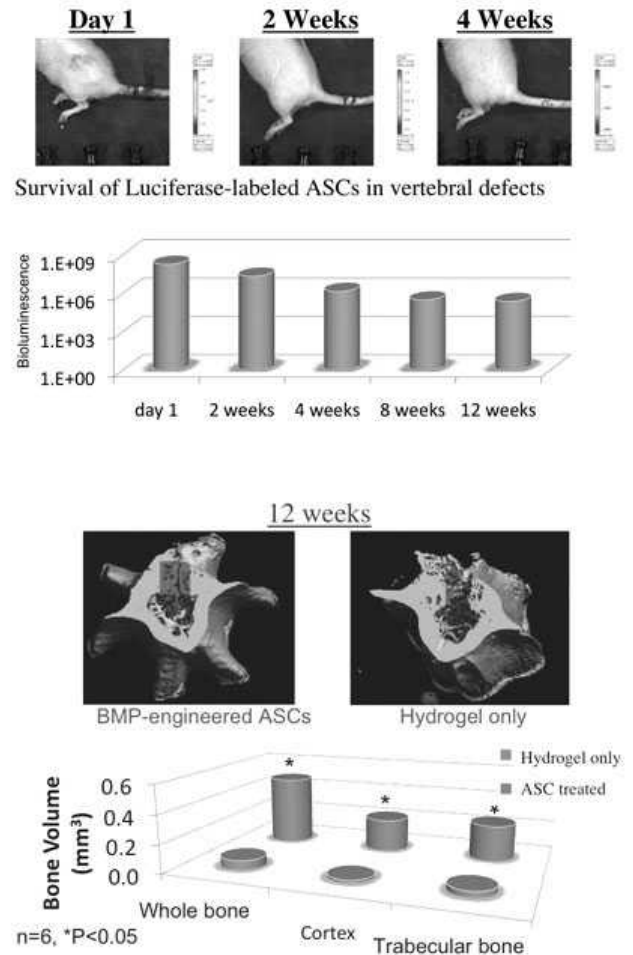

Conclusions: In this study we have shown the potential of injected, BMP-transfected, ASCs to repair vertebral bone defects in a rat model. These results could pave the way to a novel approach for a biological treatment of traumatic and osteoporosis-related vertebral bone injuries.

762. Inactivation of Dystrophin Expression Via Cre-loxP Mediated Gene Excision

Julian N. Ramos,¹ Andrea Arnett,¹ Brian Schultz,¹ Jeffrey S. Chamberlain.^{1,2}

¹Molecular & Cellular Biology, University of Washington, Seattle, WA; ²Neurology, University of Washington, Seattle, WA.

Duchenne muscular dystrophy (DMD) is a recessive X-linked disease in which the dystrophin gene is aberrantly expressed or not at all. Several potential therapies have demonstrated efficacy in animal models and have proceeded to human clinical trials. Among these strategies is to express truncated dystrophins, or micro-dystrophins, in the targeted striated muscle. Although micro-dystrophin (μ Dys) constructs have demonstrated a high degree of functionality in dystrophic models, it is uncertain how stable these truncated proteins are in adult muscles. To address this question, we generated a double

transgenic floxed- μ Dys/Cre-ERTM/mdx4cv line expressing microdystrophin in skeletal muscle. Primary myoblast cultures administered 4-hydroxytamoxifen had <25% μ Dys-expressing cells by 7 days after the end of the regimen. To ascertain the persistence of the truncated protein in vivo, Cre-mediated recombination was induced with tamoxifen delivered intraperitoneally. At 3 weeks post-treatment, multiple hind limb muscles exhibited less than <50% expression. In order to accurately gauge the protein's stability, the EDL muscles of floxed- μ Dys/mdx4cv mice were injected with rAAV-CMV-Cre-NLS. This produced a transient knockdown of dystrophin expression where significant loss was determined by physiological and morphological aspects, in addition to dystrophin labeling. These results suggest that a micro-dystrophin with a modular design similar to one described herein has a maximal half-life of 7 days in vivo.

763. A Miniature Muscle Model Suitable for the Rapid Screening of Vially Delivered Transgenes

Rainer Ng,¹ Jeffrey S. Chamberlain.¹
¹University of Washington, Seattle.

Delivery of transgenes to the skeletal muscles of animal models is a fundamental approach used to study muscle function. Among various gene delivery techniques, viral-mediated approaches are most preferable as they transduce skeletal muscle at great efficiency while invoking no physical damage to the muscle. Investigators who wish to study multiple transgenes or perform construct optimization, however, will find viral-mediated gene delivery unfeasible due to the time and resource associated with virus production. To overcome this limitation, we developed a miniature muscle model using the lumbrical muscle from the forepaw of the mouse. Injection of adeno-associated virus (3e10 vg) into the paw resulted in consistent transduction of all muscle fibers within seven days. Sufficient virus for multiple injections was generated from only two 15 cm culture dishes, making it possible to screen multiple transgenes without prohibitive cost. Delivery of therapeutic micro-dystrophins to the paws of dystrophic mice resulted in functional improvement that is observable in as little as 4 weeks. We also demonstrate several advantages of the lumbrical muscle over traditional muscle models, including its (1) compatibility with live cell fluorescent imaging, (2) long term viability in vitro and (3) amenability to diffusion of macromolecules.

764. Immune Tolerance Induction in Canine X-Linked Muscular Dystrophy with rAAV9-Microdystrophin Transduction

Hironori Hayashita-Kinoh,¹ Naoko Yugeta,¹ Hironori Okada,¹ Yuko Nitahara-Kasahara,¹ Tomoko Chiyo,¹ Takashi Okada,¹ Shin'ichi Takeda.¹
¹Dept. of Molecular Therapy, National Institute of Neuroscience, NCNP, Tokyo, Japan.

Background: Duchenne muscular dystrophy (DMD) is a congenital disease causing progressive deterioration of skeletal and cardiac muscles because of mutations in the dystrophin gene. We have previously reported that local injection of rAAV2 or rAAV8 to canine skeletal muscles without immunosuppression resulted in insufficient transgene expression with potent immune responses. Also we found that DCs would trigger an immune response against the rAAV-mediated transduction. Here we used fetuses of the canine X-linked muscular dystrophy in Japan (CXMD_J) to investigate the strategy of inducing immunotolerance to the rAAV as well as the muscle transduction profiles of rAAV9-microdystrophin. Methods: For fetal transduction, pregnant CXMD_J heterozygote was anesthetized and fetuses at post-coital day 35 were injected with 1x10¹² of rAAV-CMV-microdystrophin along with 1x10¹¹ of rAAV-CAG-Luciferase into amniotic fluid with ultrasound guidance. The yolk sacs and

umbilical cords were sampled at delivery, and then transduced rAAV copy numbers were estimated by qPCR. To expect systemic microdystrophin expression, we additionally injected rAAV9-CMV-microdystrophin into the jugular vein of 6 weeks old dystrophic dog. To examine the immunotolerance to the rAAV, purified canine peripheral leukocytes were exposed to rAAV9-microdystrophin for 4 hours, and then IFN- γ expression was analyzed using qRT-PCR. Temporal muscles of the rAAV-injected animals were collected by punch-biopsy at various time points for expression analysis. In addition, rAAV-injected CXMD_J and non-injected CXMD_J were compared each other to assess gait function and lameness in the hind limb. Moreover, using whole body plethysmography, echocardiography and electrocardiography, we analyzed the respiratory and cardiac functions of the rAAV-injected dogs. Results: To rAAV transduction to fetus in utero, higher amount of AAV genome in the yolk sack of the rAAV-injected dogs was detected compared to that of the rAAV-uninjected control. Expression of IFN- γ in the purified peripheral blood leukocytes after the rAAV exposure were not induced in one of the rAAV-injected dogs, suggesting the successful induction of immune tolerance against rAAV. rAAV-derived microdystrophin expression was confirmed by qRT-PCR and immunohistochemistry in the transduced dog. Monthly analysis of the transduced dystrophic dogs demonstrated superior gait function to non-injected littermate CXMD_J. At 1 year old, respiratory function and cardiac function of the transduced affected dog was milder form than untransduced affected dog. Conclusion: Our results demonstrate that induction of oral immunotolerance against rAAV with long-term transgene expression can be achieved by direct delivery of rAAV into amniotic fluid. This strategy would be effective approach to analyze the expression and function of transgene in vivo. These findings also support the future feasibilities of rAAV-mediated fetal gene delivery strategies. Furthermore, we plan oral immune tolerance induction after the delivery to meet clinical settings.

765. Interference of Myostatin and TGF-beta Signaling by Antisense-Mediated Exon Skipping in ALK4 5 Receptors

Dwi U. Kemaladewi,^{1,2} Sandra H. van Heiningen,¹ Annemieke Aartsma-Rus,¹ Gert-Jan B. van Ommen,¹ Peter ten Dijke,² Peter A. C. 't Hoen,¹ Willem M. H. Hoogaars.¹
¹Human Genetics, Leiden University Medical Center, Leiden, Netherlands; ²Molecular and Cell Biology, Leiden University Medical Center, Leiden, Netherlands.

Duchenne muscular dystrophy (DMD) is a severe neuromuscular disorder, which is characterized by the loss of muscle fibers and replacement by fibrotic tissue due to the lack of the dystrophin protein. Myostatin and Transforming Growth Factor (TGF)-beta play important roles in regulation of muscle differentiation and fibrosis, and are emerging as attractive therapeutic targets for DMD treatment. Both cytokines signal primarily via the overlapping Smad2/3-dependent signaling pathways. In this study we targeted myostatin TGF-beta type 1 receptors Acvr1b (ALK4) and Tgfr1 (ALK5) using antisense oligoribonucleotides (AON) targeting regions in the pre-mRNA encoding ligand binding and/or kinase domains of the receptors. Transfection of ALK4 or ALK5 AONs resulted in skipping of the targeted exon, ~50% downregulation of the full length transcript and enhanced myoblast differentiation. In addition, local administration into *mdx* mice showed considerable downregulation of full length ALK4 (~80%) or ALK5 (~50%), leading to ~50% increase of myogenic genes expression and ~40% decrease of fibrotic markers expression. Furthermore, we used these AONs to study how TGF-beta and myostatin signalings are regulated in different cells origins. We showed an exclusive requirement of ALK4 for myostatin signaling in myoblasts, but preference for ALK5 in the other cell types, which suggested that at least two co-receptors are involved in this cell-type

specific regulation of myostatin signaling. In summary, we were able to use this specific genetic approach to selectively disrupt myostatin or TGF-beta signaling, dissect the overlapping pathways and revealed a novel muscle specific mechanism of myostatin signaling. Systemic administrations are currently ongoing to further assess the therapeutic benefits of these AONs and to determine the differential effect of ALK4 and ALK5 knockdown on the dystrophic pathology of the *mdx* mice.

766. AAV9-Mediated FKRP Gene Therapy Restores the Expression of Functional Glycosylation of α -DG

Lei Xu,¹ Pei Lu,¹ Chi-Hsien Wang,² Jianbin Li,² Elizabeth Keramaris,¹ Xiao Xiao,² Qi Long Lu.¹

¹McColl-Lockwood Laboratory for Muscular Dystrophy Research, Department of Neurology, Cannon Research Center, Carolinas Medical Center, Carolinas Healthcare System, Charlotte, NC; ²Division of Molecular Pharmaceutics, Eshelman School of Pharmacy, University of North Carolina at Chapel Hill, Chapel Hill, NC.

Mutations in FKRP gene are one of the most common causes of muscular dystrophies, accounting for more than 19% of all the reported Limb Girdle muscular dystrophies (LGMD). Currently there is no effective treatment available. Gene replacement therapy is one of the most promising therapeutic strategy. In this study we examined the effects of AAV-FKRP in the P448L^{K1} mice via local and systemic delivery. Mutant mice (12 months) were administered with 5×10^9 v.g of AAV9-CB-FKRP to the tibialis anterior (TA) muscle and 1×10^{12} v.g via intraperitoneal injection (i.p.). Muscles were examined 4 weeks after injections by immunohistochemistry and western blot with antibodies to FKRP and glycosylated epitope of functional α -dystroglycan. Our results showed FKRP expression in all muscles including heart, diaphragm and other skeletal muscles in the mice treated by systemic delivery of AAV9-CB-FKRP. Consistent with our previous observation, the induced FKRP was mainly localized to Golgi apparatus within muscle fibers. Expression of FKRP consequently restored functional glycosylation of α -DG as judged by immunohistochemistry with the IIH6 antibody in all muscles examined including the cardiac muscle. Expression of the FKRP transgene and induction of glycosylation of α -DG and its binding to laminin were confirmed in all the skeletal and cardiac muscles on Western blots. Our results thus further confirmed that loss of FKRP function is the cause of hypoglycosylation of α -DG and LGMD2I.

767. Repair of Large Bone Defects Using Gene Activated Muscle Tissue Grafts

Oliver B. Betz,¹ Volker M. Betz,² Peter Augat,³ Volkmar Jansson,¹ Peter E. Mueller.¹

¹Orthopedic Surgery, University of Munich, Munich, Germany; ²Trauma Surgery, Technical University of Dresden, Dresden, Germany; ³Institute for Biomechanics, Trauma Clinic Murnau, Murnau, Germany.

Background and Aim: It was shown that bony defects can be repaired by implanting bone morphogenetic protein (BMP) transduced muscle cells. However, the drawback of this treatment modality is that it requires the isolation and long-term culture of transduced autologous cells, which makes this approach cumbersome, time-consuming, and expensive. Therefore, we transferred BMP-9 cDNA directly to muscle tissue fragments and evaluated the ability of such gene-activated muscle grafts to induce bone repair. **Methods:** Two of 20 male, syngeneic Fischer 344 rats used in this study served as donors for muscle tissue. The muscle fragments remained unmodified or were incubated with an adenoviral vector carrying the cDNA encoding BMP-9. Critical-size defects were created in the right femora of

18 rats and were filled (press fitted) with either unmodified muscle tissue or with BMP-9-activated muscle tissue. We did not include an empty defect group and a group receiving muscle tissue transduced with a non-osteogenic marker gene since our previous data show that these groups don't heal. **Results and Conclusion:** After 6 weeks, femora were evaluated by radiography, microcomputed tomography, histology, and biomechanical testing. Six weeks after implantation of BMP-9-activated muscle grafts, bone defects were bridged, as documented by radiographs and microCT imaging, and showed formation of a neocortex, as evaluated by histology. Bone volumes and biomechanical stability of the femora repaired by BMP-9-transduced muscle tissue were statistically indistinguishable compared to those of intact, contralateral femora. In contrast, control defects receiving unmodified muscle did not heal. BMP-9 gene-activated muscle grafts are osteoregenerative implants that provide an expedited means of treating and subsequently healing large segmental bone defects.

768. Defining Outcome Measures in Sporadic IBM for a Follistatin Gene Transfer Clinical Trial

Linda P. Lowes,¹ Lindsay N. Alfano,¹ Laurence Viollet,¹ Xiomara Q. Rosales,¹ Brian Kasper,¹ K. Reed Clark,¹ Zarife Sahenk,¹ Kevin M. Flanigan,¹ Jerry R. Mendell.¹

¹Center for Gene Therapy, Nationwide Children's Hospital, Columbus, OH.

Introduction: Sporadic inclusion body myositis (sIBM) presents with a stereotyped phenotype of knee extensor (quadriceps) muscle weakness resulting in frequent falls, a need for ambulatory aids, and loss of ambulation. Direct intramuscular injection of the alternatively spliced follistatin gene (FS344) mediated by AAV1 transduction results in the synthesis and secretion of the follistatin 315 isoform leading to increased muscle size and strength in the *mdx* mouse and nonhuman primates. Translating this to clinical trial requires outcome measures designed to test quadriceps strength and function in sIBM patients. **PURPOSE:** Evaluate the relationship between quadriceps strength and functional tests. Questions persist as to whether the strength of the quadriceps muscle will serve as a surrogate for functional improvement assessed by the timed tests of walking (distance over time) and rising from a chair. **DESIGN:** Measure quadriceps strength of 51 subjects with sIBM (12 women, 39 men; mean age 65 years range 44-88) using maximum voluntary isometric contraction (MVICT). Functional tests included Timed Up and Go (TUG) (stand up from a chair, walk 3 meters, turn and return to sitting), and distance walked for two (2MWT) and six (6MWT) minutes. **RESULTS:** Strength was compared to normative values. Quadriceps strength ranged from 1 to 90% (Mean=18%) of age-expected values. Hamstrings strength ranged from 10 to 111% of age-expected values (Mean=43%). Quadriceps strength shows a moderate correlation with the 2MWT (0.587, $p=0.00$) and 6MWT (0.555 $p=0.00$) and a mild correlation to TUG (-0.390 $p=0.004$). Analysis of variance revealed that knee extension strength accounted for 35 % of the variability in 6MWT distances ($r^2 = 0.345$ $p=0.000$). Thirty five participants completed the TUG between 6 and 41 seconds (mean = 12 seconds). Roughly one third (11) of the subjects exceeded 14 seconds and are considered to be a high risk for falling (Bohannon, 2006). Distances walked in 2 and 6 minutes were highly correlated (0.949 $p=0.00$) with quadriceps strength, suggesting that 2 minutes might be sufficient for testing function. **Conclusions:** Preserved quadriceps muscle strength predicts superior timed functional measures for TUG and distance covered in the 2 MWT and 6MWT suggesting that targeting this muscle will improve function. However, the variability in quadriceps strength and complex patterns of weakness (e.g., proximal and distal) emphasizes the need for careful patient selection to avoid the pitfalls of a false-negative effect of FS344 gene therapy. For some patients, improvement may require targeting multiple muscles to achieve clinically meaningful

outcomes. Bohannon RW. Reference values for the Timed Up and Go Test: A Descriptive Meta-Analysis. *Journal of Geriatric Physical Therapy*, 2006;29(2):64-8.

769. AAV-Based shRNA Silencing of NF- κ B Ameliorates Muscle Pathologies in *mdx* Mice

Qing Yang,^{1,2} Ying Tang,¹ Kara Imbrogno,¹ Aiping Lu,¹ Anmin Chen,² Fengjin Guo,² Freddie H. Fu,¹ Johnny Huard,¹ Bing Wang.¹
¹Orthopaedic Surgery, University of Pittsburgh, Pittsburgh, PA;
²Orthopaedic Surgery, Tongji Hospital, Huazhong University of Science and Technology, Wuhan, Hubei, China.

Duchenne muscular dystrophy (DMD) is an X-linked genetic muscle disease affecting 1 of every 3500 male births. Chronic inflammation, promoted by an up-regulated NF-kappaB (NF- κ B) pathway, plays a key role in Duchenne muscular dystrophy (DMD) patients' pathogenesis. Higher immune alertness, due to chronic inflammation and immune effector cell infiltration, challenges recombination adeno-associated viral (AAV) vector-mediated gene replacement treatment for DMD, especially in large animal models and clinical trials. We and others found that blocking the NF- κ B pathway could be a viable solution to promote muscle regeneration and to decrease necrosis in *mdx* mice (a murine DMD model), by using transgenic and AAV-mediated transfer (dominant-negative forms of IKK α & β) approaches, without any side effect. Based on the small interference RNA (siRNA) technology used in this study, we examined whether an AAV vector carrying small hairpin RNA (shRNA) targeting the NF- κ B/p65 subunit, a major subunit of NF- κ B associated with inflammation in *mdx* mice, inhibits NF- κ B activation as well as ameliorates pathological necrosis and regeneration in the locally-treated gastrocnemius (GAS) muscle of 1 and 4 month old *mdx* mice. At 1 month post-treatment, NF- κ B/p65 levels in locally-treated muscles were significantly decreased by the efficient transfer of specific shRNA in both of the different treated age groups. This led to remarkable decreases in necrosis and myofiber damage compared to *mdx* mice treated by a phosphate-buffered saline (PBS) or a control AAV vector containing a scrambled shRNA. The shRNA silencing of the NF- κ B pathway diminished the pathological myofiber regeneration in young *mdx* mice treated at 1 month of age, but it enhanced the capacity of myofiber regeneration in old *mdx* mice treated at 4 months of age. Moreover, quantitative analysis revealed that central nucleation of the myofibers of treated young *mdx* muscles was reduced from 67% to 34%, but centrally-located nuclei were not significantly reversed to the peripheral position in treated old *mdx* mice. Our findings indicate that AAV-mediated NF- κ B/p65-shRNA has the capacity to ameliorate muscle pathologies in *mdx* mice by degrading mRNA of the NF- κ B/p65 subunit.

770. Muscle Fiber Type-Predominant Promoter Activity in Lentiviral-Mediated Transgenic Mouse

Tomohiro Suga,¹ En Kimura,¹ Yuka Morioka,² Masahito Ikawa,² Sheng Li,³ Katsuhisa Uchino,¹ Yuji Uchida,⁴ Satoshi Yamashita,¹ Yasushi Maeda,¹ Jeffrey S. Chamberlain,³ Makoto Uchino.¹
¹Neurology, Kumamoto University Graduate School of Medical Sciences, Kumamoto, Japan; ²Research Institute for Microbial Diseases, Osaka University, Suita, Japan; ³Department of Neurology, University of Washington School of Medicine, Seattle; ⁴Pharmacology, Division of Life Science, Faculty of Pharmaceutical Sciences, Sojo University, Kumamoto, Japan.

Variations in gene promoter/enhancer activity in different muscle fiber types after gene transduction was noticed, but poorly analyzed. The murine stem cell virus (MSCV) promoter drives strong, stable gene expression in hematopoietic stem cells and several other cells, including cerebellar Purkinje cells, however it has not been studied in striate muscle. We injected a lentiviral vector carrying an MSCV-

EGFP cassette (LvMSCV-EGFP) into tibialis anterior muscles and observed strong EGFP expression in muscle fibers, primary cultured myoblasts, and myotubes isolated from injected muscles. We also generated lentiviral-mediated transgenic mice carrying the MSCV-EGFP cassette and detected transgene expression in striated muscles. LvMSCV-EGFP transgenic mice showed fiber type-dependent variations in expression: highest in type I and IIA, intermediate in type IID/X, and lowest in type IIB fibers. The soleus and diaphragm muscles, consisting mainly of type I and IIA, are most severely affected in the *mdx* mouse model of muscular dystrophy. Further analysis of this promoter may have the potential to achieve certain gene expression in severely affected muscles of *mdx* mice. The Lv-mediated transgenic mouse may prove a useful tool for assessing the enhancer/promoter activities of a variety of different regulatory cassettes.

771. Noninvasive Monitoring of Whole Body Muscle Function in Dystrophin-Deficient Dogs

Jin-Hong Shin,¹ Brian B. Greer,¹ Chady H. Hakim,¹ Zhihai He,² Dongsheng Duan.¹
¹Molecular Microbiology & Immunology, University of Missouri, Columbia, MO; ²Electrical and Computer Engineering, University of Missouri, Columbia, MO.

Dystrophin-deficient dogs are highly valuable tools for evaluating gene/cell therapies to treat Duchenne muscular dystrophy (DMD). Unfortunately, robust muscle functional end points are poorly defined in the canine DMD models. Here, we described a set of non-invasive methods for whole body muscle function analysis in normal and affected dogs. Briefly, the gait and voluntary activity were recorded using high-resolution digital video recorders. Gait recoding was repeated three times on three different days for each dog. Voluntary activity monitoring was performed under low-lux red lighting between 7pm and 5am for each dog. The stride length, stride speed, range of the motion and overall activity were analyzed using a customer-developed program. Three normal and four affected dogs of a litter were examined. Affected dogs showed significantly reduced stride length (affected, 35.7 \pm 8.5 cm; normal, 80.2 \pm 6.1 cm; $p < 0.02$) and stride speed (affected, 61.7 \pm 16.4 cm/sec; normal, 156.5 \pm 23.8 cm/sec; $p < 0.03$). The range of the motion in forelimb (palm, forearm and wrist) and hind limb (sole, low leg and ankle) was also significantly decreased in affected dogs. The affected dogs also showed significantly less movement during overnight monitoring. In summary, our results suggest that whole body muscle function was significantly compromised in affected dogs. Non-invasive video recording may represent a convenient and reliable method to monitor disease progression and gene/cell therapy effect in canine models of DMD.

772. Novel Functional Optical Imaging of Bone Repair in a Calvaria Defect Model

Ilan Kallai,¹ Nadav Kimelman-Bleich,¹ Wafa Tawackoli,² Xiaoyu Da,² Anthony Oh,² Gadi Pelled,^{1,2} Zulma Gazit,^{1,2} Dan Gazit.^{1,2}
¹Hebrew University of Jerusalem, Jerusalem, Israel; ²Surgery-Regenerative Medicine Institute, Cedars-Sinai Medical Center, Los Angeles.

The establishment of new therapeutic approaches for tissue repair and regeneration could be accelerated if adequate technologies to monitor the repair process are developed. In cranio-maxillofacial surgery, 96,000 bone grafts are performed each year to regenerate bone loss due to trauma or disease. Autologous bone, usually used to treat these lesions, is not always available and necessitates additional surgery for its harvest. Alternatively, there is a large potential supply of craniofacial allografts, which are composed of non-vital bone. Yet, these grafts often fail to integrate due to the formation of scar tissue

around them. Little is known of the mechanism behind the induction of scar tissue by allografts. We hypothesized that the establishment of functional fluorescence imaging (FLI) of osteogenesis, angiogenesis and osteoclastogenesis in calvarial defects treated with allografts would provide new insights that would enable the development of novel therapies for allograft bio-integration. **Methods:** A critical-size calvarial defect was created in FVB/n mice. Groups included transplantation of: allografts, autografts, and untreated defects (used as control). For blood flow and angiogenesis imaging the mice were injected with AngioSense 750 or Integrisense 750 on Days 5 and 12-post transplantation. FLI of angiogenesis was done using epi-illumination 24 hours after probe injection. Signal quantification eliminated autofluorescence. For osteogenesis imaging the mice were injected with OsteoSense 680 or 800. Imaging with Osteosense was performed on Day 20, *in vivo* and then *ex vivo* following mice sacrifice. Finally, bone resorption activity was imaged using Cathepsin-K 680 probe. Bone formation and vasculogenesis were analyzed as well using Micro CT imaging and histological analysis. **Results:** Functional FLI of blood flow showed significantly higher signal on Day 6 than on Day 13 in both treated groups and was greater in both treated groups than in the control group.

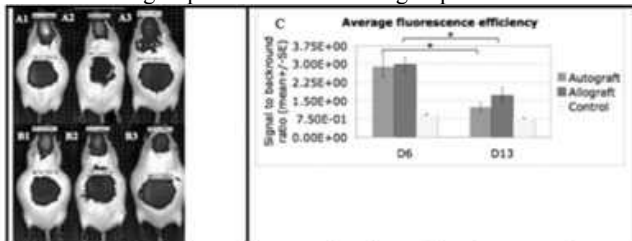

Fig. 1: FLI of angiogenesis in calvaria repair on Days 6 (A) and 13 (B). 1, autograft, 2, allograft, 3, untreated. (C) FLI quantification. * $P < 0.05$.

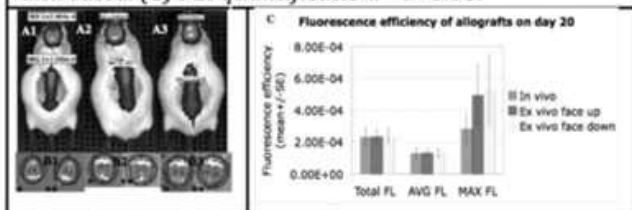

Fig. 2: FLI of OsteoSense 680 in calvaria repair. FLI on Day 20 (in vivo (A) and ex vivo (B [*calvaria face up; **calvaria face down])). 1, autograft, 2, allograft, 3, untreated. C: FLI quantification of the calvarial area signal *in vivo* and *ex vivo*.

Imaging of OsteoSense 680 on Day 20 *in vivo* and *ex vivo* showed no difference. [figure 2] Thus, although epi-illumination FLI is known for high tissue attenuation, in this model the signal is preserved. MicroCT and histological analysis performed on the calvaria samples corroborated the results of osteogenesis and angiogenesis detected by functional FLI. **Discussion:** Our findings indicate that functional FLI is a reliable tool for monitoring the repair of a calvarial bone defects. An evaluation and validation of new therapies involving allografts for the repair of calvarial injuries may be obtained using this system. Furthermore, a better understanding of the healing process in craniofacial defects treated with allografts may be reached.

773. Comparison of Efficacy of a Novel Double-Strand AAV2 Vector Harboring VEGF cDNA to AAV-SS-VEGF: *In Vitro* Transgene Expression and *In Vivo* Application To Enhance Survival of Ischemic Flaps

Xiao Tian Wang,¹ Bella Avanesian,¹ Qiangzhong Ma,¹ Yuqing Tang,¹ Heather Durfee,¹ Paul Y. Liu.¹

¹*Surgical Research and Gene Therapy, Roger Williams Medical Center, Providence, RI.*

Purpose: Conventional recombinant adeno-associated virus (rAAV) vectors are a single-stranded DNA vector, which needs to be converted to double-stranded DNA prior to transcription, thus delaying expression of transgene. Previously, we reported that rAAV-VEGF gene transfer to rat ischemic flaps improved flap survival in PSRC meetings. Here we compare the transgene expression efficacy of single-stranded (SS) and double-stranded AAV (DS) mediated human VEGF gene transfer and the efficiency in enhancing ischemic flap survival. **Materials and Methods:** 1. 293 cells were transduced with AAV-DS-VEGF or AAV-SS-VEGF (MOI=1, 10, 50, 100, n=3). Non-treatment was as control. The supernatant was harvested at day 3 and 7 for human VEGF ELISA. 2. Primary DB/DB and DBm fibroblasts were transduced with AAV-DS-VEGF and AAV-SS-VEGF (MOI=100, n=4). Non-treatment was as control. Three days later, the supernatant was harvested for ELISA analysis. We performed *in vitro* wound healing assay by scratching transduced cells and recording the healing for 48 hours using an IncuCyte system. 3. AAV-SS-VEGF and AAV-DS-VEGF (n=10) were injected into a 7 cm x 3 cm area on the dorsum of the rat. The control rats received saline or AAV-SS-GFP injection. One week later, a flap of 10 cm x 3 cm was raised. One week post-surgery, we evaluated the flap viability and harvested the injected and surviving flap tissues for histology. **Results:** 1. At day 3 and 7, both AAV-SS-VEGF and AAV-DS-VEGF treated 293 cell supernatant contained a greater amount of VEGF compared to control at all MOIs. AAV-DS-VEGF treated cell supernatant had higher expression than AAV-SS-VEGF supernatant did at all MOIs tested. 2. AAV-SS-VEGF and AAV-DS-VEGF treated mouse fibroblasts (DB/DB and DBm) presented enhanced human VEGF expression compared to control. AAV-DS-VEGF treated cell supernatant showed higher VEGF expression than AAV-SS-VEGF group. Supernatant of DBm fibroblasts contained more VEGF than that of DB/DB cells. 3. *In vitro* wound healing was improved by use of either AAV-SS-VEGF or AAV-DS-VEGF; no significant difference was found between two treatments. 4. AAV-DS-VEGF improved flap survival (57.2%±5.5%) compared to saline group (48%±5.1%) and AAV-SS-GFP group (45.9±6.3%) significantly ($p < 0.05$, both comparisons). AAV-SS-VEGF treated flaps showed 50.7% ± 7.2% survival, which did not differ significantly compared to saline and AAV-SS-GFP groups. **Discussion/Conclusions:** AAV-DS-VEGF and AAV-GFP-VEGF can successfully transduce primary diabetic and non-diabetic fibroblasts. AAV-DS-VEGF produces higher and earlier transgene expression. AAV-SS-VEGF and AAV-DS-VEGF enhanced *in vitro* wound healing. AAV-DS-VEGF improves flap survival compared to controls, but AAV-SS-VEGF did not significantly improve flap survival in the present study, which contrasts to our previous results of significant improvement in flap survival when it was injected 2 weeks prior to flap elevation.

774. Serum Neural Cell Adhesion Molecule (NCAM) Is Hyposialylated in Hereditary Inclusion Body Myopathy (HIBM)

Yadira Valles-Ayoub,¹ Saghi Esfandiariifard,¹ Zeshan Khokher,^{1,2} Pedram Sinai,¹ Rosangela Carbajo,^{1,2} Daniel No,^{1,2} Babak Darvish,³ Marvin Pietruszka,¹ Emil Kakkis,⁴ Daniel Darvish.¹
¹HIBM Research Group, Reseda, CA; ²Los Angeles Mission College, Sylmar, CA; ³VA Greater Los Angeles (VA-GLA/UCLA), Los Angeles, CA; ⁴Ultragenyx, Navato, CA.

Hereditary Inclusion Body Myopathy (HIBM) is a young-adult onset autosomal recessive disorder caused by hypomorphic rate limiting enzyme of sialic acid biosynthesis. Evidence suggests the pathology of HIBM is related to mutations in the GNE gene, which encodes the bifunctional enzyme UDP-N-Acetylglucosamine 2-Epimerase / N-Acetylmannosamine Kinase. The clinical features of HIBM include slow progressive muscle weakness and atrophy. Patients are typically diagnosed at 20-30 years of age, and most patients are incapacitated and wheelchair-confined by 30-50 years of age. Some sialic acid containing glycoproteins, including NCAM, are hyposialylated in HIBM muscle biopsy samples. We developed a method to allow detection of serum NCAM sialylation using Western Blot, and tested serum samples from several patients. Preliminary results show a clear difference in polysialylated and hyposialylated forms of NCAM extracted from serum, and showed NCAM is hyposialylated in HIBM serum samples. This exciting initial finding may prove useful in reducing the need for serial muscle biopsies in HIBM treatment trials. Additional studies are underway to further validate this finding, and to evaluate the specificity, reliability, and robustness of this potential serum biomarker for HIBM.

Cancer - Immunotherapy III

775. Adoptive T Cell Therapy Generates Tumor Escape Variants through Induction of Genomic Instability

Karen Kaluza,¹ Jill Thompson,¹ Heather Flynn Gilmer,¹ Darlene Knutson,¹ Richard Vile.¹
¹Mayo Clinic, Rochester, MN.

Adoptive T cell transfer is a promising therapy for cancer. However, clinically, many initial responders still go on to relapse. We reasoned that a better understanding of the mechanisms tumor cells use to escape potent T cell responses would reveal ways to change such protocols in order to improve long-term survival. We routinely observe that adoptive transfer of ova-specific OT-I T cells into C57BL/6 mice apparently clears small, established tumors and significantly prolong the survival of the mice. However, tumors often recur weeks later. To investigate the reasons for this escape, we extended this model by directly challenging OT-I mice, in which all T cells are specific for ova. In these mice, tumor appearance is significantly delayed as compared to wild-type mice, but aggressive tumors still emerge in most OT-I mice within two months of challenge. By comparing tumors recovered from mice which received no therapy to those from mice receiving OT-I transfer, or to tumors growing in OT-I mice, we identified several patterns associated with escape. Most strikingly, we found that many of these tumors had not only lost expression of OVA but that they had lost the ova gene itself. This novel escape mechanism occurred both in tumors under the most intense T cell pressure (tumors which grew in OT-I mice) and, to a lesser extent, when T cells were administered to C57BL/6 mice with B16ova tumors. T cell/tumor cell co-cultures *in vitro* showed that OT-I T cell activity is sufficient to induce the emergence, and subsequent selection, of ova gene-loss tumor cells. Based on these results, we hypothesized that therapy would be improved by combining OT-I adoptive transfer with transfer of another T cell clone targeting a

different tumor associated antigen. Pmel T cells target the melanoma antigen gp100. Under conditions where adoptive transfer of either OT-I or Pmel T cells alone did not cure mice of B16ova tumors, combination therapy (OT-I+Pmel) was able to do so. Similarly, when transferred into mice with established tumors, the combination of OT-I and Pmel T cells provided significantly better therapy than either clone alone. Significantly, recurrent tumors from mice treated with both OT-I and Pmel cells continued to express both target antigens, and the adoptively transferred T cells persisted in the treated mice. Overall, our results suggest that adoptive T cell transfer therapies can actively promote the emergence of antigen escape variants by inducing genomic instability in target tumor cells. By targeting multiple antigens simultaneously it may be possible to reduce emergence of such variants. We are currently using these approaches to combine adoptive T cell therapies with virotherapies in which the T cells are used as carriers of oncolytic viruses and/or in which viruses expressing tumour associated antigens are used to enhance the persistence and activity of the adoptively transferred T cells.

776. Gene Therapy with a Novel Fusion Protein of Interferon Alpha and Apolipoprotein A-I Exerts Antitumor Effects

Jessica Fioravanti,¹ Jose I. Quetglas,¹ José Medina-Echeverz,¹ Nuria Ardaiz,¹ Jesús Prieto,¹ Cristian Smerdou,¹ Pedro Berraondo.¹
¹Hepatology and Gene Therapy, Center for Applied Medical Research, Pamplona, Navarra, Spain.

Interferon alpha (IFN α) is widely used for the treatment of viral hepatitis and as an antitumor agent, but substantial toxicity hampers its clinical use. In this work, we aimed at improving the efficacy of IFN α gene therapy by fusing this cytokine with apolipoprotein A-I (ApoA-I) as stabilizing and targeting moiety. To characterize this new fusion protein, we generated plasmids encoding IFN α , albumin bound to IFN α (ALF) or IFN α linked to ApoA-I (IA) and mice were treated either by hydrodynamic administration of the plasmids, by injection of the corresponding recombinant proteins, or HDLs containing IA. The plasma half-life of IA was intermediate between IFN α and ALF. IA exhibits stronger *in vivo* antiviral activity than IFN α and the hematologic cytopenic effects of IA are milder than those observed when using IFN α or ALF. Interestingly, *in vivo* studies showed that IA boosts T cell immune responses more efficiently than IFN α or ALF. To take advantage of this immunostimulatory activity for solid cancer treatment, we generated a Semliki Forest Virus (SFV) vector engineered to express the fusion protein. SFV belongs to the Alphavirus genus, which comprises enveloped viruses carrying a single positive-strand RNA genome of about 12 kb. These Alphavirus-based vectors have emerged as a promising tool for cancer gene therapy, since they combine an extraordinarily high transgene expression level with the capacity to induce apoptosis in infected cells. This recombinant virus was tested in a model of established TC-1 tumor. Intratumoral injection of SFV-IA was able to eradicate 50 % of large tumors treated 21 days after implantation with long-term tumor-free survival and very low toxicity.

777. Highly Efficient and Safe Vectors for TCR Gene Therapy: Silencing of Endogenous TCR Improved Expression and Anti-Tumor Reactivity of Transduced Tumor-Specific TCRs in Human Lymphocytes

Sachiko Okamoto,¹ Hiroaki Ikeda,² Hiroshi Fujiwara,³ Ikuei Nukaya,¹ Hirofumi Yoshioka,¹ Masaki Yasukawa,³ Hiroshi Shiku,² Junichi Mineno.¹

¹Center for Cell and Gene Therapy, Takara Bio Inc., Otsu, Shiga, Japan; ²Department of Immuno-Genetic Therapy, Mie University Graduate School of Medicine, Tsu, Mie, Japan; ³Department of Bioregulatory Medicine, Ehime University Graduate School of Medicine, Toon, Ehime, Japan.

Adoptive immunotherapy with gene-modified T cells that express tumor antigen specific T-cell receptor (TCR) has proven to be a promising strategy to treat cancer patients. However, there are some potential drawbacks to this strategy: Endogenous TCRs competes with introduced TCRs for CD3 molecules, resulting in inefficient surface expression of introduced TCRs. Furthermore, the introduced TCRs mispair with endogenous TCRs, generating T cells with unknown specificities. The expression level of the transgene can be enhanced by increasing the vector copy number. However, the risk of infusing cells with aberrant vector insertion site that could promote oncogenic changes should be increased with vector copy number. Therefore, a strategy for achieving high expression of the transduced TCRs with relatively low copy numbers and preventing TCR mispairing is required for more efficient and safe TCR gene therapy. To overcome those obstacles, we have developed “siTCR” retroviral vectors encoding both siRNAs to knockdown endogenous TCRs and codon-optimized, siRNA-resistant TCR chains specific for tumor antigens. Human T cells transduced with these vectors exhibited high surface expression of the introduced TCRs accompanied with reduced endogenous TCRs at low vector copy numbers, resulting in enhanced cytotoxic activity against antigen-expressing tumor cells. As the target of this strategy is endogenous TCRs, siTCR vectors may be a powerful tool for any TCR gene therapy without any dependency of TCR variation (Cancer Res 2009;69,9003-11). We are in process to start clinical trials using siTCR vectors expressing HLA-A*24:02 restricted MAGE-A4 or WT1 specific TCRs. To improve the efficacy of siTCR vectors, we have developed the 2A peptide based-siTCR vectors which could increase the expression levels of transduced TCRs compared to dual promoter based-siTCR vectors. This newly constructed 2A based-siTCR retroviral vectors could achieve higher surface expression level of introduced TCRs, however there was a case which dual promoter based- and 2A based-siTCR retroviral vectors achieved equivalent expression levels of transduced TCRs, even the expression levels of introduced TCR β chain was much higher in 2A based-siTCR vector transduced T cells, showing the importance of elimination of endogenous TCRs for efficient TCR gene expression. We have also compared this “siTCR” strategy and the other strategies to reduce TCR mispairing such as the addition of a new interchain disulfide bond in the constant regions. Furthermore, we have also developed the siTCR lentiviral vectors which could enhance the therapeutic TCR heterodimer expression at low proviral copy number, and reduce the endogenous TCR expression, which may effectively prevent TCR mispairing. Therefore, our novel “siTCR technology” may open the new gate for effective immunotherapy in cancer patients.

778. Development of a Drug Resistant Immunocompetent Cell-Based Therapy To Treat Neuroblastoma and Other Cancers

Anindya Dasgupta,¹ Jordan E. Shields,¹ Robert Moot,¹ H. Trent Spencer.¹

¹Department of Pediatrics, Emory University, Atlanta, GA.

Current treatments are ineffective at controlling advanced stage neuroblastoma. Thus novel therapies, such as cellular immunotherapies are being pursued to improve survival. Clinical evaluation of several cellular therapies demonstrated low toxicity, but also low efficacy. If novel immunocompetent cell-based therapies can be administered concurrently with standard frontline chemotherapy, a significant improvement of anti-neoplastic therapy may be achieved, possibly with administration of less aggressive chemotherapy. However, low level HLA expression by neuroblastoma limits the use of HLA-restricted adaptive immunity. Also, drug induced toxicities frequently encountered during chemotherapy treatments can be detrimental to any cell-based therapies administered in conjunction with chemotherapy strategies. To overcome these limitations, we are testing the use of HLA-unrestricted innate immune response cells, such as IL2- dependent NK92 cells, and using lentiviral-based applications to bioengineer these cells to be drug resistant. It was hypothesized that the introduction of cDNAs that confer drug resistance to the immunocompetent cells would allow for the co-administration of immuno- and chemotherapy, an anti-cancer strategy that we term drug resistant immunotherapy (DRI). We show that the introduction of the well studied transgenes, P140KMGMT and L22YDHFR, into NK92 cells using a bicistronic lentiviral vector confers high level resistance to both temozolomide and trimetrexate. In addition, retroviral introduction of the cDNA encoding human IL-2 provides cytokine-independent growth. The introduction of these nucleic acid sequences has no effect on cell growth and the engineered cells retain their strong cytotoxic potential against neuroblastoma cells. In vivo testing of DRI was accomplished using an aggressive neuroblastoma cell line, IMR-5, implanted in immunosuppressant mice. A chemotherapy regimen comprising temozolomide (50 mg/kg/mice) and trimetrexate (15 mg/kg/mice) was developed that has no measurable effect on complete blood counts, including lymphoid and myeloid cell populations. This regimen alone attenuates IMR-5 cell growth during treatment, but once ended mice must be sacrificed within a week due to uncontrolled tumor growth. Administration of immunotherapy only also provides some benefit but all immunotherapy only treated mice needed to be sacrificed by day 14 due to excessive tumor burden. However, all DRI treated mice, with treatments consisting of immunotherapy followed 2 hours later by chemotherapy, are alive 40 days after initiation of treatment, with regression of all tumors. In contrast, mice treated with non-modified NK92 cell-based therapy in combination with chemotherapy did not respond well to therapy, as evidenced by limited tumor regression, which was similar to the effect in the chemotherapy only treated mice. These findings demonstrate that a DRI-based treatment approach combining drug resistant immunocompetent cell-based therapy with chemotherapy is highly effective in controlling the growth of aggressive neuroblastoma in mice. We anticipate such a therapy can also be directed toward other malignant diseases that continue to have unmet medical needs.

779. Gold Nanoshell Induced Photothermal Therapy Ablates Primary Tumors and Enhances Anti-Tumor Activity of Antigen-Specific Cytotoxic T Lymphocytes

Adham S. Bear,¹ Laura C. Kennedy,² Joseph K. Young,³ Rebekah A. Drezek,² Aaron E. Foster.¹

¹Center for Cell and Gene Therapy, Baylor College of Medicine, Texas Children's Hospital and The Methodist Hospital, Houston, TX; ²Department of Bioengineering, Rice University, Houston, TX; ³Department of Electrical and Computer Engineering, Rice University, Houston, TX.

Adoptive transfer of cytotoxic T lymphocytes (CTL) has shown increasing promise for the treatment of a variety of cancers. Efficacy of this approach, however, is limited by the immune suppressive tumor microenvironment, suboptimal migration into tumors and poor expansion and survival of CTL following infusion. Thermal ablation has the potential to address these deficiencies by destroying tumor and tumor associated suppressor cells, inducing local and systemic inflammation to increase T cell infiltration, and releasing tumor antigens to promote CTL stimulation, expansion and survival. Here we examine whether gold nanoshell (GNS)-enabled photothermal therapy (PTT) of tumors can enhance the *in vivo* migration, expansion and efficacy of adoptively transferred CTL. C57BL/6 mice were injected subcutaneously with 5×10^5 B16 tumor cells in the right and left flank. After 7 days, tumors on the right flank were treated with 10^{11} 40 nm GNS and subsequently exposed to near infrared energy (4 W/cm², 3 min, 5 mm spotsize). 7 days post GNS treatment; the contralateral tumor was excised and analyzed by FACS for Tregs (CD4+CD25+FoxP3+), T cell infiltration (CD3+CD4+ and CD3+CD8+), NK cells (CD56+), dendritic cell (DC; CD11c+) and myeloid-derived suppressor cells (MDSC) (CD11b+Gr-1+CD124+). Analysis of DC infiltration was also performed (CD11c+CD80+CD86+). We measured endogenous anti-tumor immunity following PTT using IFN- γ ELISpot assays against Trp2 and gp100 antigens. To test whether PTT enhances CTL therapy, mice were injected with contralateral B16 tumors, where the right tumor was treated with GNS-enabled PTT. After 48 hours, mice received 1×10^7 activated gp100-specific pmel1 T cells. Mice were assessed for tumor growth by caliper measurement. For migration and expansion studies, pmel1 T cells were transduced with luciferase and analyzed using bioluminescent imaging. PTT treatment resulted in complete tumor ablation. PTT also significantly reduced tumor growth of the contralateral tumor compared to control mice ($p < .001$). Examination of immune cell composition of the second tumor showed dramatic infiltration of CD8+CD25+ T cells (>25%) compared to untreated mice. Tumors also exhibited increased infiltration of mature DC (CD11c+CD80+CD86+). Additionally, following PTT, IFN- γ ELISpots showed increased levels of Trp2 and gp100-specific CD8+ T cells. Next mice were treated with or without PTT and in combination or absence of CTL infusion. PTT combined with CTL therapy showed superior anti-tumor activity when compared to either therapy alone ($p < .05$). Importantly, PTT facilitated migration into secondary tumors and increased expansion of luciferase-modified CTL. Thus, PTT represents a minimally invasive strategy to debulk primary tumors and elicit systemic and local inflammation to promote infiltration of anti-tumor CTL, and may therefore be used to condition the host to enhance adoptive T cell therapy.

780. Tumor Immune Evasion Enforced by Viral cDNA Library Vaccination Can be Exploited for Ambush of Emerging Tumor Cell Variants

Phonphimon Wongthida,¹ Elizabeth Ilett,² Jose Pulido,¹ Timothy Kottke,¹ Jill Thompson,¹ Feorillo Galivo,¹ Peter Selby,² Alan Melcher,² Richard Vile.^{1,2}

¹Mayo Clinic, Rochester, MN; ²University of Leeds, Leeds, United Kingdom.

We have previously developed an immunotherapy for cancer in which normal cells are intentionally killed in the presence of the potent adjuvant hsp70 to induce autoimmune T cell reactivity. In turn, this autoimmune reactivity is effective against tumors expressing normal tissue specific antigens of the same histological type (*Cancer Res* 2009 69:7767). We have also shown that oncolytic viruses, such as VSV, are powerful immunoadjuvants for induction of T cell responses against tumor associated antigens (TAA), if a) the virus leads to release of TAA in the lymph node (*Nat Med* 2008 14: 37; *ClinCanRes.* 2009 15: 4374) and b) when the virus itself encodes the TAA (*Cancer Res* 2007 15:2840). Therefore, we hypothesised that it would be possible to combine induction of autoimmune reactivity against normal tissue specific antigens with highly immunogenic, viral adjuvant-induced antigen presentation, for cancer immunotherapy. To achieve this, we cloned cDNA libraries from a variety of sources, including normal tissues, into oncolytic viruses such as VSV. We reasoned that the viral-expressed cDNA library would encompass epitopes from most normal antigens which might serve as immunogens for cancer rejection, thereby dispensing with the need for direct killing of the normal tissue. We have now shown that intravenous injection of VSV encoding a cDNA library leads to regression of murine tumors in immune competent mice in both prostate and melanoma models. In the prostate model, regressions were immune mediated, as opposed to induced by viral oncolysis, and priming of a CD4+ dependent, Th17 response against self antigens was dependent upon hsp70 induction in the lymph nodes of treated mice. However, under suboptimal vaccinating conditions, tumor escape was possible, but only by the acquisition of a radically new tumor cell phenotype. Recurrent tumors could then be treated by sequential vaccination with a cDNA library from the recurrent tumors through a Th1-like, IFN- γ -dependent mechanism. This two-step 'trap-and-ambush' strategy uses initial vaccination to trap tumor cells into a very restricted evolution to ensure escape from the selective pressure imposed against the very broad antigenic repertoire encoded by the cDNA library. Thereafter, a highly targeted second line treatment against the new, enforced tumor phenotype can ambush these emerging escape variants. We have now transferred these cDNA libraries into vaccinia virus in order to increase the cloning capacity available for expression of antigens and to enhance our ability to co-express molecular adjuvants, such as hsp70, which should potentiate the ability of the viral expressed libraries to induce anti tumour immunity. Overall, this approach dispenses with the need to induce direct damage to normal tissues *in situ*, allows for wide-ranging *in vivo* immune selection for antigens which are likely to be effective targets for both autoimmune and anti tumor responses and uses the ability of oncolytic viruses to induce hsp70-mediated mechanisms of self antigen presentation as a novel approach to the immunotherapy of cancer.

781. Adoptive Immunotherapy Using EphA2-Specific T Cells for the Treatment of Glioblastoma Multiforme

Kevin K. H. Chow,^{1,2,3} Vita S. Salsman,^{1,2} Sunitha Kakarla,^{1,2,3} Claudia Gerken,^{1,2} Yvonne Kew,⁴ Robert G. Grossman,⁴ Suzanne Z. Powell,⁵ Nabil Ahmed,^{1,2,3} Stephen M. Gottschalk.^{1,2,3}
¹Center for Cell and Gene Therapy, Baylor College of Medicine, Houston; ²Texas Children's Cancer Center, Texas Children's Hospital, Houston; ³Translational Biology and Molecular Medicine, Baylor College of Medicine, Houston; ⁴Neurosurgery, The Methodist Hospital, Houston; ⁵Pathology, The Methodist Hospital, Houston.

Background: Glioblastoma multiforme (GBM) is the most common and most aggressive primary brain tumor in humans and is virtually incurable with current standard therapies. Thus, new targeted treatments are needed to improve outcomes, and adoptive immunotherapies have the potential to fulfill this need. Genetic modification of T cells with chimeric antigen receptors (CARs) enables the rapid generation of T cells that can recognize and kill tumors with specific tumor antigens. Erythropoietin-producing hepatocellular A2 (EphA2) receptor has been identified as an antigen that is overexpressed in many solid tumors including GBM. The aim of this study was to 1) generate a CAR specific for EphA2 and express it in T cells, and 2) determine if EphA2-specific T cells can selectively recognize and kill EphA2-positive GBM *ex vivo* and *in vivo*. **Methods:** EphA2.CAR was generated by fusing the antigen-binding domain of an anti-EphA2 antibody (4H5) to the signaling domain of a T-cell receptor. T cells were retrovirally transduced to express the EphA2.CAR (EphA2-specific T cells). The *ex vivo* efficacy of the EphA2-specific T cells was determined by their ability to proliferate and secrete cytokines in response to EphA2-positive tumor cells, and to kill EphA2-positive targets in cytotoxicity assays. The *in vivo* efficacy of EphA2-specific T cells was tested for their ability to induce tumor regression in an orthotopic xenograft murine model of GBM. **Results:** EphA2.CAR was successfully expressed on T cells as determined by FACS. Expression of EphA2 receptor on target cells was confirmed by Western blot. EphA2-specific T cells were able to recognize EphA2-positive tumors as evidenced by their production of high levels of IFN- γ and IL-2. EphA2-specific T cells were also able to kill EphA2-positive tumors, whereas nonspecific T cells could not. *In vivo*, EphA2-specific T cells were able to induce regression of established GBM tumors and increase overall survival of the treated mice. **Conclusions:** We successfully generated an EphA2.CAR that is able to direct T cells to tumors that overexpress the EphA2 receptor. EphA2-specific T cells were able to recognize EphA2-positive GBM, secreting immunostimulatory cytokines in response and killing the tumor. EphA2-specific T cells were also able to cause regression of established GBM xenografts in an orthotopic murine model. EphA2 has emerged as an important tumor antigen for immunotherapy, and targeting this receptor using EphA2.CAR-modified T cells shows promise for the treatment of GBM and other solid tumors.

782. Improved T Cell Survival, Tumor Localization and Tumor Eradication by Folate Receptor- α Redirected T Cells Is Achieved by Provision of CD137 Costimulatory Signaling

Degang Song,¹ Silvana Canevari,³ Carl H. June,² George Coukos,¹ Daniel J. Powell, Jr.^{1,2}
¹Department of Obstetrics and Gynecology, University of Pennsylvania, Philadelphia, PA; ²Department of Pathology and Laboratory Medicine, University of Pennsylvania, Philadelphia, PA; ³Department of Experimental Oncology and Molecular Medicine, Istituto Nazionale dei Tumori, Milan, Italy.

Human T cells engineered to express a chimeric immune receptor (CIR) specific for folate receptor-alpha (FR α) have shown robust anti-tumor activity against epithelial cancers *in vitro* but not in the clinic due to their inability to persist and home to tumor *in vivo*. To address this issue, CIRs were constructed containing an FR α -specific scFv (MOv19) coupled to the T cell receptor CD3 ζ chain signaling module alone or in combination with the CD137 (4-1BB) costimulatory motif in tandem. Primary human T cells engineered to express conventional MOv19- ζ or costimulatory MOv19-BB ζ CIRs secrete various proinflammatory cytokines and exert cytotoxic function when cocultured with FR α + tumor cells *in vitro*. However, only transfer of human T cells engineered to express the costimulated MOv19-BB ζ CIR mediates tumor regression in immunodeficient mice bearing large, established human cancer. Tumor regression mediated by MOv19-BB ζ CIR T cells is achievable via intravenous, intraperitoneal or intratumoral routes of infusion and mediates the regression of intraperitoneal, subcutaneous, or lung-involved human ovarian cancer. Tumor response was associated with the selective survival and tumor localization of human T cells *in vivo* which was only observed in mice receiving costimulated MOv19-BB ζ CIR T cells. Although T cell persistence and tumor activity are largely antigen-driven, provision of CD137 signaling in the absence of specific antigen recognition by CIR improves T cell persistence but not anti-tumor activity *in vivo*. Thus, while genetically engineered T cells expressing conventional anti-FR α - ζ CIR can mediate killing of cancer cells *in vitro*, antitumor activity *in vivo* is achievable with provision of CD137 costimulatory signaling in tandem.

783. BPX-101 Vaccine: Regulation of CD40 Signaling in DCs *In Vivo* Leads to Spiking Cytokines Correlative with Objective Responses in mCRPC Patients in a Phase I/IIa Trial

David M. Spencer,¹ Natalia Lapteva,¹ Jan O. Kemnade,¹ Jon M. Levitt,¹ John McMannis,³ Guru Sonpavde,² Kevin M. Slawin.⁴
¹Path&Immuno, Baylor College of Medicine, Houston, TX; ²Texas Oncology, Houston, TX; ³MDACC, Houston, TX; ⁴Vanguard Urologic Institute, Houston, TX.

Background and Objectives: BPX-101 represents a novel vaccine for metastatic castration-resistant prostate cancer (mCRPC), comprising prostate specific membrane antigen (PSMA)-pulsed autologous dendritic cells (DCs) expressing a synthetic ligand (AP1903)-inducible version of CD40 (iCD40). Unlike typical *ex vivo*-activated DC vaccines, BPX-101 can be activated after lymph node migration by delayed infusion of AP1903. After showing low toxicity and efficacy against various syngeneic mouse tumors, we tested safety and exploratory efficacy in a 3 + 3 phase I/IIa clinical trial. **Methods:** 12 mCRPC patients, who received a maximum of 1 prior chemotherapy regimen, received Adv-iCD40-transduced, PSMA-pulsed GM-CSF/IL4-matured autologous DCs in a 3 + 3 dose-escalation trial. Gene-modified DCs were pre-activated with LPS (250 ng/mL) and AP1903 (100 ng/mL) O/N, extensively washed and cryopreserved prior to i.d. administration of 6 fortnightly injections during the "induction" phase (4, 12.5 and 25 x 10⁶ cells/dose; 3, 3, and

6 patients, respectively). Up to 5 extra doses were administered every 8 weeks, or until disease progression. 24 hours after each injection, AP1903 (0.4 mg/kg) was administered i.v. Serum for multiplex cytokine testing was obtained weekly during the acute phase. PSA and radiological testing was performed at regular intervals. Injection site biopsies were obtained for antigen-specific immunological testing following the 4th vaccination. **Results:** Planned enrollment was completed and vaccine successfully manufactured for all patients. Most (10/12) completed the acute phase and 2 went off protocol due to progression. Toxicities were mild and primarily confined to injection-site DTH responses, which were common and expected. Most (5/7) patients with evaluable T cells grown out from injection sites revealed PSMA-specific immunity, biased towards Th1 (3/5) or Th2 (2/5) cytokine production. 9/12 patients revealed significant (10 to 10,000-fold) but asymptomatic cytokine spikes 1 week after each vaccination that returned to baseline within 7 days. At 12 weeks, PSA doubling times (PSADT) increased on most (8/12) patients. Notably, 1 post-docetaxel, low-dose patient achieved a RECIST PR, and 1 high-dose patient underwent near complete elimination of multi-focal lung metastases with SD following the induction phase. Remarkably, 1 mid-dose patient with widespread visceral and bone metastasis achieved a RECIST CR with docetaxel-based chemotherapy after the induction phase and remains stable with undetectable PSA 1 year after enrollment. **Conclusions:** Vaccination with BPX-101 followed by AP1903 appears safe and can elicit strong PSMA-specific and other immune responses that appear to correlate with clinical responses. Combination therapy with chemotherapy may further expand efficacy. Finally, we will discuss observed improvements from “unified” vectors under development, comprising both iCD40 and TLR signaling along with antigen expression.

784. Pre-Clinical Safety and Toxicity Dose-Finding of a Novel Bi-Cistronic High-Capacity Adenoviral Vector Encoding Flt3L and TK: Identification of a Maximally Tolerated Dose in the Brain with Restricted Biodistribution of Vector Genomes

Mariana Puntel,¹ A. K. M. G. Muhammad,¹ Weidong Xiong,¹ Kyle Kelson,¹ Alireza Salem,¹ Kurt M. Kroeger,¹ Chunyan Liu,¹ Catherine Farrokhi,¹ Liliana Lacayo,¹ Robert N. Pechnick,¹ Donna Palmer,² Philip Ng,² Maria G. Castro,¹ Pedro R. Lowenstein.¹
¹Cedars-Sinai Medical Center/UCLA, Los Angeles, CA; ²Baylor College of Medicine, Houston, TX.

Glioblastoma multiforme (GBM) is the most aggressive primary brain tumor, is highly invasive, and invariably recurs killing the patient. Using a combined immunotherapy/conditional cytotoxic approach, we have previously demonstrated that intratumoral delivery of first generation adenoviral vectors (Ad) encoding the conditional cytotoxic gene, herpes simplex virus type 1-thymidine kinase (TK) and Fms-like Tyrosine Kinase 3 ligand (Flt3L) generates a tumor antigen specific anti-GBM immune response resulting in a long-term survival and immunological memory in over eight orthotopic rat and mouse models of GBM. The large cloning capacity of HC-Ads has allowed us to develop a single novel, bi-cistronic HC-Ad vector engineered for inducible expression of Flt3L using the TetOn regulatory system and constitutive expression of HSV1-TK; this simplifies downstream process development, improves the immunological safety profile, and facilitates clinical implementation. We assessed the safety profile of this novel dual HC-Ad vector in naive Lewis rats at three doses of HC-Ad vector, at short-term (5 days), medium-term (1 month) and long-term (12 months) time points. To identify the maximally tolerated dose in the brain, we assessed safety and toxicity as determined by biodistribution of vector genomes using real-time quantitative PCR (qPCR), levels of Flt3L in the serum, Ad-specific neutralizing antibodies, TK-specific serum antibodies, serum biochemistry, and

a comprehensive panel of behavioral tests. HC-Ad vector genomes were below detectable limits in all peripheral organs tested and restricted to the tumor bearing brain hemisphere. At the highest dose tested (1×10^{10} vp), neuropathological analysis of brain sections revealed considerable disruption of the neuronal architecture and transient short-term inflammation. Levels of Flt3L in serum were only detectable at 5 days, but not at 1 month and 12 months post treatment. Biochemical laboratory parameters indicated normal liver and renal function for all doses. Analysis of amphetamine-induced rotational behavior, total locomotor activity and rearing activity did not reveal any behavioral abnormalities compared to age matched control animals, even at the high dose that caused neuropathology. These data reveal that 1×10^9 vp is the MTD in the naive Lewis rat brain, thus further demonstrating the high safety profile of the dual HC-Ad vector administration, and supports further downstream process development for eventual implementation in human clinical trials.

785. Targeting of Myeloid Leukemia Stem Cells through Genetic Redirection of T Cells Against CD44 Variant 6

Monica Casucci,¹ Laura Falcone,¹ Barbara Camisa,¹ Zulma Magnani,¹ Claudio Bordignon,² Barbara Savoldo,³ Gianpietro Dotti,³ Chiara Bonini,¹ Attilio Bondanza.¹
¹Division of Regenerative Medicine, Stem Cells, and Gene Therapy, Experimental Hematology Unit, San Raffaele Scientific Institute, Milano, Italy; ²MolMed S.p.A, Milano, Italy; ³Center for Cell and Gene Therapy, Baylor College of Medicine, Houston, TX.

Acute myeloid leukemia (AML) is organized as a hierarchy dominated by leukemia stem cells (LSC). LSC are resistant to radiochemotherapy and ultimately responsible for disease relapse. The results of allogeneic hematopoietic stem cell transplantation (allo-SCT) suggest that LSC are sensitive to adoptive T-cell therapy. Nevertheless, the frequent occurrence of HLA-loss variants after transplantation recommends the targeting of antigens crucial for LSC. LSC self-renewal depends on signals provided within the SC-niche, among which those mediated by CD44 and its variant isoforms. Accordingly, CD44-specific mAb have been shown to specifically eradicate LSC in immunodeficient mouse models. With the aim of targeting LSC, we constructed a second-generation chimeric antigen receptor (CAR) specific for CD44 variant 6 (CD44v6-CAR.28z). Retroviral-mediated gene transfer after stimulation with cell-sized beads coupled to anti-CD3 and anti-CD28 antibodies allowed robust transgene expression. Culture with IL-7 and IL-15 efficiently expanded CD44v6-CAR28z+ T cells, while preserving a central memory T-cell phenotype. In co-culture experiments, CD44v6-CAR28z+ T cells specifically cleared AML cell lines expressing CD44v6. CD44v6-CAR28z+ T cells were also effective against a panel of primary AML cells isolated from patients and expressing CD44v6, but not against healthy CD34+ stem cells. Moreover, CD44v6 expression on primary AML and recognition by CD44v6-CAR28z+ T cells was enhanced upon culture on bone marrow-derived stromal cells. Interestingly, similar results were observed on multiple myeloma (MM) cell lines and primary MM cells, suggesting a common cancer stem cell/niche-specific signature. When stimulated with CD44v6+ autologous monocytes, CD44v6-CAR28z+ T cells expanded significantly, but also displayed background cytotoxicity. To increase the safety of our strategy, we implemented the thymidine kinase (tk) suicide gene. Co-transfer of tk enabled the elimination of CD44v6-CAR28z+ T cells upon administration of the prodrug ganciclovir, providing a safety switch in case of unexpected toxicity. These results warrant the clinical implementation of CD44v6-redirection suicide gene-modified T cells for the safe and effective eradication of LSC.

786. Generation of Antigen Specific T Cells by Transplant of Human Hematopoietic Stem/Progenitor Cells (HSPC) Transduced with a Lentiviral Vector Carrying the Genes for a T Cell Receptor Specific for MART-1

Francesca Giannoni,¹ Cinnamon L. Hardee,¹ Jennifer P. Wherley,¹ Don B. Kohn.¹

¹MIMG, UCLA, Los Angeles, CA.

Transduction of human hematopoietic stem/progenitor cells (HSPC) with the genes for a human T cell receptor (TCR) that recognizes a tumor-associated peptide may lead to long-term in vivo production of T cells expressing the TCR and confer specific anti-tumor activity. We evaluated this hypothesis using a lentiviral vector (CCL-cppt-MNDU3-F5-WPRE) into which we cloned the genes of a human TCR specific for an HLA-A*0201-restricted peptide of Melanoma Antigen Recognized by T Cells (MART-1), called F5 MART TCR, and provided by S. Rosenberg, NCI. To evaluate the capacity of transduced CD34+ HSPC to produce F5 TCR-expressing T cells, we used NOD/SCID/IL2R γ ^{-/-} (NSG) immune-deficient mice as xenograft recipients. To test the hypothesis that expression of HLA-A*0201 would facilitate the intra-thymic positive selection of HSPC-derived thymocytes expressing the F5 TCR, we developed a strain of NSG mice transgenic and homozygous for HLA-A*0201 (NSG-A2.1). Expression of HLA-A*0201 may also play a role in thymic selection when expressed on thymic dendritic cells derived from transplanted HSPC. Hence, we generated four combinations of HSPC-transplanted mice, using either HLA-A*0201 + or - HSPC and either NSG control or NSG-A2.1 mice, to test their roles in thymopoiesis. CD34+ HSPC were transduced with the F5 TCR lentiviral vector (VCN 0.5-2.0) or mock-transduced and injected into neonatal NSG (A2.1 + or -) mice that were euthanized when 4 months old. Engraftment of human leukocytes, T cells subtypes and their levels of F5 TCR expression were evaluated in peripheral blood, spleen, bone marrow, thymus. In most of the mice analyzed, we were able to achieve 40-80% engraftment of human leukocytes in all four compartments, and engrafted thymi contained almost 100% human cells. In peripheral compartments up to 60% of T cells from mice transplanted with F5-transduced CD34+ cells ("F5 mice") were expressing F5 TCR. The F5 mice expressed the F5 TCR in 30-90% of the CD8 CD4 double positive (DP) or CD8 single positive (SP) thymocytes. Interestingly, in some F5 NSG-A2.1 mice, most of the thymocytes were CD8 SP; in contrast, in the NSG-A2.1 mice transplanted with mock CD34+ cells or in NSG mice transplanted with F5- CD34+ cells, most of the thymocytes were DP. These observations suggest that HLA-A*0201 expression on the murine thymus promotes or accelerates positive selection of SP F5 TCR CD8 T cells precursors. To determine the ex-vivo response of F5 TCR T cells to antigen specific stimulation, thymocytes from F5- and mock mice were co-cultured with an APC cells line (T1 lymphoblastoid cells) presenting the MART-1 peptide on HLA-A*0201, and IFN gamma and Granzyme B production were determined by ELISA. We found that IFN gamma production by F5 TCR thymocytes in response to MART-1 peptide was higher than by mock-transduced thymocytes. In summary, we were able to generate an experimental preclinical model using CD34+ HSPC expressing the F5 TCR as a long-term source of mature T cells for immunotherapy of melanoma. We will next characterize the in-vivo anti-tumor activity of human T cells, by injecting the NSG mice with human melanoma cell lines.

787. Anti-Glioma Immune Response Induced by Conditional Cytotoxic/Immune-Stimulatory Gene Therapy Requires pDC Activation Triggered by Circulating Brain Tumor DNA

Marianela Candolfi,¹ Kader Yagiz,¹ Karthika Balasubramanian,¹ Mariana Puntel,¹ Gwendalyn D. King,¹ Yohei Mineharu,¹ A. K. M. G. Muhammad,¹ David Foulad,¹ Nicholas Barnett,¹ Kurt M. Kroeger,¹ Pedro R. Lowenstein,¹ Maria G. Castro.¹

¹Gene Therapy Research Institute, Cedars Sinai Medical Center, Los Angeles, CA.

Complexes of DNA and proinflammatory proteins are found in serum during autoimmune responses and activate antigen presenting cells, contributing to autoimmune pathogenesis. Although circulating DNA has been extensively evaluated as a biomarker for cancer progression, its role in the onset of anti-tumor immunity remains elusive. Here we aimed to evaluate the role of circulating DNA in the induction of anti-tumor immunity induced by the combination of immune-stimulant Flt3L and conditionally cytotoxic thymidine kinase (TK), which leads to long-term survival when delivered into intracranial brain tumor models using adenoviral vectors (Ad). Treatment of CNS-1 glioblastoma cells with Ad.TK+GCV led to substantial release of DNA in vitro. Similar results were observed in vivo; intratumoral treatment of established intracranial CNS-1 glioblastomas in rats with Ad-TK/GCV+Ad-Flt3L led to increased levels of circulating DNA in serum when compared to saline-treated tumor-bearing rats. Since our previous results suggest that tumor immunity was dependent on the function of activated pDCs, we aimed to evaluate the hypothesis that circulating tumor DNA induces pDC activation. Using specific inhibitors, such as DNase, micrococcal DNase, CpG2088 (an inhibitor of TLR9) and cloroquine (an inhibitor of endocytosis, required for intracellular TLR9 activation), we found that circulating DNA from treated rats induced TLR9-dependent activation of pDCs. Taken together, our results suggest that after treatment of brain tumors with Ad.TK+Ad.Flt3L dying tumor cells release DNA to the general circulation, which mediate antitumor immunity by acting as danger-associated molecular patterns, leading to TLR9 signaling and pDC activation. Supported by NIH/NINDS grants.

788. Myeloid Derived Suppressor Cells Expand and Infiltrate Brain Tumors in Response to Circulating Glioma-Derived Factors

Marianela Candolfi,¹ Kader Yagiz,¹ Hikmat Assi,¹ A. K. M. G. Muhammad,¹ Chunyan Liu,¹ David Foulad,¹ Gabrielle Alzadeh,¹ Daniel A. Piseri,¹ Kurt M. Kroeger,¹ Pedro R. Lowenstein,¹ Maria G. Castro.¹

¹Gene Therapy Research Institute, Cedars Sinai Medical Center, Los Angeles, CA.

Glioblastoma multiforme (GBM) is the most common and aggressive primary brain cancer in adults. In spite of improved standard of care (surgery, chemotherapy and radiation) the median survival of GBM patients remains dismal. GBM's therapeutic challenges include its invasiveness, resistance to therapies, and immune suppression. We and others have shown that immune suppressive cells infiltrate the GBM microenvironment, i.e., regulatory T cells and myeloid derived suppressor cells (MDSC). Expansion of MDSCs can be triggered by factors produced by the tumor cells, which interfere with myelopoiesis and inhibit the maturation of myeloid precursor cells. We aimed to study whether intracranial GBMs release factors to the general circulation that induce expansion of MDSCs and their recruitment into the tumor mass. We first explored the ability of GBM cells to release soluble factors that induce MDSC expansion in vitro. When compared to control 3T3 mouse fibroblasts, conditioned media (CM) from GL26 and M7 brain tumor cells expressed high levels of ligands

for the receptor for advanced glycation end products (RAGE), i.e., HMGB1, S100A8 and S100A9, which have been shown to play a critical role in the expansion of MDSCs in several cancer models. Tallying with these findings, CM from GL26 and M7 glioma cells induced an increase in the number of MDSC (Gr-1+/Cd11b+) and an inhibition of dendritic cell maturation in bone marrow cultures in vitro. We then implanted intracranial GL26 tumors in syngeneic C57/Bl6 mice and evaluated the infiltration of MDSCs into the brain tumor mass and their expansion in peripheral lymphoid organs during tumor progression, as well as the capacity of GBM cells to release immunosuppressive factors in vivo. An increase in circulating RAGE ligands that correlated with tumor progression was observed in the serum of tumor-bearing mice. Expansion of MDSCs was detected in cervical lymph nodes, spleen and blood 2 weeks after tumor implantation. The presence of Gr-1+/Cd11b+ MDSCs was detected within the tumor by flow cytometry at 21 and 35 (moribund) days after implantation. These cells accounted for as much as 30% of total tumor infiltrating immune cells (CD45+). By Confocal microscopy, we found Gr-1+/CD11b+ MDSCs at the tumor border and within the brain tumor mass, as well as GBM cells expressing S1008 and S100A9 and exhibiting cytoplasmic HMGB1. Multiparameter immunophenotypic analysis of bone marrow showed an increase in hematopoietic stem cells and a reduction in common myeloid progenitors, indicating an inhibition of myeloid cells' differentiation. Our results suggest that GBM-derived factors stimulate peripheral expansion of MDSCs and their recruitment into the tumor mass, eliciting immune-suppression and GBM progression. Thus, manipulation of MDSCs emerges as an attractive therapeutic target for brain cancer. Supported by grants from NIH/NINDS.

789. Enhancing CD8 T Cell Function by IL-2 Potentiates the Efficacy of a Combined Cytotoxic Immunostimulatory Gene Therapy in an Aggressive Glioma Model

Yohei Mineharu,^{1,2} A. K. M. Ghulam Muhammad,^{1,2} Mariana Puntel,^{1,2} Mariana Candolfi,^{1,2} Weidong Xiong,^{1,2} Kurt M. Kroeger,^{1,2} Chunyan Liu,^{1,2} Niyati Bondale,^{1,2} Pedro R. Lowenstein,^{1,2} Maria G. Castro.^{1,2}

¹Board of Governors Gene Therapeutics Research Institute, Cedars Sinai Medical Center, Los Angeles, CA; ²Departments of Medicine, and Molecular and Medical Pharmacology, David Geffen School of Medicine, University of California Los Angeles, Los Angeles, CA.

Glioblastoma multiforme (GBM) is the most lethal type of brain tumor. We tested and optimized a combined cytotoxic/immunostimulatory gene therapy using adenoviral vectors expressing HSV1-TK (Ad-TK) and Flt3 ligand (Ad-Flt3L) in an aggressive rat glioma model (RG2), which is refractory to all therapeutic modalities tested so far. Although Ad-TK combined with Ad-Flt3L lead to long term survival in other rat glioma models (CNS1, 9L, F98) as shown in our previous studies, this treatment only prolonged the median survival of RG2 bearing rats from 18 days to 33 days. To improve the treatment efficacy, we modified the regimen by delivering: (1) SR39, an HSV1-TK mutant which demonstrates superior tumor ablation, (2) Flt3L-IgG2a fusion protein, which shows higher affinity to Flt3 and longer serum half-life, (3) combination treatment with Ad-CCL3 or Ad-CXCL10, Ad-CD40L or Ad-CCL2 to stimulate dendritic cells, (4) combination treatment with Ad-IL-2 or Ad-IFN gamma (Th1 cytokines) to enhance the function of T cells and NK cells. Our data showed that the combination Ad-TK/Ad-Flt3L with Ad-IL-2 or Ad-IFN gamma further enhanced treatment efficacy extending median survival from 18 to 51 or 42 days, respectively. Taken together our results indicate that enhancing T cells' function will provide a novel

therapeutic target to be used in combination with Ad-TK/Ad-Flt3L to improve therapeutic efficacy and increase median survival in this challenging intracranial syngeneic GBM model.

790. Tumor-Specific Viral Inflammation Facilitates Effective Dendritic Cell Cancer Immunotherapy in a Regulatory T Cell-Dependent Manner

Norman Woller,¹ Sarah Knocke,¹ Bettina Mundt,¹ Engin Guerlevik,¹ Nina Struever,¹ Michael P. Manns,¹ Tim Sparwasser,² Stefan Kubicka,¹ Florian Kuehnel.¹

¹Clinic for Gastroenterology, Hepatology, and Endocrinology, Hannover Medical School, Hannover, Germany; ²Infection Immunology, Twincore-Centre for Infection Research, Hannover, Germany.

In our study we identified tumor-tissue inflammation, induced by intratumoral infection with a telomerase-dependent, tumor-selectively replicating adenovirus, as an important precondition for effective DC-vaccination against a tumor-associated antigen (TAA). Our investigations were carried out in syngeneic, immunocompetent mouse models with subcutaneously engrafted CMT64 or KLN205 tumors expressing ovalbumin or hemagglutinin as model TAA. Administration of TAA-pulsed DCs in the context of a coinciding tumor specific viral inflammation, further referred to as oncolysis-assisted DC-vaccination (ODC), was capable of eliciting a strong antitumoral CD8+T cell response. ODC-mediated cytotoxic T cell response was accompanied by reduced virus-specific immunoglobulins and a shift towards Th2-immunoglobulin isotype IgG1, indicating an obvious interference of antitumoral and antiviral immune responses. As an essential prerequisite for treating metastatic cancers, the antitumoral immune response elicited by ODC facilitated significant tumor-regression and successful eradication of pre-established, uninfected tumor colonies in the lungs of treated mice. To further enhance antitumoral immunity by ODC we depleted regulatory T-cells (Tregs) via CD25 depleting antibodies and in transgenic DREG mouse models by application of diphtheriatoxin to delete Foxp3 positive cells. Unexpectedly, regulatory T cell depletion during ODC-treatment did not further enhance therapeutic efficacy, but instead abrogated antitumoral cytotoxicity and rescued antiviral immunoglobulins in both models. This phenomenon could be attributed to a compensatory induction of myeloid suppressor cells by the altered cytokine pattern in the vigorously inflamed tumors which counterbalanced the effect of ODC. Consequently, Tregs are not only general suppressors, but are essential for the therapeutic success of multimodal and temporally fine-adjusted vaccination strategies.

791. Anti-Tumor Activity of Engineered T Lymphocytes Expressing an Anti-CD19 CAR for B Cell Lymphoma

Tomonori Tsukahara,¹ Ken Ohmine,² Ryosuke Uchibori,¹ Masashi Urabe,¹ Hiroaki Mizukami,¹ Akihiro Kume,¹ Isabelle Riviere,³ Michel Sadelain,³ Renier Brentjens,³ Keiya Ozawa.¹

¹Division of Genetic Therapeutics, Center for Molecular Medicine, Jichi Medical University, Shimotsuke-City, Tochigi, Japan;

²Division of Hematology, Department of Medicine, Jichi Medical University, Shimotsuke-City, Tochigi, Japan; ³Department of Medicine, Memorial Sloan Kettering Cancer Center, New York, NY.

For the treatment of refractory B-cell non-Hodgkin lymphoma, we conducted experiments to develop an adoptive immunotherapy using genetically engineered autologous T lymphocytes that express a CD19-antibody fragment fused to the TCR ζ /CD28 receptor (19-28z). Here we examined whether 19-28z-transduced T lymphocytes could eradicate CD19+tumors in vitro. Human peripheral blood T lymphocytes from healthy volunteers were activated by

immobilized anti-CD3 antibody/Retronectin, and transduced with retrovirus vectors encoding 19-28z prepared from producer cells, established by stable transduction of the 19-28z plasmid into the PG13 packaging cells. Transduced T lymphocytes were expanded *ex vivo* in the presence of NIH3T3 fibroblasts expressing human CD19. Following CD19 antigen stimulation, 19-28z-transduced cell numbers increased about 1000-fold, and the surface expression of 19-28z positive CD3+ T lymphocytes (CD8+ population was over 60%) was approximately 95%, as assessed by flow cytometry. These T lymphocytes also produced IL-2 and IFN γ in response to antigen stimulation. Expanded 19-28z+T lymphocytes specifically lysed CD19+ tumor cell lines (Raji and Daudi burkitt lymphoma cell lines) but not CD19- K562 leukemia cell line in luciferase-based cytotoxicity assays. These results indicate that functional 19-28z+T lymphocytes would be effective for the treatment of refractory B-cell non-Hodgkin lymphoma.

792. Inhibition of Experimental Colon Cancer Liver Metastasis by IL-15 Immunogene Therapy

Xianghui He,¹ Dongbing Zhou,¹ Yifeng Wang,¹ Weidong Li,¹ Liwei Zhu.¹

¹Department of General Surgery, Tianjin General Surgery Institute, Tianjin Medical University General Hospital, Tianjin, China.

Liver is the most common site for colon cancer metastasis. Effective liver gene transfer has been achieved by hydrodynamic plasmid injection in mice. In present study, we investigated the therapeutic effect of IL-15 gene transfer on experimental colon cancer liver metastasis in mice model. We previously constructed amplified IL-15 expressing plasmid pHi2-spIL15-CMV-tat (L3) and green fluorescence protein (EGFP) expressing pHi2-EGFP-CMV-tat (L6). The transgene expression was further characterized by transfection of mice colon cancer CT-26 cells *in vitro* and transfection of mice liver *in vivo*. Liver metastasis model were established by splenic inoculation of CT-26 cells. The effect of IL-15 gene transfer on liver metastasis were evaluated by hydrodynamic injection of IL-15 expressing plasmid into tumor-bearing mice. Results showed that IL-15 expression in culture supernatant of L3 transfection CT-26 cells were 69.76 \pm 29.91pg/mL at 24h, 246.69 \pm 55.13 pg/mL at 48h. EGFP expression was observed in liver tissue of L6 injected mice. The liver metastasis of mice injected L3 was less than that of control and increase survival were observed. In conclusions, IL-15 expression plasmids liver gene transfer can inhibit experimental colon cancer liver metastasis in mice, which provides evidence for potential of clinical application of IL-15 gene therapy.

Cancer-Oncolytic Viruses II

793. Antifibrotic Properties of Transarterial VSV Oncolytic Therapy for Hepatocellular Carcinoma in Rats with Thioacetamide-Induced Liver Fibrosis

Jennifer Altomonte,¹ Enrico De Toni,² Irene Esposito,¹ Claus Hellerbrand,³ Sabrina Marozin,¹ Oliver Ebert.¹

¹Klinikum Rechts der Isar, Technical University of Munich, Munich, Germany; ²Klinikum Grosshadern, University of Munich, Munich, Germany; ³University Hospital Regensburg, Regensburg, Germany.

Oncolytic virotherapy is a promising strategy for safe and effective treatment of malignancy. We have previously reported that recombinant vesicular stomatitis virus (VSV) vectors are effective oncolytic agents, which can be administered via the hepatic artery in immune-competent rats to treat multifocal hepatocellular carcinoma (HCC), and result in significant prolongation of survival. However, the majority of clinical cases of HCC arise as a result of liver fibrosis, which poses an even greater challenge for treatment of the cancer as

well as the underlying liver disease. We were therefore prompted to investigate the safety and efficacy profile of VSV when applied in this context. To this end, syngeneic HCC cells were injected into the livers of rats harboring thioacetamide-induced fibrosis. We confirmed that VSV was able to access the tumor via hepatic arterial infusion and replicate to high titers and produce a similar oncolytic response in fibrotic livers as compared to healthy control animals. Furthermore, in addition to the absence of any detectable signs of hepatotoxicity, we obtained evidence that VSV therapy could, in fact, confer an additional benefit in reversing the development of fibrosis through the repression of hepatic stellate cell (HSC) activation. Liver sections from rats treated with VSV were assigned lower Ishak fibrosis staging scores than buffer-treated counterparts, and morphometric analysis revealed a decrease in fibrotic liver content. Immunohistochemical staining of tumor sections revealed a co-localization of VSV with α -smooth muscle actin (α -SMA), a marker for activated HSCs. Quantitative RT-PCR analysis confirmed a reduction in α -SMA, TGF β , tissue inhibitor of metalloproteinase-1 (TIMP-1), and pro-collagen mRNA in liver tissue following VSV therapy. These results were replicated *in vitro* in the human HSC cell line, LX-2, as well as primary HSCs, in which we further demonstrated that VSV replicates in and kills these cells in an HSC activation-dependent manner. Together, this work suggests that VSV virotherapy is not only safe and effective for the treatment of HCC in fibrotic livers, but it could potentially be developed as an anti-fibrotic agent for future clinical application.

794. Enhancing Therapeutic Outcome Using Radiation and Measles Infected CIK Cell Carriers for the Treatment of Disseminated Multiple Myeloma

Yun-Wen Chen,¹ Chunsheng Liu,¹ Stephen J. Russell,¹ Kah-Whye Peng.¹

¹Molecular Medicine, Mayo Clinic, Rochester, MN.

Multiple myeloma (MM) is a disseminated disease consisting of malignant monoclonal plasma cells which reside in the bone marrow. Several studies have illustrated the potential of utilizing measles viruses (MV) for the treatment of MM, but there are significant barriers that prevent the viruses from reaching sites of myeloma tumor growth after intravenous delivery. Cytokine induced killer (CIK) cells are *ex-vivo* expanded cells which bear phenotypic markers of natural killer (NK) and T cells. CIK cells play a crucial role in tumor cell killing mainly through the receptor natural killer group 2D (NKG2D)-mediated cytotoxicity. In the present study, we employed CIK cells as carriers to deliver oncolytic measles virus to tumor sites. *In vitro* studies showed that CIK cells were efficiently infected by MV-GFP and remained viable for at least 3 days post-infection. When compared with CIK cells alone, MV-infected CIK cells were highly effective at killing human myeloma cells. In addition, CIK can protect MV-GFP from neutralization by antimeasles antibodies; 50% syncytia formation was evident when "naked" MV-GFP virus was mixed with a 1:640 dilution of measles immune human sera. In contrast, at a 1:40 dilution of measles immune human sera, 50% syncytia formation was evident when CIK infected with MV were overlaid into Vero cells. The therapeutic potential of CIK/MV cell carriers was determined *in vivo* using subcutaneous and disseminated MM xenografts. Long-term survival curves of mice in the various treatment groups [saline, irradiation (RT), CIK, CIK infected with MV (CIK-MV), RT/CIK-MV, MV (+Ab), CIK-MV (+Ab)] were plotted in a Kaplan-Meier curve. Our results showed that CIK can significantly extend the survival of passively immunized mice-bearing disseminated human myeloma disease and protects MV from neutralizing antimeasles antibodies. In addition, combinations of MV-infected CIK cells with

irradiation prolonged the survival of mice. However, the mechanisms involving in the effect of irradiation on enhanced therapeutic outcome are still unclear and are under investigation.

795. Treatment of Cancer with Oncolytic Adenovirus Combined with Temozolomide, an Autophagy Inducer

Ilkka Liikanen,¹ Laura Ahtiainen,¹ Vincenzo Cerullo,¹ Petri Nokisalmi,¹ Sophie Escutenaire,¹ Iulia Diaconu,¹ Sari Pesonen,¹ Anniina Koski,¹ Lotta Kangasniemi,² Elina Haavisto,² Kaarina Partanen,³ Timo Joensuu,³ Anna Kanerva,¹ Akseli Hemminki.¹
¹Cancer Gene Therapy Group, Molecular Cancer Biology Program, Transplantation Laboratory, Haartman Institute and Finnish Institute for Molecular Medicine, University of Helsinki, Helsinki, Finland; ²Oncos Therapeutics, Inc., Helsinki, Finland; ³International Comprehensive Cancer Center Docrates, Docrates Clinic, Helsinki, Finland.

Purpose: Oncolytic viruses can induce autophagic cancer cell death and preclinical data suggests that autophagy modulating drugs can enhance their efficacy. This, however, has not been previously studied in humans. **Experimental design:** We assessed the combinations of oncolytic adenovirus, autophagy inducing temozolomide and immunomodulatory cyclophosphamide in a prostate tumor model in mice. 17 patients with solid tumors refractory to conventional treatment modalities were treated in a personalized advanced therapy access program with oncolytic adenovirus together with a low-dose pulse of temozolomide (100mg/d). Concurrent low-dose metronomic cyclophosphamide was administered to reduce regulatory T-cells. The primary end-point was safety. In addition, immunological, virological and efficacy parameters were studied. **Results:** In mice, the best tumor growth inhibition was observed with combination of oncolytic adenovirus, temozolomide and cyclophosphamide. Electron microscopy revealed increased autophagy in combination treated tumors compared to controls. Combination treatments in humans were safe with grade 1–2 flu-like symptoms, fever, and fatigue and nausea in most patients. Non-hematological grade 3–5 side effects were seen in one patient with grade 3 ileus and one patient with grade 3 abdominal pain. Overall, objective evidence of anti-tumor activity was seen in 12/17 evaluable treatments. **Conclusions:** Low-dose pulse temozolomide and low-dose cyclophosphamide in combination with oncolytic adenovirus showed increased efficacy in mice and were well tolerated in humans. Further studies are needed to assess if temozolomide increases the efficacy of oncolytic virotherapy in humans.

796. Oncolytic Virus Therapy for Bladder Cancer Using a Third-Generation HSV-1 Armed with Interleukin 12

Jiangang Hou,¹ Hiroshi Fukuhara,¹ Yuzuri Tsurumaki,¹ Yukio Homma,¹ Yasushi Ino,^{2,3} Tomoki Todo.^{2,3}
¹Urology, The University of Tokyo, Tokyo, Japan; ²Neurosurgery, The University of Tokyo, Tokyo, Japan; ³Translational Research Center, The University of Tokyo Hospital, Tokyo, Japan.

Oncolytic herpes simplex viruses type 1 (HSV-1) that replicate selectively in cancer cells are promising therapeutic agents for cancer. G47Δ is a third-generation oncolytic HSV-1 that has triple mutations in the γ 34.5, α 47 and ICP6 genes, and the first recombinant oncolytic virus to be used in a clinical trial in Japan. Using the G47Δ backbone, we newly constructed T-mfIL12, an HSV-1 armed with fusion-type murine interleukin 12 (IL-12). We have previously shown that, when inoculated intraneoplastically at 1×10^6 pfu, T-mfIL12 was significantly better at inhibiting the growth of subcutaneous MB-49 tumors (murine bladder cancer) in syngeneic C57BL/6 mice compared with T-01, a control virus. From a clinical standpoint, we

further sought various applications of IL-12-expressing oncolytic HSV-1 for treating bladder cancer. A lung metastases model was generated by injecting MB-49 cells intravenously in C57BL/6 mice, and viruses were repeatedly administered into the tail vein. Both T-01 and T-mfIL12 (5×10^6 pfu) significantly prolonged the survival compared with mock, with T-mfIL12 being more efficacious than T-01 (Fig. 1). In an orthotopic bladder cancer model, intravesical inoculations with T-mfIL12 (1×10^6 pfu) prolonged the survival of C57BL/6 mice with MB-49 bladder cancer compared with T-01. Further, using the orthotopic model, cancer-bearing mice were treated with intravesical administration of T-mfIL12 (1×10^6 pfu) or mock in combination with BCG (1.35mg) or PBS. The combination of T-mfIL12 and BCG prolonged the survival of the mice with MB-49 bladder cancer compared with T-mfIL12 alone or BCG alone. When athymic mice bearing subcutaneous human RT-4 bladder cancer were treated with intraneoplastic inoculation of G47Δ (4×10^4 pfu) or mock in combination with intraperitoneal injection of Gefitinib, an epidermal growth factor receptor inhibitor, or PBS, the combination therapy was significantly more efficacious than G47Δ alone or Gefitinib alone (Fig. 2). Results indicate that the G47Δ-derived oncolytic HSV-1's are useful for treating bladder cancer in a variety of ways. The efficacy of G47Δ may be greatly enhanced by arming the virus with IL-12.

Combination of G47Δ and Gefitinib is efficacious against RT-4 xenografts

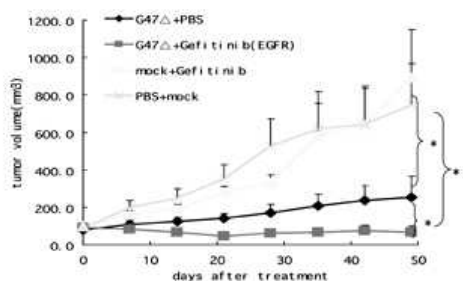

T-mfIL12 prolonged the survival of mice with bladder cancer lung metastases

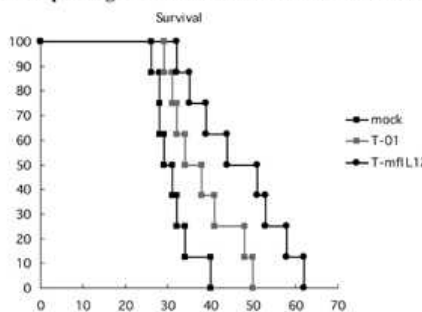

797. Oncolytic Adenovirus Induces Autophagic Cell Death through an E2F1-microRNA-7-Epidermal Growth Factor Receptor Axis in Human Cancer Cells

Hiroshi Tazawa,^{1,2} Shuya Yano,² Ryosuke Yoshida,² Yuuri Hashimoto,² Yasuo Urata,³ Toshiyoshi Fujiwara.²
¹Center for Gene and Cell Therapy, Okayama University Hospital, Okayama, Japan; ²Department of Gastroenterological Surgery, Okayama University Graduate School, Okayama, Japan; ³Oncology BioPharma, Inc., Tokyo, Japan.

Background: Oncolytic virotherapy is a promising anticancer treatment to induce oncolytic cell death that is distinct from apoptosis caused by conventional chemoradiotherapy in human cancer cells. Recent accumulating evidences have suggested the implication of autophagy on the oncolytic adenovirus-mediated cell death. However,

molecular mechanism underlying oncolytic adenovirus-mediated autophagic cell death remains unclear. We previously generated a genetically engineered oncolytic adenovirus (Telomelysin®: OBP-301) that replicates and induces autophagic cell death against human cancer cells in a telomerase-dependent manner. As microRNA (miRNA), a post-transcriptional regulator of gene expression, has been recently shown to regulate diverse cell fates including autophagy, we hypothesized that OBP-301 infection induces autophagic cell death through miRNA modulation in human cancer cells. In this study, we attempted the role of miRNA on the OBP-301-mediated autophagic cell death in human cancer cells. **Methods:** We used 3 human cancer cell lines (H1299, A549 and T.Tn), that showed different sensitivities to OBP-301. *In vitro* cytopathic effect of OBP-301 in each cell line was confirmed by XTT assay. Induction of autophagy was analyzed by western blot for autophagy-related proteins (LC3, Atg5 and p62). To investigate whether OBP-301 infection modulates miRNA expression, the expression levels of 757 human miRNAs were analyzed in OBP-301-infected H1299 cells using miRCURY miRNA microarray (EXIQON). Modulation of miRNA expression was further validated by quantitative real-time RT-PCR (qRT-PCR). Induction of autophagy by miRNA was determined using artificial miRNA-transfected cells by flowcytometric and western blot analysis. Expression of miRNA's target gene was confirmed by western blot analysis. **Results:** XTT assay revealed that H1299 and A549 cells were sensitive, whereas T.Tn cells were resistant to cytopathic effect of OBP-301. In OBP-301-sensitive H1299 and A549 cells, autophagy, which includes the conversion of LC3-I to LC3-II, upregulation of Atg5 and downregulation of p62, was induced by OBP-301 infection. However, no autophagy was induced in OBP-301-resistant T.Tn cells. miRNA microarray and qRT-PCR revealed that OBP-301 infection upregulated *miR-7* expression, which was significantly correlated with OBP-301-mediated cytopathic activity and autophagy induction. We also revealed that OBP-301-mediated *miR-7* upregulation depended on enhanced E2F1 expression. Furthermore, ectopic expression of *miR-7* in human cancer cells suppressed cell viability and subsequently induced autophagy. Flowcytometric and western blot analysis revealed that downregulation of epidermal growth factor receptor (EGFR) was involved in the induction of autophagy by *miR-7*. **Conclusions:** Our results suggest that oncolytic adenovirus OBP-301 induces autophagic cell death through an E2F1-*miR-7*-EGFR pathway in human cancer cells, providing a novel insight into the molecular mechanism of an oncolytic virotherapy.

798. EGFR-Targeted and Cytosine Deaminase-Armed Measles Virus in Combination with 5-Fluorocytosine as a Novel Chemovirotherapy for Head and Neck Squamous Cell Carcinoma

Karim Zaoui,^{1,2} Sascha Bossow,¹ Christian Großardt,¹ Mathias F. Leber,¹ Christoph Springfeld,³ Christof von Kalle,¹ Peter K. Plinkert,² Guy Ungerechts.¹

¹Department of Translational Oncology, National Center for Tumor Diseases, German Cancer Research Center, Heidelberg, Germany; ²Department of Otorhinolaryngology and Head and Neck Surgery, University Hospital Heidelberg, Heidelberg, Germany; ³Department of Internal Medicine IV, University Hospital Heidelberg, Heidelberg, Germany.

For locally advanced or metastatic head and neck squamous cell carcinoma (HNSCC) no curative therapy is currently available. Therefore, novel treatment methods are urgently needed. Measles viruses (MV) derived from vaccine strain have shown considerable oncolytic activity against lymphomas and a wide variety of solid adenocarcinomas from different entities. In this study, we investigated for the first time the susceptibility of HNSCC cell lines to MV infection using MV expressing enhanced green fluorescent protein (MV-EGFP). Next, we generated targeted and armed MV encoding the

prodrug convertase cytosine deaminase (CD) which converts the non-toxic prodrug 5-fluorocytosine (5-FC) to the potent chemotherapeutic 5-fluorouracil (5-FU). Since EGFR is frequently overexpressed in HNSCC, we fused a single-chain antibody (scFv) specific for the extracellular domain of EGFR as a C-terminal extension to the MV attachment protein H which was blinded for the natural MV receptors CD46/SLAM. Specificity of infection by the EGFR-retargeted MV was compared to the parental MV-EGFP with unmodified tropism and to a control virus which binds to CD20, a B cell specific antigen. It was demonstrated *in vitro* that EGFR-retargeted MV can infect HNSCC specifically and kill target cells very efficiently. Combined treatment of MV-CD-antiEGFR infected cells with 5-FC substantially enhanced the cytoreductive impact on infected and bystander cells. In a subcutaneous tumor xenograft model of HNSCC intratumoral administration of MV-EGFP-antiEGFR resulted in a statistically significant tumor growth delay and prolongation of survival in contrast to mock treated animals. Importantly, combined chemovirotherapy using MV-CD-antiEGFR together with subsequent prodrug administration yielded significantly consolidated tumor regression as well as extended survival compared to mice treated with virus only. This EGFR-retargeted and armed virus may be a promising tool for chemovirotherapy of advanced HNSCC.

799. Generation of Fiber-Modified, Conditionally-Replicating Adenovirus Vectors Expressing the Sodium Iodide Symporter for Prostate Cancer Therapy

Michael J. Oneal,¹ Miguel A. Trujillo,² Julia Davydova,³ Masato Yamamoto,³ John C. Morris.²

¹Department of Molecular Medicine, Mayo Clinic, Rochester, MN; ²Department of Endocrinology, Mayo Clinic, Rochester, MN; ³Department of Surgery, University of Minnesota, Minneapolis, MN.

As the second leading cause of cancer death in men, and as a cancer for which few curative treatments exist, there is an urgent need for novel therapies for prostate cancer. Replicating oncolytic viruses expressing the sodium iodide symporter (hNIS) can readily transduce target cells and effect functional NIS expression and uptake of radioactive iodine. This vector would extend radioiodine therapy, a well-established thyroid cancer treatment, to other cancers. Previous work in our lab has elucidated the potential of radiovirotherapy using a conditionally replicating vector, Ad5PB-RSV-NIS, where E1a expression is regulated by the prostate-specific probasin promoter. Transduction of tumors with Ad5PB-RSV-NIS followed by administration of radioactive iodide showed significant improvement over vector alone. This approach utilizes the bystander effects of replication and radiation to compensate for low *in vivo* transduction efficiency, a problem frequently observed in virotherapy trials. We have modified the adenovirus vector structure to further improve efficacy. Specifically, we modified our vectors with a hybrid fiber protein containing the knob domain of Ad serotype 3, which binds to CD46 rather than the less-available CAR. Also, the Adenovirus death protein (ADP), an E3 splice product absent in our previous vector, hastens the release of viral particles after assembly. Increasing the speed of viral spread by the introduction of cytolytic proteins or transductional modification may increase the number of infected tumor cells able to take up radioiodide, and the dose of radiation absorbed by the tumor as a consequence. To determine the effect of these changes on efficacy, we generated two vectors, Ad5/3PB-ADP-hNIS, and Ad5/3PB-hNIS, and assessed their ability to improve outcome. Infection and NIS-expression *in vitro* was characterized by MTS assay, staining of infected cells with crystal violet, and radioisotope uptake assays. These assays demonstrated that ADP-expressing vector lysed cells tenfold more quickly than their ADP-lacking counterpart, but induced about a third of the

radioiodide uptake. We also confirmed iodide uptake *in vivo* by imaging LNCaP-xenografted mice infected with each construct by SPECT-CT. These results will better inform the outcome of efficacy studies with these vectors.

800. Biological Effects of Oncolytic Adenovirus on Epithelial-Mesenchymal Transition in Human Lung Cancer Cells

Yuuri Hashimoto,¹ Shuya Yano,¹ Hiroshi Tazawa,^{1,2} Ryosuke Yoshida,¹ Yasuo Urata,³ Shunsuke Kagawa,¹ Toshiyoshi Fujiwara.¹
¹Department of Gastroenterological Surgery, Okayama University Graduate School of Medicine, Dentistry and Pharmaceutical Sciences, Okayama, Japan; ²Center for Gene and Cell Therapy, Okayama University Hospital, Okayama, Japan; ³Oncolys BioPharma, Inc., Tokyo, Japan.

Background: Epithelial-mesenchymal transition (EMT) is a biologic process by which epithelial cells lose their epithelial characteristics, acquire mesenchymal properties and become motile. In cancer, EMT promotes the malignant phenotype of carcinoma cells, including metastatic ability and drug resistance. Hence, to fight cancer progression, the agent to inhibit and/or reverse the EMT is required. Although a number of oncolytic adenoviruses were developed, little is known about the relationship between adenovirus and EMT program. In this study, we examined the effects of telomerase-dependent oncolytic adenovirus on EMT in human cancer cells. **Methods:** We previously developed telomerase-specific replication-selective oncolytic adenovirus (OBP-301: Telomelysin), in which the telomerase promoter regulates viral replication. Transforming growth factor- β (TGF- β) was used to induce EMT in human lung cancer A549 cells. *In vitro* antitumor effect of OBP-301 and chemotherapeutic agents in TGF- β -treated cancer cells were assessed by trypan blue exclusion assay. To investigate whether OBP-301 infection affects TGF- β -induced EMT, western blot analysis for EMT-related proteins was performed. We also examined cell mobility by transwell migration and invasion assays. **Results:** A549 cells acquired a mesenchymal character, which is spindle-like cell morphology, down-regulation of E-cadherin, up-regulation of vimentin and high motility, by TGF- β treatment. OBP-301 efficiently killed A549 cells that had undergone EMT, whereas cisplatin and docetaxel were less effective. Western blot analysis for EMT markers revealed that OBP-301 infection increased E-cadherin expression and reduced expression of vimentin and N-cadherin in TGF- β treated A549 cells. Moreover, OBP-301 inhibited TGF- β -induced cell migration and invasion. We further investigated expression of EMT-inducible transcription factors, Snail, Slug, ZEB1 and Twist, in cancer cells infected with OBP-301 following TGF- β treatment. The expression level of Snail in OBP-301-infected cells was markedly lower than in TGF- β -treated cells. **Conclusion:** Our data suggest that telomerase-specific oncolytic adenovirus OBP-301 may inhibit TGF- β -mediated EMT and cell migration by suppressing Snail expression, therefore, OBP-301 may have therapeutic potential against human cancer cells that have undergone EMT.

801. Targeting of Prostate Cancer Cells with the Novel Replication-Selective Adenoviral Mutant Ad $\Delta\Delta$ in Combination with the Phytochemical Drugs Equol and Resveratrol

Virginie S. Adam,¹ Daniel Oberg,¹ Nicholas Lemoine,¹ Gunnell Halldén.¹

¹Centre for Molecular Oncology and Imaging, Barts Cancer Institute, QMUL, London, United Kingdom.

Safety and selectivity of several oncolytic adenoviral mutants have been demonstrated in numerous clinical trials however, significant efficacy was only observed in combination with chemotherapeutics

or radiation therapy. Although lower doses of cytotoxic drugs might be administered in combination with oncolytic mutants unwanted toxic side-effects still occur. In this study, we demonstrate that two phytochemicals with low cytotoxicity, equol and resveratrol, can synergistically enhance cell death in combination with adenovirus to kill prostate cancer cells in culture and inhibit growth of prostate tumour xenografts *in vivo*. We recently generated a novel improved oncolytic adenovirus Ad $\Delta\Delta$ with deletions in both the E1ACR2-region (pRb-binding) and the anti-apoptotic E1B19K gene for selective replication in prostate cancer cells and limited spread in normal tissue. In addition, Ad $\Delta\Delta$ cell killing is synergistically enhanced with several chemotherapeutics such as docetaxel and mitoxantrone used for the treatment of prostate cancer. In this study we demonstrate that synergistic cell killing also resulted from treatments with equol (10-100 M) or resveratrol (5-15 M) in combination with Ad $\Delta\Delta$ in both the androgen receptor (AR)-positive 22Rv1 and AR-negative PC3 cell lines. The greatest effects, determined by calculation of combination indexes (CI), was in combination with equol and to a lesser degree with resveratrol in the highly treatment-resistant PC3 cells; CI=0.09. Both equol and resveratrol enhanced viral infectivity in the PC3 cells by up to 14% through an increased expression of cellular receptors involved in viral uptake such as CAR, $\alpha v\beta 3$ and $\alpha v\beta 5$ integrins. Cell death caused by equol and resveratrol showed apoptotic features such as decreased $\Delta\phi m$ and increased caspase-3 activation. However, when the phytochemicals were combined with Ad $\Delta\Delta$ the pan-caspase inhibitor zVAD-fmk could only partly inhibit the synergistic effects while the autophagy inducer rapamycin decreased the synergistic cell death. Results from ongoing studies to elucidate the role of apoptosis and autophagy in the synergistic effects will be reported. We anticipate that these findings will lead to the development of Ad $\Delta\Delta$ in combination with equol or resveratrol into a novel therapeutic regime for prostate cancer.

802. Systemically Administered Vesicular Stomatitis Virus Induces Neurotoxicity in Myeloma-Bearing Mice

Danielle N. Yarde,¹ Rebecca A. Nace,¹ Shruthi K. Naik,¹ Mark J. Federspiel,¹ Stephen J. Russell.¹

¹Department of Molecular Medicine, Mayo Clinic College of Medicine, Rochester, MN.

Multiple myeloma is an incurable hematologic malignancy of mature B cells. Patients with myeloma have large numbers of clonal, antibody-secreting plasma cells in their bone marrow. Unfortunately, although patients initially respond to chemotherapy, they eventually relapse and succumb to this disease. Therefore, novel therapies are necessary for the successful treatment of this disease. To this end, our laboratory has focused extensively on radiovirotherapy, which utilizes oncolytic viruses in combination with radiotherapy to specifically target tumor cells. One oncolytic virus currently being studied for the treatment of myeloma is vesicular stomatitis virus (VSV). In pre-clinical studies, VSV has been shown to very efficiently eradicate tumor cells. However, its safety profile must be improved before it can be used in the clinic. This virus can be neurotropic and has been shown to cause encephalitis in mice. Mice without tumors as well as mice with low tumor burden are able to tolerate high doses of VSV. However, we have seen that C57Bl/KaLwRij mice with advanced systemic myeloma die or must be sacrificed typically within five days following systemic VSV administration. These mice rapidly lose weight and develop hind limb paralysis, which we hypothesized was due to VSV-induced neurotoxicity. Using a recombinant VSV containing a firefly luciferase reporter (VSV-Luc), we were able to detect luciferase activity not only in the tumors, but also in the brains of tumor-bearing mice treated systemically with VSV-Luc at 28 days post-5TGM1 myeloma cell injection. To determine if VSV-induced neurotoxicity is indeed causing the decline of these mice, and not

tumor burden, we treated mice with VSV, a therapeutically effective dose of cyclophosphamide (CPA), or the combination of VSV plus CPA. We hypothesized that if death is due to VSV neurotoxicity, then an effective dose of CPA would not be able to rescue VSV-treated mice. The results revealed that mice treated with only CPA had a significant survival advantage over control-treated mice, VSV-treated mice, and, importantly, mice treated with the combination of VSV+CPA. Since CPA was not able to rescue mice treated with VSV, the results suggest that these mice are dying due to the harmful effects of VSV. These neurotropic effects may be model-specific, though, because neoplastic cells were found in the meninges of these mice, but are typically not found in the brains of human myeloma patients. These tumor cells may provide VSV with access to the CNS in this model. The aim of future studies is to insert neuron-specific miRNA targets into VSV, which would inhibit VSV replication in the CNS, as a means to enhance the specificity and improve the safety of this virus.

803. The Effect of Combination Therapy of Oncolytic Virus hrR3 and Bevacizumab in Human Gastric Cancer

Gewen Tan,¹ Hideki Kasuya,¹ Tevfik T. Sahin,¹ Toshio Shikano,¹ Suguru Yamada,¹ Akiyuki Kanzaki,¹ Kazuo Yamamura,¹ Tsutomu Fujii,¹ Hiroyuki Sugimoto,¹ Shuji Nomoto,¹ Yoko Nishikawa,¹ Shin Takeda,¹ Akimasa Nakao.¹

¹*Surgery II, Nagoya University Graduate School of Medicine, Nagoya, Japan.*

Background: Gastric cancer is one of the major causes of cancer death worldwide. The prognosis of locally advanced or metastatic cases still remains poor. Furthermore, 50% of the patients with curative resection will suffer from local recurrence. Multimodality approach with a more specific and effective strategy is urgently needed. Oncolytic herpes viruses are good candidates because of broad host range and also oncolytic viral replication. Bevacizumab is a monoclonal antibody against vascular endothelial growth factor subtype A (VEGFA). It inhibits neovascularization and therefore tumor growth. Combination of these two novel strategies previously has not been evaluated for the treatment of gastric cancer. **Methods:** The VEGFA gene and protein expression was measured in human gastric cancer (AZ521, MKN45), pancreatic cancer (Capan-1 and MIA PaCa-2), hepatic cancer (Hep3B and PLC/PRF/5), colon carcinoma (WiDr) and ovarian carcinoma (SKOV-3) cell lines. The MTT analysis was performed to evaluate efficiency of combination therapy in-vitro. The effect on viral replication was evaluated by PCR and titrating of the virus replicating under various doses of bevacizumab. The in vivo study consisted of 24 BALB/c nude mice which were injected 10^6 cells into the right flank region. Control group received no treatment. hrR3 group received 10^7 pfu virus intratumorally. Bevacizumab group received 5mg/kg bevacizumab intraperitoneally twice a week. Combination group received both intratumoral hrR3 and intraperitoneally bevacizumab at the same dose. Tumor diameters were measured twice weekly. 2 days following the last dose of the treatment tumors from each group were resected and collected. Histopathologically CD31 driven microvascular density was evaluated by immunohistochemistry. Apoptosis was evaluated by apoptag immunoperoxidase staining. Viral replication in tissue was evaluated by β -Galactosidase (LacZ) histochemistry. **Results:** MKN45 and SKOV3 cell line had the highest VEGFA gene and protein expression. In the in vivo study; tumors of the combination group had the smallest volume among other groups ($P < 0.05$). The Microvascular density was highest in the hrR3 group ($P < 0.05$). Combination group had higher angiogenesis when compared to bevacizumab and control groups. LacZ induction was highest in the combination group when compared to hrR3 group ($P < 0.05$). Apoptosis were increased in the combination group ($P < 0.05$). **Conclusion:** Antiangiogenic therapy is

a tumoristatic therapy. Penetration of the oncolytic virus in the tumor is a limiting problem for genetically engineered viruses. However; the results of our study show that bevacizumab increased the replication the virus in the tumor tissue. Apoptosis and potent oncolysis resulted in reduction of the tumor. Oncolytic herpes viruses seem to induce angiogenesis.

804. p53-Dependent Expression of the Meganuclease I-Sce I Allow Self-Restriction of Oncolytic Adenovirus in Normal Tissue

Peter Schache,¹ Engin Guerlevik,¹ Anneliese Goetz,¹ Nina Struever,¹ Michael P. Manns,¹ Stefan Kubicka,¹ Florian Kuehnel.¹
¹*Clinic for Gastroenterology, Hepatology, and Endocrinology, Hannover Medical School, Hannover, Germany.*

Diverse mechanisms have already been established to restrict replication of oncolytic adenoviruses to cancer tissue. However, those approaches usually address the regulation of progeny production but not the integrity of the vector DNA. Therefore, tissue-specific destruction of oncolytic viruses has not yet been addressed. In this study, we present an oncolytic adenovirus for conditional replication in p53-altered tumor cells that harbors a meganuclease function for selective vector cleavage destruction in normal tissue. Conditionally replicating adenoviruses were constructed containing an expression cassette for the meganuclease I-Sce I (EGFP as non-functional control) under transcriptional control of the artificial, p53-dependent promoter prMinRGC. As target for I-Sce I mediated cleavage the E1 gene region was flanked by I-Sce I recognition sites. We could show that I-Sce I adenoviruses expressed I-Sce I in p53-normal cells but not in p53-aberrant cells and intracellular cleavage of adenoviral genomes was confirmed by detection of specific circularized cleavage products by PCR. Oncolysis by I-Sce I expressing adenoviruses was selectively inhibited in p53-normal cells, but not in p53-aberrant cells when compared to EGFP-expressing control viruses thus indicating that I-Sce I-mediated vector destruction successfully interfered with viral replication. In subsequent vector strategies, p53-dependent, I-Sce I-mediated vector cleavage was combined with an additional transcriptional regulation mechanism aiming at reduction of viral genomes prior to effective cleavage. In this case, p53-dependent I-Sce I expression was linked to the expression of the transcriptional repressor Gal4-KRAB via an IRES sequence. To achieve transcriptional repression of E1A, the E1A-controlling promoter was flanked by Gal4-KRAB binding sites. These vectors showed a further increased selectivity of viral replication for p53-aberrant cells compared to I-Sce I-only vectors thus demonstrating the usefulness to combine tumor-specific transcriptional targeting and tumor-specific destruction of the vector. In summary, we established tightly regulated, conditionally replicating adenoviruses that combine transcriptional regulation as well as vector destruction mechanisms for improved safety and efficacy of virotherapeutic treatment of solid tumors.

805. Promoter-Mediated Replication of Adenoviruses Induces Apoptosis-Independent Cell Death in p53-Null Pancreatic Carcinoma Cells

Masatoshi Tagawa,¹ Suguru Yamauchi,¹ Kiyoko Kawamura,¹ Shinya Okamoto,² Shan Yang,¹ Wen Chang Li,¹ Hiroshi Kobayashi,² Shuji Kubo,³ Yuji Tada,⁴ Yuichi Takiguchi,⁴ Koichiro Tatsumi,⁴ Kenzo Hiroshima,⁵ Hideaki Shimada.⁶

¹Division of Pathology and Cell Therapy, Chiba Cancer Center Research Institute, Chiba, Japan; ²Department of Biochemistry, Graduate School of Pharmaceutical Sciences, Chiba University, Chiba, Japan; ³Laboratory of Host Defenses, Institute for Advanced Medical Sciences, Hyogo College of Medicine, Nishinomiya, Japan; ⁴Department of Respiriology, Graduate School of Medicine, Chiba University, Chiba, Japan; ⁵Department of Pathology, Tokyo Women's Medical University Yachiyo Medical Center, Chiba, Japan; ⁶Department of Surgery, School of Medicine, Toho University, Tokyo, Japan.

Pancreatic carcinoma is often resistant to a number of chemotherapeutic agents, which can be partly due to the non-functional p53 pathways. We then examined a possible therapeutic strategy with replication-competent adenoviruses (Ad) that had an exogenous transcriptional unit, which is active in various human tumors, to drive E1 region genes and replaced the fiber-knob region with that of the type 35. Ad receptor expression levels including coxsackie Ad receptors and CD46 molecules were variable among 4 kinds of human pancreatic cell lines and the infectivity of Ad, tested with type 5 Ad bearing the green fluorescence protein gene (Ad-GFP) and type 35 fiber-knob replaced Ad-GFP, did not directly correlate with the receptor expression levels. The cytotoxicity of the type 35 fiber-knob-bearing Ad was however greater than that of type 5 Ad and the cytotoxic activity of Ad activated with midkine promoter, an exogenous transcription unit, was comparable to that of cytomegalovirus promoter-driven Ad. The replication-competent Ad induced cytopathic effects immediately after the infection but the live cell percentages, tested with a dye exclusion method, rather gradually decreased, which was not coordinated with the cytopathic effects. Moreover, cell cycle analyses did not show increased sub-G1 populations. Western blot analysis demonstrated that caspase 3 and PARP were minimally activated although E1 and hexon protein readily increased. Subsequent studies also suggested that autophagy did not play a significant role in the Ad-induced cell death. These data suggest that replication Ad-induced cell death in pancreatic carcinoma cells is independent of conventional apoptotic pathways, which may be linked with the loss of p53 functions.

806. Active Targeting of Bioreducible Polymer Concealing Oncolytic Adenovirus to Cancer Cells Expressing Integrins

Jaesung Kim,¹ Hye Yeong Nam,¹ Tae-Il Kim,¹ Pyung-Hwan Kim,¹ Chae-Ok Yun,² Sung Wan Kim.¹

¹Department of Pharmaceutics and Pharmaceutical Chemistry, University of Utah, Salt Lake City, UT; ²Brain Korea 21 Project for Medical Sciences, Institute for Cancer Research, Yonsei Cancer Center, Severance Biomedical Science Institute, Yonsei University College of Medicine, Seoul, Republic of Korea.

In contrast to the efforts to develop effective and selective oncolytic adenoviruses (Ads), which can conditionally replicate in and ultimately kill cancer cells, the therapeutic application still has been restricted accompanying the issues of non-targeting to tumor and antiviral immune surveillance. To overcome the limits of transductional targeting and immune privilege of oncolytic Ad for safe and efficient delivery to cancer cells, the recent reports have noted the increasing tendency of adenoviral capsid coated with polymer. We previously reported the applicatory potential of the biodegradable

polymer, poly(CBA-DAH) (CD) as a promising candidate for efficient gene delivery. To endow the selective targeting of tumor vasculature to CD, cRGDfC well-known as a ligand for cell surface integrins on tumor endothelium was conjugated to CD using hetero-bifunctional cross linker SM(PEG₅₀₀) for CD-PEG₅₀₀-RGD or SM(PEG₂₀₀₀) for CD-PEG₂₀₀₀-RGD. The oncolytic Ad (Ad-ΔB7-IL8) expressing shRNA against interleukin-8 mRNA was physically complexed with CD, CD-PEG₅₀₀-RGD or CD-PEG₂₀₀₀-RGD with different molar ratios. The size of each polymer-coated Ad complex was measured by dynamic light scattering (DLS) and each complex was transduced to HT1080 (low CAR expression, high integrins expression) or MCF7 (negative CAR, high integrins expression) cells to check cytopathic effects following transduction efficiency. Among them, the most effective cell killing effect was assessed with the treatment of Ad/CD-PEG₅₀₀-RGD including shorter size of PEG molecule. Whereas, the viability of the cancer cells treated with non-targeted Ad/CD-PEG₅₀₀ was increased compared with Ad/CD or Ad/CD-PEG₅₀₀-RGD. HT1080 and MCF7 cells treated with Ad/CD-PEG₅₀₀-RGD showed higher induction of apoptosis and suppression of VEGF expression as well when compared with other experimental groups. In summary, RGD-conjugated bioreducible polymer might be used to deliver oncolytic Ad safely and efficiently for tumor therapy.

807. A Replication-Selective Adenovirus Expressing the Prodrug-Converting Enzyme CD/UPRT Efficiently Inhibits Tumour Growth in Prostate Cancer Models

Maria Ekblad,¹ Daniel Oberg,¹ Nicholas Lemoine,¹ Gunnell Halldén.¹

¹Centre for Molecular Oncology and Imaging, Barts Cancer Institute, QMUL, London, United Kingdom; ²Barts Cancer Institute, QMUL, London, United Kingdom; ³Barts Cancer Institute, QMUL, London, United Kingdom.

Prostate cancer is the second most common cause of cancer-related deaths in men. Hormone ablation and chemotherapy are the only available treatment modalities for more advanced cancers that frequently develop resistance to all therapies. We recently engineered a replication-selective oncolytic adenovirus AdΔΔ with deletions in both the E1ACR2-region (pRb-binding) and the anti-apoptotic E1B19K gene for prevention of spread in normal cells. AdΔΔ replicates only in cancer cells with deregulated cell cycle pathway and interacts synergistically with chemotherapeutics such as docetaxel and mitoxantrone to kill prostate cancer cells. In this study, the prodrug-converting enzyme CD/UPRT was inserted into the E3B-region to generate the novel AdΔΔCU mutant. CD/UPRT converts the non-toxic prodrug 5-fluorocytosine (5-FC) to toxic 5-fluorouracil (5-FU) in infected cells, resulting in high local concentrations while systemic toxicity is avoided. When AdΔΔCU was evaluated in the human prostate cancer cell lines PC3, DU145 and 22Rv1 the mutant could efficiently kill, infect and replicate. As expected, in normal human prostate (PrEC) and bronchial (NHBE) epithelial cells only limited toxicity and no significant replication was observed. By combining AdΔΔCU and 5-FC cell killing efficacy was greatly increased in both cell lines and PC3 xenograft models in vivo. EC50 values for AdΔΔCU was 10-100-fold lower in the presence of 5-FC (1-100 μg/ml). Increased viral uptake in response to 5-FU followed by higher early viral protein expression (E1A) caused the improved viral efficacy with 5-FC. However, viral replication was attenuated in the presence of drug suggesting complex interactions between AdΔΔCU and drug. Further modifications of the virus are in progress to maximise anti-tumour efficacy in the combination treatment. In conclusion, AdΔΔCU/5-FC is a promising new therapeutic regime for future application in prostate cancer treatment.

808. Oncolytic Adenoviral Vector Targeted to Hepatocellular Carcinoma Expressing Low Levels of miR-122

David Sharon,¹ Michael Shumann,² Sandeep Randhawa,¹ Mary Hitt.¹

¹*Oncology, University of Alberta, Edmonton, AB, Canada;* ²*Quality Control Laboratories, CSL Behring, Marburg, Germany.*

Oncolytic adenoviral vectors have been extensively studied as a potential therapy for the treatment of hepatocellular carcinoma (HCC). However, due to the ability of these vectors to replicate, there is a high risk of liver toxicity. Recently, several studies have found that addition of targeted sequences of the liver-specific miR-122 at the 3' untranslated region of transgenes encoded by replicating adenoviruses reduced transgene expression in liver cells, as well as liver toxicity in *in vivo* mouse models. Many hepatocellular carcinoma tumours and cell lines downregulate the expression of miR-122, and therefore, addition of these targeted sequences may confer specificity to HCC cells compared to normal liver cells. We have constructed an oncolytic adenoviral vector that contains two miR-122 targeted sequences at the 3' untranslated region of the E1a gene. To further increase the cancer specificity of the vector, both the E1b gene and the virus-associated RNA genes were deleted from the viral genome. Deletion of either gene has previously been shown to increase the specificity of adenoviral replication and cell lysis in many cancer cells, and therefore, deletion of both genes, as well as restricting E1a protein expression to non-liver cells, should reduce the toxicity to normal liver cells. Western blot analysis showed that two days following infection with the oncolytic vector, E1a levels were much higher in HCC cell lines expressing low levels of miR-122 (HepG2 and Hep3B) when compared to an HCC cell line expressing high levels of miR-122 (HUH7.5). Additionally, survival curves seven days following infection showed much lower survival of HepG2 and Hep3B compared to HUH7.5. Caspase 3 expression and activation was elevated in HepG2 and Hep3B cells, suggesting that the cell death mediated by viral infection is through apoptosis. Hexon is a late adenoviral protein often used as a marker of viral replication. Hexon levels were found to be much higher in HepG2 and Hep3B (low miR-122 levels) compared to HUH7.5 (high miR-122 levels). Additionally, increased infectious virus production was measured in HepG2 and Hep3B compared to HUH7.5. These results suggest that miR-122 sufficiently reduces E1a protein expression in order to reduce viral replication as well as cell death. Recent studies using oncolytic adenoviral vectors have shown that increased antitumour effect can be found when chemotherapeutic drugs are administered in combination with the virus. Therefore, we are currently determining whether the addition of cisplatin can specifically increase cell death of HCC cells expressing low levels of miR-122. Deletion of E1b and VA-RNA genes, in addition to inhibition of E1a expression in liver cells, should result in an increase the therapeutic index of this oncolytic vector. Therefore, this oncolytic adenoviral vector has high potential to be a clinical therapy for the treatment of HCC.

Cancer-Targeted Gene & Cell Therapy III

809. E10A, an Adenovirus Carrying Endostatin Gene, Enhanced Anti-Tumor Effect of Metronomic Chemotherapy with Low Dose Cisplatin in a Xenograft Mouse Model for Head and Neck Squamous Cell Carcinoma

Zainal Adhim,^{1,2} Xubin Lin,³ Wenlin Huang,³ Tsutomu Nakamura,⁴ Hiroyuki Yasui,⁵ Naoki Otsuki,¹ Ken-ichi Nibu,¹ Masato Fujisawa,⁶ Toshiro Shirakawa.^{1,6,7}

¹*Otolaryngology-Head and Neck Surgery, Kobe University Graduate School of Medicine, Kobe, Japan;* ²*Infectious Disease Control, Kobe University Graduate School of Medicine, Kobe, Japan;* ³*Himeji Dokkyo University, Himeji, Japan;* ⁴*Kyoto Pharmaceutical University, Kyoto, Japan;* ⁵*Urology, Kobe University Graduate School of Medicine, Kobe, Japan;* ⁶*Translational Research for Biologics, Kobe University Graduate School of Medicine, Kobe, Japan.*

Background: Mostly cancer chemotherapeutic agents are administered at the maximum tolerated dose (MTD) in short cycles with treatment breaks. However, the MTD-based chemotherapies are often associated with significant toxicity and the treatment breaks might allow the opportunities for tumor regrowth and acquisition of chemo-resistance. To minimize these drawbacks, metronomic strategy, in which chemotherapeutics are administered at doses significantly below the MTD without treatment breaks, has been suggested by many investigators. The anti-tumor effect of the metronomic chemotherapy may be partially due to inhibition of tumor angiogenesis, and it could be enhanced by combination with antiangiogenic agents. Endostatin, a carboxyl-terminal proteolytic fragment of collagen XVIII, was regarded as one of the most potent inhibitors of tumor angiogenesis. In the present study, we evaluated the synergistic effect of E10A, an adenovirus carrying endostatin gene, in combination with metronomic chemotherapy with weekly low dose cisplatin in a xenograft mouse model for head and neck squamous cell carcinoma. **Methods:** Real time RT-PCR and immunocytochemical study were performed to detect endostatin mRNA and protein expressions in human hypopharyngeal squamous cell carcinoma, H891 cells, infected with E10A. H891 cells were injected subcutaneously into the flank of BALB/c (nu/nu) mice. Intra-tumoral injections of E10A at 1×10^9 pfu, and intraperitoneal injections of cisplatin at 2mg/Kg body weight, were given to mice with H891 xenografted tumor once a week for 4 weeks. The mice received injections of intratumoral Ad/LacZ and intraperitoneal PBS were regarded as control groups. The tumor size was measured twice a week and tumors were extracted at 4 weeks after the treatment initiation for immunohistochemical analysis. **Results:** E10A induced the mRNA and protein expressions of endostatin in H891 cells *in vitro*. In *in vivo* experiments, the combination of E10A and cisplatin significantly inhibited the tumor growth compared with the other treatment groups: E10A alone, cisplatin alone, Ad/LacZ alone, and PBS alone. Immunohistochemical study with anti-ssDNA and anti-CD31 antibodies revealed that the combination of E10A and cisplatin highly induced cell apoptosis and inhibited tumor angiogenesis compared with the other treatment groups. **Conclusion:** E10A could enhance the metronomic chemotherapy with cisplatin for head and neck cancer. This combinational approach deserves further extensive investigation.

murine IFN γ . Plasmid DNA expressing the fusion protein, pCpG-IFN γ -(HBD)_n (n=1 to 3), was delivered to mouse liver through hydrodynamic injection. The serum concentration of IFN γ was determined by ELISA, and its biological activity in the liver was determined by measuring the mRNA levels of IFN γ -inducible molecules. M5076 murine ovarian sarcoma cells were inoculated to mice via the tail vein to establish a mouse model of hepatic metastasis, and the survival of mice was monitored. The toxicity was evaluated by anorexia, body weight loss and liver damage. **Results:** The mRNA expression of IFN γ derivatives decreased with increasing number of HBD on IFN γ . The serum concentration of IFN γ also decreased with the HBD number, and a large decrease was observed for IFN γ -(HBD)₂ and IFN γ -(HBD)₃, suggesting that two or more repeats of the HBD are effective in capturing the fusion proteins onto liver cells. An intravenous injection of heparin resulted in a transient increase in the serum concentration of IFN γ -(HBD)₂. Despite the huge differences in the serum concentration of IFN γ , the ratio of the mRNA levels of IFN γ -inducible molecules to those of IFN γ in the liver was almost comparable to all groups. A hydrodynamic injection of pCpG-IFN γ -(HBD)₂ was as effective as that of pCpG-IFN γ in suppressing the liver metastasis, whereas it caused no significant liver toxicity, loss of body weight and anorexia, which were obvious in mice receiving pCpG-IFN γ . **Conclusion:** We have demonstrated that gene transfer of IFN γ -(HBD)₂ to the liver is effective in inhibiting hepatic metastasis as well as in reducing IFN γ -inducible systemic side-effects.

813. Cytokine-Based Log-Scale Expansion of Functional Human Dendritic Cells from PBMCs

Yui Harada,^{1,2} Satoru Saito,¹ Yosuke Morodomi,¹ Kumi Yoshida,¹ Tomohiko Ichikawa,² Yoshikazu Yonemitsu.¹

¹R&D Laboratory for Innovative Biotherapeutics, Kyushu University Graduate School of Pharmaceutical Sciences, Fukuoka, Japan; ²Departments of Urology, Chiba University Graduate School of Medicine, Chiba, Japan.

PURPOSE: Dendritic cells (DCs) play a crucial role in maintaining the immune system. Though DC-based cancer immunotherapy has been suggested to hold potential to treat various kinds of malignancies, clinical efficacies are still insufficient in many human trials. We proved that this antitumor effect depends on the number of DCs (unpublished data), and it is necessary to prepare an enough number of DCs for effective treatments of tumors. In this study, therefore, we attempted to expand functional human DCs ex vivo with cytokine cocktail. **Materials and Methods:** Peripheral blood mononuclear cells (PBMCs) and CD14⁺ cells were obtained from volunteers. Conventional DCs were obtained from peripheral blood CD14⁺ cells as described previously with minor modification. Briefly, CD14⁺ cells were cultured under hGM-CSF and hIL-4 (GM/IL-4). CD3-depleted PBMCs were expanded and differentiated into DCs in the presence of hGM-CSF and hSCF (GM/SCF) or GM/IL-4 for several weeks. Expanded DC properties such as expression of surface markers, inflammatory cytokines production, phagocytotic activity, antigen presenting ability in vitro were analyzed, and compared with those of conventional DC. **RESULTS:** CD3-negative cells increased approximately 10 - 100 fold after 5 weeks culture and >80% of expanded cells expressed CD11c. Thus, by this method, 10 - 100 times more CD11c⁺ cells could be obtained than conventional procedures could. As are seen in conventional DCs, expanded DCs showed dendrites after maturation, and endocytotic activities. Expanded DCs also expressed HLA-DR, adhesion molecules, and co-stimulatory molecules and produced inflammatory cytokines as well as conventional DCs did. Functionally, mixed lymphocyte reaction (MLR) assay revealed that expanded DCs could stimulate allogenic T-cell proliferation to the same extent as conventional DCs. **CONCLUSIONS:** We found that human CD11c⁺ cells could be effectively expanded from PBMCs by culture with cytokine cocktail

(GM/SCF). Expanded DC had properties that were required to obtain therapeutic gain. We expect that this technology will be able to contribute largely to both basic and clinical research of human cancer immunotherapy. DC expansion technology will improve therapeutic gain of cancer and alleviate patients' burden of apheresis.

814. A New Method To Develop Genetically Modified Lung Cancer Stem Cells

Feridou Karimi-Busheri,¹ Victoria Zadorozhny,¹ Ali Haghighi,¹ Daniel L. Shawler,¹ Habib Fakhrai.¹

¹NovaRx Corporation, San Diego, CA.

Discovery of cancer stem cells has initiated a new era that holds much promise and hope in the fight against cancer. Tumor stem cells are resistant to chemotherapy and radiation and are reputed to be one of the major causes of cancer recurrence. We have established an intense program to better understand lung cancer tumor stem cells and develop new therapeutic approaches against lung cancer, the most prominent, and most common, cancer killer in the world. The annual death due to this disease exceeds the combined deaths caused by colon, breast, prostate, and pancreatic cancers. Thus, development of an effective therapy is critical to serve this serious unmet medical need. Lung cancer causes severe morbidity and mortality and its cost to the society related to treatment costs, morbidity, and mortality approaches a 100 billion annually in the United States. Here we report the isolation and gene modification of lung cancer stem cells from established non-small cell lung cancer (NSCLC) cell lines and from primary cells of a NSCLC tumor xenograft established in NOD/SCID mice. We also present methodologies towards genetically engineering the isolated cells by antisense gene modification with the TGF- β antisense vector pKNC/SBA2 and the generation of large-scale quantities of the gene modified tumor stem cells for utilization in clinical trials. Our data demonstrate that the secretion of TGF- β is significantly reduced by the transformed vector and expression of many genes is significantly altered in gene modified cells compared to the parental unmodified cell lines. Inclusion of a specific cancer stem cells vaccine as components of our whole tumor cell vaccine cocktails belagenpumatucel-L, which has shown effectiveness in 70 percent of the patients in a phase II clinical trial, may result in an even higher survival among the patients and decreasing tumor metastasize.

815. miRNA from Tumor-Associated Macrophages as Serum Biomarkers for Ovarian Cancer

Jonas Persson,¹ Ines Beyer,¹ Nicole Urban,² Charles Drescher,² Andre Lieber.¹

¹Division of Medical Genetics, University of Washington, Seattle, WA; ²Fred Hutchinson Cancer Research Center, Seattle, WA.

Our findings and published data show that ovarian cancers are heavily infiltrated by tumor-associated macrophages (TAMs). TAMs secrete factors that support tumor growth and prevent anti-tumor immune responses. There is a clear correlation between the number of TAMs and malignancy. Our central hypothesis is that TAM derived miRNA can serve as a serum biomarker for cancer. miRNAs have distinct expression profiles in different tissues. They are actively released from cells and highly stable in a cell-free form in the blood. To test our hypothesis, we isolated TAMs from mouse tumors or biopsies from ovarian cancer patients and compared their miRNA expression profiles with those of peripheral blood monocytes from animals or patients without tumors. Based on this, we selected a set of miRNA that were expressed at a significantly higher level in TAMs. In preliminary studies in mice, we found that several of these miRNAs were present at significantly lower levels in serum from mice with tumors compared to serum from control mice. Furthermore, the concentration of these miRNA inversely correlated with the tumor

size in animals. By measuring the concentration of these miRNA in tumor cells and circulating TAMs, we came to the conclusion that serum miRNA were derived from circulating TAMs and that in tumor bearing mice less circulating TAMs and more tumor-localized TAMs were present. This explains the lower serum concentration of TAM-specific miRNA in serum of tumor bearing mice. Preliminary data with circulating human TAMs and serum miRNA corroborated the observations made in mice. We are currently conducting studies with a large number of PBMCs and serum from healthy donors and patients with different stages of ovarian cancer to assess the specificity and selectivity of TAM miRNA as biomarkers of ovarian cancer. As the use of tumor derived miRNA as biomarkers is complicated by the genetic and epigenetic instability of cancer cells, TAM-derived miRNAs might be a more reliable marker for early detection and prognosis of ovarian cancer.

816. Increased Invasiveness and Host Vessels Co-Option after 15-LO-1 and HSV-tk Combination Gene Therapy in Rat Glioma Model

Agnieszka Pacholska,¹ Hariitha Samaranyake,^{1,2} Jere Pikkarainen,^{1,2} Farizan Ahmad,¹ Thomas Wirth,¹ Seppo Ylä-Herttua.¹

¹Department of Biotechnology and Molecular Medicine, A.I. Virtanen Institute, Kuopio, Finland; ²Ark Therapeutics Oy, Kuopio, Finland.

One of the most fatal and refractory cancer type in humans is malignant glioma, out of which the most common and aggressive subtype is glioblastoma multiforme. Gliomas are among the most vascularised tumors in humans, what makes them a potential target for anti-angiogenic therapies. 15-lipoxygenase-1 (15-LO-1) is widely expressed in various cells and acts on diverse signal transduction pathways. It is known that 15-LO-1 may possess strong anti-angiogenic properties. Recently, we have proved that 15-LO can also induce apoptosis by induction of lipid peroxidation in vivo and is able to significantly extent survival in rat malignant glioma. We concluded that 15-LO-1 gene therapy could be used as a promising cancer treatment acting through two independent mechanisms with pro-apoptotic therapeutic effects additionally being complemented by inhibition of tumor angiogenesis. Therefore, we tested the therapeutic potential of 15-LO gene therapy in combination with adenoviral herpes simplex thymidine kinase (AdHSV-tk) to investigate whether it could additionally enhance the effects of suicide gene therapy. BDIX male rats were injected with 10⁴ BT4C glioma cells into the right corpus callosum. 15 days after cell inoculation the animals received 3 injections (2.5 μ l per site) of both Adh15-LO-1 (2.7 x 10¹⁰ pfu/ml) and AdHSV-tk (1.45x10¹² vp/ml), followed by two additional injections applied the next day and 14 days of gancyclovir treatment (50mg/kg). Combination gene therapy did not inhibit the tumor growth and showed no survival benefit. However, a profound effect on the migratory properties of the tumor cells was noted. The treatment induced a shift in glioblastoma tumor phenotype toward enhanced migration and healthy tissue infiltration, represented by formation of multiple satellite tumors. Moreover, co-option of the host vasculature became a compensatory mechanism to combination therapy, as the tumor cells ensheathed preexisting vessels and traveled along them to invade healthy tissue. Our results are in line with other reports, suggesting that some cancer therapeutics, in particular anti-angiogenic drugs, may elicit tumor adaptation and its progression to a metastatogenic phenotype.

817. Effective Sensitization of Paclitaxel-Resistant Colorectal Cancer Cells by New Cationic Micelle-Based Combined Delivery of Paclitaxel and XIAP siRNA

Yeon Lim Jang,¹ Ui Jeong Yun,¹ Min Sang Lee,¹ Myung Goo Kim,¹ Su Young Chae,¹ Dong-Gyu Jo,¹ Jae Hyung Park,² Ji Hoon Jeong.¹
¹School of Pharmacy, Sungkyunkwan University, Suwon, Korea;
²Department of Chemical Engineering, Kyung Hee University, Suwon, Gyeonggi-do, Korea.

Although a number of therapeutic treatments have been developed, cancer is still a leading cause of death. The problem seems to come from the complexity of the disease, which involves a lot of different molecules during its pathogenesis. This may be one of the reasons why cancer cannot be readily eradicated by a single treatment, such as small molecule-based chemotherapy. Chemotherapy is still the most widely used approaches for cancer treatment. One of the most challenging factors of chemotherapy is to overcome intrinsic and acquired drug resistance of cancer cells. Majority of anticancer drugs depend mainly on the induction of apoptosis for cancer cell death. However, since expression of antiapoptotic proteins such as Bcl-2 and inhibitors of apoptosis (IAPs) is significantly elevated in many types of cancers, the efficiency of chemotherapy is often limited by the resistance mechanism developed by cancer cells. In addition, the treatment of anticancer drugs can also induce the expression of the drug-resistant proteins. Simultaneous use of apoptosis-inducing drug and an inhibitor that blocks the action of anti-apoptotic proteins would address the drug resistance problems for cancers. In this case, best results can be expected if an apoptosis-inducing anticancer drug and inhibitors for anti-apoptotic proteins exist in the same space and time, i.e., the same intracellular space. Therefore, in this study, we used a new cationic micelle-based delivery system that can deliver water-insoluble anticancer drug and nucleic acid drug in a single vehicle. Previously, we showed a conjugate of bile acid and low molecular weight polyethylenimine (PEI 1.8 KDa) spontaneously formed cationic micelles in an aqueous milieu and showed highly efficient and consistent cellular delivery of nucleic acid drugs such as plasmid DNA and siRNA in various cells, including hybridomas, primary cells, and adult stem cells. The amphiphilic cationic micelle could also effectively dissolve an water-insoluble anticancer drug, paclitaxel. The paclitaxel-loaded cationic micelle was used for a combined delivery vehicle for siRNA. The siRNA silences the expression of antiapoptotic protein at post-transcriptional level while the anticancer drug induces apoptosis, leading to synergistic anticancer effect. Colorectal cancers are known to over-express XIAP, X-linked inhibitor of apoptosis, which reduces the action of paclitaxel. The delivery of XIAP siRNA efficiently reduced the amount of XIAP in colorectal cancer cell (HCT-116). The combined delivery of an apoptosis inducer, paclitaxel, and siRNA targeting XIAP (X-linked inhibitor of apoptosis) protein significantly increased the sensitivity of colon cancer cells for paclitaxel. The combined delivery system also demonstrated a desired synergic effect in an animal model bearing tumor xenograft.

818. c-Cbl shRNA-Expressing Adenovirus Sensitizes TRAIL-Induced Apoptosis with Less Side Effects

So Y. Kim,^{1,2} Bo K. Sun,² Seeun Oh,^{1,2} Dongho Kim,³ Joo-Hang Kim,^{1,2} Jae J. Song.²

¹Brain Korea 21 Project for Medical Science, Yonsei University College of Medicine, Seoul, Korea; ²Institute for Cancer Research, Yonsei University College of Medicine, Seoul, Korea; ³Genolution Pharmaceuticals, Inc, Genolution Pharmaceuticals, Inc, Seoul, Korea.

Previously, we suggested that c-Cbl-down regulation can sensitize TRAIL-induced apoptosis with two different ways. One way is to block the rapid degradation of TRAIL receptors, which keeps TRAIL-induced apoptosis for a long time. The other way is to inhibit Akt phosphorylation induced by TRAIL. For the application of adenoviral cancer gene therapy, first of all, we designed an adenoviral shuttle vector with the indicated c-Cbl shRNA sequence. Then, additional several targets for efficient repression of c-Cbl mRNA were screened by real time RT-PCR and selected one target sequence for the direct comparison of former c-Cbl shRNA. After the production of adenoviral vectors with different c-Cbl shRNA, we tested which adenovirus expressing different type of c-Cbl shRNA had better effect on the Cbl downregulation and functioned as better sensitizer of TRAIL-induced apoptosis in various tumor cell lines. As a consequence, TRAIL enhanced apoptosis in Cbl-down regulated cells induced by infection of c-Cbl shRNA-expressing adenovirus with less invasive activity through less binding of CIN85. And this sensitizing effect of c-Cbl shRNA-expressing adenovirus was also confirmed in nude mice. Based on the evidences, combined therapy using both TRAIL gene and c-Cbl shRNA is under investigation.

819. PEI-CyD-FA Coated Adenovirus as an Effective and Safe Gene Delivery Vector

Hong Yao,^{1,2} Julia J. Li,¹ Wai S. Poon,¹ Hsiang-fu Kung,² Xiu Wu Bian,² Marie C. Lin.^{1,2}

¹Brain Tumour Centre, Division of Neurosurgery, Dept of Surgery, The Chinese University of Hong Kong, Hong Kong, Hong Kong; ²Southwest Cancer Center, Southwest Hospital, Chong Qing, China.

Recombinant adenovirus is evolving as a promising gene delivery vector for gene therapy. However, the host immune response could cause rapid clearance of the vector, impair its efficacy, and obstruct its effective clinical applications. We have previously synthesized a biodegradable co-polymer consisting of low molecular weight PEI, β -cyclodextrin, and folic acid (PEI-CyD-FA). Here we reported that adenovirus coated with PEI-CyD-FA could enhance the transfection efficiency and prolonged the duration of gene expression in immunocompetent mice by either intratumoral injection and systemic administration. Importantly, repeated injection did not reduce the transfection efficiency. Furthermore, we found that PEI-CyD-FA may coat the capsid protein of adenovirus and transformed the surface charge of adenovirus capsomers from negative to positive in physiological solution, which could shelter the epitopes of capsid protein of adenovirus. These findings suggest that PEI-CyD-FA coated Adv is a promising gene delivery system and warrant further investigations.

Hematologic and Immunologic Gene & Cell Therapy II

820. Tolerance Induction towards Protein Therapy Using Autologous Dendritic Cells

Gautam Sule,¹ Masataka Suzuki,¹ Racel Cela,¹ John Rodgers,³ Brendan Lee.^{1,2}

¹Department of Molecular and Human Genetics, Baylor College of Medicine, Houston, TX; ²Howard Hughes Medical Institute, Houston; ³Department of Pathology & Immunology, Baylor College of Medicine, Houston, TX.

A major obstacle in the genetic therapy of inherited metabolic disease includes host immune response to the therapeutic protein. This is best exemplified by inhibitor formation in the protein therapy for hemophilia A. An approach to overcoming this is the stimulation of immunological tolerance to the therapeutic protein. Tolerogenic dendritic cells (DCs) have the unique ability to initiate and direct the host immune response towards peripheral tolerance. Cytokines such as IL-10 and TGF- β 1 have been identified as key mediators of tolerogenic response. Our group has demonstrated that combinatorial treatment with IL-10 and TGF- β 1 of DCs (DCtols) can effectively suppress T cell proliferation while accelerating differentiation of Tregs *in vitro*. Additionally, we have also succeeded in generating DCtols to specific antigens. Our data shows that adoptive transfer of DCtols pulsed with an antigen, is able to suppress antibody response in mice. We observe that tolerance is very robust as even a booster injection of the antigen in the mice does not alleviate the tolerance. This phenomenon was observed even in DO11.1 mice indicating the effectiveness of the therapy. This report demonstrates that autologous cell therapy for antigen-targeted immune suppression may be developed to facilitate long-term therapy. Additionally, this study would have broad implications in solid organ transplantation and auto-immune diseases like diabetes and inflammatory bowel disease where proinflammatory responses are undesirable.

821. Rescue of the Bleeding Diathesis in Severe Von Willebrand Disease Using Lentiviral Gene Transfer

Jonathan B. Rosenberg,¹ Bishnu P. De,¹ Lan Wang,¹ Stephen M. Kaminsky,¹ Ronald G. Crystal.¹

¹Genetic Medicine, Weill Cornell Medical College, New York, NY.

Von Willebrand factor (VWF) is a large multimeric plasma glycoprotein that functions as a carrier for the coagulation factor VIII and mediator of platelet adhesion to sites of vascular lesions. Mutations in the *vwf* genomic locus lead to the development of von Willebrand disease (VWD), a common inherited bleeding disorder affecting 1 to 3% of the U.S. population. Since VWD is a systemic monogenetic disorder, it is ideal for gene therapy, but its size (cDNA 8.4 kb), with multiple functional domains that cannot be excised, is a packing challenge for most gene transfer vectors. Based on the knowledge that the intact VWF cDNA will fit into a lentivirus expression cassette, we assessed the ability of a lentivirus vector to transfer the intact murine VWF cDNA *in vivo* directly to the liver as a means to ameliorate the bleeding symptoms of severe VWD. A lentivirus construct (LentiCMV.mVWF) was created with the full length murine VWF cDNA under the control of a CMV promoter, and inserted in a self-inactivating replication-defective lentivirus. As a control, the VWF cassette was replaced by the human α 1-antitrypsin gene (LentiCMV.hATT). Full length VWF multimers were observed in the supernatants of *in vitro* cell cultures following LentiCMV.mVWF infection. Newborn litters of VWF $-/-$ mice (1 to 2 days old) were injected intrahepatically with (1-2 x 10⁹ particle units) of lentivirus. The mice were assessed over 3 months for VWF antigen by Western analysis and tested for bleeding parameters.

Parallel experiments using α 1-antitrypsin as the transgene showed consistent levels of 1 to 1.5 mg/ml of α 1-antitrypsin in mouse serum over the same time period. Administration of LentiCMV.mVWF to VWF -/- mice allowed development of full length VWF multimers in approximately 30% of each treated litter, resulting in improvements in the bleeding time assays as early as wk 3, with 33% of the treated mice showing complete cessation of bleeding at 3 months. The volume of blood following tail incision was significantly reduced in 41% of the treated mice. In contrast, all untreated VWF knockout mice continued bleeding until cauterized, while all of the WT control mice showed complete cessation in less than 4 min. In LentiCMV.mVWF treated knockout mice, normal VWF expression was restored and was detectable over a 3 month period, with expression levels >1-3% normal levels (comparable to severe VWD transformed to moderate VWD in humans). Thus, it is possible to partially correct VWD with administration of lentiviral VWF vectors to the neonatal liver in some affected mice. While the reason for the variability in the efficacy is not clear, a significant improvement in the bleeding diathesis of some affected animals suggests a lentivirus-based strategy should be pursued.

822. Blood Outgrowth Endothelial Cells for Gene Therapy of Rheumatoid Arthritis

Jeana Zacharias,¹ Jennifer L. Auger,² Liming Milbauer,³ Robert P. Heibel,³ Bryce A. Binstadt,² Nicola J. Philpott.¹
¹Medicine (Rheumatic and Autoimmune Diseases), University of Minnesota, Minneapolis, MN; ²Pediatrics (Pediatric Rheumatology), University of Minnesota, Minneapolis, MN; ³Medicine (Hematology, Oncology and Transplantation), University of Minnesota, Minneapolis, MN.

Blood outgrowth endothelial cells (BOECs) are mature endothelial cells that have a high expansion capacity *in vitro*, stable phenotype and ability to expand *in vivo* with no apparent toxicity. BOEC-based gene therapy alleviates safety concerns associated with administration of a vector directly *in vivo* and since they are derived from the host, would present a low risk of immune response, potentially allowing multiple administrations for chronic disease. Furthermore, since BOECs are mature cells, we do not expect any adverse effects due to differentiation following administration of the cells. BOECs have been shown to migrate to sites of increased angiogenesis in tumor vasculature *in vivo*. Our goal was to determine whether BOECs would also migrate to regions of angiogenesis in the inflamed joints of an arthritic phenotype. Ultimately, we are interested in harnessing the ability of BOECs that express a therapeutic transgene to migrate to sites of intense angiogenesis in Rheumatoid Arthritis (RA) and developing a cell-based gene therapy for the treatment of RA. The aims of this project are to assess migration of BOECs to areas of angiogenesis in murine models of RA and to determine whether a single systemic administration of BOECs can treat the multiple sites of inflammation in these mice. We hypothesized that luciferase-expressing BOECs would migrate to the joints in the arthritic mice and therefore luciferase expression would be higher in the affected joints of arthritic animals when compared to controls. Our approach was to transduce C57Bl/6 BOECs with a lentiviral vector containing a luciferase reporter gene. The transduced BOECs were then injected intravenously into control non-arthritic mice or C57Bl/6 mice with arthritis induced by serum transfer from K/BxN mice. Imaging of the mice over a period of days using Xenogen-IVIS live imaging allowed us to quantify luciferase expression from the luciferase-expressing BOECs. The results from our experiments show that at 3 hours post-BOEC injection, the BOECs were predominantly located in the lungs and luciferase expression in the joints was similar in the arthritic and control animals. However, after 24 hours, luciferase expression was significantly higher in the hind paws of arthritic mice compared to control animals in which luciferase expression had decreased to

background levels. Our results show that BOECs are retained in sites of angiogenesis within inflamed arthritic joints in murine models of RA. Histological analysis will determine the precise location of the BOECs within the arthritic paws and show the level of incorporation of BOECs into the joint vasculature. We are currently investigating the rescue of murine models of serum-transfer arthritis using BOECs that express a therapeutic transgene, such as IL-10. Data from this project will evaluate how BOEC-based cell therapy can be used as a potential tool in the treatment of inflammatory diseases such as RA.

823. Factor IX Expression in Skeletal Muscle of a Subject with Severe Hemophilia B Ten Years after AAV Gene Transfer

George Buchlis,^{1,2} Gregory M. Podsakoff,¹ Antonetta Radu,³ Alan W. Flake,³ Federico Mingozzi,¹ Katherine A. High.^{1,2,4}
¹Pediatrics/Hematology, The Children's Hospital of Philadelphia, Philadelphia, PA; ²University of Pennsylvania School of Medicine, Philadelphia, PA; ³Surgery, The Children's Hospital of Philadelphia, Philadelphia, PA; ⁴Howard Hughes Medical Institute, Philadelphia, PA.

The optimal route of delivery and target tissue for AAV-mediated gene transfer of Factor IX (F.IX) in patients with hemophilia B is likely to be liver, but individuals with hepatitis C and/or liver disease as a consequence may not be candidates for liver-directed gene transfer. We showed in a clinical trial that direct intramuscular injection of AAV encoding F.IX was safe and led to positive muscle expression of the F.IX protein, yet circulating plasma levels were sub-therapeutic (Kay et al., Nature Genetics 2000; Manno et al., Blood 2003). Since preclinical data suggested that increasing the dose per injection site would increase the risk of neutralizing antibody formation to the F.IX transgene (Herzog et al., Human Gene Therapy 2002), and since the number of injections had reached 100 for a subtherapeutic dose, further dose escalation was not attempted. Here we report evidence of long-term F.IX expression in one of the subjects from the AAV-F.IX IM trial ten years after vector administration. Subject F was a 43 year old Caucasian male with severe hemophilia B and a prior history of a pseudotumor, but no documented history of an inhibitor. He received a dose of 6E11 vector genomes per kilogram, spread over ~50 injection sites. Muscle biopsies in the year following vector administration showed the presence of vector genomes by PCR, and positive F.IX immunohistochemical staining of muscle sections, as previously reported (Manno et al, Blood 2003). Approximately 10 years after vector injection, the patient died of complications of surgery for the pseudotumor. We obtained skeletal muscle tissue at the time of patient expiry and 4 hours later at autopsy. Using Western blot for F.IX protein in multiple samples of injected muscle, we show robust levels of F.IX protein. Additionally, immunoperoxidase staining and immunofluorescent staining of muscle sections show a mosaic form pattern of F.IX expression in the injected muscle, as seen in the initial biopsies and likely reflecting the tropism of AAV2 for slow vs. fast muscle fibers. Additionally, RT-PCR on RNA extracted from the patient's muscle was positive for F.IX transcript, indicating active transcription of the F.IX transgene within the muscle tissue. To our knowledge, this is the longest reported expression of a parenterally administered AAV vector. Our lab has recently published successful efficacy and safety studies in canine HB models with alternative muscle administration techniques, notably ATVRX or afferent transvenular retrograde extravasation (Arruda et al., Blood 2010). This method transduces muscle fibers more extensively while reducing risk of inhibitor formation by avoiding highly concentrated foci of vector administration. Improved delivery coupled with the finding of muscle expression of F.IX one decade post administration suggests that muscle delivery of genes encoding plasma proteins is a viable therapeutic option.

824. Recombinant AAV2-Mediated β -Globin Expression in Human Fetal Hematopoietic Cells from the Aborted Fetus with β -Thalassemia

Jing Tian,^{1,2} Feng Wang,^{1,2} Jin-feng Xue,^{1,2} Fei Zhou,^{1,2} Liu-jiang Song,^{1,2} Meng-qun Tan.^{1,2}

¹Physiology, Central South University Xiang-Ya School of Medicine, Changsha, Hunan, China; ²Xiang-Ya Bio-Medicine Institute, Shenzhen, Guangdong, China.

Background: The most severe form of β -Thalassemia, β^0 -Thalassemia major, is characterized by complete absence of normal β -globin chain, and is often lethal. Autologous transplantation of genetically-modified hematopoietic stem cells (HSCs) using lentiviral vectors is currently being pursued as a possible treatment. As an alternative, recombinant adeno-associated virus (rAAV) vectors offer promise due to their low immunogenicity, broad host-range, and efficient infection of a wide variety of cell types. We have previously documented rAAV2-mediated β -globin gene transfer and expression in human fetal liver cells *in vivo*. In this study, we investigated whether rAAV2 could also mediate expression of normal β -globin gene in human HSCs from β -Thalassemia patients. **Methods:** Human HSCs were isolated from two aborted fetuses at 20 and 24 weeks of gestation. One fetus was heterozygous for $\beta^{41/42(-TCTT)}/\beta^{71/72(+A)}$, and the other was $\beta^{41/42(-TCTT)}/\beta^E$. The isolated HSCs were mock-transduced or transduced with rAAV2- β -globin at 5×10^4 v/cell, followed by *i.v.* injection into sub-lethally irradiated BALB/c nude mice. Recipient mice were analyzed longitudinally on days 14, 21 for $\beta^{41/42}/\beta^{71/72}$ fetus, and days 21, 35 for $\beta^{41/42}/\beta^E$ fetus. Human β -globin gene expression in recipient mice was characterized by RT-PCR and allele-specific PCR (ASPCR). The levels of human globin expression were determined by HPLC. **Results:** Human β -actin and β -globin transcripts were detected by RT-PCR in bone marrow cells from all recipient mice, indicating that human hematopoietic cells were successfully transplanted in these mice and that human β -globin gene was transcriptionally active. ASPCR analyses revealed that whereas the mutant $\beta^{41-42}/\beta^{71-72}$ b-chain gene transcripts were detected in all recipients, the normal b-chain gene transcripts were only detected in mice transplanted with rAAV2-b-globin transduced human HSCs. For $\beta^{41/42}/\beta^E$ fetus, the mutant $\beta^{41/42}$ gene transcripts were detected using the mutant primers, while the mutant β^E and normal b-chain gene transcripts were detected using normal primers. However, only normal b-chain fragments, but not β^E mutant, were sensitive to MnlI restriction enzyme, consistent with the loss of MnlI cleavage site in the β^E mutant allele. The level of human hemoglobin expressed in red blood cells of recipient mice was measured using a highly sensitive HPLC. Expression of human β -globin was confirmed in recipient mice by mass spectrometry. The b-chain to a-chain ratio in recipient mice transplanted with rAAV2-b-globin-transduced human HSCs was improved over that in mice that received mock-transduced cells. **Conclusion:** Our results indicate that human HSCs from β -Thalassemic fetuses can be efficiently transduced by rAAV2- β -globin vectors followed by expression of normal human β -globin protein. These studies provide the proof-of-principle that rAAV2-mediated gene transfer into human HSCs may be a feasible approach for gene therapy of β -Thalassemia.

825. Immune Modulation in Hemophilia A Mice Using Anti-CD20 and Liver-Directed Gene Transfer

Brandon K. Sack,¹ Babak Moghimi,¹ Roland W. Herzog.¹

¹Pediatrics, University of Florida, Gainesville, FL.

B cell depleting antibodies are gaining popularity as a solution to antibody-mediated diseases including neutralizing antibodies to FVIII in hemophilia. We used an anti-murine CD20 IgG2a antibody (kindly provided by Biogen Idec) to deplete B cells in two strains of hemophilia A mice and investigated the potential of this treatment

to induce tolerance to FVIII when combined with gene therapy. To deplete CD20+ B cells, either BALB/c or mixed-background BL/6-129/sv mice were given 2 doses of 10mg/kg α CD20 (3 weeks apart). Depletion of B cells was confirmed by flow cytometry of peripheral blood and secondary lymphoid organs. Mice in the group "AAV8+ α CD20" (n=5 each strain) were given 10^{11} vg/mouse of an AAV8 vector expressing FVIII under a liver-specific promoter one week after the first α CD20 injection. A second group (n=5 for each strain) was given AAV8-FVIII only. Ten weeks after AAV8-FVIII treatment (8 weeks after last α CD20 treatment), the mice were challenged *iv* with 1U/mouse/week of FVIII protein for 4 weeks. BL/6-129/sv mice showed mild and transient decrease in clotting times with the AAV8+ α CD20 group reaching 0.5-1.25% of normal FVIII levels compared to >0.5% in AAV8-only mice. All mice returned to untreated levels after protein challenge. However, the two groups differed dramatically in the magnitude of their antibody responses to FVIII challenge. BL/6-129/sv mice in the AAV8-only group had a mean anti-FVIII IgG1 titer of 7001ng/ml (\pm 867), corresponding to 336 BU (\pm 88). AAV8+ α CD20 mice were hypo-responsive with anti-FVIII IgG1 titers of 1609ng/mL (\pm 868) and Bethesda titers of 22 BU (\pm 11). BALB/c mice treated in the same manner showed better efficacy of gene therapy, with clotting activities reaching 1-2% in both AAV8-only and AAV8+ α CD20 groups. Following challenge as above, 1/3 mice in the AAV8-only developed an antibody response (544 ng IgG1/mL, 5.3 BU). None of the 5 mice treated with both α CD20 and AAV8-FVIII developed a detectable antibody response. Seven weeks after the last FVIII injection, mice were challenged for a second time. One week later, mice were tested for the ability to have their clotting times corrected with exogenous F.VIII protein. Indeed, AAV8+ α CD20 and the 2 tolerant AAV8-only mice showed correction of clotting similar to that in naïve mice receiving F.VIII for the first time. Control mice formed inhibitors in response to protein therapy, and therefore their coagulation times could not be corrected. Importantly, the antibody response of mice initially receiving only α CD20 did not differ in any respect from untreated HA mice, indicating that immune competence had been regained over time as B cells repopulated the immune system. Cytokine RNA analysis of splenocytes stimulated with F.VIII showed a reduction in the expression of IL-2, IL-4 and IFN-gamma in AAV8+ α CD20 mice but little change in expression of markers for Tregs (FoxP3, CTLA-4 and CD25), suggesting that a robust Treg response may not be responsible for the long-term tolerance observed. In summary, hepatic AAV gene transfer during transient B cell depletion may be an optimal immune modulatory therapy to achieve tolerance to conventional protein therapy for hemophilia A.

826. Differential Lineage Transduction Results in Limited FVIII Expression after Ex Vivo Modification of Hematopoietic Progenitor Cells

Jennifer M. Johnston,¹ Christopher B. Doering,¹ H. Trent Spencer.¹

¹Emory University, Atlanta, GA.

We recently engineered a high expression factor VIII transgene (HP-fVIII) and successfully treated hemophilia A mice using gene-modified hematopoietic stem cells. We have optimized several aspects of the viral vector including 1) comparison of HIV and SIV-based vectors, 2) comparison of internal promoters in SIN vectors, specifically eF1 α , CMV, PGK and the MSCV oncoretroviral promoter, 3) the value of the WPRE sequence, and 4) various HP-fVIII sequences. A final optimized construct contains a B-domain deleted chimeric human/porcine transgene containing only 10% porcine fVIII sequence, which is required to confer high level expression. The transgene is driven by an eF1- α internal promoter, and the WPRE element was shown to be inconsequential as it provided no benefit to fVIII expression or viral titer and did not limit transcription through the 3' LTR. In addition to vector optimization, we tested the

effects of transplanting SIV transduced murine bone marrow stem and progenitor cells under conditions of lethal preconditioning irradiation followed by transplanting limiting numbers of gene modified HSCs, a condition designed to maximally stress the engrafted cells. For these studies Sca-1⁺ cells were isolated from CD45.1 mice, stimulated for 48 hrs in cytokine containing medium, and transduced with SIV vectors encoding either our high expression fVIII transgene or eGFP at an MOI of 50. A maximum of 250,000 cells were transplanted into lethally irradiated (11Gy) CD45.2 mice. Engraftment and transgene expression was followed for three months after transplant. Although mice were lethally irradiated, as expected because of limiting numbers of transplanted cells, engraftment was only approximately 75%, as measured in the peripheral blood. Twelve weeks after transplant approximately 45% of CD45.1 cells expressed eGFP. Interestingly, under these conditions the majority of gene-modified cells were of lymphoid origin, with <10% derived from myeloid cells. Under similar conditions, cells transduced with HP-fVIII encoding virus resulted in moderate fVIII expression (14 ng/ml) during the first two weeks after transplant and declined to 8 ng/ml by week 12. Low level fVIII expression was observed even though there was a relatively high transgene copy number, which averaged 0.6 +/- 0.3 per mononuclear cell. We previously showed that HP-fVIII is expressed mainly from the myeloid lineage after *ex vivo* transduction of hematopoietic stem cells. Taken together, these results indicate that under the conditions of maximal bone marrow ablation followed by transplantation of minimal cell numbers, lymphoid progenitors were efficiently transduced but only moderate fVIII expression was observed due to the inefficiency of lymphoid cells to produce fVIII. These studies highlight the need to understand the relative importance of the transduction process but also the issues of engraftment that occur by modifying conditioning and transplant regimens.

827. Development of Novel AAV Vectors for Potential In Vivo Gene Transfer to Hematopoietic Cells in Bone Marrow

Mengxin Li,^{1,2,4} Qin Su,¹ Ran He,¹ Hongwei Zhang,^{1,4} Terry Flotte,³ Arun Srivastava,⁵ Guangping Gao,^{1,4} Li Zhong.^{1,3}

¹Gene Therapy Center, UMass Medical School, Worcester, MA;

²Medicine, UMMS, Worcester; ³Pediatrics, UMMS, Worcester;

⁴Microbiology & Physiol Systems, UMMS, Worcester; ⁵Pediatrics, University of Florida College of Medicine, Gainesville, FL.

The transplantation of gene-corrected syngeneic hematopoietic stem cells (HSCs) into the patient could be an ideal treatment for hematopoietic diseases. However, the patients who suffer from some diseases, such as Fanconi anemia (FA), have few HSCs. Furthermore, the cells are easily damaged by *ex vivo* treatments, leaving insufficient stem cells to repopulate the marrow, and leading to the failure of gene therapy. In vivo gene transfer by direct *in situ* or systematically *i.v.* delivery of recombinant viral vectors into bone marrow (BM) could achieve long-time transgene expression. The adeno-associated virus (AAV) has gained attention as potentially useful vectors for *in vivo* gene transfer, could be used for this purpose. We have reported that mutagenesis of surface-exposed tyrosine (Y) residues on viral capsids results in significantly increase in the transduction efficiency in human and murine cells. In recent studies, we evaluated the transduction efficiency of the wild-type (WT) and these mutant scAAV2 vectors in liquid culture assays *in vitro*. Primary murine Sca1⁺, c-kit⁺, lin⁻ hematopoietic cells were infected with 2x10⁴ genome copies (GC)/cell and maintained in liquid cultures for 7 days, and evaluated for GFP transgene expression. Whereas WT-scAAV2 showed no green fluorescence, Y444F vector-transduced cultures had the most GFP-positive cells. To identify the best AAV for *in vivo* gene transfer to HSCs, we also evaluated several scAAV serotype vectors and scAAV2 triple mutant vectors (Y730+500+444F, M3) in adult C57BL6 mice *in vivo* via intra-femoral injection of 6x10¹⁰ GC of scAAVs-CBA-

EGFP vectors. The femora were collected and sectioned at 12 months post-injection. Our data demonstrated that scAAV2-M3 vector is most efficient in transducing the primitive murine BM cells after intra-femoral injection, followed by scAAV1 and scAAV7 vectors. These data were further confirmed by FACS using peripheral blood mono-nuclear cells (PBMNCs). Whereas ~0.61% of total PBMNCs in the mock group were GFP-positive, ~2.9% of cells were GFP-positive after injection of scAAV2-M3 vectors. We also evaluated the transduction efficiency of several scAAV serotype vectors in adult C57BL6 mice *in vivo* via *i.v.* injection of high dose (4x10¹² GC/mouse) of scAAVs-CB6-EGFP vectors for 3 weeks. The data showed that scAAV1, scAAVrh10 and scAAVrh39 were most efficient, followed by scAAV7 and scAAV9 vectors, in transducing the primitive murine BM cells. These data indicated that several scAAV serotype vectors are capable of transducing primitive murine hematopoietic cells *in vivo* via *i.v.* injection of high dose of vectors. Studies on site-directed mutation of surface-exposed tyrosine residues on serotype AAV capsid should yield novel serotype AAV vectors that may result in high-efficiency transduction in bone marrow HSCs *in vivo*, which could be a novel strategy for gene therapy in hematopoietic disease, particularly in FA.

828. In Vivo Gene Therapy of Hemophilia A Mice by Intra-Bone Marrow Injection of Lentiviral Vectors Containing a B-Domain Variant of Human Factor VIII

Xuefeng Wang,¹ Liping Chen,¹ Andy Chiang,¹ Peiqing Ye,¹ Carol H. Miao.¹

¹Department of Pediatrics, University of Washington, Seattle, WA;

²Seattle Children's Hospital Research, Seattle, WA.

Hematopoietic stem cells (HSCs) in the bone marrow are an ideal target for gene- and cell-based therapy of genetic diseases, because they are self-renewal and can differentiate into mature blood cells. Intrafemoral injection of lentiviral vectors (LVs) has been shown to effectively transduce bone marrow cells in mice without preconditioning. This approach avoids the difficulties encountered by *ex vivo* HSC gene transfer. In this study, we treated hemophilia A (HemA) mice with intra-bone marrow injection of 50 LVs containing factor VIII (FVIII) transgenes. Firstly, a transgene encoding green fluorescence protein (GFP) driven by a MND promoter was delivered by intra-bone marrow injection. 17% of Lin⁻C-kit⁺Sca-1⁺ cells express high level of GFP on day 7 post injection, which confirmed that direct intra-bone marrow injection of LVs can efficiently transduce primitive stem cells *in vivo*. Two LVs containing a B-domain variant of human factor VIII (hFVIII/N6) gene driven by two different promoters, a human elongation factor-1 promoter (E-LV) and a human megakaryocyte-specific GPIIb α promoter (G-LV) were constructed, respectively. In the HemA mice injected with either E-LV or high-titer G-LV, hFVIII was detected by western blot. In mice treated with G-LV, hFVIII protein can be detected in the platelets, but not in other lymphocytes or myeloids, indicating megakaryocyte-specific gene expression. As expected, the E-LV produced higher circulating FVIII protein levels and activities (ranged from 0.1-2U/ml) compared with G-LV with the same titer of viruses. The FVIII levels in LVs- treated mice fluctuated over time and in some mice, the loss of FVIII levels was due to the formation of anti-FVIII antibodies as measured by Bethesda assay and ELISA. The phenotypic correction of the HemA mice treated with a series of E-LV or G-LV doses was evaluated by tail clip assay. On day 14 post injection, there is an inverse correlation between the dosage of E-LVs or G-LVs and the blood loss in the treated HemA mice, indicating higher percentage of bone marrow cells might be transduced by higher titer viruses to generate higher-levels of hFVIII. However, on day 35 post injection, for the HemA mice treated with E-LVs, the blood loss decreased with increasing dosages of E-LVs, which

correlated with the formation of higher-titer anti-FVIII antibodies. On the other hand, for the HemA mice treated with G-LVs, the blood loss increased with increasing dosages of G-LVs except the mice treated with high-titer G-LVs, in which FVIII proteins produced in megakaryocytes leaked into circulation and induced anti-FVIII antibodies. Most interestingly, partial phenotypic correction of the mice treated with low to medium-titers of G-LVs were achieved and maintained at day 160. In order to induce long-term immune tolerance to the transgene hFVIII in the HemA mice treated with intra-bone marrow injection of E-LVs or G-LVs, different immunosuppressive agents are also investigated. These data indicate direct transduction of bone marrow cells by LVs has the potential to correct the HemA phenotype in unconditioned mice.

829. Evaluation of Liver Gene Therapy by Lentiviral Vectors in a Dog Model of Hemophilia B

Alessio Cantore,^{1,2} Martina Damo,¹ Marco Ranzani,^{1,2} Lucia Sergi Sergi,¹ Marina Radrizzani,³ Francesca Bellintani,³ Brian Brown,⁴ Eugenio Montini,¹ Timothy Nichols,⁵ Luigi Naldini.^{1,2}
¹San Raffaele Telethon Institute for Gene Therapy, Milan, Italy; ²Vita Salute San Raffaele University, Milan, Italy; ³MolMed, Milan, Italy; ⁴Mount Sinai Scholl of Medicine, New York; ⁵University of North Carolina, Chapel Hill.

Gene therapy holds promise as a cure for hemophilic patients. We previously demonstrated phenotypic correction of hemophilia B after a single administration of a microRNA-regulated lentiviral vector (LV) encoding FIX in a mouse model. We have now tested our gene therapy strategy in hemophilia B dogs, a spontaneous large animal model of the disease. We administered intraportally 1.5x10¹⁰ LV integration units to an 8-month old, 20 Kg hemophilia B dog. The infusion was well tolerated and uneventful with only minor self-limiting hepatocellular toxicity. At the current follow up (19 months post infusion) the dog is alive and well and has experienced no spontaneous bleeds for more than 1 year. Whole blood clotting time has been stably shortened and anti-canine FIX inhibitors tested negative. Quantitative measurement of canine FIX activity by aPTT showed 0.2% of normal levels. While these results are encouraging, FIX levels are still below the therapeutic threshold of 1% of normal. Since increasing the dose represents a challenge for the current manufacturing capacity of purified LV, it becomes crucial to maximize the LV potency (efficacy per dose). Moreover, while liver gene therapy by microRNA-regulated LV has proved safe in hemophilic mice, concerns remain regarding the risk of insertional mutagenesis and a careful assessment of the safest vector design still needs to be performed before clinical translation. In order to increase the potency of our LV for liver-directed gene therapy, we compared the performance of four different hepatocyte-specific promoters in terms of efficiency and safety. First, we assessed promoters' activity in hemophilia B mice. We then assessed the potential for gene transactivation at and around the integration site of the different promoters, taking advantage of site-specific integration into two genomic loci in hepatic cell lines. Our results show that whereas all the promoters have the potential of deregulating neighboring genes, the choice of a strong synthetic promoter such as the ET does not result in an increased risk of perturbation of endogenous gene expression. To assess the impact of this finding in vivo, we are monitoring the distribution of vector integrations over time in normal and tumor-prone mice. We then evaluated a codon-optimized FIX transgene to maximize protein output from a single expression unit. By this approach we achieved 4-fold higher clotting activity in hemophilia B mice treated with a matched dose of re-coded as compared to the original vector. Based on these results we are now treating a dog with the codon-optimized LV and we will report short-term follow up of this experiment. The preclinical evaluation of our strategy, which

includes feasibility, safety and efficacy evaluation in large animals and optimization of efficacy and safety in mice, will allow us defining the risk-benefit ratio of our strategy in view of clinical translation.

830. Targeting B Cells To Express a Tolerogenic Fusion Protein Using Pseudotyped Lentiviral Vectors Displaying a Single Chain Antibody Against Human CD20

Ai-Hong (Allan) Zhang,¹ Nana Owusu-Boaitey,¹ Sabrina Kneissl,² Christian J. Buchholz,² David W. Scott.^{1,3}
¹Center for Vascular and Inflammatory Diseases, University of Maryland School of Medicine, Baltimore, MD; ²Division of Medical Biotechnology, Paul-Ehrlich-Institut, Langen, Germany; ³Department of Medicine, Uniformed Services University of the Health Sciences, Bethesda, MD.

Antigen-specific tolerance induction is an important goal that has great potential in preventing or reversing undesirable immune responses. Previously, we utilized B-cell delivered gene therapy to achieve this goal in multiple mouse models for human autoimmune diseases and inhibitor formation to clotting factor VIII (FVIII) in hemophilia. In our model, syngeneic B cells are retrovirally transduced ex vivo to express an antigen-immunoglobulin G (IgG) fusion protein. Such B cells are highly tolerogenic upon adoptive transfer to naïve or even primed recipients. In the current study, we focus on creating a gene therapy vector that can directly target B cells in vivo, and aim to apply this to treat inhibitor formation to FVIII. We have taken advantage of the recently developed lentiviral vector re-targeting technology that utilizes a virus pseudotyped to display a anti-human CD20 single chain antibody. Because the C2 domain of FVIII is an important target for hemophilia inhibitors, we PCR amplified the C2 as a fusion protein with a murine IgG1 heavy chain. This was cloned upstream of the GFP in the pSEW transfer plasmid. The α CD20-C2-Ig-GFP lentiviral vector was generated by co-transfection of 293T cells with the transfer plasmid together with two other packaging plasmids. The generated HIV-1 lentiviral vector was pseudotyped with measles virus glycoproteins displaying a single chain anti-CD20 antibody. As a control, a chicken ovalbumin (OVA) expressing vector, α CD20-OVA-Ig-GFP, was also generated. As expected, the α CD20-C2-Ig-GFP supernatant efficiently transduced up to 70% of the CD20 expressing human B cell line, Raji cells, in terms of GFP expression analyzed by flow cytometry. In addition, the α CD20-C2-Ig-GFP vector selectively transduced B cells from human PBMC in vitro. Our next step is to infect mouse B cells expressing human CD20 transgene, which can be used to test the tolerance effect using this vector in hemophilia A (FVIII^{-/-}) mice that express human CD20 transgene. Our results could facilitate the clinical translation of the B-cell gene therapy for tolerance induction purpose (Supported by NIH grant AI035622 and HL061883 to DWS)

831. BAFF Inhibition by Exon Skipping in Sjögren's Syndrome

Nienke Roescher,^{1,2} Jelle Vosters,^{1,2} Ghada Al Saleh,³ Patrick Dreyfus,⁴ Sebastien Jacques,⁵ Luis Garcia,⁴ Gilles Chiochia,⁵ Antoine Francoise,³ Jean Sibilia,³ Paul Peter Tak,¹ Jay Chiorini,² Xavier Mariette,⁶ Jacques-Eric Gottenberg.³
¹Academic Medical Center, Amsterdam, Netherlands; ²National Institutes of Health, Bethesda; ³Strasbourg Hospital, Strasbourg, France; ⁴Centre National de la Recherche Scientifique, Paris, France; ⁵Cochin Hospital, Paris, France; ⁶Bicêtre Hospital, Paris, France.

In patients with Sjögren's syndrome (SjS), a disease mainly affecting the excretory organs, B-cell activating factor of the TNF family (BAFF) is increased. Inhibition of BAFF using antibodies or soluble receptors improves the course of animal models of

autoimmune diseases like arthritis and systemic lupus erythematosus. There are as yet no data available regarding the efficacy of BAFF inhibition on salivary gland (SG) inflammation and dysfunction in animal models of SjS. DeltaBAFF, a splice variant of BAFF, lacking one single exon compared with full length BAFF, is a physiological non-secreted inhibitor of BAFF. It prevents the intracellular binding of BAFF to other monomers of BAFF and APRIL, another important factor in the activation and survival of B cells, and inhibits BAFF secretion. The use of exon skipping to promote the expression of one shorter variant over the predominant full length mRNA has shown encouraging effects for the treatment of the monogenic disease Duchenne's myopathy and offers exciting therapeutic opportunities for many other diseases. We hypothesized that targeting the splicing of BAFF mRNA using exon skipping may improve features of SjS. Adeno-associated virus (AAV) and lentiviral vectors were constructed encoding U7 RNA with an antisense sequence targeting the exon of BAFF, which is absent in deltaBAFF. The expression of BAFF and deltaBAFF mRNA was assessed by PCR after infection of U937 and human lymphoma cell lines. Exon skipping-inducing AAV (AAV 161) or an AAV control vector were administered by retrograde cannulation of the submandibular glands of 19 NOD mice at the age of 10 weeks. Salivary gland function was assessed and expression of BAFF and SG inflammation was determined by quantitative immunohistochemistry 10 weeks post-treatment. In vitro transfection of U937 and human lymphoma cell lines with an exon skipping inducing lentivirus resulted in a marked decrease of BAFF and an increase of deltaBAFF mRNA and decreased BAFF protein in the supernatant. In vivo, BAFF mRNA was significantly reduced and deltaBAFF mRNA was increased. BAFF expression in the SG was significantly decreased (48% decrease in optical density per mm², p<0.05) in mice treated with AAV161. Stimulated saliva flow increased from 2.0 (in control mice) to 3.8 (AAV161) ul/20min/gram body weight, p<0.01). In addition, treatment with AAV161 decreased the average number of salivary gland lymphocytic infiltrates per cross sectional surface area of the SG (3.9 vs 2.4, p<0.05) and reduced the number of B (Δ 87%, p<0.05) and plasma cells (Δ 69%, p<0.01), compared with control mice. These results demonstrate the efficacy of BAFF inhibition on features of SjS in NOD mice and offer a rationale to evaluate BAFF inhibition in patients with SjS. This study also represents a proof of concept of the efficacy of modulating mRNA splicing in autoimmune diseases.

832. FIX Gain of Function Mutants Augment Hemophilia B Gene Therapy To Allow Minimal AAV Vector Exposure

Paul E. Monahan,¹ Tal Kafri,¹ William Hannah,¹ Tong Gui,¹ Junjiang Sun,¹ Thipparat Suwanmanee,¹ Scott W. McPhee,² R. Jude Samulski.^{1,2}

¹Gene Therapy Center, University of North Carolina at Chapel Hill, Chapel Hill, NC; ²Asklepios BioPharmaceutical, Inc., Chapel Hill, NC.

Blood coagulation factor IX (F.IX) deficiency (hemophilia B) is a severe bleeding disorder inherited as a monogenic X-linked disease. A liver-directed human clinical trial using serotype 2 AAV delivered doses of up to 4 x 10¹¹ vg/kg without effect; escalation to 2 x 10¹² vg/kg resulted in transient therapeutic circulating F.IX activity, followed by immune recognition and CTL-mediated elimination of AAV gene-corrected hepatocytes (Manno CS, et al. Nat Med 2006). Modifications of AAV vectors including use of self-complementing AAV genome form, optimized codon usage, and AAV capsid serotype change, have achieved expression using vector doses that fall well below the apparent threshold for immune recognition defined by the aforementioned clinical trial. Persistent expression in a current human clinical trial has now been reported using a dose that is 100 times lower than the dose associated with immune recognition

in the previous trial; nevertheless, careful *ex vivo* examination of T lymphocyte responses from asymptomatic patients receiving intermediate doses have demonstrated T cell activation by Interferon gamma Elispot (Nathwani A, American Society of Hematology 07December 2010). F.IX expression from even lower vector particle numbers could increase the safety profile of AAV therapy. Single amino acid substitutions at arginine 338 in the catalytic domain generate gain of function mutants with increased specific activity. We separately substituted either R338A, R338Q, or R338L into a codon optimized human factor IX cDNA and evaluated F.IX expression in tissue culture following plasmid DNA transfection of HEK 293t cells. Codon optimized (opt) F.IX sequences (including WTopt and each R338 substitution) expressed F.IX activity in media that was 7.1-9.2 times increased over the wild type and 5.1-6.6 times increased over FIX codon optimized sequences, resulting from improved F.IX specific activity as high as 10 times increased with the use of the R338LFIXopt cDNA. scAAV vectors for expression of optimized codon F.IX cDNA with or without the R338L substitution, using a short liver-specific transthyretin (TTR) promoter, were generated in AAV vectors and injected via the portal vein to F.IX^{-/-} mice. Mice receiving 1 x 10¹⁰ vg (~4 x 10¹¹ vg/kg) expressed 86.5 % of normal F.IX activity at 2 months post-transduction from the WToptimized cDNA and 290% normal from the R338LFIXopt. Additionally, we synthesized a R338LFIXcodonopt expression cassette containing the LP1 promoter/enhancer/intron sequence being used in the ongoing clinical trial and demonstrated the same improvement in F.IX expression. Specific activity of F.IX expressed in vivo ranged from ~2200-3800 IU/ml (normal F.IX specific activity is ~200 IU/ml). Finally, we have documented a predictable dose-response for augmented F.IX activity expression across a range of doses from 4 x 10¹¹ vg/kg to as low as 1x 10¹⁰ vg/kg using the scAAV.TTR. R338LFIXopt vector, recommending application of F.IX gain of function mutants to achieve phenotypic correction while minimizing exposure to viral vectors.

833. Valproic Acid-Mediated Retention of High Level Expression of Potential Hematopoietic Stem Cell Markers Does Not Correlate with Enhancement of Engraftment

Randall K. Merling,¹ KuyLee Han,¹ Colin L. Sweeney,¹ Hongmei Wang,¹ Joseph Marcotte,¹ Gilda F. Linton,¹ Sherry M. Walker,¹ Uimook Choi,¹ Harry L. Malech.¹

¹Laboratory of Host Defenses, NIAID, NIH, Bethesda, MD.

Developing maneuvers that prevent loss of early hematopoietic stem cell (HSC) markers while allowing *ex vivo* expansion may be a helpful strategy for improving cell and gene correction therapies. Human mobilized peripheral blood stem cells (PBSC) are capable of permanently reconstituting hematopoiesis when used for clinical transplant of patients. However, *ex vivo* gene transfer into these cells generally requires a period of *ex vivo* culture, during which time markers characteristic of HSC are lost and engraftment potential progressively decreases over time in culture. Valproic acid (VPA) is a histone deacetylase inhibitor reported to promote the proliferation and self-renewal of HSCs. In this lentiviral vector gene transfer study, 0.2 mM VPA treatment of cultures of human PBSC caused these cells to retain early markers of pluripotency such that at 6 days of culture, VPA treated cultures demonstrated significant retention of the following surface markers compared to control 6 day cultures: CD34 (1.4 -fold), CD90 (3.7 -fold), CD117 (1.2 -fold), and CD133 (2.8 -fold). VPA also enhanced expression of HOXB4 (1.8 -fold for 0.2mM VPA, 2.8 -fold for 0.4mM VPA), a gene that has been reported to be important for maintenance of hematopoietic stem and progenitor cells. Despite significant retention of early markers we found no increase in engraftment of VPA treated 6 day human cultured PBSC compared to control 6 day cultured PBSC when engrafted in the NOD/SCID mouse

xenograft model. However, unexpectedly we found a significant increase in lentivector gene marking of VPA treated transduced PBSC compared to the control (86% versus 64% and 4 –fold increase in copy number). VPA treatment of human PBSC results in retention of primitive markers without enhancing engraftment potential, but this effect does enhance lentivector transduction of human PBSC by a mechanism yet to be determined.

Oligonucleotide & RNAi Therapeutics II

834. Specific Targeting of Prostate Cancer by an Aptamer-siRNA Chimera

Craig A. Howell,¹ William M. Rockey,¹ Xiu Y. Liu,¹ Daniel Vaena,¹ Paloma H. Giangrande.¹

¹Internal Medicine, University of Iowa, Iowa City, IA.

Prostate cancer is the most diagnosed cancer among men in the United States and is the second leading cause of cancer death, with approximately 27,000 deaths from the disease each year. This is partially due to the lack of effective targeted methods capable of treating metastatic disease. Because cancer cells are highly proliferative, most current methods of cancer therapy globally target proliferating cells (including normal, non-cancerous cells). This results in dosage limiting, toxic side effects. Prostate specific membrane antigen (PSMA) is a prostate cancer-specific antigen that is expressed by virtually all prostate cancers and its expression is further increased in poorly differentiated, metastatic, and hormone refractory cancers. This makes PSMA a very attractive target for both prostate cancer imaging as well as therapy. We have previously demonstrated targeting of cancer-specific cytotoxic siRNAs to prostate cancer cells expressing PSMA with a PSMA-specific synthetic RNA ligand (aptamer). Despite this initial success, therapeutic efficacy in vivo, following systemic administration, was demonstrated only with in vitro transcribed material. Clinical translation of this approach requires aptamer-siRNA conjugates that are generated using chemical synthesis. Towards this end, we have obtained chemically-synthesized, pre-clinical grade conjugates from TriLink BioTechnologies and performed efficacy studies in prostate cancer cells in cell culture. The chemically synthesized chimeras internalized into PSMA expressing cells and not into cells that lack PSMA expression, as detected via qRT-PCR. Additionally, qRT-PCR analysis revealed reduction of target mRNA levels only in PSMA expressing cells. Furthermore, pharmacokinetics and biodistribution studies of the chemically-synthesized conjugate have been performed in our murine models demonstrating increased circulatory half-life upon addition of an inert PEG moiety and indicate accumulation primarily in xenograft tumors that express human PSMA. Finally, we have assessed stability of the conjugate in human plasma, and no degradation was detected via qRT-PCR or electrophoretic analysis. Further analysis will include a murine metastatic model involving intracardiac injection of PSMA expressing prostate cancer cells. We will then determine if the synthetic chimera reduces tumor size in PSMA expressing secondary tumors.

835. Cell Penetrating Peptide-Mediated Systemic siRNA Delivery to the Liver

Jun Yamauchi,¹ Yasuhiro Hayashi,¹ Khalil A. Ikramy,¹ Hidetaka Akita,¹ Kazuaki Kajimoto,¹ Hideyoshi Harashima.¹

¹Faculty of Pharmaceutical Sciences, Hokkaido University, Sapporo, Japan.

Cell-penetrating peptide (CPP) is one of the most attractive drug delivery tools for efficient intracellular delivery of biomolecules, however, CPP mediated systemic in vivo siRNA delivery have not been uniformly successful. In the present study, octaarginine (R8) peptide-mediated systemic siRNA delivery system was developed

using MEND (Multifunctional Envelope type Nano Device) as a cargo. R8-MEND (lipid composition: STR-R8/DOPE/Cholesterol=18.5/77.5/4.5) rapidly and selectively accumulated in the liver. From confocal imaging analysis, Cy3-labeled siRNA loaded nanoparticles rarely colocalize with lysosomal compartment, suggesting that R8 peptide can efficiently deliver siRNA to the cytosol in hepatocyte. When R8-MEND containing SR-BI (scavenger receptor class B, member 1) siRNA was delivered to C57BL/6 mice (6 week, female) by using a single injection via tail vein, dose-dependent reduction in SR-BI mRNA was observed with minimum liver toxicity (45% silencing observed at the dose of 25 µg per mouse, and 75% silencing achieved at the dose of 100 µg). These results suggest that R8-MEND can be safely and effectively used to systemically deliver siRNA to the liver, and open the way to develop more efficient CPP-mediated siRNA delivery system for wide application both in experimental biology and molecular medicine.

836. Subcutaneous Delivery of Hepatocyte Targeted Sub-50 nm Nanoencapsulated siRNA Mediates Gene Silencing

B. T. Kren,¹ D. Tolbot,² V. Korman,² G. M. Unger.²

¹University of Minnesota, Minneapolis, MN; ²GeneSegues, Inc., Chaska, MN.

Modulating gene expression via RNA interference (RNAi) by siRNAs has reinvigorated nonviral delivery of nucleic acids (NA). Treatment of chronic disease by RNAi requires achieving and maintaining silencing of a specific target gene transcript, requiring a patient-friendly delivery method for the repeat administration of siRNAs. Subcutaneous (sq) delivery is a desirable method for this goal, yet 2 major barriers have hindered this approach, the sequestration of the NAs at the injection site and in endosomes with subsequent degradation in the target cells. The novel nonviral sub-50 nm (s50) crystallized capsule delivery system developed by GeneSegues can use any appropriate targeting protein, peptide or carbohydrate for the capsule shell. This specifies the receptor-mediated uptake of the capsule by the specific cell-type in vivo via the ligand used. The capsule's 10-25 nm size, crystallized-structure and neutral-charge mediate efficient in vivo penetration of tissues, and cellular uptake via the non-endosomal lipid rafts pathway, delivering the NA cargo intact to the nucleus and cytoplasm of the target cell. We previously showed asialoorosomucoid (ASOR) s50 capsules mediate hepatocyte specific delivery of plasmids in vivo following intravenous (iv) delivery (JCI, 2009). In this study we show that sq delivery of s50 ASOR encapsulated unmodified siRNAs targeting coagulation factor VII (FVII) at a dose of 1 mg/kg resulted in significant FVII mRNA transcript with the nadir observed 2 days post-injection reflecting a 52% ± 4% decrease in FVII mRNA. By day 4, transcript levels returned to 90% of control levels. An ASOR s50 encapsulated 20 mer single stranded (ss) RNAi chimeric DNA/RNA (5'-14 phosphodiester DNA residues followed by 6 2'-O-methyl RNA bases) having the same sequence as the siRNA guide-strand resulted in a 49% ± 5% decrease in FVII mRNA 2 days post-injection at 0.5 mg/kg sq. The RNAi treated FVII transcript levels increased by day 4 to 70% of untreated values. At day 3 after 0.5 mg/kg sq dosing, a 15% and 30% reduction in the FVII mRNA levels were observed with the siRNA and RNAi, respectively. Thus at equal dosing, the RNAi targeting FVII mediated a larger and more persistent decrease in the FVII transcript. This is consistent with our in vitro data indicating the ss RNAi molecule engages both the RNase H and Ago2-RISC mediated silencing pathways when delivered using the novel s50 nm capsule. Targeting ApoB using an modified siRNA or the same ss chimeric RNA guide-strand structure in ASOR s50 capsules sq gave similar results, yet decreased transcript levels persisted for a longer period. In conclusion this data indicates that sq administration of siRNAs at in s50 nm ASOR capsules mediates efficient silencing of

hepatocyte expressed transcripts for a duration of ≥ 4 days. Moreover, the novel ss chimeric RNA/DNA guide-strand chemistry was shown to be equally efficacious in silencing different target genes as their respective siRNAs. This suggests that sq administration s50 ASOR encapsulated NAs targeting hepatocyte-expressed genes every 3 days may potentially achieve the persistent gene-silencing necessary for treatment of chronic disease in a clinically relevant manner.

837. Improving the Specificity of RNAi-Based Therapeutics for Huntington's Disease

Ryan L. Boudreau,¹ Jodi L. McBride,² Ryan M. Spengler,¹ Beverly L. Davidson.¹

¹Internal Medicine, University of Iowa, Iowa City, IA; ²Division of Neuroscience, Oregon Health and Science University, Beaverton, OR.

RNA interference (RNAi) provides a promising approach for the treatment of several human diseases. However, the safety of RNAi-based therapies remains a concern. High levels of exogenously supplied RNAi substrates may cause cellular toxicity by saturating the endogenous RNAi machinery, thus disrupting natural microRNA (miRNA) biogenesis and function. Also, inhibitory RNAs have the potential to bind to and regulate unintended mRNA targets, an effect known as off-target gene silencing. Off-targeting primarily occurs when the seed region (nucleotides 2-8 of the small RNA) pairs with sequences within 3' UTRs of unintended mRNAs and directs translational repression of those transcripts. To address these concerns, we have undertaken methods to improve the safety of RNAi expression vectors for *in vivo* applications. We previously compared the efficacy and safety of short-hairpin RNA (shRNA) and artificial miRNA expression vectors *in vitro* and *in vivo*. We found that shRNAs are more potent but induce toxicity in cell cultures and in mouse brain, whereas artificial miRNAs are expressed at lower levels and display better safety profiles, while maintaining potent gene silencing capabilities. Next, we focused on sequence selection to further improve the safety of therapeutic artificial miRNAs. To date, most therapeutic RNAi sequences are primarily selected to optimize gene silencing efficacy, and later evaluated for safety. However, as inhibitory RNAs transition to clinical trials, the issue of safety remains most critical. Here, we prioritize safety when selecting inhibitory RNA sequences. As means to further improve our RNAi-based strategy to treat Huntington's disease (HD), a dominant neurodegenerative disease caused by the toxic expression of mutant huntingtin, we designed a new panel of artificial miRNAs which upon processing would yield human huntingtin-specific siRNAs which preferentially load the antisense strand. Most importantly, these antisense strands contain seed sequences that are complementary to 6-mers that are present at low frequencies within all known human 3'UTRs. Data supports that seed sequences with high off-targeting potentials (i.e. many complementary 6-mers throughout the 3'UTRome) are indeed more toxic. This new panel of artificial miRNAs was screened for huntingtin silencing efficacy in 293 cells. We found two exciting new therapeutic candidates (miHDS1 and miHDS2) which show potent huntingtin silencing. We have generated AAV vectors expressing these new candidates and are currently evaluating silencing efficacy and safety in wild-type and BACHD mice and non-human primate brain. Furthermore, we have performed microarray analysis to assess the off-targeting potential of these "safe" sequences, relative to our previous lead candidates (miHD2.4 and miHD8.2). Our results support that seed-related off-targeting can be significantly attenuated (5 to 10-fold) by applying "safe" seed guidelines to inhibitory RNA design, a finding with important implications for therapeutic RNAi development.

838. Flexible Cationic Lipids for siRNA Delivery

Jeff Sparks,¹ Gregory Slobodkin,¹ Richard T. Congo,¹ David Ulkoski,¹ Majed Matar,¹ Angela Rea-Ramsey,¹ Casey Pence,¹ Jennifer Rice,¹ Diane McClure,¹ Kevin J. Polach,¹ Elaine Brunhoeber,¹ Leslie Wilkinson,¹ Khurshed Anwer,¹ Jason G. Fewell.¹

¹EGEN, Inc., Huntsville, AL.

RNAi has emerged as a powerful method to reduce the production of gene products related to disease. Therapeutic development has been limited, however, by inefficient delivery of the nucleic acid to target cell types *in vivo*. We are developing a novel class of symmetrical, structurally flexible synthetic carriers that are efficient in delivering siRNA *in vitro* and *in vivo*. The advantage of these cationic lipid based systems is that functionalization can provide biocompatibility while simultaneously maintaining a high level of transfection activity. Here we present data on the utility of two distinct core lipids. Both of these unique cationic lipids have the ability to self-assemble with siRNA into liposomal nanoparticles as encapsulates or complexes. One of the lipids (Crossamine) is characterized by the availability of two functionalizable groups extending from a single branch point which connects the head group to the two lipid tails. Depending on the method of attachment of surface agents to the lipid head, one or both amine groups may be available, after ligand attachment, to remain cationic, allowing the entire liposomal unit to retain its optimal lamellar arrangement. This system when formulated with siRNA results in >90% target transcript knockdown in a variety of cell lines *in vitro*, including difficult to transfect suspension cell lines. The second lipid (Staramine) has a primary amine which extends to the surface of the liposome and is available for ligand attachment. In addition, the lipid contains an internal tertiary amine group that serves as the branching point within the head group and is able to provide buffering capacity that can enhance endosomal release. Staramine was modified by covalent attachment of mPEG, which when used in a liposomal formulation with siRNA, was shown to reduce particle aggregation in solutions containing serum. Additionally, to demonstrate the structural flexibility of the core lipids to provide the tools for the production of actively targeted nanoparticles, polysaccharide and peptide ligands were also attached to Staramine via PEG linkers. Systemic administration of mPEG modified Staramine nanocomplexes into mice indicated significant reduction in acute toxicity compared to non-PEGylated nanocomplexes as measured by serum chemistry. Furthermore, PEGylated Staramine nanoparticles containing siRNA targeting the caveolin-1 (Cav-1) transcript caused a reduction of the Cav-1 transcript by 50% specifically in lung tissue after 48 h compared to non-coding siRNA. The high level of target gene knockdown in the lung demonstrates the potential for the application of RNAi therapeutics for pulmonary disease.

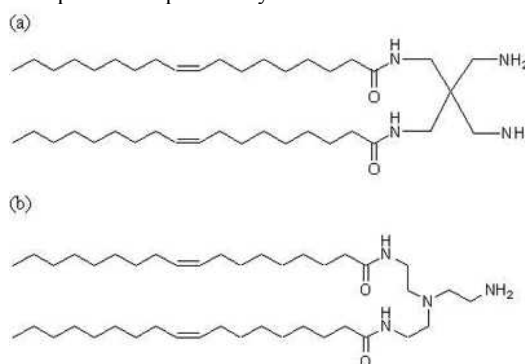

Figure 1. Structures of flexible cationic lipids (a) Crossamine and (b) Staramine.

839. Smart Nanoparticle for MMP-7 Proximity-Activated siRNA Delivery

Hongmei Li,¹ Christopher E. Nelson,¹ Todd D. Giorgio,¹ Craig L. Duvall.¹

¹Department of Biomedical Engineering, Vanderbilt University, Nashville, TN.

Introduction: Chemotherapy of primary tumors can lead to the emergence of multiple drug resistant (MDR) cancer cells. MDR cells overexpress P-glycoprotein (P-gp) drug efflux pumps that desensitize them to chemo, and they can form metastases that drastically worsen patient prognosis. Small interfering RNA (siRNA) presents a powerful tool for gene silencing, and P-gp knockdown may be a robust approach for reversing MDR and saving patient lives. However, P-gp is also important to function of many normal cell types, making tumor-specific delivery requisite for this to be a clinically-feasible approach. MMP-7 has a role in tissue remodeling and cell migration, and its overexpression is a hallmark of metastases. Here, we have incorporated an MMP-7-responsive element onto a previously-tested smart polymeric nanoparticle (SPN). The SPN has a cationic corona for siRNA condensation and a pH-responsive, endosomolytic core that mediates efficient siRNA cytosolic delivery. The current SPN design selectively enters cells only once it has been activated by MMP-7, and thus employs “proximity-activated targeting” (PAT) (Fig 1).

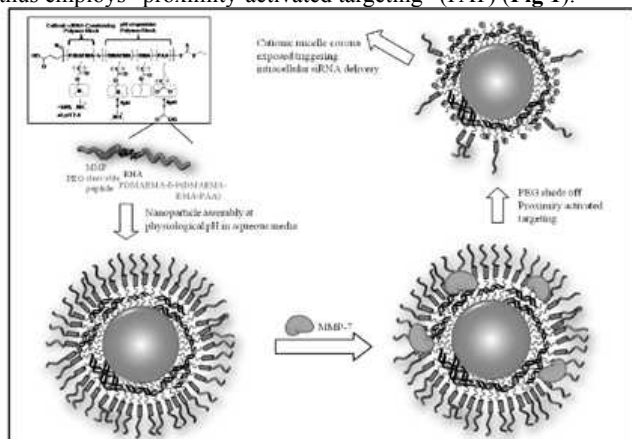

Figure 1. MMP-7 Proximity-Activated siRNA-Delivery Vehicle. The top inset shows the composition of the “smart” polymer that forms the SPN foundation for the multifunctional PAT-SPN. The base SPN polymer enables siRNA electrostatic loading and pH-responsive endo-biosomal escape activity. The complete PAT-SPN builds off of the SPN base and incorporates PEG shielding removable in MMP-7-rich environments (i.e. breast cancer metastases). MMP-7 activity exposes the cationic component of the SPN polymer, triggering cell uptake, pH-dependent endosomal escape, and cytosolic siRNA delivery.

Methods: The N-terminus of an MMP-7 cleavable peptide (COOH-CGSYLSLPV-NH₂) was conjugated to a reversible addition-fragmentation chain transfer (RAFT) chain transfer agent (CTA) through an N-hydroxysuccinimide to form a macroCTA. Conjugation was confirmed by GPC and HPLC-MS, and the macroCTA was used to polymerize a peptide-functionalized diblock copolymer (CGSYLSLPV)-P(DMAEMA)-b-P(DMAEMA-BMA-PAA). Molecular mass and polydispersity (PDI) of polymers were characterized by gel permeation chromatography (GPC). TEM and qRT-PCR were used to verify SPN architecture and siRNA activity, respectively. **Results and Conclusions:** A well-controlled diblock copolymer (PDMAEMA, $M_n = 13.0$ kDa, PDI= 1.1; diblock $M_n = 24.0$ kDa, PDI= 1.4) was synthesized via RAFT using the peptide macroCTA (Fig 2A). TEM imaging of the SPNs showed presence of micelles (Fig 2B), and a PCR study indicated that approximately 75% knockdown was achieved using SPNs to deliver siRNA against the model gene GAPDH (Fig 2C). Current work involves conjugation of a maleimide-PEG (5kDa) to the thiol in the terminal cysteine of the MMP-7-cleavable sequence. This will shield the cationic corona of the base SPN, abrogating its nonspecific charge-driven internalization, and this “shield” will be reversed when the PAT-SPN is activated by MMP-7 cleavage in metastatic lesions. Future work will involve

validation of the MMP-7-specific activation of the carrier and testing for P-gp knockdown in MDR breast cancer cell lines.

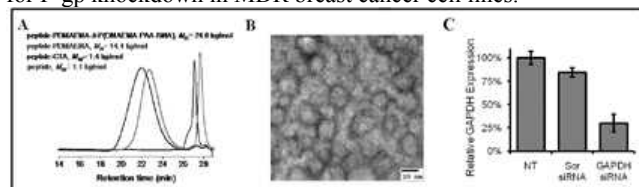

Figure 2. (A) GPC spectra for the MMP-7-cleavable peptide before (green) and after (blue) functionalization with the polymer chain transfer agent (CTA). This peptide-CTA was utilized to grow P(DMAEMA) (red) and the P(DMAEMA)-b-P(DMAEMA-BMA-PAA) (black) diblock polymer that composes the SPN (PECylation step pending). (B) TEM image of SPNs illustrates ~30 nm (dehydrated) micelle size (C) ~75% silencing of model gene GAPDH achieved using SPN to deliver GAPDH-siRNA relative to scrambled (SC) siRNA or no treatment (NT).

840. Experimental and Computational Design of Combinatorial RNAi Therapies Against HIV

Priya S. Shah,¹ Sharon Aviran,² Nhung P. Pham,¹ Adam P. Arkin,² David V. Schaffer.¹

¹Chemical and Biomolecular Engineering, University of California at Berkeley, Berkeley, CA; ²Bioengineering, University of California at Berkeley, Berkeley, CA.

As an approach that targets RNA sequence rather than protein structure, RNAi-based gene therapy offers the potential for faster drug development and fewer side effects for treating HIV infection. However, the very sequence-specificity that gives RNAi-based gene therapies these advantages also makes the therapy susceptible to HIV escape, and the development of resistance to RNAi has been extensively documented. Combinations of RNAi gene therapies have been suggested as a means to avoid resistance in a manner analogous to highly active anti-retroviral therapy (HAART), yet engineering these combinations can be difficult. Gene therapy offers the unique ability to implement different combinatorial strategies, ranging from compartmentalized expression of individual shRNAs in different cell populations, followed by pooling these populations, to engineering a single vector to express the complete combination in every cell. However, it is unclear how successful different combinatorial RNAi strategies may be for suppressing HIV and addressing viral escape. Here, we apply an integrated computational and experimental system to investigate how the nature of a combinatorial gene therapy may affect its efficacy. Using the simplest combination of two shRNAs targeting HIV, we demonstrate that two shRNA monotherapies that show similar abilities to inhibit HIV short term replication exhibit markedly different rates of viral escape in long-term cultures, and these long-term differences can only be identified in heterogeneous cultures including protected and unprotected cells. Interestingly, when the two shRNAs are combined, we observe that a compartmentalized combination showed levels of long-term efficacy similar to that of a conventional combination in vitro. Such a simplified delivery strategy may facilitate the development of combination gene therapies. Upon sequencing cultures that showed active HIV replication after long-term culturing in the presence of RNAi, we found several mutations located within the 21-nucleotide regions targeted by RNAi. Surprisingly, we identified many more mutations within the HIV Long Terminal Repeat (LTR), many in regions known to regulate HIV gene expression, such as NF-kappaB, Sp1 and LBP transcription factor binding sites. We previously showed that such compensatory mutations in the HIV LTR can act to increase gene expression and overwhelm the RNAi pathway with a large number of HIV transcripts. This large dataset further supports our previous finding that the LTR serves as a rich regulatory domain that can be manipulated by the virus to deal with various therapeutic pressures in an indirect and compensatory manner even when viable mutations with the targeted region exist. Our findings suggest that many combinatorial strategies are likely to be successful in short term suppression of HIV; however, mutations both inside and outside the target region must likely be considered when designing therapies for long term suppression.

841. Engineered Scaffold for Sustained, Local siRNA Delivery

Christopher E. Nelson,¹ Mukesh K. Gupta,¹ Elizabeth J. Adolph,² Scott A. Guelcher,² Craig L. Duvall.¹

¹Biomedical Engineering, Vanderbilt University, Nashville, TN;

²Chemical Engineering, Vanderbilt University, Nashville, TN.

Introduction: siRNA has tremendous therapeutic promise, and there are many applications where sustained, tunable siRNA delivery to a local pathological site is desirable. We have synthesized polymeric micellar nanoparticles (NPs) that possess a cationic corona that condenses siRNA and a “smart”, pH-responsive core that mediates endo-lysosomal escape. Here, we present a technological platform for sustained, tunable delivery of siRNA-loaded “smart” NPs from a polyurethane (PUR) scaffold that provides a porous, biodegradable, and biocompatible tissue template. **Methods:** (DMAEMA64-b-(DMAEMA36-co-PAA36-co-BMA72) was synthesized by RAFT polymerization. The polymer was dissolved in EtOH and transferred to PBS to trigger assembly of micelles onto which siRNA was electrostatically condensed at varied charge ratios (CR). Micelles were examined with TEM and DLS. NP-mediated gene knockdown and cytocompatibility were validated in NIH3T3 fibroblasts and RAW 264.7 macrophages using PCR and an LDH assay, respectively. NP-loaded PUR scaffolds were fabricated by reacting polyester triols with lysine triisocyanate in the presence of a catalyst, water (blowing agent), and lyophilized NPs. Confocal microscopy was used to visualize the distribution of fluorescent siRNA within the scaffold. Release kinetics of fluorescent siRNA containing NPs from PUR in PBS at 37C were tracked for 21 days, and NP size/morphology in the releasate was also evaluated by TEM. **Results:** SEC and NMR confirm an 11.9kDa DMAEMA 1st block with a total diblock size of 31.4kDa. Complete siRNA condensation was verified to occur at CR of 2:1 or greater by the agarose gel retardation assay. DLS and TEM indicated that siRNA-loaded NPs at a 4:1 CR had a diameter of 58.5±10.6nm, and Zeta potential for NPs was 16.7±6.9 mV. In studies where siRNA against the model gene GAPDH was used, NPs were able to mediate approximately 80% gene-specific silencing with no significant cytotoxicity (Fig. 1A). Confocal microscopy indicated homogenous distribution of fluorescently labeled siRNA-containing NPs throughout the PUR scaffold (Fig. 1i1), and NP release from PUR scaffolds showed an initial burst release followed by a sustained release out to 21 days (Fig. 1B). TEM of releasate confirmed the presence of polymer micelles indicating the stability of NPs to PUR fabrication (Fig 1i2). **Conclusion:** Here we present a novel PUR-NP scaffold for sustained, local siRNA delivery that could be used to efficiently transfect cells seeded onto the scaffold in vitro or cells infiltrating the porous material in vivo. The siRNA NPs have achieved gene specific knockdown in multiple cell lines and are released intact from PUR for 21 days. Ongoing studies will verify bioactivity of NPs released from PURs and further develop this technology toward specific pathological applications.

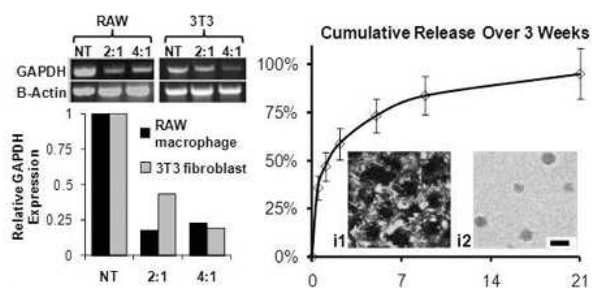

Figure 1:

A) GAPDH mRNA knockdown by RT-PCR using NPs at CRs of 2:1 and 4:1.

B) Release kinetics of NPs from PUR.

i1: Confocal image of PUR with fluorescent siRNA

i2: TEM of NPs in releasate (scale=100nm)

842. RNAi Therapy for Polyglutamine Expansion Disorders

Pavitra Narasimha,¹ Ryan L. Boudreau,² Ryan M. Spengler,³ Beverly L. Davidson.⁴

¹Interdisciplinary Program in Genetics, University of Iowa, Iowa, IA; ²Internal Medicine, University of Iowa, Iowa, IA; ³Internal Medicine, University of Iowa, Iowa, IA; ⁴Internal Medicine, Neurology, Physiology & Biophysics, University of Iowa, Iowa, IA.

We are investigating RNA interference (RNAi) therapy for the autosomal dominant polyglutamine (polyQ) expansion disorders SCA2 and SCA7. Both SCA2 and SCA7 show Purkinje cell degeneration, but SCA7 also demonstrates retinal cone-rod dystrophy. Using our prior experience in developing artificial miRNAs for directed gene silencing (Boudreau et al., 2009), we designed miR-based vectors for silencing mouse and human ataxin-7 (ATXN7) or ataxin-2 (ATXN2). For ATXN7, RNAi triggers were designed for allele-specific and non-allele specific silencing, the former artificial miRNA targeting a SNP (miSNP) common among South African patients. The miR vector candidates and a scrambled control were tested for knockdown of human-ATXN7-92Q (myc-tagged human ATXN7 with a pathogenic repeat of 92 polyQs) in vitro in HEK293 cells. Significant knockdown of ATXN7 protein was seen with miS4 and miSNP by western blot. To test knockdown of mouse ATXN7N2A (neuroblastoma) cells were used. MiS4 showed a significant ($P < 0.05$) ~40% knockdown of ATXN7 mRNA, while miSNP vector did not, demonstrating its allele-specificity. Similarly, we designed and tested artificial miRs for ATXN2. Artificial miR vectors expressing safe sequences (miS2-5) and a scrambled control were tested for knockdown of ATXN2 in vitro in HeLa cells and mouse N2A cells, which endogenously express human and mouse ATXN2, respectively. In HeLa cells, miS2 and miS5 transfected showed a significant ($P < 0.05$) knockdown efficiency of ~50% and ~40% respectively. In N2A cells miS2 and miS5 transfected cells showed a significant ($P < 0.05$) knockdown efficiency of 30% and 70% respectively. The ATXN7 and ATXN2 targeting vectors are being tested in vivo in the cerebellum, and in the case of miR.Sca7S4 and miR.Sca7SNP, also in the retina.

843. Combining Tumor-Targeting, Gene Silencing, and siRNA-Mediated Cytokine Induction in a Viral Capsid-Derived Nanoparticle

David Chu,¹ Jae Youn Hwang,¹ Jay Lubow,¹ Altan Rentsendorj,¹ Lali Medina-Kauwe.¹

¹Biomedical Sciences, Cedars-Sinai Medical Center, Los Angeles, CA.

We have previously shown that a recombinant viral cell-penetration protein, HerPBK10, engineered to bind the human epidermal growth factor receptor (HER), can deliver genes and drugs to tumors displaying elevated HER2 subunit, which associates with aggressive tumors that resist standard therapies, and whose silencing can trigger apoptosis. Elevated HER2 also confers enhanced receptor affinity for the ligand, heregulin, from which the 'Her' portion of HerPBK10 is derived. Our previous studies show that HerPBK10 is non-immunogenic and non-inducing to tumor growth in vitro and in vivo. Here we have assembled HerPBK10 with siRNA in a two-component system called HerSi that forms serum-stable nanoparticles (≤ 10 nm diameter), targets HER2+ but not HER2- tumor cells in vitro, and elicits target cell death that correlates with target-gene (HER2) silencing. Systemic intravenous delivery of HerSi in a preclinical model of HER2+ breast cancer resulted in tumor-preferential accumulation and retention compared to free siRNA, and yielded tumor-growth ablation and/or shrinkage that associated with reduced HER2 expression, suggesting that responsive tumors underwent gene silencing. Currently, we show in vitro that tumor-targeted toxicity can be enhanced by using modified siRNA that elevates interferon, thus increasing the cytotoxic potency of siRNA targeting through both gene silencing and cytokine induction in target cells.

844. The Effect of Nanofiber Topography on Astrocyte Behavior In Vitro and the Potential Application for siRNA Delivery for CNS Regeneration

Haoqing Cao,¹ Guillaume Marcy,² Eyleen Lay Keow Goh,² Jun Wang,³ Sing Yian Chew.¹

¹School of Chemical and Biomedical Engineering, Nanyang Technological University, Singapore, Singapore; ²Duke-NUS Graduate Medical School, Singapore, Singapore; ³Hefei National Laboratory for Physical Sciences at the Microscale and School of Life Sciences, University of Science and Technology of China, Hefei, Anhui, China.

The physiology of the nervous system presents great challenges to nerve repair after injury. In particular, astrocytes serve as major contributors to limited axonal regrowth through the secretion of growth inhibitory chemicals and the formation of glial scar. Unfortunately, detailed understanding on astrocyte behavior and interaction with microenvironmental signals remain limited. In this study, nanofiber topographical effects on astrocyte phenotypic changes, including the uptake of small-interfering RNA (siRNA) and the corresponding gene-silencing efficiency, were investigated to gain insights to construct a novel scaffold to deliver siRNA for CNS regeneration. Poly(caprolactone-co-ethylene ethylene phosphate) (PCLEEP) nanofibers (diameter = 655 ± 11 nm) were fabricated by electrospinning and PCLEEP films were prepared by solvent-casting as a two-dimensional (2D) control for primary rat astrocyte culture. Cell proliferation rate as measured by EdU assay indicated significantly lower EdU incorporation rate on nanofibers than on films (18.9% vs. 40.2%, $p < 0.05$). Meanwhile, TUNEL assay demonstrated a higher apoptosis rate on fibers than on films (11.9% vs. 7.1%, $p < 0.05$). Astrocytes on nanofibers adopted a smaller cell area and exhibited an elongated shape as compared to the fully stretched morphology on films (figure 1), as revealed by GFAP immunostaining. However, the insignificant change in vimentin and GFAP expression levels as

shown by western blotting implied a quiescent state of astrocytes despite morphological changes in respond to nanofibers. The uptake of siRNA was visualized by delivering Cy5-labeled oligonucleotide (Cy5-ODN) into astrocytes (figure 2), and cellular uptake was ~ 1.5 fold more efficient on 2D substrates. In contrast, GAPDH siRNA transfection showed a slightly higher silencing efficiency on nanofibers than on 2D substrates (79% vs. 73%). Altogether, our results suggest that nanofiber topography suppressed astrocytes growth and enhanced apoptosis. Together with the observation of enhanced siRNA gene knockdown, electrospun nanofibers may serve as potential scaffolds for gene silencing applications to promote CNS regeneration.

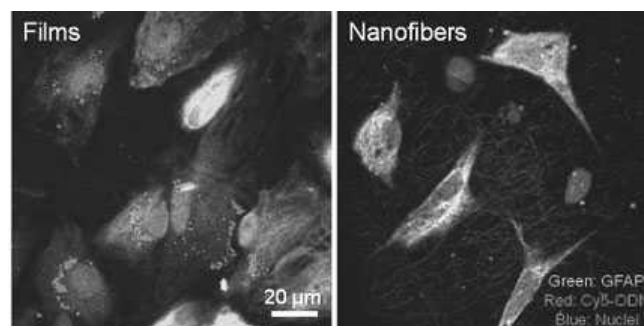
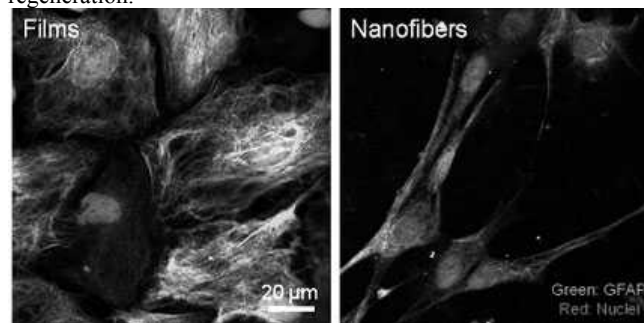

845. Inhibition of PCBP2 Reverses the Fibrogenic Effect of Alcohol on Hepatic Stellate Cells

Ravi S. Shukla,¹ Shaoying Wang,¹ Kun Cheng.¹

¹Pharmaceutical Sciences, School of Pharmacy, UMKC, Kansas City, MO.

Alcoholic liver fibrosis is characterized by excessive accumulation of type I collagen in the liver. The increase of type I collagen in alcoholic fibrosis is primarily due to the increased half-life of its mRNA upon the binding of α -complex protein-2 (α CP₂, encoded by the PCBP2 gene) at the 3' ends in activated hepatic stellate cells (HSCs). In the present study, we intended to evaluate whether the inhibition of PCBP2 reverses the fibrogenic effect of alcohol on hepatic stellate cells. Real time RT-PCR, western blot and immunofluorescence staining have been conducted to examine the fibrogenic effect of ethanol on α CP₂ and type-I collagen in HSCs. We have found that alcohol can enhance the expression of α CP₂ as well as type-I collagen in HSCs. Numerous siRNAs targeting different regions of the PCBP2 mRNA were designed, and the silencing effects were screened in HSCs. One of the most potent siRNA was chosen for the bioactivity studies in HSCs. PCBP2 siRNAs reversed the up-regulated effect of alcohol on PCBP2 and type I collagen. Moreover, mRNA decay assay demonstrated a markedly enhance decay rate of the collagen $\alpha 1(I)$ mRNA in HSC cells treated with the PCBP2 siRNA. In summary, blocking PCBP2 expression using siRNA is a potential therapeutic approach to decrease the stability of collagen $\alpha 1(I)$ mRNA and finally reverse the accumulated type I collagen in alcoholic liver fibrosis.

846. Expanded CAG Repeats Enhance the Production of a Pathogenic Cav2.1 Splice Variant That Can Be Selectively Targeted Using RNAi

Wei-Ling Tsou,³ Bing-Weng Soong,³ Henry L. Paulson,² Edgardo Rodriguez-Lebron.¹

¹Internal Medicine, University of Iowa, Iowa City, IA; ²Neurology, University of Michigan, Ann Arbor, MI; ³Life Sciences-Institute of Neuroscience, National Yang-Ming University, Taipei, Taiwan.

Spinocerebellar ataxia type 6 (SCA6) is an inherited neurodegenerative disease caused by a polyglutamine (polyQ) expansion near the C-terminus of the Cav2.1 voltage-gated calcium channel subunit (CACNA1A). SCA6 is characterized by marked cerebellar dysfunction and atrophy resulting from the preferential loss of cerebellar Purkinje neurons. There is currently no treatment for this debilitating disorder, and thus a pressing need to develop preventative therapies. RNA interference (RNAi) has proven effective at halting the progression of behavioral, histological and molecular abnormalities in several models of Spinocerebellar ataxia (SCA), including SCA type 1 and SCA type 3. However, RNAi-based strategies that selectively target mutant alleles in SCA are currently lacking. In SCA6, alternative splicing near the 3' end of the Cav2.1 transcript generates two mRNA isoforms encoding functional Cav2.1 channel subunits, only one of which contains the pathogenic polyQ domain. Taking advantage of a 5 base pair sequence difference between the two isoforms, we designed splice-isoform-specific (SIS)-RNAi molecules to selectively suppress expression of the polyQ-encoding splice variant in SCA6. Significant and selective suppression of the polyQ-encoding Cav2.1 splice variant was achieved in a variety of cell-based models. A miR124-based microRNA shuttle used for the intracellular production of SIS-RNAi molecules was efficiently recognized, processed and modified by the cellular RNAi machinery. Intriguingly, we find that pathogenic CAG expansions in Cav2.1 enhance splicing activity at the 3' end of the transcript and lead to an increase in the levels of polyQ-encoding Cav2.1 mRNA isoform and polyQ-containing Cav2.1 protein. Current experiments aim to assess the activity, specificity and safety of rAAV-SIS-RNAi mediated inhibition of polyQ-containing Cav2.1 channel subunits in the adult mouse cerebellum. Our results support the preclinical development of SIS-RNAi as a molecular therapy for SCA6 and provide the basis for the development of similar SIS-RNAi-based strategies in other dominantly inherited diseases.

847. Apolipoprotein B Knock-Down by AAV-Delivered sh/miRNA Lowers Plasma Cholesterol in Mice

Piotr Maczuga,^{1,2} Annemart Koornneef,¹ Richard van Logtenstein,¹ Florie Borel,^{1,3} Bas Blits,¹ Sander van Deventer,² Harald Petry,¹ Pavlina Konstantinova.¹

¹Research & Development, Amsterdam Molecular Therapeutics, Amsterdam, Netherlands; ²Department of Gastroenterology and Hepatology, Leiden University Medical Center, Leiden, Netherlands; ³Department of Gastroenterology and Hepatology, Academic Medical Center, Amsterdam, Netherlands.

Serum low-density lipoprotein cholesterol (LDL-C) levels are proportionate to the risk of atherosclerotic cardiovascular disease. In order to reduce serum total cholesterol and LDL-C levels in mice, RNA interference was used to inhibit expression of the structural protein of LDL-C, apolipoprotein B100 (ApoB). We initially developed and screened 19 short hairpin RNAs targeting conserved sequences in human, mouse, and macaque ApoB mRNAs (shApoB) and subsequently narrowed our focus to one candidate, shApoB10, for in vivo inhibition studies. To compare the intrinsic inhibitory properties and long-term efficacy of shRNA and miRNA, we expressed shApoB10 from a miRNA scaffold (miApoB) using the liver-specific

LP1 promoter. Self-complementary adeno-associated virus serotype 8 (scAAV8) was used for long-term transduction of murine liver with shApoB and miApoB. Expression of the AAV-shApoB and AAV-miApoB resulted in 90% ApoB protein knock-down, associated with 80% cholesterol decrease in murine plasma for the first 6 weeks. However, after 6 weeks the inhibitory effect of the shApoB started to wear off, while miApoB retained a more stable inhibitory profile. At 22 weeks post-injection, ApoB and plasma cholesterol were still decreased to 50% from baseline. Furthermore, shApoB was found to specifically reduce LDL-C in diet-induced dyslipidemic mice, while high-density lipoprotein cholesterol (HDL-C) remained unaffected. Finally, elevated lipid accumulation was shown in murine liver transduced with shApoB, a known phenotypic side effect of lowering ApoB levels. Ongoing research aims to determine the mechanism underlying the differences seen between long-term AAV-shApoB and AAV-miApoB efficacy in murine livers. We hypothesize that the long-term stability of the miApoB is due to its lower toxicity and off-target properties compared to shApoB because expression of miApoB is specifically limited to hepatocytes. Our results demonstrate a robust long-term knock-down of ApoB by AAV-delivered miApoB in murine liver, thus providing an excellent candidate for development of RNAi-based gene therapy for the treatment of hypercholesterolemia and associated cardiovascular disease.

Decrease in murine plasma cholesterol levels by AAV-shApoB10 and AAV-miApoB10

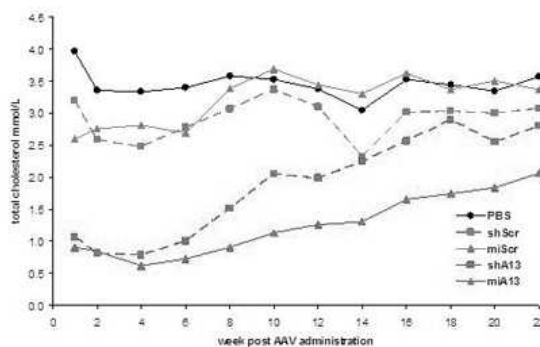

Correspondence should be addressed to P.K. (p.konstantinova@amtbiopharma.com)

848. Double-Stranded Let-7 Mimics, Potential Candidates for Cancer Gene Therapy

Qizhao Wang,¹ Chao Lu,¹ Weidong Xiao,^{1,2} Ruian Xu.¹

¹Engineering Research Center of Molecular Medicine & Institute of Molecular Medicine, Huaqiao University, Ministry of Education, Quanzhou, Fujian, China; ²Department of Microbiology, Temple University, Philadelphia, PA.

MicroRNAs (miRNAs), a class of small, single-stranded endogenous RNAs, act as post-transcriptional regulators of gene expression. The ability of one single miRNA regulating multiple functionally related mRNAs makes it a new potential candidate for cancer gene therapy. Let-7s miRNAs have been demonstrated as tumor suppressive genes in a variety types of cancers, providing one choice of gene therapy by replenishing this miRNA. Here we showed that introduction of double-stranded mimics form of Let-7s inhibited the growth and migration, and induced the cell cycle arrest of lung cancer cell lines *in vitro*. Reporter assay verified that Let-7 mimics could silence the expression of *K-ras* and *Hmga2* genes through binding to the 3'UTR of targeting mRNAs, and mutation of seed sequence significantly depressed the gene silencing activity. Both Let-7 mimics and *K-ras* siRNAs loaded into RISC within 3 h and a 3hs-interval between the introduction of functional Let-7 mimics and *K-ras* siRNA enhance the anti-cancer activities of Let-7s. By using competition and RISC loading assays, it was found that the action

manner of Let-7 mimics was similar with siRNAs. Take together, These results revealed that Let-7s mimics are potential candidates for cancer gene therapy.

849. Effective in vivo silencing for therapeutic application using serum stabilized, non-immunogenic and potent chemically modified siRNAs

Nitin Puri,¹ Chris Burnett,¹ Sasha Vlassov,¹ Angie Cheng,¹ Varun Bagai,¹ Xavier de Mollerat du Jeu,² Kristin Wiederholt,² Susan Magdaleno.¹

¹Small RNA R&D, Life Technologies, Austin, TX; ²RNA Delivery R&D, Life Technologies, Carlsbad, CA.

Short interfering RNAs (siRNA) are routinely used in the laboratory to induce targeted gene silencing via RNA interference, and increasingly, this technology is being translated to the clinic. With development of effective delivery systems, the siRNA design also needs to be enhanced for widespread applications. Primary avenues for such enhancements for in vivo applicability are stability against serum nucleases as well as reduction of non-specific effects owing to interaction of the double stranded RNA with the innate immune system. In this abstract, we introduce variety of chemical modifications in siRNAs through altering functional groups on the ribose ring. Such structural modulation of the RNA are shown to positively impact it's serum stability as well as make the siRNAs non-immunogenic, without impacting potency. These chemical enhancements in siRNAs are shown to translate into effective in vivo efficacy against multiple organs such as the liver, spleen and pancreas, upon formulation as a lipid nanoparticle. In one example, effective knockdown of chemically modified siRNAs lasts upto 29 days (30% knockdown of the mRNA target compared to negative control in the liver), while the unmodified siRNA shows no knockdown (as compared to the negative control). [figure 1] Chemical modulation of siRNAs is gaining traction in the clinic and is driving siRNAs into therapeutic applications such as cancer and metabolic diseases as well as target validation in vivo.

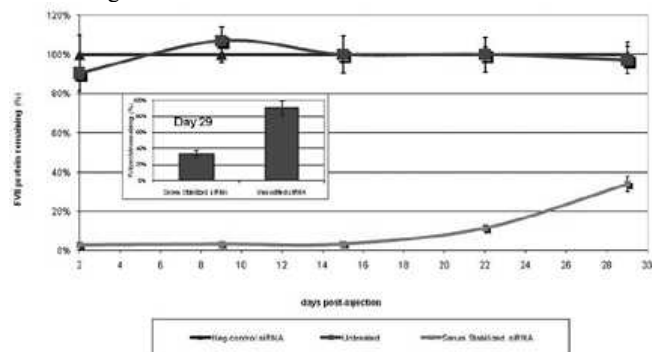

850. RNA Interference Effects on Neuronal Nitric Oxide Synthase Enzyme (nNOS) from Glioma Cells in Culture

Fernando F. B. Resende,¹ Elaine Del Bel,² Luis Pardo,³ Walter Stühmer,³ Ricardo Titze-de-Almeida.¹

¹Lab. Tecnologias para Terapia Gênica, FAV, UnB, University of Brasilia - UnB, Brasilia, Distrito Federal, Brazil; ²Lab.

Neurofisiologia e Biologia Molecular, Dept. Morfologia Estomatologia e Fisiologia, FORP, University of São Paulo - USP, Ribeirão Preto, São Paulo, Brazil; ³Molecular Biology of Neuronal Signals, Max-Planck-Institute for Experimental Medicine, Göttingen, Germany.

The cancer cells overexpress all nitric oxide synthase enzymes during tumor development and metastasis, revealing potential targets for gene therapy. RNA interference (RNAi) techniques commonly produce gene silencing and are useful tools for research or drug development. This study examined whether the RNAi on neuronal nitric oxide synthase enzyme (nNOS) would silence this enzyme in glioma cells (U251MG). We first identified targets for RNAi in the nNOS mRNA sequence using an artificial neuronal network algorithm. The sequence in test here targeted the exon 28 (exon28_nNOS), so it recognized the nNOS splicing variants isoforms α , β , and γ . The glioma cells received 150 pmol of this synthetic double-stranded RNAi (Qiagen) mixed with the transfection agent Lipofectamine[®] (Invitrogen). The negative control sequence was the commercial scramble All-Star[®] (Qiagen). The culture media used in this study were Optimem[®] (Gibco) and DMEM[®] (Gibco), for the first 6 h and for the remaining 24 h of incubation, respectively. We used commercial kits for RNA extraction (RNeasy Plus MiniKit[™], Qiagen) and reverse transcription (SuperScript[™] First-Strand Synthesis System for RT-PCR, Invitrogen). To measure the relative expression ($2^{-\Delta\Delta CT}$) of nNOS, we set up a quantitative PCR protocol with SYBR Green[®] (Applied Biosystem 7500 Fast Real-Time PCR System). The forward and reverse primers used in our study were, respectively, 5' - GGTGGAGATCAATATCGCGGTT - 3' and 5' - CCGGCAGCGGTACTCATTCT - 3' for nNOS. For the housekeeping gene β -actin, we used the primers 5' - GACATCCGCAAAGACCTGTACG - 3' and 5' - GCCAGGGCAGTGATCTCCTTC - 3'. The PCR mixture contained the following reagents: SYBR Green mix, 5.0 μ L; cDNA, 500 ng; 0.8 μ L of each primer 10 μ M/ μ L; MilliQ water up to 10 μ L. The qPCR conditions were: initial denaturation step at 95 $^{\circ}$ C for 5 min, followed by 40 cycles of amplification (95 $^{\circ}$ C for 1 min, 60 $^{\circ}$ C for 1 min). We tested each sample in triplicate wells in the same plate. Surprisingly, the synthetic RNAi sequence exon28_nNOS produced a relative 1.3 fold increase in the level of nNOS in glioma cells, in comparison to the negative control. This result contrasted with the silencing effects previously found by our group in neuroblastoma cells. In conclusion, we report here an unexpected increase of nNOS expression in glioma cells after an RNAi on exon 28 of this enzyme. The following questions remain to be clarified: where does the interference occur, which nNOS splicing variants are affected, and what are the resulting effects on cell proliferation.

851. Silencing the Expression of the alpha Isoform of the Neuronal Nitric Oxide Synthase Enzyme (nNOS) in Neuroblastoma Cells by Synthetic Double-Stranded siRNA

Linus Q. Pereira,¹ Luciana M. Klüppel,¹ Nádia R. Ferreira,² Simoneide S. Silva,¹ Luis Pardo,³ Walter Stühmer,³ Elaine Del Bel,² Ricardo Titze-de-Almeida.¹

¹Lab. Tecnologias para Terapia Gênica, FAV, UnB, University of Brasília - UnB, Brasília, Distrito Federal, Brazil; ²Lab. Neurofisiologia e Biologia Molecular, Dept. Morfologia Estomatologia e Fisiologia, FORP, University of São Paulo - USP, Ribeirão Preto, São Paulo, Brazil; ³Molecular Biology of Neuronal Signals, Max-Planck-Institute for Experimental Medicine, Göttingen, Germany.

The nNOS enzyme is expressed in brain areas submitted to injury, and its pharmacological blocking can decrease the neurotoxic effects of 6-OHDA on dopaminergic neurons. The enzyme has three main splicing variants isoforms - alfa, beta, and gama, which may have distinct roles in neurodegenerative diseases. We described here an RNAi protocol designed to silence specifically the nNOS alfa. This isoform is structurally coupled to the NMDA receptor through a domain coded by the exon 2. Firstly, we used an artificial neuronal network algorithm to identify potential targets for RNAi present only in exon 2. The synthetic siRNA duplexes with 21 nucleotides targeted to this sequence (exon2_nNOS) were synthesized by Qiagen. In our study, we transfected neuroblastoma cells (ATCC SH-SY5Y) with 150 pmol of this exon2_nNOS siRNA mixed with Lipofectamine® (Invitrogen). The negative control sequence was the commercial scramble All-Star® (Qiagen). The cell culture media used in this study were Optimem® and DMEM® (Gibco), for the first 6 h and for the remaining 24 h of incubation, respectively. We used commercial kits for RNA extraction (RNeasy Plus MiniKit®, Qiagen) and reverse transcription (SuperScript™ First-Strand Synthesis System for RT-PCR, Invitrogen). The relative expression ($2^{-\Delta\Delta CT}$) of nNOS was determined by quantitative real-time PCR with SYBR Green® (Applied Biosystem 7500 Fast Real-Time PCR System). The forward and reverse primers for nNOS were 5' - GAACGGGAGACTGAGGTGGTTC - 3' and 5' - CTCAGTGCATCCCGTTTCCA - 3'. For the housekeeping gene GAPDH, we used the primers 5' - CAACTACATGGTTTACATGTTC - 3', and 5' - GGACTGTGGTCATGAGTCCT - 3'. The PCR mixture contained the following reagents: SYBR Green mix 5.0 µL, cDNA 500 ng, 0.8 µL of each primer 10 µM/µL, MilliQ water up to 10 µL. The qPCR conditions were: initial denaturation step at 95 °C for 5 min, followed by 40 cycles of amplification (95 °C for 1 min, 60 °C for 1 min). Each sample run in triplicate wells in the same plate. The siRNA targeted to the nNOS alfa splicing variant produced a marked decrease on nNOS expression. The relative expression of nNOS in the treated group was 0.134 fold in comparison to the negative control. In conclusion, we report here an accurate method to silence the alfa splicing variant isoform of nNOS by using a synthetic double-stranded RNA. Our data encourage the use of RNAi protocols for silencing effects on enzyme isoforms, with the aim to study their roles in brain diseases or to highlight new strategies for gene therapy.

Stem Cell Therapies III

852. Similarities between Cancer Stem Cells and Induced Pluripotent Stem Cells

Ruan van Rensburg,¹ Robert Strauss,¹ Ines Beyer,¹ Oleg Denisenko,² Karol Bomsztyk,² Andre Lieber.¹

¹Division of Medical Genetics, University of Washington, Seattle, WA; ²UW Medicine Lake Union, University of Washington, Seattle, WA.

It is now generally accepted that relapse and chemotherapy resistance of cancer involves subpopulation(s) of cancer cells with stem cell feature (cancer stem cells - CSC). In our studies of ovarian cancer biopsies we have identified subpopulations of cells that are in a transitory E/M hybrid stage, i.e. cells that simultaneously express epithelial and mesenchymal markers. Based on the differences in the levels and cellular localization of the markers E-cadherin, CD133, Tie2 and CD44, we were able to isolate a cell fraction from ovarian cancer biopsies that is highly enriched for tumor-forming cells and that displays features which are generally associated with cancer stem cells. This fraction undergoes a mesenchymal-to-epithelial transition (MET) during tumor formation upon transplantation into immunodeficient mice, i.e. it differentiates into epithelial tumor cells that form the bulk of the tumor. MET was also triggered when primary ovarian cancer cultures were exposed to cisplatin, and resistant cells had a CSC phenotype. On the other hand, MET initiates and is required for the nuclear reprogramming of fibroblasts into induced pluripotent stem (iPS) cells. Similarities between iPS cells and CSC are supported by our confocal immunofluorescent microscopy analyses. Both cell types were in an E/M hybrid stage, e.g. expressed the epithelial marker E-cadherin and the mesenchymal marker N-cadherin. Undifferentiated iPS cells (positive for the stem cell antigen Tra-1-160) and CSC displayed characteristic cytoplasmic punctuated staining for E-cadherin. In contrast, epithelial cells derived from these undifferentiated iPS and CSC contained membrane localized E-cadherin as a part of intercellular junctions. A key gene in the regulation of MET is E-cadherin. We therefore plan to study the epigenetic regulation of the E-cadherin promoter during *i*) fibroblast reprogramming (fibroblasts before and after infection with lentivirus vectors expressing Oct4, Klf4, Sox2, and c-Myc), *ii*) tumor formation (primary ovarian cancer cells before and after transplantation), and *iii*) during acquirement of cisplatin resistance (primary ovarian cancer cells before and after cisplatin treatment). As noted above, all three processes involve MET. Toward this goal, we have performed matrix chromatin immunoprecipitation (ChIP) assays on six iPS cell lines derived from different sources to study the occupancy of the E-cadherin promoter by marks for open and closed chromatin. As expected, we found a closed chromatin configuration in stable iPS cell lines. However, there were significant differences in the chromatin structure of the E-cadherin promoter in different iPS cell lines and we are currently studying whether this correlates with their level of pluripotency, as measured by the ability for secondary hematopoietic differentiation. A better understanding of how CSC form and are maintained during tumor growth and under genotoxic stress can reveal new targets for cancer therapy, which has to be directed towards CSC.

853. Transcriptional Analysis of Human Embryonic Stem Cells and Vascular Endothelial Cells Derived Via Directed Differentiation

Lynsey Howard,¹ Nicole M. Kane,¹ Martin W. McBride,¹ John McClure,¹ Peter D. Adams,² Tony McBryan,² Graeme Milligan,³ Andrew H. Baker.¹

¹BHF GCRC, Institute of Cardiovascular and Medical Sciences, University of Glasgow, Glasgow, United Kingdom; ²Cancer Research UK Beatson Labs, Garscube Estate, University of Glasgow, Glasgow, United Kingdom; ³Neuroscience & Molecular Pharmacology, Wolfson Link Building, University of Glasgow, Glasgow, United Kingdom.

Human embryonic stem cells (hESC) offer broad and unique potential for regenerative medicine owing to their capacity for self renewal, exponential scale up and differentiation into any cell type in the adult body. hESC have been proposed as a potentially unlimited source for the generation of transplantable, healthy, functional vascular cells for repair of ischemic tissues. Previously published protocols for generation of vascular endothelial cells (EC) have varying efficiency and target cell population purity. We recently reported the successful generation of functional vascular ECs from hESC in a feeder-free and scale-able manner. However, the detailed transcriptional events underpinning differentiation of vascular endothelial cells from hESC remain to be fully understood. An Illumina microarray was performed on SA461 hESC subjected to a directed endothelial differentiation protocol (hESC-ECs) at defined, early timepoints. In parallel primary Human Saphenous Vein Endothelial Cells (HSVEC) were analysed. This technology permits whole-genome profiling in a high throughput format. Gene expression data, bivalent status and miRNA expression levels were ascertained for each sample. Preliminary analyses have shown a large number of significantly differentially expressed genes.

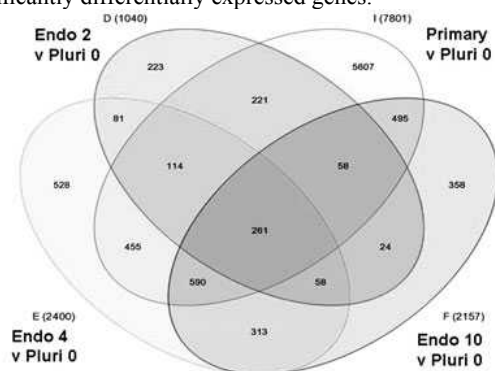

Figure 1: Venn diagram of the comparisons made within the Illumina microarray data. The red oval represents 1040 total significantly differentially expressed genes within the Endothelial Day 2 vs Pluripotent Day 0 comparison; the green oval represents 2400 total significantly differentially expressed genes within the Endothelial Day 4 vs Pluripotent Day 0 comparison; the blue oval represents 2157 total significantly differentially expressed genes within the Endothelial Day 10 vs Pluripotent Day 0 comparison and the brown oval represents 7801 total significantly differentially expressed genes within the Primary Adult Vascular Endothelial Cells vs Pluripotent Day 0 comparison (all FDR <0.05).

Comparison of primary adult endothelial cells with hESC-EC Day 10 reveals 6133 significantly differentially expressed genes. In addition to gene expression data, we have integrated miRNA expression data and gene bivalent status. At hESC-EC day 2, we observe a transient induction of several transcription factors.

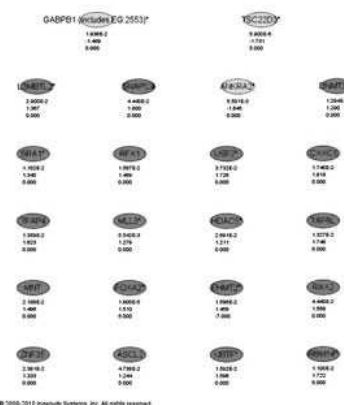

Figure 2: Ingenuity Pathway Analysis output of Endothelial Differentiation Day 2 vs Pluripotent Day 0 specific Transcription Factors. The colour red symbolises an up-regulation compared to Pluripotent Day 0 and the colour green symbolises down-regulation compared to Pluripotent Day 0. The values underneath each Transcription Factor correspond to False Discovery Rate (FDR), fold change and predicted bivalent status respectively.

We hypothesise that these transcription factors may play a key role in the early mesoderm/EC commitment process. Further analysis demonstrated that a proportion of these genes are bivalently marked with the potential to be rapidly activated and/or repressed. Continued analysis of these datasets, and strategies to manipulate the transcriptome of hESC to further understand and refine our current endothelial differentiation protocol are ongoing. Taken together, these studies will allow us to gain new information on the “master control” of hESC differentiation to the vascular endothelial lineage.

854. An *In Vitro* Analog of the Primitive Streak To Derive High-Purity Definitive Endoderm Lineages Uncontaminated by Undifferentiated Cells

Larissa Agapova,¹ Richard West,² Alina Ostrowska,¹ Ruslan Semechkin,¹ Vladimir Agapov,¹ Irina Turovets,¹ Olga Kochetkova,¹ Jeffrey Janus,¹ Andrey Semechkin,¹ Nikolay Turovets.¹
¹International Stem Cell Corporation, Oceanside, CA; ²Western Michigan University, Kalamazoo, MI.

Derivation of differentiated cells uncontaminated by undifferentiated cells that may evolve into tumors is one of a major objective of stem cell research. We report here a novel physiological method to derive from various human pluripotent stem cell types, a high-purity definitive endoderm (DE) and DE lineages uncontaminated by undifferentiated cells. We reproduced *in vitro* the conditions encountered by cells as they migrate through the primitive streak; the migration ability of mes-endoderm, DE progenitor, was used as engine to isolate an extremely pure population of DE. Our differentiation system incorporates a three-dimensional extracellular matrix (3D-ECM) combined with a porous membrane. A layer of 3D-ECM was attached to the bottom of a porous membrane while pluripotent stem cells were plated on top of the membrane, and exposed to soluble growth factors known to direct differentiation toward DE. Differentiated cells acquired migratory properties, as indicated by mass migration of differentiated cells through membrane pores into 3D-ECM on the underside of membrane. The observed cell migration is very similar to the physiological process that occurs during vertebrate gastrulation, when epiblast cells ingress through the primitive streak. Our observations indicate that the cell type detected in the 3D-ECM by the end of DE-stimulation step of the differentiation protocol is an authentic DE. Marker analysis at the protein and RNA levels was consistent with the formation of DE. FACS analysis indicated the extremely purity of these cultures and no undifferentiated cells were detected in the created DE. Reverse transcriptase real-time quantitative PCR (RT-qPCR) revealed a lack of distinct expression of mesoderm, ectoderm, trophoderm and extraembryonic endoderm markers.

Further direct differentiation of cells toward hepatocytes within our differentiation system produced cells manifesting the same cubical shape as mature hepatocytes, and expressing a variety of genes and proteins, typical for functional mature hepatocytes. Comparative analysis of hepatocyte-like cells derived in our differentiation system from human pluripotent stem cells, and mature human hepatocytes was based on RT-qPCR gene detection. To determine whether the test cells express metabolic functions characteristic of normal human hepatocytes, we examined the activities of several phase I (CYP450) and phase II drug-metabolizing enzymes by using reversed-phase HPLC; expression of the appropriate drug-metabolizing enzymes was additionally confirmed by RT-qPCR. The purity of derived hepatocytes was determined by FACS analysis. Obtained data will be presented and discussed. The efficacy of this method was demonstrated for both human embryonic and human parthenogenetic stem cells. Thus, we postulate that, if culture of pluripotent stem cells can respond to direct differentiation signaling and can produce DE lineages, our system will be an effective new approach to isolate a high-purity population of DE lineages.

855. Peptide Based Bone Marrow Targeting of Cord Blood Cells

Thomas J. Kean,¹ James E. Dennis.¹

¹Benaroya Research Institute, Seattle, WA.

Umbilical cord blood (UCB) is a major stem cell resource that is largely underutilized with minor ethical and morbidity concerns, and it requires less HLA matching when transplanted than bone marrow. It also benefits from fewer GVHD events. However, there are a limited number of cells per donor and time to engraftment is longer than that of typical bone marrow transplants which restricts use to children and small adults and increases the potential for infection. Multiple cord blood units and multiple doses have been investigated but both have major limitations and one unit usually predominates when successful transplant is achieved. Cell-targeting offers a novel approach to improve engraftment and increase the efficacy of cord blood transplants, opening UCB transplantation therapy to a wider population. We have developed bone marrow targeting peptides using *in vivo* phage display that, when derivatized and coated onto cells, increase the number of human cord blood cells engrafting into the bone marrow of NOD/SCID mice. **Method:** *In vivo* phage display (7 amino acid library) was used to purify phage that localized in low dose (250 rads) irradiated bone marrow. Bone marrow binding phage were isolated, sequenced and tested in non-irradiated, leg irradiated and whole body irradiated mice. The most efficient binding peptide (RKV) was then synthesized into a molecule containing a biotinylated spacer and a palmitate tail (PA-BioRKV; Fig. 1a), to enable cell labeling assessment and cell membrane integration respectively. Human umbilical cord mononuclear cells, purified twice by percoll™ gradient followed by red blood cell lysis, were coated with PA-BioRKV and 1×10^7 cells were tail vein injected into low dose irradiation treated mice. After 18 days the bone marrow was harvested and the quantity of human DNA analyzed by qPCR of human-specific ALU sequences. **Results:** Several phage from the library showed binding potential in the bone marrow of both irradiated and non-irradiated mice. Selected phage showed 10-100 fold increased localization in bone marrow over a random control phage. Some phage showed preferential binding to irradiated tissue. Human UCB cell engraftment studies in NOD/SCID mice showed 7 fold higher values when cells were coated with PA-BioRKV compared to uncoated UCB cells (Fig 1b). More human DNA was found in all mouse tissues tested (lymph, thymus, spleen) in animals administered PA-BioRKV coated cells than in animals given uncoated UCB cells but the concentration in these tissues was significantly lower than in bone marrow.

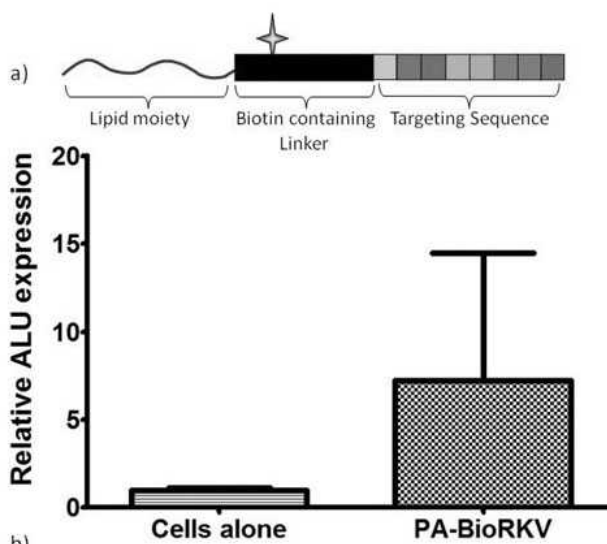

Fig. 1 - Targeting molecule and assessment of bone marrow targeting a) Targeting molecule construct b) Assessment of bone marrow targeting (two experiments, total $n=4 \pm$ SD). **Conclusion:** We have shown proof of concept for the peptide targeting of cells. Specifically, bone marrow engraftment of human mononuclear cells from cord blood was increased by coating with a palmitated peptide containing a bone marrow targeting sequence.

856. Nucleus Pulposus-Derived Stem Cells: Cell Therapy for Disc Degeneration

Olga Mizrahi,¹ Dima Sheyn,^{1,2} Anthony Oh,² Wafa Tawackoli,² Li Zhao,² Hyun Bae,² Dan Gazit,^{1,2} Zulma Gazit.^{1,2}

¹Hebrew University of Jerusalem, Jerusalem, Israel; ²Cedars-Sinai Medical Center, Los Angeles.

Introduction: Intervertebral disc (IVD) degeneration and chronic lower back pain are a major health problem. Since an understanding of disc degeneration is lacking, clinical therapies are still in early development. We previously showed that stem cells (SCs) reside in nucleus pulposus (NP). Changes in the differentiation of resident SCs can represent a loss of homeostasis and diminished regeneration of the tissue. We hypothesized that IVD degeneration affects the quantity, proliferation, and differentiation potential of SCs in the NP. **Methods:** Disc degeneration was induced in a mini-pig model by creating an annular injury under fluoroscopic guidance. NP-SCs were isolated from healthy (Healthy-NP) and degenerated (Degenerated-NP) discs. The freshly isolated cells were tested with a colony-forming unit (CFU) assay, surface MSC marker expression using FACS analysis and immuno-staining (IHC). Proliferation rate was evaluated by cell counts and BrdU incorporation. Cell differentiation into mesenchymal lineages was assessed *in vitro*. In addition, NP-SCs were differentiated into NP-like cells by culture in alginate beads supplemented with TGF β 1 in hypoxia (2% oxygen) and normoxia for 14 days. Differentiation was evaluated using a DMMB assay. **Results:** NP-SCs were isolated from healthy and degenerate IVDs. A significantly higher rate of proliferation was demonstrated in SCs from degenerated-NPs using cell counts and BrdU assay, and a higher number of CFUs as well.

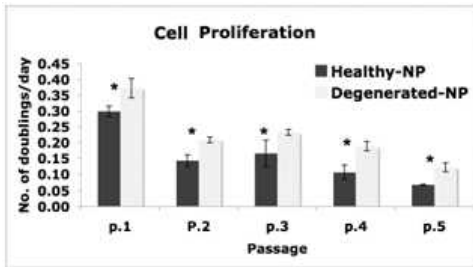

Fig. 1. NP-derived cell proliferation presented as number of cell-doublings per day. * p<0.05; n=5; bars indicate SE.

Freshly isolated SCs from healthy-NP exhibited a higher rate of MSC markers in FACS analysis. MSC-marker expression was verified using IHC. NP-derived SCs from healthy and degenerated discs were differentiated into the mesenchymal lineages; however, healthy NP-SCs showed significantly higher rate of differentiation into chondrogenic lineage. In addition Healthy NP-SCs showed a higher differentiation capacity to NP-like cells than degenerated-NP-derived, in conditions of hypoxia but not normoxia.

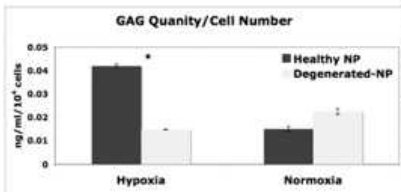

Figure 2: Differentiation into NP-like cells in conditions of hypoxia and normoxia. * p<0.05, n=3; bars indicate SE.

Discussion and Conclusions: These results indicate that disc degeneration has a clear effect on SCs residing in the NP. Cells derived from degenerate discs exhibit higher proliferation abilities that are likely caused by the degeneration process. However, although these cells maintain their differentiation abilities, they have a lower capability of differentiating into NP-like cells. These findings can elucidate what is the role of SC in degeneration process and contribute to future development of cell therapies for disc degeneration.

857. Donor Dependency of Integrin-and Chemokine Mediated Adhesion Activation in Human Mesenchymal Stromal Cells (MSCs)

Felicia Ciuculescu,¹ Melanie Giesen,¹ Victoria Lang,¹ Reinhard Henschler.¹

¹J.W. Goethe University Frankfurt am Main, German Red Cross Blood Donor Service, Frankfurt am Main, Germany.

Mesenchymal Stromal Cells (MSCs) are increasingly used as cellular therapeutics. In the last years, the main application route of MSCs has shifted from local application to intravenous injection. Although the modes of action by which MSCs mediate curative effects e.g. through immune modulation or stimulation of hematopoietic engraftment have not been completely elucidated, interaction of MSCs with endothelial cells, e.g. in the lungs, may trigger the response. We describe here that MSCs isolated from the bone marrow of 5 different donors show major differences in shear-stress dependent integrin mediated adhesion. We first tested shear-stress dependent adhesion of MSCs on three different recombinant integrin ligands, Vascular Cell Adhesion Molecule (VCAM)-1, Intercellular Adhesion Molecule-1 (ICAM)-1 and Mucosal Addressin CAM (MAdCAM)-1. In contrast to peripheral blood lymphocytes which were potently induced to arrest and firmly adhere on all three ligands at shear stresses ranging from 0.35 to 4 dynes/cm², MSCs arrested and adhered only on VCAM-1 but not ICAM-1 or MAdCAM-1. Next, MSCs from 5 different donors were arrested on VCAM-1, before increasing shear stresses were applied. Between MSCs from the 5 different donors, the fraction of cells which remained adherent varied between 50% and 28% of initially adherent cells at the lowest shear stress (0.35 dynes/cm²) and 30% and 0%, respectively, at the highest investigated shear stress (15 dynes/cm²). When the chemokines CCL15, CCL19,

CXCL8, CXCL12 and CXCL13, representing ligands to the chemokine receptors CCR1, CCR7, CXCR1, CXCR4 and CXCR5, respectively, were co-immobilized with VCAM-1, adhesion of the 5 MSC isolates was enhanced only in only part of the MSC isolates: MSCs from two donors responded to 3/5 chemokines (one to CCL15, CCL19 and CXCL13, the other to CCL19, CXCL12 and CXCL13), MSCs from two more donors responded only to 2/5 chemokines and MSCs from donors only to one chemokine, CCL19. Repeated analysis of MSCs at different passage numbers confirmed that the donor-specific response to chemokines remained constant over time in culture. When the MSCs from the same 5 donors were exposed to the tested chemokines in the absence of shear stress, all chemokines induced polarization responses, and flow cytometric analysis confirmed expression of all tested chemokine receptors in MSCs from all 5 donors, indicating that the chemokines were active on all MSCs. In summary, our data revealed that (i) MSCs show a selective integrin binding engaging only VLA-4/VCAM-1, and no binding to two other integrin ligands, (ii) MSC isolates from 5 different donors showed individual profiles in their shear stress- dependent integrin activation, and (iii) only selected chemokines possessed the ability to enhance integrin-mediated adhesion function. The molecular nature if the described defect is currently unknown. Future studies are warranted to explore potential correlations between chemokine and integrin activation capacity in individual MSC cell therapeutics and clinical outcome e.g. suppression of Graft-versus-Host-Disease or hematopoietic graft failure in patients.

858. Human Liver Endothelial Cells, but Not Macrovascular or Microvascular Endothelial Cells, Can Inhabit the Mouse Liver Sinusoidal Endothelial Niche

Ebtisam E. I. Filali,¹ Johan Hiralall,¹ Donna B. Stolz,² Jurgen Seppen.¹

¹Tytgat Institute, AMC, Amsterdam, Netherlands; ²Cell Biology and Physiology, University of Pittsburgh, Pittsburgh.

Background and aims: Mouse endothelial cells can be efficiently grafted in recipient mouse liver offering many opportunities for both cell transplantation as well as gene therapy purposes for inherited liver disorders. It is however unknown whether human liver endothelial cells also have this capacity. Furthermore, due to a lack of donor livers, the capacity of other sources of endothelial cells suitable for cell transplantation purposes should be examined. We therefore compared the grafting and repopulation capacity of human liver endothelial cells to human macrovascular and microvascular endothelial cells. **Methods:** Human liver sinusoidal endothelial cells were isolated from adult and fetal liver using anti-human CD31 antibody conjugated magnetic beads. Human macrovascular endothelial cells were obtained from umbilical vein and human microvascular endothelial cells were isolated from subcutaneous fat tissue. Cells were characterized *in vitro* using flow cytometry. Their repopulation capacity was studied after intrasplenic transplantation in monocrotaline treated immunodeficient mice. Additionally, we performed transplantation experiments with CD31 negative fetal liver cells. The cells were transduced with a GFP-expressing lentiviral vector prior to transplantation. **Results:** After transplantation GFP-expressing human liver sinusoidal endothelial cells engrafted throughout the mouse liver and repopulated up to 10% of the mouse liver endothelium. With immuno-scanning electron microscopy the presence of fenestrae in engrafted human liver endothelial cells *in vivo* was identified, confirming functional repopulation with human liver endothelium. In contrast, CD31 negative liver cells and both human macrovascular and microvascular endothelial cells were not capable of repopulating the mouse liver. Characterization of isolated human liver-, macrovascular and microvascular endothelial cells demonstrated that they expressed CD31, CD34 and CD146

but not CD45. **Conclusion:** Our study shows that human liver sinusoidal endothelial cells but not macrovascular and microvascular endothelial cells, have the capacity to repopulate the mouse liver. Our results also shows that mature macrovascular and microvascular endothelial cells do not exhibit phenotypic plasticity under our experimental conditions and are therefore not suitable sources for cell transplantation purposes.

859. Immune Modulation and Control of GvHD by Mesenchymal Stem Cells

Lung-Ji Chang,¹ Yin Liang,² Weng Hang Ho,² Jian-Ping Zhang,³ Jing-Bo Wang,³ Tong Wu,³ Chun-Rong Tong,³ Lu-Jia Dong,³ Dao-Pei Lu.³

¹Molecular Genetics and Microbiology, University of Florida, Gainesville, FL; ²Vectorite Biomedica Inc, Taipei, Taiwan; ³Beijing Daopei Hospital, Beijing, China.

Human mesenchymal stem cells (MSCs) can differentiate into connective tissues, repair tissue damage, promote angiogenesis and modulate immune responses. Infusions of MSCs into bone marrow transplant (BMT) patients experiencing acute or chronic GvHD brought about rapid and notable reduction of oral and gastrointestinal GvHD symptoms. To explore the underlying mechanisms of the prominent immunomodulatory effect of MSCs on GvHD, we isolated human BM-derived MSCs and characterized their proliferation potential and immunophenotype in culture. There was no significant correlation between donor age and the proliferative ability of the BM-derived MSCs. MSCs in culture from passage 1 to passage 7 showed constitutive expression of CD73, CD29, CD90, and CD105, but not CD45, HLA-DP-DQ-DR, CD14, CD34, and CD117. Further analysis of hematopoietic receptor/migration markers showed increased expression of mucosal, gut and BM homing markers upon continuous passages. Quantitative analysis of chemokine/cytokine production when MSCs were cocultured with autologous or allogeneic PHA-stimulated peripheral blood mononuclear cells (PBMCs) revealed increased expression of IL-6, IL-8, IL-10, IP-10, MIG and RANTES but decreased expression of IL-1 β and TNF α . We observed evident MSC-mediated suppression of proliferation of activated PBMCs and down-regulation of antigen-specific immune effector cell functions; however, the effect of this immune suppression by MSCs was donor-dependent. In sum, MSCs modulate immune responses by affecting both the effector and tissue homing functions of the immune cells. Further understanding of the regulatory potential of allografted MSCs is needed as clinical outcomes of MSC infusions may still be influenced by human leukocyte antigen (HLA) disparity.

860. Highly Efficient Neural Lineage Induction and Generation of Neural Progenitor Cells Via an AggreWell™ Embryoid Body Formation System with a Novel Neural Induction Medium

Alexandra A. Blak,¹ Jennifer Antonchuk,¹ Eileen Yoshida,¹ Mark Fairy,¹ Terry E. Thomas,¹ Allen C. Eaves,^{1,2} Sharon A. Louis.¹
¹RND, Stemcell Technologies Inc., Vancouver, BC, Canada; ²Terry Fox Laboratory, BC Cancer Agency, Vancouver, BC, Canada.

Standardization of human pluripotent stem cell (hPSC) differentiation protocols will help to improve directed differentiation efficiencies and facilitate transfer of cell replacement technologies to the clinic. We have therefore developed: a) the AggreWell™ system - a device for the formation of size-controlled embryoid bodies (EBs) in the first step of many published differentiation protocols, and b) a novel Neural Induction Medium and Rosette Selection reagent - optimized media formulations for the downstream directed differentiation of hPSC to neural progenitors. AggreWell™400 and AggreWell™800 plates contain an array of microwells on the bottom surface, in which hPSCs of defined numbers are inoculated, where they will form into

EBs. By filling the overlying well with a desired number of hPSCs, followed by centrifugation to distribute the cells evenly into the microwells, a population of EBs with uniform and defined size is formed within 24 hrs. That pool of uniformly sized EBs can then be collected by gentle pipetting. AggreWell™ is available in two size formats: AggreWell™400 for the formation of EBs from 50 to 3,000 cells each, and AggreWell™800 for the formation of EBs from 2,000 to 20,000 cells each. Importantly, while facilitating consistency in EB size within and between experiments, the AggreWell™ system also allows flexibility in EB size formation over the range of 50 to 20,000 cells per EB. To standardize differentiation protocols for hPSCs to the neural lineage, we developed a novel Neural Induction Medium, and used it in conjunction with the AggreWell™ system described above. EBs that contained 500 - 20,000 cells each were formed using AggreWell™400 or AggreWell™800 plates in Neural Induction Medium. Fresh Neural Induction Medium was replaced on the EBs cultured within the AggreWell™ plates daily for 5 days, and on day 5 EBs were harvested from AggreWell™ and sub-cultured onto poly-L-ornithine/laminin coated plates in Neural Induction Medium for an additional 2 days to allow attachment and colony formation. After 2 days, 90-100% of the colonies formed were found to contain neural "rosettes" - a commonly accepted morphological criterion indicative of early neural progenitor cell (NPC) induction. Moreover, the rosettes contained Pax6, Sox1 and Nestin positive cells indicative of early-stage NPCs. Neural rosette-containing areas were then selectively dissociated using a novel selection reagent and the harvested rosettes were re-plated onto poly-L-ornithine/laminin coated plates. The NPCs could be maintained in proliferation conditions for multiple passages, or cultured in differentiation media to induce differentiation into mature neurons and astrocytes as determined by the expression of TUJ1 and GFAP, respectively. This work describes a standardized and highly efficient protocol for the induction of neural progenitor cells and their progeny from hESCs and iPSCs.

861. Oncogenic Risk of Induced Pluripotent Stem Cells Established from Somatic Cells with Chromosome Instability

Saori Yamaguchi,¹ Tomotoshi Marumoto,^{1,2} Takenobu Nii,¹ Hiroataka Kawano,¹ Jiyuan Liao,¹ Yoko Nagai,¹ Michiyo Okada,¹ Atsushi Takahashi,^{1,2} Hiroyuki Inoue,^{1,2} Erika Sasaki,³ Shinji Okano,⁴ Yoshie Miura,¹ Kenzaburo Tani.^{1,2}

¹Division of Molecular and Clinical Genetics, Medical Institute of Bioregulation, Kyushu University, Fukuoka, Japan; ²Department of Advanced Molecular and Cell Therapy, Kyushu University Hospital, Fukuoka, Japan; ³Central Institute for Experimental Animals, KEIO University, Kawasaki, Japan; ⁴Division of Pathophysiological and Experimental Pathology, Department of Pathology, Kyushu University, Fukuoka, Japan.

Since the establishment of induced pluripotent stem cells (iPSCs) by Shinya Yamanaka in 2006, the application of iPSCs to the regenerative medicine has been strongly expected. These iPSCs are also expected to overcome ethical concerns and the problems caused by host's allogeneic immune rejection when embryonic stem cells (ESCs) are applied to the regenerative medicine. Recently patient-specific iPSCs are considered to be a powerful cell resource to establish regenerative medicine in multiple fields. However, when iPSCs are established from the patient's cells which have the chromosome instability, a risk of oncogenesis is strongly concerned. To examine the safety of the iPSC generation from the somatic cells with the chromosome instability, we established various iPSC lines with chromosome instability (iPS-CI) by lentiviral transduction of four reprogramming factors, such as human Oct3/4, Klf4, Sox2 and c-Myc, into fibroblasts with chromosome instability derived from common marmoset (CM) aorta-gonado-mesonephros (AGM) area. Seven days after the transduction, we transferred gene-transduced CM

fibroblasts on mitomycin-c treated mouse embryonic fibroblasts and cultured in the medium for CM ESCs, and found that they formed round structures 14 to 21 days after the transduction. These iPSC-CIs expressed ES markers such as SSEA3, SSEA4 and TRA-1-60, and showed alkaline phosphatase activity, suggesting that these iPSC-CIs have been reprogrammed. On the other hand, when these iPSC-CIs were transplanted to the testis or the hypodermis in immune-deficient mice, they formed poorly differentiated malignant tumors very similar to human embryonal carcinoma, indicating that iPSC-CIs had been transformed in the process of iPSC generation. It should be carefully examined whether iPSCs established from patients with chromosome instability before they are applied to the regenerative medicine. The possibility to target Oct3/4 or c-Myc to treat patients who unfortunately had iPSC-derived embryonal carcinoma (iPS-EC) in clinical practice of regenerative medicine will be discussed.

862. Hypoxia Inhibits Senescence and Maintains Mesenchymal Stem Cell Properties through Downregulation of E2A-p21 by HIF-TWIST

Chih-Chien Tsai,^{1,3} Yann-Jang Chen,² Tu-Lai Yew,³ Shih-Chieh Hung.^{1,3,4}

¹Institute of Pharmacology, Faculty of Medicine, National Yang-Ming University, Taipei, Taiwan; ²Institute of Genome Sciences, Department of Life Sciences, National Yang-Ming University, Taipei, Taiwan; ³Stem Cell Laboratory, Department of Medical Research and Education, Taipei Veterans General Hospital, Taipei, Taiwan; ⁴Orthopaedics and Traumatology, Taipei Veterans General Hospital, Taipei, Taiwan.

Low-density culture provides a method for rapid expansion of human mesenchymal stem cells (MSCs). However, MSCs enriched by this method underwent senescence and lost stem cell properties, whereas combined with hypoxic culture preserved the early stem cell properties. The mechanism was mediated through direct downregulation of E2A-p21 by HIF-1 α -TWIST. Expansion under normoxia induced E2A and p21 expression, which were abrogated by overexpression of TWIST, whereas siRNA against TWIST upregulated E2A and p21 in hypoxic cells. Further, siRNA against p21 in normoxic cells enhanced proliferation and increased differentiation potential, whereas overexpression of p21 in hypoxic cells induced a decrease in proliferation and a loss of differentiation capacity. More importantly, MSCs expanding by up to 100 population doublings under hypoxic conditions exhibit telomerase activity with maintained telomere length, have a normal karyotyping and genetic integrity, and do not form tumors. These results provide a method for efficiently expanding MSCs without losing stem cell properties and increasing tumorigenicity.

863. IPS Technology and Its Implications for Gene and Cell Therapy

Duanqing Pei.¹

¹Guangzhou Institutes of Biomedicine and Health, CAS, Guangzhou, China.

The generation of induced pluripotent stem cells (iPSCs) from somatic cells by exogenous factors opens a new era of possibilities for regenerative medicine. Potentially, once safety concerns are overcome differentiated lineages derived from patient specific iPSCs could be used for transplantation purposes and this would change the way we perceive medicine nowadays. However, for patients with genetic diseases the mutation will need to be corrected as otherwise the functional defect will remain. And the same can be said for other acquired diseases as well in which viruses can access cells through a specific receptor, for instance AIDS. To overcome these issues there is growing interest in applying zinc finger technology for either correcting mutations or knocking out genes. But this technology has

limitations and is lengthy. In this regard, gene therapy of iPSCs or their differentiated progeny using clinically approved vectors could be a valuable possibility. Here we described the generation of iPSCs from a Chinese patient with Wilson's disease that bears the R778L Chinese hotspot mutation in the ATP7B gene, whose product is a liver enzyme responsible for copper export into bile and blood. These iPSCs were pluripotent and could be readily differentiated into functional hepatocytes that display abnormal cytoplasmic localization of mutated ATP7B and defective copper transport. Importantly, gene correction using a self-inactivating lentiviral vector that expresses codon optimized-ATP7B could reverse the functional defect. In the future, hepatocytes from similarly genetically corrected iPSCs may also be an option for autologous transplantation in Wilson's disease. Notably, we also provide proof of principle that our experimental model based on iPSCs can be used to screen compounds aimed to correct the abnormality.

864. A GMP-Compliant Process for the Scale-Up and Large Scale Banking of Human Embryonic Stem Cells

Lara J. Ausubel,¹ Patricia Lopez,¹ Rui-Lin Wu,¹ Tania Aguilar,¹ Jing Chai,¹ Wei Dang,¹ Patricia Huang,¹ Rafat Khan,¹ Derek Kong,¹ Robin Wesselschmidt,¹ David Hsu,¹ Larry Couture.¹
¹Center for Biomedicine and Genetics, City of Hope, Duarte, CA.

Human pluripotent stem cells represent an important resource for the development of cellular therapies in the field of regenerative medicine. However, current culture methods do not allow for efficient scale-up and banking, thus presenting a major challenge to the field. Our objective is to apply our cGMP biologics and cell line process development expertise to the establishment of scalable cGMP-complaint banking processes for human embryonic stem cells (hESCs) and to generate cGMP hESC banks that could be used to support the development of cells for use in clinical trials. Though there are several well established research methods for the culture of hESCs, many use a co-culture method comprised of animal or human feeder cells and research-grade growth factors, all of which may contribute to an uncertain product profile containing unknown elements such as viruses with potential risk to human health or cell product integrity. We describe our process for large-scale banking which involves adapting hESC lines from standard research laboratory conditions to cGMP-compatible conditions and methods. This process allows for the scale-up culture and cryopreservation of 200-500 vial master cell banks under feeder-free conditions. Of particular importance was the development of qualifying assays to demonstrate the pluripotency, functionality, and purity of the hESCs that are needed to release these banks for clinical use. Using these methods, we have successfully banked hESCs at large scale under cGMP conditions.

865. Safeguarding Nonhuman Primate iPSC Cells with Suicide Genes

Bonan Zhong,¹ Korashon L. Watts,¹ Martin E. Wohlfahrt,¹ Jennifer E. Adair,¹ Joerg Enssle,¹ Hans-Peter Kiem.^{1,2,3}

¹Clinical Research Division, Fred Hutchinson Cancer Research Center, Seattle, WA; ²Departments of Medicine, University of Washington School of Medicine, Seattle, WA; ³Departments of Pathology, University of Washington School of Medicine, Seattle, WA.

The development of technology to generate induced pluripotent stem (iPS) cells constitutes one of the most exciting scientific breakthroughs because of the enormous potential for regenerative medicine. However, the safety of iPS cell-related products is a major concern for clinical translation. Insertional mutagenesis, possible oncogenic transformation of iPS cells or their derivatives, or the contamination of differentiated iPS cells with undifferentiated cells,

resulting in the formation of teratomas, have remained considerable obstacles. Here, we demonstrate the utility of suicide genes to safeguard iPS cells and their derivatives. We found suicide genes can control the cell fate of iPS cells *in vitro* and *in vivo* without interfering with their pluripotency and self-renewal capacity. This study will be useful to evaluate the safety of iPS cell technology in a clinically highly relevant, large animal model and further benefit the clinical use of human iPS cells.

866. Bone Marrow Derived Stem Cells Involved in Regeneration of Epithelial Cells through Cell Fusion

Yi-ling Hsu,¹ Xianghui He,¹ Wei Wei,¹ Zhixiang Zhang,¹ Liwei Zhu.¹

¹*Department of General Surgery, Tianjin General Surgery Institute, Tianjin Medical University General Hospital, Tianjin, China.*

Bone marrow derived stem cells have shown to have strong plasticity, but the mechanism they participate in regeneration and renewal of tissue is still under debate. In the present study, we investigated the possibility and possible mechanism of bone marrow derived stem cells involvement in the renewal of vascular endothelial cells in different organs through bone marrow transplantation using green fluorescence protein transgenic mice as donor. Six week-old female C57BL/6-GFP mice were used as donor mice, and male C57BL/6 mice with the same age were used as the recipient to establish bone marrow transplanted chimeric mice. The chimerism of bone marrow was assessed by flow cytometry. Twenty weeks after transplantation, frozen slide of the brain, kidney, liver, spleen, heart, and lung tissue were prepared and fluorescence in situ hybridization was applied to label the Y chromosome, then GFP expression and Y chromosome were observed using fluorescence microscope. Results showed that the percent of GFP⁺ cell of bone marrow cells in the recipient were $7.48\% \pm 1.38\%$ and $73.92\% \pm 5.57\%$ at week 1 and week 4 respectively, indicating the success of bone marrow transplantation model. In week 20, fluorescence microscope observation showed GFP expression in vascular endothelial cells in the brain, kidney, liver, spleen, and lung, and some cells also show Y chromosome expression at the same time, indicating cell fusion occurred. No GFP expression was observed within the parenchyma of the brain and heart. These results indicate BMSCs may participated in the renewal of blood vessel endothelial cells in different organs through cell fusion.