



HAL
open science

Fluxnet and regional carbon flux modeling, spatial integration and regional fluxes, spatial scales of coherence, network-scale analysis

Philippe Ciais, Markus Reichstein, Kenneth Davis, Toshinobu Machida, Dario Papale, Galina Churkina, Scott Denning, Gen Inoue, Ivan Janssens, Natasha Miles, et al.

► To cite this version:

Philippe Ciais, Markus Reichstein, Kenneth Davis, Toshinobu Machida, Dario Papale, et al.. Fluxnet and regional carbon flux modeling, spatial integration and regional fluxes, spatial scales of coherence, network-scale analysis. FLUXNET Workshop "Celebrating 10 years Since La Thuile and Planning for the Future", Dec 2004, Firenze, Italy. 58 pl. hal-01189430

HAL Id: hal-01189430

<https://hal.science/hal-01189430v1>

Submitted on 7 Jun 2020

HAL is a multi-disciplinary open access archive for the deposit and dissemination of scientific research documents, whether they are published or not. The documents may come from teaching and research institutions in France or abroad, or from public or private research centers.

L'archive ouverte pluridisciplinaire **HAL**, est destinée au dépôt et à la diffusion de documents scientifiques de niveau recherche, publiés ou non, émanant des établissements d'enseignement et de recherche français ou étrangers, des laboratoires publics ou privés.

Fluxnet and regional carbon flux modeling

(spatial integration and regional
fluxes, spatial scales of coherence,
network-scale analysis),

Ph. Ciais, M. Reichstein, K. Davis, T. Machida, D. Papale, S. Arshimov, G. Churkina, S. Denning, G. Inoue, I. Janssens, N. Miles, S. Richardson, K. Trusilova, R. Valentini, N. Viovy, A. Granier ⁽⁴⁾, J. Ogée ⁽⁵⁾, V. Allard ⁽⁶⁾, M. Aubinet ⁽⁷⁾, Chr. Bernhofer ⁽⁸⁾, A. Carrara ⁽⁹⁾, F. Chevallier ⁽¹⁾, N. De Noblet ⁽¹⁾, A. Friend ⁽¹⁾, T. Grünwald ⁽⁸⁾, B. Heinesch ⁽⁷⁾, P. Keronen ⁽¹⁰⁾, A. Knohl ^(11,12), D. Loustau ⁽⁵⁾, G. Manca ⁽²⁾, G. Matteucci ⁽¹³⁾, F. Miglietta ⁽¹⁴⁾, J.M. Ourcival ⁽¹⁵⁾, K. Pilegaard ⁽¹⁶⁾, S. Rambal ⁽¹⁵⁾, G. Seufert ⁽¹³⁾, J.-F. Soussana ⁽⁶⁾, M.-J. Sanz ⁽⁹⁾, E.D. Schulze ⁽¹¹⁾, T. Vesala ⁽¹⁰⁾

Estimating regional fluxes

Atmospheric
inversions

Ill posed problem
Errors amplification

Completeness
Not traceable to processes

Downscaling

Upscaling

Hétérogénéities
Variability

Flux models
Data -driven
Process -driven

Remote sensing
Biophysics
Phenology
Land cover

Incompleteness
Traceable to processes

Biometric
studies

Eddy
Covariance
Towers

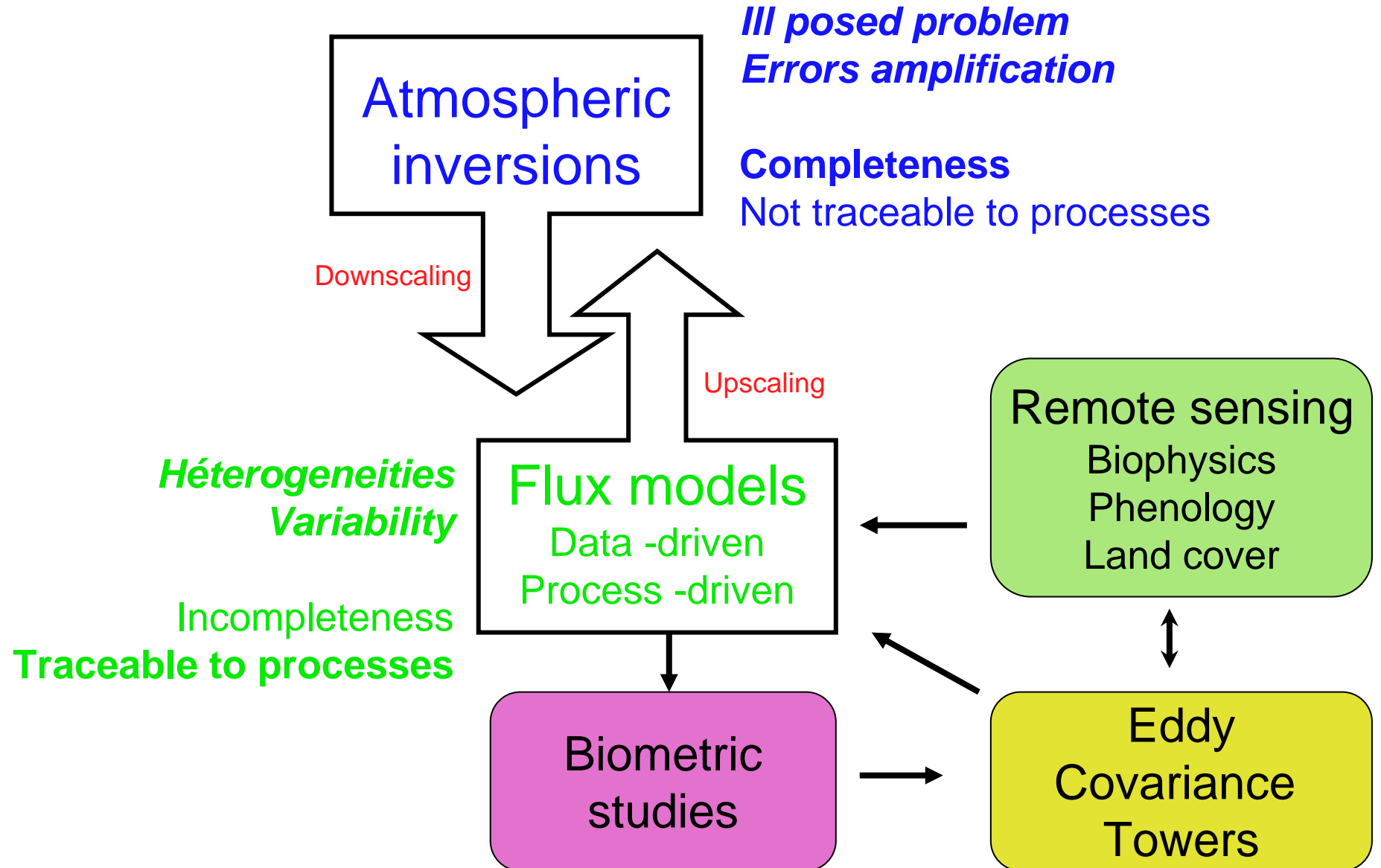

Inversions

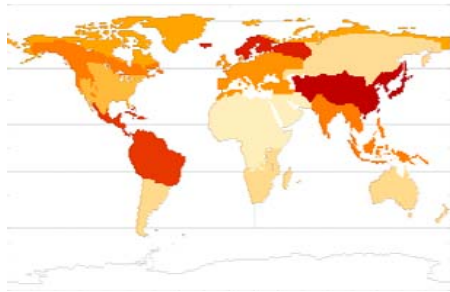
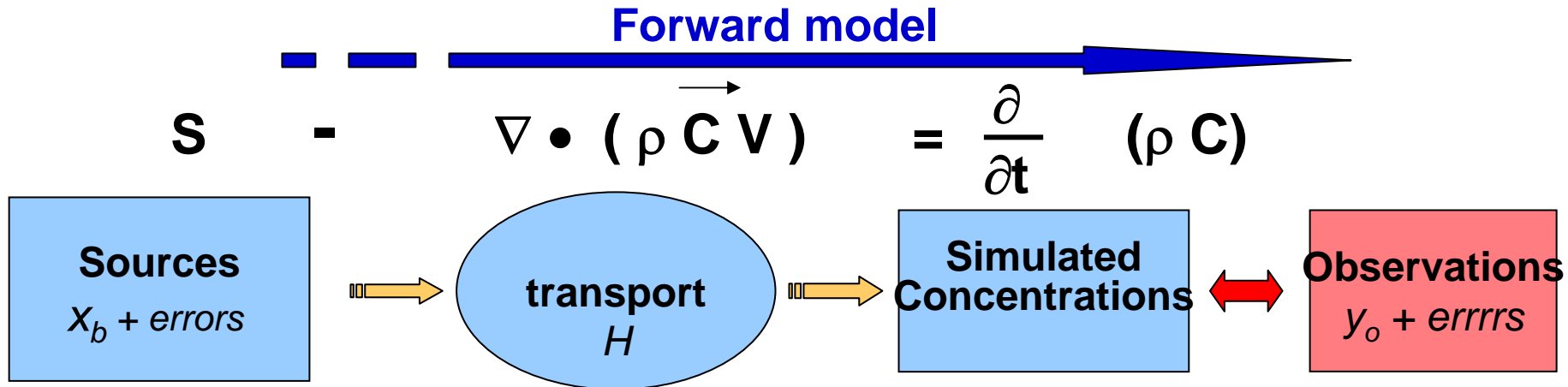

Inversion

$$\mathbf{H} \mathbf{x} = \mathbf{y}$$

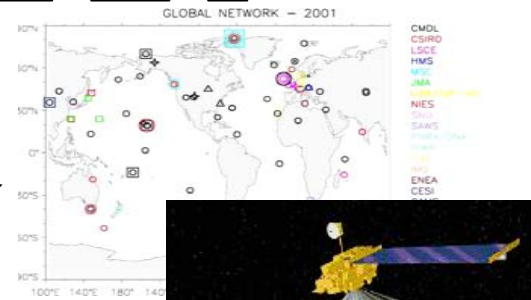

Flux estimate x_a which produces the best fit the atmospheric data

Estimation : $x_a = x_b + (\mathbf{H}^T \mathbf{R}^{-1} \mathbf{H} + \mathbf{P}^{-1})^{-1} \mathbf{H}^T \mathbf{R}^{-1} (\mathbf{y}_0 - \mathbf{H} x_b)$

Error : $\mathbf{P}_a = (\mathbf{H}^T \mathbf{R}^{-1} \mathbf{H} + \mathbf{P}^{-1})^{-1}$

Joint constraints! Complementary methods : 1. Continental budgets

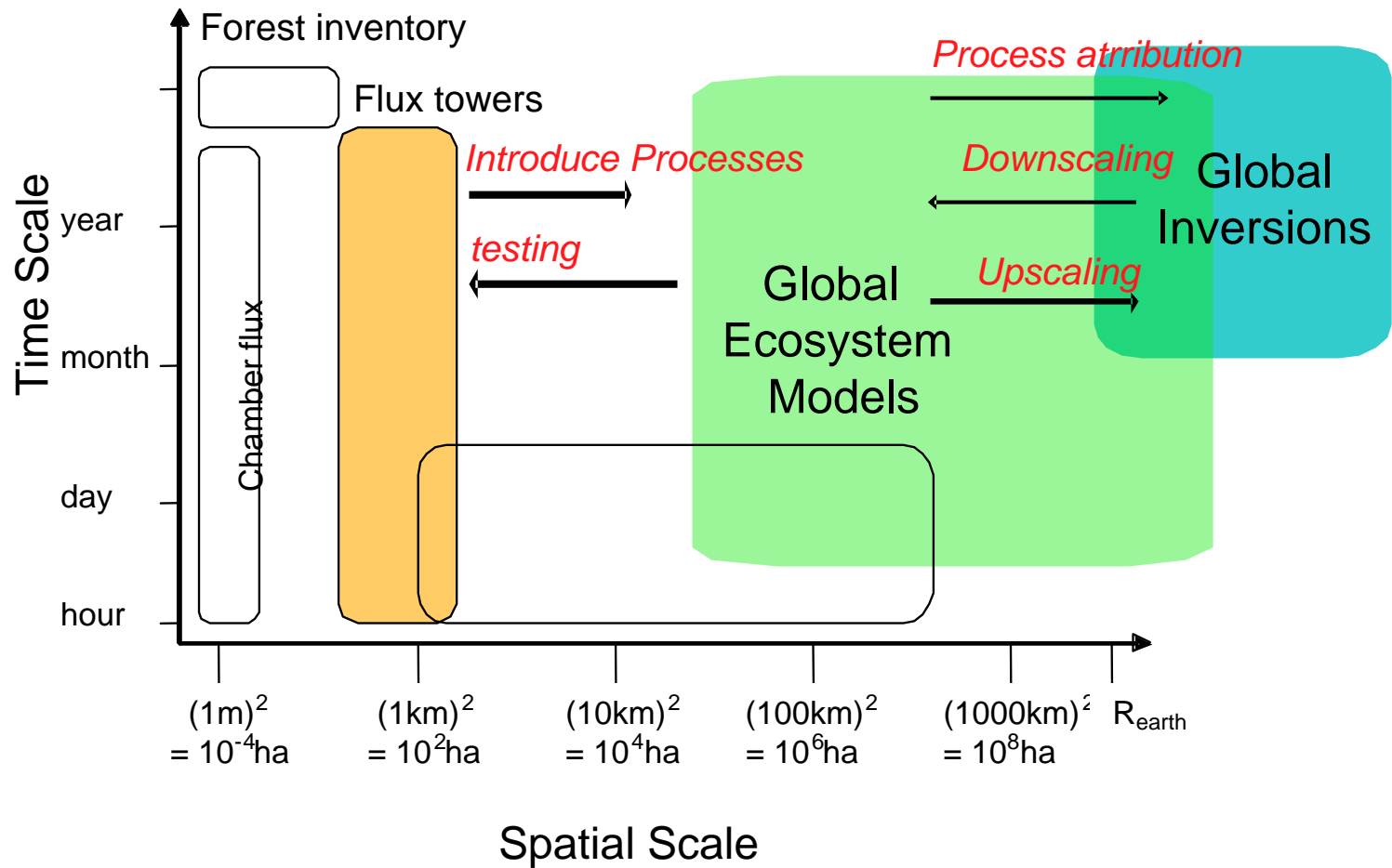

Inversion of Continental Fluxes

Apportionment of NH sink in longitude

Sources of uncertainties

- Data errors
- Network density
- Transport biases
 - seasonal vertical advection*
- Inversion set-up
 - Prior flux aggregations*
 - Prior errors*
 - Prior estimate*

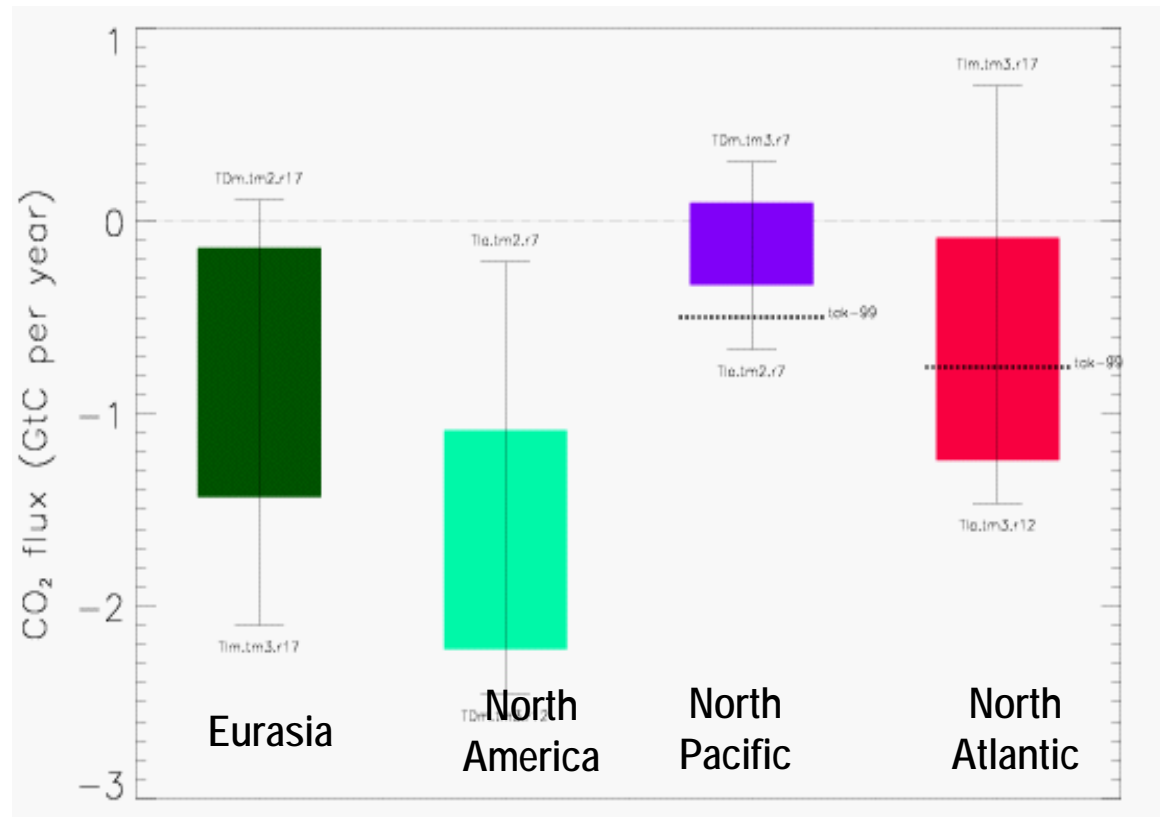

Interannual variations in CO₂ growth rate

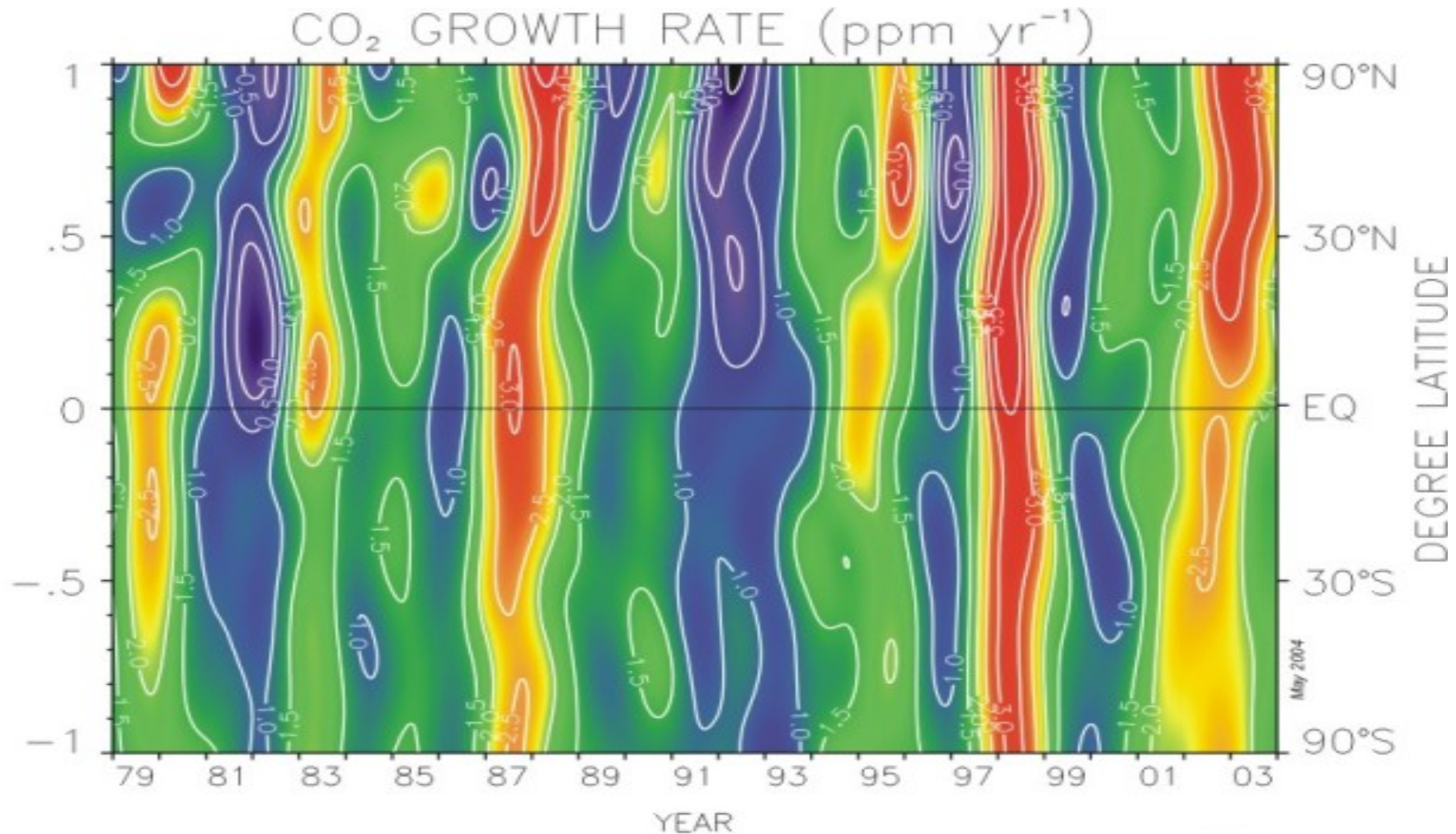

Contour plot showing the temporal and spatial variations in the atmospheric increases of carbon dioxide. The cooler colors (green, blue, violet) represent periods of lower than average growth rates and the warmer colors (yellow, orange, red) represent high growth rate periods. The plot is derived from measurements of thousands of samples collected at the CMDL cooperative air sampling network sites. The variations in the growth rate of this climatically important gas are due to interannual variations in the imbalance between sources and sinks, and also to variations in atmospheric transport. Principal investigator: Thomas Conway, NOAA CMDL Carbon Cycle Greenhouse Gases, Boulder, Colorado, (303)497-6681 (thomas.j.conway@noaa.gov, <http://www.cmdl.noaa.gov/ccgg>).

IAV of global fluxes

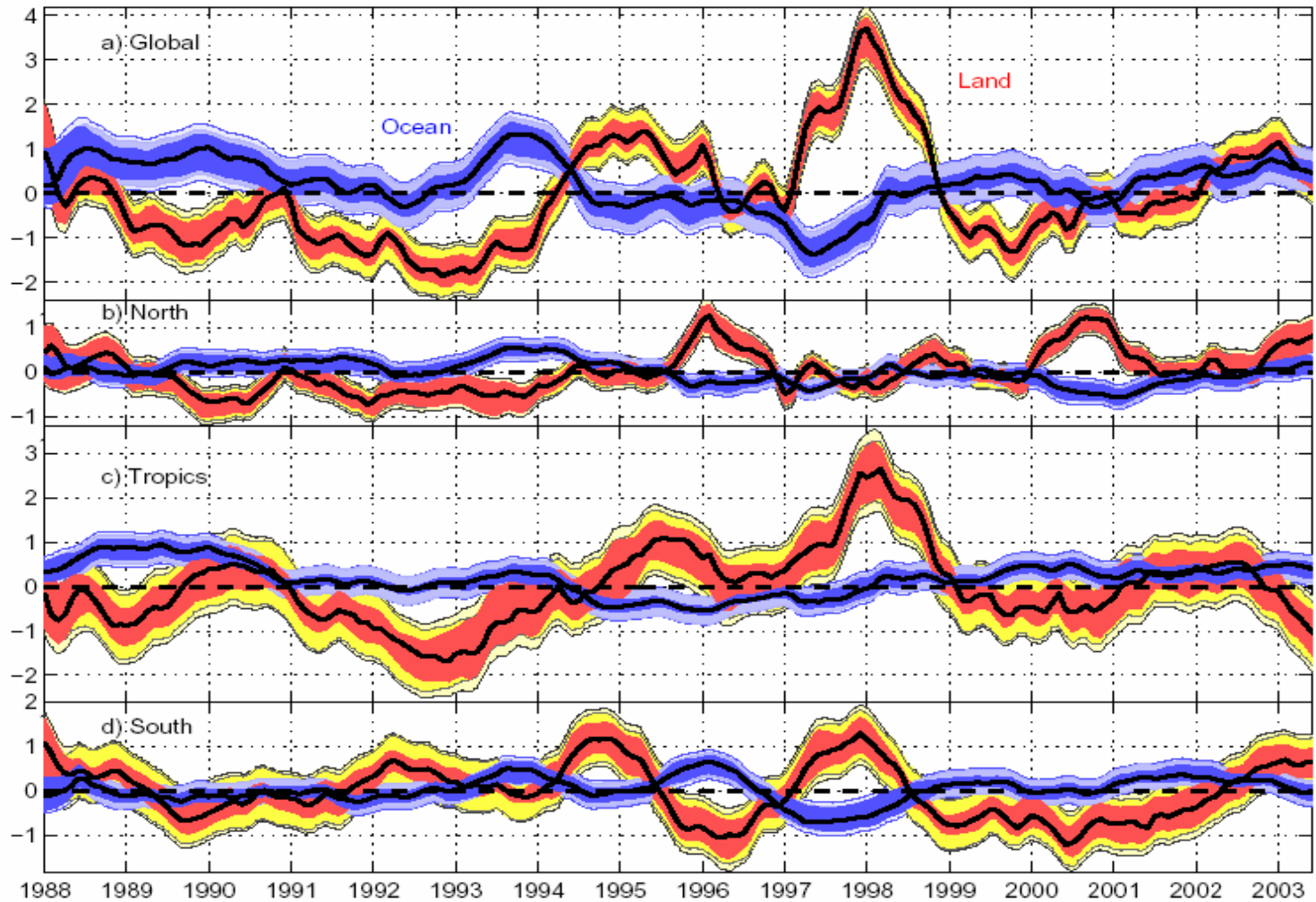

Figure 4. The land and ocean flux interannual variability (PgC yr^{-1}) from x^{IAV} for the full globe, and for the three broad latitude bands defined in Table 4.

IAV of Continental scale fluxes

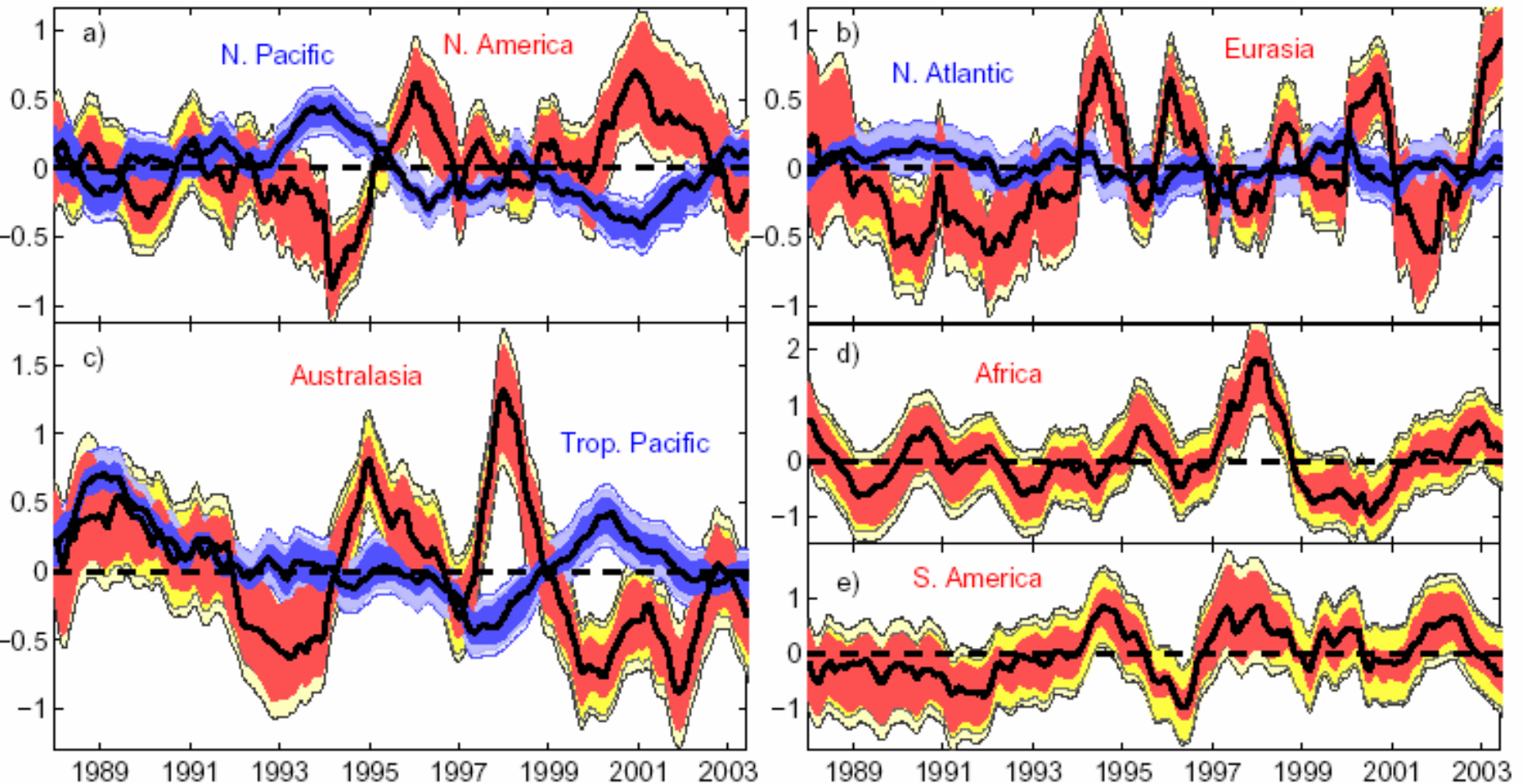
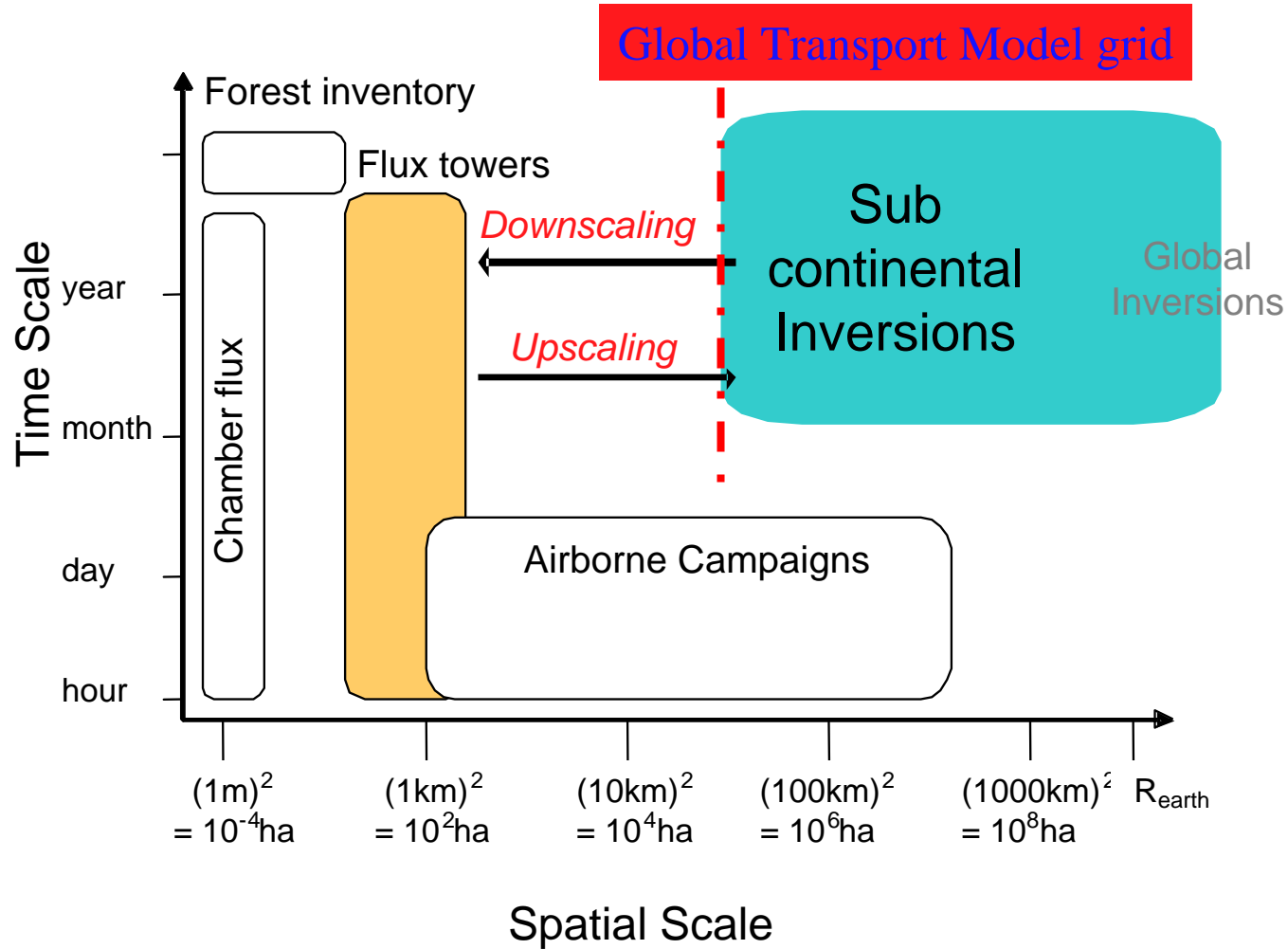

Figure 5. The 13-model mean CO₂ flux IAV [PgC yr⁻¹] from x^{IAV} on the continent/basin scale for the regions defined in Table 4: a) North Pacific & North America, b) North Atlantic & Eurasia, c) Australasia & Tropical Pacific, d) Africa, and e) South America (note the different scales for Africa and S. America).

Joint constraints! Complementary methods : 2. sub-continental budgets



Inversions on the model grid

Regional scale Fluxes

from continuous CO₂ concentrations

Daily fluxes over Europe at 50 km
(over the rest of globe (large regions))

Flux correction

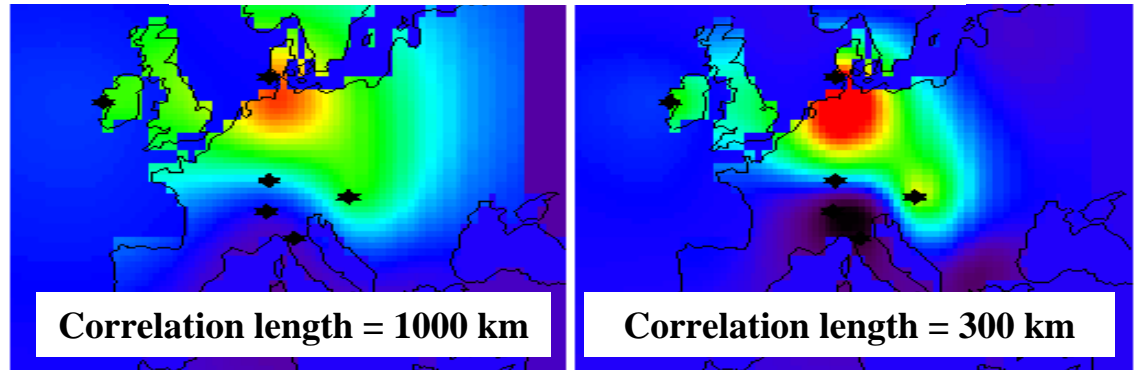

Sources of Uncertainty

- Transport

Synoptic horizontal

Diurnal vertical

- Prior Fluxes

Scales of coherence

Diurnal Cycle

Synoptic variability

- Representiveness

- Network density

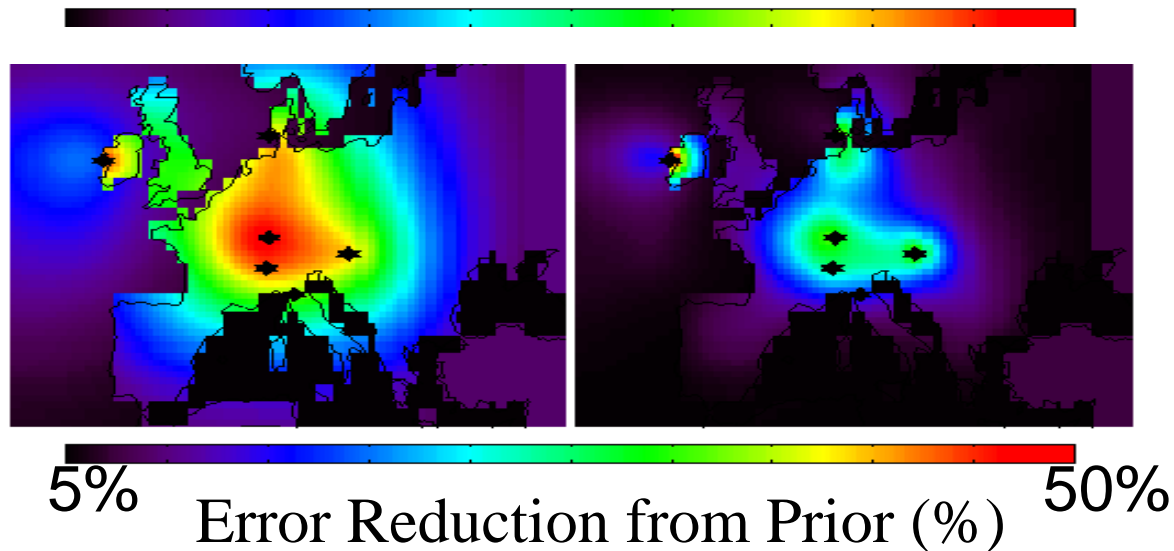

Carouge et al. 2004

NOAA CMDL Carbon Cycle Greenhouse Gases MEASUREMENT PROGRAMS - 2007

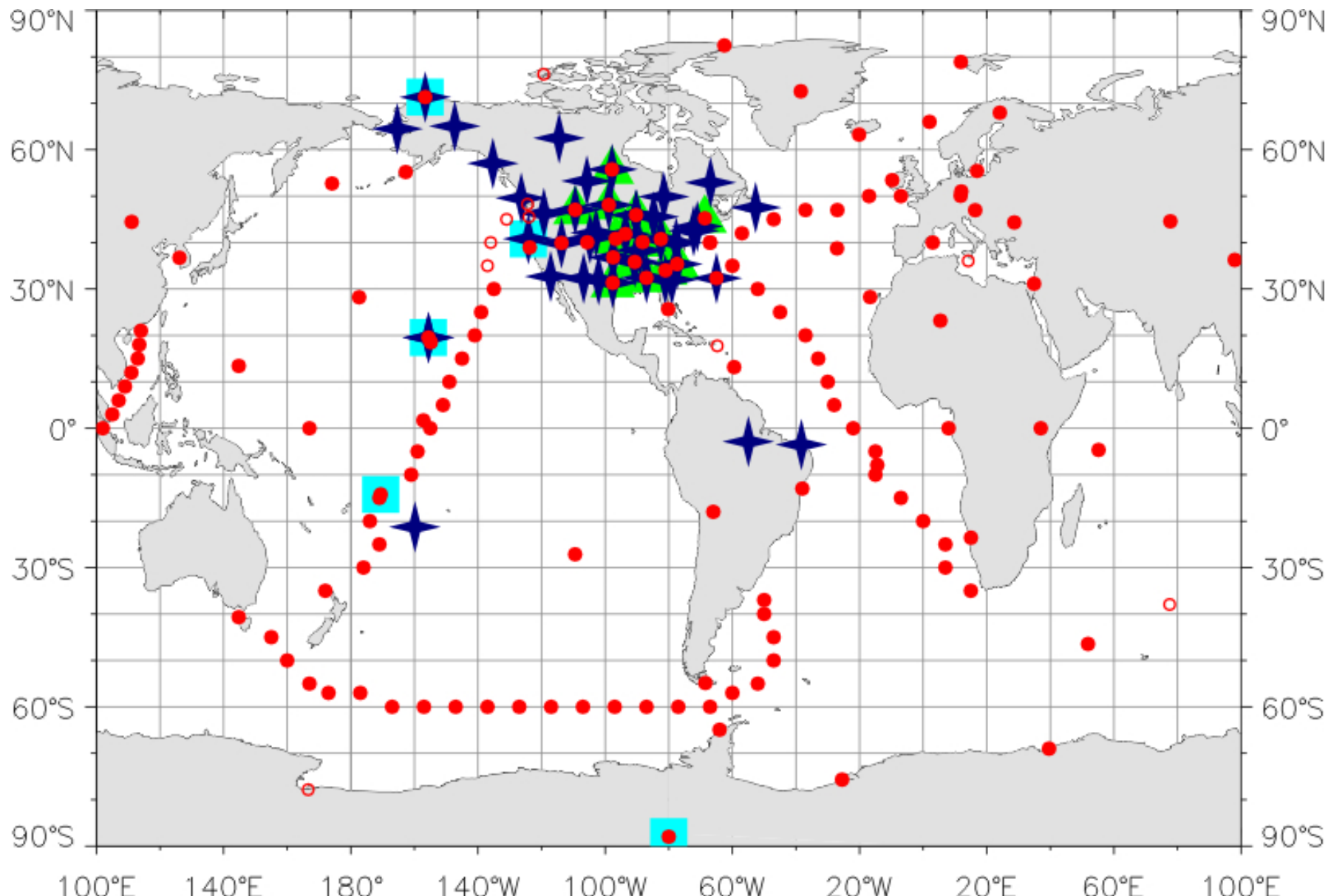

Linking bottom up observations ?

A 2003 European heatwave case study

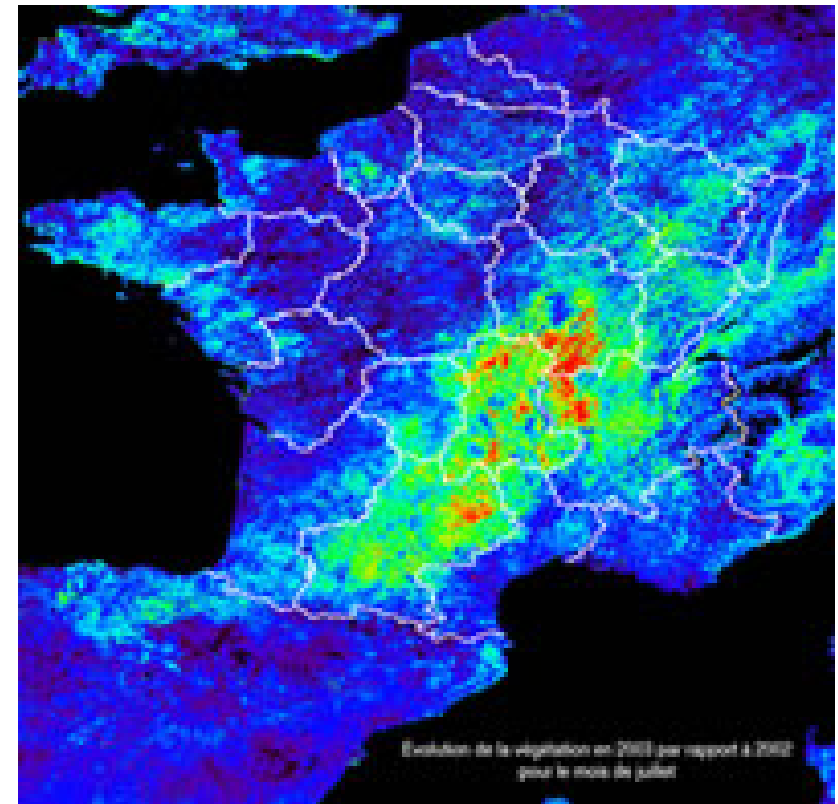
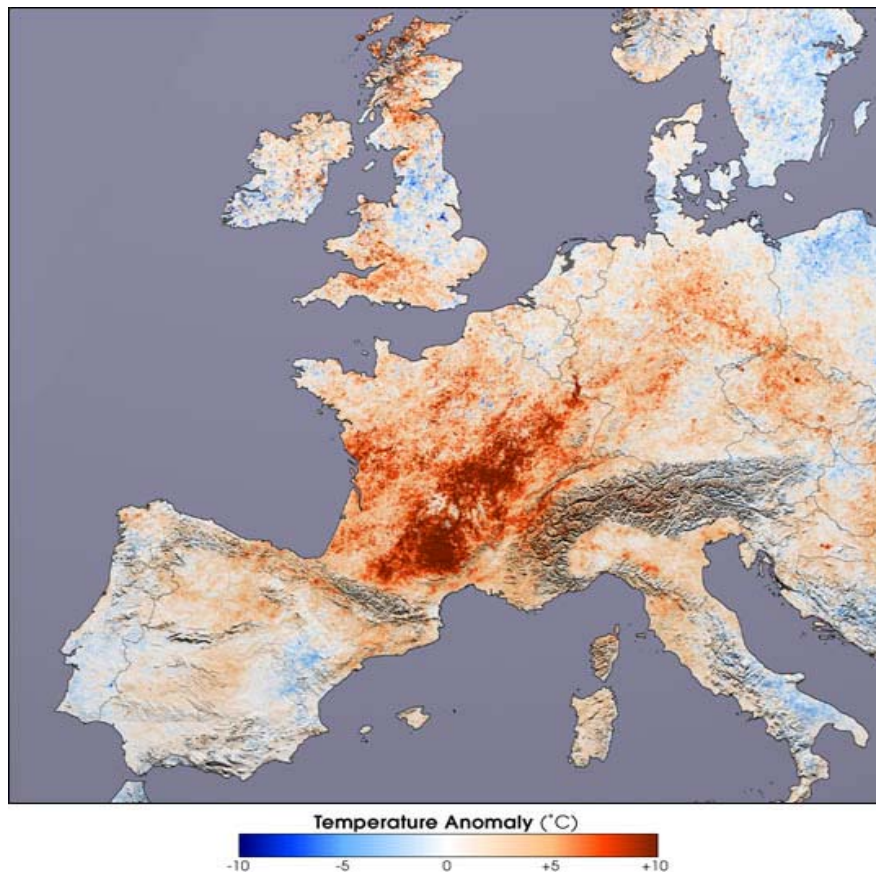



Secular increase in primary productivity from satellite NDVI over the past 25 years

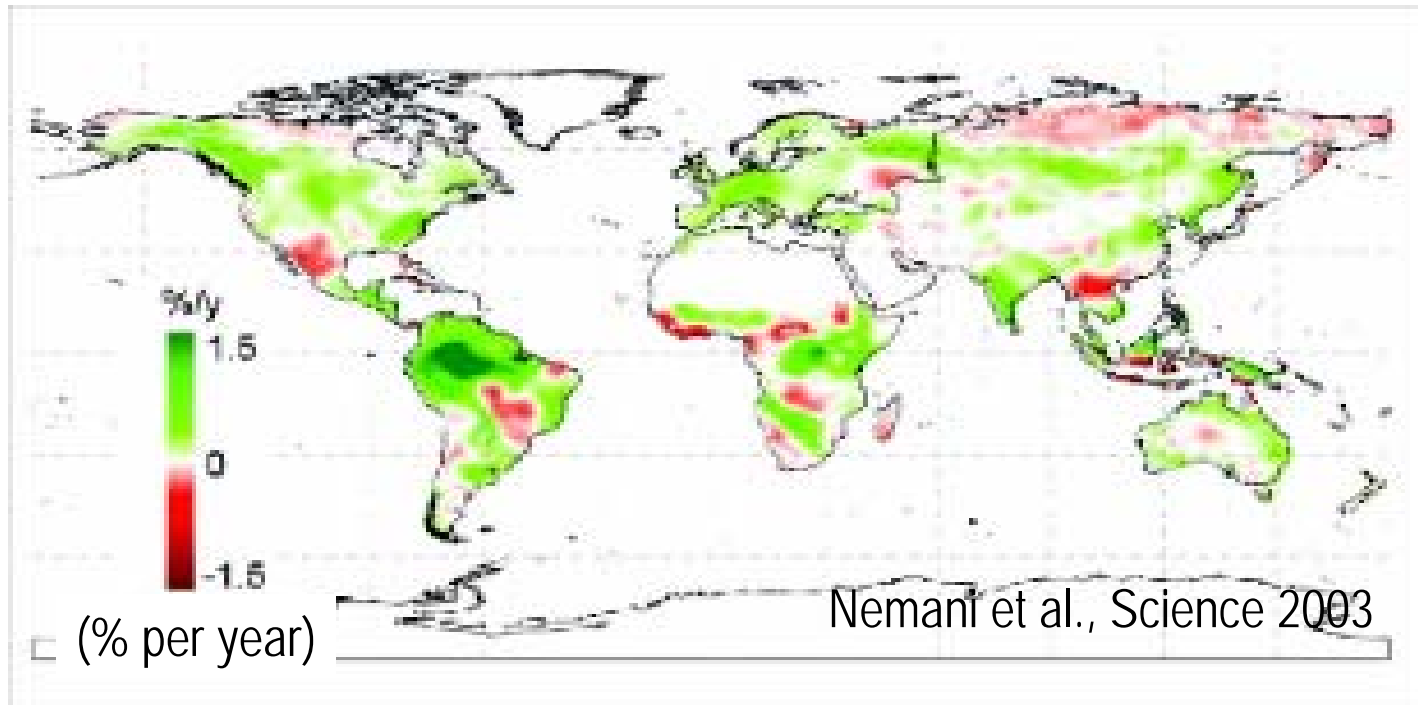

Will the greening continue if more frequent climate extremes impact productivity and net fluxes ?

Historical temperature records in Switzerland

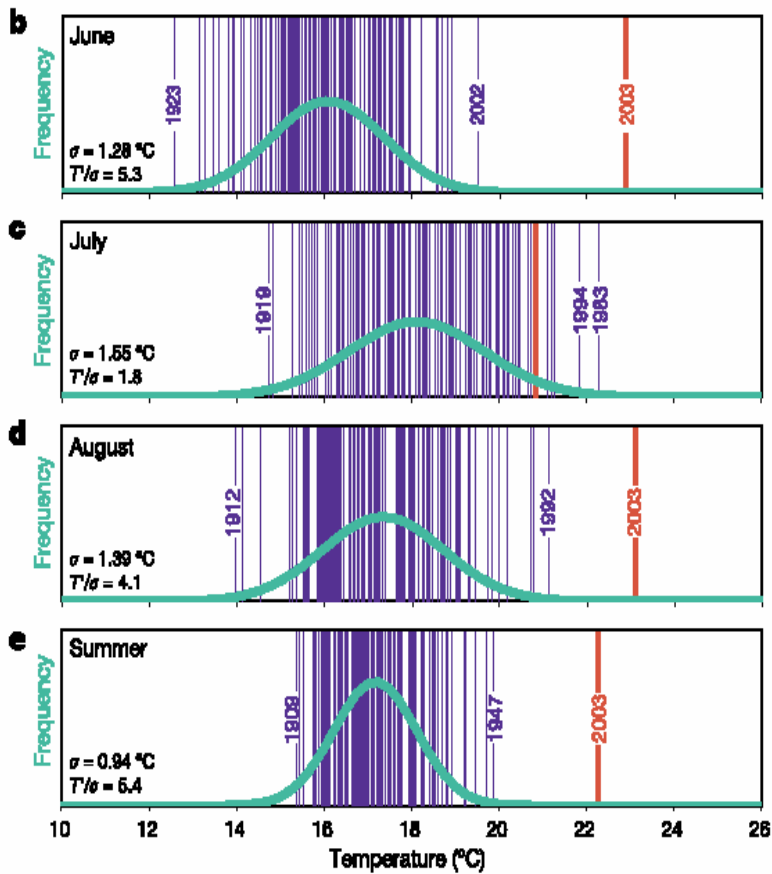

Shär et al., Nature 2003

Precipitation history in Bavaria

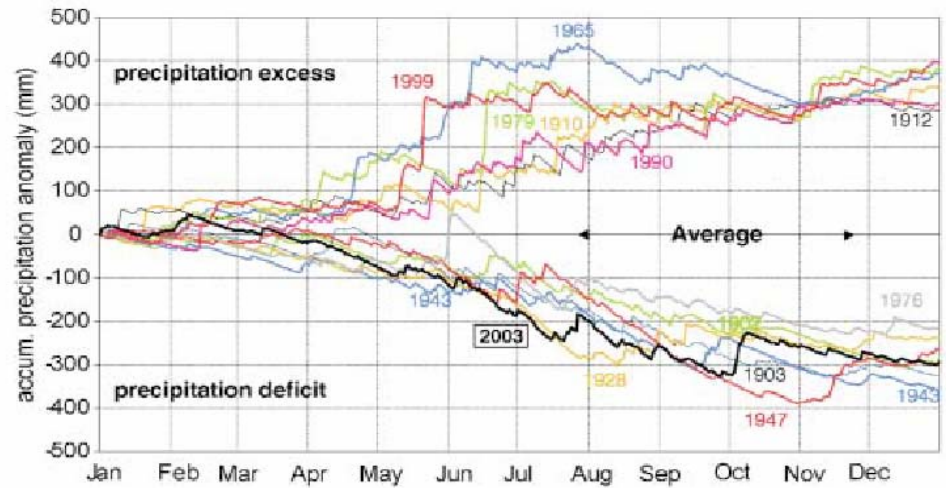

Summer temperature reconstruction from harvest dates in Burgundy

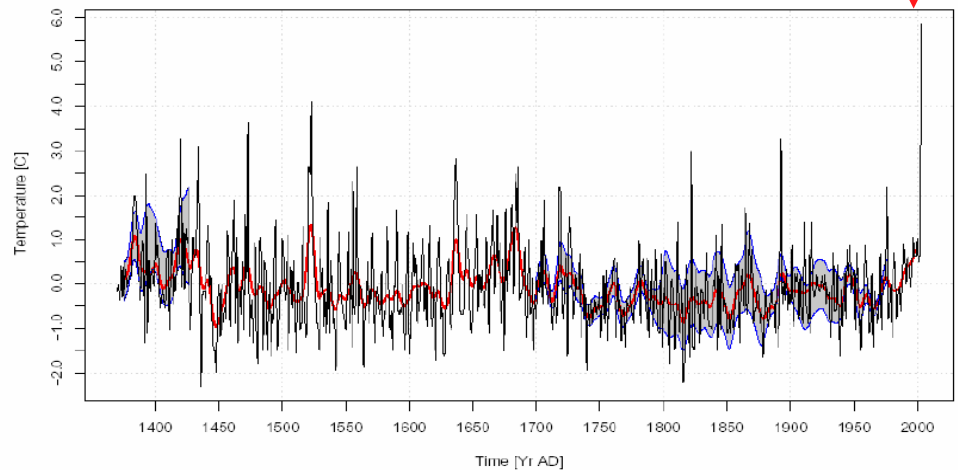

Chuine et al., Nature, 2004

Integrating Regional Carbon Budgets

- Eddy covariance fluxes
- Crop yield statistics
- Remote sensing
- Atmospheric concentration
- Tree rings
- Terrestrial ecosystem models

Multiple Constraint Observations

| | Spatial representativity | Temporal resolution | Information on processes | Long term record |
|---------------------------|---|-----------------------------|--------------------------------|-----------------------------------|
| Flux Towers Network | -- (++ from processes and network) | +++ | +++ | - |
| Crop yields | + Averaged at the resolution of yield data | -- | --- | +++ |
| Remote sensing | +++ But only GPP, NPP | +++ But only GPP, NPP | - | + From different sensors |

JUL-SEP Temperature 2003 vs 1998-2002

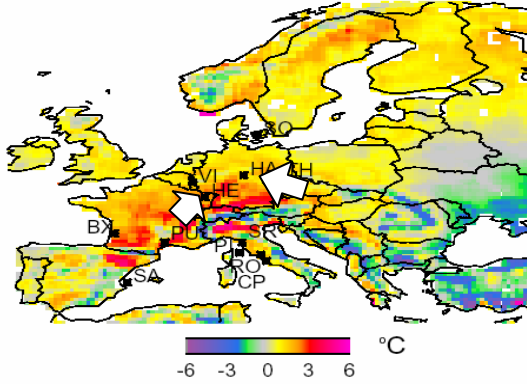

Two Beech forests

Hainich

Eastern Germany

150 years

Hesse

Eastern France

30 yrs

QuickTime™ et un
décompresseur TIFF (LZW)
sont requis pour visionner cette image.

Annual Rain 2003 vs 1998-2002

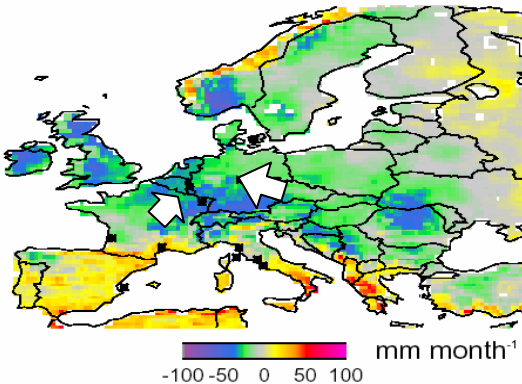

Mediterranean forests

Holm oak

Maquia

Oak

Pine

QuickTime™ et un
décompresseur TIFF (LZW)
sont requis pour visionner cette image.

QuickTime™ et un
décompresseur TIFF (LZW)
sont requis pour visionner cette image.

Annual GPP and TER ...

are coupled...

... and even the difference 2003-2002.

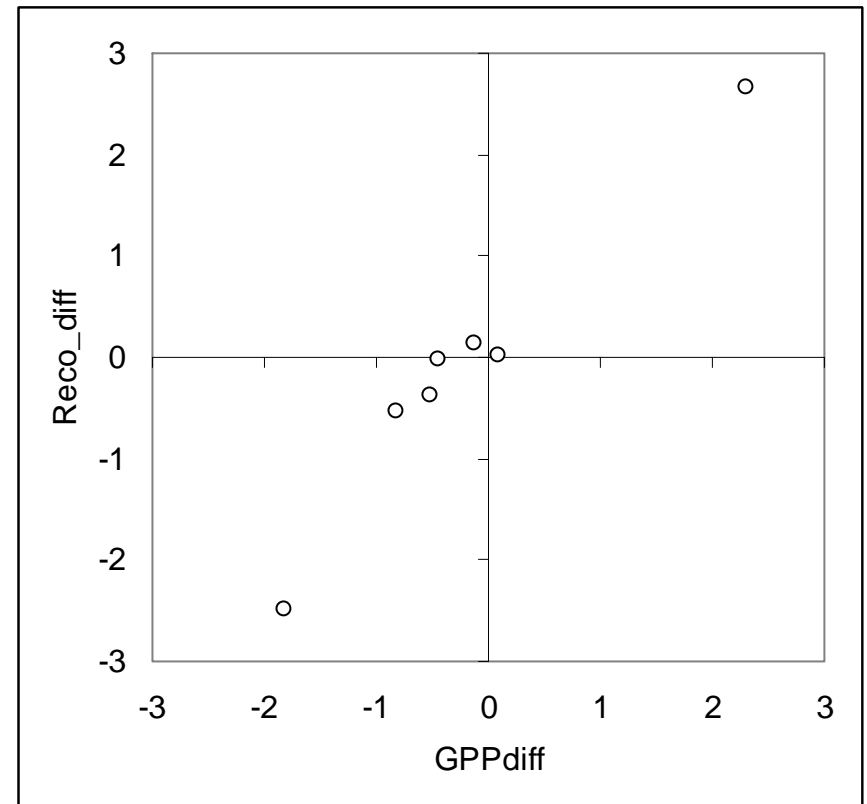
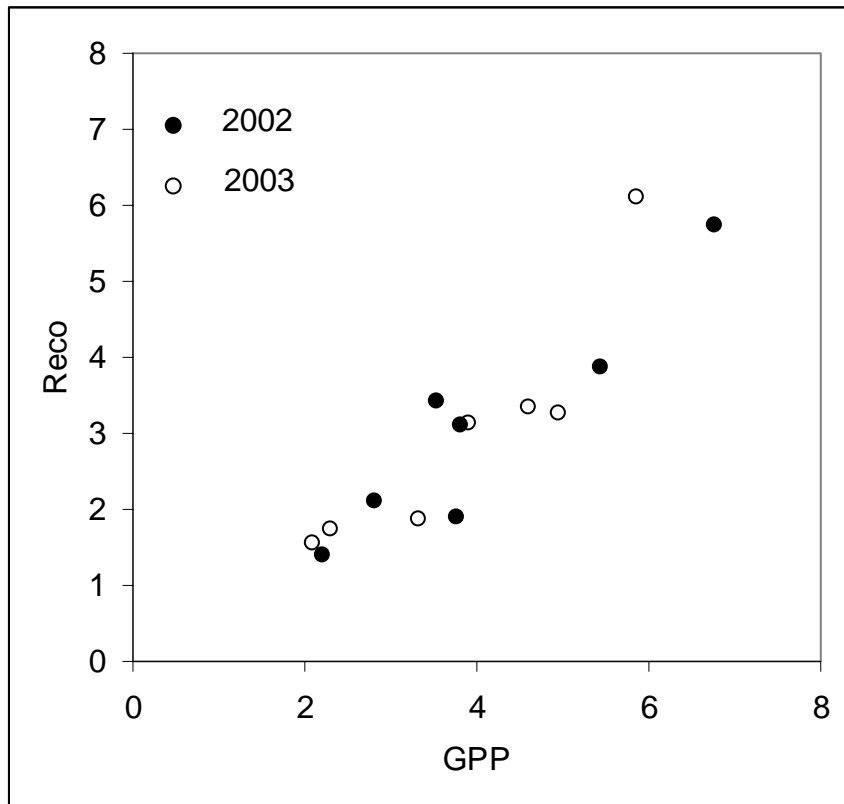

2003 modelling system

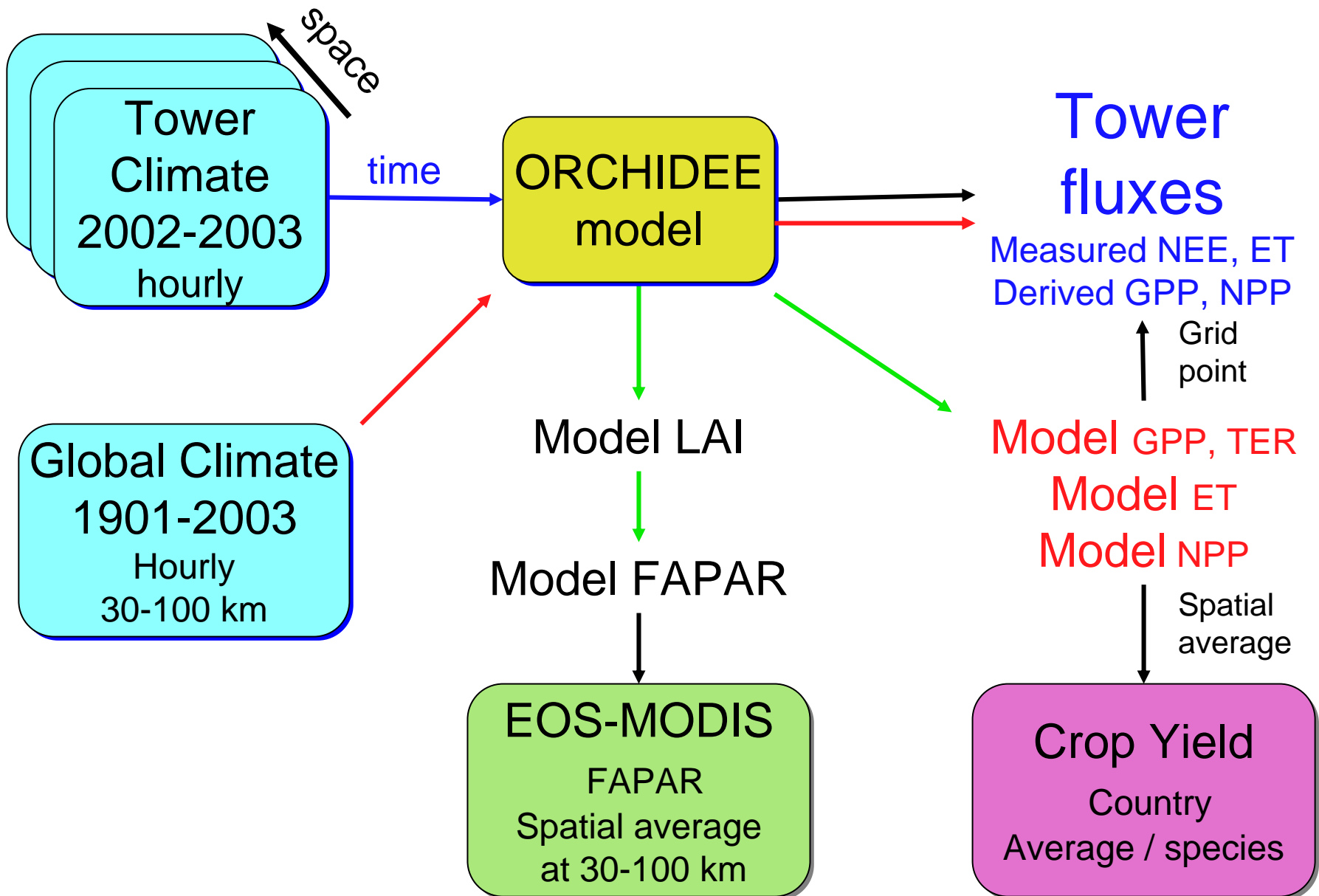

Global biospheric model ORCHIDEE

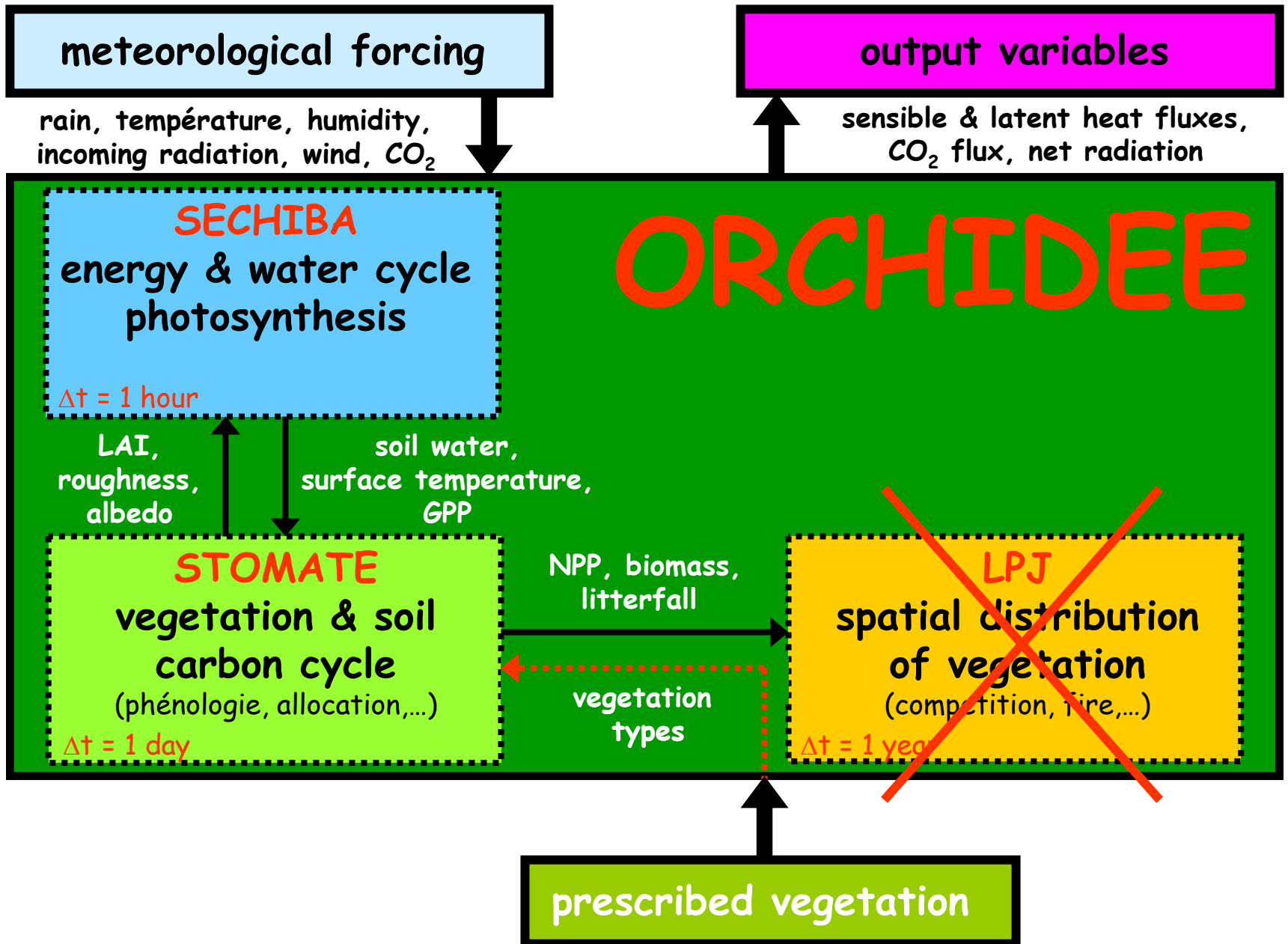

Gross and net fluxes in 2002 and 2003

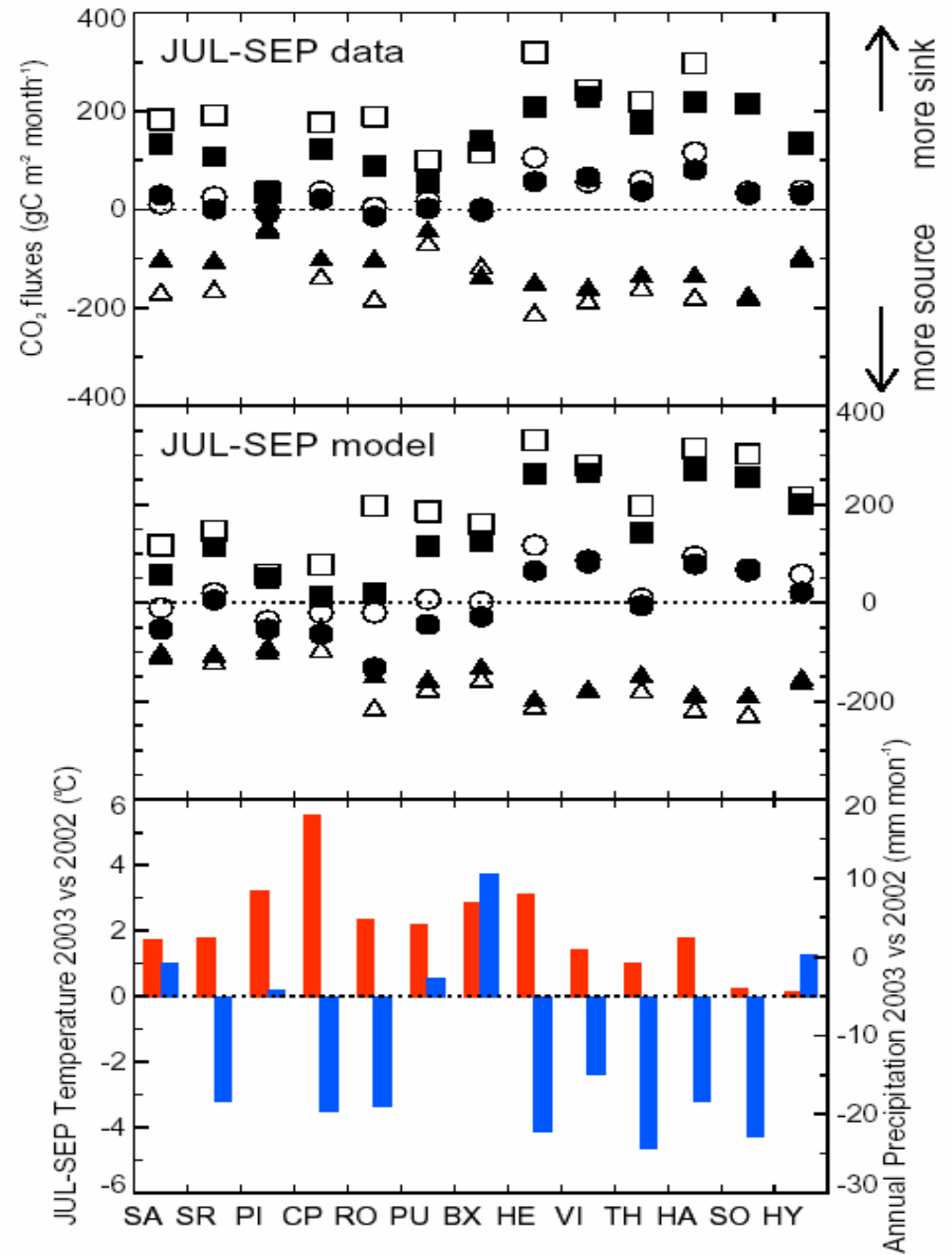

Abnormal Climate and Productivity in 2003



Model
verification with
EOS-MODIS
FAPAR

Climate

JUL-SEP Temperature 2003 vs 1998-2002

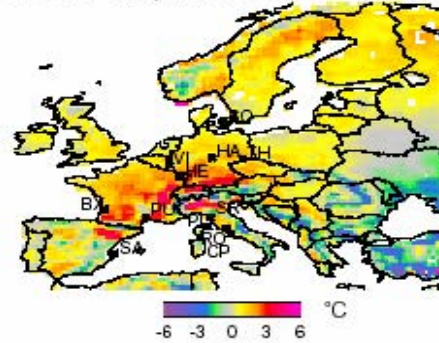

Annual Rain 2003 vs 1998-2002

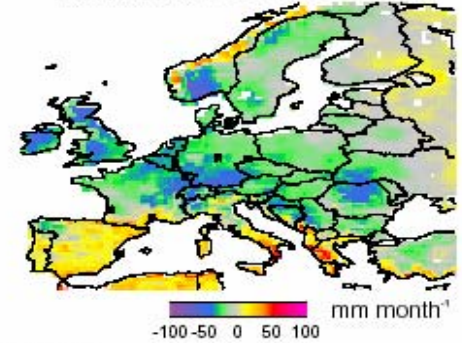

Net Primary Productivity

JUL-SEP NPP 2003 vs 1998-2002

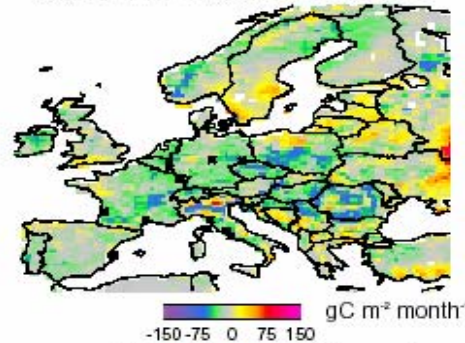

Annual NPP 2003 vs 1998-2002

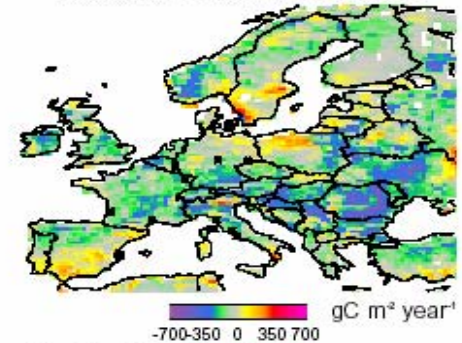

Fraction of Absorbed Photosynthetic Radiation

MODIS JUL-SEP 2003 vs 2000-2002

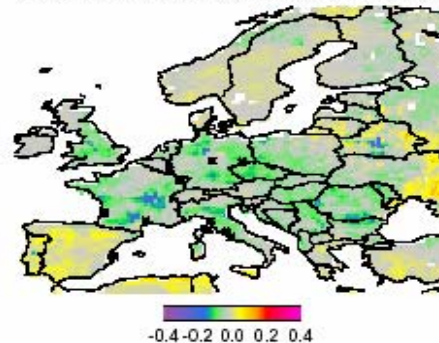

Simulated JUL-SEP 2003 vs 2000-2002

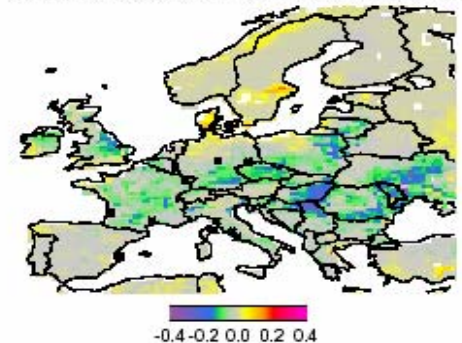

Verification against crops yield national data

QuickTime™ et un
décompresseur TIFF (LZW)
sont requis pour visionner cette image.

2003 is the largest productivity crash of the past 100 years

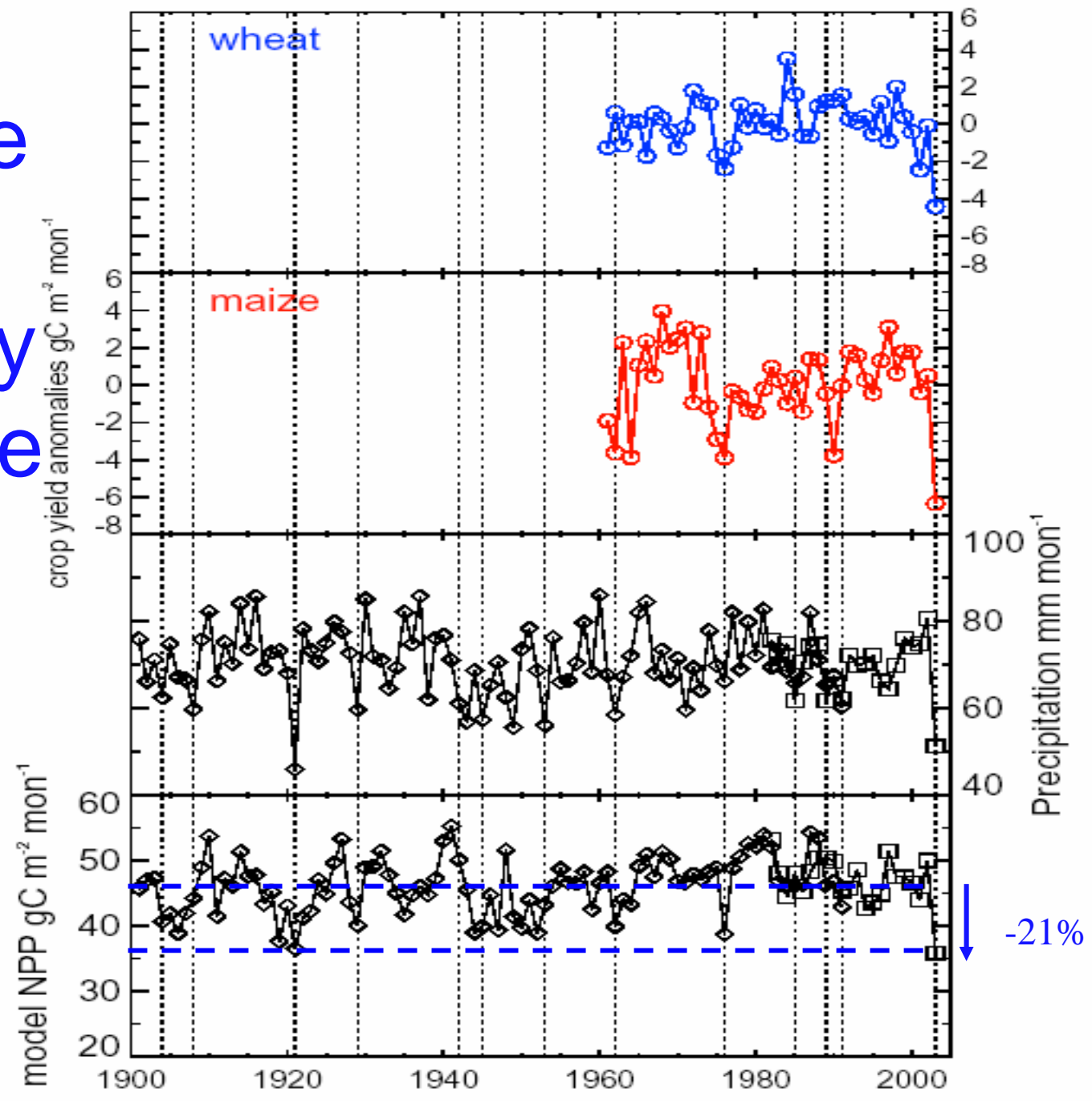

Independent tree ring verification

Hesse: seasonal variation of tree circumference as measured on beech trees among the dominant and codominant crown class during the period 1999-2003 (the same trees were measured each year).

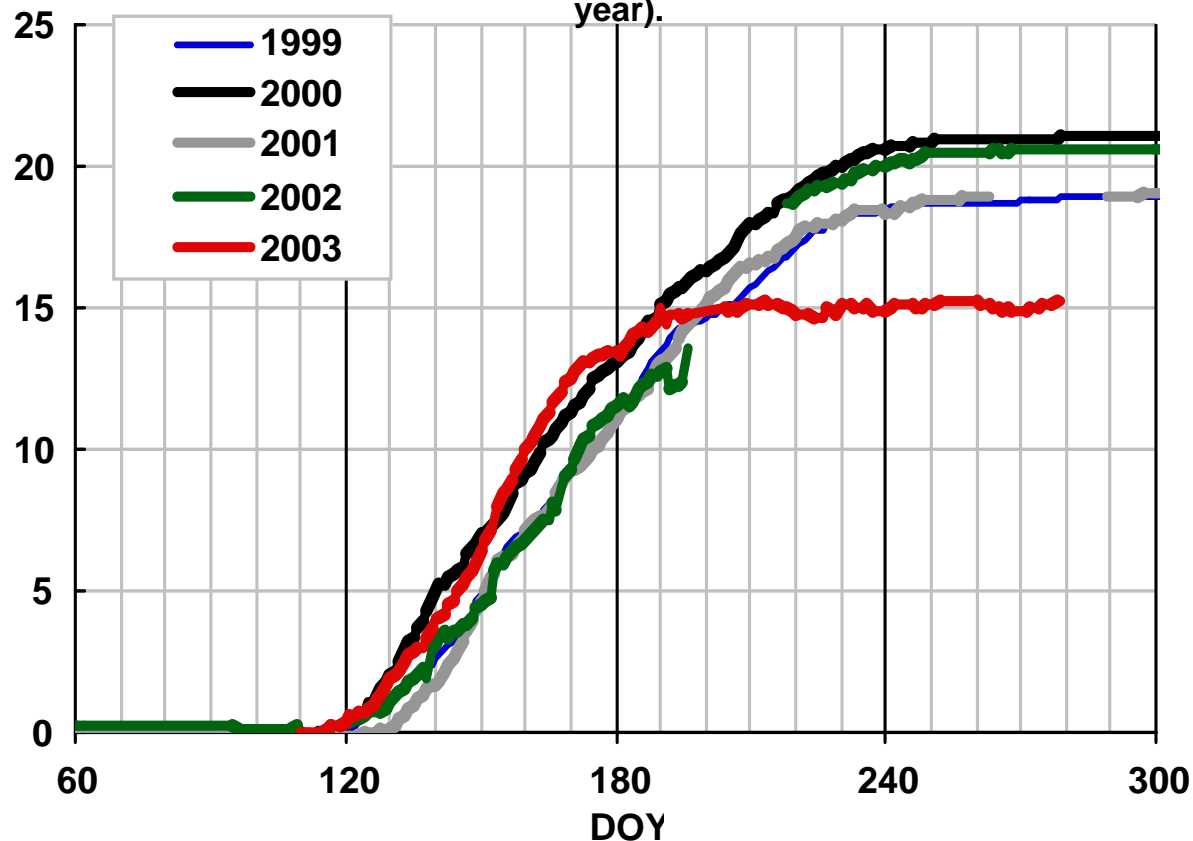

A. Granier pers. Comm

Independent Atmospheric Verification of NEE (in progress)

Monte cimone, 2100 m (Italy)

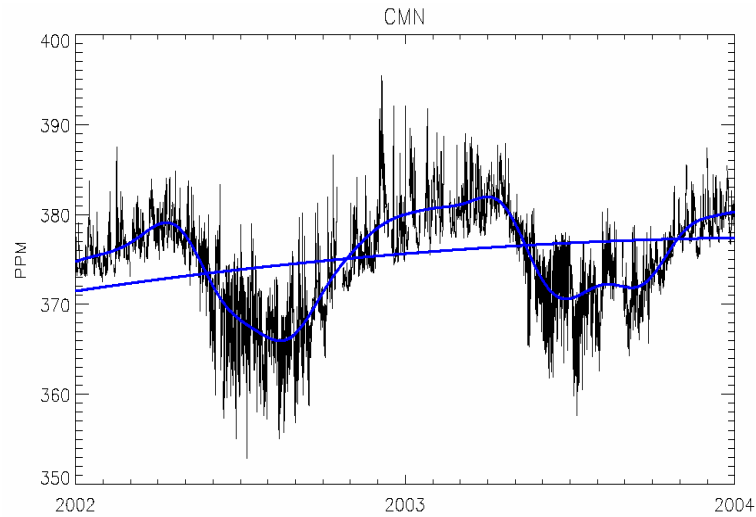

Schauinsland, 1200 m (Germany)

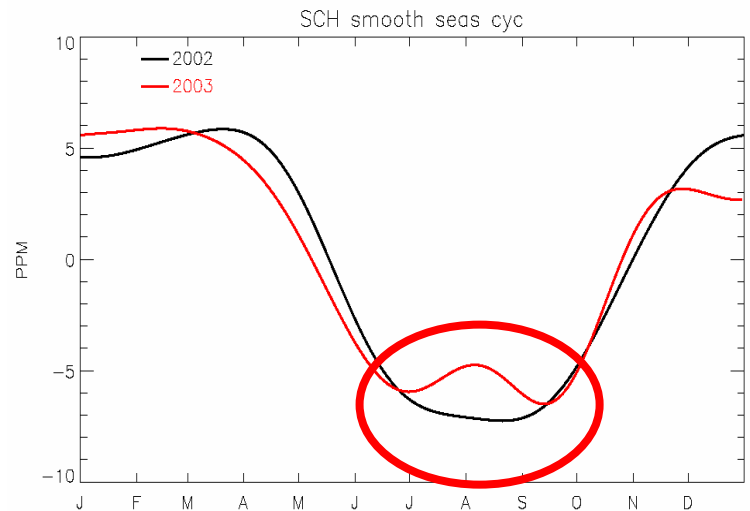
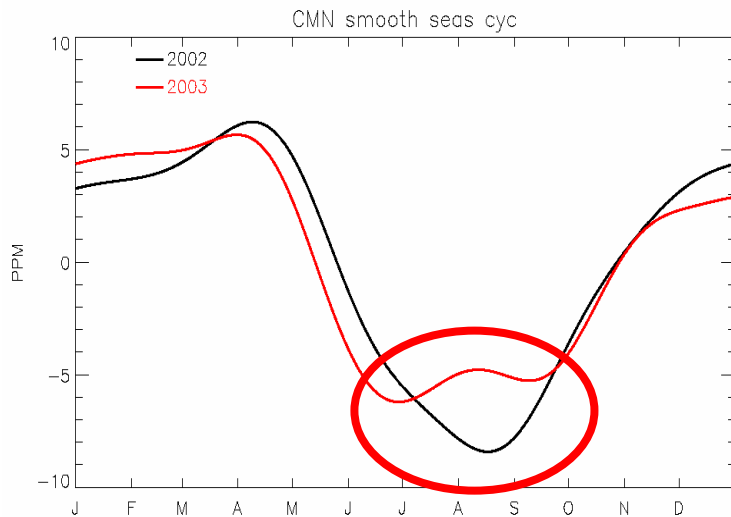
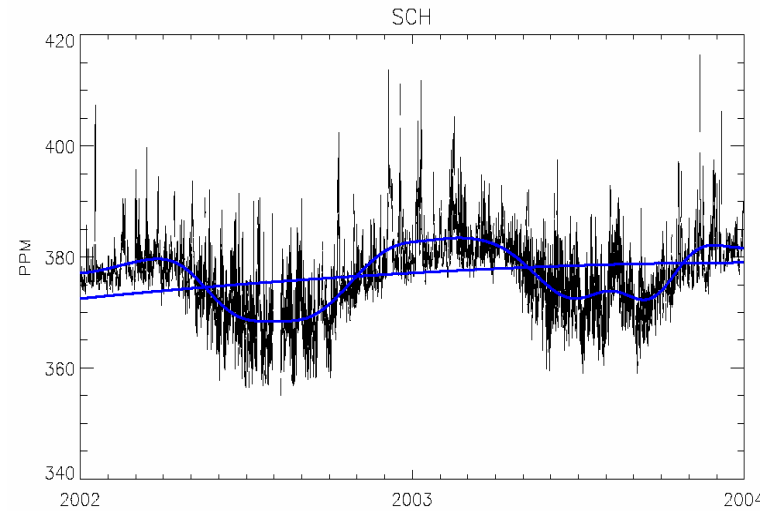

Precipitation

NPP

MAY 2003 vs 1998-2002

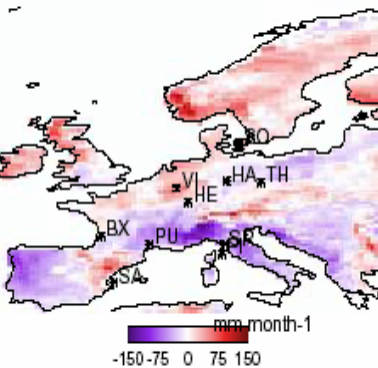

JUN 2003 vs 1998-2002

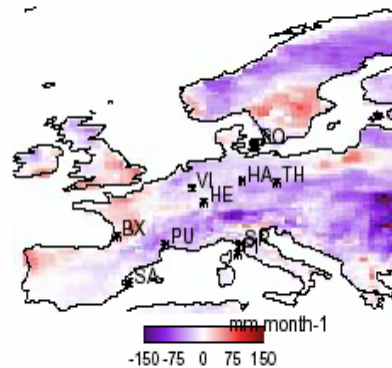

MAY 2003 vs 1998-2002

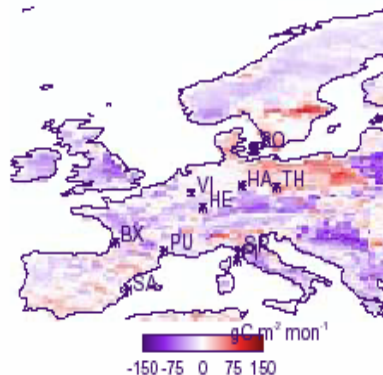

JUN 2003 vs 1998-2002

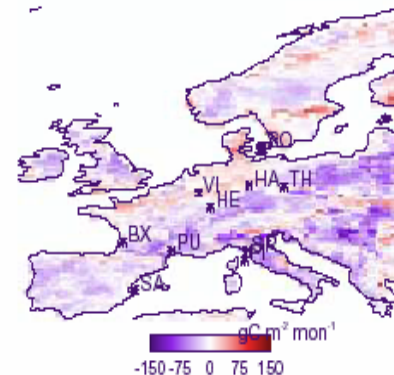

JUL 2003 vs 1998-2002

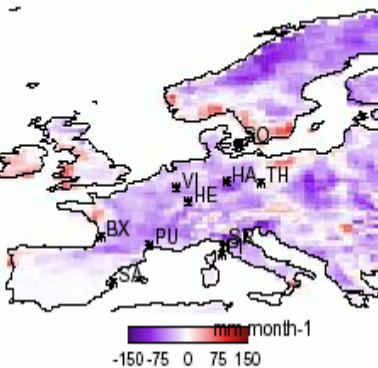

AUG 2003 vs 1998-2002

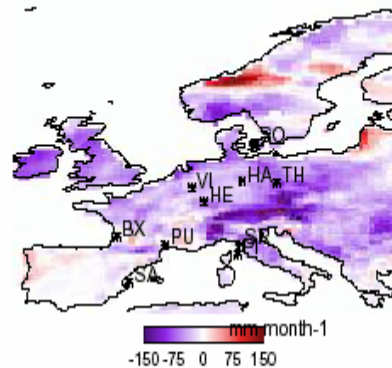

JUL 2003 vs 1998-2002

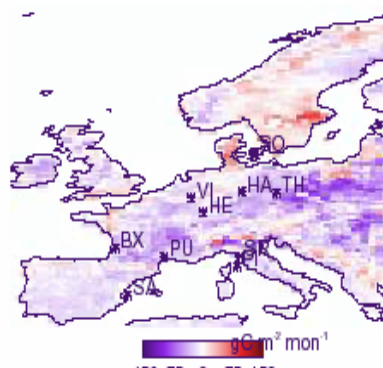

AUG 2003 vs 1998-2002

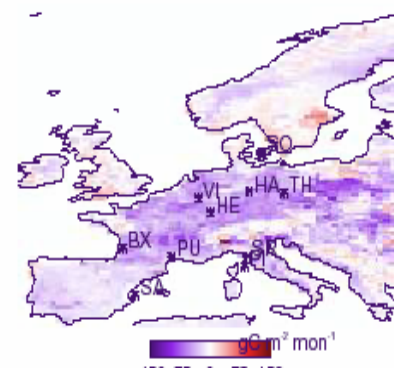

SEP 2003 vs 1998-2002

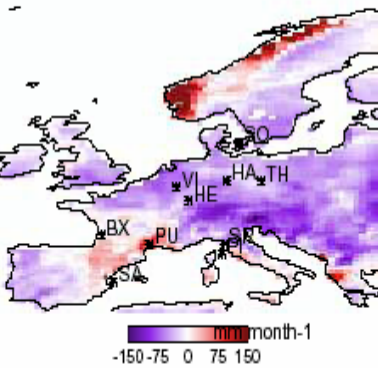

OCT 2003 vs 1998-2002

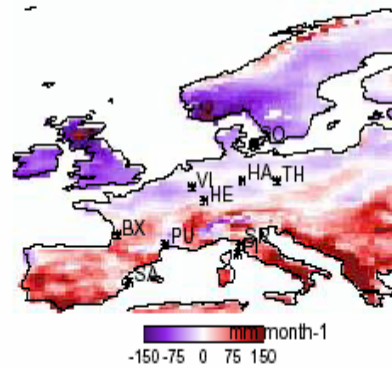

SEP 2003 vs 1998-2002

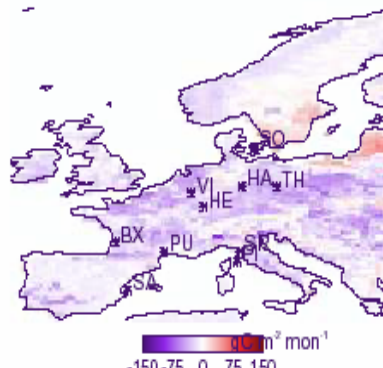

OCT 2003 vs 1998-2002

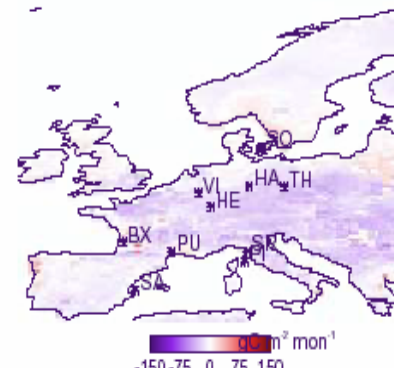

Did Rainfall deficit drives the GPP decrease ?

Model

QuickTime™ et un décompresseur TIFF (LZW) sont requis pour visionner cette image.

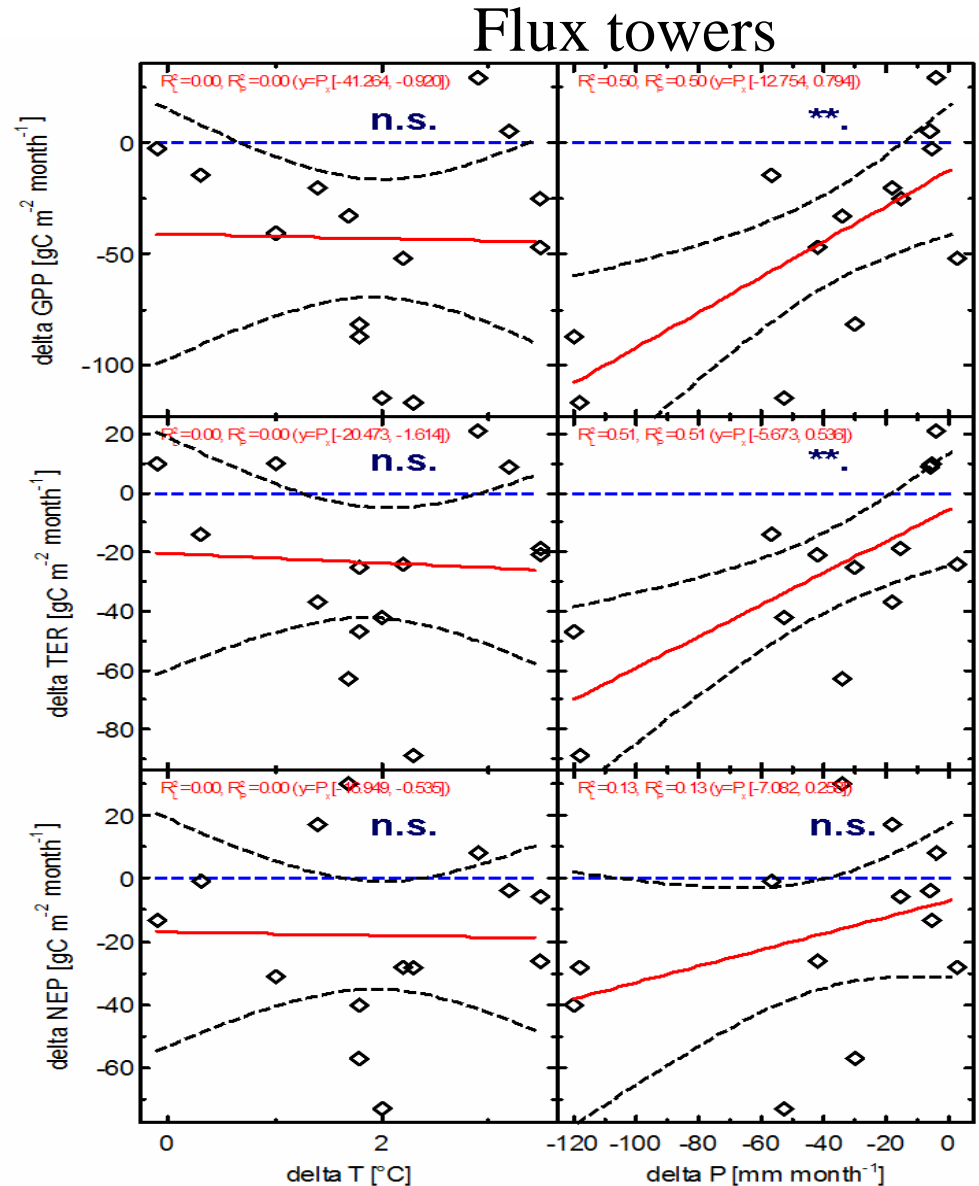

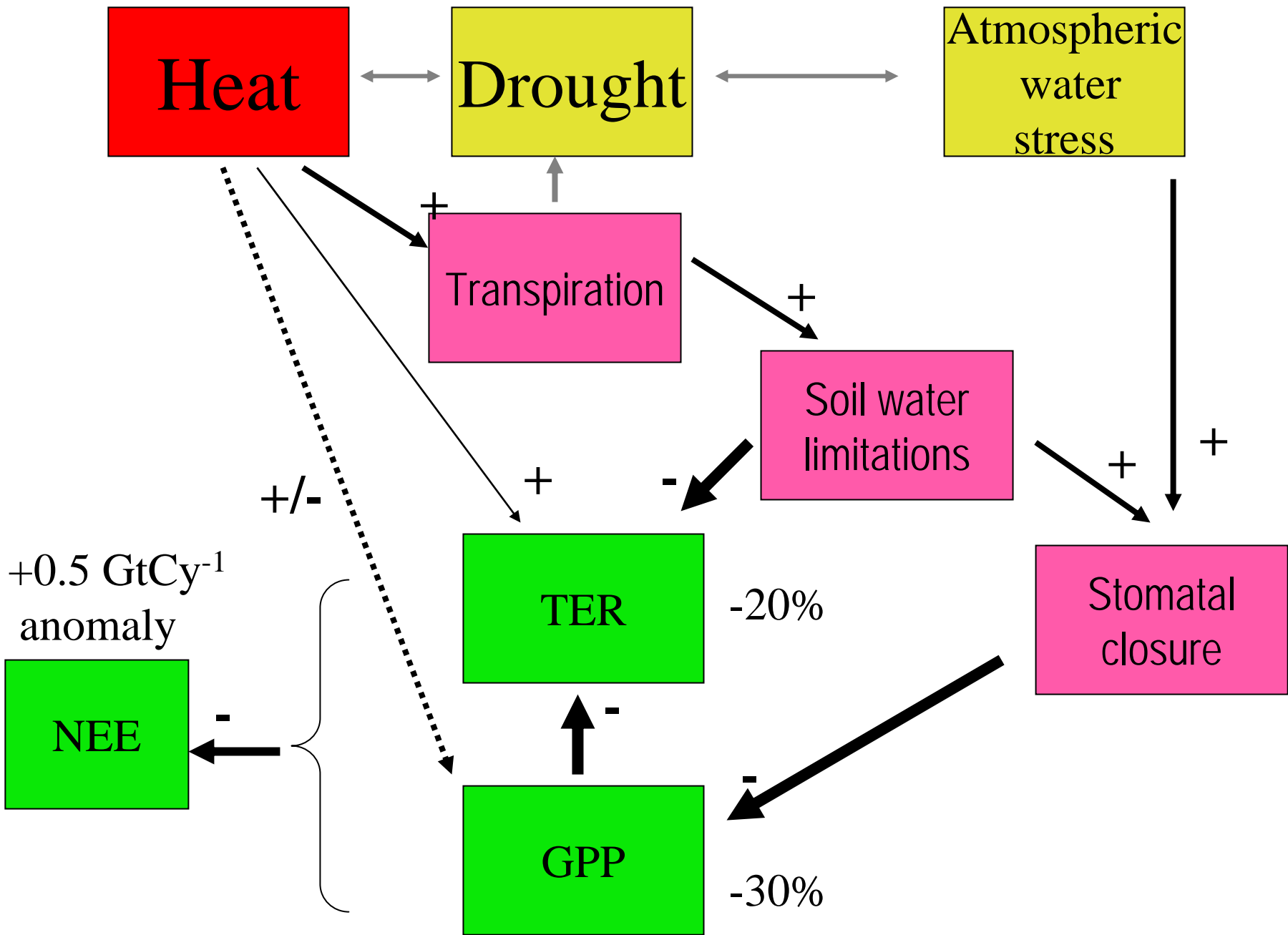

Soil water content variation model and observations indicate large water stress at all sites in 2003 with Root Extractable Water (REW) < 0.4

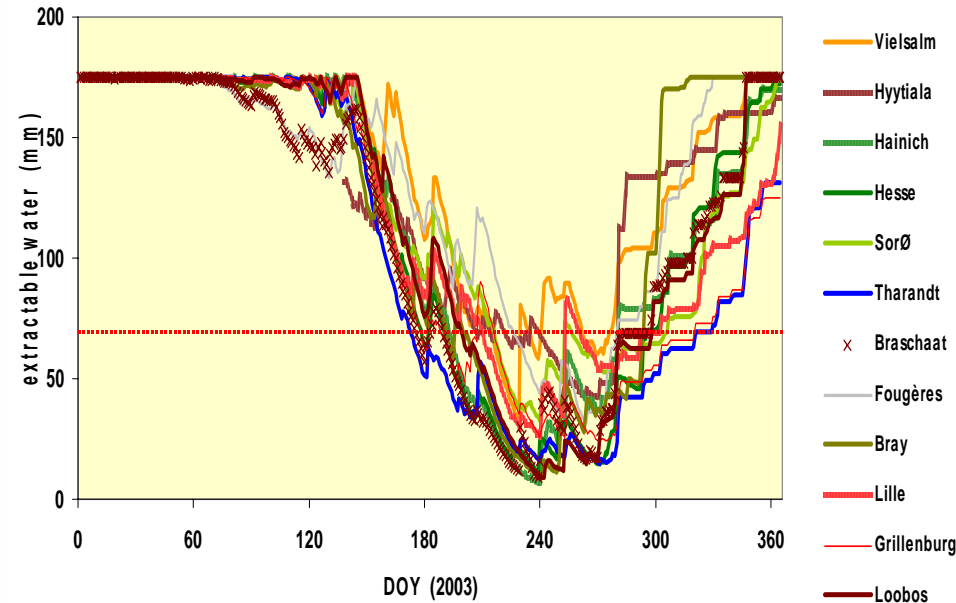
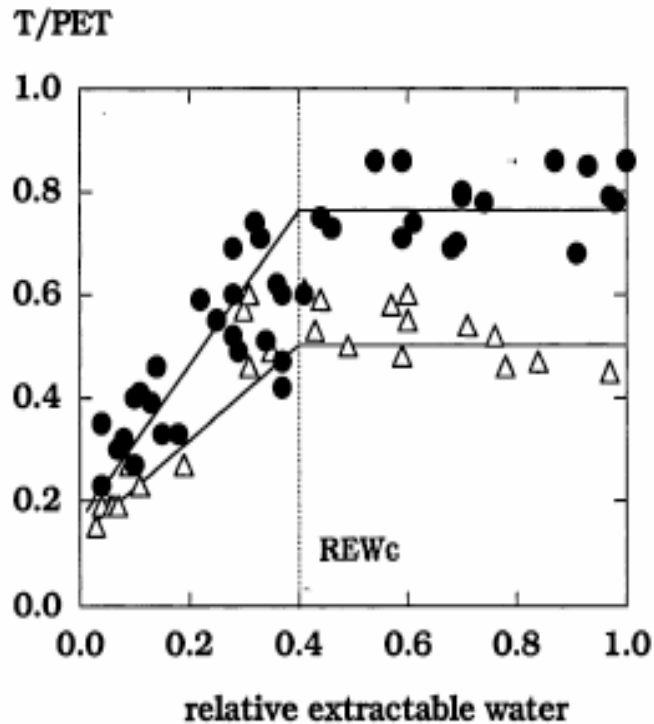
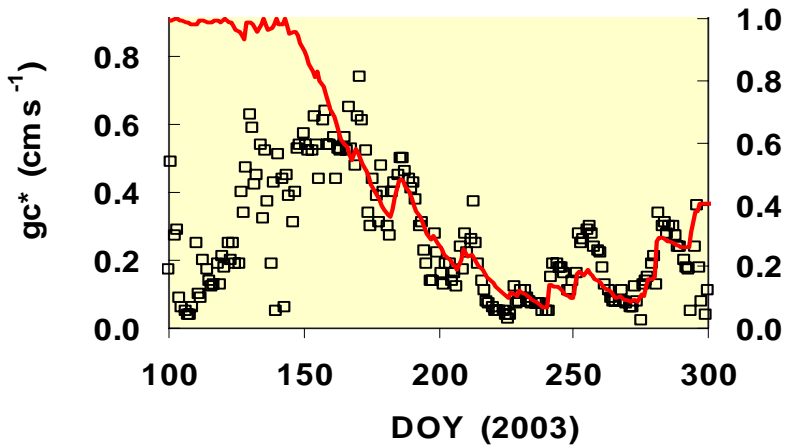

Fig. 2. Ratio T/PET calculated from sap flow measurements in an oak stand as a function of relative extractable water (REW) calculated from neutron probe measurements (from Bréda and Granier, 1996). Two data sets are reported: $LAI = 6 \text{ m}^2 \text{ m}^{-2}$ (black circles) and $LAI = 4.5 \text{ m}^2 \text{ m}^{-2}$ (open triangles). The dotted line shows the critical REW (REW_c).

Breda et al. 1999

Granier et al. analysis confirms water-stress controls

Canopy conductance
correlates with soil water
stress



Canopy conductance in 2003 at Hesse was 15% of its 2002 value !

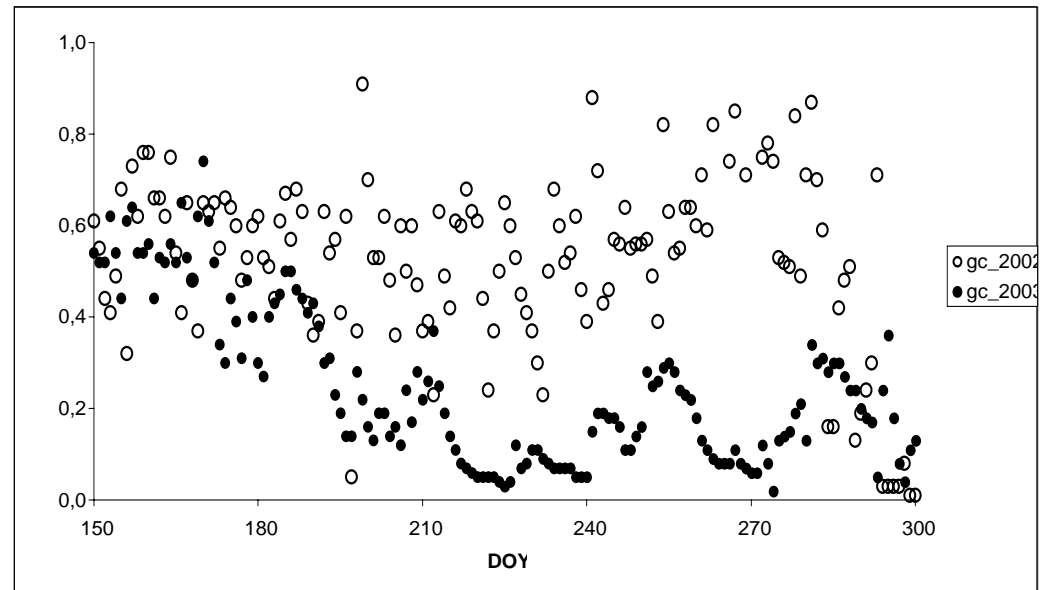

Modellers, be brave !

test your best parameters for 2003!

See also Wang et al. , Poster by Santaren, etc..

BIOME-BGC Model Parameters

Deciduous broadleaf forest

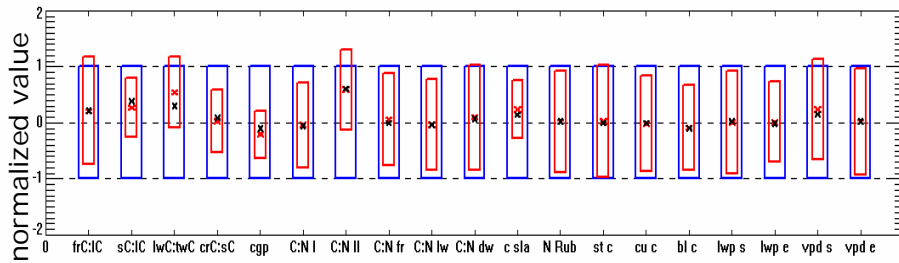

Evergreen needle leaf forest

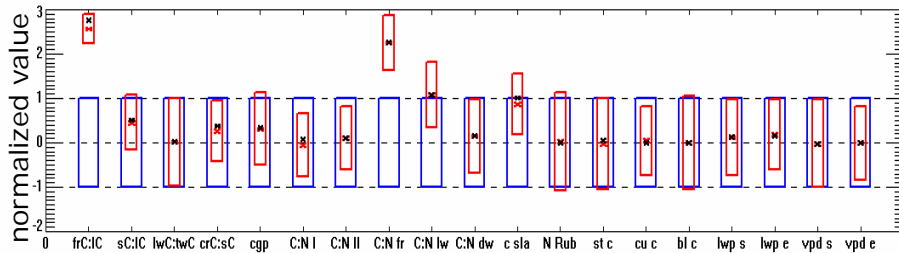

ecophysiological parameters

Parameter range before optimization

Parameter range after optimization

Model Results NEE

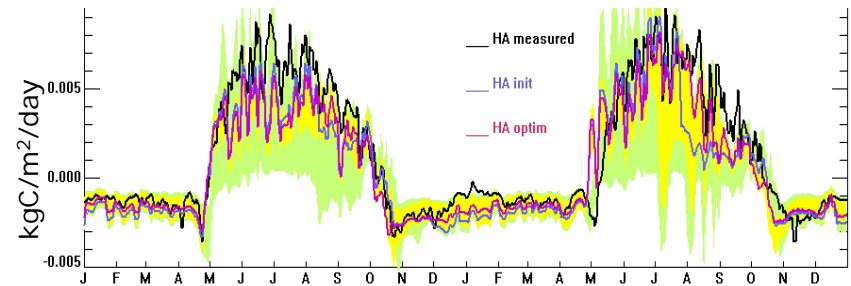

Leaf Area Index

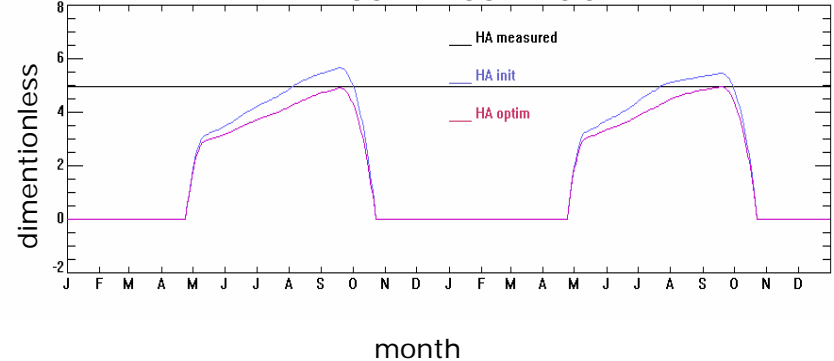

Trusilova and Churkina
in preparation

Joint constraints! Complementary methods 3. Regional Inversions

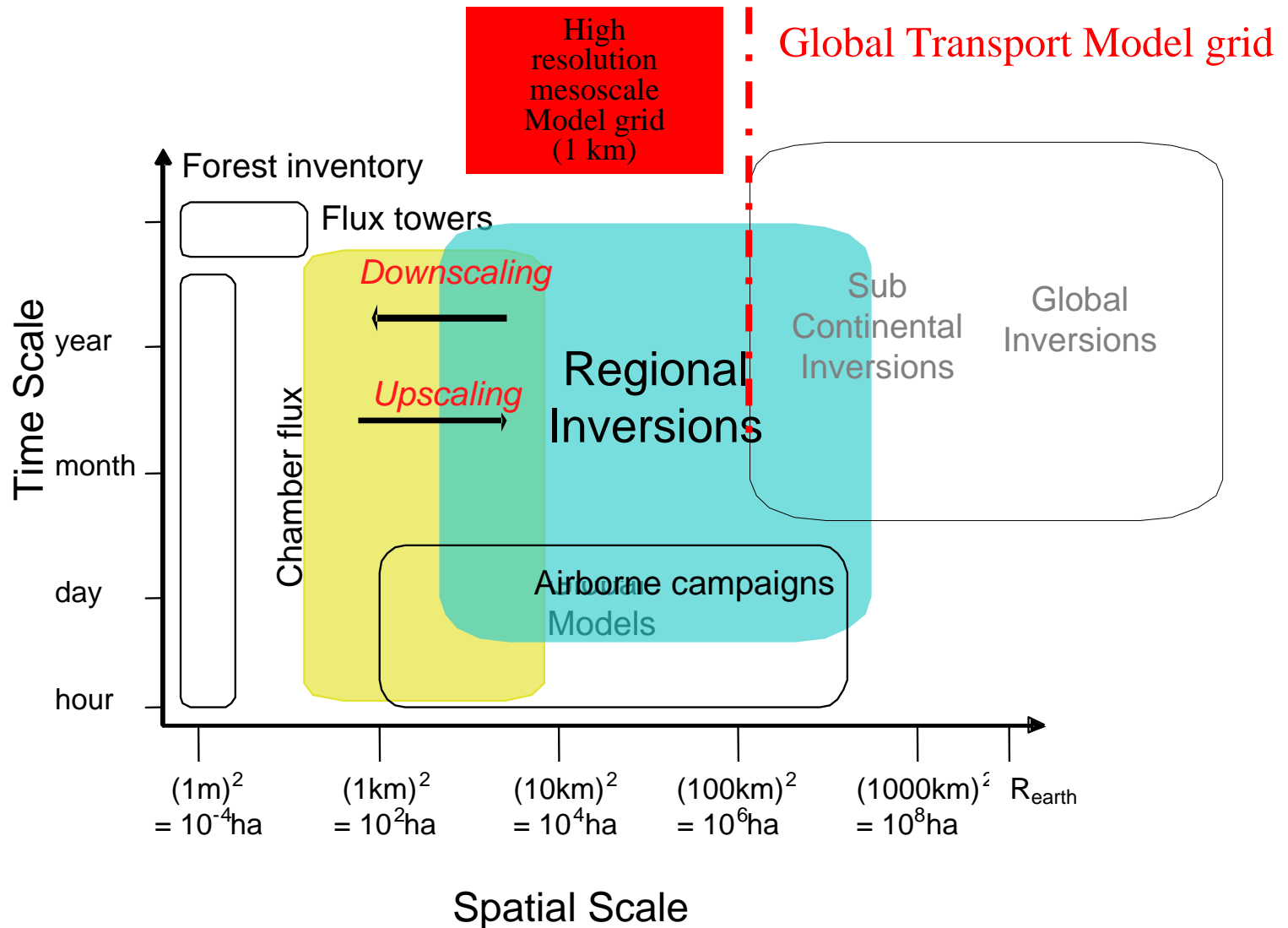

WLEF CO₂ flux and mixing ratio observatory

K. Davis and colleagues

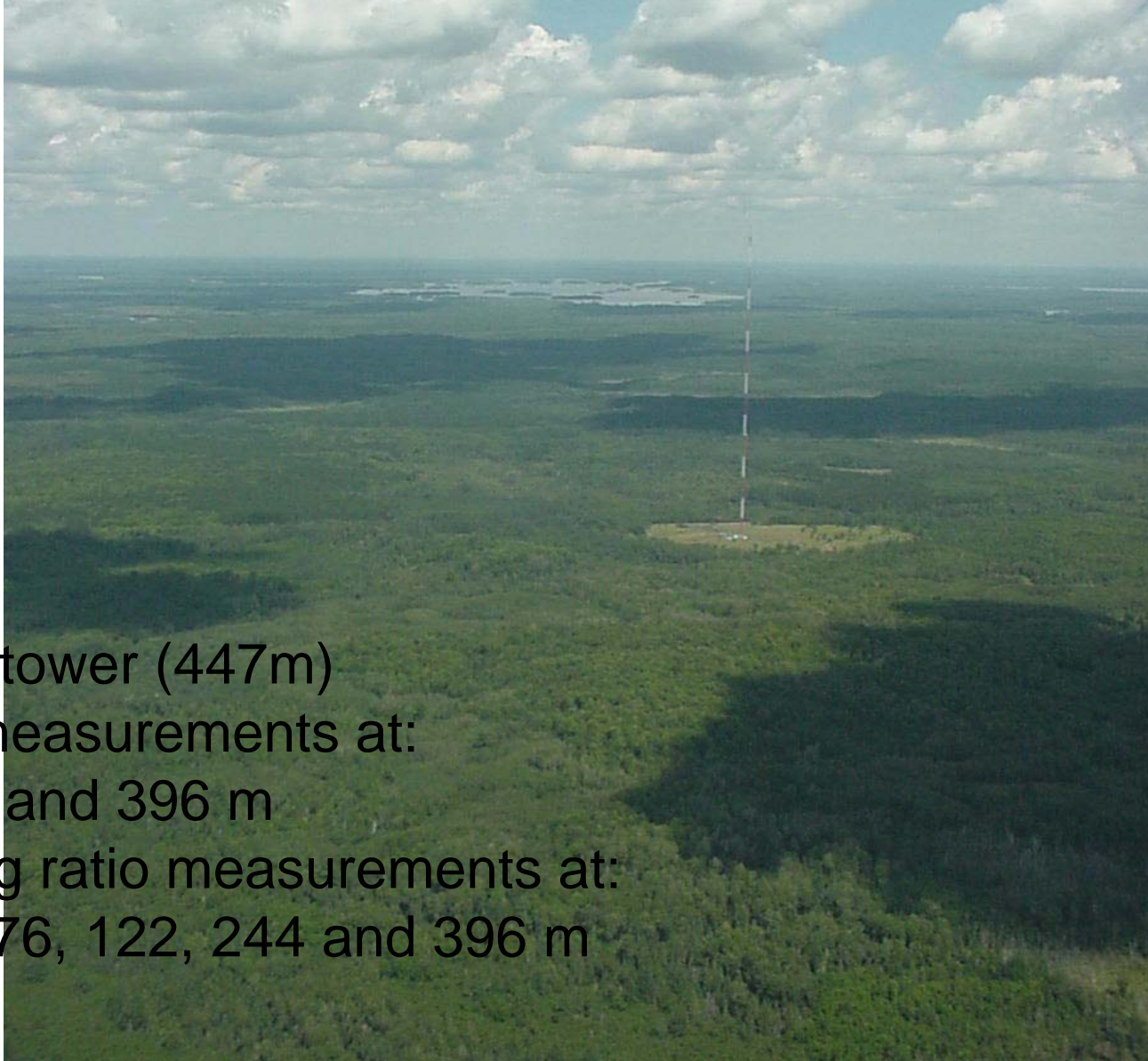

WLEF tall tower (447m)

CO₂ flux measurements at:

30, 122 and 396 m

CO₂ mixing ratio measurements at:

11, 30, 76, 122, 244 and 396 m

Photo credit: UND Citation crew, COBRA

ChEAS Regional Flux Experiment Domain

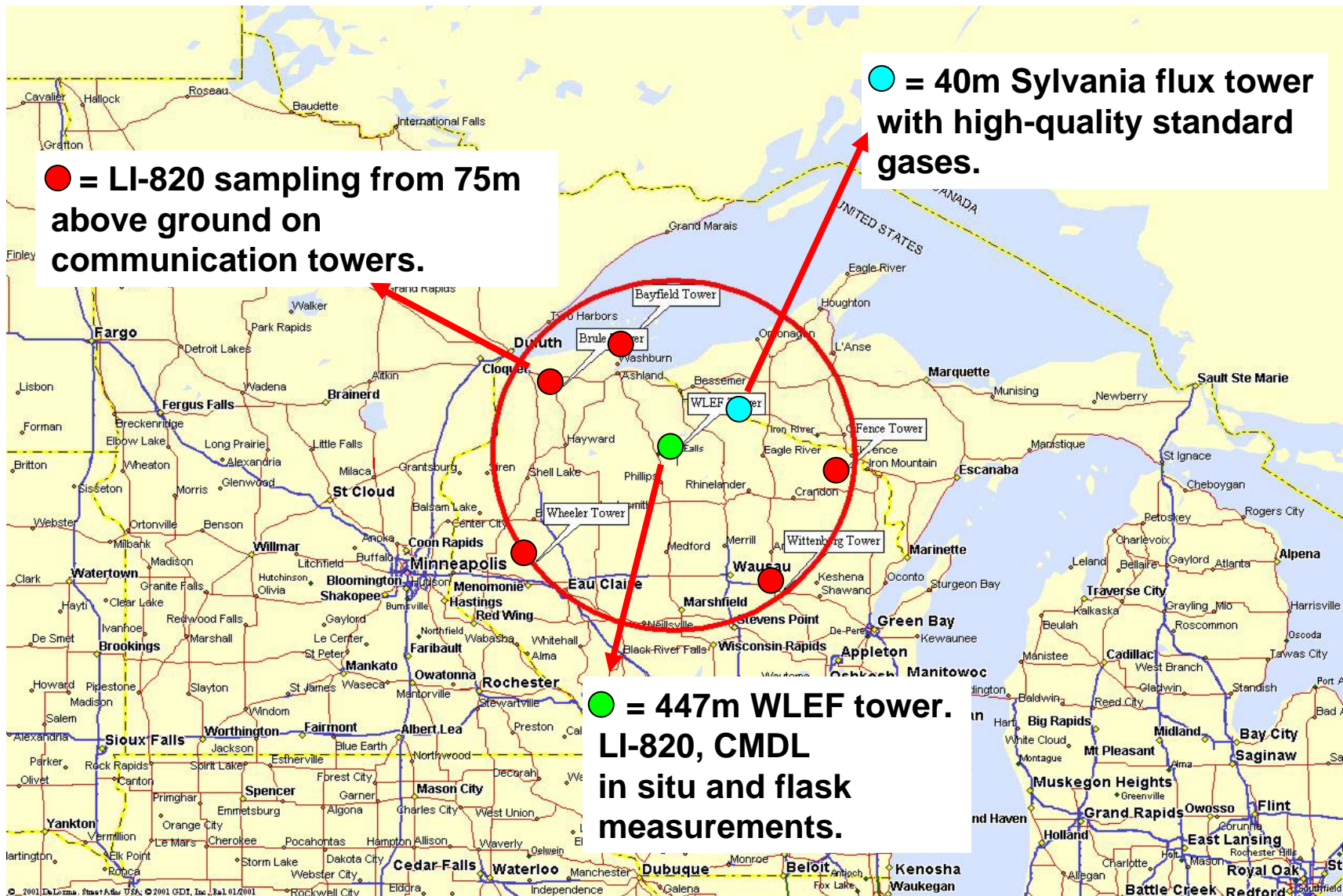

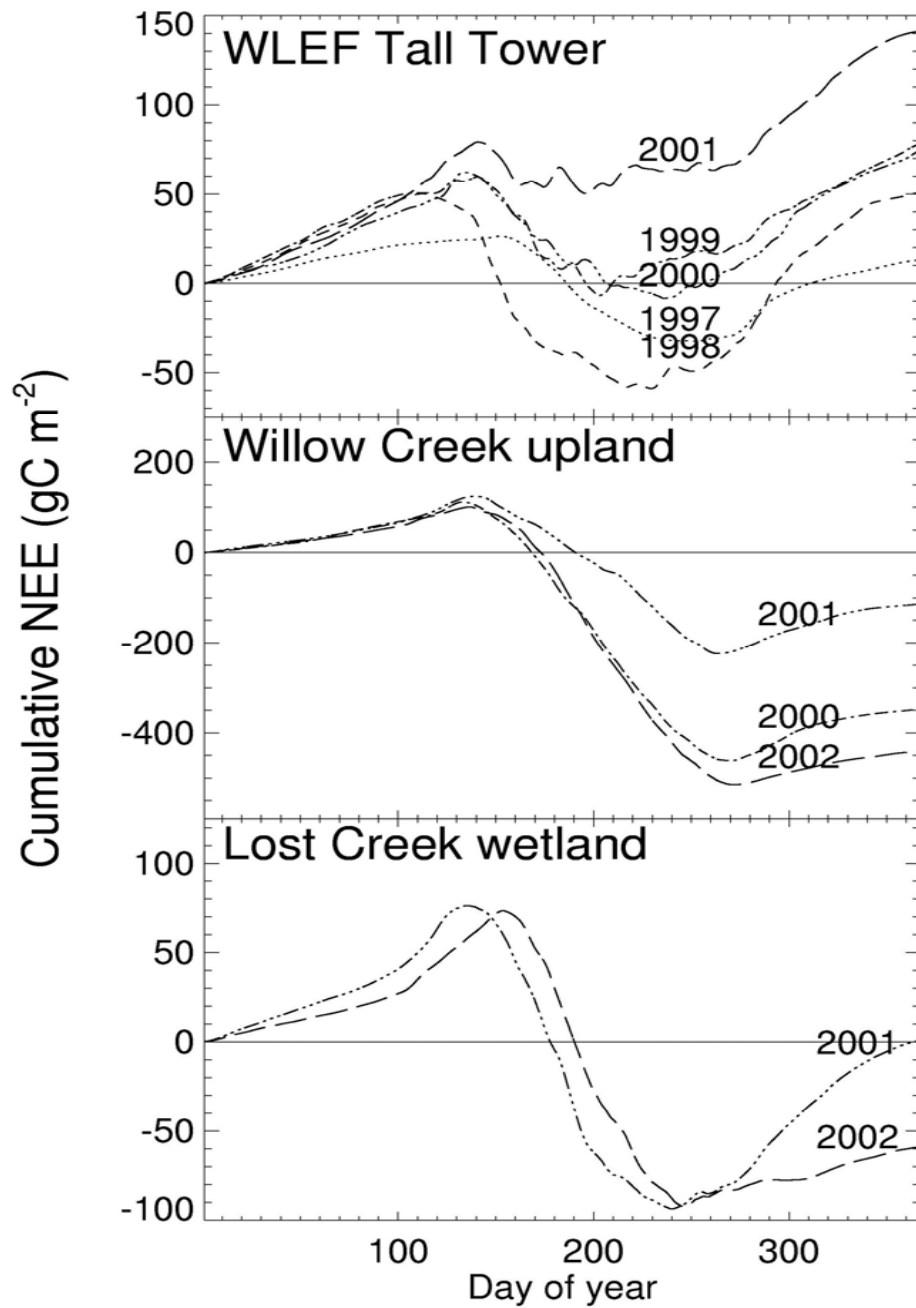

NEE and gross fluxes at ChEAS sites: 1997-2002

| | NEE (gC m ⁻²) | Respiration (gC m ⁻²) | Photosynthesis (gC m ⁻²) |
|-----------------------------|------------------------------|--------------------------------------|---|
| WLEF 1997 | 27 | 991 | 964 |
| WLEF 1998 | 48 | 986 | 938 |
| WLEF 1999 | 100 | 1054 | 954 |
| WLEF 2000 | 74 | 1005 | 931 |
| WLEF 2001 | 141 | 1067 | 926 |
| WLEF average | 78 | 1021 | 942 |
| Willow Creek 2000 | -347 | 762 | 1109 |
| Willow Creek 2001 | -108 | 741 | 849 |
| Willow Creek 2002 | -437 | 648 | 1085 |
| Willow Creek average | -297 | 717 | 1014 |
| Lost creek 2001 | 1 | 759 | 758 |
| Lost Creek 2002 | -58 | 631 | 689 |
| Lost Creek average | -30 | 695 | 724 |

ChEAS Regional Flux Experiment

- Derive daytime and daily seasonal fluxes using regional atmospheric inversions and relatively inexpensive in situ CO₂ sensors.
- Overarching goal – evaluate/merge multiple approaches of studying terrestrial fluxes of CO₂.
 - Merge flux-tower based upscaling with downscaled inversion methodology. Regional integration and mechanistic interpretation.
 - Determine interannual variations in seasonal fluxes on a regional basis. Again, integrate with regional flux measurements/mechanistic interpretations.
 - If possible, derive net annual fluxes. Spatial resolution is limited by the magnitude of the annual signal.

Expected Regional Mixing Ratio Differences (Winter to Summer)

| Time scale | Daytime | Diurnal | Annual |
|-----------------------------|---|--|--|
| Flux magnitude | 1 to 10 $\mu\text{mol m}^{-2} \text{s}^{-1}$ | 1 to 4 $\text{gC m}^{-2} \text{d}^{-1}$ | ~ 1 $\text{gC m}^{-2} \text{d}^{-1}$ |
| Mixing depth | 1 to 2 km | 1 to 2 km | ~ 10 km |
| Advection time | ~ 10 hours | ~ 24 hours | |
| Advection distance | ~ 180 km (half ring) | ~ 400 km (full ring) | 400 km (full ring) |
| Change in ABL CO_2 | 1 to 5 ppm | 2 to 5 ppm | ~ 0.2 ppm |

Climatology of influence functions for August 2000

- influence functions derived from RAMS/LPD model simulations
- passive tracer
- different configurations of concentration samples - time series from
 - a single level of WLEF tower
 - all levels of WLEF tower
 - six additional towers

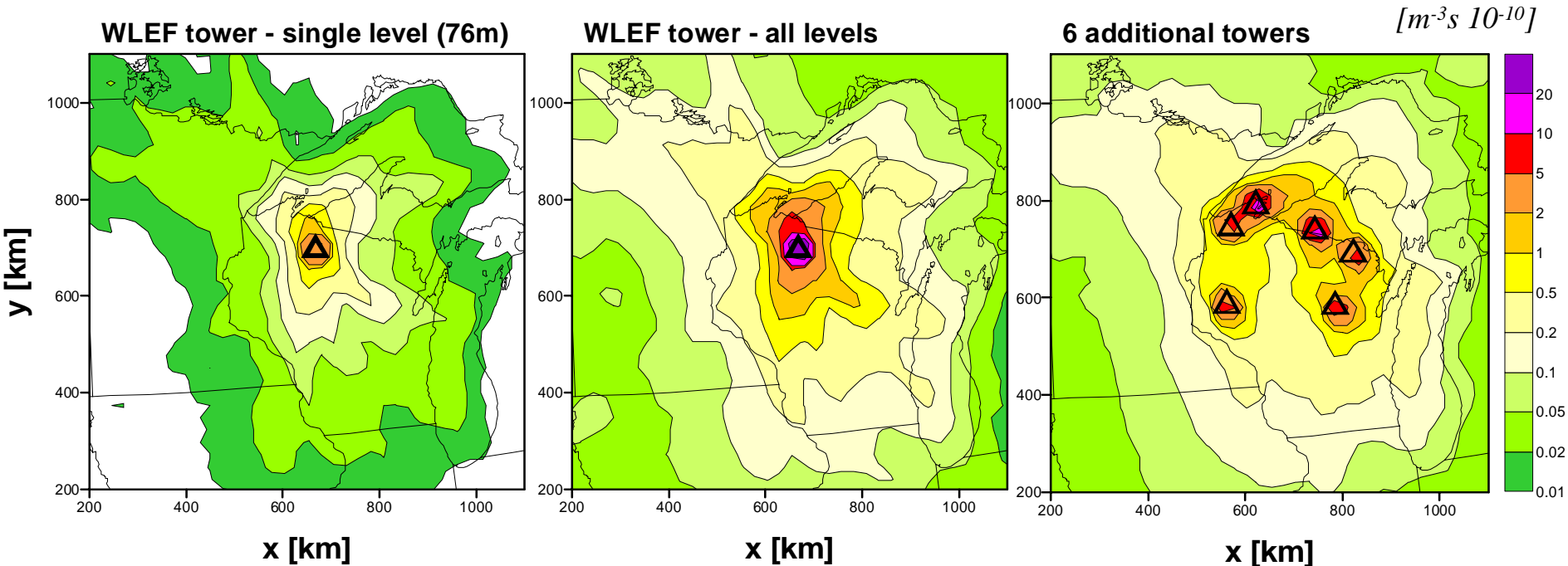

Regional Inversions

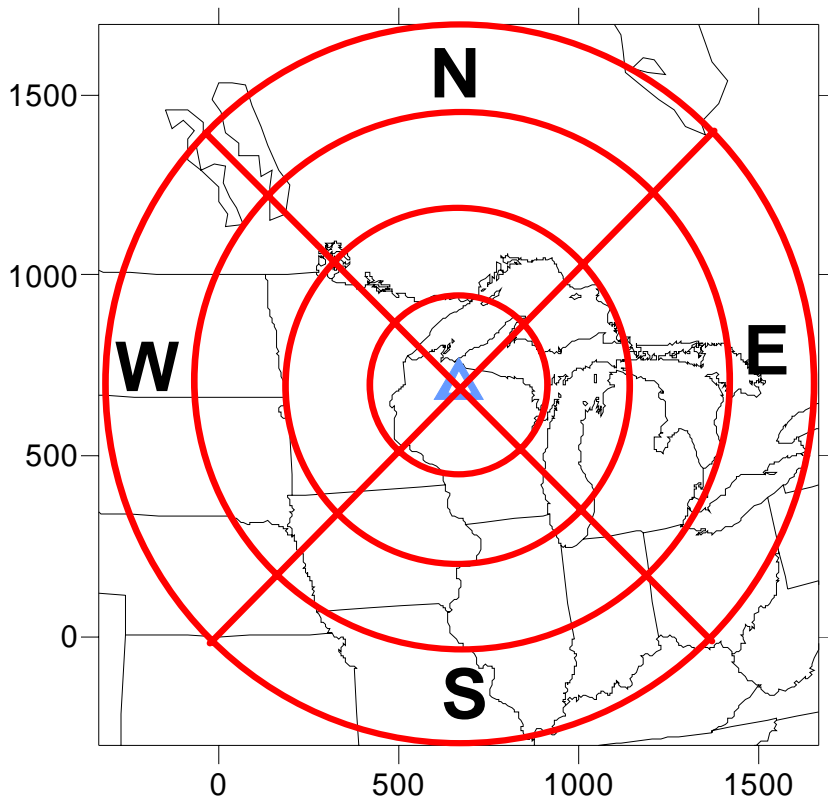

Separate estimation of
 $A(\text{PAR})$, $R(\text{T})$, FF

- Bayesian inversion technique
- source areas defined in polar coordinates centered at the WLEF tower
 - a better coverage by atmospheric transport
- [RAMS -> LPD] long term simulations
 - derivation of influence functions for concentration samples
- data: concentration time series from the WLEF tower and additional towers
- CO_2 flux decomposed into respiration and assimilation fluxes
- CO_2 inflow fluxes from a larger scale model
 - a priori estimations to be improved in inversion calculations

Example of estimation of NEE averaged for August 2000

- ✓ Inversion calculations for increasing number of concentration data (time series from towers)
- ✓ NEE uncertainty presented in terms of standard deviation derived from posteriori covariance matrix
- ✓ Inflow CO_2 flux is assumed to be known from a large scale transport model

Configuration of source areas with WLEF tower in the center of polar coordinates

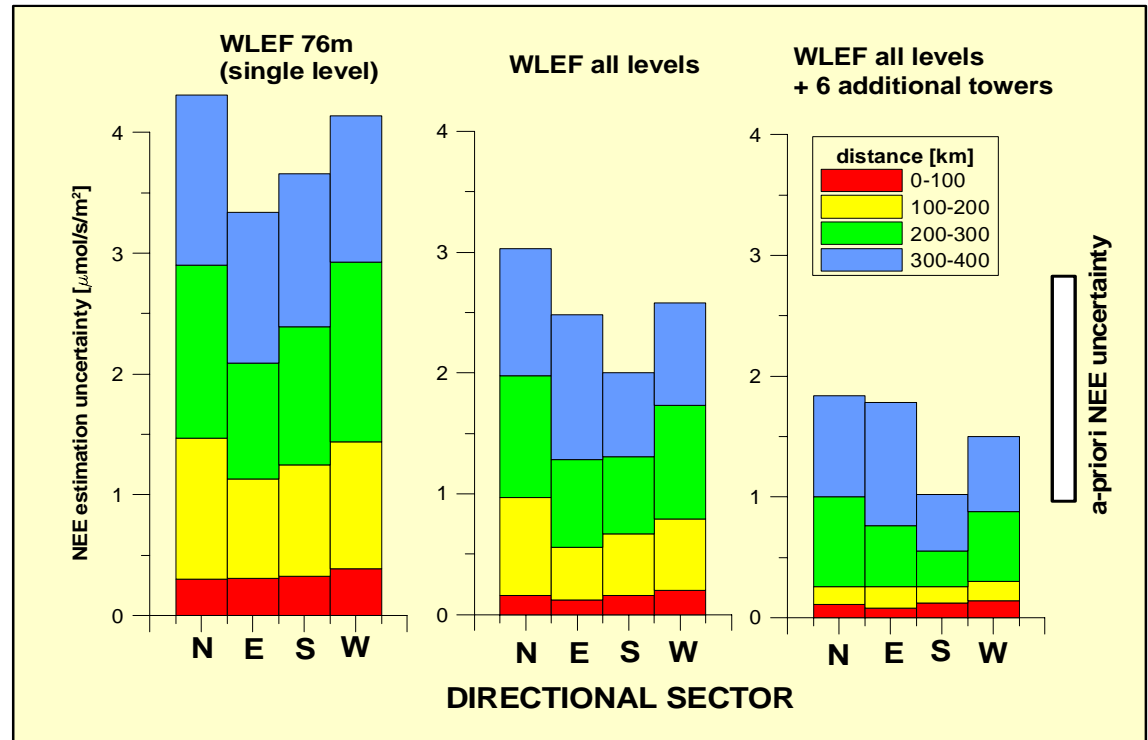
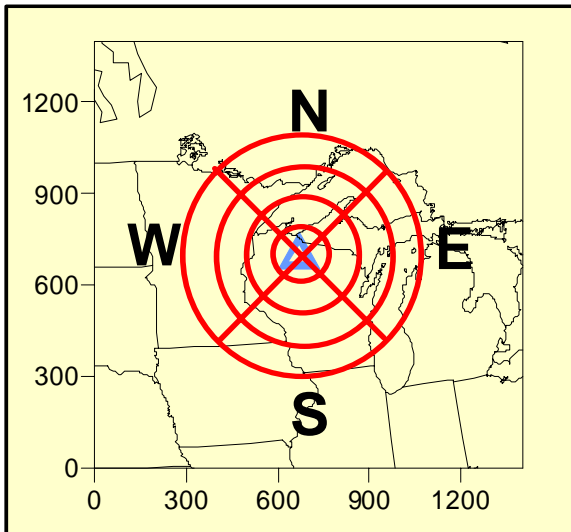

CO2 from 5 sites, April 29, 2004

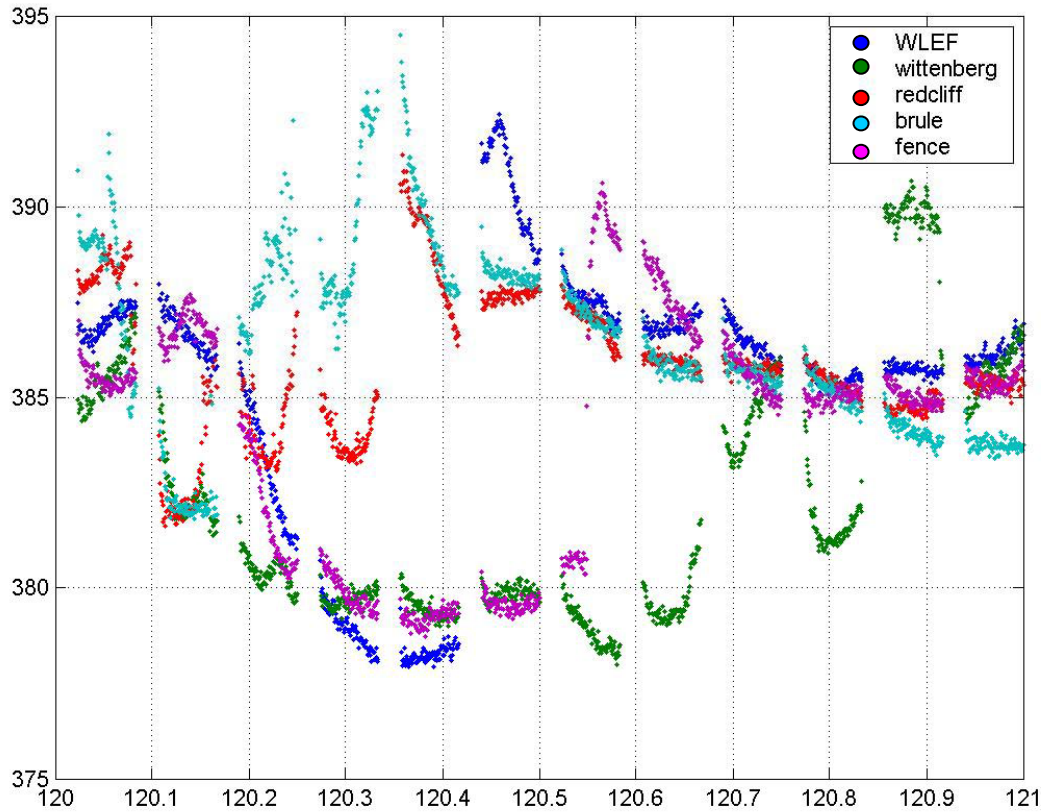

1200 UTC April 29, 2004

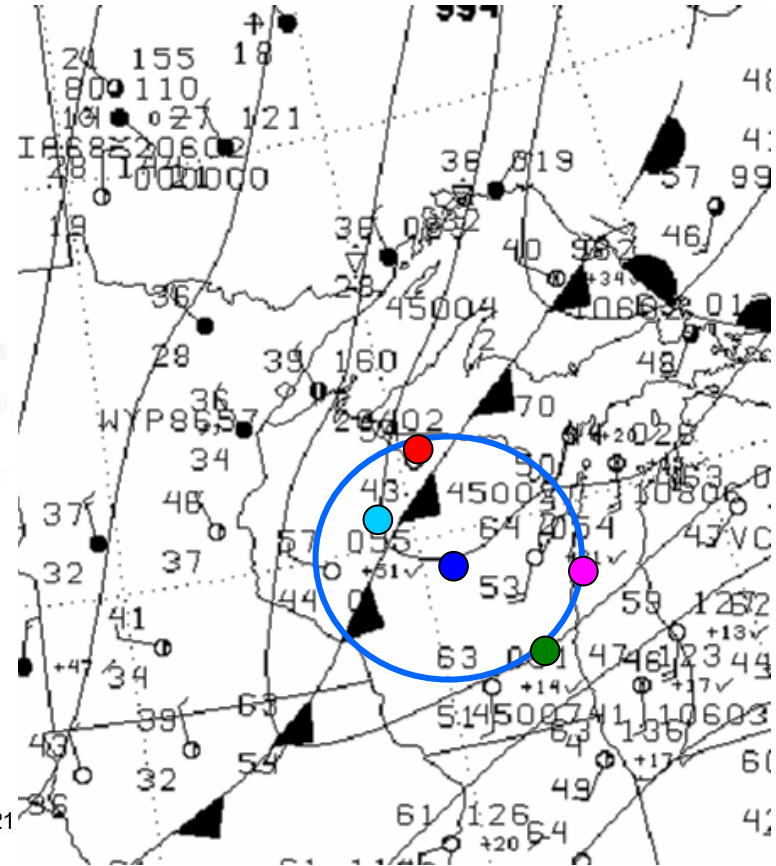

Joint constraints! Complementary methods : Airborne campaigns

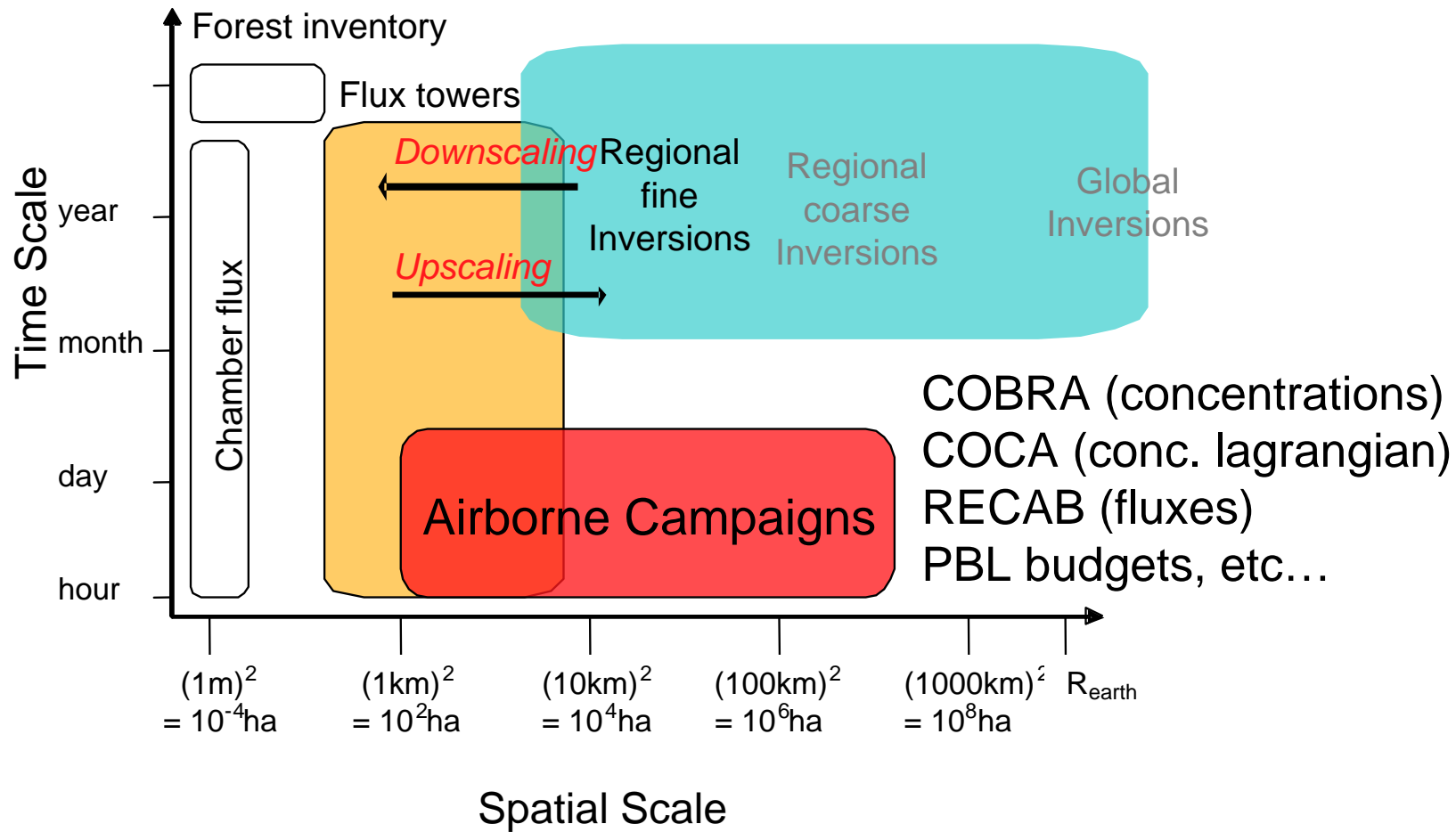

Atmospheric and bottom-up regional fluxes in Les landes

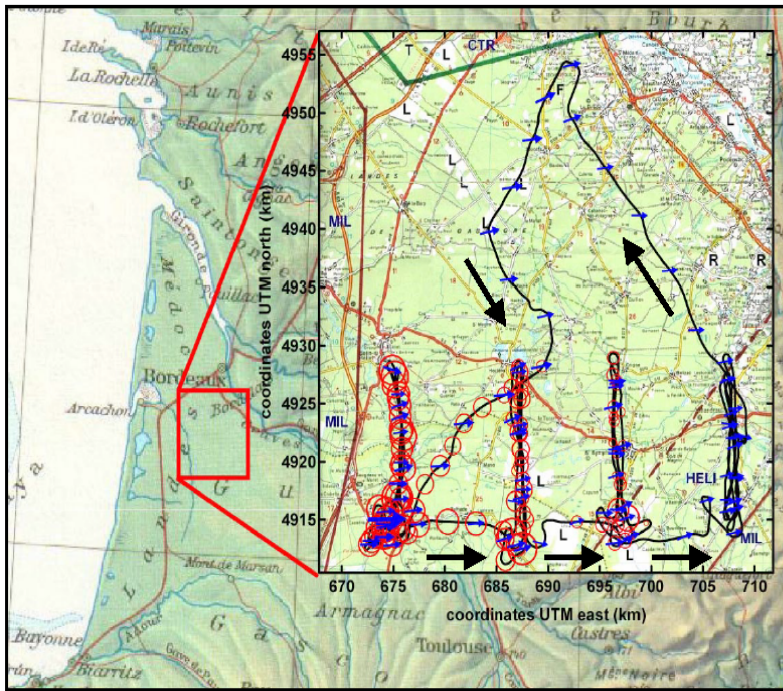

Schmitgen et al. 2004

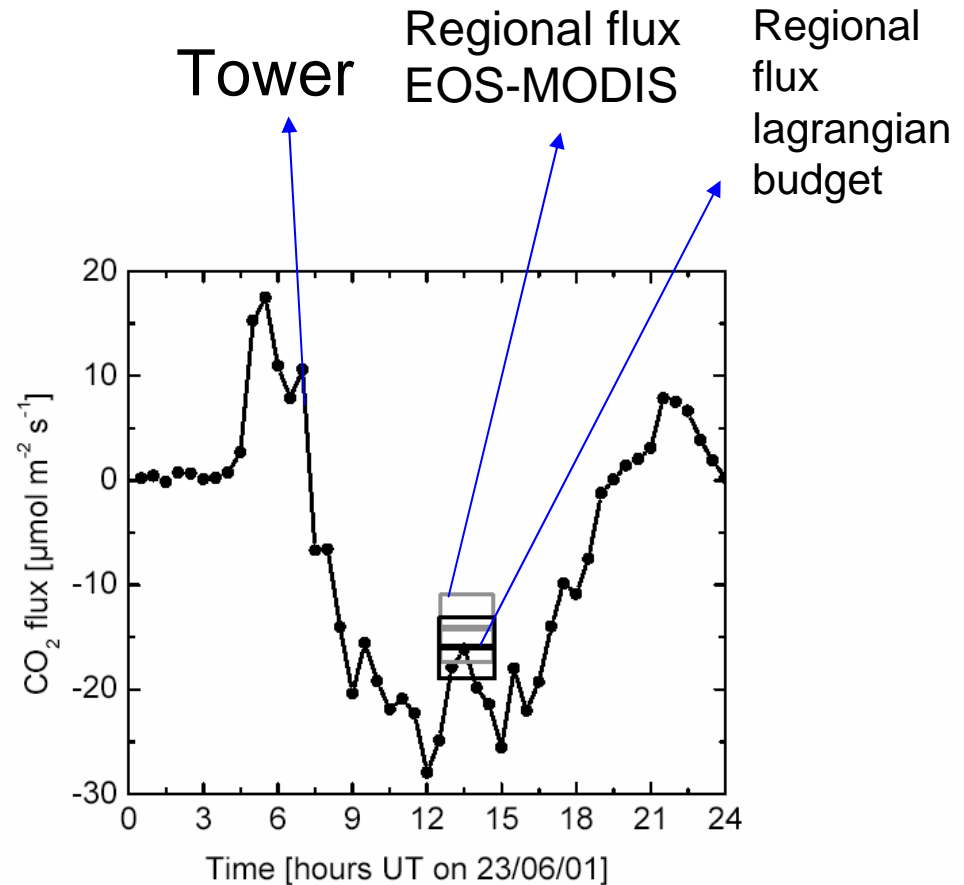

Figure 7: Net ecosystem CO₂ exchange (NEE) from the eddy correlation measurement at the “Le Bray” tower on 23.06.2001 (circles). The black bar shows the regional NEE from the Lagrangian CBL budget, the gray bar the regional NEE modeled via remote sensing input (the boxes indicate the 1-sigma uncertainties as in Table 4).

3000m
(2000m)
to
150m



Berezorechka
T. Machida and
Russian and
Japanese colleagues

80m

40m

20m

5m



1) Flat

2) Homogenous
Vegetation

3) Far from Big
City

4) Tower

Berezorechka village, West Siberia





CO2 Measurement System by Air

Small Automatic



High-Frequency Measurement

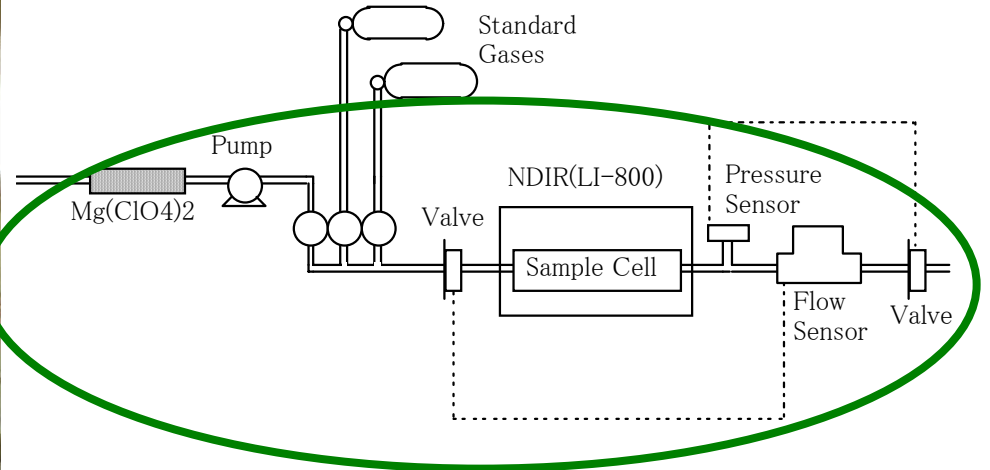

Vertical CO2 profiles in 2002

Oct.'01-Jul.'02

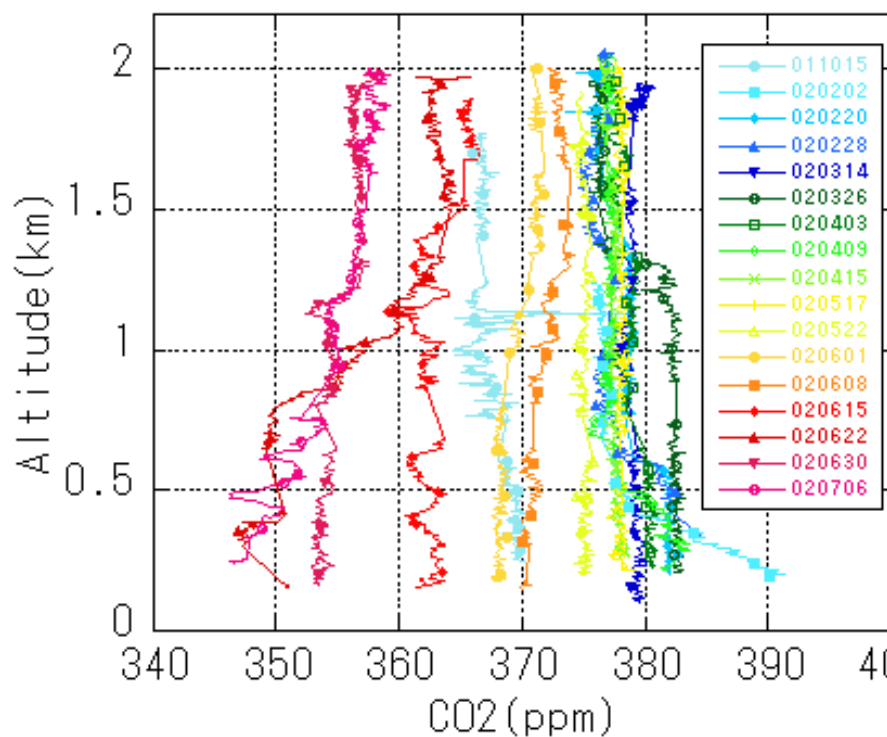

Jul.'02-Dec.'02

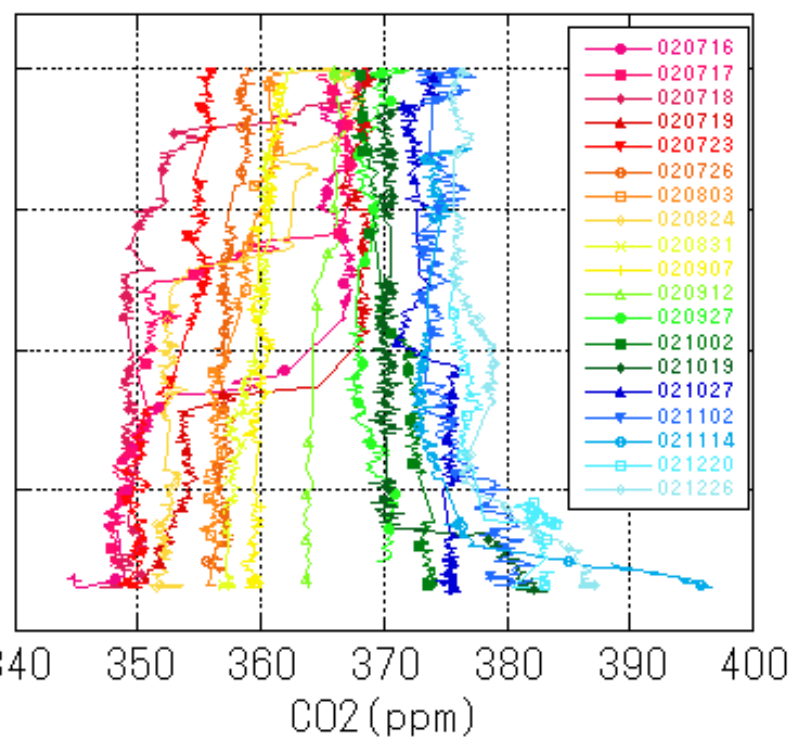

35 Flights in 2002

Vertical CO₂ profiles in 2003

Jan.'03-Jul.'03

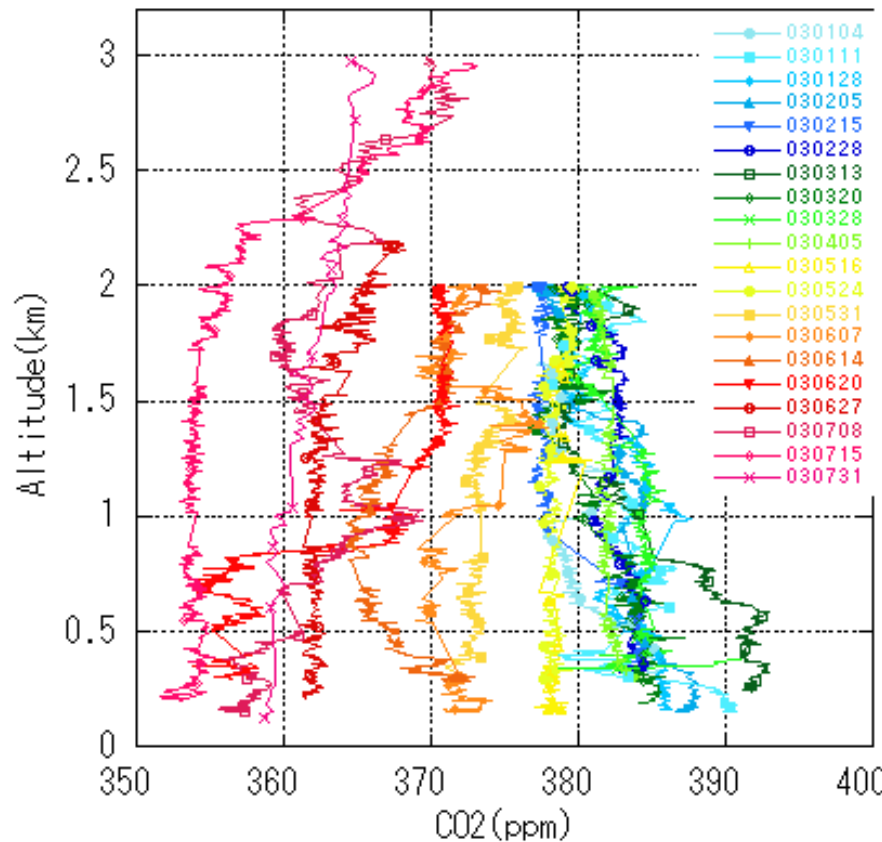

Jul.'03-Dec.'03

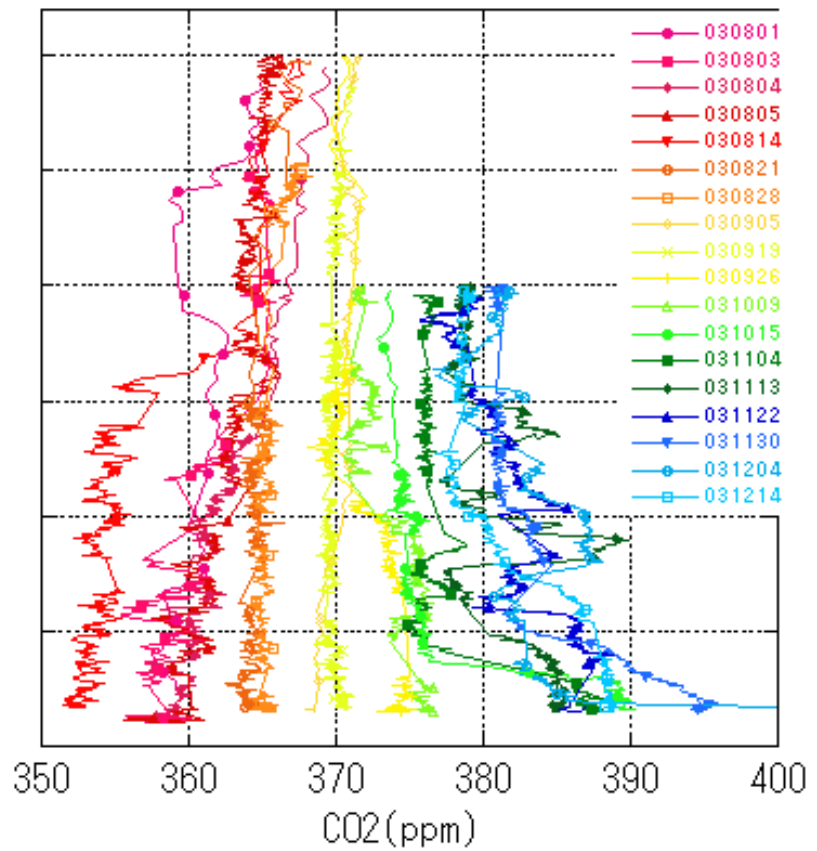

38 Flights in 2003

FT and PBL

26 Mar. 2002

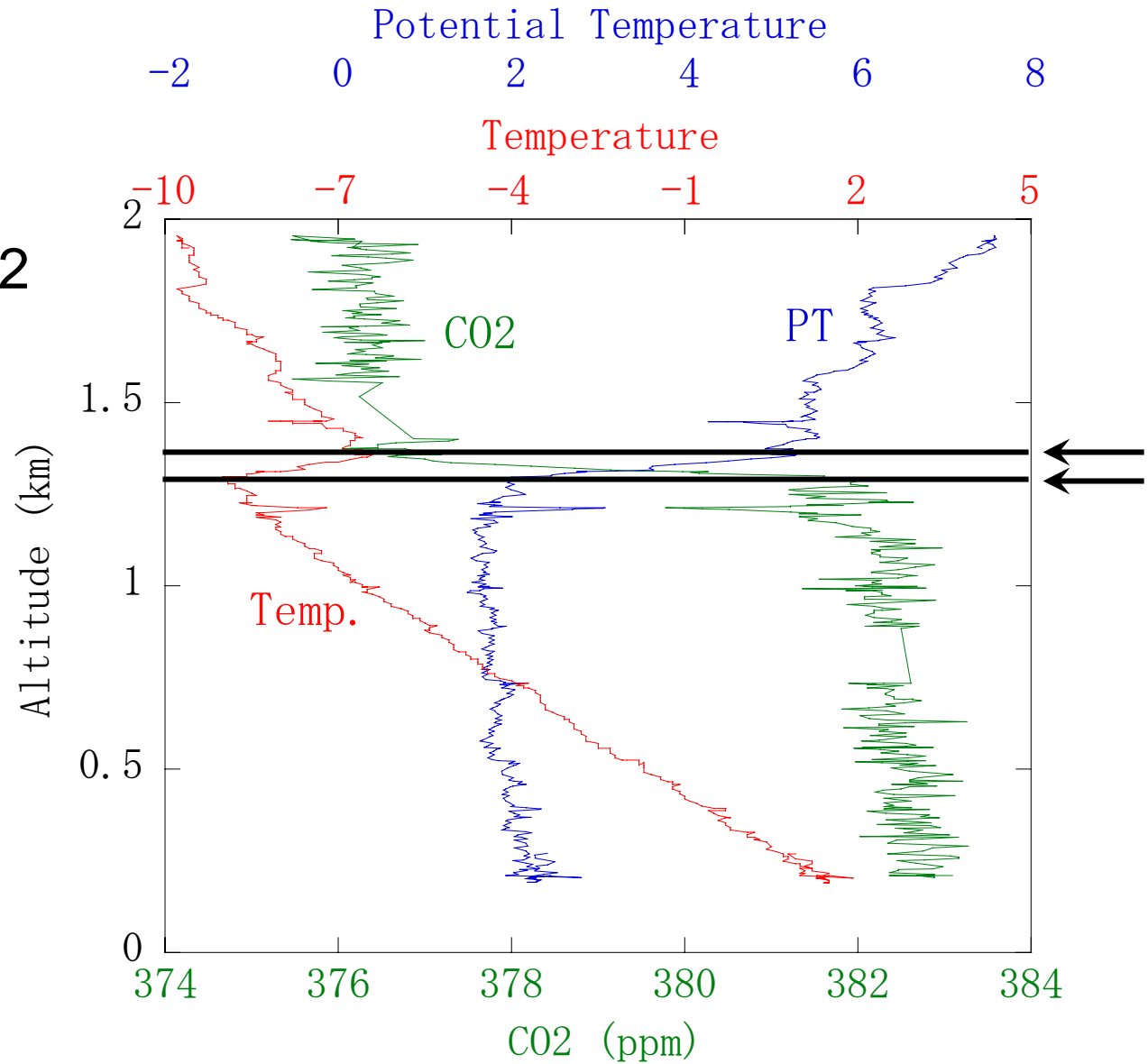

Temporal Variation of CO₂ in FT and PBL

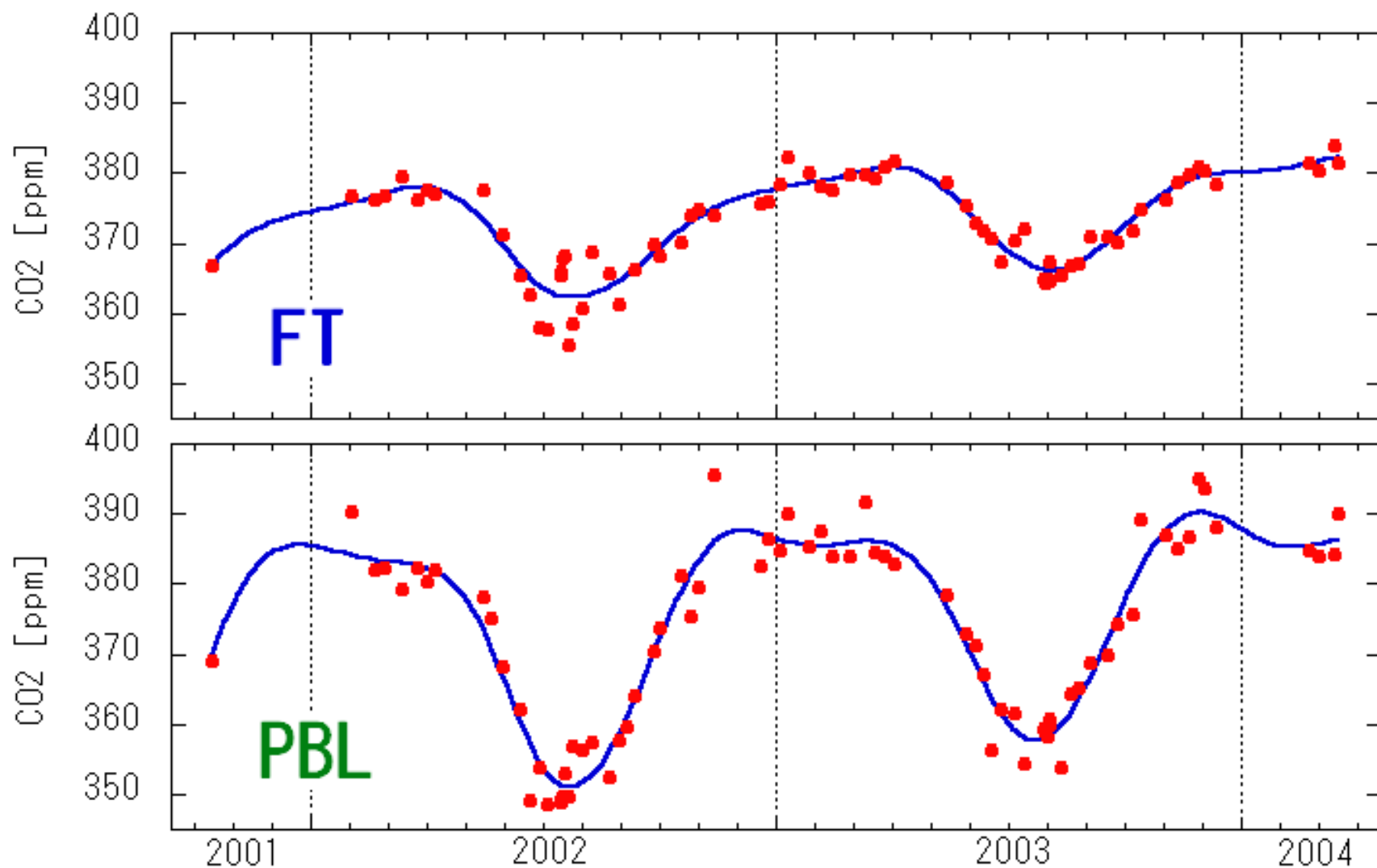

Comparison of Fitting Curves

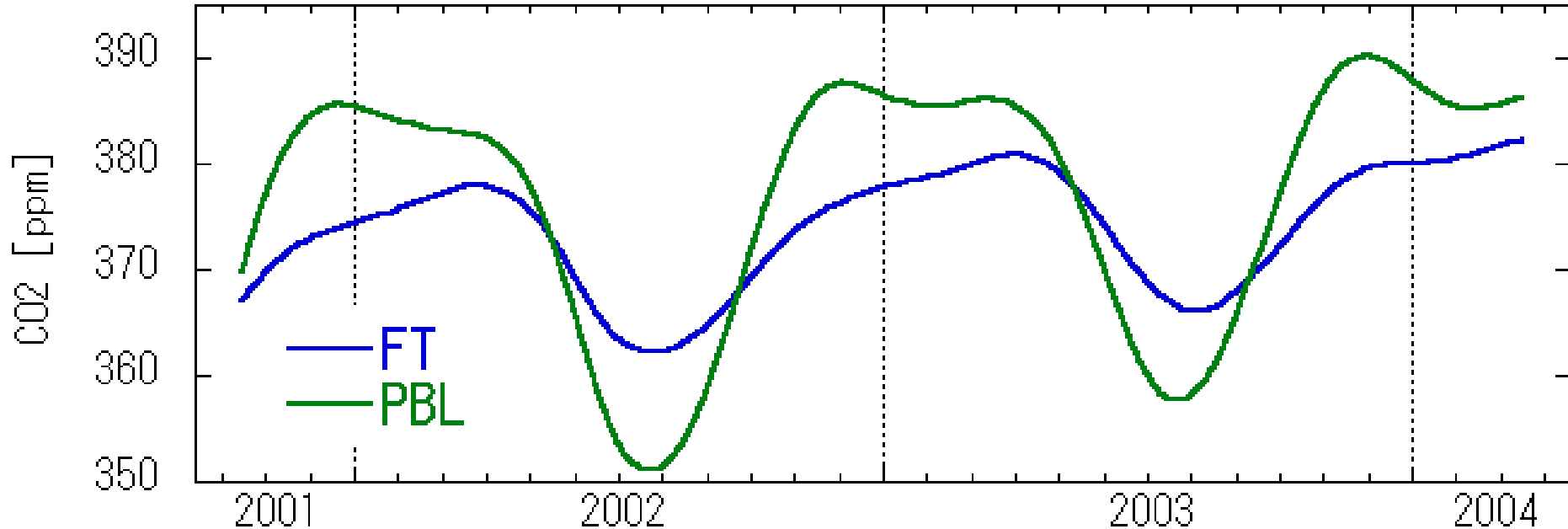

Amplitude = 16ppm(FT) and 34ppm(PBL)

High concentration in Winter

Annual average in PBL is 2ppm higher (rectifier effect)

Comparison between Tower and Aircraft PBL

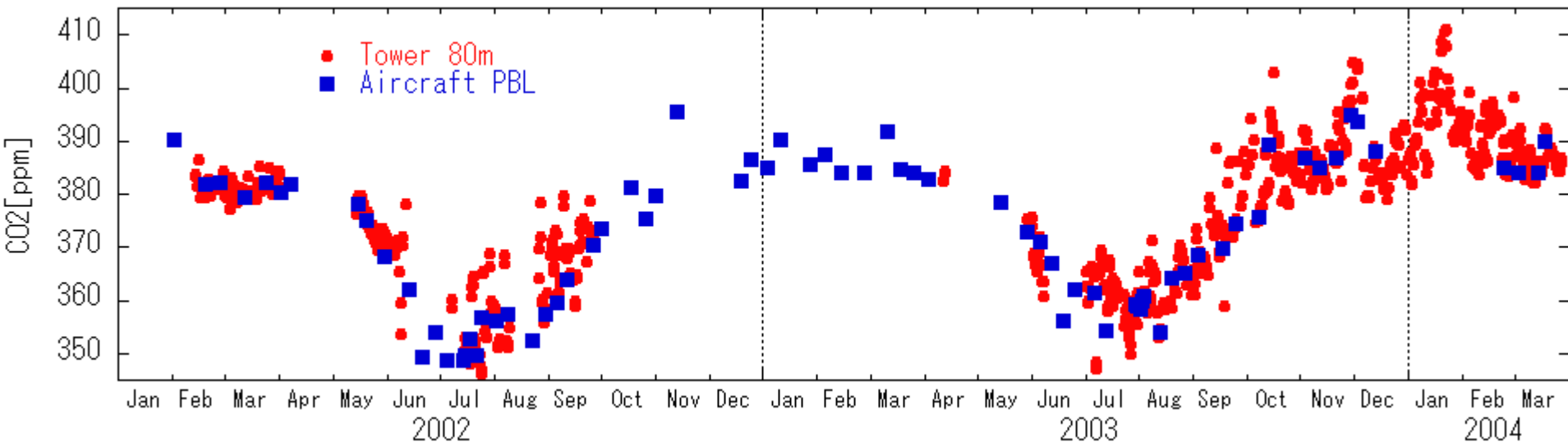

Substantial Difference

--> Aircraft conducts only in the good weather
Weather Bias

Comparison on the good weather condition

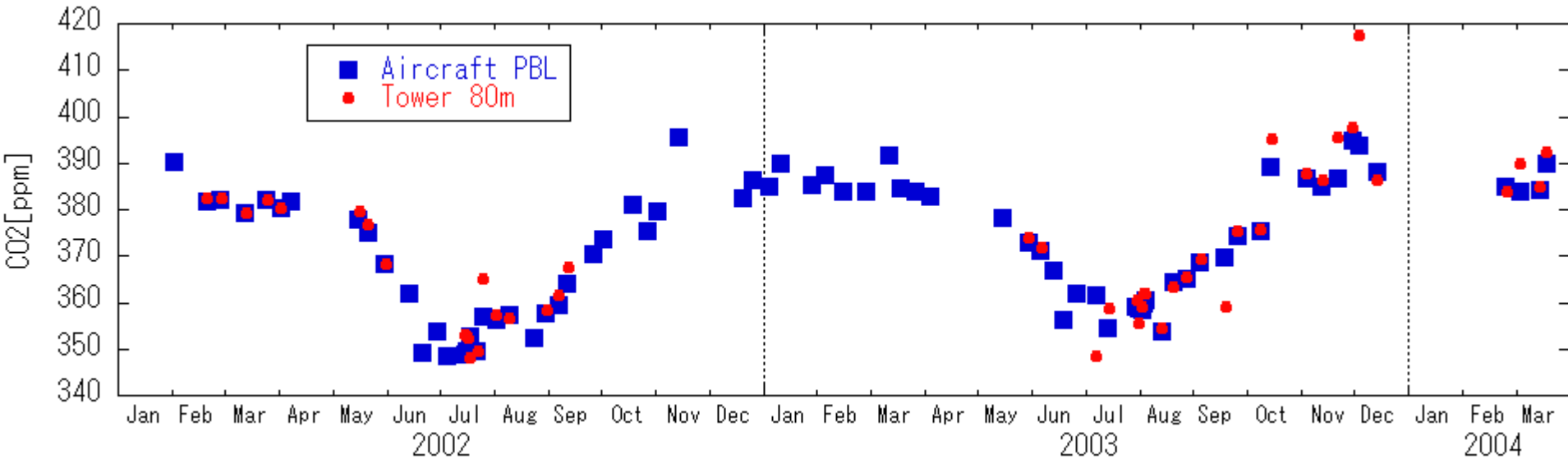

60% data are ± 2 ppm

Without Daytime Inversion (Winter)
No Variable day (Summer)

Conclusions

Reconciling orthogonal perspectives

Inversion downscaling

Excellent spatial integration

Strong constraint on flux magnitude

Poor temporal resolution

Limited mechanistic understanding.

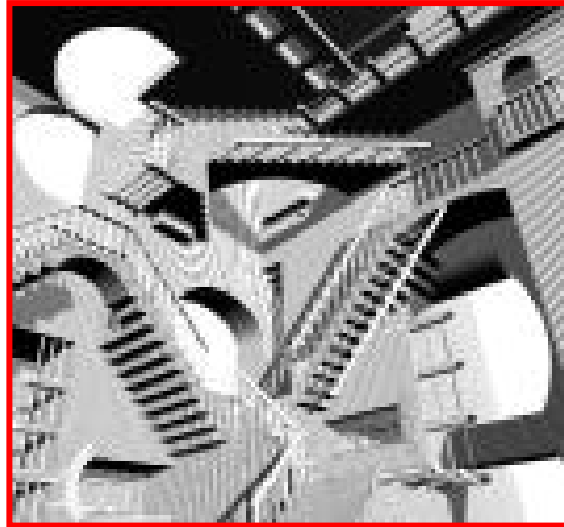

Flux tower upscaling

Intrinsically local measurements.

Difficult to upscale flux magnitudes. Variability easier

Excellent temporal resolution

Strong mechanistic understanding

Let's fusion flux upscaling and Inversions !!!

CCDAS,

Coupling of energy budget parameters with transport

Coupling of soil respiration to atmosphere