



HAL
open science

Oxidation Assisted Intergranular Cracking in Alloy 718: Effects of Strain Rate and Temperature

Eric Andrieu, Bertrand Max, Bertrand Viguiier

► **To cite this version:**

Eric Andrieu, Bertrand Max, Bertrand Viguiier. Oxidation Assisted Intergranular Cracking in Alloy 718: Effects of Strain Rate and Temperature. Aerospace Lab, 2015, 9, p. 1-7. 10.12762/2015.AL09-09 . hal-01187099

HAL Id: hal-01187099

<https://hal.science/hal-01187099>

Submitted on 26 Aug 2015

HAL is a multi-disciplinary open access archive for the deposit and dissemination of scientific research documents, whether they are published or not. The documents may come from teaching and research institutions in France or abroad, or from public or private research centers.

L'archive ouverte pluridisciplinaire **HAL**, est destinée au dépôt et à la diffusion de documents scientifiques de niveau recherche, publiés ou non, émanant des établissements d'enseignement et de recherche français ou étrangers, des laboratoires publics ou privés.

E. Andrieu
(CIRIMAT, ENSIACET/INP)
B. Max
(IRT Saint Exupéry)
B. Viguier
(CIRIMAT, ENSIACET/INP)

E-mail: bertrand.max@irt-saintexupery.com

DOI : 10.12762/2015.AL09-09

Oxidation Assisted Intergranular Cracking in Alloy 718: Effects of Strain Rate and Temperature

Alloy 718 is the most widely used superalloy in industry due to its excellent mechanical properties, as well as its oxidation and corrosion resistance over a wide range of temperatures and solicitation modes. Nevertheless, it is a well-known fact that this alloy is sensitive to oxidation assisted intergranular cracking under loading in the temperature range encountered in service. The mechanisms resulting in such degradation are not well-understood, but it has been well established that a relation exists between a change in fracture mode and the apparition of plastic instability phenomena over a wide range of temperatures. Quantification and characterization of the damaging process provide important information leading to a better understanding of the degradation mechanisms involved in the oxidation assisted intergranular cracking of this alloy. These observations allow various domains to be defined in the strain rate - temperature plane, where the damaging process characteristics are different: a high strain rate / low temperature domain in which instabilities occur and where the fracture mode is systematically transgranular ductile, an intermediary domain where numerous intergranular crack initiations can be observed, and a slow strain rate / high temperature domain where crack propagation is enhanced. These results lead to the proposal of consistent scenarii to explain grain boundary opening due to applied intergranular normal stress and critical decohesion stress changes.

Introduction

A large number of studies dealing with mechanical properties in relation to microstructure and environment have been carried out with alloy 718 [1, 4, 6-9, 13]. Depending on the industrial applications, the microstructure of this Ni-based superalloy can be designed to fulfill service property requirements. Thus, a great variety of microstructures have been explored, together with some slight changes in chemical composition. However, whatever the microstructure may be, this alloy remains sensitive to oxidation assisted intergranular crack initiation or propagation [12]. Studies on the effect of the environment on the crack propagation rate and the cracking path have shown that the occurrence and kinetics of the local intergranular oxidation involved in the damaging process do not vary following classical oxidation laws, but rather depend on the type of oxide formed during the first steps of the oxidation process [2, 3, 11]. A critical oxygen partial pressure was evidenced, relating the type of oxide and the type of crack propagation path. This coupling effect between the local mechanical behavior and the oxidation process give rise to an abrupt change in the fatigue or creep fatigue crack propagation rates when crossing the critical oxygen partial pressure.

At a much lower temperature (340°C), when exposed to simulated pressurized water reactor testing conditions, without irradiation effects, a similar intergranular fracture process occurs during slow strain rate tests [14]. Typical fracture surfaces corresponding to high and low temperature oxidation assisted intergranular fracture are shown in figure 1 [5, 15].

In order to achieve a better understanding of this type of coupling between the mechanical behavior, oxidation and metallurgical state, further studies were performed. A transition between intergranular crack initiation and growth to transgranular ductile fracture is evidenced over the entire temperature range 300°C -700°C under air testing conditions when Portevin-Le Chatelier (PLC) type flow instabilities appear. Given that this boundary between the Dynamic Strain Ageing (DSA) without serrations and the PLC sub-domain is related to microscopic and macroscopic mechanical aspects and mechanisms, studies were continued and the results have been the subject of an earlier publication [10]. A great number of tensile tests have been carried out in an air atmosphere, in order to characterize the plastic instabilities (PLC effect) resulting from a DSA phenomenon in this alloy. The results of these tests are plotted in figure 2, showing the

absence or occurrence of plastic instabilities and the rupture mode exhibited by the fracture surface.

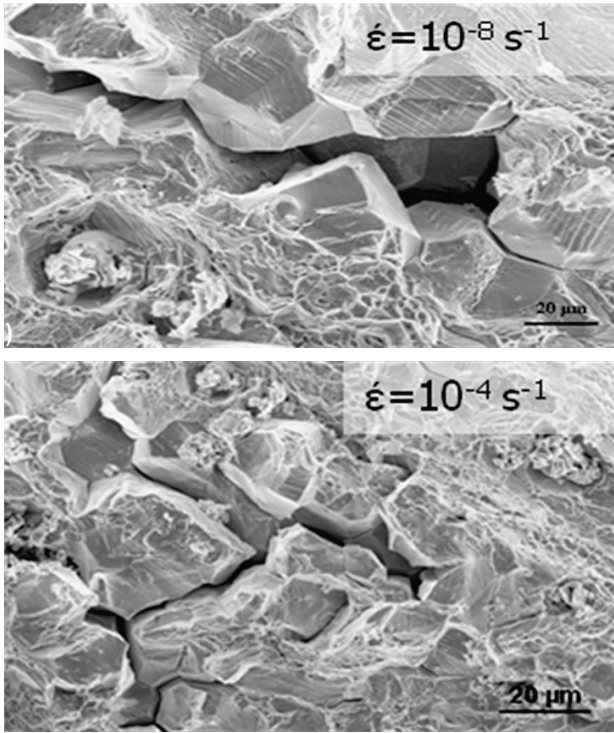

Figure 1 - Typical fracture surface SEM micrographs for (a) a tensile test under simulated PWR testing conditions and (b) a tensile test at 650°C in air

This paper mainly focuses on the effect of strain rate on both the mechanical properties and the sensitivity to Oxidation Assisted Intergranular Cracking (OAIC) of alloy 718, during tensile tests in an air environment for a temperature 650°C. The purpose is to propose a realistic scenario concerning the mechanisms responsible for oxidation assisted intergranular crack initiation in alloy 718.

Materials and experimental procedure

The specimens used in this study were machined from a single heat, whose chemical composition is given in table 1. The material was hot rolled and then cold rolled up to a final thickness of 0.64 mm. The as-received material is in a solid solution state. Typical solution annealing heat treatment can be achieved through a standard route (1040°C-0.5h-Water Quench). Tensile specimens and coupons were cut through spark machining. A standard heat treatment (720°C-8h; cooling rate 50°C/h down to 620°C-8h) was then applied to these samples. After being heat treated, all of the samples were mechanically polished in order to eliminate the spark machining affected zone. The tensile specimen geometry is presented in figure 3. The microstructure of the material was then characterized, using usual observation tools (optical and Scanning Electron Microscopes (SEM)). An average grain size of 10 to 20 μm was measured. As expected from the annealing heat treating conditions, the delta phase was not observed. Primary carbide alignments were evidenced, due to the hot and cold rolling steps. Representative micrographs of the microstructure are given in figure 4.

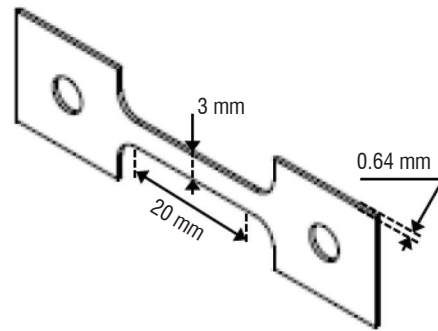

Figure 3 - Geometry of the tensile specimens used in this study

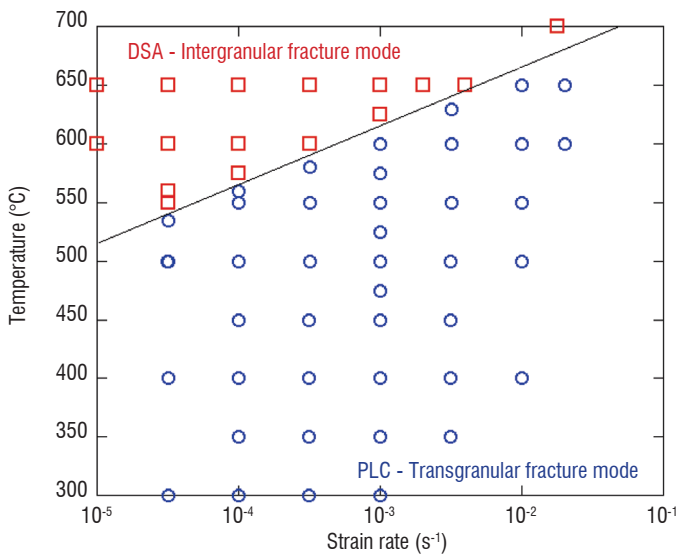

Figure 2 - Representation of the plastic instability occurrence or absence domains (PLC: denotes the domain where serrations were observed; DSA: denotes the domain where no serration was observed, often called the dragging domain) and of the associated rupture modes on the temperature – strain rate plane

Tensile tests were performed on a low capacity (10kN) MTS tensile machine equipped with a radiation furnace and an environmental control chamber. Care was taken to limit the thermal gradients along the tensile specimens to less than +/- 5°C. Tensile tests were carried out under displacement rate control. Due to the weak strain hardening of this alloy and the in situ measurement of strain by a laser extensometer, different quasi constant strain rates could be explored from 10⁻⁵s⁻¹ to 10⁻¹s⁻¹. Tensile tests were performed in the temperature range 300°C - 700°C. Initial mechanical properties at room temperature, 300°C and 650°C determined with a strain rate close to 10⁻³s⁻¹ are presented in table 2.

Element	Ni	Fe	Cr	Nb	Ta	Ti	Al	Mo	Mn	Si	Cu	Co	C	B	P	S
Composition (weight %)	53.6	18.3	18.4	4.94	0.01	0.95	0.56	3.0	0.06	0.04	0.02	0.02	0.033	0.002	0.01	0.0002

Table 1 - Chemical composition in weight percent of alloy 718 used in this study, as determined by Glow Discharge Mass Spectrometry (GDMS) / Instrumental Gas Analysis (IGA)

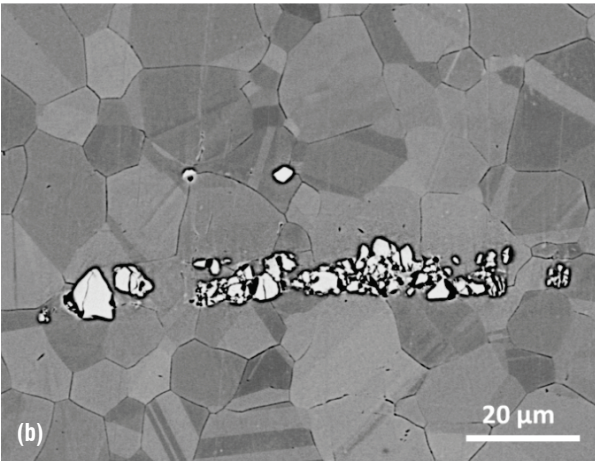
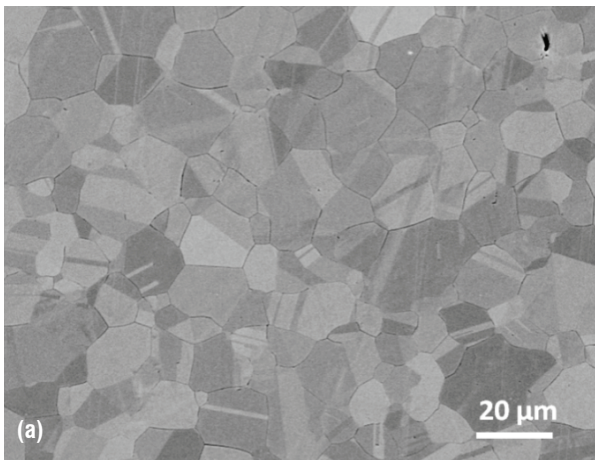

Figure 4 - Typical SEM micrographs of alloy 718 used in this study:
 (a) fully recrystallized equiaxed microstructure
 (b) typical carbide alignment in the rolling direction

	$\sigma_{0.2}$ (MPa)	σ_m (MPa)	E_f (%)	U_e (%)
RT	1200	1600	19	18.2
300°C	1200	1600	16	15.2
650°C	1000	1280	19	18.3

Table 2 - Typical mechanical properties of alloy 718 used in this study for different temperatures: Room Temperature (RT), 300°C and 650°C. Yield stress ($\sigma_{0.2}$), Ultimate tensile stress (σ_m), Elongation to failure (E_f) and Uniform elongation (U_e)

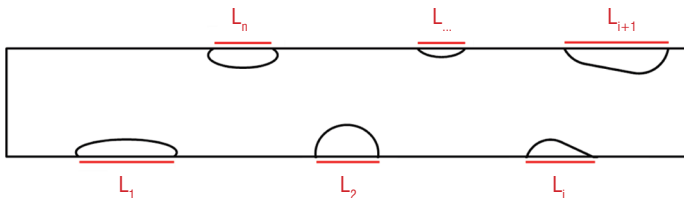

Figure 5 - Diagram of the fracture surface of a sample, with determination of the intergranular brittle fracture length

In this study, two indexes were used to characterize the effects of OAIC: a linear index and an areal index. These indexes can be calculated from quantitative SEM observations of the fracture surfaces of the tensile samples. The linear index is given by the cumulated length of intergranular brittle areas ($\sum L_i$) over the total perimeter length of the fracture surface ratio, as represented in figure 5 and defined by equation (1). To

be taken into account, intergranular brittle areas must be extended over more than one grain. The areal index is given by the ratio of intergranular brittle areas over the total surface of the fracture surface, as defined by equation (2). The linear index is well suited to characterize crack initiation, while the areal index is suited to characterize crack propagation. Calculations of both indexes were carried out for all air tested samples.

$$I_{\text{OAIC}}^{\text{linear}} = \frac{\sum_{i=1}^{i=n} L_i}{L_{\text{tot}}} \quad (1)$$

$$I_{\text{OAIC}}^{\text{areal}} = \frac{\sum_{i=1}^{i=n} S_i}{S_{\text{tot}}} \quad (2)$$

Results

Inert environment

In order to assess the effect of the strain rate on the mechanical behavior, tensile tests were carried out in an inert environment. In this case, a dynamic vacuum equal to 10^{-5} mbar was used. The results of these tests at 650°C are presented in figure 6. As expected, a positive effect of the strain rate on the flow stress is found. Flow instabilities appeared for an applied strain rate of 10^{-2} s^{-1} , as well as low noise emissions. This phenomenon is clearly related to the triggering of PLC instabilities. The fracture surface was observed for each test. All of the specimens exhibited a typical ductile fracture with dimples, mostly initiated on primary carbides, whatever the strain rate, independently from the occurrence or not of plastic instabilities. That is to say that flow instabilities in an inert atmosphere do not generate a change in the fracture mode.

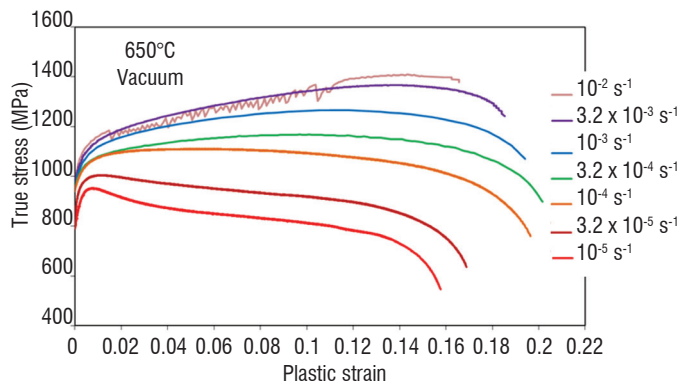

Figure 6 - Evolution of the flow stress for 650°C tensile tests in a vacuum (10^{-5} mbar), as a function of the strain rate

Oxidizing environment

A new set of experiments with the same thermal and mechanical testing conditions but under laboratory air conditions was performed. Some of the corresponding tensile curves are plotted in figure 7. The strain rate sensitivity was confirmed to be unaffected by environmental testing conditions. However, when dealing with elongation to rupture, the results are quite different. Figure 8 gathers the results obtained for the two sets of tests, i.e., in a vacuum and under laboratory air testing conditions. The results obtained show that elongation to rupture is much smaller when the tests are carried out in air, except after the triggering of flow instabilities. When the strain rate is greater than the threshold strain rate, the elongation to fracture does not depend on the environment. However, due to the strain localization in the PLC regime, the strain to failure decreases [16]. It is worth noting here that

the modification of the fracture behavior between the two environments is associated with a change in the fracture mode. At low strain rates under air testing conditions the fracture mode is intergranular. On the contrary, when the strain rate is greater than the strain rate threshold the fracture surface is ductile, whatever the environment.

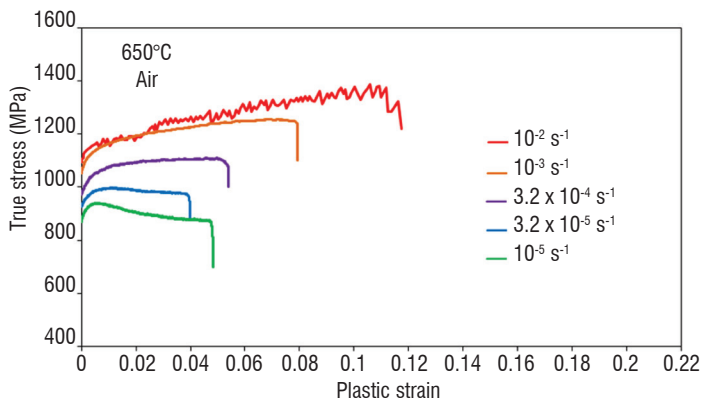

Figure 7 - Evolution of the flow stress for 650°C tensile tests in laboratory air as a function of strain rate

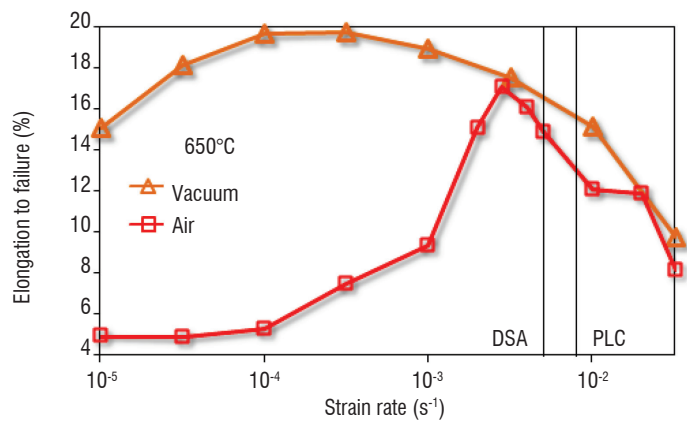

Figure 8 - Elongation to failure for tensile tests at T=650°C for different types of atmosphere: dynamic vacuum (10^{-5} mbar), or air

It is worth noting that tensile properties, such as Yield Stress (YS) and Ultimate Tensile Stress (UTS), are strongly dependent on strain rate. A representation of their evolution as a function of strain rate is plotted in figure 9. The stress experienced by the sample can reach various levels as a function of the strain rate.

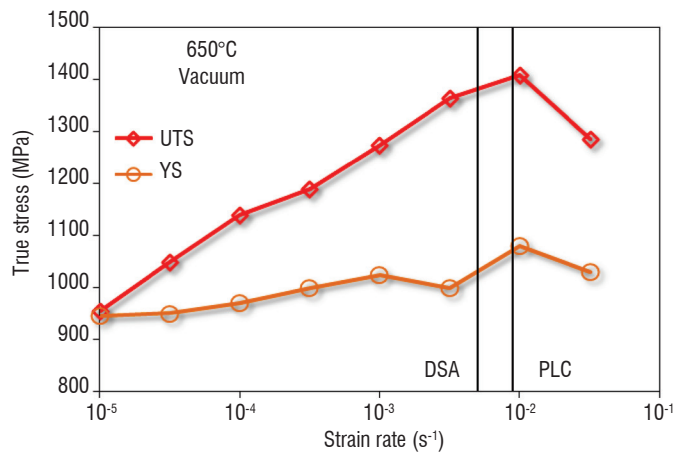

Figure 9 - Evolution of the yield stress and ultimate tensile stress for tensile tests at T=650°C in a dynamic vacuum (10^{-5} mbar)

Discussion

In order to better understand the OAIC mechanism, we compare macroscopic mechanical behavior with microstructural features. This is done through the graphical representation in figure 10, which shows the evolution of rupture elongation and both (linear and areal) indexes for OAIC sensitivity, as defined in a previous section of this paper, versus the strain rate. The plot also contains two complementary scales. The first corresponds to the duration of a tensile test, which varies both with the strain rate and the elongation to failure. The second one corresponds to the maximum crack length, determined using the maximum intergranular propagation rate in alloy 718 CT samples during creep-fatigue tests. This fastest crack propagation rate of a crack in alloy 718 has been evidenced in [12], it corresponds to the propagation of an initiated crack on a CT sample, during creep-fatigue tests (10s-300s-10s) in a high oxygen partial pressure environment ($PO_2=0.2$ bar) and a high stress intensity factor ($\Delta K = 40 MPa\sqrt{m}$). More precisely, these loading conditions have proven to lead to an average crack propagation rate of the order of $2 \mu m.s^{-1}$.

Crack propagation in alloy 718 is still a controversial issue; nevertheless, under these assumptions, the maximum crack propagation length related to the tensile test duration can be evaluated, which provides important information on the operating damaging mechanism associated with the applied strain rate.

Something that must be pointed out is first of all that when tensile test parameters, namely the temperature and strain rate, trigger plastic instabilities, i.e., in the PLC domain, the fracture surface is entirely ductile. This experimental fact is due to the strong localization of plastic deformation within macroscopic bands resulting from the PLC effect. Hence, in this case, the fracture cannot be intergranular for two main reasons: the first is that the tensile tests do not last enough for the deleterious process of intergranular oxidation to occur; the second is the localization of the deformation into bands, which tends to enhance the mechanical damaging process.

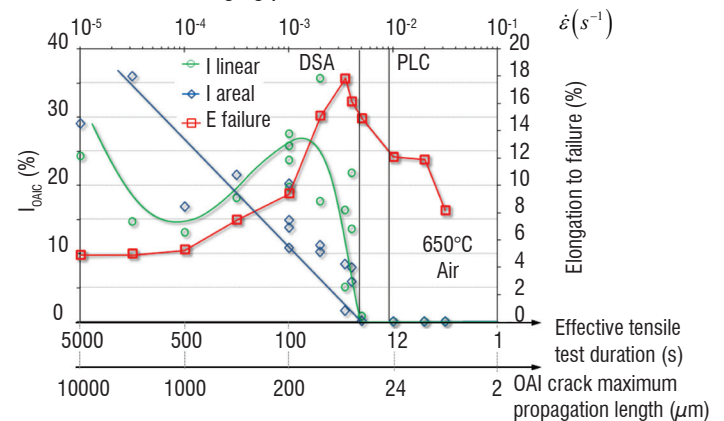

Figure 10 - Evolution of the elongation to failure and OAIC sensitivity indexes as a function of the strain rate for tensile tests at 650°C in an air environment

When entering the DSA domain from the fastest strain rate side, the damage characteristics are as follows: the indexes are rather scattered; crack initiations are numerous, but propagation is inoperative; the bearing section of the sample is, in this case, nearly unaffected by the cracking phenomenon. This strain rate domain enables the crack initiation behavior of the alloy to be characterized. This is the domain of

interest for alloy 718, for which sensitivity is the key point regarding in-service lifetime.

When reaching the lowest strain rates in the DSA domain, the damage characteristics are the following: the indexes are weakly scattered; intergranular crack initiation sites are few, but cracks propagate widely. In this case, the bearing section of the sample is strongly affected by the cracking phenomenon and the elongation to failure is significantly reduced and nearly constant in this domain. Thus, this strain rate domain tends to be crack propagation controlled.

It is worth noting that these features, reported in this paper at the fixed temperature of 650°C, were also observed at different temperatures within the 300 - 700°C range. Indeed, OAIC indexes vary similarly versus a decrease in the strain rate or an increase in the temperature [15]. Also, for lower temperatures, PLC instabilities are observed in a systematic way to be associated with ductile fracture surfaces, confirming that the higher local strain rate does not allow OAIC to take place.

For a given grain boundary, crack initiation occurs when the intergranular normal stress σ_{app} reaches a critical value that corresponds to the grain boundary decohesion stress (GBDS), σ_c . Both stresses have a temporal evolution depending on the strain rate distribution in the polycrystal, which can be related to various parameters that will be discussed herein.

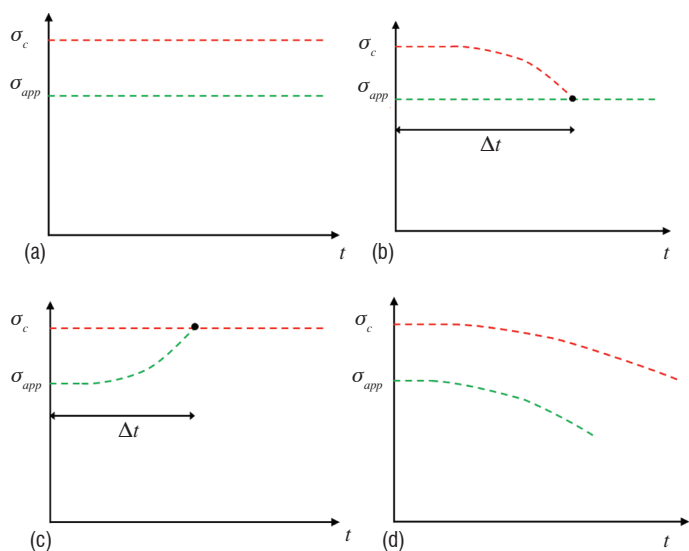

Figure 11 - Graphs of (a) applied intergranular stress and critical decohesion stress of grain boundaries, (b,c) some possible temporal evolutions of applied normal stress and critical bonding stress leading to grain boundary opening and (d) typical evolutions of both stresses in an inert atmosphere

It is relevant to note that the intergranular applied stress is unable to reach the GBDS (d) without an environmental coupling effect, which weakens the grain boundary, since the fracture surface of tensile samples tested at the same temperature in a dynamic vacuum atmosphere never exhibit intergranular brittle areas. It is only when the GBDS is lowered (b), or when the applied stress to a grain boundary increases (c), that intergranular brittle fracture can occur. The question is: how do σ_c and σ_{app} evolve respectively during the tensile test?

The decohesion stress of a grain boundary can be affected by several parameters, which can lead it to evolve during the tensile test. Oxygen penetration, vacancy injection due to the surface oxidation process, cavity formation and alloying element deformation assisted segregation to the favorably oriented grain boundaries are factors that are able to modify the decohesion resistance of the grain boundaries. It is worth mentioning here that intergranular oxidation provides a well-suited means to test interface toughness. This process, which corresponds to crack propagation jumps, might explain the high crack growth rate observed under severe loading conditions, assuming crack arrest due to bifurcation when the crack reaches a triple line.

The intergranular normal stress can evolve during the tensile test due to various phenomena, such as dislocation accumulation at the grain boundary neighborhood or creep of the surrounding grain structure, which leads a grain boundary to endure an evolving normal stress during polycrystal deformation. A competition exists between the relaxation kinetics of the grain boundary internal stresses and the weakening kinetics of the grain boundary.

A previous study [15] carried out on a heat of alloy 718 within the 550°C to 700°C temperature range and within the $3 \times 10^{-5} \text{s}^{-1}$ to 10^{-1}s^{-1} strain rate range showed the necessity to accumulate a given amount of plastic strain before crack initiation can occur. This study based on interrupted tensile tests and SEM observations showed that the amount of accumulated plastic strain before crack initiation can be observed on the gage length of the sample ranges from 1.8 to 3%. The existence of this threshold highlights the effect of strain and stress redistribution in the polycrystal, occurring at the early stages of the strain hardening process.

Conclusion

For a given microstructure of the alloy, oxidation assisted intergranular cracking in alloy 718 is still an open and important topic. Results and observations obtained within the framework of this study bring to light some new elements, allowing a better understanding of the coupling processes involved in the intergranular crack initiation damaging mechanism. Two types of indexes were defined in order to characterize both crack initiation and crack propagation on tensile specimens. The evolution of these indexes depending on temperature, strain rate and environmental testing conditions enabled three domains to be determined. In the first, characterized by a high strain rate and/or low temperatures, flow instabilities (PLC) and short test durations, intergranular crack initiation never occurs whatever the environment. In the second, for intermediate strain rates, crack initiation occurs solely in an air environment and the elongation to failure remains unaffected by the damaging process. In the third, associated to slow strain rates and high temperatures, intergranular crack propagation is enhanced in an air environment and, consequently, the elongation to failure is significantly reduced. Finally, it would be useful to re-examine the evolution and localization of the damage using EBSD imaging during in-situ interrupted tests, in order to validate the proposed coupling mechanisms, which are suspected to depend on microstructural state ■

References

- [1] E. ANDRIEU, R. COZAR, A. PINEAU - *Effect of Environment and Microstructure on the High Temperature Behavior of Alloy 718*. Superalloy 718-Metallurgy and Applications, 1989: p. 241-256.
- [2] E. ANDRIEU, A. PINEAU, H. GHONEM - *Two-Stage Crack Tip Oxidation Mechanism in Alloy 718*. Elevated temperature crack growth, 1990: p. 25-29.
- [3] E. ANDRIEU, R. MOLINS, H. GHONEM, A. PINEAU - *Intergranular Crack Tip Oxidation Mechanism in a Nickel-Based Superalloy*. Materials Science and Engineering: A, 1992. 154(1): p. 21-28.
- [4] A. DIBOINE, A. PINEAU - *Creep Crack initiation and Growth in Inconel 718 alloy at 650°C*. Fatigue & Fracture of Engineering Materials & Structures, 1987. 10(2): p. 141-151.
- [5] V. GARAT, J.-M. CLOUÉ, D. POQUILLON, E. ANDRIEU - *Influence of PLC Effect on Rupture Mode of Alloy 718 Specimens*. Journal of Nuclear Materials, 2008. 375: p. 95-101.
- [6] H. GHONEM, T. NICHOLAS, A. PINEAU - *Elevated Temperature Fatigue Crack Growth in Alloy 718 - Part I : Effects of Mechanical Variables*. Fatigue and Fracture of Engineering Materials and Structures, 1993. 16(5): p. 565-576.
- [7] H. GHONEM, T. NICHOLAS, A. PINEAU - *Elevated Temperature Fatigue Crack Growth in Alloy 718 - Part II : Effects of Environmental and Material variables*. Fatigue and Fracture of Engineering Materials and Structures, 1993. 16(6): p. 577-590.
- [8] L.A. JAMES - *Effect of Temperature upon the Fatigue-Crack Growth Behavior of Two Nickel-Base Alloys*. J. Eng. Mater. Technol., no. 4, 1973. 95(4): p. 254-256.
- [9] S. LYNCH, T. RADTKE, B. WICKS, R. BYRNES - *Fatigue Crack Growth in Nickel-Based Superalloys at 500-700° C. II: Direct-Aged Alloy 718*. Fatigue & Fracture of Engineering Materials & Structures, 1994. 17(3): p. 313-325.
- [10] B. MAX, B. VIGUIER, E. ANDRIEU, J.M. CLOUÉ - *A Re-Examination of the Portevin-Le Chatelier Effect in Alloy 718 in Connection with Oxidation-Assisted Intergranular Cracking*. Metallurgical and Materials Transactions A, 2014. 45(12): p. 5431-5441.
- [11] R. MOLINS, G. HOCHSTETTER, J. CHASSAIGNE, E. ANDRIEU - *Oxidation Effects on the Fatigue Crack Growth Behaviour of Alloy 718 at High Temperature*. Acta Materialia, 1997. 45(2): p. 663-674.
- [12] J. PEDRON, A. PINEAU - *The Effect of Microstructure and Environment on the Crack Growth Behaviour of Inconel 718 Alloy at 650 C Under Fatigue, Creep and Combined Loading*. Materials Science and Engineering, 1982. 56(2): p. 143-156.
- [13] K. SADANANDA, P. SHAHINIAN - *Crack Growth Under Creep and Fatigue Conditions*. Creep - Fatigue - Environment Interactions, 1979: p. 86-111.
- [14] B. TER-OVANEISSIAN, J. DELEUME, J.-M. CLOUÉ, E. ANDRIEU - *Quantitative Assessment of Intergranular Damage Due to PWR Primary Water Exposure in Structural Ni-Based Alloys*. Corrosion Science, 2012. 67: p. 11-19.
- [15] B. TER-OVANEISSIAN, D. POQUILLON, J.-M. CLOUÉ, E. ANDRIEU - *Influence of Local Mechanical Loading Paths on the Oxidation Assisted Crack Initiation of Alloy 718*. Materials Science and Engineering: A, 2012. 533: p. 43-49.
- [16] H.D. WANG, C. BERDIN, M. MAZIÈRE, S. FOREST, C. PRIOUL, A. PARROT, P. LE-DELLIOU - *Experimental and Numerical Study of Dynamic Strain Ageing and its Relation to Ductile Fracture of a C-Mn Steel*. Materials Science and Engineering, 2012. A 547: p. 19-31.

Acronyms

CIRIMAT	(Centre Inter-universitaire de Recherche et d'Ingénierie des Matériaux)
ENSIACET	(Ecole Nationale Supérieure des Ingénieurs en Arts Chimiques et Technologiques de Toulouse)
DSA	(Dynamic Strain Ageing)
GDMS	(Glow Discharge Mass Spectrometry)
IGA	(Instrumental Gas Analysis)
OAIC	(Oxidation Assisted Intergranular Cracking)
PLC	(Portevin-Le Chatelier)
SEM	(Scanning Electron Microscope)
UTS	(Ultimate Tensile Stress)
YS	(Yield Stress)

AUTHORS



Eric Andrieu Doctor-Engineer ENSMP, 1990-1996 : Associate Professor at the Materials Center Pierre Marie Fourt-ENSMP. Head of a research group dealing with Mechanical Behaviour of metallic alloys and Environment. Since 1996: Professor at INP Toulouse / ENSIACET / CIRIMAT Head and now member of a research group studying couplings between mechanical (behavior and damage), microstructure (metallurgical states), reactivity (oxidation, corrosion) on metallic materials.



Bernard Viguiet Engineer in Physics from INSA Toulouse (1991), PhD degree from EPFL (1995), University Professor at INP Toulouse / ENSIACET / CIRIMAT Head of the Materials engineering department at ENSIACET and Deputy Director of the Doctorate School in Materials Sciences from the University of Toulouse. Experimental characterization of plastic deformation and phase transformations.



Bertrand Max Doctor-Engineer INPT-ENSIACET, Post-Doctoral position at IRT Saint-Exupéry, Toulouse Dynamic strain aging, Couplings between mechanical and oxidation, Impact of thermomechanical processes on microstructures.