



HAL
open science

Composing short 3-compressing words on a 2-letter alphabet

Alessandra Cherubini, Achille Frigeri, Zuhua Liu

► **To cite this version:**

Alessandra Cherubini, Achille Frigeri, Zuhua Liu. Composing short 3-compressing words on a 2-letter alphabet. *Discrete Mathematics and Theoretical Computer Science*, 2017, Vol. 19 no. 1, 10.23638/DMTCS-19-1-17 . hal-01184460v3

HAL Id: hal-01184460

<https://hal.science/hal-01184460v3>

Submitted on 1 Jun 2017

HAL is a multi-disciplinary open access archive for the deposit and dissemination of scientific research documents, whether they are published or not. The documents may come from teaching and research institutions in France or abroad, or from public or private research centers.

L'archive ouverte pluridisciplinaire **HAL**, est destinée au dépôt et à la diffusion de documents scientifiques de niveau recherche, publiés ou non, émanant des établissements d'enseignement et de recherche français ou étrangers, des laboratoires publics ou privés.



Distributed under a Creative Commons Attribution - NonCommercial 4.0 International License

Composing short 3-compressing words on a 2-letter alphabet*

Alessandra Cherubini^{1†}Achille Frigeri^{1‡}Zuhua Liu^{2§}¹ Dipartimento di Matematica “F. Brioschi”, Politecnico di Milano² Department of Mathematics, Kunming Universityreceived 1st Sep. 2015, revised 15th Mar. 2017, accepted 24th May 2017.

A finite deterministic (semi)automaton $\mathcal{A} = (Q, \Sigma, \delta)$ is k -compressible if there is some word $w \in \Sigma^+$ such that the image of its state set Q under the natural action of w is reduced by at least k states. Such word w , if it exists, is called a k -compressing word for \mathcal{A} and \mathcal{A} is said to be k -compressed by w . A word is k -collapsing if it is k -compressing for each k -compressible automaton, and it is k -synchronizing if it is k -compressing for all k -compressible automata with $k + 1$ states. We compute a set W of short words such that each 3-compressible automaton on a two-letter alphabet is 3-compressed at least by a word in W . Then we construct a shortest common superstring of the words in W and, with a further refinement, we obtain a 3-collapsing word of length 53. Moreover, as previously announced, we show that the shortest 3-synchronizing word is not 3-collapsing, illustrating the new bounds $34 \leq c(3, 2) \leq 53$ for the length $c(3, 2)$ of the shortest 3-collapsing word on a two-letter alphabet.

Keywords: deterministic finite automaton, collapsing word, synchronizing word

1 Introduction

Let $\mathcal{A} = (Q, \Sigma, \delta)$ be a finite deterministic complete (semi)automaton with state set Q , input alphabet Σ , and transition function $\delta : Q \times \Sigma \rightarrow Q$. For any word $w \in \Sigma^+$, the *deficiency* of w is the difference between the cardinality of Q and the cardinality of the image of Q under the natural action of w . For a fixed $k \geq 1$, the word w is called k -compressing for \mathcal{A} if its deficiency is greater than or equal to k . An automaton \mathcal{A} is k -compressible, if there exists a k -compressing word w for \mathcal{A} and in such case \mathcal{A} is said to be k -compressed by w . A word $w \in \Sigma^+$ is k -collapsing, if it is k -compressing for every k -compressible automaton with input alphabet Σ . A word $w \in \Sigma^+$ is called k -synchronizing if it is k -compressing for all k -compressible automata with $k + 1$ states and input alphabet Σ . Obviously each k -collapsing word is also k -synchronizing.

*The first two authors are partially supported by PRIN: “Automi e linguaggi formali: aspetti matematici e applicativi”. The third-named author’s visit to Politecnico di Milano was supported by the CSC (China Scholarship Council), he acknowledges support from National Natural Science Foundation of China, grant No. 11261066.

[†]Email: alessandra.cherubini@polimi.it

[‡]Email: achille.frigeri@polimi.it

[§]Email: liuzuhua@hotmail.com

The concept of k -collapsing words arose (under a different name) in the beginning of the 1990s with original motivations coming from combinatorics (Sauer and Stone (1991)) and from abstract algebra (Pöschel et al. (1994)). In Sauer and Stone (1991) it has been proved that k -collapsing words always exist, for any Σ and any $k \geq 1$, by means of a recursive construction which gives a k -collapsing word whose length is $O(2^{2^k})$. Better bounds for $c(k, t)$ and $s(k, t)$, the length of the shortest k -collapsing and k -synchronizing words respectively, on an alphabet of cardinality t were given in Margolis et al. (2004). The bounds for $c(2, t)$ were slightly improved in Pribavkina (2005) and Cherubini et al. (2009), but the gaps between lower and upper bounds are quite large even for small values of k and t . Exact values of $s(k, t)$ and $c(k, t)$ are known for $k = 2$ and $t = 2, 3$ and are quite far from the theoretical upper bounds (Ananichev et al. (2005)). Moreover it is known that $s(3, 2) = 33$ and that the words $s_{3,2} = ab^2aba^3b^2a^2babab^2a^2b^3aba^2ba^2b^2a$ and its dual $\bar{s}_{3,2}$ are the unique shortest 3-synchronizing words on $\{a, b\}$ (Ananichev and Petrov (2003)). Observing that $s(k, t) \leq c(k, t)$, and applying the construction in Margolis et al. (2004), one gets $33 \leq c(3, 2) \leq 154$.

The reader is referred to Ananichev et al. (2005); Cherubini (2007); Cherubini et al. (2009); Margolis et al. (2004) for references and connections to theoretical computer science and language theory. The paper is organized as follows: in Section 2 we introduce some general concepts about 3-compressible automata and the main tool we use to study them, *i.e.*, 3-Missing State Automata. In Section 3 we give a complete characterization of proper 3-compressible automata on a two-letter alphabet with a letter acting as a permutation, while in Section 4 we characterize all proper 3-compressible automata without permutations. In Section 5 we describe how to use the previous characterization to obtain a short 3-collapsing word, improving the known upper bound for $c(3, 2)$, as already announced in Cherubini et al. (2011). Section 6 ends the paper with some considerations about the quest for short 3-collapsing words in general and the relationship between 3-synchronizing and 3-collapsing words, and how our analysis can be exploited to obtain more general results, as already done in Cherubini and Kisielewicz (2014, 2016).

2 Background

Let $\mathcal{A} = (Q, \Sigma, \delta)$ be a finite deterministic complete (semi)automaton with state set Q , input alphabet $\Sigma = \{a, b\}$, and transition function $\delta : Q \times \Sigma \rightarrow Q$. The action of Σ on Q given by δ extends naturally, by composition, to the action of any word $w \in \Sigma^+$ on $q \in Q$; we denote it by $qw = \delta(q, w)$, while the action of w on the entire state set Q is denoted by $Qw = \{qw | q \in Q\}$.

Definition 1 *The difference $|Q| - |Qw|$ is called the deficiency of the word w with respect to \mathcal{A} and denoted by $df_{\mathcal{A}}(w)$. For a fixed $k \geq 1$, a word $w \in \Sigma^+$ is called k -compressing for \mathcal{A} , if $df_{\mathcal{A}}(w) \geq k$. An automaton \mathcal{A} is k -compressible, if there exists a k -compressing word for \mathcal{A} . A word $w \in \Sigma^+$ is k -collapsing, if it is k -compressing for every k -compressible automaton with input alphabet Σ . A word w is called k -synchronizing if it is k -compressing for all k -compressible automata with $k + 1$ states and input alphabet Σ . Obviously each k -collapsing word is also k -synchronizing.*

Actually, we view the automaton \mathcal{A} as a set of *transformations* on Q induced via δ and labeled by letters of Σ , rather than as a standard triple. Indeed, in order to define an automaton, it is just enough to assign to every letter $a \in \Sigma$ the corresponding transformation $\tau_a : q \rightarrow \delta(q, a)$ on Q . Now, for $a \in \Sigma$, we get $df_{\mathcal{A}}(a) = |Q| - |\text{Im}(\tau_a)|$, hence $df_{\mathcal{A}}(a) = 0$ if and only if τ_a is a permutation on Q . If $df_{\mathcal{A}}(a) = m \geq 1$, then there are exactly m different states $y_1, y_2, \dots, y_m \notin \text{Im}(a)$, and there are some elements of Q whose images under τ_a are equal.

Definition 2 Let $\mathcal{P} = \{\{x_1^1, \dots, x_j^1\}, \dots, \{x_1^r, \dots, x_j^r\}\}$ be a partition of Q (where singleton sets are omitted), and $y_1, \dots, y_m \in Q$. We say that τ_a is a transformation of type

$$[x_1^1, \dots, x_j^1] \dots [x_1^r, \dots, x_j^r] \setminus y_1, \dots, y_m$$

if \mathcal{P} is induced by the kernel of τ_a and the states y_1, y_2, \dots, y_m do not belong to $\text{Im}(\tau_a)$.

For instance, if \mathcal{A} has at least three states denoted by 1, 2 and 3, a transformation τ is of type $[1, 2] \setminus 3$, if and only if $\tau(1) = \tau(2)$, the preimage of 3 is empty, and for any $q, q' \notin \{1, 2\}$, $\tau(q) = \tau(q')$ if and only if $q = q'$. So, with an abuse of notation, we will write $\tau = [1, 2] \setminus 3$ (actually $[1, 2] \setminus 3$ is a family of transformations). Then, in the sequel we will identify each letter of the input alphabet with its corresponding transformation.

Definition 3 Let $a \in \Sigma$, we say that a is a permutation letter if it induces a permutation on the set of states, i.e., it has deficiency 0.

We assume that permutations on Q , viewed as elements of the symmetric group S_n with $|Q| = n$, are written in the factorization in disjoint cycles where sometimes also cycles of length 1 are explicitly written. So we will write $a = (1)(23)\pi$ to denote that (the permutation induced by) a fixes state 1, swaps states 2 and 3, and π is a permutation that acts on $Q \setminus \{1, 2, 3\}$ (π is not necessarily a cycle).

The notion of transformation induced by a letter naturally extends to words, and then the semigroup generated by the transformations of \mathcal{A} consists precisely of the transformations corresponding to words in Σ^+ . If \mathcal{A} is k -compressible, at least one letter of its input alphabet has deficiency greater than 0. It is well known that each k -collapsing word over a fixed alphabet Σ is k -full (Sauer and Stone (1991)), i.e., contains each word of length k on the alphabet Σ among its factors. Hence, to characterize k -collapsing words it is enough to consider k -full words compressing all k -compressible automata that are proper, i.e., k -compressible automata which are not compressed by any word of length k .

Proposition 4 Let \mathcal{A} be a finite complete automaton on the alphabet $\{a, b\}$: it is 3-compressible and not proper if at least one letter, say a , fulfills one of the following conditions:

1. it has deficiency greater than 2;
2. it has deficiency 2 and is of type $[x, y, z] \setminus u, v$, with $\{u, v\} \not\subseteq \{x, y, z\}$;
3. it has deficiency 2 and is of type $[x, y][z, v] \setminus u, w$, with either $\{u, w\} = \{x, y\}$, or $\{u, w\} = \{z, v\}$, or $\{u, w\} \not\subseteq \{x, y, z, v\}$;
4. it has deficiency 1 and is of type $[x, y] \setminus z$, with $z \notin \{x, y\}$ and $za \notin \{x, y\}$.

The proof of the previous proposition is trivial, indeed if the letter a fulfills one of the above conditions, then either a or a^2 or a^3 has deficiency 3. Since we are looking for a proper 3-compressible automaton we may assume that each letter of the alphabet is either a permutation or one of the following types (we assume different letters represent different states):

1. $[x, y, z] \setminus x, y$;
2. $[x, y][z, v] \setminus x, z$;

3. $[x, y] \setminus x$;

4. $[x, y] \setminus z$ with $za = x$.

In the sequel we view the set Q of the states of \mathcal{A} as a set of natural numbers: $Q = \{1, 2, \dots, n\}$, so that, when no confusion arises, a letter a of types **1**, **2**, **3**, **4** is denoted respectively by $[1, 2, 3] \setminus 1, 2$, $[1, 2][3, 4] \setminus 1, 3$, $[1, 2] \setminus 1$, $[1, 2] \setminus 3$ with $3a = 1$.

Definition 5 Let $w \in \Sigma^+$. We call $\mathcal{M}(w) = Q \setminus Qw$ the missing set of w . Let $Q_1 \subseteq Q$. We denote by $\mathcal{M}(Q_1, w)$ the missing set of w when we have already missed Q_1 , i.e., the set $\mathcal{M}(w) \cup \{qw \mid q \in Q_1 \text{ and } \forall q' \in Q \setminus Q_1, qw \neq q'w\}$.

Observe that $\mathcal{M}(\emptyset, w) = \mathcal{M}(w)$, and if $a \in \Sigma$ is a permutation, $\mathcal{M}(Q_1, a) = Q_1a$. Moreover, $|\mathcal{M}(w)| \geq |\mathcal{M}(w_1)|$, whenever w_1 is a factor of w .

Definition 6 With abuse of language, for a letter a and $Q_1 \subseteq Q$, we call the orbit of a over Q_1 the set $Orb_a(Q_1) = \bigcup_{n=0}^{\infty} Q_1a^n$. In order to increase the readability, we will write $Orb_a(q_1, \dots, q_n)$ instead of $Orb_a(\{q_1, \dots, q_n\})$.

We say that \mathcal{A} is a (\mathbf{i}, \mathbf{j}) -automaton, $1 \leq i, j \leq 4$, if it is an automaton on a two-letter alphabet $\{a, b\}$ and the letter a is of type \mathbf{i} and b is of type \mathbf{j} . We say that \mathcal{A} is a (\mathbf{i}, \mathbf{p}) -automaton, with $1 \leq i \leq 4$, to denote that the letter a is of type \mathbf{i} and b is a permutation. In the sequel, without loss of generality, we will always suppose that in a (\mathbf{i}, \mathbf{j}) -automaton (resp. (\mathbf{i}, \mathbf{p}) -automaton) the letter a is of type \mathbf{i} and b is of type \mathbf{j} (resp. a permutation).

Although the notion of missing set is sufficient to describe the compressibility of an automaton, it is in general quite intricate to use, especially when long words are involved. So, to easily calculate the set $\mathcal{M}(Q_1, w)$, we introduce a graphical device, the *missing state automaton* of \mathcal{A} .

Definition 7 Let $\mathcal{A} = (Q, \Sigma, \delta)$ be a deterministic (semi)automaton with $|Q| = n$, and let $m < n$. The m -Missing State Automaton (*mMSA* for short) of \mathcal{A} is the automaton $\mathcal{M} = (\wp^{m-1}(Q) \cup \{\mathbf{m}\}, \Sigma, \tau, \emptyset, \mathbf{m})$, where $\wp^{m-1}(Q)$ is the set of subsets of Q of cardinality less than or equal to $m-1$, \mathbf{m} is a special state not belonging to $\wp^{m-1}(Q)$ graphically denoted by a circle with m tokens inside, and $\tau : \wp^{m-1}(Q) \times \Sigma \rightarrow \wp^{m-1}(Q) \cup \{\mathbf{m}\}$ is the transition relation defined by

$$\tau(Q_1, a) = \begin{cases} \mathcal{M}(Q_1, a), & \text{if } |\mathcal{M}(Q_1, a)| < m; \\ \mathbf{m}, & \text{otherwise.} \end{cases}$$

notice that τ is not defined at the state \mathbf{m} .

For example, in Fig. 1 we draw the 2MSA of a simple semiautomaton, proving that it is synchronizable.

The notion of missing state automaton is similar to that of power state automaton, which is a standard tool in computing synchronizing words, see Trahtman (2006); Kudlacik et al. (2012); Volkov (2008). The difference is that the names of states are replaced by their complements and all superstates made by more than m states are identified. Although power set automata are only used to design algorithm to find possibly shortest synchronizing words of a fixed automaton, we need to consider a whole class of automata. Moreover, as we are only interested in knowing if an automaton is 3-compressible, often we will draw only a *Partial 3-Missing State Automaton* (P3MSA), i.e., a path (possibly the shortest) from the initial to the final state of the whole 3MSA.

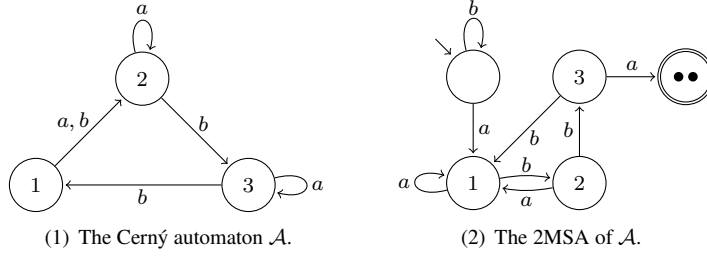

Fig. 1: The Cerný semiautomaton with 3 states and its 2MSA: the set of synchronizing words for \mathcal{A} is the regular language $b^*a(a + ba + b^3)^*bba$.

Lastly, we observe that when considering a family of automata, dozens of subcases arise when we try to find some (short) 3-collapsing word for such family. So, to capture a greater number of cases and improve the readability, we gather several subcases using a *conditional* 3MSA. In this case, a label can be of the form $a|qw \in Q'$. So, $\tau(q_1, a|qw \in Q') = q_2$ means that $\mathcal{M}(\{q_1\}, a) = \{q_2\}$ under the hypothesis (condition) that $qw \in Q'$. Observe that the condition $qw \in Q'$ spreads over all the states reached from q_2 , so two different states can share the same name, when belonging to different branches. For example, in the conditional 3MSA in Fig. 4(1), the two states named by $\{1, 3\}$ have different behavior as the one in the first row inherits the condition $3a = 3$ and then $\mathcal{M}(\{1, 3\}, a) = \{1, 3\}$, while the one in the second row inherits the condition $3a = 2$ and then $\mathcal{M}(\{1, 3\}, a) = \{1, 2\}$.

3 3-compressible (i, p)-automata

In this section we characterize all proper 3-compressible automata on the alphabet $\{a, b\}$ in which the letter b acts as a permutation on the set Q of states. In particular in the following propositions we give a small set of short 3-collapsing words when letter a is of type i, $1 \leq i \leq 4$.

Proposition 8 *Let \mathcal{A} be a (1, p)-automaton with $a = [1, 2, 3] \setminus 1, 2$. Then \mathcal{A} is 3-compressible and proper if and only if the following conditions hold:*

1. $Orb_b(1, 2) \not\subseteq \{1, 2, 3\}$, and
2. $\{1, 2\}b \subset \{1, 2, 3\}$.

Moreover, if \mathcal{A} is 3-compressible and proper, then the word ab^2a 3-compresses \mathcal{A} .

Proof: Let \mathcal{A} be a (1, p)-automaton that does not satisfy one of the conditions 1. or 2. If $Orb_b(1, 2) \subseteq \{1, 2, 3\}$, then for each word $w \in \{a, b\}^*$ we have that $\mathcal{M}(wa) = \{1, 2\}$, whence \mathcal{A} is not 3-compressible. Else, if $\{1, 2\}b \not\subseteq \{1, 2, 3\}$, then $\mathcal{M}(a) = \{1, 2\}$, $\mathcal{M}(ab) = \{1b, 2b\} \not\subseteq \{1, 2, 3\}$, and $|\mathcal{M}(aba)| \geq 3$, so \mathcal{A} is not proper.

Conversely, let \mathcal{A} be an automaton satisfying conditions 1. and 2. A 3-compressing word for \mathcal{A} must have at least two non-consecutive occurrences of letter a , and the word aba is not 3-compressing. Moreover, $\{1, 2\}b^2 \not\subseteq \{1, 2, 3\}$, else $Orb_b(1, 2) \subseteq \{1, 2, 3\}$, against the hypothesis, and then the word ab^2a 3-compresses \mathcal{A} . \square

Proposition 9 Let \mathcal{A} be a $(2, \mathbf{p})$ -automaton with $a = [1, 2][3, 4] \setminus 1, 3$. Then \mathcal{A} is 3-compressible and proper if and only if one of the following conditions holds:

1. $\{1, 3\}b = \{2, 4\}$ and $\{2, 4\}b \neq \{1, 3\}$;
2. $\{1, 3\}b \in \{\{1, 4\}, \{2, 3\}\}$ and at least one of the following conditions is true:
 - (a) $Orb_b(1, 3) \not\subseteq \{1, 2, 3, 4\}$;
 - (b) $|Orb_b(1)| = 3$;
 - (c) $|Orb_b(3)| = 3$.

Moreover, if \mathcal{A} is 3-compressible and proper, then one of the words ab^2a or ab^3a 3-compresses \mathcal{A} .

Proof: Let \mathcal{A} be a $(2, \mathbf{p})$ -automaton that does not satisfy both conditions 1. and 2. If $\{1, 3\}b \not\subseteq \{1, 2, 3, 4\}$, then the word aba 3-compresses \mathcal{A} , which is not proper. So, let $\{1, 3\}b \subseteq \{1, 2, 3, 4\}$, then we have to consider only the following cases:

1. $\{1, 3\}b \in \{\{1, 2\}, \{3, 4\}\}$, then again the word aba 3-compresses \mathcal{A} , so \mathcal{A} is not proper;
2. $\{1, 3\}b = \{1, 3\}$, then for all $w \in b^*$, $\mathcal{M}(w) = \emptyset$, while for all $w \in \{a, b\}^* \setminus b^*$, $\mathcal{M}(w) = \{1, 3\}$, then \mathcal{A} is not 3-compressible;
3. $\{1, 3\}b \in \{\{1, 4\}, \{2, 3\}\}$ with $Orb_b(1, 3) \subseteq \{1, 2, 3, 4\}$, $|Orb_b(1)| \neq 3$ and $|Orb_b(3)| \neq 3$, then $b = (1423)\pi$ or $b = (1324)\pi$ or $b = (1)(34)\pi$ or $b = (12)(3)\pi$. The 3MSA in figures 2(1) and 2(2) prove that in any case \mathcal{A} is not 3-compressible;
4. $\{1, 3\}b = \{2, 4\}$. If $\{2, 4\}b \subseteq \{1, 2, 3, 4\}$, then $b = (12)(34)\pi$ or $b = (14)(32)\pi$ or $b = (1234)\pi$ or $b = (1432)\pi$, and the 3MSA in Fig. 2(2) proves that \mathcal{A} is not 3-compressible.

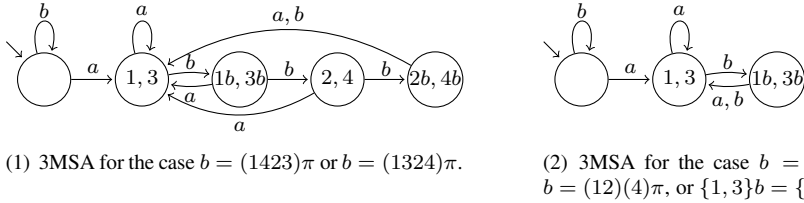

Fig. 2: 3MSA for automata that do not satisfy conditions 1. and 2. of Proposition 9.

Conversely,

1. let $\{1, 3\}b = \{2, 4\}$ and $\{2, 4\}b \neq \{1, 3\}$. Then $\mathcal{M}(ab^2) = \{2, 4\}b$, and the word ab^2a 3-compresses \mathcal{A} . On the other hand, $\mathcal{M}(aba) = \{1, 3\}$ and then \mathcal{A} is proper.

2. Now, let $\{1, 3\}b = \{1, 4\}$. If $Orb_b(1, 3) \not\subseteq \{1, 2, 3, 4\}$, then $b = (1)(34x\dots)\pi$ or $b = (314x\dots)\pi$ or $b = (1)(342x\dots)\pi$ or $b = (3142x\dots)\pi$ for some $x \notin \{1, 2, 3, 4\}$. In the first two cases the word ab^2a 3-compresses \mathcal{A} , in the last two the word ab^3a 3-compresses \mathcal{A} . If $|Orb_b(1)| = 3$, then $1b = 4$ and $3b = 1$, i.e., $b = (143)\pi$, while if $|Orb_b(3)| = 3$, then either $b = (143)\pi$, or b fixes 1 and is of the form $(34x)\pi$ for some $x \notin \{1, 3, 4\}$. In any cases, $\{1, 3\}b^2 \in \{\{1, x\}, \{3, 4\}\}$, so the word ab^2a 3-compresses \mathcal{A} . The case $\{1, 3\}b = \{2, 3\}$ is symmetric, and then either the word ab^2a or ab^3a 3-compresses \mathcal{A} .

□

Observe that each 3-compressible $(\mathbf{3}, \mathbf{p})$ - or $(\mathbf{4}, \mathbf{p})$ -automaton \mathcal{A} is proper. Indeed each 3-compressing word for \mathcal{A} contains at least three occurrences of the letter a which are not all consecutive. So in the next two propositions, we only look for 3-compressible automata.

Proposition 10 *Let \mathcal{A} be a $(\mathbf{3}, \mathbf{p})$ -automaton with $a = [1, 2] \setminus 1$. Then \mathcal{A} is 3-compressible (and proper) if and only if the following conditions hold:*

1. $|Orb_b(1)| \geq 2$ and $\{1, 2\}b \neq \{1, 2\}$;
2. if $b = (13)\pi$, then
 - (a) $3a \neq 3$;
 - (b) if $3a = 2$, then $2b \neq 2$ or $2a \neq 3$;
 - (c) if $3a = 2b$ and $2b \notin \{2, 3\}$, then $2b^2 \neq 2$ or $2ba \neq 3$;
3. if $b = (123)\pi$, or $b = (132)\pi$, then $\{2, 3\}a \neq \{2, 3\}$;
4. if $b = (1324)\pi$, then $\{3, 4\}a \neq \{3, 4\}$.

Moreover, if \mathcal{A} is 3-compressible (and proper), then one of the words $ababa$, aba^2ba , ab^2ab^2a , $ab^2a^2b^2a$, ab^2abab^2a , $abab^2aba$, ab^3aba , $abab^3a$ or ab^3ab^3a 3-compresses \mathcal{A} .

Proof: Let \mathcal{A} be a $(\mathbf{3}, \mathbf{p})$ -automaton that does not satisfy one of the conditions 1.-4. We prove that it is not 3-compressible.

1. Let $|Orb_b(1)| = 1$ or $\{1, 2\}b = \{1, 2\}$, then $1b = 1$ or $b = (12)\pi$. In the former case for all $w \in (a+b)^*$, $\mathcal{M}(w) \in \{\emptyset, \{1\}\}$, in the latter $\mathcal{M}(w) \in \{\emptyset, \{1\}, \{2\}\}$, so \mathcal{A} is not 3-compressible.
2. Let $b = (13)\pi$ and either $3a = 3$, or $3a = 2$, $2b = 2$ and $2a = 3$, or $3a = 2b = 4$, $2b^2 = 2$ and $2ba = 3$. Observe that in the last two cases $3a^2 = 3$ and $3ab = 2$, indeed if $3a = 2$, $2b = 2$ and $2a = 3$ then $(3a)a = 2a = 3$ and $(3a)b = 2b = 2$, while if $3a = 2b = 4$, $2b^2 = 2$ and $2ba = 3$, then again $(3a)a = (2b)a = 3$ and $(3a)b = (2b)b = 2$. The 3MSA in Fig. 3 proves that in any case \mathcal{A} is not 3-compressible.
3. Let $b = (123)\pi$, or $b = (132)\pi$, and $\{2, 3\}a = \{2, 3\}$. The 3MSA in figures 4(1) and 4(2) prove that \mathcal{A} is not 3-compressible.
4. Let $b = (1324)\pi$, and $\{3, 4\}a = \{3, 4\}$. The 3MSA in Fig. 5 proves that \mathcal{A} is not 3-compressible.

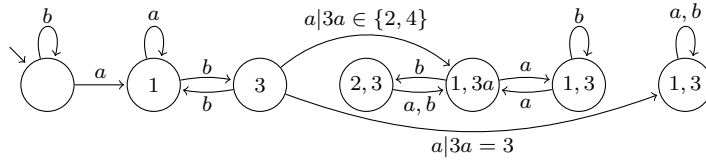

Fig. 3: 3MSA for automata that do not satisfy condition 2. of Proposition 10.

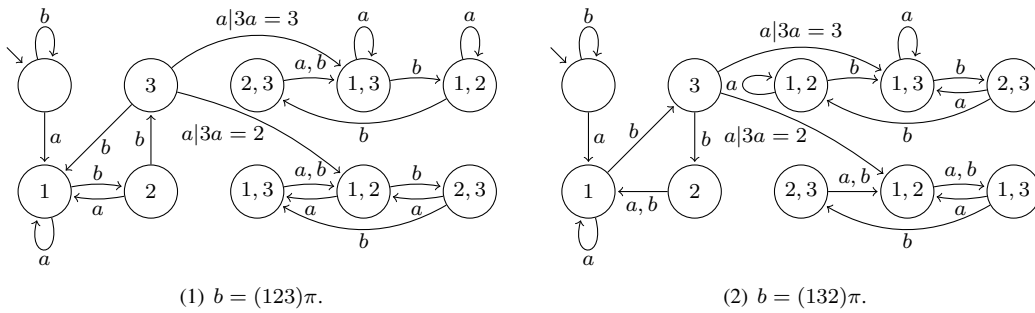

Fig. 4: 3MSA for automata that do not satisfy condition 3. of Proposition 10.

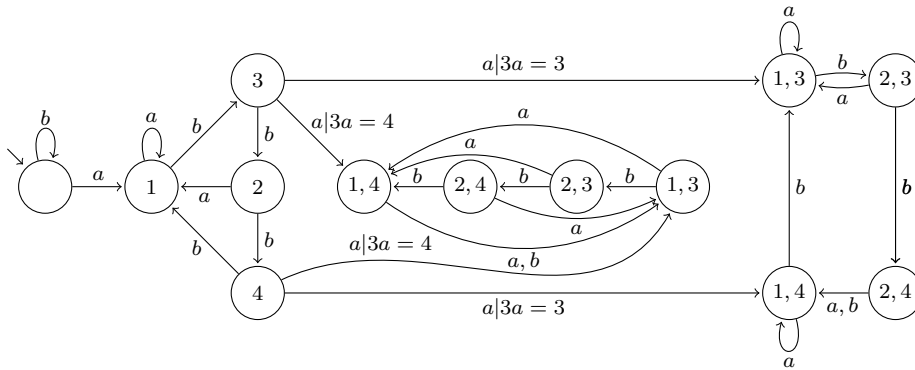

Fig. 5: 3MSA for automata that do not satisfy condition 4. of Proposition 10.

Conversely, let \mathcal{A} be an automaton satisfying conditions 1. – 4. Since $|Orb_b(1)| \geq 2$ and $\{1, 2\}b \neq \{1, 2\}$, we have $1b \neq 1$ and b is not of the form $(12)\pi$. Moreover, observe that if b is of the form $(134\dots)\pi$, then one of the words $abab^2a$, $ababa$, ab^2ab^2a or ab^2aba 3-compresses \mathcal{A} , as shown in Fig. 6. for this reason in the following we do not consider such cases.

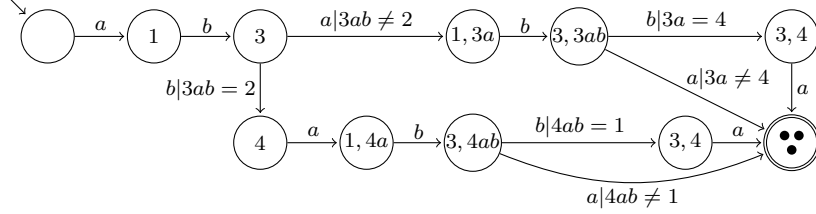

Fig. 6: P3MSA for 3-compressible automata with $b = (134\dots)\pi$.

1. Let $|Orb_b(1)| = 2$, $b = (13)\pi$, and $3a \neq 3$, then there are two further subcases.
 - (a) If $|Orb_b(2)| \leq 2$, i.e., $b = (13)(2)\pi$ or $b = (13)(24)\pi$, then $\{2b, 3\}a \neq \{2b, 3\}$ and in Fig. 7(1) we draw a P3MSA for those cases, proving that either the word $ababa$ or aba^2ba 3-compresses \mathcal{A} .
 - (b) If $|Orb_b(2)| \geq 3$, i.e., $b = (13)(245\dots)\pi$, then in Fig. 7(2) we draw a P3MSA for this case, proving that either the word $ababa$ or $abab^3a$ 3-compresses \mathcal{A} .

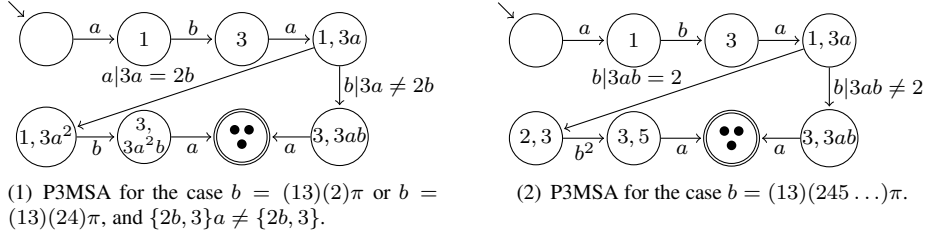

Fig. 7: P3MSA for 3-compressible automata with $b = (13)\pi$ and $3a \neq 3$.

2. Let $|Orb_b(1)| = 3$, then we have to considered the two subcases $b = (123)\pi$ and $b = (132)\pi$, as the case $b = (134)\pi$ was already analyzed in Fig. 6.
 - (a) If $b = (123)\pi$, then $\{2, 3\}a \neq \{2, 3\}$ and in Fig. 8 we draw a P3MSA for this case, proving that one of the words ab^2ab^2a , $ab^2a^2b^2a$ or ab^2abab^2a 3-compresses \mathcal{A} .
 - (b) If $b = (132)\pi$, then $\{2, 3\}a \neq \{2, 3\}$ and in Fig. 9 we draw a P3MSA for this case, proving that one of the words aba^2ba , $ababa$ or $abab^2aba$ 3-compresses \mathcal{A} .
3. Let $|Orb_b(1)| = 4$, then we have to considered the two subcases $b = (1234)\pi$ and $b = (1324)\pi$, as the cases $b = (1342)\pi$ and $b = (1345)\pi$ were already analyzed in Fig. 6.

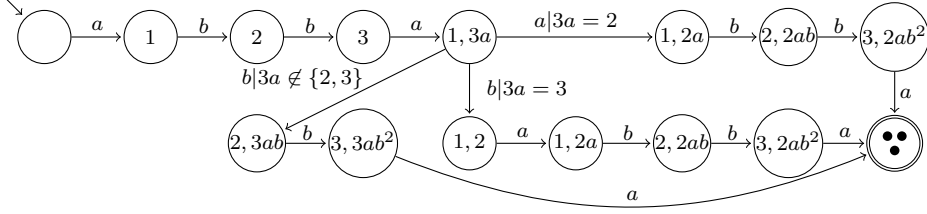

Fig. 8: P3MSA for 3-compressible automata with $b = (123)\pi$ and $\{2, 3\}a \neq \{2, 3\}$.

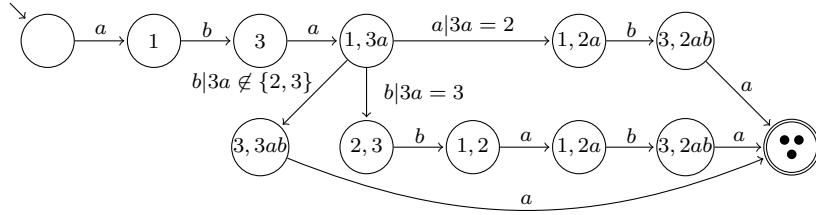

Fig. 9: P3MSA for 3-compressible automata with $b = (132)\pi$ and $\{2, 3\}a \neq \{2, 3\}$.

- (a) If $b = (1234)\pi$, then in Fig. 10 we draw a P3MSA for this case, proving that one of the words ab^2ab^2a , ab^3ab^3a , ab^2abab^2a or $ab^2a^2b^2a$ 3-compresses \mathcal{A} . Indeed, observe that:
- if $3a \notin \{3, 4\}$, then $3ab^2 = 1$ implies $3a = 3$, and $3ab^2 = 2$ implies $3a = 4$, and both of them are contradictions;
 - if $3a = 4$ and $4a = 3$, then $2ab^2 = 1$ implies $2a = 3$, and $2ab^2 = 2$ implies $2a = 4$, both contradictions;
 - if $3a = 3$ and $4a \neq 4$ or if $3a = 4$ and $4a \neq 3$, then $4ab^2 = 1$ implies $4a = 3$, and $4ab^2 = 2$ implies $4a = 4$, both contradictions.
- (b) If $b = (1324)\pi$, then $\{3, 4\}a \neq \{3, 4\}$ and in Fig. 11 we draw a P3MSA for this case, proving that either the word $ababa$ or ab^3aba 3-compresses \mathcal{A} . Observe that if $3ab = 1$, then $3a = 4$, $4a \neq 3$, and so $4ab \notin \{1, 2\}$, else if $3ab = 2$, then $3a = 3$, $4a \notin \{3, 4\}$, and again $4ab \notin \{1, 2\}$.
4. Let $|Orb_b(1)| \geq 5$, then we have to consider the two subcases $b = (12345)\pi$ and $b = (13245)\pi$, as the cases $b = (13425\dots)\pi$, $b = (13452\dots)\pi$, and $b = (13456\dots)\pi$ were already analyzed in Fig. 6.
- (a) If $b = (12345\dots)\pi$, then in Fig. 12 we draw a P3MSA for this case, proving that one of the words ab^2ab^2a , ab^2abab^2a or $ab^2a^2b^2a$ 3-compresses \mathcal{A} . Note that if $3ab^2 = 1$ and $3a^2b^2 = 2$, then $3abab^2 \notin \{1, 2\}$. In fact if $3abab^2 = 1$, then $3a = 3aba$, hence $3a = 2$ and $3ab^2 = 4$, a contradiction. If $3abab^2 = 2$, then $3aba = 3a^2$, hence $3ab = 3a$ and $3ab^2 = 3ab = 1$, again a contradiction. Similarly, if $3ab^2 = 2$ and $4ab^3 = 2$, then $3abab^2 \notin \{1, 2\}$; in fact if $3abab^2 = 1$ then $3ab^2ab^2 = 4ab^2$ and $3ab^2 = 4$, else if $3abab^2 = 2$ then $3ab^2 = 3abab^2$ hence $3ab = 3$ and $3ab^2 = 4$, and in both cases this is a contradiction.

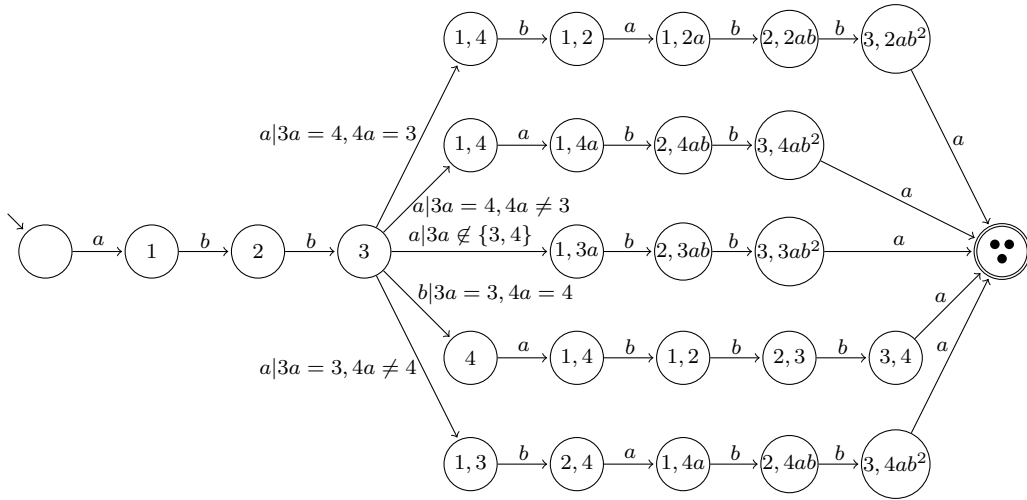

Fig. 10: P3MSA for the case $b = (1234)\pi$.

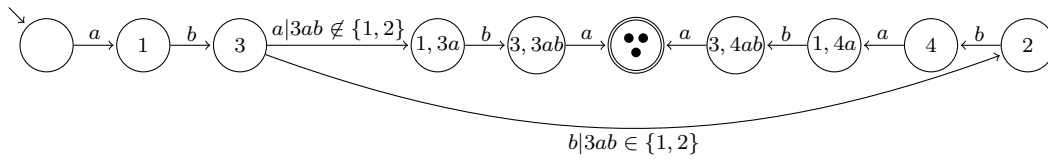

Fig. 11: P3MSA for the case $b = (1324)\pi$ and $\{3,4\}a \neq \{3,4\}$.

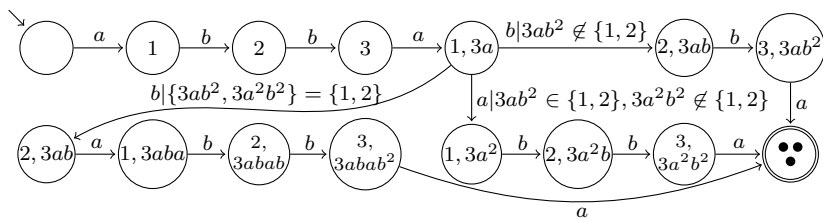

Fig. 12: P3MSA for the case $b = (12345 \dots)\pi$.

(b) If $b = (13245 \dots)\pi$, then in Fig. 13 we draw a P3MSA for this case, proving that one of the words ab^3ab^3a , ab^3aba or $abab^3a$ or $ababa$ 3-compresses \mathcal{A} .

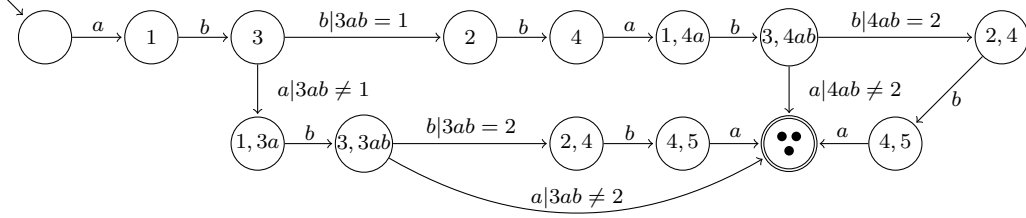

Fig. 13: 3MSA for the case $b = (13245 \dots)\pi$.

□

Proposition 11 Let \mathcal{A} be a $(4, \mathbf{p})$ -automaton with $a = [1, 2] \setminus 3, 3a = 1$. Then \mathcal{A} is 3-compressible (and proper) if and only if the following conditions hold:

1. $\{1, 3\}b \neq \{1, 3\}$;
2. $b \neq (12)(3)\pi$;
3. if $b = (1)(23)\pi$, or $b = (123)\pi$, or $b = (132)\pi$, then $2a \neq 2$;
4. if $b = (1)(2)(34)\pi$, or $b = (12)(34)\pi$, or $b = (14)(23)\pi$, or $b = (1423)\pi$, or $b = (1324)\pi$, then $4a \neq 2$.

Moreover, if \mathcal{A} is 3-compressible (and proper), then one of the words a^2ba^2 , $a^2b^2a^2$, a^2b^3a , a^2baba^2 or ab^3ab^3a 3-compresses \mathcal{A} .

Proof: Let \mathcal{A} be a $(4, \mathbf{p})$ -automaton that does not satisfy one of the conditions 1.-4. We prove that it is not 3-compressible.

1. Let condition 1. be false, i.e., $\{1, 3\}b = \{1, 3\}$, then the 3MSA in Fig. 14(1) proves that \mathcal{A} is not 3-compressible.
2. Let condition 2. be false, i.e., $b = (12)(3)\pi$, then the 3MSA in Fig. 14(2) proves that \mathcal{A} is not 3-compressible.
3. Let condition 3. be false, i.e., $b = (1)(23)\pi$ or $b = (123)\pi$ or $b = (132)\pi$, and $2a = 2$. Then the 3MSA in figures 15(1), 15(2) and 15(3) prove that \mathcal{A} is not 3-compressible.
4. Let condition 4. be false, i.e., $b = (1)(2)(34)\pi$ or $b = (12)(34)\pi$ or $b = (14)(23)\pi$ or $b = (1423)\pi$ or $b = (1324)\pi$, and $4a = 2$. Then the 3MSA in figures 16(1), 16(2), 16(3) and 16(4) prove that \mathcal{A} is not 3-compressible.

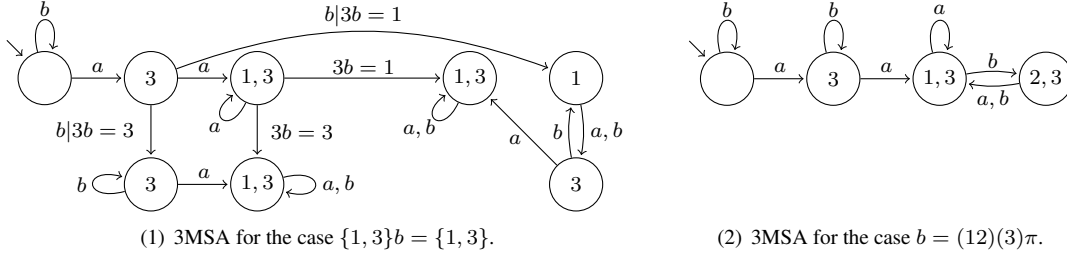

Fig. 14: 3MSA for automata that do not satisfy conditions 1. or 2. of Proposition 11.

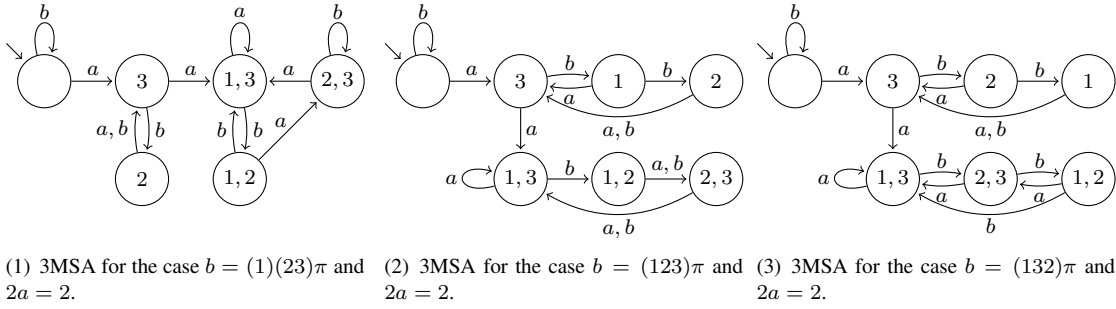

Fig. 15: 3MSA for automata that do not satisfy condition 3. of Proposition 11.

Conversely, let \mathcal{A} be an automaton satisfying conditions 1.-4.

If $Orb_b(1, 3) \subseteq \{1, 2, 3\}$, then $Orb_b(1, 3) = \{1, 2, 3\}$, as $\{1, 3\}b \neq \{1, 3\}$. There are two subcases:

1. if $b = (1)(23)\pi$ or $b = (123)\pi$, and $2a \neq 2$, then $\mathcal{M}(a^2b) = \{1, 2\}$, $\mathcal{M}(a^2ba) = \{2a, 3\}$, and $\mathcal{M}(a^2ba^2) = \{1, 3, 2a^2\}$, and the word a^2ba^2 3-compresses \mathcal{A} ;
2. if $b = (132)\pi$ and $2a \neq 2$, then $\mathcal{M}(a^2b) = \{2, 3\}$, $\mathcal{M}(a^2b^2) = \{1, 2\}$, $\mathcal{M}(a^2b^2a) = \{2a, 3\}$, and $\mathcal{M}(a^2b^2a^2) = \{1, 3, 2a^2\}$, and the word $a^2b^2a^2$ 3-compresses \mathcal{A} .

Let now $Orb_b(1, 3) \not\subseteq \{1, 2, 3\}$, we distinguish four subcases by considering the cardinality of $Orb_b(3)$.

1. Let $Orb_b(3) = \{3\}$, then there are two further subcases:
 - (a) if $b = (14\dots)(3)\pi$, then $\mathcal{M}(a^2b) = \{3, 4\}$, $\mathcal{M}(a^2ba) = \{1, 3, 4a\}$, and the word a^2ba 3-compresses \mathcal{A} ;
 - (b) if $b = (124\dots)(3)\pi$, then $\mathcal{M}(a^2b) = \{2, 3\}$, $\mathcal{M}(a^2b^2) = \{3, 4\}$, $\mathcal{M}(a^2b^2a) = \{1, 3, 4a\}$, and the word a^2b^2a 3-compresses \mathcal{A} .
2. Let $Orb_b(3) = \{2, 3\}$, then there are two further subcases:
 - (a) if $b = (14)(23)\pi$, and $4a \neq 2$, then $\mathcal{M}(a^2b) = \{2, 4\}$, $\mathcal{M}(a^2ba) = \{3, 4a\}$, $\mathcal{M}(a^2ba^2) = \{1, 3, 4a^2\}$, and the word a^2ba^2 3-compresses \mathcal{A} ;

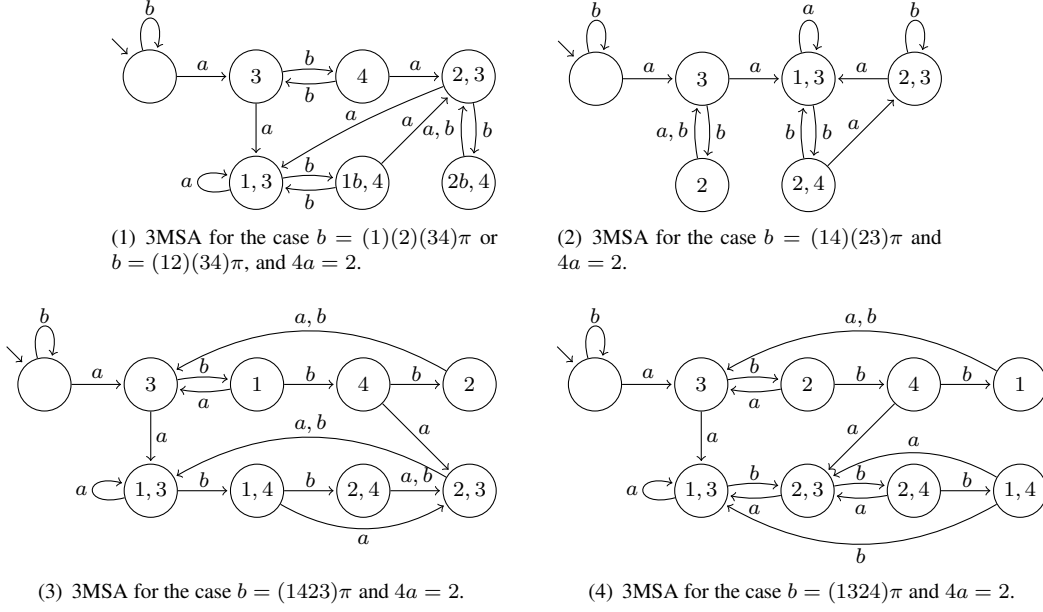

Fig. 16: 3MSA for automata that do not satisfy condition 4. of Proposition 11.

(b) if $b = (145\dots)(23)\pi$, then $\mathcal{M}(a^2b) = \{2, 4\}$, $\mathcal{M}(a^2b^2) = \{3, 5\}$, $\mathcal{M}(a^2b^2a) = \{1, 3, 5a\}$, and the word a^2b^2a 3-compresses \mathcal{A} .

3. Let $Orb_b(3) = \{3, 4\}$, i.e., $b = (34)\pi$, then in Fig. 17 we draw a P3MSA for this case, proving that one of the words a^2b^2a , a^2ba , aba^2 or $ababa$ 3-compresses \mathcal{A} . Observe that, if $4a = 2$ and $1b = 1$, then by condition 4. we have $2b \neq 2$. Similarly, if $4a = 2$ and $1b = 2$, then $2b \neq 1$.

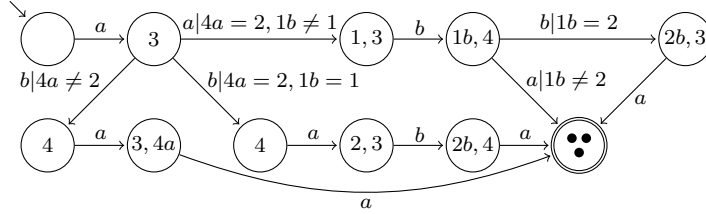

Fig. 17: P3MSA for the case $b = (34)\pi$.

4. Let $|Orb_b(3)| \geq 3$, then there are three main subcases.

(a) $3b = 1$.

i. If $b = (3124\dots)\pi$, then $\mathcal{M}(a^2b) = \{1, 2\}$, $\mathcal{M}(a^2b^2) = \{2, 4\}$, $\mathcal{M}(a^2b^3) = \{4, 4b\}$, $\mathcal{M}(a^2b^3a) = \{3, 4a, 4ba\}$ and the word a^2b^3a 3-compresses \mathcal{A} .

- ii. If $b = (314\dots)\pi$, then the P3MSA in Fig. 18 proves that one of the words a^2baba^2 , a^2b^2a or ab^2a^2 3-compresses \mathcal{A} . Observe that if $4a = 2$ and $4b = 2$, then b is of the form $(31425\dots)\pi$, otherwise condition 4. is not satisfied.

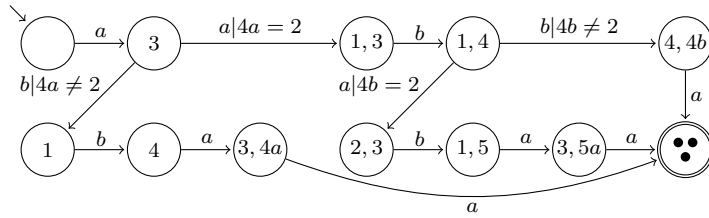

Fig. 18: P3MSA for the case $b = (314\dots)\pi$.

- (b) $3b = 2$.

- i. If $b = (3214\dots)\pi$, then the P3MSA in Fig. 19 proves that either the word a^2ba^2 or ab^3ab^3a 3-compresses \mathcal{A} .

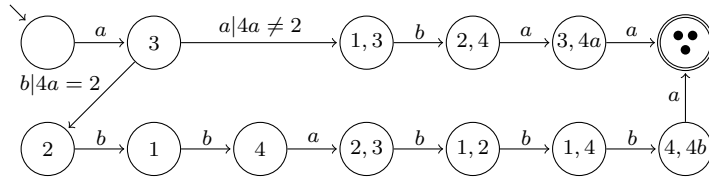

Fig. 19: P3MSA for the case $b = (3214\dots)\pi$.

- ii. If $b = (324\dots)\pi$, then in Fig. 20 we draw a P3MSA for this case, proving that one of the words ab^2a^2 , a^2b^3a or a^2ba^2 3-compresses \mathcal{A} . Observe that $1b \neq 3$ implies $1ba \neq 1$. Moreover if $4a = 2$, then $1ba \neq 2$, otherwise the contradiction $1b = 4$ arises. So when $4a = 2$ and $1b \neq 3$ we have $1ba \notin \{1, 2\}$. Finally, if $4a = 2$ and $1b = 3$, then by condition 4. we have $4b \neq 1$.

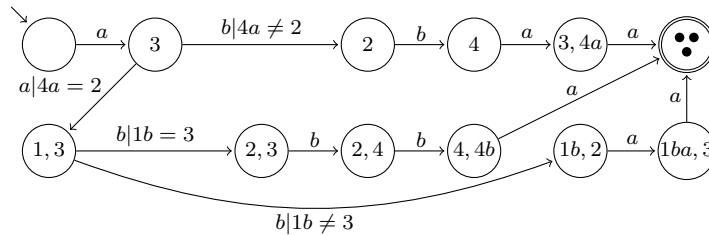

Fig. 20: P3MSA for the case $b = (324\dots)\pi$.

- (c) $3b = 4$.

- i. If $1b \notin \{1, 2\}$, then $\mathcal{M}(a^2b) = \{1b, 4\}$, $\mathcal{M}(a^2ba) = \{1ba, 3, 4a\}$, and the word a^2ba 3-compresses \mathcal{A} .
- ii. If $1b \in \{1, 2\}$ and $4a \neq 2$, then $\mathcal{M}(aba) = \{4a, 3\}$ and $\mathcal{M}(aba^2) = \{4a^2, 1, 3\}$, and the word aba^2 3-compresses \mathcal{A} .
- iii. If $1b \in \{1, 2\}$, $4a = 2$ and $2b \in \{1, 2\}$, then $4b \notin \{1, 2, 3, 4\}$ and $4ba \notin \{1, 2, 3\}$, so $\mathcal{M}(ab^2a) = \{3, 4ba\}$ and $\mathcal{M}(ab^2a^2) = \{1, 3, 4ba^2\}$, and the word ab^2a^2 3-compresses \mathcal{A} .
- iv. If $1b \in \{1, 2\}$, $4a = 2$ and $2b \notin \{1, 2\}$, then $\mathcal{M}(aba) = \{2, 3\}$, $\mathcal{M}(abab) = \{2b, 4\}$ and $\mathcal{M}(ababa) = \{2ba, 2, 3\}$, and the word $ababa$ 3-compresses \mathcal{A} .

□

4 3-compressible automata without permutations

In this section we characterize proper 3-compressible automata on 2-letter alphabet where no letter acts as a permutation.

Proposition 12 *Let \mathcal{A} a (\mathbf{i}, \mathbf{j}) -automaton with $i \in \{1, 2\}$ and $j \in \{1, 2, 4\}$, then \mathcal{A} is either not 3-compressible or not proper.*

Proof: We have to consider five different cases.

1. Let \mathcal{A} be a $(\mathbf{1}, \mathbf{1})$ -automaton with $a = [1, 2, 3] \setminus 1, 2$ and $b = [x, y, z] \setminus x, y$:
 - (a) if $\{1, 2\} \subseteq \{x, y, z\}$ and $\{x, y\} \subseteq \{1, 2, 3\}$, then for any $w \in \{a, b\}^*$, we have $\mathcal{M}(wa) = \{1, 2\}$ and $\mathcal{M}(wb) = \{x, y\}$, so \mathcal{A} is not 3-compressible;
 - (b) if $\{1, 2\} \not\subseteq \{x, y, z\}$, then $|\mathcal{M}(ab)| \geq 3$, so \mathcal{A} is not proper; similarly if $\{x, y\} \not\subseteq \{1, 2, 3\}$, then $|\mathcal{M}(ba)| \geq 3$, and again \mathcal{A} is not proper.
2. Let \mathcal{A} be a $(\mathbf{1}, \mathbf{2})$ -automaton with $a = [1, 2, 3] \setminus 1, 2$ and $b = [x, y][z, v] \setminus x, z$:
 - (a) if $\{1, 2\} \in \{\{x, z\}, \{x, v\}, \{y, z\}, \{y, v\}\}$ and $\{x, z\} \subseteq \{1, 2, 3\}$, then for any $w \in \{a, b\}^*$, we have $\mathcal{M}(wa) = \{1, 2\}$ and $\mathcal{M}(wb) = \{x, z\}$, so \mathcal{A} is not 3-compressible;
 - (b) if $\{1, 2\} \notin \{\{x, z\}, \{x, v\}, \{y, z\}, \{y, v\}\}$, then $|\mathcal{M}(ab)| \geq 3$, so \mathcal{A} is not proper; similarly if $\{x, z\} \not\subseteq \{1, 2, 3\}$, then $|\mathcal{M}(ba)| \geq 3$, and again \mathcal{A} is not proper.
3. Let \mathcal{A} be a $(\mathbf{2}, \mathbf{2})$ -automaton with $a = [1, 2][3, 4] \setminus 1, 3$ and $b = [x, y][z, v] \setminus x, z$:
 - (a) if $\{1, 3\} \in \{\{x, z\}, \{x, v\}, \{y, z\}, \{y, v\}\}$ and $\{x, z\} \in \{\{1, 3\}, \{1, 4\}, \{2, 3\}, \{2, 4\}\}$, then for all $w \in \{a, b\}^*$, we have $\mathcal{M}(wa) = \{1, 3\}$ and $\mathcal{M}(wb) = \{x, z\}$, so \mathcal{A} is not 3-compressible;
 - (b) if $\{1, 3\} \notin \{\{x, z\}, \{x, v\}, \{y, z\}, \{y, v\}\}$, then $|\mathcal{M}(ab)| \geq 3$, so \mathcal{A} is not proper; similarly if $\{x, z\} \notin \{\{1, 3\}, \{1, 4\}, \{2, 3\}, \{2, 4\}\}$, then $|\mathcal{M}(ba)| \geq 3$, and again \mathcal{A} is not proper.
4. Let \mathcal{A} be a $(\mathbf{1}, \mathbf{4})$ -automaton with $a = [1, 2, 3] \setminus 1, 2$ and $b = [x, y] \setminus z, zb = x$:

- (a) if $\{x, z\} \not\subseteq \{1, 2, 3\}$, then $\mathcal{M}(b^2) = \{x, z\}$ and $\mathcal{M}(b^2a) = \{1, 2, xa, za\}$, so \mathcal{A} is not proper;
- (b) if $\{x, z\} = \{1, 2\}$, then for all $w \in \{a, b\}^+ \setminus \{b\}$, we have $\mathcal{M}(w) = \{1, 2\}$, so \mathcal{A} is not 3-compressible;
- (c) if $\{x, z\} = \{1, 3\}$. If $x = 1$ and $z = 3$, the P3MSA in Fig. 21(1) proves that if $2b = y = 2$ then \mathcal{A} is not 3-compressible, else it is not proper. If $x = 3$ and $z = 31$, the P3MSA in Fig. 21(2) proves that if $y = 2$ then \mathcal{A} is not 3-compressible, else it is not proper;

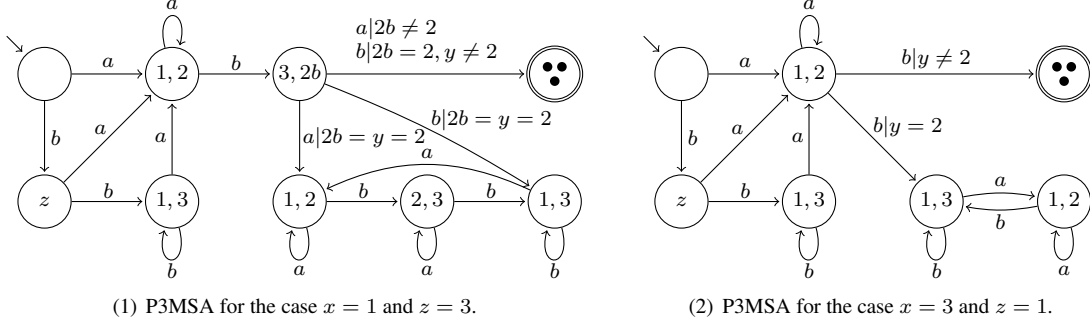

Fig. 21: 3MSA for a (1, 4)-automaton with $a = [1, 2, 3] \setminus 1, 2$, $b = [x, y] \setminus z$, $zb = x$ and $\{x, z\} = \{1, 3\}$.

- (d) if $\{x, z\} = \{2, 3\}$, this case reduces to the previous exchanging the state 1 and 2.

5. Let \mathcal{A} be a (2, 4)-automaton with $a = [1, 2][3, 4] \setminus 1, 3$ and $b = [x, y] \setminus z$, $zb = x$:

- (a) if $\{x, z\} \notin \{\{1, 3\}, \{1, 4\}, \{2, 3\}, \{2, 4\}\}$, then $\mathcal{M}(b^2) = \{x, z\}$ and $|\mathcal{M}(b^2a)| \geq 3$, so \mathcal{A} is not proper;
- (b) if $\{x, y\} \cap \{1, 3\} = \emptyset$, then $\mathcal{M}(ab) = \{1b, 3b, z\}$, so \mathcal{A} is not proper;
- (c) if $\{x, z\} = \{1, 3\}$, then for all $w \in \{a, b\}^+ \setminus \{b\}$, we have $\mathcal{M}(w) = \{1, 3\}$, so \mathcal{A} is not 3-compressible;
- (d) if $\{x, z\} = \{1, 4\}$ and $\{x, y\} \cap \{1, 3\} \neq \emptyset$, we consider two subcases:
 - i. if $x = 4$ and $z = 1$, then y must be equal to 3. So $b = [4, 3] \setminus 1$, then for all $w \in \{a, b\}^+$, we have $\mathcal{M}(wa) = \{1, 3\}$ and $\mathcal{M}(wb) = \{1, 4\}$, so \mathcal{A} is not 3-compressible;
 - ii. if $x = 1$ and $z = 4$, then if $y \neq 2$ the P3MSA in Fig. 22(1) proves that \mathcal{A} is not proper. Else, if $y = 2$ and $3b \neq 2$, then the word aba 3-compresses \mathcal{A} which is not proper. Otherwise, if $y = 2$ and $3b = 2$, then the 3MSA in Fig. 22 proves that \mathcal{A} is not 3-compressible;
- (e) if $\{x, z\} = \{2, 3\}$, this case reduces to the previous exchanging the state 1 and 3, as well as the states 2 and 4;
- (f) if $\{x, z\} = \{2, 4\}$ and $\{x, y\} \cap \{1, 3\} \neq \emptyset$ then $y \in \{1, 3\}$. Let $q \in \{1, 3\} \setminus \{y\}$:
 - i. if $b = [2, 1] \setminus 4$ and $q = 3$, or $b = [4, 3] \setminus 2$ and $q = 1$ then, if $qb \neq y$ we have $\mathcal{M}(ab) = \{z, qb\}$ and $\mathcal{M}(aba) = \{1, 3, qba\}$, so the automaton is not proper, else if $qb = y$ \mathcal{A} is not 3-compressible, as shown in Fig. 22(2);

- ii. if $b = [2, 3] \setminus 4$ and $q = 1$, or $b = [4, 1] \setminus 2$ and $q = 3$ then either the word ab^2 or aba 3-compresses \mathcal{A} , so it is not proper.

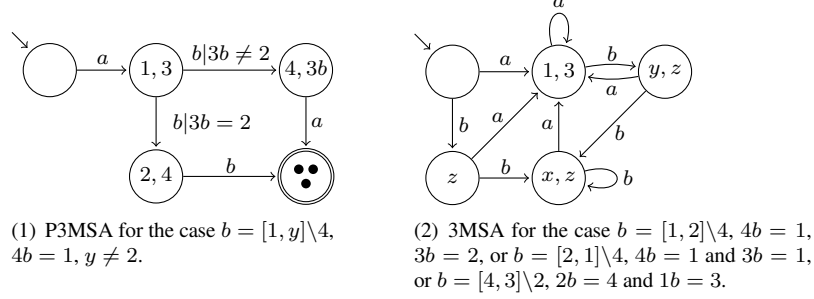

Fig. 22: 3MSA for a $(2, 4)$ -automaton with $a = [1, 2][3, 4] \setminus 1, 3$ and b satisfying either condition (d).ii or (f).i.

□

Proposition 13 Let \mathcal{A} be a $(1, 3)$ -automaton with $a = [1, 2, 3] \setminus 1, 2$ and $b = [x, y] \setminus x$. Then \mathcal{A} is 3-compressible and proper if and only if the following conditions hold:

1. $x \in \{1, 2, 3\}$;
2. $\{1, 2\} \cap \{x, y\} \neq \emptyset$;
3. if $x \in \{1, 2\}$, then for $q \in \{1, 2\} \setminus \{x\}$ it is $qb \in \{1, 2, 3\}$ and $Orb_b(q) \not\subseteq \{1, 2, 3\}$;
4. if $x = 3$, then for $q \in \{1, 2\} \setminus \{y\}$ it is $qb \in \{1, 2, 3\}$ and $Orb_b(q) \not\subseteq \{1, 2, 3\}$.

Moreover, if \mathcal{A} is 3-compressible and proper, then the word ab^2a 3-compresses \mathcal{A} .

Proof: Let \mathcal{A} be a $(1, 3)$ -automaton that does not satisfy one of the conditions 1.-3.

1. Let $x \notin \{1, 2, 3\}$, then the word ba 3-compresses \mathcal{A} , and so it is not proper.
2. Let $\{1, 2\} \cap \{x, y\} = \emptyset$, then the word ab 3-compresses \mathcal{A} , and so it is not proper.
3. Now let $x \in \{1, 2, 3\}$ and $\{1, 2\} \cap \{x, y\} \neq \emptyset$.
 - (a) Suppose $x \in \{1, 2\}$ and let $q \in \{1, 2\} \setminus \{x\}$.
 - i. If $qb \notin \{1, 2, 3\}$, then $\mathcal{M}(ab) = \{qb, x\}$ and $\mathcal{M}(aba) = \{1, 2, qba\}$, so the word aba 3-compresses \mathcal{A} which is not proper.
 - ii. Suppose $qb \in \{1, 2, 3\}$ and $Orb_b(q) \subseteq \{1, 2, 3\}$, then $qb \in \{q, 3\}$ and $3b = q$, so \mathcal{A} is not 3-compressible, as shown in Fig. 23(1).
 - (b) Lastly, suppose $x = 3$ and let $q \in \{1, 2\} \setminus \{y\}$.

- i. If $qb \notin \{1, 2, 3\}$, then $\mathcal{M}(ab) = \{qb, x\}$ and $\mathcal{M}(aba) = \{1, 2, qba\}$, so the word aba 3-compresses \mathcal{A} which is not proper.
- ii. Suppose $qb \in \{1, 2, 3\}$ and $\text{Orb}_b(q) \subseteq \{1, 2, 3\}$. Then $y \in \{1, 2\}$ (as $\{1, 2\} \cap \{x, y\} \neq \emptyset$) and $qb \in \{1, 2\} = \{q, y\}$ (as $x = 3$ does not belong to the image of b). Moreover, as $\text{Orb}_b(q) \subseteq \{1, 2\} = \{q, y\}$, also $yb \in \{1, 2\}$ and then \mathcal{A} is not 3-compressible, as shown in Fig. 23(2).

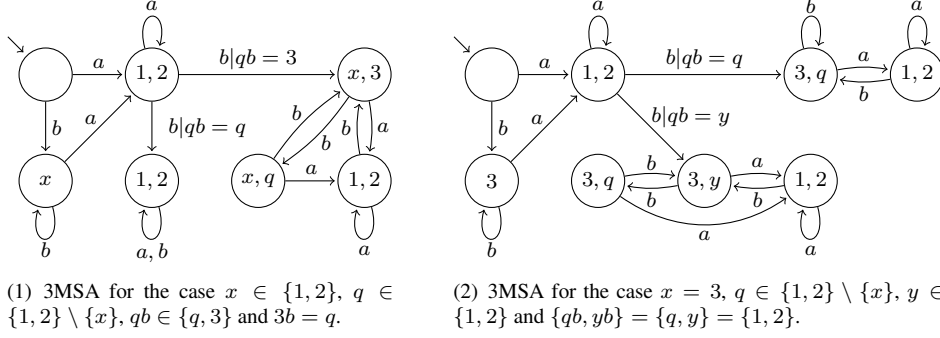

Fig. 23: 3MSA for automata that do not satisfy condition 3. or 4. of Proposition 13.

Conversely, suppose $x \in \{1, 2, 3\}$ and $\{1, 2\} \cap \{x, y\} \neq \emptyset$. If $x \in \{1, 2\}$, let $q \in \{1, 2\} \setminus \{x\}$, otherwise, if $x = 3$ let $q \in \{1, 2\} \setminus \{y\}$. In any cases, $\mathcal{M}(ab) = \{x, qb\}$, $\mathcal{M}(ab^2) = \{x, qb^2\}$, and, as $qb^2 \notin \{1, 2, 3\}$, $\mathcal{M}(ab^2a) = \{1, 2, qb^2a\}$, and the word ab^2a 3-compresses \mathcal{A} . \square

Proposition 14 Let \mathcal{A} be a $(2, 3)$ -automaton with $a = [1, 2][3, 4]1, 3$ and $b = [x, y]x$. Then \mathcal{A} is 3-compressible and proper if and only if the following conditions hold:

1. $x \in \{1, 2, 3, 4\}$;
2. if $x = 1$, then $3b = 4$ and $\text{Orb}_b(3) \not\subseteq \{3, 4\}$;
3. if $x = 2$, then $y \in \{1, 3\}$ and
 - (a) if $y = 1$, then $3b = 4$ and $4b \neq 3$;
 - (b) if $y = 3$, then $1b \in \{3, 4\}$;
4. if $x = 3$, then $1b = 2$ and $\text{Orb}_b(1) \not\subseteq \{1, 2\}$;
5. if $x = 4$, then $y \in \{1, 3\}$ and
 - (a) if $y = 1$, then $3b \in \{1, 2\}$;
 - (b) if $y = 3$, then $1b = 2$ and $2b \neq 1$.

Moreover, if \mathcal{A} is 3-compressible and proper, then either the word ab^2a or ab^3a 3-compresses \mathcal{A} .

Proof: Let \mathcal{A} be a $(2, 3)$ -automaton that does not satisfy one of the conditions 1.-5.

1. Let $x \notin \{1, 2, 3, 4\}$, then the word ba 3-compresses \mathcal{A} , and so it is not proper.
2. Let $x = 1$:
 - (a) if $3b \neq 4$, then if $3b = 3$ \mathcal{A} is not 3-compressible, while if $3b \neq 3$ the word aba 3-compresses \mathcal{A} that it is not proper, as shown in Fig. 24(1);
 - (b) if $3b = 4$ and $Orb_b(3) \subseteq \{3, 4\}$, then \mathcal{A} is not 3-compressible, as shown in Fig. 24(2).

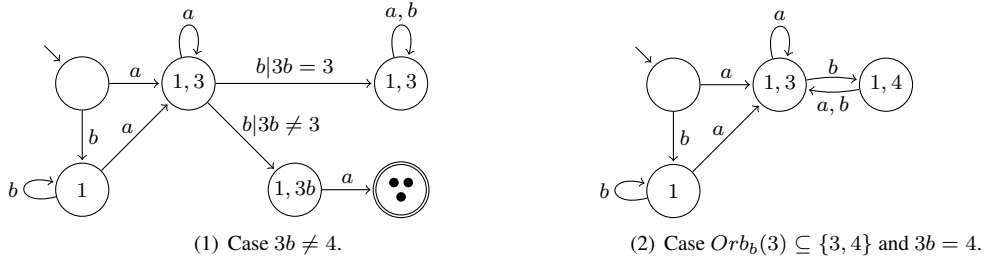

Fig. 24: 3MSA for automata that do not satisfy condition 2. of Proposition 14.

3. Let $x = 2$:
 - (a) if $y \notin \{1, 3\}$, then the word ab 3-compresses \mathcal{A} , and so it is not proper;
 - (b) if $y = 1$, then if $3b \neq 4$, then \mathcal{A} is not 3-compressible, as shown in Fig. 25(1); while if $3b = 4$ and $4b = 3$, then \mathcal{A} is not 3-compressible, as shown in Fig. 25(2);

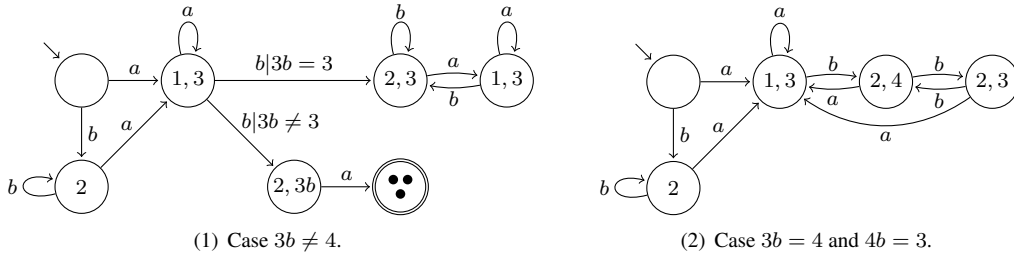

Fig. 25: 3MSA for automata that do not satisfy condition 3. of Proposition 14 with $y = 1$.

- (c) if $y = 3$ and $1b \notin \{3, 4\}$, then $\mathcal{M}(ab) = \{2, 1b\}$, and $\mathcal{M}(aba) = \{1, 3, 1ba\}$, so the word aba 3-compresses \mathcal{A} that it is not proper.

The cases with $x = 3$ and $x = 4$ are symmetrical to case 3. and 4., respectively.

Conversely, suppose $x \in \{1, 2, 3, 4\}$.

1. Let $x = 1$, $3b = 4$ and $Orb_b(3) \not\subseteq \{3, 4\}$, this implies $4b = 3b^2 \notin \{3, 4\}$. Then $\mathcal{M}(ab) = \{1, 4\}$, $\mathcal{M}(ab^2) = \{1, 4b\}$ and $\mathcal{M}(ab^2a) = \{1, 3, 4ba\}$, so ab^2a 3-compresses \mathcal{A} .
2. Let $x = 2$:
 - (a) if $y = 1$, $3b = 4$ and $4b \neq 3$, then $\mathcal{M}(ab) = \{2, 4\}$, $\mathcal{M}(ab^2) = \{2, 4b\}$ and $\mathcal{M}(ab^2a) = \{1, 3, 4ba\}$, so ab^2a 3-compresses \mathcal{A} ;
 - (b) if $y = 3$ and $1b \in \{3, 4\}$, then either the word ab^2a or ab^3a 3-compresses \mathcal{A} , as shown in Fig. 26.

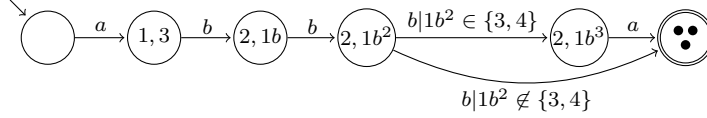

Fig. 26: P3MSA for the case $b = [2, 3] \setminus 2$ and $1b \in \{3, 4\}$.

The cases with $x = 3$ and $x = 4$ are symmetrical to those with $x = 1$ and $x = 2$, respectively. \square

The following lemma is straightforward.

Lemma 15 *Let \mathcal{A} be a $(3, 3)$ 3-compressible automaton with $a = [1, 2] \setminus 1$ and $b = [x, y] \setminus x$. Then $x \neq 1$ and $\{x, y\} \neq \{1, 2\}$.*

Lemma 16 *Let \mathcal{A} be a $(3, 3)$ 3-compressible automaton with $a = [1, 2] \setminus 1$ and $b = [2, y] \setminus 2$ with $y \neq 1$. Then:*

1. $\{1ba, 1b^2a, 1b^3a\} \not\subseteq \{2, y\}$, or
2. $Orb_a(1ba) \not\subseteq \{2, y\}$.

Proof: Let \mathcal{A} be a $(3, 3)$ -automaton that does not satisfy the above conditions, we prove that it is not 3-compressible.

1. Let $1b = 1$ and $Orb_a(1ba) \subseteq \{2, y\}$.
 - (a) If $1ba = 1a = 2a = 2$, then the 3MSA in Fig. 27(1) proves that \mathcal{A} is not 3-compressible.
 - (b) If $1ba = 1a = 2a = y$, then $ya = 1ba^2 = 2$ and the 3MSA in Fig. 27(2) proves that \mathcal{A} is not 3-compressible.
2. Let $1b \neq 1$, $\{1ba, 1b^2a, 1b^3a\} \subseteq \{2, y\}$ and $Orb_a(1ba) \subseteq \{2, y\}$. If $1ba = 1b^2a$ or $1b^2a = 1b^3a$, then, since for all $h > 0$ we have that $1b^h \neq 2$, we obtain that $1 = 1b$, against the hypothesis. If $1b^2a = 1b^3a$, as $1b^2 \neq 2$, then $1b^2 = 1b^3$, and then $1 = 1b$, against the hypothesis. So, as $|\{1ba, 1b^2a, 1b^3a\}| \leq 2$, $1ba = 1b^3a$, then $1b = 1b^3$ and $1 = 1b^2$.
 - (a) If $1ba = 2$, then $1b^2a = y$, hence $1a = 2a = y$, $ya = 2$ and $1b = y$. The 3MSA in Fig. 28(1) proves that \mathcal{A} is not 3-compressible.

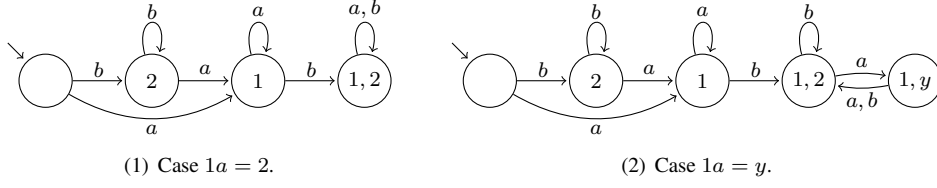

Fig. 27: 3MSA for automata that do not satisfy conditions 1. and 2. of Lemma 16 with $1b = 1$.

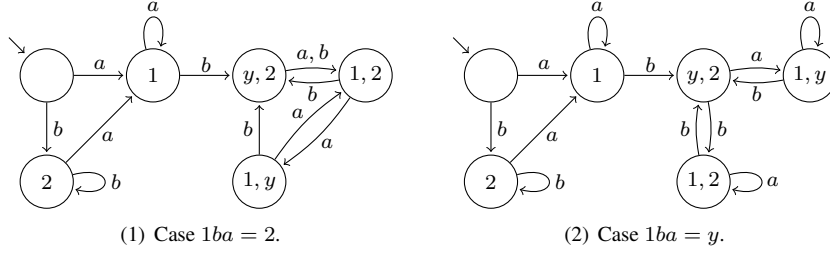

Fig. 28: 3MSA for automata that do not satisfy conditions 1. and 2. of Lemma 16 with $1b \neq 1$.

- (b) If $1ba = y$, then $1b^2a = 1a = 2a = 2$. Moreover, $1ba^2 = y$, otherwise $1ba^2 = 2$ gives the contradiction $1ba = 1$, hence $ya = y$, $1b = y$ and $yb = 1b^2 = 1$. The 3MSA in Fig. 28(2) proves that \mathcal{A} is not 3-compressible.

□

Corollary 17 Let \mathcal{A} be a $(\mathbf{3}, \mathbf{3})$ 3-compressible automaton with $a = [1, 2] \setminus 1$ and $b = [x, 1] \setminus x$ with $x \neq 2$. Then:

1. $\{xab, xa^2b, xa^3b\} \not\subseteq \{1, 2\}$, or
2. $\text{Orb}_b(xab) \not\subseteq \{1, 2\}$.

Proof: It is a straightforward consequence of the previous lemma, simply replacing a with b , 1 with 2, 2 with y and x with 1. □

Lemma 18 Let \mathcal{A} be a proper $(\mathbf{3}, \mathbf{3})$ 3-compressible automaton with $a = [1, 2] \setminus 1$ and $b = [x, y] \setminus x$ with $x \notin \{1, 2\}$ and $y \neq 1$. Then all the following conditions hold:

1. $1b \in \{1, 2\}$;
2. $xa \in \{x, y\}$;
3. $\text{Orb}_b(1) \not\subseteq \{1, 2\}$ or $\text{Orb}_a(x) \not\subseteq \{x, y\}$.

Proof: Let \mathcal{A} be a $(\mathbf{3}, \mathbf{3})$ -automaton that does not satisfy the above conditions, we prove that it is not 3-compressible or not proper.

1. If $1b \notin \{1, 2\}$, then \mathcal{A} is not proper, in fact $\mathcal{M}(ab) = \{x, 1b\}$ and $|\mathcal{M}(aba)| = 3$; similarly
2. if $1b \in \{1, 2\}$ and $xa \notin \{x, y\}$, then \mathcal{A} is not proper, in fact $\mathcal{M}(ba) = \{1, xa\}$ and $|\mathcal{M}(bab)| = 3$.
3. If $1b \in \{1, 2\}$, $xa \in \{x, y\}$, $Orb_b(1) \subseteq \{1, 2\}$ and $Orb_a(x) \subseteq \{x, y\}$, then
 - (a) if $1b = 1$ and $xa = x$, the 3MSA of \mathcal{A} is in Fig. 29(1);
 - (b) if $1b = 1$ and $xa = y$ (and then $ya = x$), the 3MSA of \mathcal{A} is in Fig. 29(2);
 - (c) if $1b = 2$ (and then $2b = 1$) and $xa = x$, the 3MSA of \mathcal{A} is in Fig. 29(3);
 - (d) if $1b = 2$ (and then $2b = 1$) and $xa = y$ (and then $ya = x$) the 3MSA of \mathcal{A} is in Fig. 29(4).

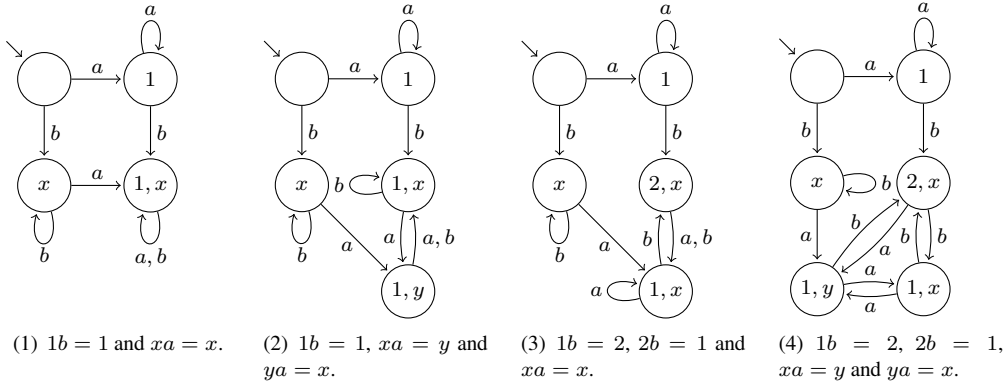

Fig. 29: 3MSA for automata that do not satisfy conditions 3. of Lemma 18

In all the subcases, \mathcal{A} is not 3-compressible. □

Proposition 19 Let \mathcal{A} be a $(\mathbf{3}, \mathbf{3})$ -automaton with $a = [1, 2] \setminus 1$ and $b = [x, y] \setminus x$. Then \mathcal{A} is 3-compressible and proper if and only if one of the following conditions holds:

1. $b = [2, y] \setminus 2$, $y \neq 1$, and either $\{1ba, 1b^2a, 1b^3a\} \not\subseteq \{2, y\}$ or $Orb_a(1ba) \not\subseteq \{2, y\}$;
2. $b = [x, 1] \setminus x$, $x \neq 2$, and either $\{xba, xb^2a, xb^3a\} \not\subseteq \{1, 2\}$ or $Orb_b(xab) \not\subseteq \{1, 2\}$;
3. $b = [x, y] \setminus x$, $x \notin \{1, 2\}$, $y \neq 1$, $1b \in \{1, 2\}$, $xa \in \{x, y\}$, and either $Orb_b(1) \not\subseteq \{1, 2\}$ or $Orb_a(x) \not\subseteq \{x, y\}$.

Moreover, if \mathcal{A} is 3-compressible and proper, then one of the words $abab$ or ab^2ab or ab^3ab or aba^2b or aba^3b or $baba$ or ba^2ba or ba^3ba or bab^2a or bab^3a 3-compresses \mathcal{A} .

Proof: If \mathcal{A} is a 3-compressible $(\mathbf{3}, \mathbf{3})$ -automaton with $a = [1, 2] \setminus 1$ and $b = [x, y] \setminus x$, then, from lemmata 15, 16 and 18 and Corollary 17, one of the above conditions must hold.

Conversely, we find for any automaton satisfying conditions 1. – 3. a (short) 3-compressing word.

1. Let $b = [2, y] \setminus 2$ and $y \neq 1$:
 - (a) if $\{1ba, 1b^2a, 1b^3a\} \not\subseteq \{2, y\}$, then either the word $abab$ or ab^2ab or ab^3ab 3-compresses \mathcal{A} , since $\mathcal{M}(aba) = \{1, 1ba\}$, $\mathcal{M}(ab^2a) = \{1, 1b^2a\}$ and $\mathcal{M}(ab^3a) = \{1, 1b^3a\}$;
 - (b) if $Orb_a(1ba) \not\subseteq \{2, y\}$, then $\{1ba, 1ba^2, 1ba^3\} \not\subseteq \{2, y\}$ and either the word $abab$ or aba^2b or aba^3b 3-compresses \mathcal{A} , since $\mathcal{M}(aba) = \{1, 1ba\}$, $\mathcal{M}(aba^2) = \{1, 1ba^2\}$ and $\mathcal{M}(aba^3) = \{1, 1ba^3\}$.
2. Let $b = [x, 1] \setminus x$, $x \neq 2$, and either $\{xba, xb^2a, xb^3a\} \not\subseteq \{1, 2\}$ or $Orb_b(xab) \not\subseteq \{1, 2\}$. This case reduces to the previous one replacing a with b , 1 with 2, 2 with y and x with 1, then either the word $baba$ or ba^2ba or ba^3ba or bab^2a or bab^3a 3-compresses \mathcal{A} .
3. Let $b = [x, y] \setminus x$, $x \notin \{1, 2\}$, $y \neq 1$, $1b \in \{1, 2\}$ and $xa \in \{x, y\}$. If $Orb_b(1) \not\subseteq \{1, 2\}$, then $1b = 2$ and $2b \notin \{1, 2\}$, and so the word ab^2a 3-compresses \mathcal{A} , as $\mathcal{M}(ab^2) = \{x, 2b\}$; similarly, if $Orb_a(x) \not\subseteq \{x, y\}$, exchanging b and a and so x with 1 and y with 2, the word ba^2b 3-compresses \mathcal{A} .

□

Lemma 20 *Let \mathcal{A} be a (3, 4) 3-compressible automaton with $a = [1, 2] \setminus 1$ and $b = [x, y] \setminus z$, $zb = x$. If \mathcal{A} is proper then all the following conditions hold:*

1. $\{1, 2\} \cap \{x, z\} \neq \emptyset$;
2. $z \in \{1, 2\}$ or $\{1, za\} \cap \{x, y\} \neq \emptyset$;
3. $\{1, 1b\} \cap \{x, y\} \neq \emptyset$;
4. $1 \in \{x, y\}$ or $\{z, 1b\} \cap \{1, 2\} \neq \emptyset$.

Proof: If $\{1, 2\} \cap \{x, z\} = \emptyset$, then $|\mathcal{M}(b^2a)| = 3$; if $z \notin \{1, 2\}$ and $\{1, za\} \cap \{x, y\} = \emptyset$, then $|\mathcal{M}(bab)| = 3$; if $\{1, 1b\} \cap \{x, y\} = \emptyset$, then $|\mathcal{M}(ab^2)| = 3$; if $1 \notin \{x, y\}$ and $\{z, 1b\} \cap \{1, 2\} = \emptyset$, then $|\mathcal{M}(aba)| = 3$. So each automaton that does not satisfy one of the conditions of the lemma is 3-compressed by a word of length 3, and then it is not proper. □

Corollary 21 *Let \mathcal{A} be a proper (3, 4) 3-compressible automaton with $a = [1, 2] \setminus 1$ and $b = [x, y] \setminus z$, $zb = x$. Then exactly one of following conditions holds:*

1. $z = 1$;
2. $z = 2$ and $\{1, 1b\} \cap \{x, y\} \neq \emptyset$;
3. $z \notin \{1, 2\}$ and either $b = [1, y] \setminus z$ or $b = [2, 1] \setminus z$.

Proof: It is a straightforward consequence of the previous lemma. □

Proposition 22 *Let \mathcal{A} be a (3, 4)-automaton with $a = [1, 2] \setminus 1$ and $b = [x, y] \setminus z$, $zb = x$. Then \mathcal{A} is 3-compressible and proper if and only if the following conditions hold:*

1. if $b = [x, y] \setminus 1$, then $Orb_a(x) \not\subseteq \{x, y\}$;
2. if $z = 2$ and
 - (a) $b = [1, y] \setminus 2$, then $Orb_a(2) \not\subseteq \{2, y\}$ or $2ab \notin \{1, y\}$;
 - (b) $b = [x, 1] \setminus 2$, then $\{2a, xa\} \neq \{2, x\}$ or $\{2ab, xab\} \neq \{1, x\}$;
 - (c) $b = [x, y] \setminus 2$, $1b = y$, and $1 \notin \{x, y\}$, then $\{xa, ya\} \neq \{x, y\}$;
3. if $z \notin \{1, 2\}$ and
 - (a) $b = [1, y] \setminus z$ and $y \neq 2$, then $za \neq z$;
 - (b) $b = [x, y] \setminus z$ and $\{x, y\} = \{1, 2\}$, then $|Orb_a(z)| > 2$ or $zab \notin \{1, 2\}$.

Moreover, if \mathcal{A} is 3-compressible and proper, then either the word b^2ab^2 or $b^2a^2b^2$ or $b^2a^3b^2$ or b^2abab^2 3-compresses \mathcal{A} .

Proof: First observe that from the previous corollary a proper 3-compressible (3, 4)-automaton always satisfies the antecedent of one of the above conditions, so all the possible cases are taken into account. We start proving that a (3, 4)-automaton that does not satisfy the conditions 1.-3. is not 3-compressible.

1. Let condition 1. be false, i.e., $b = [x, y] \setminus 1$ and $Orb_a(x) \subseteq \{x, y\}$. The 3MSA in Fig. 30 proves that \mathcal{A} is not 3-compressible.

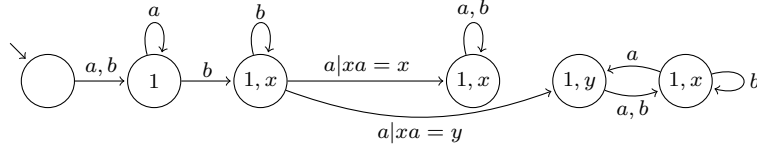

Fig. 30: 3MSA for the case in which condition 1. of Proposition 22 is false.

2. Let $z = 2$.
 - (a) Let condition 2.(a) be false, i.e., $b = [1, y] \setminus 2$, $Orb_a(2) \subseteq \{2, y\}$ and $2ab \in \{1, y\}$. Observe that if $2a \neq 2$, then $2a = y$ and $ya = 2$. Since $y \neq 2$, then $yb = 2ab \neq 1$, and so $2ab = y$. The 3MSA in Fig. 31(1) proves that \mathcal{A} is not 3-compressible.
 - (b) Let condition 2.(b) be false, i.e., $b = [x, 1] \setminus 2$, $\{2a, xa\} = \{2, x\}$ and $\{2ab, xab\} = \{1, x\}$. Observe that if $2a = 2$, then $2ab = 2b = x$ and so $xab = 1$. If $xa = 2$, then $xab = 2b = x$ and so $2ab = 1$. The 3MSA in Fig. 31(2) proves that \mathcal{A} is not 3-compressible.
 - (c) Let condition 2.(c) be false, i.e., $b = [x, y] \setminus 2$, $1b = y$, $1 \notin \{x, y\}$ and $\{xa, ya\} = \{x, y\}$. The 3MSA in Fig. 31(3) proves that \mathcal{A} is not 3-compressible.

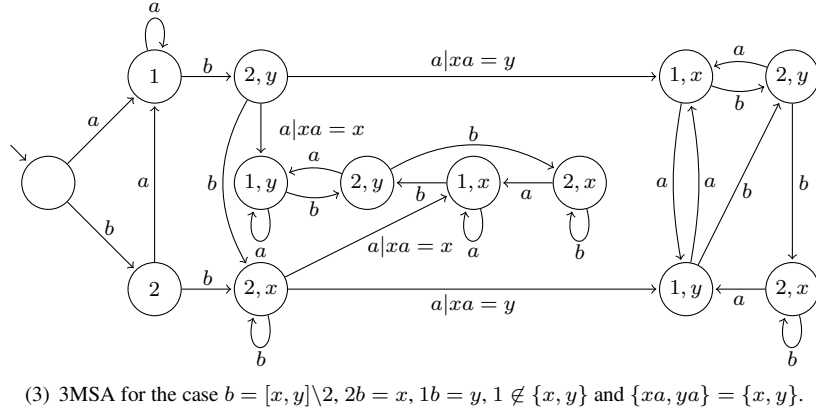
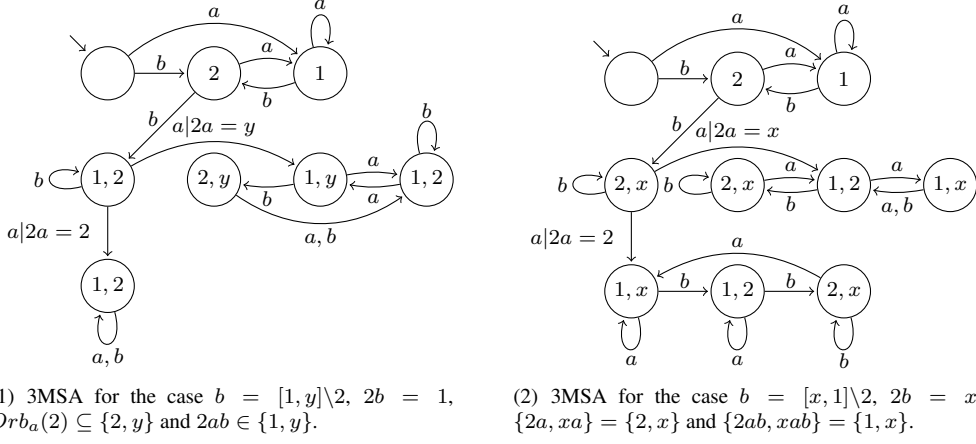

Fig. 31: 3MSA for the case in which condition 2. of Proposition 22 is false.

3. Let $z \notin \{1, 2\}$.

- Let condition 3.(a) be false, i.e., $b = [1, y] \setminus z$, $y \neq 2$ but $za = z$. Then for all $w \in a^*b$ and $u \in \{a, b\}^+$, $\mathcal{M}(w) = \{z\}$ and $\mathcal{M}(wu) = \{1, z\}$, so \mathcal{A} is not 3-compressible.
- Let condition 3.(b) be false, i.e., $b = [x, y] \setminus z$ and $\{x, y\} = \{1, 2\}$, but $|Orb_a(z)| \leq 2$ and $zab \in \{1, 2\}$. If $x = 1$ and $y = 2$, then the 3MSA in Fig. 32(1) proves that \mathcal{A} is not 3-compressible. Else, if $x = 2$ and $y = 1$, then the 3MSA in Fig. 32(2) proves that \mathcal{A} is not 3-compressible.

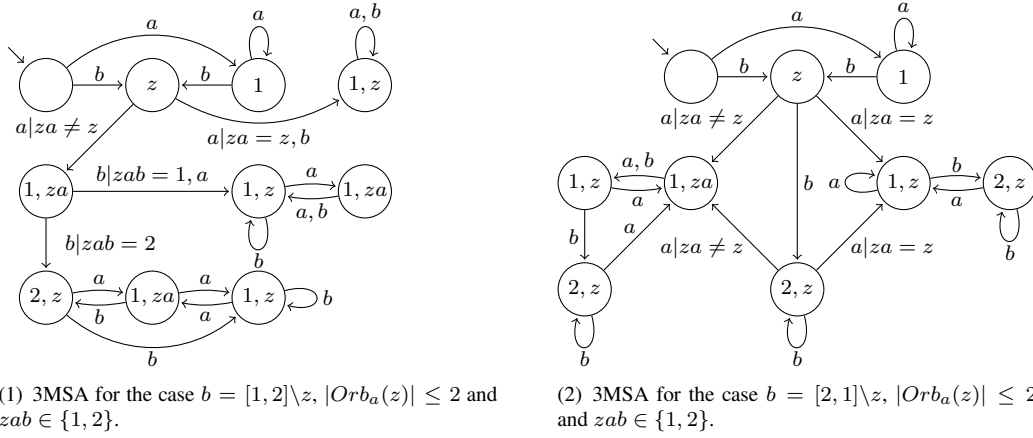

Fig. 32: 3MSA for the case in which condition 3.(b) of Proposition 22 is false.

Conversely, we find for any automaton satisfying conditions 1.-3. a (short) 3-compressing word.

1. Let $b = [x, y] \setminus 1$ and $Orb_a(x) \not\subseteq \{x, y\}$, whence $xa \neq x$. Then either xa or xa^2 are different from y , and so either the word b^2ab or b^2a^2b 3-compresses \mathcal{A} .
2. Let $z = 2$, we consider various subcases.
 - (a) Let $b = [1, y] \setminus 2$. Then $2a \neq 2$, otherwise $Orb_a(2) = \{2\}$ and $2ab = 1$, against the hypothesis. Hence if $2ab = y$, then $2a^2b \neq y$ (otherwise $2a^2 = 2a$ and $2a = 2$). The P3MSA in Fig. 33 proves that either the word b^2ab^2 or $b^2a^2b^2$ 3-compresses \mathcal{A} .

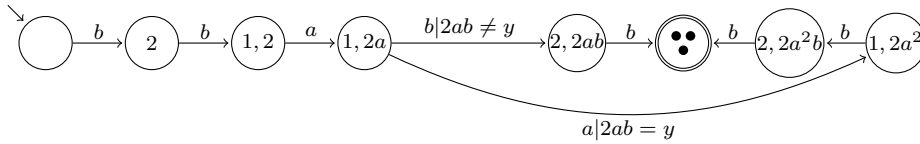

Fig. 33: P3MSA for the case 2.(a) of Proposition 22.

- (b) Let $b = [x, 1] \setminus 2$.
 - i. If $\{2ab, xab\} \neq \{1, x\}$, then the P3MSA in Fig. 34 proves that the word b^2ab^2 or $b^2a^2b^2$ or b^2abab^2 3-compresses \mathcal{A} . Observe that if $xab = x$, then $xa = 2$ and $2ab \notin \{1, x\}$.
 - ii. If $2ab = x$, $xab = 1$, and $\{2a, xa\} \neq \{2, x\}$, then $2ab = 2b$, $2a = 2$ and then $xa \notin \{2, x\}$. So $\mathcal{M}(b^2a) = \{1, xa\}$, $\mathcal{M}(b^2a^2) = \{1, xa^2\}$ and $\mathcal{M}(b^2a^2b) = \{2, xa^2b\}$. If $xa^2b = x = 2b$, then $xa^2 = 2a$, and so $xa = 2$, against the hypothesis. Else, if $xa^2b = 1 = xab$, then $xa^2 = xa$, and so $xa = x$, against the hypothesis. Then it follows that $|\mathcal{M}(b^2a^2b^2)| = 3$ and the word $b^2a^2b^2$ 3-compresses \mathcal{A} .

- i. Let $b = [x, y] \setminus z$ and $|\text{Orb}_a(z)| > 2$. In particular $za \neq z$, $zab \neq za^2b$ and $z \neq za^2$. If $zab = y$, then $za^2b \notin \{zb, zab\} = \{1, 2\}$. The P3MSA in Fig. 37 proves that either the word ba^2b^2 or bab^2 3-compresses \mathcal{A} .

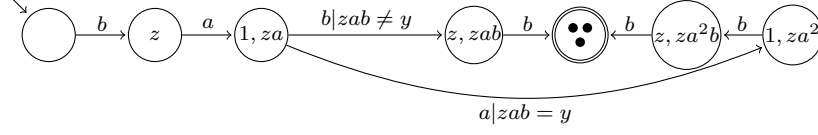

Fig. 37: P3MSA for the case $b = [x, y] \setminus z$, $\{x, y\} = \{1, 2\}$ and $|\text{Orb}_a(z)| > 2$.

- ii. Let $b = [x, y] \setminus z$ and $zab \notin \{1, 2\}$. Then $\mathcal{M}(bab) = \{z, zab\}$ and $|\mathcal{M}(bab^2)| = |\mathcal{M}(baba)| = 3$, both the words bab^2 and $baba$ 3-compress \mathcal{A} .

□

Lemma 23 Let \mathcal{A} be a $(4, 4)$ 3-compressible automaton with $a = [1, 2] \setminus 3$, $3a = 1$ and $b = [x, y] \setminus z$, $zb = x$. If \mathcal{A} is proper then all the following conditions hold:

1. $\{1, 2\} \cap \{x, z\} \neq \emptyset$;
2. $z \in \{1, 2\}$ or $\{3, za\} \cap \{x, y\} \neq \emptyset$;
3. $\{3, 3b\} \cap \{x, y\} \neq \emptyset$;
4. $\{1, 3\} \cap \{x, y\} \neq \emptyset$;
5. $3 \in \{x, y\}$ or $\{z, 3b\} \cap \{1, 2\} \neq \emptyset$;
6. $\{z, za\} \cap \{1, 2\} \neq \emptyset$.

Proof: If $\{1, 2\} \cap \{x, z\} = \emptyset$, then $\mathcal{M}(b^2) = \{x, z\}$ and $|\mathcal{M}(b^2a)| = 3$; if $z \notin \{1, 2\}$ and $\{3, za\} \cap \{x, y\} = \emptyset$, then $\mathcal{M}(ba) = \{3, za\}$ and $|\mathcal{M}(bab)| = 3$; if $\{3, 3b\} \cap \{x, y\} = \emptyset$, then $\mathcal{M}(ab) = \{3b, z\}$ and $|\mathcal{M}(ab^2)| = 3$; if $\{1, 3\} \cap \{x, y\} = \emptyset$, then $\mathcal{M}(a^2) = \{1, 3\}$ and $|\mathcal{M}(a^2b)| = 3$; if $3 \notin \{x, y\}$ and $\{z, 3b\} \cap \{1, 2\} = \emptyset$, then $\mathcal{M}(ab) = \{z, 3b\}$ and $|\mathcal{M}(aba)| = 3$; if $\{z, za\} \cap \{1, 2\} = \emptyset$, then $\mathcal{M}(ba) = \{3, zb\}$ and $|\mathcal{M}(ba^2)| = 3$. Then each automaton that does not satisfies one of the above is not proper. □

Corollary 24 Let \mathcal{A} be a proper $(4, 4)$ 3-compressible automaton with $a = [1, 2] \setminus 3$, $3a = 1$ and $b = [x, y] \setminus z$, $zb = x$. The following conditions hold:

1. if $z = 1$, then $3 \in \{x, y\}$;
2. if $z = 2$, then $3 \in \{x, y\}$ or $1 \in \{x, y\}$ and $3b \in \{x, y\}$;
3. if $z \notin \{1, 2\}$, then $x \in \{1, 2\}$ and $za \in \{1, 2\}$.

Proof: It is a straightforward consequence of the previous lemma. Observe that not all the conditions of Lemma 23 are applied, so some automaton satisfying the conditions of the corollary could possibly be not proper or not 3-compressible. \square

Proposition 25 Let \mathcal{A} be a $(4, 4)$ -automaton with $a = [1, 2] \setminus 3$, $3a = 1$ and $b = [x, y] \setminus z$, $zb = x$. Then \mathcal{A} is 3-compressible and proper if and only if the following conditions hold:

1. if $z = 1$, then $y = 3$ and $xa \neq 2$ or $2b \neq 3$;
2. if $z = 2$ and $3 \notin \{x, y\}$, then $1 \in \{x, y\}$ and $3b \in \{x, y\}$;
3. if $z = 2$ and $3 \in \{x, y\}$, if $q \in \{x, y\} \setminus \{3\}$ then $qa \neq 2$ or $1b \neq y$;
4. if $b = [x, y] \setminus z$, $z \notin \{1, 2\}$, $x \in \{1, 2\}$ and $za \in \{1, 2\}$, then $y = 3$.

Moreover, if \mathcal{A} is 3-compressible and proper, then either the word b^2a^2 or b^2ab^2 or a^2b^2 or a^2ba^2 3-compresses \mathcal{A} .

Proof: First observe that from Corollary 24, a proper 3-compressible $(4, 4)$ -automaton always satisfies the antecedent of one of the above conditions, so all the possible cases are taken into account. We start proving that a $(4, 4)$ -automaton that does not satisfy conditions 1.-4. is not proper or it is not 3-compressible.

1. Let condition 1. be false, i.e., $b = [x, y] \setminus 1$ but either $y \neq 3$ or $xa = 2$ and $2b = 3$. Observe that if $y \neq 3$ then from the previous corollary we have $x = 3$. The 3MSA in Fig. 38 proves that if condition 1. is false, then \mathcal{A} is not 3-compressible.

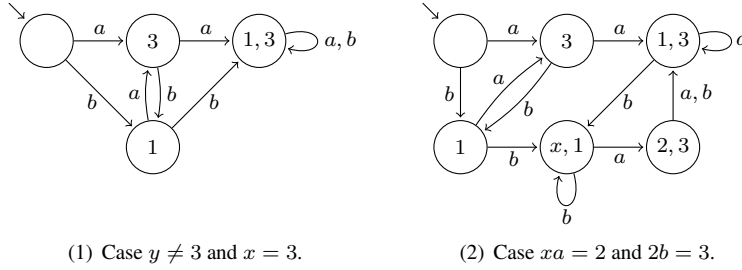

Fig. 38: 3MSA for the case in which condition 1. of Proposition 25 is false.

2. Let condition 2. be false, i.e., $b = [x, y] \setminus 2$ and $3 \notin \{x, y\}$ but either $1 \notin \{x, y\}$ or $3b \notin \{x, y\}$. From conditions 3. and 4. of Lemma 23 we have that in this cases \mathcal{A} is not proper, as it is 3-compressed either by ab^2 or by a^2b .
3. Let condition 3. be false. If $b = [x, 3] \setminus 2$ but $xa = 2$ and $1b = 3$, then the 3MSA in Fig. 39(1) proves that \mathcal{A} is not 3-compressible. Else, if $b = [3, y] \setminus 2$ but $ya = 2$ and $1b = y$, then the 3MSA in Fig. 39(2) proves \mathcal{A} is not 3-compressible.

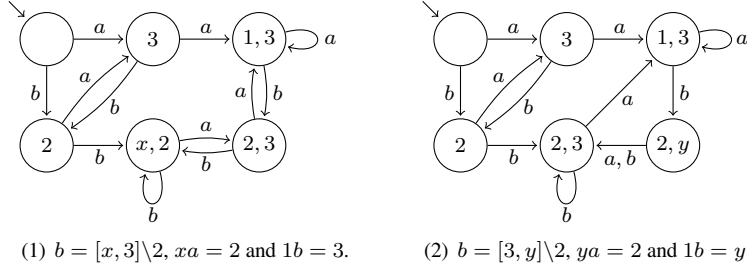

Fig. 39: 3MSA for the case in which condition 3. of Proposition 25 is false.

4. Let condition 4. be false, i.e., $b = [x, y] \setminus z$, $z \notin \{1, 2\}$, $x \in \{1, 2\}$ and $za \in \{1, 2\}$, but $y \neq 3$. We have to consider the following subcases.

- (a) Let $za = 1$, hence $z = 3$ and $zb = x$. If $x = 1$, then for all $w \in \{a, b\}^+$ with $|w| \geq 2$, we have $\mathcal{M}(w) = \{1, 3\}$, and then \mathcal{A} is not 3-compressible. If $x = 2$, then by condition 4 of Lemma 23 we have $y = 1$, and for all $w \in \{a, b\}^+$ we have $\mathcal{M}(wa) = \{1, 3\}$ and $\mathcal{M}(wb) = \{2, 3\}$ and again \mathcal{A} is not 3-compressible.
- (b) Let $za = 2$, hence $z \neq 3$. We consider two further subcases:
 - i. if $x = 1$, then $3b \neq 1$ and by condition 2. of Lemma 23 $za = y = 2$, and by condition 3. of Lemma 23 we have $3b = 2$. The 3MSA in Fig. 40(1) proves that \mathcal{A} is not 3-compressible;
 - ii. if $x = 2$, then by condition 4. of Lemma 23 we have $y = 1$ and by condition 3. of Lemma 23 we have $3b = 1$. The 3MSA in Fig. 40(2) proves that \mathcal{A} is not 3-compressible.

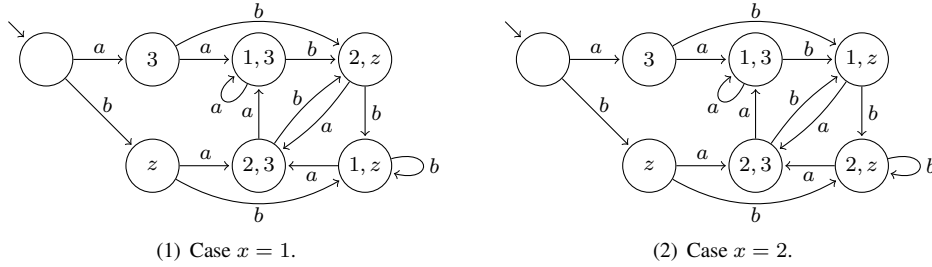

Fig. 40: 3MSA for the case in which condition 4. of Proposition 25 is false and $za = 2$.

Conversely, we find for each automaton satisfying conditions 1.-4. a (short) 3-compressing word.

1. Let $b = [x, 3] \setminus 1$ and $xa \neq 2$ or $2b \neq 3$. Observe that $xa \neq 1$, as $3a = 1$ and $x \neq 3$. The P3MSA in Fig. 41 proves that either the word b^2a^2 or b^2ab^2 3-compresses \mathcal{A} .
2. Let $b = [x, y] \setminus 2$, $3 \notin \{x, y\}$, $1 \in \{x, y\}$ and $3b \in \{x, y\}$. There are two subcases.

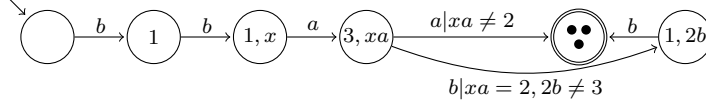

Fig. 41: P3MSA for the case $b = [x, 3] \setminus 1$ and $xa \neq 2$ or $2b \neq 3$.

- (a) Let $x = 1$, then $b = [1, y] \setminus 2$, $y \neq 3$, $3b = y$ (as $2b = 1$) and $2a \neq 1$ (as $3a = 1$). So $\mathcal{M}(b^2a) = \{2a, 3\}$ and if $2a \neq 2$, then $|\mathcal{M}(b^2a^2)| = 3$, else if $2a = 2$, then $|\mathcal{M}(b^2ab)| = 3$, so either the word b^2a^2 or b^2ab 3-compresses \mathcal{A} .
- (b) Let $y = 1$, then $b = [x, 1] \setminus 2$, $x \neq 3$, $3b = 1$ (as $2b = x$) and $2a \neq 1$ (as $3a = 1$). If $2a = 2$, then the P3MSA in Fig. 42(1) proves that the word a^2b^2 3-compresses \mathcal{A} . If $2a \neq 2$, then the P3MSA in Fig. 42(2) proves that the word a^2ba^2 3-compresses \mathcal{A} .

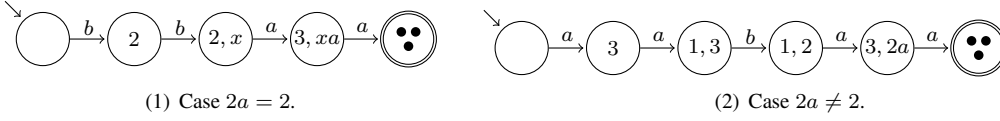

Fig. 42: P3MSA for the case $b = [x, 1] \setminus 2$, $x \neq 3$ and $3b \in \{x, 1\}$.

3. If $b = [x, 3] \setminus 2$ and $xa \neq 2$ or $1b \neq 3$, then observe that $xa \neq 1$, as $3a = 1$ and $x \neq 3$. If $xa \neq 2$, then $\mathcal{M}(b^2) = \{2, x\}$, $\mathcal{M}(b^2a) = \{3, xa\}$ and $|\mathcal{M}(b^2a^2)| = 3$. If $xa = 2$ and $1b \neq 3$, then $\mathcal{M}(a^2) = \{1, 3\}$, $\mathcal{M}(a^2b) = \{1b, 2\}$ and $|\mathcal{M}(a^2b^2)| = 3$. Then either the word b^2a^2 or a^2b^2 3-compresses \mathcal{A} . If $b = [3, y] \setminus 2$ and $ya \neq 2$ or $1b \neq y$, then observe that $ya \neq 1$, as $3a = 1$ and $y \neq 3$. The P3MSA in Fig. 43 proves that either the word a^2b^2 or a^2ba^2 3-compresses \mathcal{A} .

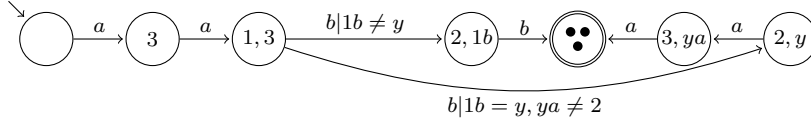

Fig. 43: P3MSA for the case $b = [3, y] \setminus 2$ and $ya \neq 2$ or $1b \neq y$.

4. Let $b = [x, 3] \setminus z$, $z \notin \{1, 2\}$, $x \in \{1, 2\}$ and $za \in \{1, 2\}$. Observe that $z \neq 3$ and $3a = 1$, so $za \neq 1$, and then it is always $za = 2$. We have to consider two subcases.
- (a) Let $x = 1$, then $b = [1, 3] \setminus z$, $zb = 1$, $3b \neq 1$ and $\mathcal{M}(a^2b) = \{z, 3b\}$. If $3b \neq 2$, then $\mathcal{M}(a^2ba) = \{za, 3ba, 3\}$ and a^2ba 3-compresses \mathcal{A} . Else, if $3b = 2$, then $\mathcal{M}(a^2b^2) = \{1, z, 2b\}$ and a^2b^2 3-compresses \mathcal{A} .
- (b) Let $x = 2$, then $b = [2, 3] \setminus z$, $3b \neq 2$ (as $zb = 2$) and $\mathcal{M}(a^2b) = \{z, 1b\}$. If $1b \neq 3$, then $\mathcal{M}(a^2b^2) = \{2, 1b^2, z\}$ and a^2b^2 3-compresses \mathcal{A} . Else, if $1b = 3$, then $\mathcal{M}(a^2ba) = \{1, 3, za\}$ and a^2ba 3-compresses \mathcal{A} .

□

5 Finding lower and upper bounds for $c(3, 2)$

Collecting the words arising from the previous propositions, and taking into account that the roles of letters a and b are interchangeable, then each 3-full word, containing as factors the words in the set W :

$$W = \{ab^2ab^2a, ab^2a^2b^2a, abab^2aba, ab^3aba, abab^3a, ab^3ab^3a, ba^2baba^2b, a^2b^3a, ba^2ba^2b, ba^2b^2a^2b, baba^2bab, ba^3bab, baba^3b, ba^3ba^3b, ab^2abab^2a, b^2a^3b, a^2b^3a^2, b^2a^3b^2\}$$

is a 3-collapsing word on a two-letter alphabet. Remark that a^2b^3a and b^2a^3b are factors of $a^2b^3a^2$ and $b^2a^3b^2$ respectively, the reason for which they occur in W will be clear in the sequel.

Then, in order to construct a short 3-collapsing word, we find a word having as factor all the words above, *i.e.*, we solve the Shortest Common Supersequence problem (SCS) for W . It is well-known that SCS is NP-complete (Raiha and Ukkonen (1981)) even on a two-letter alphabet, thus approximation algorithms are often used. Nevertheless, the cost of finding a good approximation is comparable to the cost of finding an optimal solution (Karpinski and Schmieid (2013)) and, on the other hand, efficient algorithms give poor approximation (Turner (1989)).

So, as no near-optimal solutions can be found in reasonable time, we decided to code the problem in the bounded satisfiability problem for a set of linear-time temporal logic (LTL) formulae, and to solve it with the tool described in Bersani et al. (2014). More precisely, let S be a propositional letter, a word w of length n is coded in the LTL formula \mathbf{w} that is satisfied if and only if for all $1 \leq i \leq n$ the i -th letter of w is “a” if and only if at the i -th time instant S is true. E.g., the word aba is encoded in the formula $S \wedge (\mathbf{X}(\neg S \wedge \mathbf{X}(S)))$, where \mathbf{X} is the “next” operator. Then we look for the shortest model that satisfy the formula $\bigwedge_{w \in W} \mathbf{w}$: such model encodes the shortest word having as factor all the words in W and has length 55.

However, we were well aware that such “greedy approach”, *i.e.*, to find an optimal solution for each subcase and combining them to obtain a global one, is not suitable in order to achieve a global optimum.

We observed that the words $a^2b^3a^2$ and $b^2a^3b^2$ are needed only to solve a special subcase of $(3, 4)$ -automata, so we tried to replace them with a longer factor in order to obtain a shorter 3-collapsing word.

Actually, the shortest word having as a factor the words in $W \setminus \{a^2b^3a^2, b^2a^3b^2\}$ is

$$w_3 = b^2a^3b \underbrace{a^3b^3aba^2}_v baba^2ba^2b^2a^2b^2ab^2aba \underbrace{b^2aba^3bab^3}_u ab^3a$$

which has as a factor the word $u = b^2aba^3bab^2$ and $v = a^2b^3aba^2$. As u belongs to the language \mathcal{L} defined in Proposition 22, case 2.b.iii, and v belongs to the dual of \mathcal{L} , this proves that w_3 is a 3-collapsing word of length 53.

It is known that in general the language $\mathcal{C}_{k,t}$ of k -collapsing words on an alphabet of t letters differs from the language $\mathcal{S}_{k,t}$ of k -synchronizing words on the same alphabet. However, this not excludes that in some cases $c(k, t)$ and $s(k, t)$, respectively the length of the shortest k -collapsing and k -synchronizing word on an alphabet of t letters, can be equal. Up to now it was only known that $c(2, 2) = s(2, 2)$ (Sauer and Stone (1991)) and that $c(2, 3) \neq s(2, 3)$ (Ananichev and Petrov (2003)). We find a counterexample proving that $c(3, 2) \neq s(3, 2)$ (and so $c(3, 2) \geq 34$). In fact, the semiautomaton in Fig. 44(2) is 3-compressible (and also 3-synchronizing), but the word $s_{3,2}$ do not compresses it. On the other hand, its dual $\bar{s}_{3,2}$ synchronizes it.

We believed that any 3-compressible 5-states automaton on a two-letter alphabet were 3-compressed either by $s_{3,2}$ or by $\bar{s}_{3,2}$, but an Anonymous reviewer observed that this is not the case: the semiautomaton in Fig. 44 is 3-synchronizable but it is not 3-compressed neither by $s_{3,2}$ nor by $\bar{s}_{3,2}$.

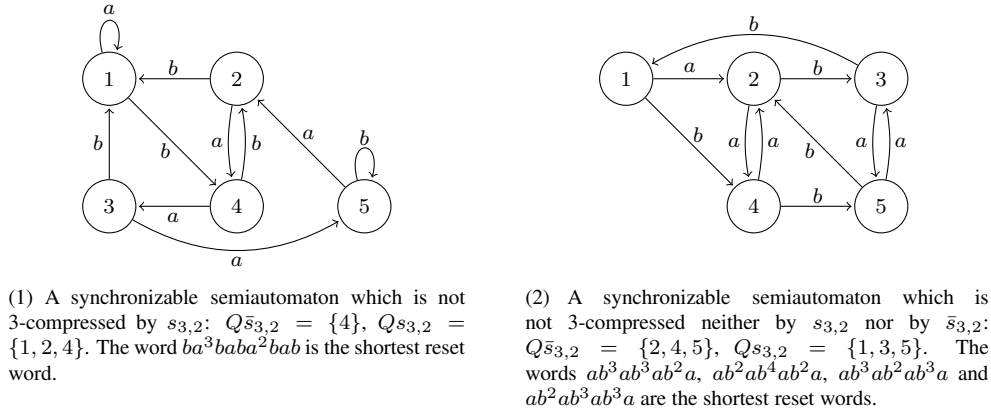

Fig. 44: Synchronizable automaton with long reset words.

6 Conclusion

Although very technical, our analysis can be effectively exploited in order to obtain more general results and to investigate some conjectures. In Cherubini and Kisielewicz (2014, 2016), the authors exploit the characterization of $(\mathbf{3}, \mathbf{p})$ -automata (Proposition 10) to prove that the problem of recognizing whether a binary word is 3-collapsing is co-NP-complete.

Moreover, the word w_3 can be used to improve the procedure arising from Margolis et al. (2004) (Theorem 3.5) to obtain shorter k -collapsing words for $k \geq 4$. In particular, it follows that $c(4, 2) \leq 1741$ and $c(5, 2) \leq 109941$. Though very lengthy, they can be effectively used in testing the compressibility of an automaton. In particular, this can accelerate the algorithm presented in Ananichev and Petrov (2003); Petrov (2008) to find short (possibly shortest) 4- and 5-synchronizing words.

Acknowledgements

We sincerely thank the anonymous reviewers for valuable comments and their careful reading of our paper, which were of great help in revising the manuscript.

References

- D. S. Ananichev and I. V. Petrov. Quest for short synchronizing words and short collapsing words. In *WORDS. Proc. 4th Int. Conf.*, pages 411–418, 2003.
- D. S. Ananichev, I. V. Petrov, and M. V. Volkov. Collapsing words: A progress report. In *Developments in Language Theory*, volume 3572 of *LNCS*, pages 11–21, 2005.
- M. Bersani, A. Frigeri, A. Morzenti, M. Pradella, M. Rossi, and P. San Pietro. Constraint LTL satisfiability checking without automata. *Journal of Applied Logic*, 12(4):522 – 557, 2014.
- A. Cherubini. Synchronizing and collapsing words. *Milan J. Math.*, 75:305–321, 2007.

- A. Cherubini and A. Kisielewicz. Binary 3-compressible automata. In *Proceedings of the 15th Italian Conference on Theoretical Computer Science (ICTCS 2014)*, volume 1231 of *CEUR Workshop Proceedings*, pages 109–120, 2014.
- A. Cherubini and A. Kisielewicz. Recognizing 3-collapsing words over a binary alphabet. *Theor. Comput. Sci.*, 629(C):64–79, 2016.
- A. Cherubini, A. Kisielewicz, and B. Piochi. A bound for the length of shortest 2 collapsing words. *DMTCS*, 11(1):33–44, 2009.
- A. Cherubini, A. Frigeri, and B. Piochi. Short 3-collapsing words over a 2-letter alphabet. In *Developments in Language Theory. DLT 2011*, volume 6795 of *LNCS*, pages 469–471, 2011.
- M. Karpinski and R. Schmied. Improved inapproximability results for the shortest superstring and related problems. In *19th Computing: The Australasian Theory Symposium (CATS 2013)*, Adelaide, Australia, volume 141 of *CRPIT*, pages 27–36, 2013.
- R. Kudlacik, A. Roman, and H. Wagner. Effective synchronizing algorithms. *Expert Syst. App.*, 39(14):11746–11757, 2012.
- S. W. Margolis, J.-E. Pin, and M. V. Volkov. Words guaranteeing minimum image. *Internat. J. Foundations Comp. Sci.*, 15:259–276, 2004.
- I. Petrov. An algorithm for recognition of n -collapsing words. *Theoret. Comput. Sci.*, 391(1-2):99–108, 2008.
- R. Pöschel, M. V. Sapir, N. W. Sauer, M. G. Stone, and M. V. Volkov. Identities in full transformation semigroups. *Algebra Universalis*, 31:580–588, 1994.
- E. V. Pribavkina. On some properties of the language of 2-collapsing words. In *Developments in Language Theory*, volume 3572 of *LNCS*, pages 374–384, 2005.
- K. Raiha and E. Ukkonen. The shortest common supersequence problem over binary alphabet in NP-complete. *Theoretical Computer Science*, 16:187–198, 1981.
- N. Sauer and M. G. Stone. Composing functions to reduce image size. *Ars Combinatoria*, 1:171–176, 1991.
- A. N. Trahtman. An efficient algorithm finds noticeable trends and examples concerning the Černý conjecture. In *Proceedings of MFCS*, volume 4162 of *LNCS*, pages 789–800, 2006.
- J. Turner. Approximation algorithms for the shortest common superstring problem. *Information and Computation*, 83:1–20, 1989.
- M. V. Volkov. Synchronizing automata and the Černý conjecture. In *Language and Automata Theory and Applications*, volume 5196 of *LNCS*, pages 11–27, 2008.