

S. Defoort, M. Balesdent, P. Klotz,  
P. Schmollgruber, J. Morio, J. Hermetz,  
C. Blondeau, G. Carrier, N. Bérend  
(Onera)

E-mail: sebastien.defoort@onera.fr

# Multidisciplinary Aerospace System Design: Principles, Issues and Onera Experience

With the increasing complexity of aerospace systems, it has become more and more necessary to adopt a global, integrated approach from the very early steps and throughout the design process. Tightly coupling aerodynamics, propulsion, structure, trajectory, guidance and navigation, while also taking into account environmental and societal constraints, as well as manufacturability, reliability and maintainability, is a huge challenge. The field of Multidisciplinary Design Optimization (MDO) provides some answers on how to integrate increasing knowledge into the design process, while reducing the design cycles. It consists in a core of key methodologies, such as multi-disciplinary problem formulation and decomposition, optimization under uncertainties and surrogate based high-fidelity tool integration, which are validated and enriched through confrontation with various kinds of design studies. The aim of this paper is, on the one hand, to give a clear view of the challenges at stake and the key difficulties that must be overcome and, on the other hand, to focus on some significant studies and achievements at Onera over the past decade, either on tools and methods, or on dedicated applications, illustrating the progress made and the challenges to come.

## MDO approach in an aerospace context and methodological challenges

### Context

In a context of technological breakthrough and increasing complexity, with technologies interacting together in a way that prevents each of them from being handled separately, there is a wide field of development for multidisciplinary design methods and tools. Additionally, there are increasing constraints that must be taken into account when defining new aerospace vehicles, from operational requirements and regulation compliance to public acceptance and environmental performance.

In every scientific domain addressed, such as for example aerodynamics, structural mechanics or aeroacoustics, improvements can only be obtained by accurately handling complex phenomena, which requires, on the one hand, high-fidelity and efficient modeling and, on the other hand, large computational resources. This is mandatory to enable detailed exploration of the design space and significant performance improvements.

In addition to these disciplinary-centered requirements, the tight coupling of several phenomena interacting together makes it a huge

challenge to find a global optimum for the entire system, which can be very far from a collection of single-discipline optimizations. The search for this optimal performance stresses the need to adopt an integrated design and optimization approach, allowing sufficient knowledge to be included in the performance analysis. Traditional design processes – where disciplinary knowledge is only handled by the dedicated expert or team – must hence be merged into a global approach, with corresponding methods and tools. This also requires the multi-fidelity problem to be handled, which means keeping the system consistency, using low-fidelity approaches and refining some key performances, by including high fidelity processes adequately coupled to the system analysis.

### Multidisciplinary Design Optimization: in brief

*Multidisciplinary Design Optimization* (MDO), also known as *Multidisciplinary Optimization*, is a relatively recent field of engineering sciences whose objective is to address design problems more efficiently by incorporating various disciplines. The MDO has been used in a great number of domains, such as structure, automotive, electronics or aerospace engineering and allows complex problems, which are difficult to handle with the classical design methods, to be solved. MDO approaches have emerged between 1970 and 1990, with

the increase of computer-aided tools and a need to take into account manufacturability, reliability, maintainability and also the worldwide spreading of the main aeronautics companies. Indeed, this increase has made the numerical optimization of complex problems possible and has paved the way for complete system design.

By handling the various disciplines simultaneously, MDO techniques facilitate the search for a global optimal design, which may not be obtained when the disciplines are handled sequentially. Indeed, in most design problems, the various disciplines may lead to antagonistic decisions (*e.g.* structure and aerodynamics in launch vehicle design, as we shall see later). In such cases, MDO techniques are aimed at finding compromises between the different disciplines, in order to achieve a global optimal design.

Handling a series of disciplines at the same time significantly increases the complexity of the problem to solve. One of the branches of the MDO field is dedicated to making new formulations of the optimization problem, aimed at reducing the complexity of the problem and at allowing the more efficient use of traditional optimization methods. Many MDO methods have been developed and can be found in literature [2][3][8][65][70].

Instead of disciplinary codes in a computer, or computer networks, MDO may also address design problems involving engineer teams all over the world. Indeed, due to the globalization of the industries, system design can be distributed among various research centers located in different countries. In this case, the data exchanges between the teams become a crucial point in the design process and MDO provides new tools for the designers, in order to make the design process more efficient.

### Onera positioning

US universities and government agencies have played a large role in the development of these methodologies, especially with the work on decomposition methods of Dr. Sobieski from NASA Langley, who is also founding chairman of the AIAA technical committee on MDO [26]. In Europe, several initiatives have been conducted by research agencies and universities and now tend to be integrated into a lot of FP7 projects. On both sides of the Atlantic, the work is concentrating on the development of integrated MDO capabilities, such as ANR-OMD, OMD2 or the System@tic CSDL projects in France. Taking into account this need for design methodology improvement, Onera has been making an important internal effort to develop tools and techniques that will help to build efficient design processes and optimization capabilities. The core of this methodological effort is a 4-year internal project called DOOM (Multidisciplinary Optimization Tool Approach), conducted between 2004 and 2008, and extended by several applicative studies in the field of civil aircraft, Unmanned Air Vehicles (UAV), launch vehicles and missiles. This important development, together with its central position in the French aerospace context, has made it possible to build a strong competency which is still continuously under improvement.

### Vehicle design studies: how can complexity be mastered?

#### A large span of applications

As the French aerospace center for applied research, Onera has an

assigned mission ranging from developing disciplinary skills in key fields, such as aerodynamics, propulsion or structure, to overall integration into a coherent system design. For the latter, the challenges are to master the complexity of multi-physics and high technology systems and to generate innovative concepts beyond well-known solutions, with a methodological approach being sufficiently generic to be applied to very different domains. In fact, Onera covers the complete field of aerospace systems, from civil aircraft to orbital vehicles. This paper is focused on air vehicle design. These design studies can be related to civil aircraft (integration of new propulsion technologies and new concepts such as flying wings), UAVs (from flapping wing micro-air-vehicles to large size HALE UAVs), conventional and air-breathing missiles (mid-life evolutions of an existing system, new high speed concepts), launchers and orbital systems (classical ground launched systems and innovative air-launch concepts).



Figure 1 – Examples of vehicle designs in various fields

These design studies also differ by the needs of the customers: they can be either technology-oriented (assessment of the system impact of a new technology for a subsystem manufacturer), driven by industrialization constraints (co-design with industrial actors), require performance sensitivity to changes in the constraints (expertise for MoD or civil authorities) or be aimed at creating fully new vehicle concepts (internal prospective studies).

### Typology of studies

To illustrate the differences between these system studies and to better characterize the need for adequate design methodology, they can be classified along 2 axes:

- The level of modeling fidelity that is required by the study (horizontal axis): number of design variables, disciplines involved, fidelity of the models (from analytic to high-fidelity Computational Fluid Dynamics, or Finite Element Methods);
- The “unconventionality” or originality of the design with respect to well-known solutions (vertical axis): new exploration topologies, unusual flight domain (low Reynolds number, high Mach number, *etc.*).

Four families of design studies can be roughly identified:

1. Conceptual design of well-known systems (*e.g.* missile quick sizing loops);
2. Exploration of innovative configurations at a conceptual design level (*e.g.* flying wing, Orbital Transfer Vehicles);
3. Preliminary design of well-known systems (*e.g.* technology integration on a civil aircraft);
4. New types of vehicles with insufficiently known physics (*e.g.* scramjet missiles, flapping wing UAVs).

Moving upwards and towards the right on the diagram, the complexity of the processes involved increases. More design variables, higher fidelity of modeling and greater exploration needs require the definition of more and more integrated processes with advanced MDO techniques. Furthermore, for a same vehicle, MDO can be applied at different levels of the design process and with different degrees of complexity (coupling identification, design problem formulation, uncertainty handling, optimal use of surrogate models, *etc.*).

## General MDO approach

In this section, we describe the different steps of a generic MDO approach, in order to handle a design problem.

### Design process set up

The first challenge for advanced MDO is to deal with the multidisciplinary aspect of vehicle design. Before talking about design

space exploration and optimization, the first obstacle to overcome is the analysis problem, which means the identification of disciplinary couplings and the computation of objectives and constraints as a function of the design variables. However, what is quite obvious in the case of mono-discipline, or even bi-discipline optimization, becomes really challenging when dealing with a process involving at least 4 or 5 disciplines, with multiple solutions.

The aim is to build a design process that is compliant with certain requirements: robustness of the response, computation time of the process, dimension of the design space, or the constraints to be fulfilled. From a methodological point of view, how to coherently choose the following must be found out:

- The objective function(s) to simultaneously or independently optimize: cost, mass, performance, payload, range of action, *etc.*;
- The design variables: accuracy of the geometric representation, discrete choices such as materials and equipment, macroscopic versus local representation, *etc.*;
- The coupling variables: variables that are used to link the various disciplines;
- The disciplinary analysis: number of phenomena to be included, level of assessment, inputs and outputs, *etc.*;
- The overall dependencies between disciplines and data exchanges: sequence of computations, local couplings, degree of freedom in the design, *etc.*

This requires knowledge about both the application at stake and the optimization techniques that will be used. This is why a mix between empirical and formal approaches must be used.

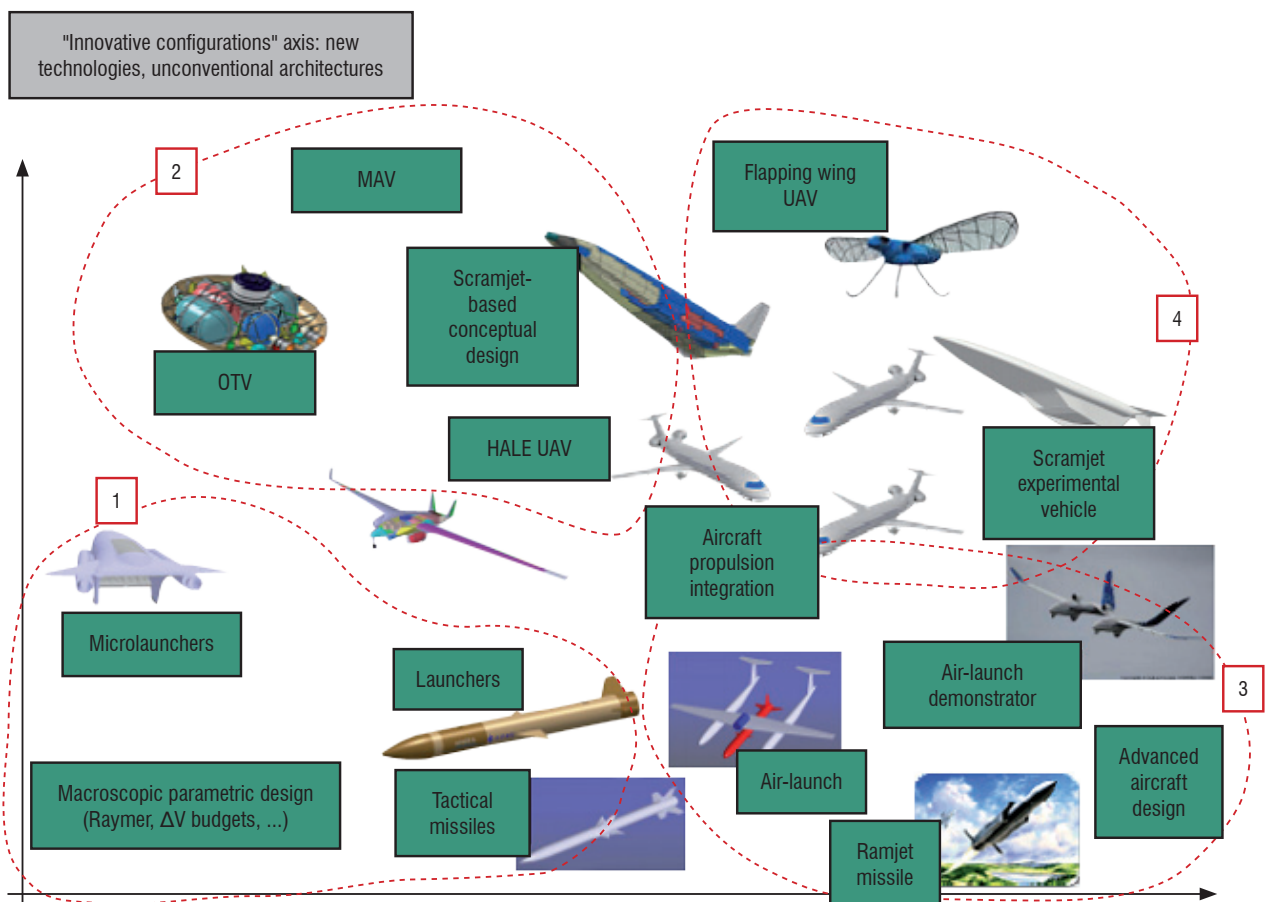

Figure 2 – Typology of design studies

## Generic formulation of a MDO problem and classical MDO methods

Once the various previous choices have been made, incorporating the largest amount of knowledge possible to evaluate the design objectives and constraints, the next step is to formulate the problem, in order to be able to use suitable optimization algorithms.

The general formulation of an MDO problem can be written as follows:

$$\begin{aligned} &\text{Minimize} && f(x, y, z) \\ &\text{With respect to} && z \\ &&& g(x, y, z) \leq 0 \end{aligned} \quad (1)$$

$$h(x, y, z) = 0 \quad (2)$$

$$\text{Subject to} \quad \forall i \in \{1, \dots, n\}, \forall j \neq i, y_i = \{c_{ji}(x_j, y_j, z_j)\}_j \quad (3)$$

$$\forall i \in \{1, \dots, n\}, R_i(x_i, y_i, z_i) = 0 \quad (4)$$

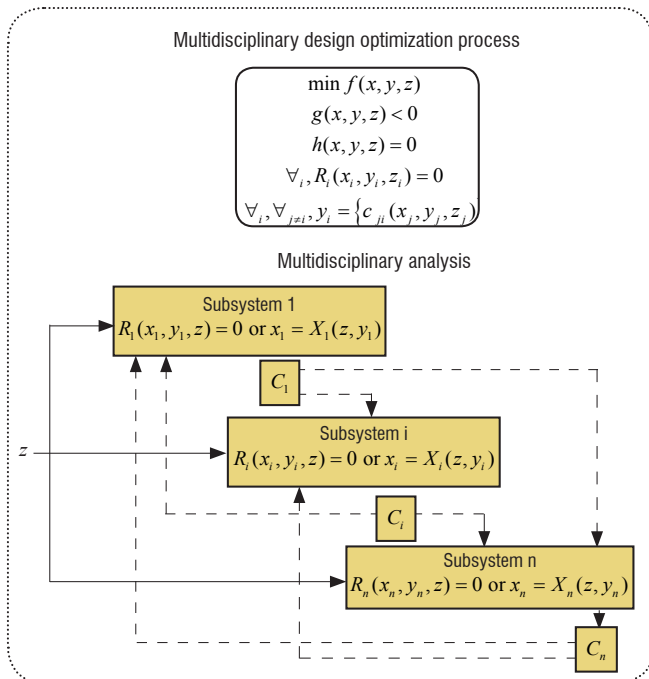

Figure 3 – General MDO process

A general MDO process is illustrated in Figure 3. This process involves several types of variables. These variables play specific roles and are regrouped into three categories:

- $z$ : design variables. These variables change all along the optimization process, in order to find the optimal design. They can be used in one or several subsystems;

- $y$ : coupling variables. These variables are used to link the different subsystems and to evaluate the consistency of the design with regard to the couplings  $c$  (equations 3);

- $x$ : state (or disciplinary) variables. These variables can vary during the disciplinary analysis, in order to find equilibrium in the state equations (Disciplinary Equations 4). Unlike  $z$ , the state variables are not independent degrees of freedom, but rather depend on the design variables  $z$ , the coupling variables  $y$  and the state equations. The cases in which  $x$  are given by explicit functions of  $z$  and  $y$  are uncommon in engineering applications. The  $x$  variables are most often defined by implicit functions, which generally require specific optimization methods for solving complex industrial problems.

The disciplinary equations can be handled in different ways, using disciplinary analyzers (*i.e.* the subsystems are in charge of solving the equations 4 by the subsystems), disciplinary evaluators (*i.e.* the subsystems just compute the values of the residuals  $R$  in the equations 4) or a Multidisciplinary Analysis (*i.e.* the subsystem level is responsible for solving the coupling equations 3 and the residuals 4).

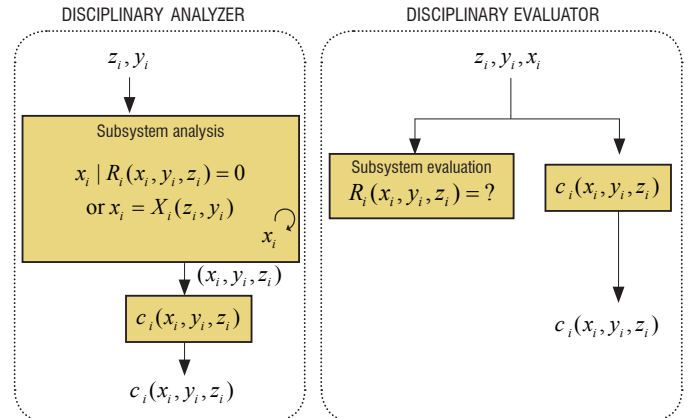

Figure 4 – Disciplinary analysis and evaluation

Many MDO methods are proposed in literature. The main methods can be grouped into two categories with respect to the use of one optimization level (MultiDiscipline Feasible MDF, Individual Discipline Feasible IDF, All At Once AAO [8], *etc.*) or multiple optimization levels (Collaborative Optimization CO [14], Bi-Level Integrated System Synthesis BLISS [63], Concurrent Sub-Space Optimization CSSO [66], Analytical Target Cascading ATC [46], *etc.*). [5] [65] can be consulted for more details regarding MDO formulations in aerospace design. The choice of the appropriate formulations depends on various characteristics of the problem to be solved, such as the search space dimension, the number of couplings, the disciplinary objectives, the availability of analytical sensitivity calculations, *etc.* Some papers (*e.g.* [69]) propose benchmark studies of the main MDO formulations in several test cases, in order to help the designer to choose which MDO formulation is the most appropriate for his problem.

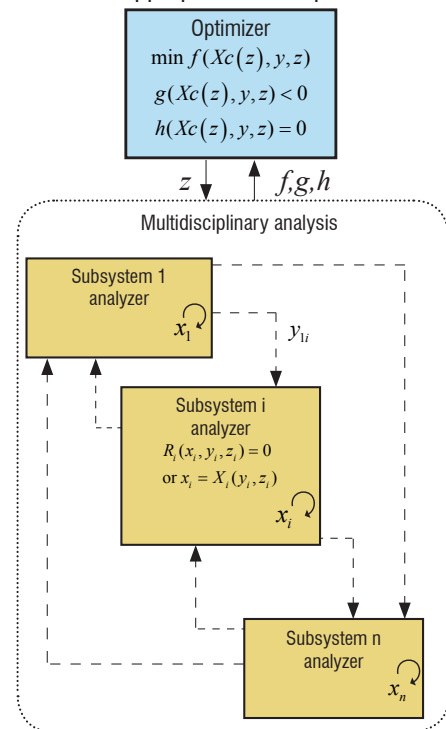

Figure 5 – MDF

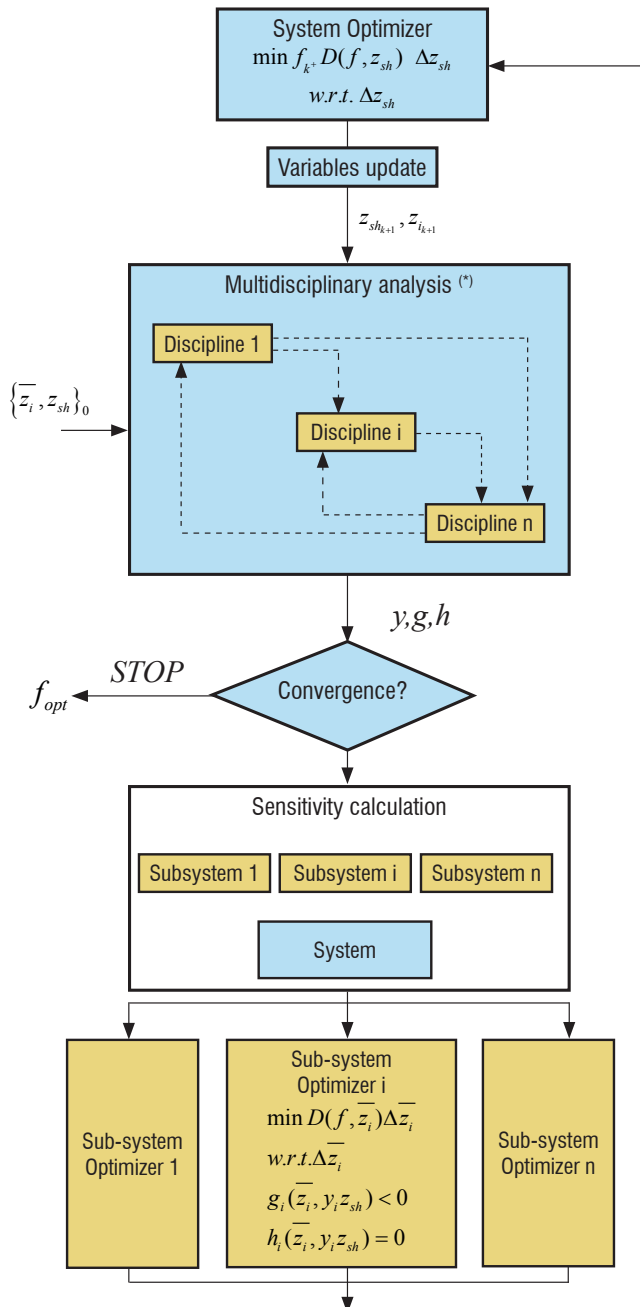

Figure 6 – BLISS  
 (\*)MDA is optional and allows to have a consistent starting point

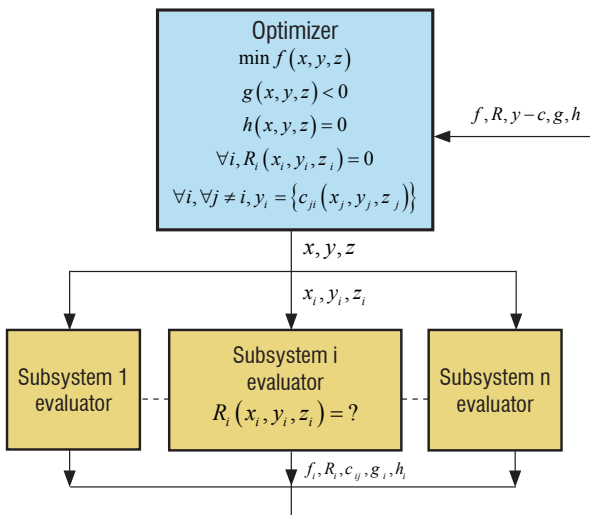

Figure 7 – AAO

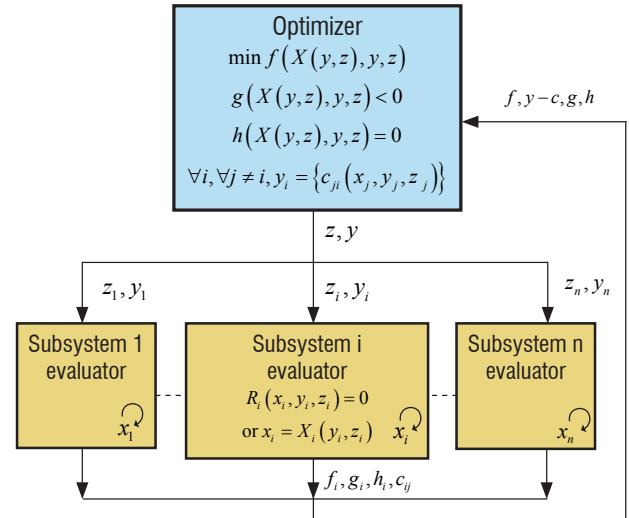

Figure 8 – IDF

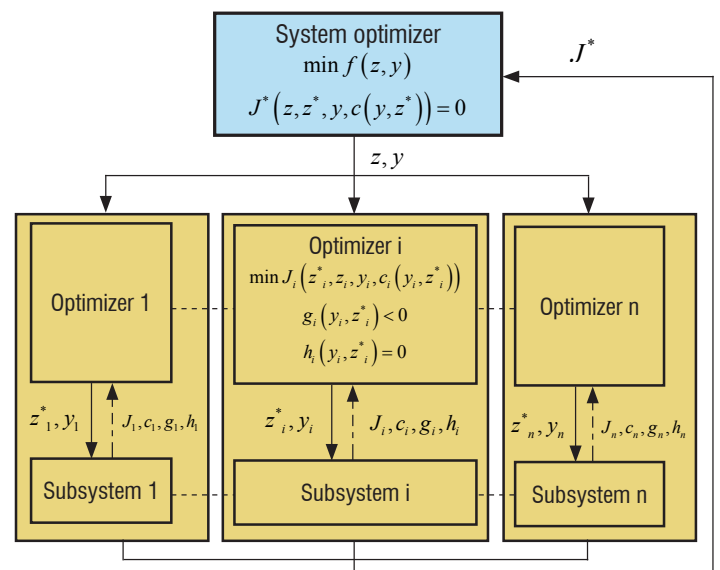

Figure 9 – CO

Some of these formulations have been compared, on a simplified Supersonic Business Jet aircraft design test case, in the frame of a PhD thesis at Onera [18]. These formulations have been compared in terms of convergence robustness, number of disciplinary calls and practical implementation difficulties. The analysis has shown that there is no preferred or universal approach for all types of problems, but a lot of knowledge could be accumulated to drive the choice for a new problem, depending on the requirements (discipline or interdisciplinary feasibility at each stage of the optimization process, convergence consistency requirements, natural structure of the MDA – mono or bi-level, possible use of global sensitivity equations, compromise between CPU time and accuracy, etc.). These formulations were also analyzed in the framework of a PhD thesis on launcher MDO (see the next section), for which new approaches were proposed.

Examples of application of some of the MDO methods described above (e.g. BLISS, CO and MDF) will be exposed in the next section. There are 2 extremes that should be avoided when performing the multi-disciplinary optimization:

- Optimizing the entire system by considering the Multidisciplinary Design Analysis (MDA) as a black box (which is known as the MDF formulation) is the most natural approach, but can be very costly if the

MDA convergence is difficult to obtain, especially when gradients need to be computed. No disciplinary expertise is included in that process;

- Optimizing the different disciplines separately and linking the disciplinary optimizations (Figure 10) is often the case in an industrial context, but disciplinary specialists tend to strive towards the improvement of objectives and fulfillment of constraints in terms of variables in their own discipline. This generates side effects that other disciplines must absorb, usually to the detriment of the overall system performance.

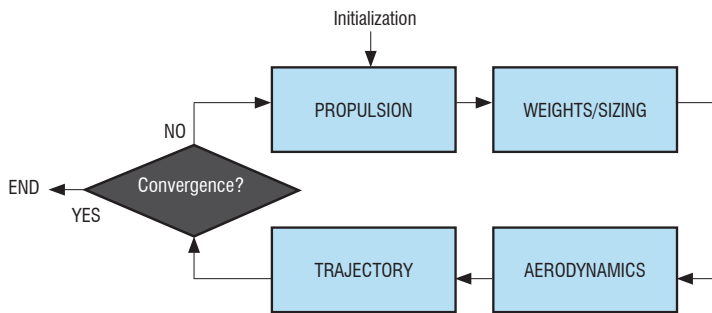

Figure 10 – Traditional design process

After having determined the most appropriate MDO formulation for the design problem, the suitable optimization algorithms for the problem must be selected. This is the subject of the following section.

### Choice of the optimization algorithms

Basically, the optimization algorithms can be divided into two categories, with respect to whether or not they require sensitivity calculations. Since the presentation of the optimization algorithms is not the focus of the current paper, we only give a short description of these two categories.

The gradient-based methods are the most classical optimization algorithms. Basically, these algorithms consist in differentiating the objective function and the constraints, in order to adjust the variables. Complete descriptions of these algorithms can be found in [21][50]. A commonly used gradient-based algorithm is the Sequential Quadratic Programming (SQP) algorithm. For more details about this algorithm, [13] [27] [50] can be consulted.

Gradient-free algorithms may present some interest in the MDO field, because the engineering (industrial) simulation codes may not have been designed to provide the sensitivity information in an efficient manner. Moreover, these algorithms allow non-differentiable and non-convex functions (and constraints) to be worked with, whereas the classical gradient-based algorithms require some differentiability and smoothness properties of the objective and the constraints. We can find many gradient-free algorithms in literature. The most popular algorithms are the Genetic Algorithm [28] [34], the Nelder & Mead algorithm [49], Simulated Annealing [38], *etc.* Several algorithms, such as Efficient Global Optimization [36], CMA-ES [31], may present some interest in terms of calculation time reduction and optimization efficiency in the search for the global optimum.

### Integration of high fidelity tools: surrogate models

MDO formulations can provide better accounting for the interactions between disciplines. However, they also introduce the need, on the one hand, to automate the execution of each disciplinary code and, on the other hand, to have low computational cost models in the loop, which is in contradiction with introducing more knowledge at early steps of the design process. The challenge is then the smart use of the most advanced modeling tools, using response surface modeling to lower the computational cost [23] [73].

## Box 1 - Typology of Multi-Disciplinary Analyses

When using an integrated Multidisciplinary Analysis, some key questions must be addressed, *e.g.*, how objectives and constraints must be computed, given a set of design variables and how must the couplings be handled? The answers to these questions are not unique and may have different consequences on the design process performance (time to converge, accuracy, degrees of freedom) depending on the coupling choices that are made (iteration loops, introduction of design rules at a disciplinary level, local variables calculated internally by the disciplines models, *etc.*). 3 typical processes are put forward:

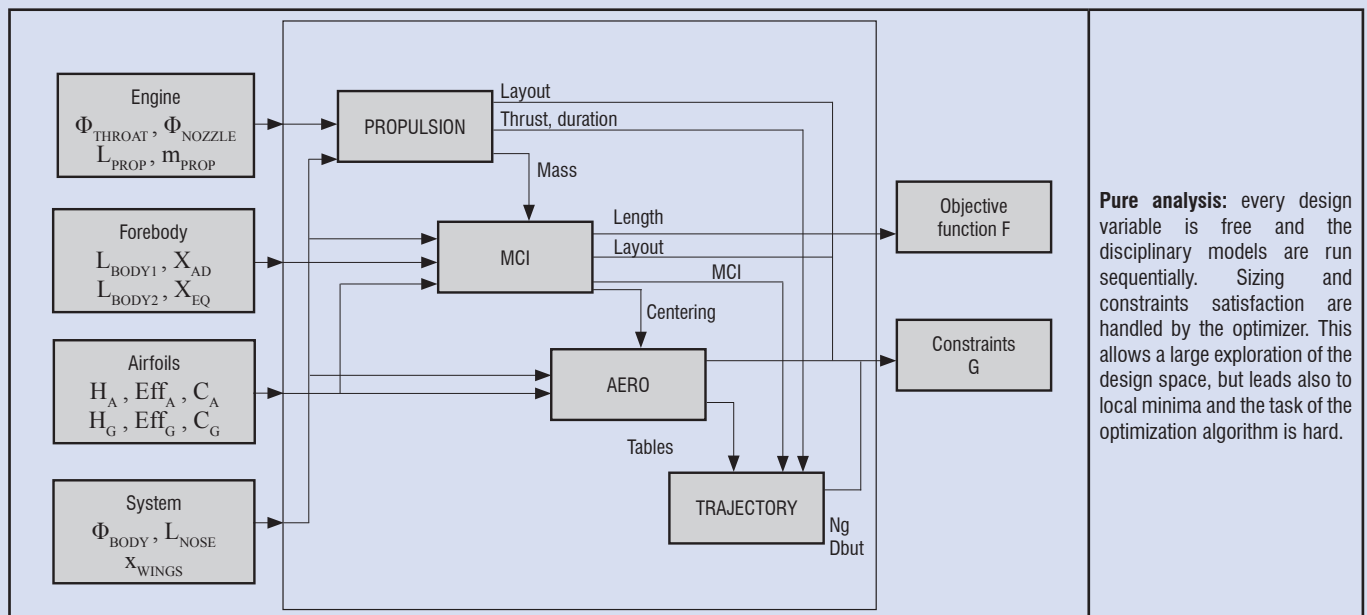

**Pure analysis:** every design variable is free and the disciplinary models are run sequentially. Sizing and constraints satisfaction are handled by the optimizer. This allows a large exploration of the design space, but leads also to local minima and the task of the optimization algorithm is hard.

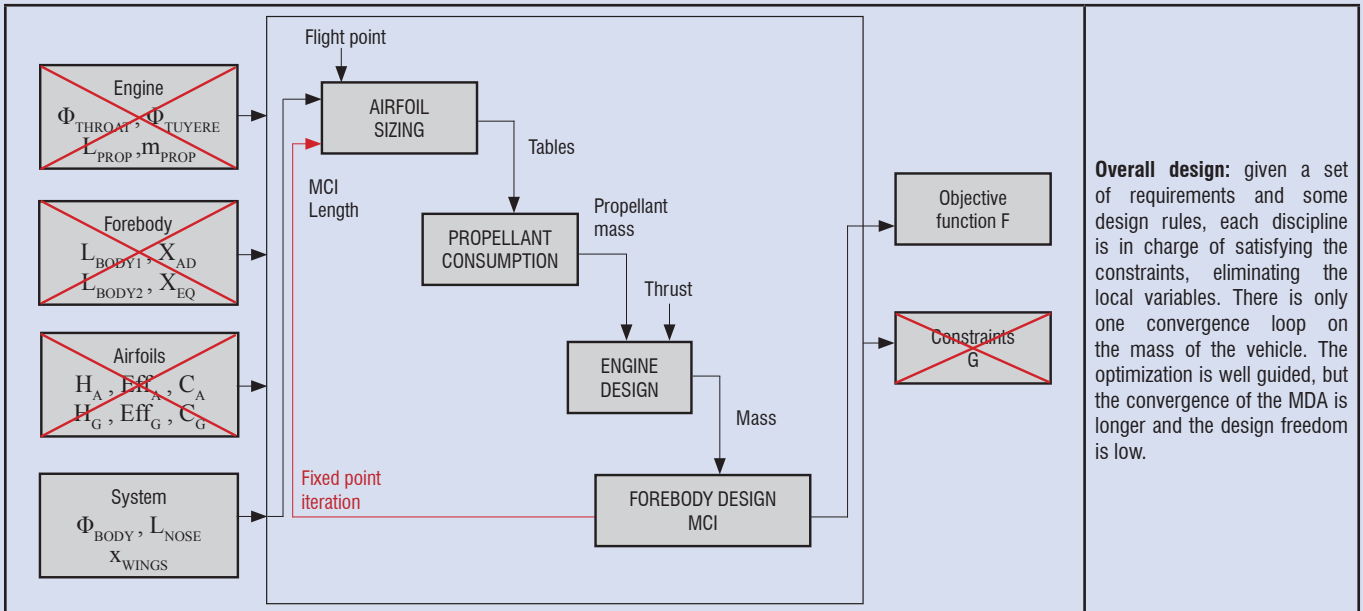
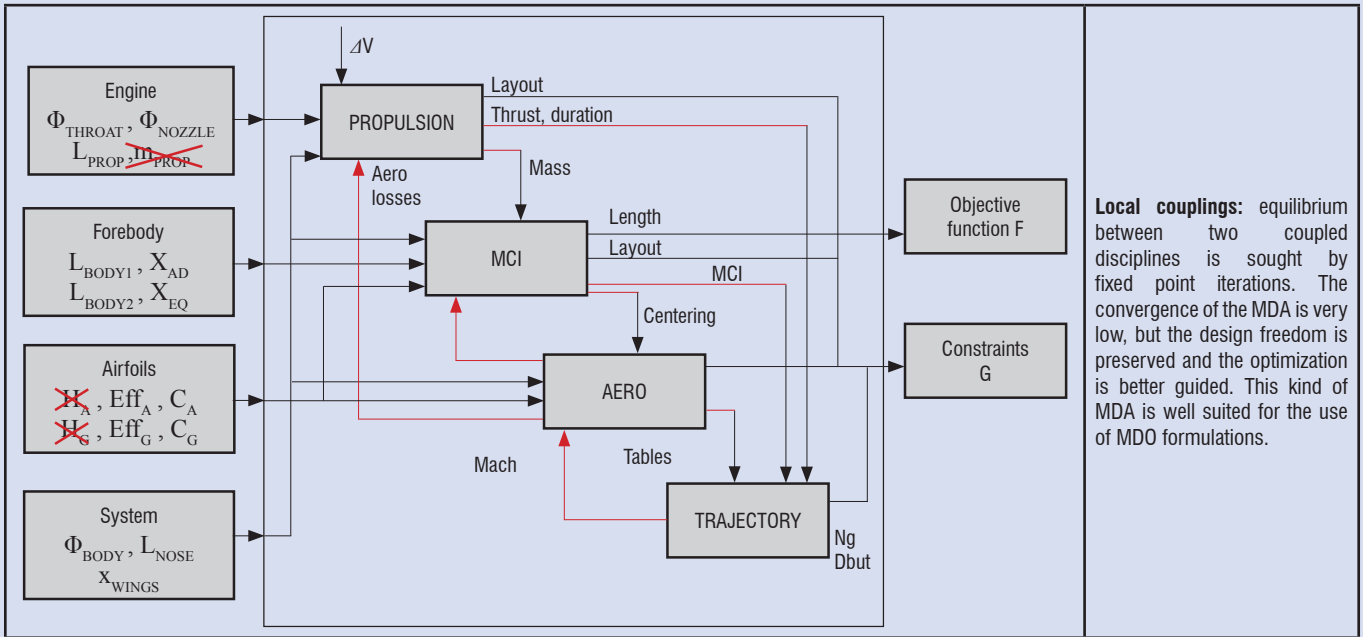

## Reduced model

MDO is most often a time consuming process, whose cost increases with the number of design variables and the duration of the disciplinary evaluations. A common way to reduce this computational cost consists in substituting these high fidelity models by reduced models. These approaches could be classified by their method of construction. The reduced-order models (ROM) are based on the physical equations and complexity reduction is provided by simplifying assumptions, projection on a reduced basis [44], or substitution by a behavioral model. As long as they are sufficiently accurate, these models must be used preferably. Otherwise, when these models are not available or any more representative, the metamodels (also called surrogate models, regression model, or response surface models), exclusively based on some changes of the reference model, become an interesting alternative.

The polynomial regression [61] metamodeling techniques have benefited from the development of response surface methodologies [48] and more recently from the design and analysis of computer experiments with the Kriging statistical model [57]. Moreover, artificial neural networks [61], radial basis functions [35], splines [24], or support vector machines [24] from statistical learning have proved their efficiency in regression. All of these models could be classified by their degrees of liberty, the type of their basis functions and the learning technique. Consequently, their areas of application are not the same and their performances can be evaluated depending on these criteria:

- Implementation: the complexity of program implementation, method robustness and speed execution;
- Respect of physical problem specificities: bounds, strongly nonlinear behavior, symmetries;
- Quality of prediction: accuracy, consistency relating to size of design of experiments.

## Metamodel construction

The construction of a metamodel requires three steps: selection, identification and validation.

- The selection step is aimed at selecting the set of simulation points and the most appropriate metamodeling technique. Since defining a representative experiment design is difficult for high dimensional systems, the reduction of the problem dimension should be studied. This can be done by selecting only the most influent parameters through a sensitivity analysis. The sampling of simulation points is crucial for the prediction quality of the metamodel and the robustness of its construction. For computer experiments, the design must be “space filling”, that is, the simulation points must be evenly and adequately spread over the design of interest [39] to provide information from the complete design space. Depending on the final dimension and knowledge of the problem, adapted suitable metamodeling technique is chosen;

- Once the surrogate model is selected, its coefficients are the solution of a least square minimization problem whose complexity depends on the number of coefficients to be adjusted. This model fitting [61] uses samples reserved for the statistical learning, while another set is dedicated to validation tests and is in relation with the bias-variance trade-off, the result of the model parameter tuning compromise between learning and generalization samples;

- Finally, the evaluation of model prediction quality, evaluated by means of the model generalization error on the validation samples, allows the model to be validated or not. Statistical techniques, such as leave-one-out, cross validation or bootstrap, provide an estimation of this error.

The choice of the metamodel most suited to the problem can be made by having knowledge regarding the physical problem: input and output dimensions, behavior, number and location of samples and by fulfilling criteria, such as expected prediction accuracy or robustness of the construction. However, there is not always a cheap surrogate model able to satisfy all of these features. That is why many works dealing with the metamodeling technique, devoted to a specific problem, are under development. Since the best metamodel is the one that takes into account all of the available information of the reference problem, new approaches strive to integrate additional data, or a basis decomposition, linked with the problem in the metamodel construction.

## Metamodeling for complex systems

A first example of methodology is the adaptive design of experiments, appropriate for expensive evaluations of the reference problem. The method consists in selecting new samples and updating the metamodel. The process is iterated until the desired error of the model is reached. These simulation points are chosen for their capacity to decrease the model uncertainty and result from an analytical expression of the model error, or statistical techniques like bootstrap [25]. Unfortunately, this approach is no more suitable for extremely costly evaluations of the reference problem. Recent methods are aimed at constructing models based on multilevel fidelity evaluations. Their purpose is to construct a surrogate model with many samples resulting from low fidelity evaluations corrected by a few high fidelity samples. Space mapping [9] constructs a matching function between a low fidelity model and a high fidelity model for correcting surrogate model evaluations in optimization problems. More recently, the construction of the Kriging

model has been extended to samples of multilevel fidelity, using the space mapping technique. This co-Kriging model is described in [22]. Another illustration is provided by a strategy of trust-region model managing of the fidelity of surrogate models for MDO problems [54]. Multimodal problems require complex regression models involving a lot of coefficients. The resulting optimization problem can be very difficult and consequently requires a large set of samples. A mixture of experts combines several surrogate models that fit the clustered data set locally, rather than globally. Hence, the difficulty no longer lies in the construction of a global surrogate model, but rather in the domain decomposition and combination function.

## Surrogate models for multidisciplinary optimization

Metamodeling techniques are particularly suited to MDO problems, in which discipline evaluations are costly and can be processed independently. In a general way, surrogate models are substituted into the disciplinary simulation [62]. However, the objective or constraints of the problem can also be approximated, in order to obtain the optimal point more easily. Moreover, the multilevel formulations were also adapted to the use of metamodels. Multidisciplinary feasible (MDF) formulations with the substitution of objective functions by metamodels are detailed in [37][60]. An extended formulation of BLISS to disciplinary metamodels is proposed in [67]. An adaptation of CSSO to artificial neural networks is detailed in [59]. An integration of moving least squares in the CO formulation is presented in [74].

## High-fidelity modeling: surrogate model investigation

Within the framework of the DOOM methodological project carried out at Onera, significant research was made in regard to several RSM techniques, including neural networks, Kriging-based RSM, SVM, RBF, *etc.* These methods were applied on two test cases in the fields of structure (left) and aerodynamics (right), each being characterized by 5 parameters :

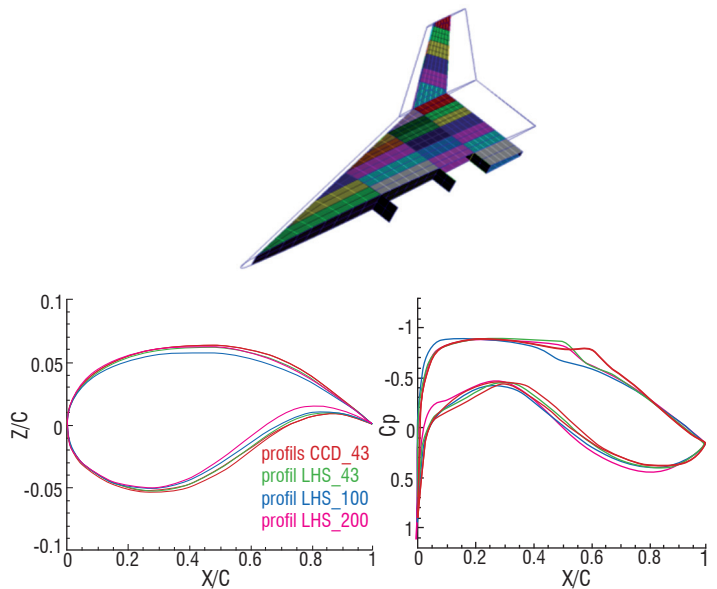

Figure 11 – Structure and aerodynamics, RSM test cases

The tests on 4 different kind of RSM with variable sample size showed the same behavior for both physics, which is illustrated by the chart on the right. It shows the error of the surrogate models along the X-axis and the percentage of validation points along the Y-axis, where the surrogate error is smaller than the X-axis error.



The Kriging methods appear to be quite efficient, but they are sensitive to the parameter tuning accuracy, RBF show acceptable results but little improvement is shown when the sample size increases and the neural network methods are difficult to tune, but offer greater degrees of freedom.

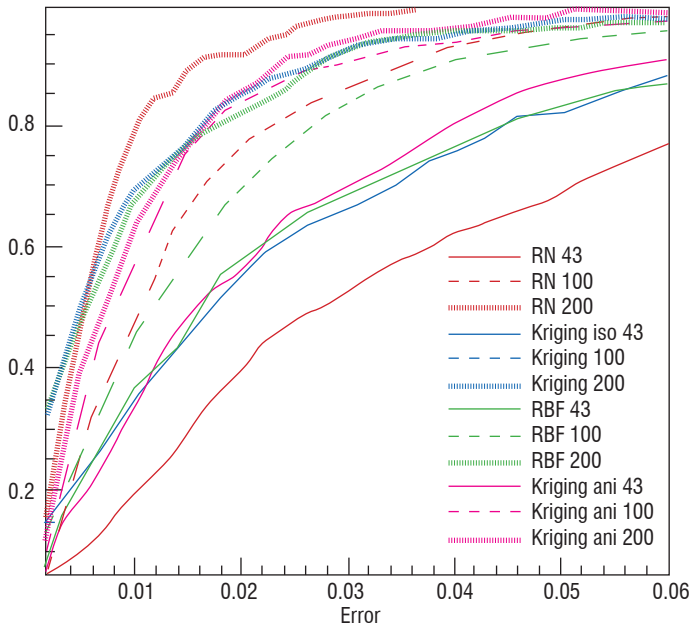

Figure 12 – Distribution of several surrogate models

## Two examples of MDO applications at Onera

Many projects have been achieved at Onera involving the development of MDO techniques. For example, the construction of the UCoDe (UAV Conceptual Design) tool, inherited from the Onera project HALERTE. It consists in an integrated UAV design platform wrapped in the Model Center environment, which has been developed for 10 years through various studies. More details about this project can be found in [11][12][29][33][42]. This section is focused on two examples of recent use of MDO techniques at Onera: the design of aircraft and launch vehicles.

### Aircraft design: the ARTEMIS project

#### Context

Airbus Flight Physics defined a strategy called Multi-Disciplinary Design Capability (MDDC) aimed at an enhancement of the aircraft development process, from the initial concept definition to the validation of the detailed product. The objective is to enable both a more robust design, based on a better knowledge of the aircraft (higher fidelity tools), and the possibility of keeping several design options [45] as long as possible.

To initiate the implementation of the MDDC in an industrial environment, Airbus started project ARTEMIS (Advanced R&T Enablers for Multidisciplinary Integrated Systems) to identify and complete the necessary technical progress to be made in different disciplines, as a first step, and then to carry out studies to increase the readiness level of these techniques. Launched in September 2008, the first phase, called ARTEMIS eXternal Research Forum (XRF), scheduled different workshops between European research centers (DLR, Onera, QinetiQ) in order to provide the state of the art in Multi-Disciplinary Optimization at different stages of the

aircraft design process and the identification of the necessary scientific developments in 5 areas (data modeling, multi-disciplinary processes, optimization toolboxes, framework and tool integration). After several iterations between its specialists based on conclusions from past projects, Onera proposed at the end of ARTEMIS XRF a 5 years roadmap on the necessary steps to gradually implement MDDC. This roadmap is divided into two main research axes, and the part of the work performed at Onera is aimed at achieving the milestones identified for the first two years.

### Bi-disciplinary bi-level design process

The Bi-Disciplinary process is aimed at optimizing the shape of the wing (planform, airfoil and twist) and its internal structure. The process is based on high fidelity tools used at the detailed design level. For CFD, elsA (Onera code) is used, while for CSM, NASTRAN is used. The architecture of this optimization process follows the BLISS approach. An asset of this method is the possibility to carry out the disciplinary optimizations in an independent manner. A general description of this method is given in the following figure, where:

- $X_a$  correspond to Aerodynamic variables;
- $X_s$  correspond to Structure variables;
- $Z$  corresponds to system variables.

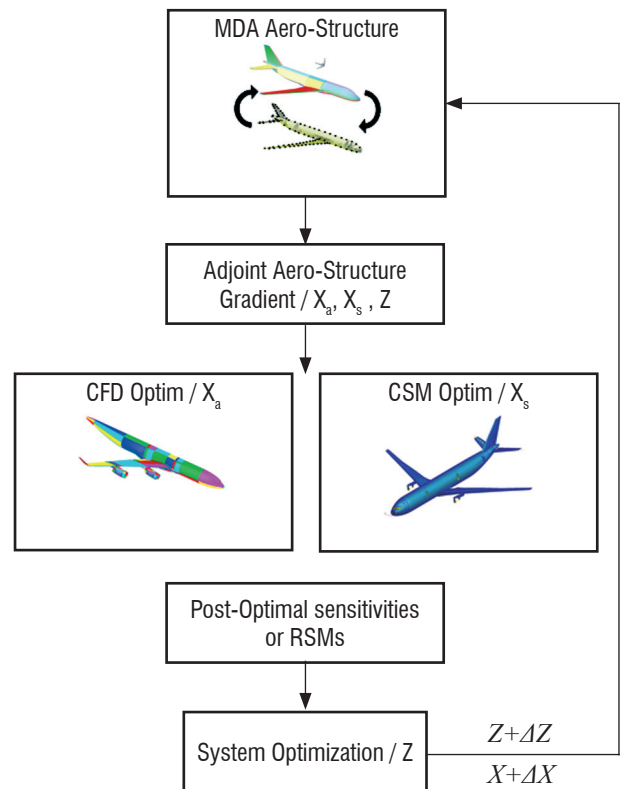

Figure 13 – BLISS approach into ARTEMIS project

In a first step, for a given set of disciplinary variables ( $X_0$ ) and system variables ( $Z_0$ ), the multidisciplinary aero-structure analysis is completed, resulting in a consistent set of data. Subsequently, the calculation of coupled sensitivities and the disciplinary optimization are carried out, resulting in a new set of disciplinary variables. Using post-optimal sensitivity analysis [14], the total derivatives with respect to system variables of the Drag and Structural Weight are evaluated. The optimization of the system with respect to the system variables is completed by a trust-region approach, to control the validity model of the reduced-model.

## Global aircraft design process

This design process is aimed at performing the complete aircraft optimization (large number of disciplines involved and lower fidelity tools) at the conceptual design level (MG2 to MG3).

The constraints taken into consideration during this optimization process are:

- Limitations regarding the span, to meet airport constraints;
- Limitations on geometric parameters, to avoid unfeasible geometries;
- Approach speed;
- Take off field length considering a One Engine Inoperative (OEI) condition.

The multidisciplinary process of GAP is based on 4 modules, with strong interactions: aerodynamics (cruise configuration and low speed, from empirical equations), propulsion (thrust and specific consumption function of Mach and altitude, given by existing databases, or a rubber engine model), weight estimation (combination of fixed weights, empirical data and physics-based sizing) and mission performances (calculation of state variables over the whole mission). It is mostly based on aircraft conceptual design rules [54][55] and will also be aimed in the following steps at integrating the definition of the control system in the design loop [1][16][40][45][53].

A key point of the proposed roadmap is the introduction of a coupling between the Bi-Disciplinary Process and the Global Aircraft Process, in order to benefit from the assets of each approach and thus improve the respective optimization processes. Figure 14 gives an overview of the coupling between the two processes.

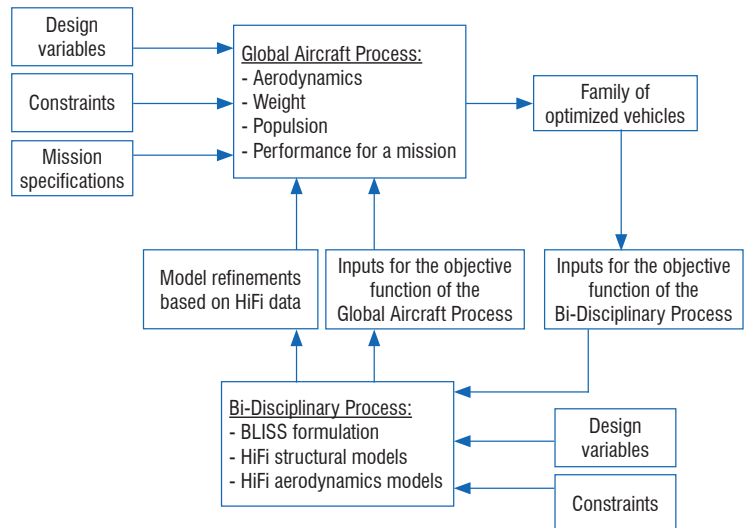

Figure 14 – Coupling between the Global Aircraft Process and the Bi-Disciplinary Process

## MDO applied to launch vehicle design: SWORD method

### Context

Launch Vehicle Design (LVD) is a complex problem, which involves many disciplines (propulsion, aerodynamics, structure, trajectory, etc.). These disciplines may have antagonistic objectives (e.g. structure and aerodynamics) and may require Multidisciplinary Design Optimization (MDO) methods to handle the couplings and to

## Box 2 - Uncertainty handling

Uncertainties are becoming increasingly pervasive in the world of engineering systems. They can take, for instance, some random forms (operations, parameter-driven, shapes, physical model parameters) or epistemic descriptions (form driven, unknown unknowns). Uncertainty can consequently play a key role in designing the “best” engineering systems. Possible manners to use and characterize uncertainty in MDO are described next.

System and disciplinary analysis in MDO must be run thousands of times and involves a great computation burden. Approximation methods should be used to construct metamodels of the high-fidelity models and substitute them in the optimization, so as to balance the accuracy and cost [52]. To build approximation models, design-of-experiment (DOE) techniques [4][32] can be used, to sample data in the design domain with the knowledge of parameter uncertainty. The accuracy of the approximation models is dependent on the number of samples and on the positions of the samples in the design space. Nevertheless, too many samples could result in a computation burden in the construction of the metamodel itself. There is thus a trade-off between the sampling size and the metamodel accuracy.

Uncertainty analysis also allows the uncertainty distribution characteristics of the system performances under the impacts of design uncertainties to be described, and also determines which input parameters are the most influent on its performances. For complex systems with multiple disciplines, the direct propagation of uncertainties can be difficult to process for uncertainty analysis [51]. For that purpose, methods that could be used for uncertainty analysis are notably Monte-Carlo simulations [56], first order-second Moment analysis [72], stratified sampling, sensitivity analysis [68], etc.

Uncertainty can also influence the optimization process, such as the results based on first order reliability approximation in [43][47]. The first issue related to setting up the optimization problem is the selection of objectives. The output of the uncertainty model will be the mean and the stochastic distribution of each attribute. Therefore, it is straightforward to normalize these values, resulting in the mean of the performances and its distribution [30].

Uncertainty and design is becoming increasingly central to MDO and to decision making. New techniques in MDO that deal with uncertainty appropriately have the potential to impact many aerospace systems and problems of interest (e.g. [19][41][58][75][76]). Nevertheless, new approaches must be developed to make problems tractable and frameworks being developed today must take into account possible organizational structures dictated by design under uncertainty methods.

facilitate the quest for compromises. The most used MDO method in LVD is the Multidiscipline Feasible method (MDF). In this method, all of the optimization variables are handled at the same level, and a Multidisciplinary Analysis (MDA) is performed upon each iteration, ensuring the consistency of the couplings.

In order to decouple the computationally expensive MDA, classical decomposition used in LVD is performed according to the various disciplines. This decomposition makes possible the use of single-level methods (Individual Discipline Feasible, All At Once) or multi-level methods (Collaborative Optimization, Concurrent Subspace Optimization, Bi-Level Integrated Systems Synthesis, etc.). This discipline-wise decomposition does not exploit the main specificity of the LVD, which is the combination of the optimizations of the design and trajectory variables [5]. Indeed, the trajectory optimization is often considered as a black box and is optimized in the same way as for the other disciplines.

### SWORD method

In order to place the trajectory optimization at the center of the optimization process, a new decomposition method, called the Stage-Wise decomposition for Optimal Rocket Design (SWORD) method, has been developed [6]. This bi-level method splits up the LVD problem according to the different flight phases and transforms the global MDO problem into the coordination of smaller ones. Each stage is optimized separately and the different stages are coordinated through the trajectory optimization, via the state vectors at the stage separations.

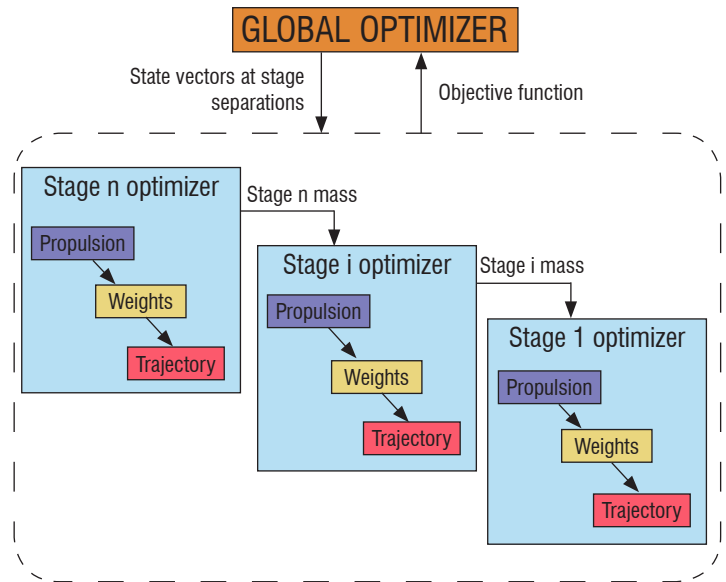

Figure 16 – SWORD architecture

### Application case: optimization of a three-stage launch vehicle

The LVD problem to be solved is the optimization of a three-stage cryogenic launch vehicle. The objective function to be minimized is the Gross-Lift-Off-Weight (GLOW). The payload mass is equal to 4 tons and the target orbit is a Geostationary Transfer Orbit.

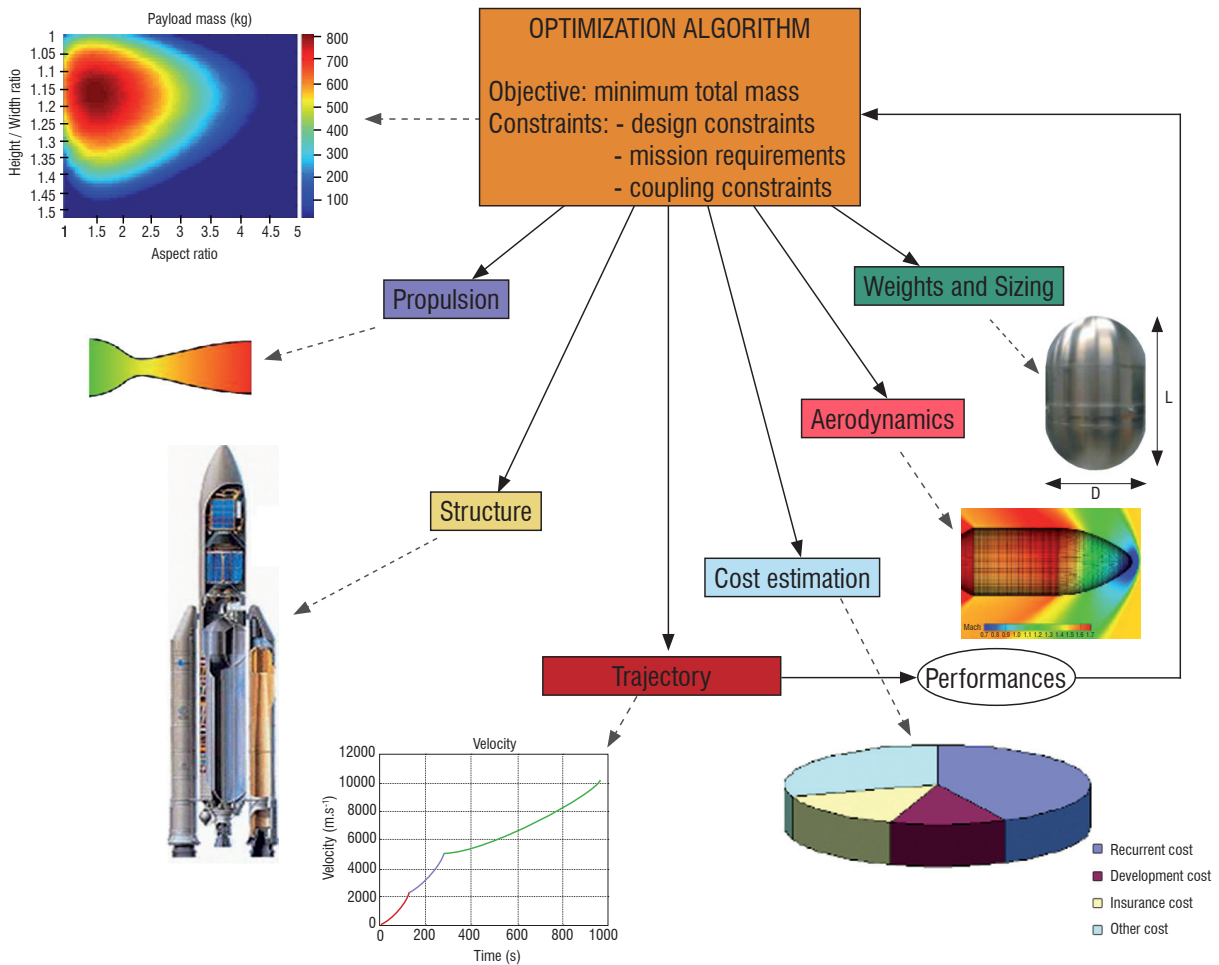

Figure 15 – Example of a Launch Vehicle Design process

## Comparison with MDF in case of global search

In order to be consistent with the literature dealing with the MDO methods in launch vehicle design [10][17][20][71], the SWORD method has been compared with MDF using a same Genetic Algorithm in a very large search space. The comparison is performed considering the same computation time (10 hours). Ten runs have been carried out from random initializations and three comparative criteria have been selected for the comparison:

- The best found design at the stopping time of the algorithm;
- The time elapsed to find a first feasible design from random initialization;
- The improvement of the objective function during the optimization process.

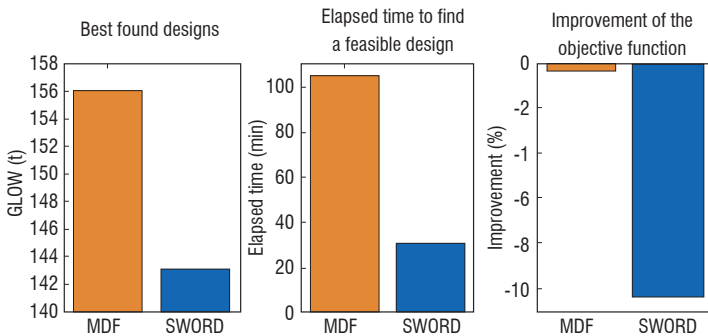

Figure 17 – Results of the comparison

SWORD clearly outperforms MDF in the case of global search optimization in a very large search space. Indeed, this method leads to the best design, is able to find a feasible design in a minimum time and leads to the best improvement of the objective function during the optimization. However, even though the SWORD method allows the efficiency of the MDO process to be clearly improved with respect to MDF, this study has shown that the use of a global search alone is not sufficient to obtain an optimum within an acceptable calculation time (a few hours). Therefore, the development of a specific optimization strategy is necessary.

## Dedicated optimization strategy

### Principle

The choice of the optimization algorithms is a key point in LVD. Indeed, both global and local searches are required, in order to explore a large search space and to converge efficiently toward an optimum. We have taken into account the four following requirements to develop the optimization strategy:

- The ability to quickly find feasible designs (*i.e.* satisfying the design and coupling constraints) from random initialization;
- The ability to converge from very large search domains (no accurate estimations of the optimization variables variation domains are required);
- Once a feasible domain is reached, the ability to efficiently converge toward an optimum.

In order to meet all of these requirements, we propose a three-phase strategy using the proposed stage-wise decomposition [7]. In the first phase, we exploit the flight-phase decomposition to perform a sequential exploration of the system-level optimization variable sets. Once feasible designs are found, a first optimization phase using the

Nelder & Mead algorithm [49] is carried out to reach the vicinity of an optimum. Finally, in order to converge quickly toward an optimum, a bi-level gradient-based optimization, using Post-Optimality Analysis [14] and Global Sensitivity Synthesis [63], is achieved.

## Results

In order to evaluate the efficiency and the robustness of the proposed optimization strategy, 10 runs have been carried out from different randomized initializations. The system-level variable search domains have been defined as very large, in order to estimate the efficiency of the method without requiring any a priori knowledge on design variables from the user. Figure 4 presents the change in the relative difference (in percentage) between the best found design and the reference optimum (which is obtained with fine tunings on the optimizers and design variable variation domains).

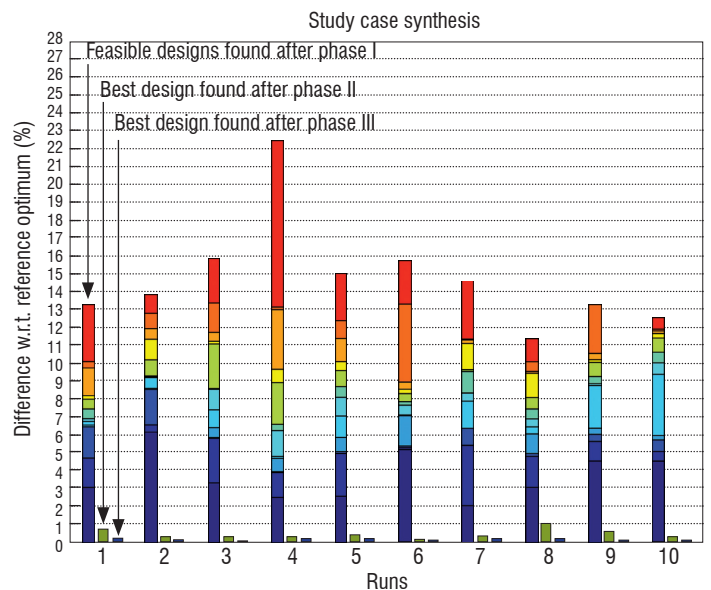

Figure 18 – Study case synthesis

The different divisions of colored left bars represent the 12 feasible designs obtained after Phase I, which are used to initialize the Nelder & Mead algorithm. In all of the cases, the optimization process converges with a maximal relative difference of 0.2% between the found design and the reference optimum. Indeed, the relative distance between the found design and the reference optimum is reduced by 96% on average, in a calculation time of approximately 4 hours (MATLAB, 2.4GHz Dual Core Pentium/Windows XP), which is very satisfactory in early design launch vehicle studies.

## Conclusion and perspectives

Striving to achieve increasingly complex system integration studies and to generate innovative aerospace vehicle concepts, one faces the challenge of developing robust, efficient and innovative design methodologies. Comprehensive investigation of process set up, uncertainty quantification, high-fidelity tool integration and formal decomposition of the optimization strategy is mandatory, but this theory must always be tested and validated on 'real-life' design cases. The on-going methodological actions at Onera in the field of conceptual layout, control system design or RSM advanced techniques, together with the application in more and more industrial design cases, pave the way to a real "off the shelf" multi-level, multi-fidelity and multi-disciplinary capability ■

## References

- [1] M.J. ABZUG and E.E. LARRABEE - *Airplane Stability and Control - A History of the Technologies that Made Aviation Possible, 2<sup>nd</sup> Edition*. Cambridge Aerospace Series, 2005.
- [2] J. AGTE, O. DE WECK, J. SOBIESZCZANSKI-SOBIESKI, J. ARENSEN, P. MORRIS and M. SPIECK - *MDO Assessment and Direction for Advancement - an Opinion of One International Group*. Structural Multidisciplinary Optimization, 40:17-33, 2010.
- [3] N. ALEXANDROV and M. HUSSAINI - *Multidisciplinary Design Optimization: State of the Art*. 8<sup>th</sup> AIAA/UASAF/NASA/ISSMO Symposium on Multidisciplinary Analysis and Optimization. Long Beach, CA, USA, 2000.
- [4] A.C. ATKINSON, A.N. DONEV and R.D. TOBIAS - *Optimum Experimental Designs with SAS*. Oxford University Press, 2007.
- [5] M. BALESDENT, N. BEREND, P. DEPINCE and A. CHRIETTE - *A Survey of Multidisciplinary Design Optimization Methods in Launch Vehicle Design*. Structural Multidisciplinary Optimization, published online, 2011.
- [6] M. BALESDENT, N. BEREND and P. DEPINCE - *New MDO Approaches for Launch Vehicle Design*. 4<sup>th</sup> European Conference for AeroSpace Sciences St Petersburg, Russia, 2011.
- [7] M. BALESDENT, N. BEREND and P. DEPINCE - *MDO Formulation and Techniques Adapted to Multi-Stage Launch Vehicle Design*. 9<sup>th</sup> World Congress on Structural and Multidisciplinary Optimization, Shizuoka, Japan, 2011.
- [8] R. BALLING and J. SOBIESZCZANSKI-SOBIESKI - *Optimization of Coupled Systems: a Critical Overview of Approaches*. NASA/ICASE Report 94-100, 1994.
- [9] J.W. BANDLER, Q.S. CHEN, S.A. DAKROURY, A.S. MOHAMED, K. MADSEN and J. SONDERGAARD - *Space Mapping: The State of the Art*. IEEE Transactions on Microwave Theory and Techniques, 52(1):337-361, 2004.
- [10] D. BAYLEY, R. HARTFIELD, J. BURKHALTER and R. JENKINS - *Design Optimization of a Space Launch Vehicle Using a Genetic Algorithm*. Journal of Spacecraft and Rockets, 45(4):733-740.
- [11] N. BEREND, M. BOURGAIE, S. DEFOORT, J. HERMETZ, C. LE TALLEC and R. BEC - *Innovative Air-Launch System Using a Multirole UAV*. 57<sup>th</sup> International Astronautical Congress, Valence, Spain, 2006.
- [12] N. BEREND, C. LE TALLEC, J. HERMETZ and R. BEC - *New Perspective for Air Launch Systems Using Unmanned Aerial Vehicles*. 7<sup>th</sup> International Symposium on Launcher Technologies, Barcelona, Spain, 2007.
- [13] P. BONNANS, J-C GILBERT, C. LEMARECHAL and C. SAGASTIZABAL - *Numerical Optimization. Theoretical and Practical Aspects, 2<sup>nd</sup> Edition*. Springer, 2006.
- [14] R. BRAUN, I. KROO and P. GAGE - *Post Optimality Analysis in Aerospace Vehicle Design*. AIAA Aircraft Design, Systems and Operations Meeting, Monterey, USA, 1993.
- [15] R. BRAUN and I. KROO - *Development and Application of the Collaborative Optimization Architecture in a Multidisciplinary Design Environment*. *Multidisciplinary Design Optimization : State of the Art*. SIAM 98-116, 1995.
- [16] C. CARPENTER - *Flightwise Volume 2, Aircraft Stability and Control*. Airline Publishing Ltd, 2002.
- [17] F. CASTELLINI and M. LAVAGNA - *Concurrent Optimization of Launcher Architecture and Ascent Trajectories with Global Optimization Algorithms*. 59<sup>th</sup> International Astronautical Congress, Glasgow, Scotland, 2008.
- [18] J. CLEMENT, J. HERMETZ, N. BARTOLI and M. MASMOUDI - *Multi-Disciplinary Optimisation Methods Studies*. EUCASS conference, Brussels, Belgium, 2007.
- [19] V. DUBOURG, B. SUDRET and J-M. BOURINET - *Reliability-Based Design Optimization Using Kriging Surrogates and Subset Simulation*. Structural Multidisciplinary Optimization, published online, 2011.
- [20] N. DURANTE, A. DUFOUR and V. PAIN - *Multidisciplinary Analysis and Optimisation Approach for the Design of Expendable Launchers*. 10<sup>th</sup> AIAA/ISSMO Multidisciplinary Analysis and Optimization Conference, Albany USA, 2004.
- [21] R. FLETCHER - *Practical Methods of Optimization, 2<sup>nd</sup> Edition*. John Wiley & Sons Ltd, 1987.
- [22] A.I.J. FORRESTER, A. SOBESTER and A. KEANE - *Multi-Fidelity via Surrogate Modelling*. Proceedings of the Royal Society A. 463:3251-3269, 2007.
- [23] A.I.J. FORRESTER, A. SOBESTER and A. KEANE - *Engineering Design via Surrogate Modelling: A Practical Guide*. Progress in Astronautics and Aeronautics Series, 226, published by John Wiley & Sons, 2008.
- [24] J. H. FRIEDMAN - *Multivariate Adaptive Regressive Splines*. The annals of statistics 19:1-67, 1991.
- [25] S. GAZUT, J. M. MARTINEZ, G. DREYFUS and Y. OUSSAR - *Towards the Optimal Design of Numerical Experiments*. IEEE Transactions on Neural Networks, 19(5):874-882, 2008.
- [26] J. P. GIESING and J.-F. BARTHELEMY - *A Summary of Industry MDO Applications and Needs*. AIAA Technical Committee, 1998.
- [27] P. GILL, W. MURRAY and M. SAUNDERS - *Large-Scale SQP Methods and their Applications in Trajectory Optimization*. Birkhauser Verlag, 1994.
- [28] D. GOLDBERG - *Genetic Algorithms in Search, Optimization and Machine Learning*. Addison-Wesley Professional, 1989.
- [29] Z. GORAJ, A. FRYDRYCHEWICZ, J. HERMETZ and C. LE TALLEC - *HALE UAV Platform Optimized for a Specialized 60-ft Altitude Patrol Mission*. 24<sup>th</sup> International Congress of the Aeronautical Sciences, Yokohama, Japan, 2004.
- [30] J. GUO, W. YAO and E. GILL - *Uncertainty Multidisciplinary Design Optimization of Distributed Space Systems*. 6<sup>th</sup> International workshop on satellite constellation and formation flying, Taipei, Taiwan, 2010.
- [31] N. HANSEN and A. OSTERMEIER - *Completely Derandomized Self-Adaptation in Evolution Strategies*. Evolutionary Computation 9(2):159-195, 2001.
- [32] K. HINKELMANN and O. KEMPTHORNE - *Design and analysis of experiments I and II, 2<sup>nd</sup> Edition*. Wiley, 2008.
- [33] J. HERMETZ and HALERTE - *A Multidisciplinary Tool for HALE UAV System Concepts Definition and Evaluation*, UAVnet meeting, Eilat, Israel, 2002.
- [34] J. HOLLAND - *Adaptation in Natural and Artificial System*. Ann Arbor: the University of Michigan Press, 1975.
- [35] R. JIN, W. CHEN and T. W. SIMPSON - *Comparative Studies of Metamodeling Techniques under Multiple Modelling Criteria*. Structural Multidisciplinary Optimization, 23(1):1-13, 2001.
- [36] D. JONES, M. SCHONLAU and W. WELCH - *Efficient Global Optimization of Expensive Black-Box Functions*. Journal of Global Optimization 13:455-492, 1998.
- [37] F. JURECKA - *Automated Metamodeling for Efficient Multi-Disciplinary Optimisation of Complex Automotive Structures*. 7<sup>th</sup> European LS-DYNA Conference, 2009.
- [38] S. KIRKPATRICK, C.D. GELATT and M.P. VECCHI - *Optimization by Simulated Annealing*. Science 220:671-680, 1983.
- [39] J.P.C. KLEIJNEN, S. M. SANCHEZ, T.W. LUCAS and T. M. CIOPPA - *A User's Guide to the Brave New World of Designing Simulation Experiments*. INFORMS Journal on Computing 17(3):263-289, 2005.
- [40] M. LAPINS, R.P. MARTORELLA, R.W. KLEIN, R.C. MEYER and M.J. STURN - *Control Definition Study for Advanced Vehicles*. NASA CR 3738, 1983.

- [41] I. LEE, K.K. CHOI and L. ZHAO - *Sampling-Based RBDO Using Dynamic Kriging Method and Stochastic Sensitivity Analysis*. 13<sup>th</sup> AIAA/ISSMO Multidisciplinary Analysis Optimization Conference Fort Worth, USA, 2011.
- [42] C. LE TALLEC, J. HERMETZ and HALERTE - *A Multidisciplinary Engineering Methodology for HALE UAV System Conceptual Design*. Onera -DLR Aerospace Symposium, Toulouse, France, 2003.
- [43] J. LIANG, Z.P. MOURELATOS and J. TU - *A Single-Loop Method for Reliability-Based Design Optimization*. International Journal of Product Development, 5(1/2):76-92, 2008.
- [44] T. LIEU, C. FARHAT and M. LESOINNE - *Reduced-Order Fluid/Structure Modeling of a Complete Aircraft Configuration*. Computer methods in applied mechanics and engineering, 195(41-43):5730-5742, 2006.
- [45] D. MAVRIS and D. DELAURENTIS - *Methodology for Examining the Simultaneous Impact of Requirements, Vehicle Characteristics, and Technologies on Military Aircraft Design*, ICAS Congress, Harrogate, UK, 2000.
- [46] N. MICHELENA and H. KIM, P. PAPALAMBROS - *A System Partitioning and Optimization Approach to Target Cascading*. Proceedings of the 12<sup>th</sup> International Conference on Engineering Design, Munich, Germany, 1999.
- [47] Z.P. MOURELATOS, N. VLAHOPOULOS, O. EBRAT, J. LIANG and J. WIANG. - *Probabilistic Main Bearing Performance for an Internal Combustion Engine*. ASME Journal of Tribology 127(4) :784-792, 2005.
- [48] R. H. MYERS, D. C. MONTGOMERY and C. M. ANDERSON-COOK - *Response Surface Methodology: Process and Product Optimization Using Designed Experiments*. John Wiley & Sons, Inc., 1995.
- [49] J. NELDER and R. MEAD - *A Simplex Method for Function Minimization*. Computer Journal 7:308-313, 1965.
- [50] J. NOCEDAL and S. WRIGHT - *Numerical Optimization, 2<sup>nd</sup> Edition*. Springer-Verlag, 2006.
- [51] W.L. OBERKAMPF, S.M. DELAND, B.M. RUTHERFORD, K.V. DIEGERT and K.F. ALVIN - *Error and Uncertainty in Modelling and Simulation*. Reliability Engineering and System Safety 75(3):333-357, 2002.
- [52] D. PADMANABHAN and S. BATILL - *Reliability Based Optimization Using Approximations with Applications to Multidisciplinary System Design*. 40<sup>th</sup> Aerospace sciences meeting & exhibit, Reno, USA, 2002.
- [53] R.E. PEREZ, H.H.T LIU and K. BEHDINAN - *Multidisciplinary Optimisation Framework for Control-Configuration Integration in Aircraft Conceptual Design*. Journal of Aircraft, 43(6), 2006.
- [54] D.P. RAYMER - *Aircraft Design: A Conceptual Approach, 3<sup>rd</sup> Edition*. AIAA Education Series, 1999.
- [55] J.F. RODRIGUEZ, V.M. PEREZ, D. PADMANABHAN and J.E. RENAUD - *Sequential Approximate Optimization Using Variable Fidelity Response Surface Approximations*. Structural Multidisciplinary Optimization 22:24-34, 2001.
- [56] J. ROSKAM - *Airplane Design*. DAR corporation, 1997-2002.
- [57] R.Y. RUBINSTEIN and D.P. KROESE - *Simulation and the Monte Carlo Method, 2<sup>nd</sup> Edition*. John Wiley & Sons, 2007.
- [58] J. SACKS, J., W. WELCH, T. J. MITCHELL and H. P. WYNN - *Design and Analysis of Computer Experiments*. Statistical Science, 4(4):409-435, 1989.
- [59] D. SALAZAR, R. LERICHE, J. MOLIMARD and A. VAUTRIN - *An Empirical Study of the Use of Confidence Levels in RBDO with Monte Carlo Simulations, Multidisciplinary Design Optimization in Computational Mechanics*. P. Breitkopf and R. Filomeno Coelho Eds., Wiley/ISTE Pub, 2010.
- [60] R.S. SELLAR, S.M. BATILL and J.E. RENAUD - *Response Surface Based, Concurrent Subspace Optimization for Multidisciplinary System Design*. In 34<sup>th</sup> AIAA Aerospace Sciences Meeting and Exhibit, USA, 1996.
- [61] T.W. SIMPSON, J.J. KORTE, T.M. MAUERY and F. MISTREE - *Comparison of Response Surface and Kriging Models for Multidisciplinary Design Optimization*. 7<sup>th</sup> AIAA/USAF/NASA/ISSMO Symposium on Multidisciplinary Analysis and Optimization, USA AIAA-1998-4755, 1998.
- [62] T. W. SIMPSON, J. D. POPLINSKI, P. N. KOCH and J. K. ALLEN - *Metamodels for Computer-Based Engineering Design: Survey and Recommendations*. Engineering with computers, 17(2):129-150, 2001.
- [63] T. W. SIMPSON, V. TOROPOV, V. BALABANOV and F.A.C. VIANA - *Design and Analysis of Computer Experiments in Multidisciplinary Design Optimization: a Review of How Far We Have Come or Not*. 12<sup>th</sup> AIAA/ISSMO Multidisciplinary Analysis and Optimization Conference, 10-12, 2008.
- [64] J. SOBIESZCZANSKI-SOBIESKI, J. BARTHELEMY and K. RILEY - *Sensitivity of Optimum Solutions of Problem Parameters*. AIAA Journal 20(9), 1982.
- [65] J. SOBIESKI, J. S. AGTE and R. SANDUSKY - *Bi-Level Integrated System Synthesis (BLISS)*. 7<sup>th</sup> AIAA/USAF/NASA/ISSMO Symposium, St Louis, USA, AIAA-1998-4916, 1998.
- [66] J. SOBIESZCZANSKI-SOBIESKI and R. HAFTKA - *Multidisciplinary Aerospace Design Optimization: Survey of Recent Developments*. Structural Optimization 14:1-23, 1997.
- [67] J. SOBIESZCZANSKI-SOBIESKI - *Optimization by Decomposition: a Step from Hierarchic to Non-Hierarchic Systems*. NASA Technical Report CP-3031, 1988.
- [68] J. SOBIESZCZANSKI-SOBIESKI, T.D. ALTUS, M. PHILIPS and R. SANDUSKY - *Bilevel Integrated System Synthesis for Concurrent and Distributed Processing*. AIAA Journal, 41(10):1996-2003, 2003.
- [69] I.M. SOBOL and S. KUCHEREKO - *Sensitivity Estimates for Nonlinear Mathematical Models*. Mathematical Modelling and Computational Experiments, Vol. 1:407-414, 1993.
- [70] N.P. TEDFORD and J.R.R.A. Martins - *Benchmarking Multidisciplinary Design Optimization Algorithms*. Optimization Engineering 11:159-183, 2010.
- [71] S. TOSSERAMS, L.F.P. ETMAN and J.E. ROODA - *A Classification of Methods for Distributed System Optimization Based on Formulation Structure*. Structural Multidisciplinary Optimization 39:503-517, 2008.
- [72] T. TSUCHIYA and T. MORI - *Optimal Conceptual Design of Two-Stage Reusable Rocket Vehicles including trajectory optimization*. Journal of Spacecraft and Rockets 41(5):770-778
- [73] M. UZIELLI, S. DUZGUNY and B.V. VANGELSTENZ - *A First-Order Second-Moment Framework for Probabilistic Estimation of Vulnerability to Landslides*. ECI Conference on Geohazards, Lillehammer, Norway, 2006.
- [74] G. G. WANG and S. SHAN - *Review of Metamodeling Techniques in Support of Engineering Design Optimization*. Journal of Mechanical Design, 129, 2007.
- [75] P. ZADEH, V. TOROPOV and A. WODD - *Metamodel-Based Collaborative Optimization Framework*. Structural and Multidisciplinary Optimization, 38(2):103-115, 2009.
- [76] K. ZAMAN and S. MAHADEVAN - *Design Optimization under Data Uncertainty*. 9<sup>th</sup> World Congress on Structural and Multidisciplinary Optimization. Shizuoka, Japan, 2011.
- [77] L. ZHAO, K.K. CHOI, I. LEE, D. LAMB and D. GORSICH - *Conservative Surrogate Model Using Weighted Kriging Variance for Sampling Based RBDO*. 9<sup>th</sup> World Congress on Structural and Multidisciplinary Optimization. Shizuoka, Japan, 2011.

## Acronyms

AAO (All At Once)  
ANR (Association Nationale pour la Recherche)  
ARTEMIS (Advanced R&T Enablers for Multidisciplinary Integrated Systems)  
ASMP (*Air Sol Moyenne Portée* / Medium-Range Air to Surface Missile)  
ATC (Analytical Target Cascading)  
BLISS (Bi-Level Integrated System Synthesis)  
CMA-ES (Covariance Matrix Adaptation Evolution Strategy)  
CO (Collaborative Optimization)  
CSDL (Complex System Design Lab)  
CSSO (Concurrent SubSpace Optimization)  
DeDalus (Design of Dual-use Air Launch UAV Systems)  
DOE (Design Of Experiments)  
DOOM (Démarche Outillée d'Optimisation Multidisciplinaire)  
FP7 (Framework Program 7)  
GAP (Global Aircraft Process)  
GLOW (Gross Lift Off Weight)  
HALE (High Altitude Long Endurance)  
HALERTE (Haute Altitude Longue Endurance des Robots Transportant des Equipements)

IDF (Individual Discipline Feasible)  
LVD (Launch Vehicle Design)  
MDA (MultiDisciplinary Analysis)  
MDDC (Multi-Disciplinary Design Capability)  
MDF (Multi Discipline Feasible)  
MDO (Multidisciplinary Design Optimization)  
OMD (French acronym for MDO)  
OEI (One Engine Inoperative)  
PERSEUS (Projet Européen de Recherche Spatiale Etudiant Universitaire et Scientifique)  
SQP (Sequential Quadratic Programming)  
RSM (Response Surface Methodology)  
SVM (Support Vector Machine)  
RBF (Radial Basis Function)  
SWORD (Stage-Wise decomposition for Optimal Rocket Design)  
UAV (Unmanned Air Vehicle)  
UCoDe (UAV Conceptual Design)  
XRF (eXternal Research Forum)

## AUTHORS



**Sébastien Defoort** graduated from “*Ecole Centrale de Lyon*” in 2002, with a major in Aerospace Engineering. He has worked at Onera since 2004, as a research engineer in the field of aerospace vehicle design and performance and he has developed methods and tools for vehicle layout, multi-disciplinary optimization and flight dynamics evaluation.



**Mathieu Balesdent** obtained a PhD degree in mechanical engineering from the “*Ecole Centrale de Nantes*” in 2011. He is currently working as a research engineer at Onera. His research interests include multidisciplinary design optimization, uncertainty propagation and rare event probability estimation.

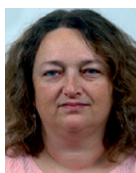

**Patricia Klotz** obtained a PhD from SupAero in 1991. She joined the Onera Mathematical Modeling and Numerical Simulation group in 1995, where she focused on surrogate based optimization applied to combustion chamber design. Currently, she is in charge of an internal research project on surrogate modeling.



**Peter Schmollgruber** joined the System Design and Performance Evaluation Department in 2006, as a Research Engineer in Aircraft Design. His work focuses on advanced aircraft design methods. Developments in this area are subsequently used to define, assess and optimize new aircraft concepts. In parallel, he carries out studies on scaled demonstrators.



**Jérôme Morio** has been a Research Engineer at Onera since 2007. He graduated from the “*Ecole Nationale Supérieure de Physique*” of Marseille, France, in 2004 and obtained a Ph.D. degree in physics from the University Aix-Marseille Paul Cézanne, France, in 2007. His main research interests include rare event estimations, sensitivity analysis, uncertainty propagation and optimization for large scale and time-dependent systems.



**Jean Hermetz** graduated from the “*Ecole Nationale Supérieure d'Arts et Métiers*” (ENSAM 1986) and the “*Ecole Supérieure des Techniques Aéropatiales*” (ESTA 1990). He has worked at Onera since 1991, in the System Design and Performance evaluation department (DCPS). In 2004, he launched a 4-year Onera internal project dedicated to the development of new methodologies and tools for Multidisciplinary Design Optimization. He is now the Head of the Aeronautical Systems Research Unit of the DCPS and deputy director of this department.



**Christophe Blondeau** graduated from the “*Ecole Nationale Supérieure d'Arts et Métiers*” in 1990 and from the “*Ecole Supérieure des Techniques Aéropatiales*” the year after. He works in the Aeroelasticity and Structural Dynamics Department (DADS) and has more than ten years of experience in the field of optimization. He is currently in charge of the Multidisciplinary Optimization roadmap of the department.



**Gérald Carrier** is currently working as a research engineer in the Applied Aerodynamics Department at Onera. Being in charge of several research projects related to numerical optimization, he has an experience of more than 10 years in applying local and global optimization methods for aerodynamic and multi-disciplinary design problems.



**Nicolas Bérend** graduated from the “*Ecole Centrale de Lille*” in 1992 and the “*Ecole Supérieure des Techniques Aéropatiales*” in 1993, and is currently in charge of space transportation system studies. He has managed several projects dealing with the multidisciplinary design of space transportation systems, including orbital transfer vehicles (CENTOR) and air launch systems (DEDALUS). He is a Corresponding Member of the International Academy of Astronautics (IAA).