



**HAL**  
open science

## **An Overview of Relevant Issues for Aircraft Model Identification.**

A. Bucharles, C. Cumer, G. Hardier, B. Jacquier, A. Janot, T. Le Moing, C. Seren, C. Toussaint, P. Vacher

► **To cite this version:**

A. Bucharles, C. Cumer, G. Hardier, B. Jacquier, A. Janot, et al.. An Overview of Relevant Issues for Aircraft Model Identification.. Aerospace Lab, 2012, 4, p. 1-21. hal-01183676

**HAL Id: hal-01183676**

**<https://hal.science/hal-01183676v1>**

Submitted on 10 Aug 2015

**HAL** is a multi-disciplinary open access archive for the deposit and dissemination of scientific research documents, whether they are published or not. The documents may come from teaching and research institutions in France or abroad, or from public or private research centers.

L'archive ouverte pluridisciplinaire **HAL**, est destinée au dépôt et à la diffusion de documents scientifiques de niveau recherche, publiés ou non, émanant des établissements d'enseignement et de recherche français ou étrangers, des laboratoires publics ou privés.

A. Bucharles, C. Cumer, G. Hardier,  
B. Jacquier, A. Janot, T. Le Moing,  
C. Seren, C. Toussaint, P. Vacher  
(Onera)

E-mail: georges.hardier@onera.fr

# An Overview of Relevant Issues for Aircraft Model Identification

A number of activities in aeronautical engineering rely on the availability of models to represent the real behavior of the aircraft. Let us quote, for example, the development of autopilots and synthesis of flight control laws, the study of the handling qualities, the fault monitoring process, the prediction of hazardous behaviors, or the implementation of simulators used to train the pilots and to validate hardware and software systems. The initial modeling derived from CFD, wind tunnel or ground tests is seldom reliable enough with respect to the requirements. Hence, the needed accuracy is finally achieved thanks to suitable identification techniques and to a set of peculiar flight tests. In addition, the complexity of the models has increased in recent years, along with more stringent accuracy requirements to satisfy the raising constraints of the new aeronautical devices which make use of these models; *e.g.*, an increasing number of vibration modes in the low frequency range for flexible aircraft, or a larger complexity and non-linearity of the aerodynamical models in the rigid case. Hence, the variety of problems and models under consideration entails taking an interest in a wide range of identification techniques. These include basic methods, like least-squares or maximum likelihood and their variants, spectral analysis and estimators based on Kalman filtering, as well as more recent approaches like neural-based or subspace methods. Special care is given to the frequency domain formulation of the algorithms, especially in the flexible A/C case. Most of these methods are not directly usable as they are and need to be adapted to the peculiarities of aeronautics. Accordingly, this paper reviews the various issues related to the identification process when applied to such applications. These steps include data pre-processing, input design, time vs. frequency domain methods, model validation, etc., and are illustrated by industrial problems dealt with by Onera, for rigid as well as for flexible A/C modeling.

## Introduction

The concept of model identification refers to a set of tasks required to determine, and then to tune, a suitable modeling, likely to explain the experimental behavior of a given system. This involves choosing the type of mathematical relationships linking the i/o observed variables (often denoted as structural identification), as well as adjusting the unknown parameters of these equations (denoted as parametric identification). The early developments in system identification date back to the seventies, but this topic remains the subject of new developments nowadays, especially for aeronautics. In this domain, the works concern the modeling of both rigid aircraft, described by the flight mechanics equations, and flexible aircraft where the structural deformations are taken into account.

A number of activities in aeronautical engineering rely on the availability of models to represent the real behavior of the aircraft. Let us quote for example the development of autopilots and the synthesis of flight control laws, the study of the handling qualities, the fault monitoring process, the prediction of hazardous behaviors, or the implementation of simulators used to train the pilots and to validate hardware and software systems. The initial modeling, obtained from Computational Fluid Dynamics, wind tunnel or ground tests, is seldom accurate enough with respect to the accuracy requirements. Hence, this accuracy is finally achieved thanks to suitable identification techniques and to a set of peculiar flight tests. Models have become increasingly complex in recent years, and there are more stringent

accuracy requirements to satisfy the raising constraints of the new aeronautical devices which make use of these models. In the framework of flexible aircraft for example, the new materials and the structural alleviation lead to an increasing number of vibration modes in the low frequency range, some of which are likely to interact with the rigid body modes. The identification of a flexible model, or even of a coupled one representing both the rigid and flexible components, thus becomes a much trickier task but is also more crucial than it was in the past. On the other hand, the aerodynamical models used for the rigid case are also becoming drastically complex since from now on they integrate several effects that were disregarded before, or simply because the airplanes themselves have become much more complicated. Let us quote A400M as an example, or A380 with an unprecedented proliferation of the control surfaces. We also need to point out a strong industrial constraint, which affects the identification process; the need to reduce the duration and cost of the identification tests, taking place during the first flights of a new airplane (both of these being significant), requires specific techniques to design and then to process this type of tests to be developed, without degrading the quality of the resulting models.

One feature of the aeronautical domain is that we can rely on many physical models derived from aerodynamics, structural dynamics or flight mechanics. Quite often however, these models cannot be implemented into identification algorithms just as they are, because of high orders or strongly nonlinear behaviors. Hence, they require grey-box type simplified physical representations to be developed, or even to make use of intermediate black-box models, linear or nonlinear types. *E.g.*, these submodels facilitate the modeling of multidimensional aerodynamic nonlinearities, usually complex and poorly structured, and are also beneficial to the linear modeling of A/C aeroelastic behavior by means of polynomial transfer functions in the Frequency Domain (FD). In addition, some constraints should be respected during the process: the aircraft simulation will require continuous-time differential equations to be integrated, *a priori* knowledge about the predicted A/C behavior should be considered, a physical understanding and interpretation of the results will remain mandatory and could induce additional constraints in the optimization process.

The variety of problems and models under consideration entails having a wide range of identification techniques available. Obviously, they include basic methods, such as least-squares or maximum likelihood (ML) and their variants, spectral analysis and estimators based on Kalman filtering (KF), as well as more recent approaches like neural or subspace methods. Special care is given to the FD formulation of the algorithms, especially in the flexible A/C case; working inside a limited frequency band allows a good part of the noise to be cancelled and the computational cost to be decreased noticeably, thanks to information compression. Most of these methods are not directly usable as they are and need to be adapted to the peculiarities of aeronautical problems (previously mentioned). For example, a very restrictive point comes from the requirement of coupling identification tools with industrial simulators, in order to enable model updating and to facilitate the implementation of the results. This is all the more restrictive because the simulators also suffer from increasing complexity, involving a drift of the computational costs which is hardly compatible with the number of simulations required by the identification procedure. Another major concern arises from the will to automate and systematize the test processing, in order to reduce its duration and to facilitate its progress. Indeed, the whole set of available flight tests represents a huge

amount of data and hence some semi-manual steps of the process are especially tedious for the engineers responsible for sifting through the data. Automation also enables a global and joint processing of many tests, as well as the gradual introduction of new tests as they become available. For the flutter analysis of flexible A/C, a near real-time processing is considered to open the flight envelope and again it results in strong constraints on the performances and the features of the tools to be developed.

On the other hand, the accuracy of the estimates issued from the identification algorithms is highly dependent on the frequency content of the input signals used to excite the system, in addition to the quality of the measurements which can be degraded by several types of errors (incorrect alignments, drifts, delays, calibration errors, etc.) superimposed on the usual noises and external disturbances (wind, turbulence). Even if the signal-to-noise ratio is satisfactory, an improvement can be achieved by taking advantage of the redundancy that usually exists between some of the available measurements (especially with aircraft instrumented for flight testing). Regarding the excitation signals, the common idea consists in looking for optimal inputs permitting the estimation accuracy to be improved, this optimization taking place by considering either single tests or multiple tests. This question can also be extended to minimizing the signals length while keeping a given level of accuracy, or even generalized to other types of criteria.

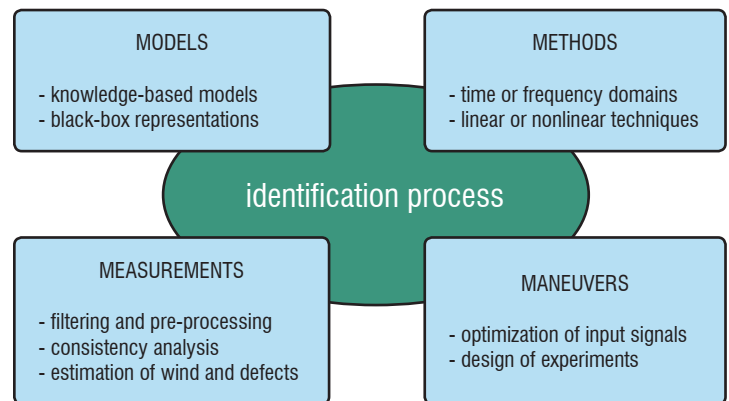

Figure 1 – Identification process and the *Quad-M* basics

To sum up, it appears that identification in aeronautics calls for various skills: flight mechanics, aerodynamics, structural dynamics, signal processing, estimation and optimization techniques. Their combination is absolutely mandatory to obtain a relevant model, in fine. These various aspects are depicted by the scheme in figure 1, which stresses that the identification process is located at the meeting point of the *Quad-M* basics (*Maneuvers-Measurements-Models-Methods*) [14]. These will be detailed in the following sections and illustrated by a set of industrial applications resulting from Onera's activities in this field.

## State-of-the-art and industrial context at Onera

Owing to its positioning and to its mission, Onera plays an intermediate role between academy and its main industrial partners. Within the framework of identification, as in others domains, this role presupposes that new promising methods will be investigated, adapted and transposed whenever necessary, and will finally be

evaluated through aeronautical applications. Since the early historical works of Landau [10], De Larminat [8] and Richalet *et al.* [51,55] in the seventies, the academic research in this domain has been active in France. Without claiming to be exhaustive in any way, several university specialists, such as E. Walter [75] and A. Benveniste [45] contributed especially to developing and promoting new techniques. In Europe, the Delft University of Technology also became renowned in the identification domain [50,72,74], as well as the Vrije Universiteit of Brussels [59] for modal estimation, without forgetting L. Ljung, one of the most famous European specialists in this topic [38]. With regard to aeronautical applications, the key players are obviously not so many; let us mention R. Jategaonkar at the DLR [24-26] and the E. Morelli/V. Klein [29,46-48] and R.E. Maine/K.W. Iliff pairs at NASA [41-43], two organizations that have a scientific scope and authority to perform activities similar to those of Onera.

System identification was a very first activity for the Systems Control and Flight Dynamics Department (DCSD) of Onera. DCSD has been developing and implementing identification techniques since the beginning of the seventies [31,32] in various application fields, such as: industrial processes, robotics, marine and aerial vehicles. It is noteworthy that some of these methods can benefit more than one domain and that advances can often be transposed to other applications. For instance, the experience gained and strengthened in the aeronautical domain through airplanes and helicopters has allowed DCSD to identify many warships and submarines from sea tests (linear and nonlinear models), as required by the synthesis of their control laws [15,17]. Parallel to the aeronautical sector, this activity has represented a major area of application for Onera from the beginning of the eighties since, for 25 years, the autopilots of most French submarines, frigates and aircraft carrier were studied and carried out by DCSD. Besides these historical works, which lie beyond Onera's usual scope, DCSD has been working with French aircraft manufacturers (Airbus and Dassault Aviation) on the whole spectrum of themes presented in the introduction, applying them through a succession of industrial programs: from the A320 to the A380, the Rafale, UAVs, etc. Let us mention very briefly:

- A close cooperation with the Flight Mechanics and Simulation Department of Airbus has been running without a break for about 30 years and has led to the implementation of several software in its identification tool unit for an operational use [37]. It is continuing nowadays through research programs aimed at improving the industrial process that allows the aerodynamic model to fit in the flight envelope as a whole. Indeed, the aerodynamic forces appear in the flight mechanics equations as nonlinear look-up tables depending on a number of variables (Mach number, angles of attack (AoA) and sideslip, configuration, dynamic pressure, etc.). Consequently, the identification task can be performed either within a linear (or weakly nonlinear) framework by processing only tests performed under similar flight conditions, or within a fully nonlinear framework by seeking to adjust the global modeling in an extended area of the flight domain.

- The transposition of some techniques developed for the civilian industry to military aircraft and drones was also considered a few years ago, during research programs involving Dassault Aviation. This work was intended to automate the industrial processes for identifying the models of new aircraft, a tedious task considering all of the load configurations. Appropriate techniques, suitable for dealing with unstable models (linear or nonlinear), were developed and evaluated from real flight data.

- The processing of the flight test campaign for flutter analysis is the subject of a cooperation with the Flight Tests Department of Airbus, which dates back to the mid-eighties and which has made

progress in successive stages through more and more ambitious goals [64-71]: SISO identification at first, then SIMO (Single Input-Multiple Outputs) implementation within the framework of the MEFAS project in the early 2000 s [57], and finally MIMO processing in the FIND project which is still underway. Hence, the real-time performance of DCSD approaches remains very competitive in comparison to other commercial products, such as the polyMAX method developed by the company LMS. As such, Onera was also involved in the European project FLITE2 which gathered many specialists in modal analysis (French, Belgian and Polish universities, laboratories), together with Airbus and Dassault Aviation. DCSD managed the working group TRAMPOLINE, which studied the continuous tracking of aeroelastic modes during the acceleration stages between two flight conditions.

## Input design and flight test optimization

### Off-line techniques

#### Flight test protocols

As numerical simulation becomes widely used in aeronautics, the requirements regarding the accuracy and reliability of the flight dynamics models are increasing. To improve the representativeness of the models, flight test protocols are thus designed and flown to adjust some relevant coefficients of the predicted aerodynamic model to the real aircraft. However, the permanent concern of building more accurate models in a shorter time leads to this identification process being revisited, by designing optimal inputs. Such an optimization belongs to the field of Experimental Design (ED), which is basically aimed at defining experiments suitable for the modeling purpose. In our context, an experimental protocol gathering several input signals can thus be mathematically represented as:

$$\Xi = \left\{ (N_T, u^i(t)) / N_T \in \mathcal{N}^*, i = 1 \dots N_T \text{ and } t \in [0, T_i] \right\} \quad (1)$$

In (1),  $N_T$  corresponds to the total number of aircraft flight test maneuvers considered for aerodynamic parameter estimation, and the index  $i$  denotes the current maneuver with time duration  $T_i$ . The input vector  $u^i(t)$  associated with the  $i^{\text{th}}$  flight test can be either a single or a multiple control surface input signal. Optimal ED can thus be performed on the basis of criteria that characterize the uncertainty in the model parameters to be estimated, denoted by  $\theta$ . Such cost functions depend on the estimator used to conduct the identification process. In particular, for any asymptotically unbiased and efficient estimator, a minimum achievable parameter standard deviation, also called Cramer-Rao lower bound [41], can be computed for each component of the vector  $\theta$ . The problem of ED can thus be formulated as follows:

$$\begin{aligned} \text{Given : } \Xi &= \left\{ (N_T, u^i(t)) / N_T \in \mathcal{N}^*, i = 1 \dots N_T \text{ and } t \in [0, T_i] \right\} \\ \text{Find : } \Xi^* &= (u^1(t) \quad \dots \quad u^i(t) \quad \dots \quad u^{N_T}(t))^* = \underset{\Xi}{\text{argopt}}(J(\Xi)) \\ \text{Subject to : } \forall i &= 1 \dots N_T, \forall t \in [0, T_i] \quad \begin{cases} \forall j = 1 \dots n_u, \Gamma_j(u^i(t)) \leq \gamma_j(t) \\ \forall k = 1 \dots n_y, \Lambda_k(y^i(t)) \leq \lambda_k(t) \end{cases} \end{aligned} \quad (2)$$

In (2), integer  $n_u$  (resp.  $n_y$ ) corresponds to the number of non-linear constraints ( $\Gamma, \gamma$ ) (resp. ( $\Lambda, \lambda$ )) that the inputs (resp. outputs) must satisfy in the design process due to flight tests safety: inputs energy, A/C loads tolerance, sideslip angle limitations... In problem



statement (2), criterion  $J$  can take, among other possibilities, the form of a non-linear scalar function applied to the Fisher information matrix  $F$ , s.t.  $J(\Xi) = \Phi(F(\Xi, \theta)) \in \mathcal{R}$ .  $F$  is calculated from the matrix of the model output sensitivities  $S(t)$  to the parameter vector  $\theta$  s.t.:

$$F(\Xi, \hat{\theta}) = \sum_{i=1}^{N_T} \frac{1}{np(i)} \sum_{j=1}^{np(i)} S^T(t_j, u^i(t_j)) R^{-1} S(t_j, u^i(t_j))$$

where  $S(t_j) = \left. \frac{\partial y(t_j, u^i(t_j))}{\partial \theta} \right|_{\theta=\hat{\theta}}$  (3)

In (3),  $y(t)$  designates the outputs of the simulation model and the weighting factors  $np(i) \in \mathcal{N}^*$  the number of measurement points available per flight test.  $R$  is a diagonal weighting matrix. An illustrative and general class of functions  $\Phi$  is given by the following family ( $k \in \mathcal{N}^*$ ):

$$\Phi_k(F(\Xi, \theta)) = \left[ \frac{1}{p} \text{trace} (QF^{-1}(\Xi, \theta)Q^T)^k \right]^{\frac{1}{k}}$$

if  $\det(F(\Xi, \theta)) \neq 0$  ( $+\infty$  otherwise) (4)

where  $Q$  is also a weighting matrix. Other examples based on the mathematical notions introduced in equation (3) and commonly used in the literature are given by:

- $\text{trace}(F)$  which represents the amount of information available through the set of flight tests, but does not take into account the possible correlations between the effects;
- $\log(\det(F))$  which is indicative of the global sensitivities of model outputs towards the aerodynamic parameters, collected for a given set of flight tests. Inputs that maximize this scalar norm are called D-optimal;
- $\text{trace}(F^{-1})$  which is equal to the sum of the variances of the parameter estimation errors. Inputs that minimize this criterion are called A-optimal;
- $\lambda_{\max}$  of  $F^{-1}$  which is equal to the maximum radius of the uncertainty ellipsoid. Inputs that minimize the greater eigenvalue of the dispersion matrix are called E-optimal.

As shown in (3)-(4), the objective function depends on  $\theta$  which are unknown parameters. More general mathematical formulations (e.g., based on the expectation) can be used to introduce some given uncertainties on these parameter values. More details are available in [75] (see robust optimal experiment design). When the number of experiments  $N_T$  is fixed *a priori*, the ED formulation (2) is reduced to an Optimal Input Design (OID) issue, which is unfortunately an infinite dimensional problem since  $U = \{u^i(t)/i = 1 \dots N_T\}$  are functional decision variables. Consequently, solving OID requires an approximation by a finite dimensional problem using a non-linear programming approach. Input signals  $U$  of  $\Xi$  are thus parameterized in order to conduct a non-linear optimization. Despite this approximation, the resulting OID problem remains difficult to solve due to its global feature. Indeed, several approaches corresponding to various levels of complexity exist to tackle issue formulation (2). For instance, the OID problem can be solved on the basis of a single flight test ( $N_T = 1$ ), for which an optimal scalar input signal, applied to only one A/C control surface, is desired ( $\dim(u^1)^* = 1$ ). On the contrary, the same issue can be tackled globally, considering a set of flight tests ( $N_T > 1$ ) composed of both mono and multi-dimensional input vectors, which results in a problem that is far more complex to solve than the previous one.

The state of the art in the field of OID dedicated to parameter estimation points out the Time Domain (TD) methodology developed by Klein/

Morelli, which applies the principles of dynamic programming (see [46-48]), as the main contribution. A literature review shows that other methods exist, such as the minimum flight test length via optimal inputs developed by Chen, which applies the principles of the time-optimal control theory [5]; let us also quote the FD OID methodologies initially set by Mehra [44], and then generalized by Mulder [50], in which input signals are parameterized from a predefined basis of orthonormal functions. Yet, none of these seems fully suitable for tackling and solving the OID problem (2) in its entirety (i.e. multiple flight tests with multidimensional input signals). This observation has motivated the development of new methodologies based on the theoretical principles of Evolutionary Computation (EC) to solve formulation (2) in various frameworks (single/multiple input signals for single/multiple experiments). The optimization techniques used correspond to original adaptations of the genetic and particle swarm optimization algorithms, for handling both continuous and discrete decision variables. Theoretical details of these methods are available in [60,61]. Among other capabilities, the resulting OID algorithms permit *a priori* information, defined through usual reference flight tests so that expert know-how can be preserved for flight dynamics identification, to be integrated into the optimization process. The results obtained show promising gains in both the global flight test duration and the accuracy of the estimated parameter. ED and OID methodologies are now entered into a phase of validation in flight. A series of flight tests has been flown to validate the theoretical results obtained in simulation. The objective is to prove that this kind of new input signals is able to provide at least the same level of parameter accuracy as in the usual flight test protocols, while significantly reducing the overall length of the flight tests. Video 1 illustrates a typical example of optimized input signals, simulated on an AIRBUS A340/300 and used for the identification of the lateral flight dynamics.

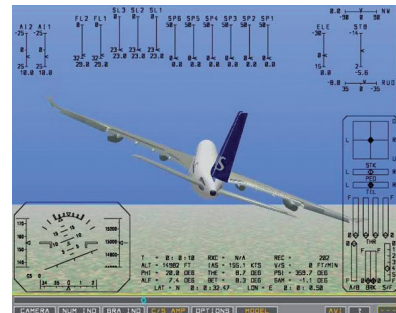

Video 1- Optimization of input signals for an A340/300

Video - <http://www.aerospacelab-journal.org/al4/relevant-issues-for-aircraft-model-identification>

### Definition of excitation signals for aeroelastic mode estimation

Flutter is a divergent aeroelastic phenomenon, usually resulting from a coupling between flexible modes. Hence, it is mandatory for certification to prove that the aircraft is free from flutter throughout the flight domain. For this purpose, the flight test strategy consists in applying excitations to the aircraft structure by means of the control surfaces, at stabilized flight conditions (constant speed and Mach number). Acceleration measurements are then used to analyze the evolution of aeroelastic modes. Clearance for the next flight condition is given if it is satisfactory and safe. Flutter tests are usually performed by using two types of excitation signals: sine sweeps and pulses. The former provides a good excitation level over a prescribed frequency range, but it is also very time-consuming (nearly 120 s long). For this reason, pulse excitation signals (see figure 2) are preferred nowadays, since they result in shorter duration tests (the useful response is usually 10 s or 15 s long).

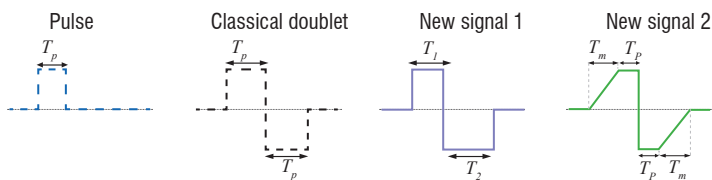

Figure 2 – Shape of classical vs. innovative excitation signals

However, the excitation level provided by this kind of signal is lower than that provided by sine sweeps, and the frequency range is also limited. Research has been performed at Onera for defining better excitation signals. Two innovative orientations were studied in order to improve the quality of the modal analysis and to reduce the test duration in the meantime.

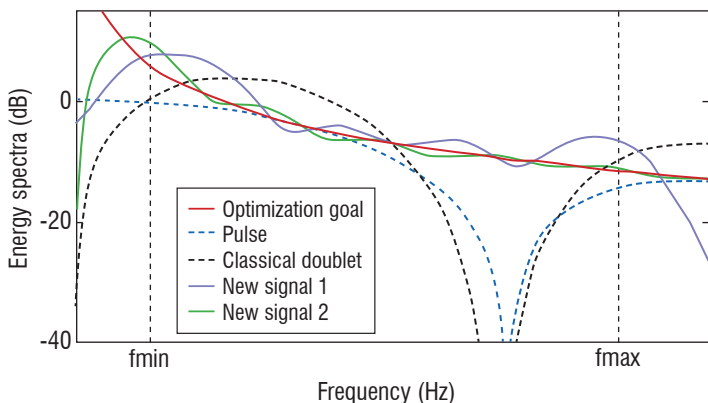
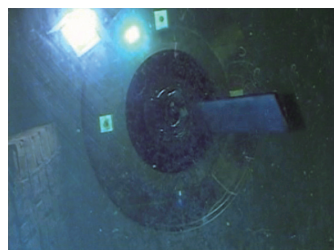

Figure 3 – Spectral comparison of classical and innovative excitation signals

A first approach deals with the distribution of the excitation signal through the control surfaces. Instead of applying signals through pairs of control surfaces, the idea is to combine the excitations applied to the whole set of control surfaces at the same time. Thus, more energy is introduced into the structure. The deflections of the surfaces are also coordinated, so as to excite the A/C modes more efficiently [22,70]. A second approach focuses on the design of more efficient excitation signals. The objective is to devise signals as simple as possible, with a duration comparable to pulses but with an improved frequency content [71]. This is illustrated in figure 3, where the spectra of the 4 excitation signals plotted in figure 2 are depicted. We can notice a gap in the spectra of the conventional and pulse doublet. Conversely, the 2 new signals proposed do not present any weaknesses in the whole frequency band of interest.

### On-line techniques

In 2002, Onera launched an internal research program called REMANTA (*REsearch program on Micro Aerial vehicle and New Technologies Application*) on biologically-inspired Micro Air Vehicles [40], which was aimed at improving scientific and technical knowledge in several topics, such as unsteady aerodynamics, actuation, structural dynamics and control. In order to gain a better understanding of specific unstationary aerodynamic phenomena at low Reynolds numbers, experimental tests were carried out in the Onera/DAAP hydrodynamic tank, with a scaled wing model flapping in water, in order to maintain the Reynolds similitude (see video 2).



Video 2 - Experiments in a hydrodynamic tank

Video - <http://www.aerospacelab-journal.org/al4/relevant-issues-for-aircraft-model-identification>

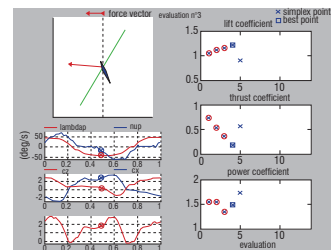

Video 3 - Optimization of wing motion

Video - <http://www.aerospacelab-journal.org/al4/relevant-issues-for-aircraft-model-identification>

A specific experimental set-up was designed to analyze hovering flight which requires large angular motions, and an innovative on-line optimization process was proposed to seek efficient wing kinematics without needing a preliminary identification of the flight dynamics model [54]. The experiment consists in a rigid up-scaled wing and in a mechanism including two independent servo-controlled motors to control the flapping and pitching motions. The search for efficient wing kinematics consists in an optimal input design problem with the experimental set-up in the loop. A parameter optimization technique was implemented to determine the shapes of a periodic wing motion maximizing the performance criteria computed from force balance measurements (figure 4).

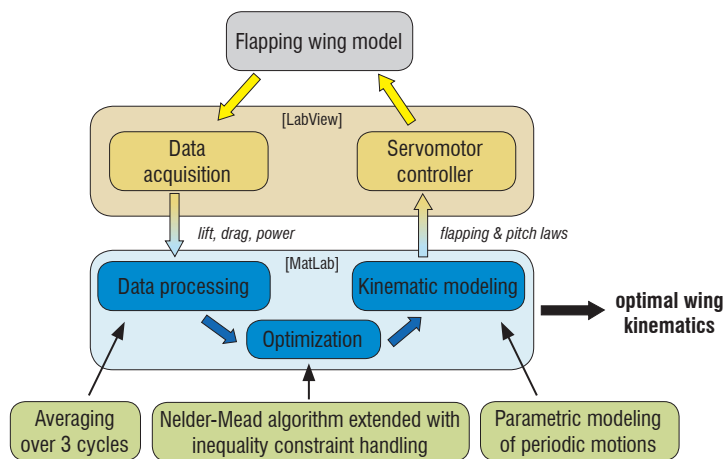

Figure 4 – On-line optimization process of wing kinematics

The two periodic laws involved in wing motions have been modeled in a parametric form, chosen to represent various wing kinematics observed in the literature review [53], with a limited number of parameters (figure 5).

The flapping model consists of four 3<sup>rd</sup> order polynomial arcs. Signal shape is defined by  $tb$  and  $pb$  values. The duty cycle parameter  $rb$  can be modified to deliver dissymmetrical signals. The adjustment of only one parameter facilitates the reproduction of periodic functions continuously varying from square to triangular shapes, as well as cosine functions. The pitch motion model involves 3 parameters. Mathematical functions were established to reproduce insect wing kinematics, which corresponds to a nearly constant incidence during wing stroke [54].

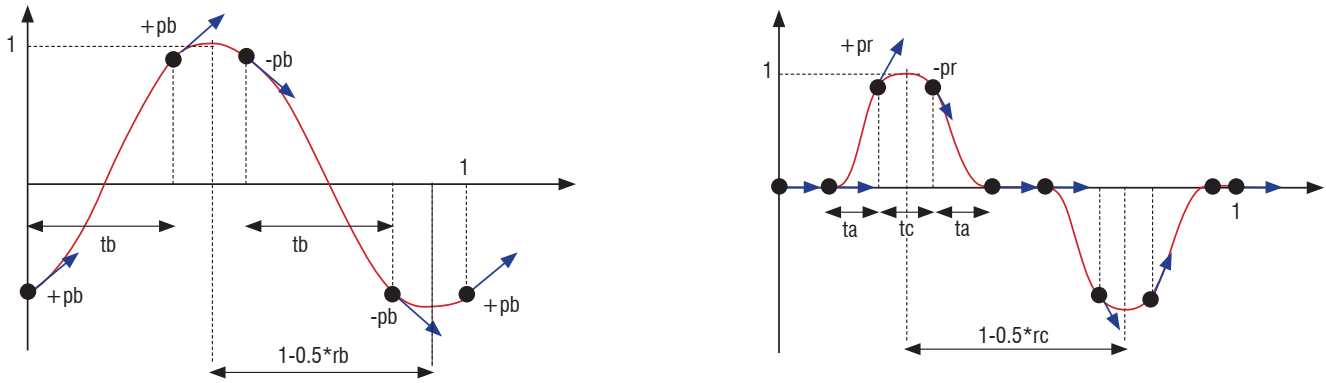

Figure 5 – Modeling of flapping angle (left) and pitching rate (right)

A direct search method based on the Nelder-Mead algorithm was implemented to optimize the parameters of the flapping laws. This algorithm, which does not require gradient evaluation, is well suited to avoid the effects of measurement noise on the approximation of gradients by finite-difference [2]. This method, which is an extension of the original simplex method, is based on a comparison of the criteria at the vertices of a simplex. The algorithm combines three geometric operations (reflection, expansion and contraction) in order to construct a new simplex in a favorable direction. This is a simple, intuitive and relatively stable method that is used in various domains and is renowned as a computationally efficient algorithm to minimize noisy unconstrained functions. The algorithm requires the choice of an initial point, which was set here to kinematics optimized by using an *a priori* simulation model. Classical convergence criteria have been supplemented with detection of simplex degeneracy. The original algorithm was extended to handle bounded parameters and nonlinear inequality constraints. Constraints are accounted for by an adaptive penalization approach and a technique robust to the initialization of the penalty parameters.

- pitch shape with a sine flapping in a horizontal stroke plane, in order to maximize the mean lift coefficient;
- flapping and pitch shapes in a horizontal stroke plane, to minimize the mean power for a minimum mean lift coefficient;
- pitch shape with a sine flapping in an inclined stroke plane, to maximize the mean lift coefficient (see video3).

The preliminary analysis of the test results shows a fast convergence of the iterative optimization process and an optimal kinematics shape close to those obtained with the *a priori* simulation model. Hydrodynamic force measurements were analyzed to improve the reliability of the simulation model, based on a simplified aerodynamic model consisting of a single-element model. Adjustments to the lift gradient coefficient, and to the location of the reference point on the wing chord used for the computation of the local AoA, lead to a good match for instant lift forces over a complete cycle. Figure 6 presents the contribution of separate components of the aerodynamic model (from green, to cyan, to blue colors). In the same way, the aerodynamic moments resulting from the global forces applied to the aerodynamic center match well with the time history of the three components (figure 7). Further experimental tests should be performed to complete the validation of this on-line optimization process, with more complex wing kinematics and multi-objective optimization methods, for hovering and forward flight.

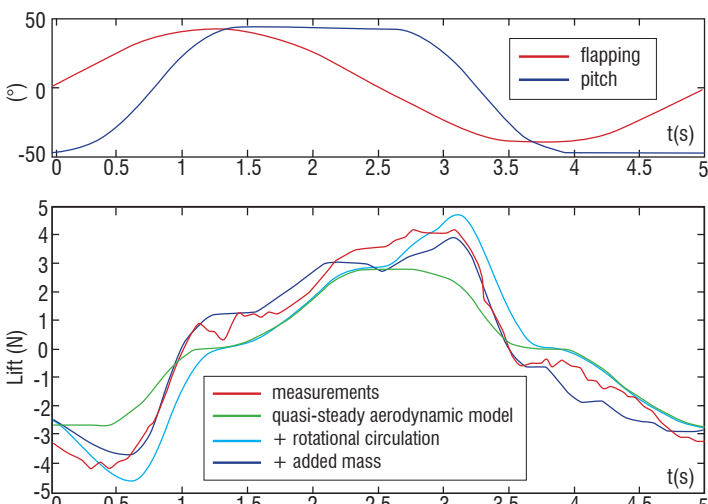

Figure 6 – Time history of computed and experimental forces

During the first test program, a restricted set of parameters was tuned in several configurations, resulting in the optimization of:

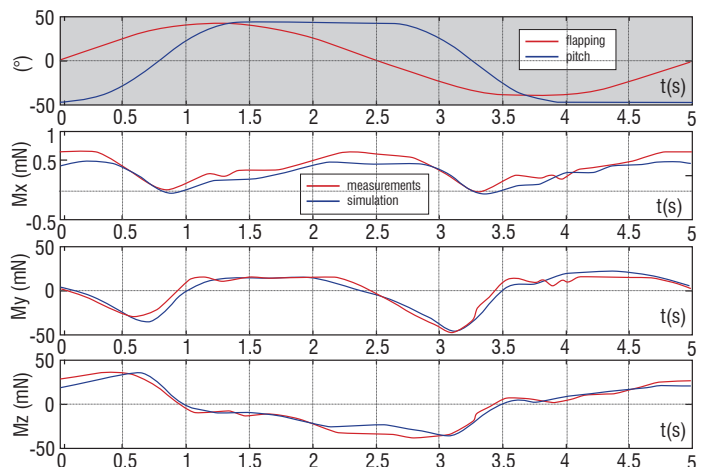

Figure 7 – Time history of computed and experimental moments

# Data Pre-Processing And Consistency Analysis

## Consistency analysis

The development of a new airplane involves a series of flight tests intended to update and validate the aircraft model, especially used for flight control design and for training simulators. The goal of these tests is to ensure an accurate representation of the aircraft behavior over its whole flight envelope, but also in ground to flight transitions. The accuracy of the updated model strongly depends on the quality and consistency of the measurements recorded during the flight tests. This data often contains deficiencies such as biases, time delays and air data calibration errors, which must be estimated before undertaking the A/C identification process. Furthermore, wind components can only be partially reconstructed from the comparison between ground speed and air speed measurements. Accurate and reliable measurements of ground velocities are achievable by using DGPS devices. On the other hand, air data information is corrupted, especially in ground effects, by aerodynamic disturbances that are only partially corrected by calibration laws.

With the aim of achieving a systematic check of data consistency, a set of estimation tools based on KF and Rauch smoothing techniques has been developed by DCSD. These tools are designed from simple physical models (kinematics, atmosphere), independent from the aircraft modeling which is not accurate as yet at this stage. Experience has proven that an incomplete or imperfect modeling can induce disturbances in a set of variables and moreover can complicate the interpretation of anomalies. To avoid these drawbacks, a multistep checking process has been developed on the basis of models of increasing complexity. This multistep procedure enables an easy detection and localization of some unexpected errors, for example the reference position of the velocity measurements. Flight data analysis is performed in three stages, involving a consistency checking of:

- Angular data: This estimator is also relevant for estimating the angular accelerations, which are useful to update the aircraft model thanks to an equation error approach (EE);
- Ground speed: DGPS velocities are compared to the velocities resulting from the integration of the accelerometers and previously validated angular measurements;
- Air data: Wind is estimated from the difference between the ground and air velocities.

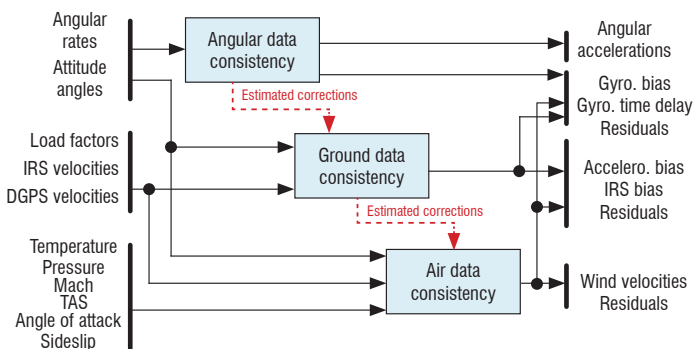

Figure 8 – Block diagram of flight test data checking

In this process, which is outlined in figure 8, the inputs of the three estimators always consist of raw measurements. Only the error parameters are propagated from one step to the next. At the end of the KF, results are processed backward in time by a Rauch smoothing algorithm, to improve the estimation accuracy and to estimate the initial state. Smoothing residuals are also computed to check the proper adjustment of the Kalman error models *a posteriori*. Based on this

residual computation, an iterative technique was implemented for an automatic adjustment of the variances of process and measurement noises. This method is aimed at satisfying the agreement between theoretical and experimental variances of the residuals. This tool was also extended to air data reconstruction at low speeds in ground effects. The introduction of variable measurement error variances along the flight path enables some aerodynamic disturbances to be compensated for in AoA measurements during takeoff phases.

Figure 9 shows a typical result of corrections for the AoA. The validity of clinometric air data is limited below 25 m/s, due to losses in sensor sensitivity. Moreover, these measurements are forced to zero below 5 m/s. Wind components are held constant at their latest value estimated during smoothing with the air data nominal accuracy. During the first seconds of climb, the vertical wind component computed from raw AoA measurements shows unlikely variations, which are mitigated by the KF with non-stationary noise covariances. To sum up, consistency checking is an important part of flight test data processing prior to aircraft modeling. It provides an estimate of the sensor errors and of unmeasured or poorly measured variables, and thus can help to save a lot of time during the following modeling tasks.

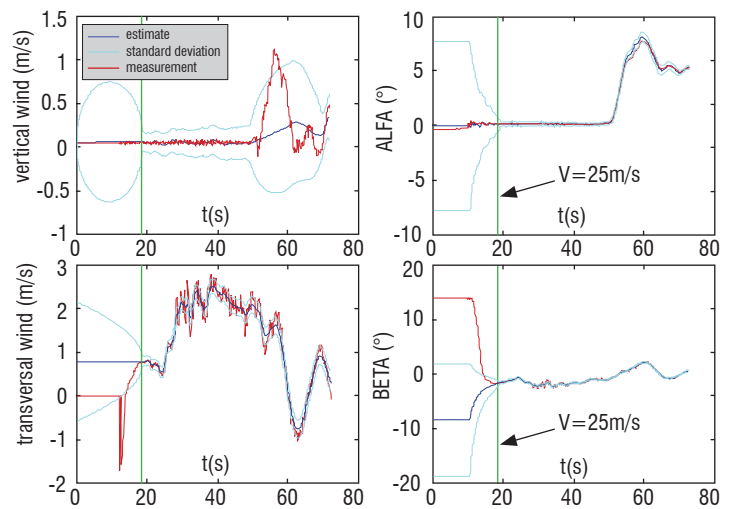

Figure 9 – Air data reconstruction for a take-off test

## New estimation techniques: particle and Sigma-point Kalman filters

A necessary step for modeling, identification or fault diagnosis often consists in fully reconstructing the system state. In aeronautical applications, the A/C state is only partially measured and the reconstruction of the full state involves a classical state estimation task. Two kinds of state estimation can be distinguished, depending on whether the application should run on-line or not. In this section devoted to flight tests processing, only off-line applications are considered.

The Extended Kalman filter (EKF), supplemented by a Rauch smoothing algorithm, is the most widely used method taking into account nonlinear models with uncertainties or unknown inputs. It is implemented by linearizing the nonlinear models about the current estimate. Such a numerical technique using finite differences can raise practical problems with strong nonlinearities of the aerodynamic model at high angles of attack. Recent approaches address the model linearization issues of the EKF with approximations of the probability density of the estimated state  $x_k$  (at time  $k$ ). Some of these represent this probability distribution by a minimal set of  $N_p$  weighted sample points (given the measurements  $z_{1:k} = (z_1, \dots, z_k)$ ):



$$p(x_k / z_{1:k}) \approx \sum_{i=1}^{N_p} W_k^{(i)} \delta(x_k - \chi_{k/k}^{(i)}) \quad (5)$$

with  $\sum_{i=1}^{N_p} W_k^{(i)} = 1$  and  $W_k^{(i)} \geq 0 \quad (\forall i)$

where  $W_k^{(i)}$  is the weight associated to the sample point  $\chi_{k/k}^{(i)}$  and  $\delta(\cdot)$  is the delta Dirac density. For instance, the Unscented Kalman Filter (UKF) selects the sample points (also called Sigma Points) by deterministic methods in order to match the mean and covariance of the true probability density [27]. These sigma points are then propagated through the nonlinear function. An augmented formulation of this algorithm is able to propagate state and measurement noises through model nonlinearities. Specific implementations such as square-root or UDU UKF can improve the numerical stability for sigma point computations. Moreover, the use of sigma points can be generalized to solve the smoothing problem [58] and to compute measurement and state residues. In the same vein, the particle filters [1] consist in iteratively updating an approximate description of the filtered distribution  $p(x_k / z_{1:k})$  (figure 10). This description requires a set of random samples (or particles) with associated weights. As the number of samples becomes very large, this Monte-Carlo characterization is more accurate. Then the key point consists in a recursive propagation of the weights and support points when new measurements are obtained.

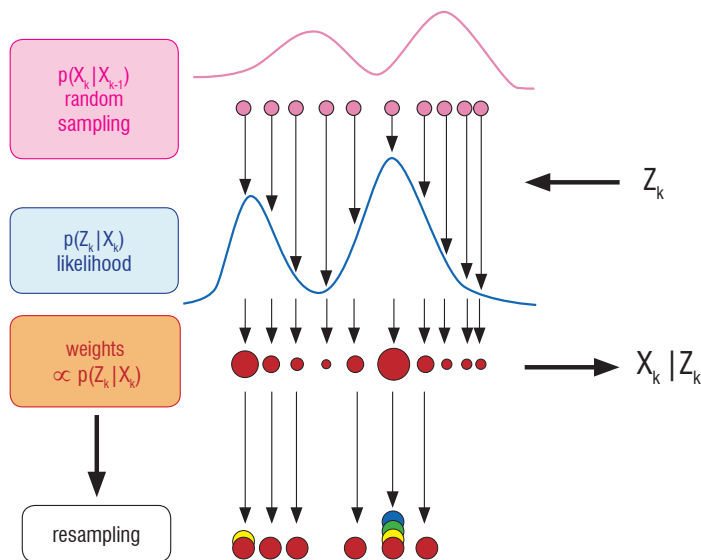

Figure 10 – Principles of particle filtering algorithms

Again, various versions of particle filter algorithms depend on a *priori* choices (like the resampling method, etc.) and attempt to counteract the difficulties encountered with the simplest version. The best example is the *Rao-Blackwellized* particle filter (also called marginalized particle filter [7]) which exploits the presence of a linear Gaussian substructure in the state equation. Thus, the corresponding linear components of the state can be optimally estimated by a KF. The resulting filter combines a particle filter for the estimation of the nonlinear components with a classical KF for updating the particles in the linear state space. This procedure is worthwhile on two accounts: it reduces the particle number as well as the variance of the estimation error. Other EKF alternatives approximate the filtered density with a weighted sum of Gaussian densities:

$$p(x_k / z_{1:k}) \approx \sum_{i=1}^{N_p} W_k^{(i)} N(\hat{x}_{k/k}^{(i)}, P_{k/k}^{(i)})$$

with  $\sum_{i=1}^{N_p} W_k^{(i)} = 1$  and  $W_k^{(i)} \geq 0 \quad (\forall i)$

Such methods (called Gaussian Mixture Filters [30]) do not need sampling techniques, as is the case with particle filters. At each iteration, the number of Gaussian densities used for the *a priori* density is multiplied by the number of Gaussian densities used for the noise models. In order to avoid an exponential increase of Gaussian densities, an elimination mechanism of the low weight components is added to the algorithm.

Among the various situations of interest, the estimation of delays was retained to evaluate these new estimation methods. Indeed, the recording systems for in-flight data acquisition rarely perform a synchronous sampling of all measurements. This is the reason why differential delays exist between some measurement subsets. The estimation of these delays involves a strongly nonlinear filtering problem. This is noticeable with the EKF, which suffers from its linearization step, whereas the UKF gives a more accurate estimation of the input delays. This application is a good illustration of the UKF ability to take strong nonlinearities into account. Similarly the *Rao-Blackwellized* version of the particle filter offers a good compromise between the accuracy of the estimates and the number of required particles.

Another interesting application comes from sensor fault detection. For instance, local measurements of airflow characteristics, performed by anemo-clinometric sensors, often produce errors that are difficult to model. Corrections are applied to provide the modulus and direction of the aerodynamic velocity. Despite these corrections, some undesirable effects (such ground effects, etc.) are not cancelled. Literature reports few approaches dedicated to sensor fault detection and non-stationary noises, which are interesting to test through this specific example. Amongst the various tested approaches, the *Rao-Blackwellized* particle filter and the stochastic M algorithm (combining the pros of the particle and Mixture Gaussian filters [76]) offer a better performance.

## Identification techniques

### Identification in the time domain

The equations of motion of a rigid body A/C are derived from the fundamental principles of classical mechanics. The external forces involved in these equations are the propulsion and aerodynamic forces, and gravitational attraction. The uncertainties in this model mostly concern the aerodynamic effects. Consequently, the fitting of the aerodynamic model within the whole flight envelope is the main purpose of the identification process.

### Parameter identification methods

#### Equation Error type approaches

Since EE methods are mostly applied to Linear-in-their-Parameters (LP) models (*i.e.* linear with respect to the parameters to be identified), only this type of model is considered in this section. An extension to the nonlinear case will be considered afterwards. Therefore, the model obeys:

$$Z = \Phi \theta + \varepsilon \quad (6)$$

where  $Z$  is a  $(N \times I)$  vector gathering all measurements,  $\Phi$  is the  $(N \times n_\theta)$  regression matrix, and  $\theta$  is the  $(n_\theta \times I)$  vector of parameters to be identified. Therefore,  $\varepsilon$  is the  $(N \times I)$  vector of errors and  $N$  is the total number of available samples. The columns of  $\Phi$  are called the regressors and are assumed to be linearly independent (*i.e.*  $\text{rank}(\Phi) = \text{dim}(\theta) = n_\theta$ ). In addition, the model structure is supposed to be fixed and known *a priori*, because it results from Lagrangian equations, Newton's law, Ohm's law or Maxwell equations.

In aeronautics, this method is commonly used to estimate the linear coefficients involved in the analytical expression of aerodynamic developments and, more generally, as a preliminary step in the identification process. As an example, let us consider the following linearized lift modeling,  $Cz = Cz_0 + Cz_\alpha \alpha + Cz_q \bar{q} + Cz_{\delta_e} \delta_e$ , where  $Cz_0, Cz_\alpha, Cz_q, Cz_{\delta_e}$  are the stability and control derivatives to be estimated,  $\alpha$  is the AoA,  $\bar{q}$  is the adimensional pitch rate and  $\delta_e$  the elevator angle. This model is LP since we can write (at sample  $k$ ):

$$Z_k = Cz(k), \Phi_k = [1 \quad \alpha(k) \quad \bar{q}(k) \quad \delta_e(k)] \quad (7)$$

and  $\theta = [Cz_0 \quad Cz_\alpha \quad Cz_q \quad Cz_{\delta_e}]^T$

Since values like  $Cz$  are not directly sensed, this approach at first requires these global aerodynamic coefficients, which constitute the pseudo-measurements of the model to be identified, to be reconstructed. Hence, they are computed from the linear and angular accelerations, which are measured or derived from the flight test instrumentation. Keeping the z-axis example, this is achieved by inverting the flight mechanics equation  $mg n_z = -(F_z^{aero} + T_z^{eng})$ , where  $n_z$  is the normal load factor computed from the accelerometers,  $T_z^{eng}$  is the normal component of the engine thrust and  $F_z^{aero}$  is the normal aerodynamic force permitting the previous  $Cz$  to be computed *in fine*. Practically, the measured input variables used in this process are corrupted by noises and calibration errors, especially in the case of air data. To reduce the impact of these errors, which can result for example in a correlation between  $\Phi$  and  $\varepsilon$ , a KF technique is relevant to estimate A/C state variables and aerodynamic coefficients jointly (see figure 18).

Usually, the vector  $\theta$  is identified with the well-known Ordinary Least Squares (OLS) technique, which minimizes the following criterion:  $J(\theta) = \|\varepsilon\|_2^2$ . The OLS solution is then given by:

$$\hat{\theta}_{LS} = (\Phi^T \Phi)^{-1} \Phi^T Z \quad (8)$$

In most cases, OLS is not statistically efficient, and the Weighted Least Squares (WLS) technique is often preferred to OLS. For this purpose, a  $(N \times N)$  weighting matrix  $\Omega$  is introduced and the WLS solution is then given by:

$$\hat{\theta}_{WLS} = (\Phi^T \Omega \Phi)^{-1} \Phi^T \Omega Z \quad (9)$$

LS techniques are easy to use and were successfully validated through several application fields such as robots, motors, cars, compactors and aircraft (see for example [12,28,36,73]). However, LS techniques provide consistent results if and only if the observation matrix  $\Phi$  is statistically not correlated with the error vector  $\varepsilon$  (*i.e.*  $E(\Phi^T \varepsilon) = 0$ ). This is the reason why LS techniques are often coupled with an appropriate data filtering to make the regression matrix  $\Phi$  practically deterministic. However, as pointed out in many papers, it cannot be proven that LS estimation is consistent without additional information [6,11,63]. Consequently, techniques dealing with a noisy observation matrix have been studied. One among others is the Instrumental Variable (IV) method. The idea consists in introducing an instrumental matrix  $(N \times n_\theta)$

denoted as  $V$  and pre-multiplying the two members of (6) by  $V^T$ ; with the strong assumptions that  $E(V^T \varepsilon) = 0$  and  $V^T \Phi$  is invertible, the IV estimation is thus given by:

$$\hat{\theta}_{IV} = (V^T \Phi)^{-1} V^T Z \quad (10)$$

The major problem is of course to find valid instruments. The best choice consists in building the instrumental matrix from simulated data. This choice is particularly suitable for physical systems [77]. Though the IV technique has been studied in many papers, there are only a few real world applications. Nevertheless, this technique has been recently extended to robots with excellent results [23].

### Output Error and Filter Error type approaches

The output error (OE) method is probably the most widely applied method to parameter estimation for aircraft models. The principle is again very simple: A/C model parameters (aerodynamic derivatives, state and output biases, initial conditions) are fitted in order to minimize the following cost function:

$$J(\theta) = \frac{1}{2} \sum_{k=1}^N [z_k - y_k]^T R^{-1} [z_k - y_k] \quad \{ + N \log[\det(R)] / 2 \} \quad (11)$$

where  $y$  represents the vector of  $n_y$  model outputs,  $z$  the  $(n_y \times I)$  measurement vector,  $N$  is the number of samples and  $R$  is the covariance matrix of the measurement noises. Solving this optimization problem according to the ML principle also allows  $R$  to be estimated with a relaxation strategy [29]. In practice, the diagonal elements of  $R$  are often adjusted by the user, to balance the output contributions according to the measurement accuracy (and the last term of (11) is dropped). It is worth noting that the principle of the OE method assumes that the control deflections used to simulate the A/C model behavior are noise free. In addition, for more than 30 years, it has been proven that the variance of the parameter estimates can be computed at the same time, an approximation being provided by the Cramer-Rao lower bounds (see *e.g.* [41]). However, an imperfect knowledge of the aerodynamic model structure can result in a degradation of the parameter accuracy, resulting in a spread of the aerodynamic derivatives dependent on the flight conditions. In this case, the uncertainties evaluated via the Cramer-Rao bounds do not account for these errors. Moreover, the processing of flight tests performed in the presence of turbulence can also lead to an increase in the parameter scattering.

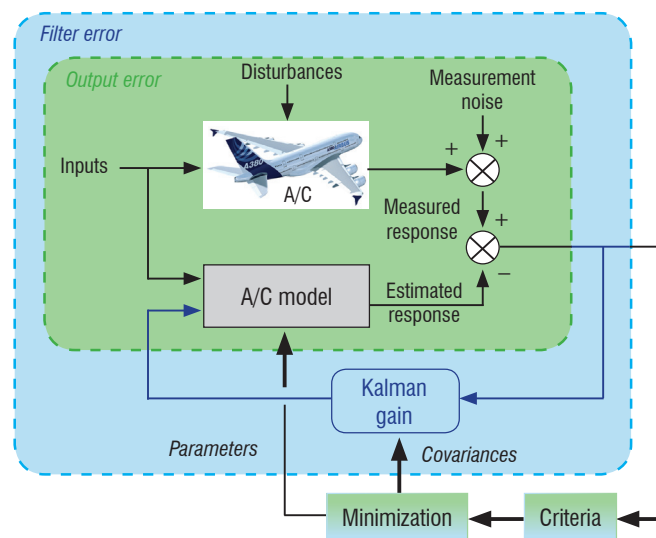

Figure 11 – Block diagram of OE/FE methods

Owing to these problems, the ML principle allows the OE approach [41] to be generalized. The previous two types of disturbances are then represented by process noises, which can be accounted for in a more general formulation called the filter error method (FE). This technique can be considered as an extension of the OE method and incorporates a state estimator, KF type (figure 11). Applied to parameter identification, the estimation, according to the ML principle, gives the parameter value that maximizes the probability of the measured data for a given set of parameters. The likelihood function is defined from the probability distribution  $p(Y/\theta)$  of the response  $Y = (y_1, \dots, y_N)$  as  $L(\theta) = p(Y/\theta)_{y=z}$ . Assuming a linear state space representation with Gaussian white noises for measurement and process equations, the ML estimate can be derived by minimizing the following cost:

$$J(\theta) = \frac{1}{2} \sum_{k=1}^N [z_k - y_k]^T S^{-1} [z_k - y_k] + N \log[\det(S)]/2 \quad (12)$$

where  $y$  corresponds, from now on, to the predicted observations resulting from the KF and  $S$  is the innovation covariance of the KF. In the most general formulation, this method can be used to estimate all the parameters, *i.e.*, the model parameters, the initial states and the covariance of process and measurement noises ( $Q$  and  $R$ ). Several formulations have been proposed for linear models, to solve the numerical and the convergence issues [42]:

- Natural formulation: the unknown variances (in  $Q$  and  $R$ ) are estimated, as well as the model parameters;
- Innovation formulation: the elements of the Kalman gain matrix are directly estimated, instead of noise variances, and the innovation covariance is experimentally estimated from the filtering residuals;
- Combined formulation: this algorithm takes the principle of natural formulation and replaces the computed innovation covariance by its estimate from measurements [42]. The computation of the Kalman gain is derived from a modified Riccati equation, which must be solved with an additional constraint to ensure the filter stability.

Extensions to nonlinear systems have also been derived, but implementations are often restricted to steady state filters, to limit the computational burden [24]. In practice, with nonlinear systems and measurements corrupted with non-white Gaussian noises, an estimation of both process and measurement variances is generally not achievable. However, the simultaneous estimation of aerodynamic model parameters and of (a limited number of) process noise variances can be considered thanks to the direct minimization of the likelihood function. The algorithm adjustment parameters are then limited to the elements of  $R$ , as is usually the case with the OE method.

Following this principle, an FE approach has been developed to identify a nonlinear aircraft model. It includes a nonlinear Kalman estimator, operated with a constant gain resulting from the resolution of an algebraic Riccati equation and requires a (numerically) linearized A/C model. The state estimator is implemented in a Gauss-Newton algorithm, a common optimization method for OE approaches. This 2<sup>nd</sup> order method is based on a local quadratic approximation of the Hessian matrix and only requires a computation of the output sensitivity derivative vector. An additional mechanism was implemented to decrease the step size of parameter changes automatically, if the criterion increases. The gradient computation has been extended to allow the optimization of the process noise covariance, which results in a non-quadratic formulation [13]. The corresponding estimated parameters are defined by the logarithms of the noise standard deviations. This change of variable cancels the sign constraints, and improves the convergence rate.

The simultaneous processing of multiple flight tests leads to defining a subset of parameters (*i.e.* aerodynamic coefficients) that are shared

by all tests and to cope with specific parameters, such as state and output biases, plus initial conditions, which must be adjusted for each experiment. Process noise variances can be globally defined for all the experiments, or separately processed. Output sensitivity derivatives are numerically estimated restricting the simulations to those required by the previous test-dependent parameters. Apart from accounting for process and measurement noises, this method offers several advantages compared to the OE approach: a faster convergence rate, fewer local minima, an improved convergence robustness to initial model errors and the possibility of identifying unstable models [25]. Regarding the latter, the gradual evolution towards new unstable A/C configurations can lead to difficulties in the use of the standard OE approach. Indeed, this technique involves an open-loop integration of the model, which may cause numerical divergence during the simulations. The state estimator implemented in the FE method has intrinsic stabilizing properties and is thus well suited for the identification of unstable models. Without process noise, the steady-state Kalman gain matrix is not null as it is with OE, but is rather a constant gain that shifts the unstable poles in the left half-plane.

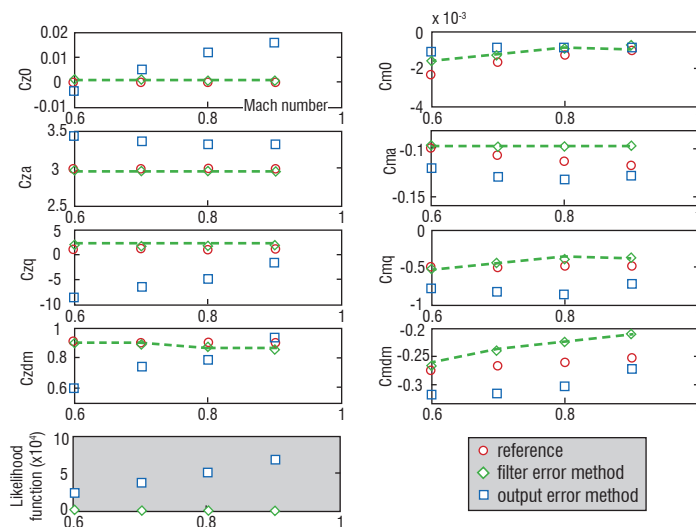

Figure 12 – Estimates of aerodynamic derivatives (FE vs. OE)

To illustrate this, some simulation results are presented in figure 12, to show the benefits of applying an FE approach to the identification of aerodynamic derivatives with a mismatched model. A linear aerodynamic model is estimated, whereas the reference simulation was performed with nonlinearities in the control derivatives. Each plot displays the variation of the aerodynamic derivatives with the Mach number. Coefficients estimated with the FE method match well with reference values, whereas several parameters delivered by the OE method exhibit a drift.

### Structure of the aerodynamic model

The aerodynamic coefficients are usually expressed as look-up tables or strongly nonlinear functions, depending on multiple parameters (configuration, Mach, AoA, sideslip, deflection angles). However, the parameter estimation can be tackled either in a linear or weakly nonlinear framework, by using only tests flown at close flight conditions, or in a strongly nonlinear framework by fitting the model directly into a large part of the flight envelope. The 6dof flight mechanics model is usually split into two largely independent sets of equations describing the longitudinal and the lateral-directional A/C motions. This way, the identification problem is reduced to two smaller problems, which are easier to solve. The main difficulties result from

the strong nonlinearities in the Mach number and AoA as far as the longitudinal axis is concerned, and from the roll-yaw coupling in the lateral case. EE-OE-FE minimizations can be used, depending on the context. Whatever the method, it is crucial for the aerodynamic corrections to remain physically acceptable.

### Weak nonlinearities

Usually, the identification process for the lateral-directional coefficients can be conducted by using flight tests flown with about the same configuration, Mach number, AoA and at low sideslip angles. The nonlinearities, which mainly depend on sideslip, do not act and the aerodynamic nonlinear effects come only from control surface efficiency. Either additive or multiplicative corrections can be estimated by minimizing the weighted errors between simulated outputs and A/C measurements. In addition, a smoothing constraint is generally applied to the efficiencies, in order to limit their fluctuations and to ensure the consistency of the corrections. Accordingly, a software package was developed by DCSD for identifying the lateral model of an aircraft and was used by Airbus for several programs from the A340 up to the A380 [37].

The aerodynamic model identification is based on aircraft-wide measurements and delivers global corrections for the aerodynamic coefficients. If the aerodynamic model is split into an aircraft with and without tailplane, as is the case with Airbus modeling, the question is raised regarding the distribution of the corrections among the various parts. A conceivable solution to this problem would consist in processing measurements that are sensitive to local effects, such as load measurements, besides standard flight parameters. The drawback is that this kind of measurements can be corrupted by a high level of noise. This idea was implemented to estimate the lateral-directional coefficients of an A340-600, in high-lift configuration, the additive measurements being restricted to fin loads sensed by strain gages. Among the split coefficients corresponding to an aircraft with and without vertical stabilizer (fin), only sideslip effects could be accurately identified.

### Neural and hybrid approaches

Techniques based on linear or weakly nonlinear models are efficiently used as a first step of the identification process. However, when a global model is sought, *i.e.*, a model that is valid throughout the flight domain and that includes all aircraft specific nonlinearities, appropriate approaches and techniques must be applied. The task is all the more complex because the nonlinearities are only available in the form of multivariate look-up tables, which are not very convenient for identification purposes. In industry, this global modeling is typically obtained after a long iterative process mainly based on EE algorithms, the result of which is highly dependent on the skill of the performing engineers. For that matter, DCSD has been developing a so-called *hybrid identification* approach for several years, which is aimed at proposing a more automatic processing of flight data. The ideal thing would be to tune all of the model parameters in a single step (linear and nonlinear ones) using all of the available test data; thus, the tools have been designed for that purpose. In practice, a sequential approach often remains useful.

Hybrid identification refers to the hybridization between classical linear approaches (in the TD) and specific methods intended to handle the model nonlinearities. The various methods classically used can be

implemented (EE, OE or FE algorithms) and this has been achieved through extensive algorithmic adaptations. As for the representation of the nonlinearities, the choice was made in favor of Neural Networks [21]. NN are commonly used as *surrogate models* to replace the system or the reference model when it is too complex or time consuming for achieving some tasks like optimization, parameter identification, etc. [62]. They are particularly well suited for modeling complex and unstructured nonlinear systems, whether static or dynamic [15,16]. In the hybrid approach, NN are typically used to replace the look-up tables describing the various nonlinearities of the aerodynamic model [39]. This allows an algorithmically efficient identification which, additionally, does not require *a priori* knowledge (*e.g.* the look-up index). This kind of implementation of NN is thus grey-box type and it preserves the physical meaning and structure of the aerodynamic developments. Let us provide an example of how NN are introduced in the model. The equation below shows a somewhat simplified description of an A/C pitching moment coefficient  $C_m$ , as it appears in longitudinal flight dynamic equations [3]:

$$C_m = S l P d \left[ \underbrace{C_{m_0}}_{f(M)} + (x_{cg} - x_F) \underbrace{C_{z_\alpha}}_{f(M)} \alpha + \underbrace{\eta_{NL}}_{f(Pd, M)} \underbrace{\Delta C_{m_{NL}}}_{f(\alpha, M)} + \dots \right] \quad (13)$$

where  $\alpha, M, S, l, P d$  are AoA, Mach number, reference area and length, and dynamic pressure respectively, whereas  $x_{cg}$  and  $x_F$  correspond to the longitudinal abscissae of mass and aerodynamic centers.  $C_{m_0}, x_F, C_{z_\alpha}, \Delta C_{m_{NL}}$  and  $\eta_{NL}$  represent aerodynamic and aeroelastic coefficients, which contribute to the global  $C_m$  and which can be replaced by neural modules to automate and improve the identification process.

Two options are available: either this time dependent coefficient is directly compared with its counterpart extracted from flight data throughout the sequence of tests available (EE), or it is integrated into the flight dynamic equations to allow a minimization between measured and simulated state variables (OE). Both methods benefit from of the analytical and differentiable formulations of NN, which make it possible to perform quasi-exact parameter optimization (unlike purely numerical approaches using finite differences). Much CPU time is also saved for the derivative estimates required by the sensitivity equations, which is quite valuable, especially for OE or FE approaches. The software developed by DCSD mainly relies on the use of local models, such as Radial Basis Function Networks (RBFN). As opposed to global models, such as Multi-Layered Perceptrons (MLP), local models keep the aerodynamic model readable and make it easier to perform identification from partial data relative only to portions of the flight domain [49]. The output  $\hat{y}_k$  predicted by a RBFN, *e.g.*  $\hat{C}_{z_\alpha}$  in (13), complies with the form:

$$\hat{y}_k = f(e_k) = \sum_{j=1}^m w_j \phi_j(e_k) \quad (14)$$

$$\text{with } \phi_j(e_k) = \exp\left[-\sum_{i=1}^n (e_k^i - c_{ji})^2 / \sigma_{ji}^2\right]$$

denoting  $e_k^i$  ( $\forall i \in [1, n]$ ) the value of the  $i^{th}$  explanatory variable for the  $k^{th}$  data sample (*i.e.*  $\alpha, P d$  or  $M$  in (13)), and assuming that  $\hat{y}_k$  is scalar, to simplify the writing. In the expression (14), the functions  $\phi_j$  are the nonlinear regressors, which allow internal parameters  $c_j$  (centers) and  $\sigma_j$  (radii) to appear by choosing Gaussian radial functions, a rather common choice (see figure 13 without dotted connections).  $w_j$  are the regression parameters also to be determined during the optimization process and  $m$  defines the number of regressors (*a priori* unknown).



## Box 1 - Local Linear Modeling via Neural Networks

A nonlinear model can be either linear, nonlinear or both in regard to its internal parameters. Within the framework of NNs, the latter case corresponds for example to the MLP [15], but also to the RBFN when the centers and radii of the radial units are optimized [16]. Clearly, this is the most general formulation since LP models are nothing but a special case and it is also the cause of NN theoretical properties as parsimonious approximators. However, the joint optimization of the whole set of model parameters (linear and nonlinear) practically results in ill-posed problems, which are likely to converge very slowly to solutions conveying the trade-off between performances and regularization. This is why LP models are always quite common practice, since more simple and robust algorithms can be adopted, driven from the classical methods in use for adapting linear regression parameters. Hence, by taking advantage of their features, we can proceed to structural identification, *i.e.*, to determine the best set of regressors from the available data.

To choose the regressors  $\phi_j$ , we will focus on methods based on forward selection, as opposed to other methods which consist in selecting a full set of candidate regressors at first, before removing the less relevant ones one by one (backward elimination). Forward selection starts with an empty subset and the regressors are added one at a time in order to gradually improve the results. Therefore, the final number of regressors is not known in advance and the computational cost is reduced since the regression size will become large only if it is required to reduce the modeling error. Forward selection is computationally efficient, but constructive algorithms can be sped up even further thanks to a preliminary orthogonalization process, making use of the famous Gram-Schmidt technique [19,20]. Moreover, this procedure allows the successive regressors to be decoupled from each other, and hence allows their individual contribution to be evaluated regardless of those already recruited for the modeling.

To implement this forward selection, two options are available: ① to first define an initial pool of candidate regressors from which the most relevant ones will be selected, ② to determine each regressor individually as the process goes on, which generally amounts to optimizing the kernel functions in the input space. Within class ① is the entire range of classical and direct methods that locate the regressor kernels quite arbitrarily: in a subset of the data samples, on the knots of a lattice derived from a gridding of the input space, by using data clustering or self-organization techniques. Class ② has to do with optimization techniques, but to avoid the problems inherent to classical methods (convergence, sensitivity to initial values) global optimization is favored, among which evolutionary algorithms have done particularly well for some years. Recently, a new metaheuristic also arising from biological inspiration (bird flocking or fish schooling) was imagined, known as Particle Swarm Optimization (PSO). The collective behavior of the particles looks like a swarm of living beings (*e.g.* bees): an individual discovering a good spot passes on the information to the others, which use it to direct their next moves. Therefore, the swarm represents a set of autonomous and interacting agents cooperating to solve a problem. The members of a group benefit from the accidental discoveries, as well as the experience acquired by other individuals. Similarly to the evolutionary case, the method is based on an iterative and stochastic process [20].

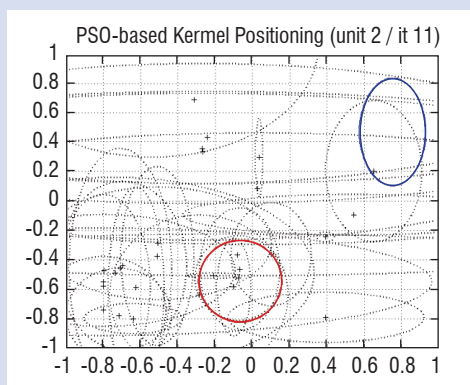

Video 4 - PSO-based kernel positioning

Video - <http://www.aerospacelab-journal.org/al4/relevant-issues-for-aircraft-model-identification>

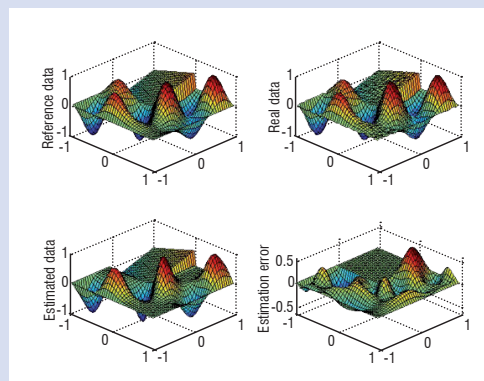

Video 5 - Modeling through LLM

Video - <http://www.aerospacelab-journal.org/al4/relevant-issues-for-aircraft-model-identification>

The coupling of this PSO algorithm with the constructive approach based on forward selection allows structural and parametric optimizations to be proceeded to jointly, for various types of regressors with local basis. The interested reader will find more details in [20,21]. In the KOALA tool (*Kernel Optimization Algorithm for Local Approximation*) developed by DCSD, this approach is applied to various kernel-based NNs, such as RBFN and LLM. To illustrate the working of this tool, videos 4 and 5 display the gradual improvement of an LLM during the iterative process involving the forward selection and optimization of kernels. The coefficient chosen corresponds to a complex L-shaped membrane including a constrained area (hyperplane in  $[-1, 0] \times [0, 1]$ ) to prove the capability of the method to take this type of constraints into account. Video 4 illustrates some PSO issues: the black crosses and dotted circles represent the swarm particles during the internal PSO cycles (centers and radii parameters), whereas the red circles represent the current best individual and the blue circles represent the kernels already selected. Video 5 displays the reference coefficient (top left) to be modeled from noisy observations (top right), the current LLM model (bottom left) and the current modeling error (bottom right), as the forward process unfolds (until 16 RBF units are created to fulfill a trade-off between accuracy and complexity). It is also worth noting that this technique is useful for identification purposes (especially EE approaches), as well as for on-board implementation of models with low memory requirements [20] or for synthesizing control laws from sparse approximated expressions [19].

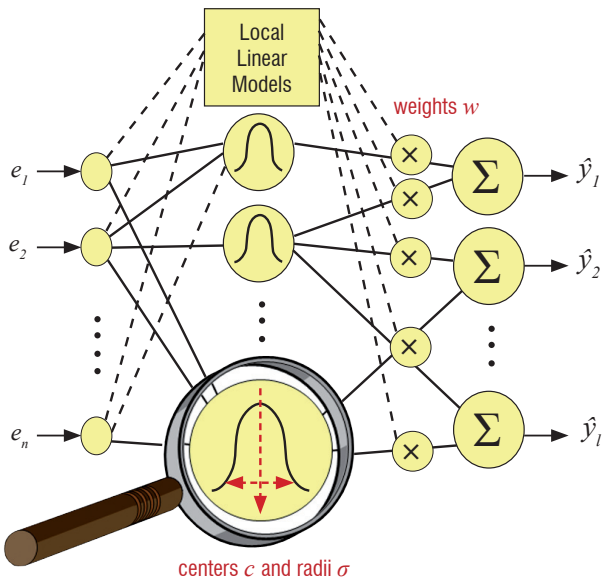

Figure 13 – Architecture of RBFN and LLM

Besides RBF nets, other types of local models can be usefully implemented (see box 1). This is the case with LLM (*Local Linear Models*), which generalize RBFN by replacing the linear weights by an affine expression depending on the model inputs, but are also related to other local models like some Fuzzy Inference Systems. By defining an extended set of regressors  $\phi_i^\#$ , the generic form (14) used to represent LP models thus becomes:

$$\hat{y}_k = f(e_k) = \sum_{j=1}^m \left( \sum_{i=0}^n w_{ji} e_k^i \right) \phi_j(e_k) = \sum_{i=1}^{m(n+1)} w_i \phi_i^\#(e_k) \quad (15)$$

with  $e_k^0 = 1$  to include the constant terms of the local affine modeling into the 2<sup>nd</sup> sum. It is thus expected that fewer RBFs will be required to achieve the same accuracy in most applications (see the dotted connections in figure 13).

Practically, the purpose of an automated identification in large areas of the flight domain has raised a new need: specifying constraints to be followed by the nonlinearities (*i.e.* the NN outputs). Constraints are a way to compensate for insufficient or sparse test data and to introduce some kind of expertise into the problem. For instance, the freezing of output levels may be required in some zones (*e.g.*  $\Delta C_{m_{NL}}$  in (13) should remain null at low AoA and low Mach, so that it does not interfere with other terms); it may also be desired to smooth the nonlinearity, or to connect identified and pre-flight models in areas where no flight data is available. Constraints are thus enforced by mechanisms relying for example on criteria penalty. Various forms of penalties are used, depending on the goals: constrained values, smoothing, regularization, etc. This in turn raises the question of choosing and tuning these hyperparameters, which should also be as automated as possible: this topic is currently being addressed.

### Identification in the frequency domain

#### Flexible A/C and flutter analysis

Among the various phenomena that can affect the flight of an A/C, flutter is one of the most feared events, since this dynamic instability can lead to a sudden destruction of the airplane (see box 2). One of

the major goals of the series of flight tests undertaken for any new aircraft is to check that the airplane is free of any flutter tendency in the whole set of flight conditions. Current flight tests are performed under stabilized flight conditions (at constant speed and at given Mach number). Under each condition, excitation signals (frequency sweeps, pulses) are successively applied to the structure through the control surfaces. The measurements of the A/C response are transmitted by telemetry to the ground test center in real time, where they are used to estimate the modes. The damping ratio estimates obtained under each stabilized condition, allow a trend to be drawn up, as a function of airspeed, which is useful to evaluate the stability of the next higher airspeed condition and to clear the airplane to this condition.

Onera has been working for many years in close collaboration with Airbus for flutter flight surveillance and has developed a large expertise in this topic [22,57,64-71]. DCSD not only develops identification tools that are currently used in the Toulouse ground test center of Airbus [57,64], but it also tackles most of the aspects of the identification process. Optimized excitation procedures are investigated and proposed for industrial use [22,70,71]. Evaluation tools based on high dimensional aeroelastic models were also developed [67,68]. Concerning the identification tools, prototypes are implemented involving all the aspects: raw data pre-processing, identification algorithms, supervision in order to determine the best model order and ergonomic graphical interfaces (see figure 14).

Owing to the operational context of the flutter tests, involving real-time monitoring, identification algorithms should comply with stringent requirements. Let us mention here the major constraints. First of all, the flight test conditions are not really favorable to an accurate identification. On the one hand, since the A/C operates under operational conditions, the measurements are affected by the ambient noise due to the airflow around the aircraft. Sometimes, the data is also corrupted by air turbulence when the aircraft encounters wind gusts. On the other hand, the excitation signals applied to the control surfaces are constrained in amplitude, frequency and shape. Consequently, many structural modes are not excited efficiently enough.

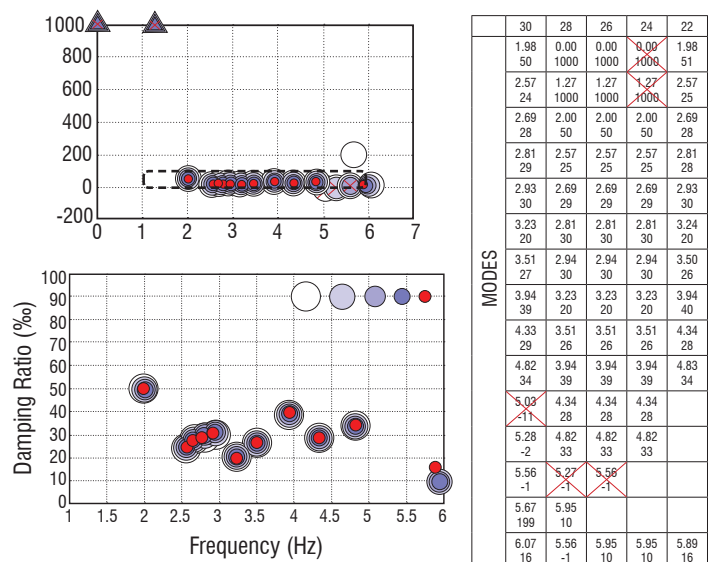

Figure 14 – Example of a graphical interface used for order determination

The second demanding requirement is that the algorithms must operate in a fully automated and near real-time way, since the crew is awaiting clearance before going on to the next test condition. It is

## Box 2 - The flutter phenomenon

In aeronautics, aeroelasticity is the science that studies the interaction between the inertial, structural, and aerodynamic forces acting on an aircraft. It was introduced by Collar as early as 1947. Aeroelasticity deals with several phenomena that may occur during flight. Among these, flutter is the most hazardous one. It is a dynamic instability whereby the oscillations of the structure extract energy directly from the airstream. Flutter can build up very quickly and cause the destruction of the aircraft. Any physical object is subject to its natural modes of vibration. When placed in a strong airflow, the aerodynamic forces alter the characteristics of these natural modes and flutter will happen if a positive feedback occurs between the natural vibration and these forces. If the energy extracted from the airflow is greater than the natural damping of the system, the level of vibration increases and leads to instability. Flutter can occur in any structure exposed to aerodynamic forces. One famous example is the collapse of the Tacoma Narrows Bridge (USA) in 1940 (see video 6 for several illustrations including this one).



Video 6 - The flutter phenomenon

Video - <http://www.aerospacelab-journal.org/al4/relevant-issues-for-aircraft-model-identification>

A schematic representation of the flutter phenomenon is also given by figure B2-1, which depicts a typical flutter case for airplanes. It results from the coupling between the bending and torsional modes of a wing. If these modes have similar frequencies and produce in phase oscillations under some flight condition, then the torsion of the wing induces variations in the lift due to the variations of the AoA. When these oscillations in the lift are in phase with the bending mode, they amplify the amplitude of the oscillations for this mode and hence flutter occurs. The physical modeling of the aeroelastic behavior is quite complex: it is based on the modeling of structural dynamics and unsteady aerodynamic effects. For complex systems such as an aircraft, the exact modeling of all structural aspects under all flight conditions is not possible. Therefore, a thorough flight testing is the only way to guarantee that an aircraft is free of flutter.

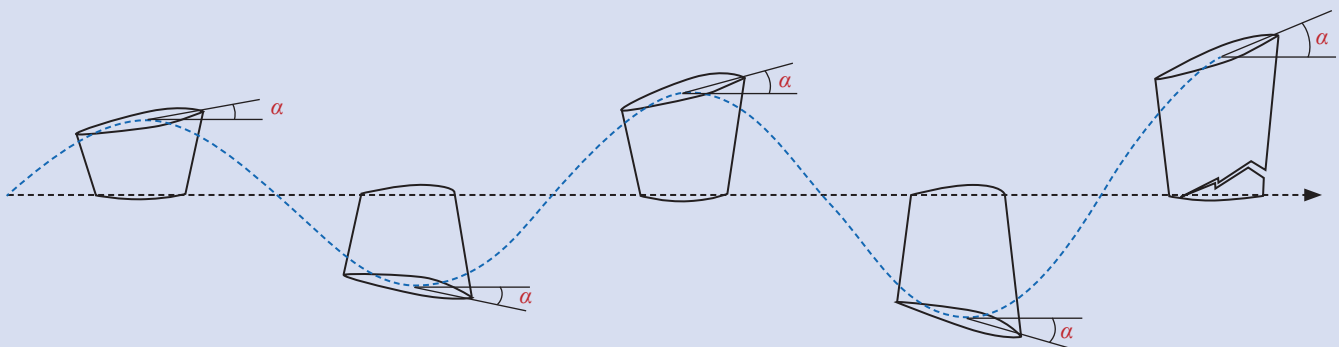

Figure B2-1 – Illustration of the flutter phenomenon

noteworthy that about one thousand identification runs are required for the certification of a new aircraft. This also claims for a high processing efficiency. Fully automated procedure is of capital importance, in order to relieve the ground operator who is put in charge of monitoring flight safety. To achieve this task, the algorithms must cope with high dimensional systems. Considering the number of modes that can be reasonably estimated and the number of available measurements, it turns out to be necessary to identify systems including 1000 to 5000 parameters. Hence, the algorithms must be very reliable and very robust to numerical errors.

The FD is particularly appropriate to the test conditions since we can focus only on the frequency band of interest. The amount of data to be processed is also greatly reduced, resulting in improved computation times. Hence, the tools developed for flutter flight test surveillance are

based on a parametric approach in the FD [64]. A polynomial transfer function has been chosen for the system, since it is very convenient for modal modeling:

$$H(s, \theta) = \frac{N(s, \theta)}{d(s, \theta)} \quad (16)$$

where the denominator  $d(s, \theta)$  is a polynomial of degree  $n_d$  and the numerator  $N(s, \theta)$  is a  $(n_y \times 1)$  vector of polynomials of degree  $n_d$ , assuming that  $n_y$  outputs are processed;  $s = j\omega$  is the Laplace transform variable and  $\theta$  is the parameter vector of dimension  $n_\theta = (n_y + 1) \times (n_d + 1)$ , which includes all of the numerator/denominator coefficients to be estimated. This black-box type of modeling is also convenient, since the frequency responses (*i.e.* the values taken by the transfer function for a discrete set of frequencies) may be directly computed from the measured time data by applying non-parametric spectral estimation methods.

The purpose of the identification task is to determine the best model (16), in order to match the estimated transfer  $H(s, \theta)$  with these *measured* frequency responses  $H_m(j\omega)$  derived from the raw data. The parameter estimation problem is then formulated as a nonlinear optimization problem:

$$\hat{\theta} = \text{Arg Min}_{\theta} [J(\theta)] \quad (17)$$

$$\text{where } J(\theta) = \sum_{\omega \in \Omega} \|H_m(j\omega) - H(j\omega, \theta)\|_{W_{\omega}}^2$$

where  $\Omega$  is the set of frequencies  $\omega$  located within the band of interest and  $W_{\omega}$  is a weighting matrix introduced to take the (varying) quality of measurements into account. A method of iteratively reweighted least-squares is then used to solve this optimization problem. To improve the algorithm implementation,  $N(s, \theta)$  and  $d(s, \theta)$  are expressed in specific polynomial bases to overcome the conditioning problems encountered with high order polynomials when using conventional bases involving high powers of  $\omega$  [64].

In the current test protocol, a single excitation signal is used for each test. In the future, in order to shorten the tests duration and hence to reduce the costs, it is contemplated to apply several excitation signals through several control surfaces simultaneously. Then, current developments focus also on MIMO (Multi-Input/Multi-Output) identification methods that are able to satisfy these more stringent operational requirements.

### Rigid A/C and on-board monitoring

As seen before, the methods involving the OE minimization are common practice in aeronautics. The criterion is generally expressed in the TD (see eq. (11)), but it can also be formulated in the FD thanks to Parseval's theorem, conveying the principle of energy preservation between the two domains. Hence, it becomes:

$$J(\theta) = \frac{1}{2} \frac{\Delta f}{\Delta t} \sum_{k=1}^{N_{\omega}} [Z(\omega_k) - Y(\omega_k, \theta)]^{\dagger} R^{-1} [Z(\omega_k) - Y(\omega_k, \theta)] \quad (18)$$

where  $\dagger$  represents the complex conjugate transpose operator and where the summation is now taken over the  $N_{\omega}$  frequencies  $\omega_k$  of interest, available from the TD to FD transformation ( $N_{\omega} \leq N$ ). The simulated and measured outputs  $Y, Z$  are defined in figure 15, whereas  $\Delta f$  and  $\Delta t$  represent the sampling periods in FD and TD respectively.

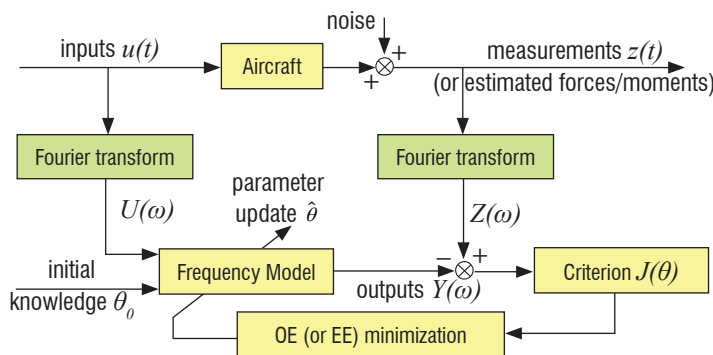

Figure 15 – Principles of identification in the frequency domain

As illustrated by figure 15, the transition to the FD is classically carried out by means of the standard FT of the TD signals. Since they are only available over a limited period of time  $[0, T]$ , the finite FT is used instead. Practically, two efficient tools are available for computing this quantity, namely the Fast Fourier Transform (FFT) and the Chirp z-transform. The latter permits a desired frequency resolution to be chosen independently

from the interval length  $T$ , but it is less effective as far as computation time is considered. From  $N$  data samples equally spaced over the time interval  $[0, T]$ , the FFT algorithm calculates  $N$  values of the discrete FT over the frequency interval  $[0, 2\pi / \Delta t]$ , also equally spaced with a step  $\Delta\omega = 2\pi / T$ . It is also worth noting that a recursive version of the algorithms allows the method to be implemented in real-time applications very efficiently. Apart from these computationally efficient tools making it possible to go from TD to FD, the FD identification approaches have other pros: they do not require an integration of the flight mechanics differential equations to perform a simulation and they enable working within a limited band of frequencies by selecting any range  $[0 \leq \omega_1, \omega_2 \leq 1 / 2\Delta t]$ .

More precisely, let us consider equation (19) which expresses the transformation of the system dynamics into state-space form from TD to FD and let the state and output biases  $b_x$  and  $b_y$  appear. If we consider frequencies  $\omega_k$  only multiples of the sampling frequency  $\Delta\omega$ , which is the case when using the FFT, the right bracket of (19) represent the simplified form of the FD state-space equations.  $\delta(\omega_k)$  denotes the Dirac function in the FD, such that  $\delta(\omega_k) = 1$  for  $\omega_k = 0$  and  $\delta(\omega_k) = 0$  else for  $\omega_k \neq 0$ .  $\Delta x = x(0) - x(T)$  corresponds to the discrepancy between the initial and final states.

$$\begin{cases} \dot{x}(t) = A(\theta)x(t) + B(\theta)u(t) + b_x \\ y(t) = C(\theta)x(t) + D(\theta)u(t) + b_y \end{cases} \quad \begin{matrix} \searrow \\ \downarrow \end{matrix} \quad (19)$$

$$\begin{cases} j\omega_k X(\omega_k) = A(\theta)X(\omega_k) + B(\theta)U(\omega_k) + b_x T\delta(\omega_k) + \Delta x \\ Y(\omega_k) = C(\theta)X(\omega_k) + D(\theta)U(\omega_k) + b_y T\delta(\omega_k) \end{cases}$$

Localized effects in the TD are thus translated into broadband effects in the FD and vice versa. Thus, the initial and final conditions are translated into a bias that affects all frequencies. On the contrary, the biases that act as broadband inputs in the TD modify only the zero frequency. To get the most out of these specificities, it is generally worthwhile to also discard this zero frequency during the identification stage, which avoids state and output biases having to be estimated. Thus, (19) is further simplified and only the  $\Delta x$  components need to be estimated in addition to other parameters  $\theta$ , if not zero.

Consequently, the FD methods are well suited for real-time implementations, for which TD methods could hardly be realistic owing to computational costs, but also for dealing, for example, with unstable models, which is rather common for military aircraft. In this case, no divergence of the internal simulations is to be feared since this technique do not proceed to TD integrations; the use of a stabilizing loop is thus avoided, which eliminates the risk of interactions between the stabilizing feedback and the identification process. It is also noteworthy that FD techniques can be beneficial to both OE and EE approaches, especially for real-time implementations, as far as the EE case is concerned; hence, the interest of FT regression has been highlighted in many publications [47]. Regarding TD algorithms, the only limitation (but not an insignificant one) results from the requirement to cope with linear or linearized models (at least locally valid).

These major application topics (model instability and online implementation) were explored by DCSD through two different research programs: with Dassault Aviation for identifying an unstable A/C, and during a long-term project jointly run by Onera and DLR between 2006 and 2010, named IMMUNE (*Intelligent Monitoring and Managing of Unexpected Events*). The objective of this project was to show the capability and viability of intelligent techniques for monitoring and



handling the Flight Control Systems (FCS) in real time, to improve civil A/C safety and autonomy. The monitoring was based on several methods, including modern Fault Detection, Isolation and Estimation (FDIE) techniques and of course on-line identification. The handling of the detected events was contemplated by different reconfiguration or self-adapting techniques, based on Fault Tolerant Control (FTC) principles. Both actions are strongly dependent and therefore were linked via a supervisory architecture in charge of the decision making [9].

The FD identification method presented above can be useful both for event detection via the variation of aerodynamic parameters, and for event handling since an updated model is often required for indirect adaptation or FTC techniques [33]. In practice, it delivers a near real time estimation of the stability/control derivatives involved in the A/C modeling. For monitoring purposes, these estimates are compared to a set of reference values corresponding to the nominal behavior (non-faulty situation). In the framework of FDIE, using this method for diagnosis makes up a special class of model-based methods, the residuals referring to model parameters instead of the TD histories of measured variables, as is usually the case. Due to weak excitation signals and large residual errors (ordinary control signals resulting from pilot or autopilot orders are used), a measure of confidence is essential to the accommodation logic, but this measure can be easily computed via the standard deviation of the estimation errors, directly available from the FD method. Finally, FD identification is the central part of a monitoring process that also includes pre-processing and post-processing stages, respectively, to prevent and filter out inaccurate estimations. The scenarios used as benchmarks during IMMUNE involved actuator FDIE on the one hand and detection of icing accretion on the other hand. Results can be found in [18]. The computational feasibility of an onboard implementation was thus shown for this FD OE method. Owing to its characteristics, the algorithm requires a few iterations to converge and the memory requirements are limited thanks to a moving data windowing. The technique can estimate changes in the dynamics within a short delay, despite state and output noises.

### State-space models for control design

Multivariable state-space models are required to design control laws using modern control techniques such as LQR/LQG, LPV/LFT, H2/H $\infty$  [56]. They must provide an accurate description of the relationship between the surface control deflections and the output signals used by the controller. For a flexible aircraft, given the strong interaction between the FCS and the first aeroelastic modes, a suitable model for control purposes must include rigid-body and structural dynamics and represent the aircraft in an extended frequency range. Reduced order models can also be derived from those identified before applying control techniques [52]. Though preliminary knowledge may provide theoretical models that are appropriate for a first design iteration, model identification from in-flight data is then required for a fine analysis or tuning of the control law performance. Therefore, a two-step identification procedure depicted in figure 16 was developed by DCSD. The corresponding software developments were included in a toolbox called HARISSA and were successfully used by Airbus for the design of structural active control laws for A340-600 aircraft [34,35]. The two steps of the procedure consist in:

- Firstly, a discrete-time representation of the structural dynamics is determined from specific flight tests (typically frequency sweeps) thanks to the Eigensystem Realization Algorithm (ERA); ERA is one of the few available techniques permitting a multivariable state-space model to be derived from i/o data [34,65]. This representation

includes only modes that are visible from the measurements. Then, it is converted to continuous-time and turned into a real block-diagonal form that provides a minimal parametric representation [4];

- Secondly, a state-space model of the flexible aircraft is obtained by gathering the structural and rigid-body linearized models, both in state-space form. The coupling is performed by simply adding the outputs of the two models. This merged model is used to initialize an OE approach relying on a Gauss-Newton algorithm in the FD, similar to the one described in the previous section (see also [18]). The identification is based on both usual rigid-body excitations and peculiar excitations dedicated to flexible modes. If it proves to be necessary, a preliminary estimation of the rigid-body model coefficients may be performed by a standard OE approach in the TD.

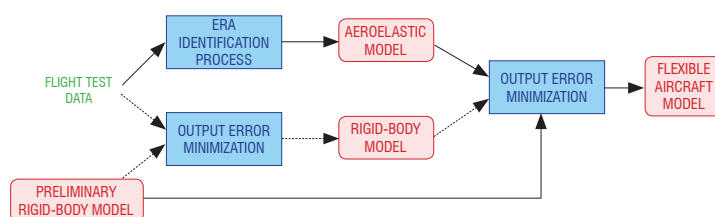

Figure 16 – General chart of the two-step identification procedure

## MODEL VALIDATION

### Estimation of unknown inputs and model corrections

Input estimation is a general process aimed at estimating the input uncertainties or the control orders of a given system, for which a mathematical model and some experimental responses are available and assumed accurate enough. Several tools have been developed to estimate various types of corrections (control surface deflections, aerodynamic coefficients, sidestick deflection, wind), which, once applied to aircraft inputs, could ensure a best match between the computed model responses and the measurements. This aspect (shown in red in figure 17) is the counterpart of parameter estimation (in blue) and data preprocessing (in green), which are aimed at correcting the model parameters or the measured outputs, respectively, assuming either a perfect knowledge of inputs and outputs on the one hand, or of inputs and model on the other hand.

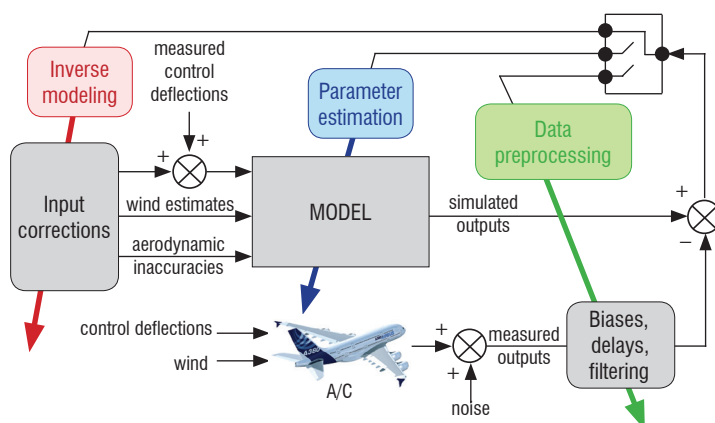

Figure 17 – Input estimation vs. parameter identification vs. data preprocessing

Thus, an estimation of some corrections related to the aerodynamic coefficients can be implemented as a preliminary step in an identification process based on an EE approach. In this case, the

estimated corrections are computed from the pre-flight aircraft model and the analysis of the corrected aerodynamic coefficients can be useful to improve the structure of the aerodynamic modeling. Following the model update by EE, an additional estimation of input corrections can be performed to check the validity of the identified model. The new estimated corrections should be centered around 0 and their amplitudes should be kept small enough to ensure that a sufficiently accurate model is derived.

In such cases, whenever a state-space model of the aircraft is available, Kalman-Rauch smoothing is an efficient and well-suited method for this estimation problem. Several tools have been developed based on a KF, including the complete nonlinear A/C model. This technique has also been extended to the processing of tests including transitions between ground and flight phases, which lead to account for discontinuities in states or inputs. The basic principle of this method is described by the block diagram in figure 18, whereas the stochastic models involved in this method are described below:

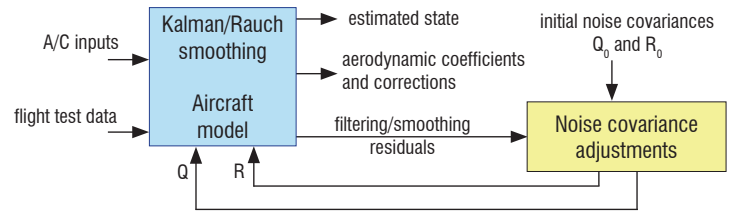

Figure 18 – Estimation of aerodynamic corrections by a filtering approach

### QTG tests

For each new aircraft, manufacturers are in charge of providing training simulators with a set of validation tests approved by the aviation authorities. These tests are aimed at proving the ability of the simulator to replicate the real aircraft motion within the regulation tolerances. They are put together within the Qualification Test Guide (QTG) and provide a basis for the qualification of the simulators. However, a preliminary step is necessary for the QTG tests, before delivering them to the simulator manufacturers. It consists in a fine tuning of the simulation inputs (initial conditions, pilot inputs) in order to satisfy the requirements of the aviation regulations. If manually operated, this task can be very tedious and time-consuming depending on the type of test, especially for tests flown with the FCS activated. This is why DCSD has designed an efficient tool able to tune a set of various tests, automatically and within a reasonable amount of time.

The solution to this problem comes up against a number of difficulties:

- There is no analytical model of the A/C with the control laws available; the only model which can be used is the closed-loop simulation software, which excludes the use of estimation methods based on state-space representations because too many nonlinear and numerical solvers are involved;
  - The model is strongly nonlinear and may be non-stationary during specific flight sequences, *e.g.*, an airplane flying with ground effect;
  - The multivariable nature of the problem adds more complexity, so the question of a global processing or an axis by axis solution is raised;
  - The solution must comply with strong input and output constraints.
- Moreover, some of these depend on the flight phase (approach, touchdown);

Continuous time process model      Discrete time observation model

$$\begin{cases} \dot{x} = f(x, u, \Delta C) \\ \Delta \dot{C} = \eta \end{cases} \quad z_k = g(x_k, u_k, \Delta C_k) + \zeta_k$$

where  $x$  represents the aircraft state,  $u$  the inputs,  $\Delta C$  represents the corrections related to the aerodynamic coefficient and  $\eta$  represents a Gaussian process noise, whereas  $z_k$  is the measurement vector and  $\zeta_k$  is a Gaussian observation noise.

To represent the aerodynamic corrections, additional state variables are introduced, with dynamics governed by a random walk process. In principle, all process noises are assigned to the aerodynamic corrections, but their amplitudes depend on both the accuracy of the pre-flight model and the shape of the aircraft maneuver. Hence, standard deviations should be adjusted for every test. In order to automate this tuning which usually relies on user experience, an iterative technique has been designed by DCSD to estimate the variances of both process and measurement noises. This algorithm is aimed at guaranteeing the consistency between the theoretical and statistical standard deviations of the smoothing residuals.

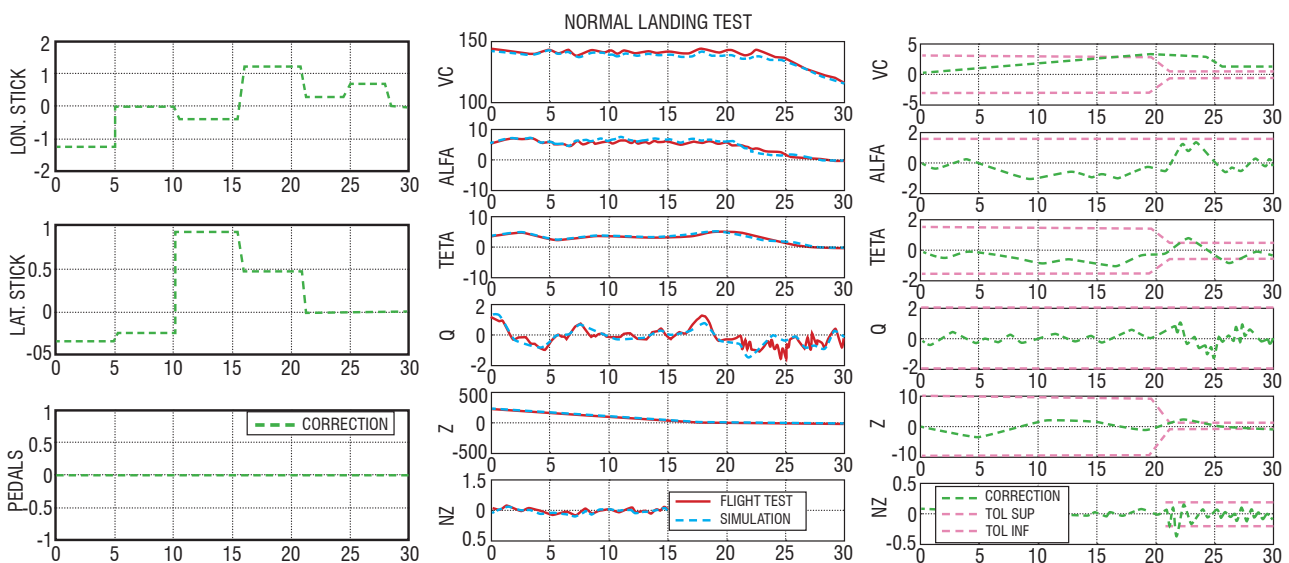

Figure 19 – Input corrections (sticks and pedals) for QTG tests

- If a solution exists, it is probably not unique since each solution satisfying the constraints is acceptable. That is why a solution minimizing the output energy will usually be favored;

- The computational cost per simulation is rather high, so that the total number of simulations should be very limited to keep the total CPU time acceptable.

The developed solution is based on a sequential processing of the air and ground stages. It has been validated from a challenging set of tests: normal landing, landing with crosswind and landing with one engine off. Optimization criteria peculiar to each phase are minimized by nonlinear optimization techniques to keep the discrepancies between simulation outputs and aircraft measurements within the tolerances. A first optimization step is devoted to the attitude and trajectory parameters, while a fine tuning of the landing gear and nose wheel touchdowns is achieved in a second optimization step. Various ways of parameterizing have been tested and compared, as regards to the corrections of the simulation inputs: multi-pulse signals including Haar or Walsh functions, multi-sine and Gaussian functions. The multi-pulse signals have turned out to be the best option. It doesn't matter whether the corrections of the longitudinal and lateral sticks are estimated simultaneously or not. Indeed, it appears that the two strategies yield very similar results. An illustration is given by figure 19.

## Conclusion and prospects

Despite being non exhaustive, this survey reveals the variety of issues involved in the identification of aeronautical systems, illustrated by some of Onera's developments. It stresses the variety of the solutions required also, depending both on the available modeling and on the objectives. For instance, the structured form of modeling used for rigid A/C leads to the use of well-known and mastered techniques, EE/OE/FE-type, whether in TD or FD forms. On the other hand, the complexity of the aeroelastic physical models involved in the flexible case requires black-box type representations, only based on i/o data, to be sought. Though iterative least-squares are nowadays the favored algorithm to obtain these, subspace methods in the FD remain promising alternatives and they have been under consideration at Onera for several years.

Most of the current works related to rigid aircraft focuses less on developing new techniques than on adapting common ones to the requirements of the aeronautical industry. For the incoming A/C programs, the certification procedures should be achieved within a shorter and shorter time period, which implies that the length of the flight tests must be reduced. Hence, there is a great demand for developing new designs of experiments that would be more efficient, but also to assist the performing engineers in their tedious task while sifting through the whole set of flight data. As regards the latter, some advances are contemplated:

- Design of tools for making the user aware of the areas where the information provided by the data is too poor to obtain relevant results and accordingly where the pre-flight model should be preserved (a rather tricky matter in the multivariate case);

- Development of multiobjective algorithms, to take various types of criteria into account jointly, in both the TD and the FD;

- Merging the identification results computed under various flight conditions;

- Proposing incremental approaches to process new flight tests progressively, as soon as they become available, in order to improve the modeling without restarting from scratch;

- Taking advantage of new types of flight tests, requested by other A/C disciplines and teams, which extend to AoA-Mach-sideslip domains usually not covered by the tests devoted to the identification process.

Nevertheless, further efforts in dealing with the most complex aerodynamic nonlinearities are needed and, besides, parameter estimation in the presence of significant disturbances still raises a number of questions. As far as flexible A/C and flutter analysis are concerned, the current effort focuses on methods allowing several sensors and several control surfaces to be processed at the same time, the excitation signals being optimized to highlight the aeroelastic modes at best. The emphasis is also put on the robustness of the tools and their computational performances, owing to real-time processing requirements. To track the modes on-line, in order to prevent a critical behavior while expanding the flight domain, a Linear Parameter-Varying (LPV) modeling could be implemented in the future, with the A/C speed as a scheduling parameter ■

## References

- [1] S. ARULAMPALAM, S. MASKELL and N. GORDON - *A Tutorial on Particle Filters for On-Line Non-Linear/Non-Gaussian Bayesian Tracking*. Transactions on Signal Processing, Vol. 50 (2), 2002.
- [2] D.M. BORTZ and C.T. KELLEY - *The Simplex Gradient and Noisy Optimization Problem*. Computational Methods in Optimal Design and Control (Progress in Systems and Control Theory), Birkhäuser, Boston, Massachusetts, Vol. 24, pp. 77-90, 1998.
- [3] C. BOUCHEREAU and D. LIOT - *Aerodynamic Specification for A340/A330/A321 Flight Training Simulators*. AIRBUS TR 456.006/90, Issue 8, 1993.
- [4] A. BUCCHARLES and P. VACHER - *Flexible Aircraft Model Identification for Control Law Design*. Aerospace Science and Technology, Vol.6 (8), 2002.
- [5] R.T.N. CHEN - *Input Design for A/C Parameter Identification: Using Time-Optimal Control Formulation*. AGARD-CP-172, #13, 1975.
- [6] R. DAVIDSON and J.G. MacKINNON - *Estimation and Inference in Econometrics*. Oxford University Press, New York, 1993.
- [7] N. DE FREITAS - *Rao-Blackwellized Particle Filtering for Fault Diagnosis*. IEEE Aerospace, 2001.
- [8] P. DE LARMINAT and Y. THOMAS - *Automatique des systèmes linéaires : identification*. Vol. 2, Flammarion Sciences., 230 p., 1975.
- [9] C. DÖLL, G. HARDIER, C. KAPPENBERGER and A. VARGA - *IMMUNE: Intelligent Monitoring and Managing of UNexpected Events*. 27<sup>th</sup> International Congress of the Aeronautical Sciences, Nice, 2010.
- [10] L. DUGARD and I. LANDAU - *Recursive Output Error Identification Algorithm: Theory and Evaluation*. Automatica, Vol. 16, 1980.
- [11] H. GARNIER and L. WANG (Eds) - *Identification of Continuous-Time Models from Sampled Data*. Springer, 2008.
- [12] M. GAUTIER - *Dynamic Identification of Robots with Power Model*. Proc. IEEE Int. Conf. on Robotics and Automation, Albuquerque, pp. 1922-1927, 1997.
- [13] N.K. GUPTA and R.K. MEHRA - *Computational Aspects of Maximum Likelihood Estimation and Reduction in Sensitivity Function Calculations*. IEEE Transactions on Automatic Control, Vol. AC 19 (6), 1974.
- [14] P.G. HAMEL and R.V. JATEGAONKAR - *Evolution of Flight Vehicle System Identification*. Journal of Aircraft, Vol. 33 (1), pp. 9-28, 1996.
- [15] G. HARDIER - *Recurrent Neural Networks for Ship Modeling and Control*. 11<sup>th</sup> Ship Control System Symposium, Southampton, 1997.
- [16] G. HARDIER - *Recurrent RBF Networks for Suspension System Modeling and Wear Diagnosis of a Damper*. IEEE World Congress on Computational Intelligence, Vol. 3, pp. 2441-2446, Anchorage, USA, 1998.
- [17] G. HARDIER, C. LAMBERT and S. KUMMER - *The COGITE System of the Charles de Gaulle Aircraft Carrier: an Innovating Heel Compensation Device*. 12<sup>th</sup> Ship Control System Symposium, La Haye, Netherlands, 1999.
- [18] G. HARDIER and A. BUCCHARLES - *On-Line Parameter Identification for In-Flight Aircraft Monitoring*. 27<sup>th</sup> International Congress of the Aeronautical Sciences, Nice, 2010.
- [19] G. HARDIER, C. ROOS and C. DÖLL - *Creating Sparse Rational Approximations for LFR Modeling Using New Evolutionary Algorithms*. Submitted to IEEE Transactions on Systems, Man and Cybernetics, Part B, 2012.
- [20] G. HARDIER, C. SEREN and P. EZERZERE - *On-Line Estimation of Longitudinal Flight Parameters*. SAE AeroTech Congress and Exhibition, Toulouse, 2011.
- [21] S. HAYKIN - *Neural Networks: a Comprehensive Foundation*. IEEE Press, MacMillan Ed., New York, 1994.
- [22] B. JACQUIER, P. VACHER, A. BUCCHARLES, A. CORDEAU and S. LEROY - *Improved Flutter Testing by Coordinated Excitations of Several Control Surfaces*. Proc. of the Society of Flight Test Engineers (European Chapter) Symposium, Toulouse, 2011.
- [23] A. JANOT, P.O. VANDANJON and M. GAUTIER - *Identification of Robots Dynamics with the Instrumental Variable Method*. Proc. IEEE on Int. Conf. on Robotics and Automation, Kobe, pp. 1762-1767, 2009.
- [24] R.V. JATEGAONKAR and E. PLAETSCHKE - *Algorithms for Aircraft Parameter Estimation Accounting for Process and Measurement Noise*. Journal of Aircraft, Vol. 26 (4), pp. 360-372, 1989.
- [25] R.V. JATEGAONKAR and F. THIELECKE - *Evaluation of Parameter Estimation Methods for Unstable Aircraft*. Journal of Aircraft, Vol. 31 (3), pp. 510-519, 1994.
- [26] R.V. JATEGAONKAR - *Flight Vehicle System Identification – A Time Domain Methodology*. AIAA Progress in Astronautics and Aeronautics, Vol. 216, Reston, 2006.
- [27] S.J. JULIER, K.UHLMANN and H.F. DURRANT-WHYTE - *A New Method for the Nonlinear Transformation of Means and Covariances in Filters and Estimators*. IEEE Transactions on Automatic Control, Vol. 45 (3), 2000.
- [28] F. KHATOUNIAN, S. MOREAU, E. MONMASSON, A. JANOT and F. LOUVEAU - *Simultaneous Identification of the Initial Rotor Position and Electrical Parameters of a PMSM for a Haptic Interface*. Proc. of EPE-Power Electronics and Motion Control, Portoroz, 2006.
- [29] V. KLEIN and E.A. MORELLI - *Aircraft System Identification – Theory and Practice*. AIAA Education Series, Reston, 2006.
- [30] J.H. KOTECHE and P.M. DJURIC - *Gaussian Sum Particle Filtering*. IEEE Trans. on Signal Processing, Vol. 51 (10), 2003.
- [31] M. LABARRERE, A. ROCHE, B. GIMONET and J.P. KRIEF - *Identification Methods Derived from Correlation Methods*. 2<sup>nd</sup> IFAC Symposium on Identification and System Parameter Estimation, Prague, 1970.
- [32] M. LABARRERE, J.P. KRIEF, B. GIMONET, - *Reduction of Multivariable Systems*. 3<sup>rd</sup> IFAC Symposium on Identification and System Parameter Estimation, The Hague, June 1973.
- [33] L. LAFOURCADE, C. CUMER and C. DÖLL - *Control Reallocation after Surface Failures Using Model Predictive Control*. 18<sup>th</sup> IFAC ACA symposium, Nara, Japan, 2010.
- [34] C. LE GARREC, M. HUMBERT, A. BUCCHARLES and P. VACHER - *In-Flight Aeroelastic Model Identification and Tuning of a Flight Control System on a Large Civil Aircraft*. International Forum of Aeroelasticity and Structural Dynamics, Madrid (Spain), 2001.
- [35] C. LE GARREC and F. KUBICA - *In-Flight Structural Modes Identification for Comfort Improvement by Flight Control Laws*. Journal of Aircraft, Vol.42 (1), 2005.
- [36] C.E. LEMAIRE, P.O. VANDANJON and M. GAUTIER - *Dynamic Identification of a Vibratory Asphalt Compactor for Contact Efforts Estimation*. Proc. of the 14<sup>th</sup> IFAC Symposium on System Identification, SYSID, Newcastle, Australia, 2006.
- [37] D.LIOT and A. BUCCHARLES - *Outils d'identification de la mécanique du vol latérale des Airbus*. Symposium RTO System Concepts and Integration Panel, Madrid, 1998.
- [38] L. LJUNG - *System Identification – Theory for the User*. Prentice-Hall, 2nd Ed., Upper Saddle River, 1999.
- [39] C.F. LO, J.L. ZHAO and R. DELOACH - *Application of Neural Networks to Wind Tunnel Data Response Surface Methods*. 21<sup>st</sup> AIAA Aerodynamic Measurement Technology and Ground Testing Conference, Denver, USA, 2000.
- [40] A. LUC-BOUHALI and O. DESSORNES - *The Remanta Project on MAV with Flapping Wings*. International Symposium on Innovative Aerial/Space Flyer Systems, Tokyo, Japan, 2005.
- [41] R.E. MAINE and K.W. ILIFF - *The Theory and Practice of Estimating the Accuracy of Dynamic Flight-Determined Coefficients*. NASA Publication 1077, 1981.
- [42] R.E. MAINE and K.W. ILIFF - *Formulation and Implementation of a Practical Algorithm for Parameter Estimation with Process and Measurement Noise*. SIAM Journal on Applied Mathematics, Vol. 4 (3), pp. 558-579, December 1981.



- [43] R.E. MAINE and K.W. ILIFF - *Application of Parameter Estimation to Aircraft Stability and Control*. NASA Publication 1168, 1986.
- [44] R.K. MEHRA - *Frequency-Domain Synthesis of Optimal Inputs for Linear System Parameter Estimation*. Div. Eng. Appl. Phys., Technical Report 65, July, 1973.
- [45] L. MEVEL, M. BASSEVILLE and A. BENVENISTE - *Fast In-Flight Detection of Flutter Onset: a Statistical Approach*. AIAA Journal of Guidance, Control, and Dynamics, Vol. 28 (3), pp. 431-438, 2005.
- [46] E.A. MORELLI and V. KLEIN - *Practical Input Optimization for Aircraft Parameter Estimation Experiments*. PhD. Report, George Washington University JIAFS, DC, 1993.
- [47] E.A. MORELLI - *Real-Time Parameter Estimation in the Frequency Domain*. Journal of Guidance, Control, and Dynamics, Vol. 23 (5), pp. 812-818, 2000.
- [48] E.A. MORELLI and V. KLEIN - *Application of System Identification to Aircraft at NASA Langley Research Center – LaRC*. Journal of Aircraft, 42: 12-25, 2005.
- [49] E.A. MORELLI and D.G. WARD - *Automated Simulation Updates based on Flight Data*. AIAA AFM, Hilton Head, USA, 2007.
- [50] J.A. MULDER, J.K. SRIDHAR and J.H. BREEMAN - *Identification of Dynamic Systems – Applications to Aircraft – Part 2: Nonlinear Analysis and Manoeuvre Design*. AGARD – AG-300, Vol. 3, Part 2, 1994.
- [51] R. POULIQUEN, J. ESTAPA and J. RICHALET - *Identification by Frequency Methods and Sensitivity Functions*. 2<sup>nd</sup> IFAC Symposium on System Sensitivity and Adaptivity, Dubrovnik, 1968.
- [52] C. POUSSOT-VASSAL and F. DEMOURANT - *Model Reduction and Interpolation*. AerospaceLab, Issue 4, 2012.
- [53] T. RAKOTOMAMONJY, M. OULADSINE and T. LE MOING - *Modeling and Kinematics Optimization for a Flapping Wing Micro Air Vehicle*. Journal of Aircraft, Vol. 44 (1), 1997.
- [54] T. RAKOTOMAMONJY, T. LE MOING, B. DANET, X. GADOULLET, D. OSMONT and M. DUPONT - *Evaluation of Flexible Flapping Wing Concept*. Health Monitoring of Structural and Biological Systems 2009. Proceedings of the SPIE, Vol. 7295, 2009.
- [55] A. RAULT, R. POULIQUEN and C. LEFEVRE - *Applications of Identification Methods to Aeronautics*. 2<sup>nd</sup> IFAC Symposium on Identification and System Parameter Estimation, Prague, 1970.
- [56] C. ROOS, C. DÖLL and J.M. BIANNIC - *Flight Control Laws: Recent Advances in the Evaluation of their Robustness Properties*. AerospaceLab, Issue 4, 2012.
- [57] J. ROUBERTIER, C. DAUDET, F. DESSILLON, A. BUCCHARLES and P. VACHER - *New Flutter Flight Test Identification Method Developed for Large and Flexible Aircraft - MEFAS*. Proc. of the Society of Flight Test Engineers European Chapter (SFTE-EC) Symp., 2003.
- [58] S. SÄRKKÄ - *Unscented Rauch-Tung-Striebel Smoother*. IEEE Trans. on Automatic Control, Vol. 53(3), pp. 845-849, 2008.
- [59] J. SCHOUKENS, G. VANDERSTEEN, R. PINTELON and P. GUILLAUME - *Frequency-Domain Identification of Linear Systems Using Arbitrary Excitations and a Nonparametric Noise Model*. IEEE Trans. on Automatic Control, Vol. 44 (2), pp. 343–347, 1999.
- [60] C. SEREN, F. BOMMIER, A. BUCCHARLES, L. VERDIER and D. ALAZARD - *Flight Test Protocol Optimization Using Genetic Algorithms*. In Proceedings of the 14<sup>th</sup> IFAC Symposium on System Identification, Newcastle, Australia, 2006.
- [61] C. SEREN - *Optimal Input Design using New Evolutionary Algorithms*. In Proceedings of the 8<sup>th</sup> International Conference System Identification and Control PROblems – SICPRO'09, pp. 26-30, Moscow, Russia, 2009.
- [62] J. SJÖBERG, H. HJALMARSSON and L. LJUNG - *Neural Networks in System Identification*. IFAC SYSID'94, Copenhagen, Denmark, pp. 49-72, 1994.
- [63] P. STOICA and T. SÖDERSTRÖM - *Optimal Instrumental Variable Estimation and Approximate Implementations*. IEEE Trans. on Automatic Control, Vol. Ac-28 (7), pp. 757–772, 1983.
- [64] P. VACHER and A. BUCCHARLES - *A Multi-Sensor Parametric Identification Procedure in the Frequency Domain for the Real-Time Surveillance of Flutter*. Proceedings of IFAC Symposium on System Identification (SYSID), Newcastle, Australia, 2006.
- [65] P. VACHER - *EFERA: an Efficient Realization Technique for the Identification of Large Aeroelastic Models*. Proceedings of the 5<sup>th</sup> IFAC Symposium on Robust Control Design (ROCOND), Toulouse, France, 2006.
- [66] P. VACHER and A. BUCCHARLES - *Detection of Turbulence During Flutter Tests*. Proceedings of ISMA International Conference on Noise and Vibration Engineering, Leuven, Belgium, 2006.
- [67] P. VACHER and A. BUCCHARLES - *Realistic Simulation of Flutter Flights Tests*. In Proceedings of ISMA International Conference on Noise and Vibration Engineering (Invited session Flite 2 EUREKA), Leuven, Belgium, 2008.
- [68] P. VACHER, B. JACQUIER, A. CORDEAU and A. BUCCHARLES - *Flutter Flight Tests: a Challenging Benchmark for Real-Time Methods*. Proceedings of the Second International Workshop in Sequential Methodologies (IWSM), Troyes, France, 2009.
- [69] P. VACHER, B. JACQUIER and A. BUCCHARLES - *Extensions of the MAC Criterion to Complex Modes*. Proceedings of ISMA International Conference on Noise and Vibration Engineering, Leuven, Belgium, 2010.
- [70] P. VACHER, B. JACQUIER and A. BUCCHARLES - *Design of Linear Input Combinations for Improved Modal Analysis of MIMO Systems*. Proceedings of Journées Identification et Modélisation Expérimentale (JIME), Douai, France, 2011.
- [71] P. VACHER, A. BUCCHARLES and B. JACQUIER - *Short Duration Excitation Signals for Flutter Testing*. Proceedings of International Forum of Aeroelasticity and Structural Dynamics (IFASD), Paris, France, 2011.
- [72] J.-W. VAN WINGERDEN, P. GEBRAAD and M. VERHAEGEN - *LPV Identification of an Aeroelastic Flutter Model*. 49<sup>th</sup> IEEE Conference on Decision and Control, Atlanta, USA, 2010.
- [73] G. VENTURE, P.J. RIPERT, W. KHALIL, M. GAUTIER and P. BODSON - *Modeling and Identification of Passenger Car Dynamics using Robotics Formalism*. IEEE Trans. on Intelligent Transportation Systems, 7(3), pp. 349-355, 2006.
- [74] V. VERDULT and M. VERHAEGEN - *Subspace Identification of Multivariable Linear Parameter-Varying Systems*. Automatica, Vol. 38 (5), pp. 805-814, 2002.
- [75] E. WALTER and L. PRONZATO - *Identification de modèles paramétriques à partir de données expérimentales*. Masson Ed., Paris, 1994.
- [76] T. WEI, Y. HUANG and P. CHEN - *Particle Filtering for Adaptive Sensor Fault Detection and Identification*. Proceedings of the IEEE International Conference on Robotics and Automation, Orlando, USA, 2006.
- [77] P.C. YOUNG - *An Instrumental Variable Method for Real Time Identification of a Noisy Process*. Automatica, Vol. 6, pp. 271–287, 1970.

## Acronyms

CFD (Computational Fluid Dynamics)  
FD (Frequency Domain)  
TD (Time Domain)  
ML (Maximum Likelihood)  
KF (Kalman Filter)  
EKF (Extended Kalman Filter)  
UKF (Unscented Kalman Filter)  
AoA (Angle of Attack)  
SISO (Single Input-Single Output)  
MIMO (Multiple Input-Multiple Output)  
ED (Experimental Design)  
OID (Optimal Input Design)  
EE (Equation Error)  
OE (Output Error)  
FE (Filter Error)  
LPV (Linear Parameter-Varying)  
ERA (Eigensystem Realization Algorithm)

LP (Linear-in-their-Parameters)  
LS (Least Squares)  
OLS (Ordinary Least Squares)  
WLS (Weighted Least Squares)  
IV (Instrumental Variable)  
NN (Neural Network)  
RBFN (Radial Basis Function Network)  
MLP (Multi-Layered Perceptron)  
LLM (Local Linear Model)  
PSO (Particle Swarm Optimization)  
FT (Fourier Transform)  
FFT (Fast Fourier Transform)  
FCS (Flight Control System)  
FDIE (Fault Detection, Identification and Estimation)  
FTC (Fault Tolerant Control)  
QTG (Qualification Test Guide)  
IMMUNE (Intelligent Monitoring and Managing of UNexpected Events)

## AUTHORS



**Alain Bucharles** graduated from the *Ecole Centrale de Lyon* in 1973. He joined Onera in 1975, and has now more than 30 years of experience in system identification applied to rigid and flexible aircraft. He has been involved in many joint projects with A/C manufacturers and has contributed to several software tools which have been successfully applied in aeronautics industry.



**Christelle Cumer** received her Ph.D. degree in Automatic Control from Supaero in 1998, before joining Onera/DCSD where she has been in charge of the Control and Integration research unit since 2010. Her main research interests concern flexible multi-body dynamics and modeling, flexible structure control and their applications to various aerospace systems. She is also involved in new developments concerning the adjustment of control laws and nonlinear estimation methods.



**Georges Hardier** holds a Ph.D. in Automatic Control from Supaero. After joining Onera, he was in charge of the development of autopilots and control laws for a series of French warships for two decades. He has now over 25 years of experience in parametric estimation, modeling and identification techniques, applied to the aeronautics industry.

Recently, he developed on-line estimation methods for Fault Detection and Diagnosis during the Onera-DLR project IMMUNE.



**Béatrice Jacquier** is a research engineer at Onera. She received her Ph.D. degree in structural dynamics and control from Supaero in 1998. Her fields of interest are modeling and identification of dynamic models, signal processing and civil aircraft applications. Since 2009, she has been involved in the development of tools with Airbus, permitting a real time identification of the aircraft to be achieved during the flutter flight tests.



**Alexandre Janot** received his Ph.D. from the University of Nantes and the French Atomic Energy Commission (CEA) in 2007, before joining Onera in 2010. His research interests are focused on the modeling and identification of multi-body dynamics and, more generally, on the development and application of identification methods in several areas, including robotics.



**Thierry Le Moing** graduated from Supaero in 1984. After working for the Thomson group on the development of new digital processing radar for air defense systems, he joined Onera in 1989 where he contributed to the evaluation of autonomous navigation systems for tactical missiles. For over 15 years, his main interest has concerned estimation and optimization techniques for flight test data processing. More recently, he has been involved in research programs on flapping wing micro aerial vehicles, aimed at developing new control and actuator concepts.



**Cédric Seren** is a research scientist at Onera. He graduated in 2003 from ENSAE and received his Ph.D. degree in 2007. During his Ph.D., he worked on A/C flight tests protocol optimization for flight dynamics identification, using new evolutionary algorithms. Since 2007, his activity has been essentially focused on both nonlinear modeling and estimation for aircraft fault detection, isolation and recovery, as well as on mathematical optimization.



**Clément Toussaint** graduated from the *Ecole Polytechnique* and from Supaero in 1994. Then, he joined Onera, where he initially worked on turbo-machinery CFD and pioneered blade optimization based on Navier-Stokes solvers. He moved to DCSD in 2000 and his fields of interest are the identification of nonlinear models using neural networks, as well as aircraft flight dynamics.



**Pierre Vacher** graduated from the *Ecole Polytechnique* and from Supaero in 1984. Since that time, he has been a research scientist at Onera. His fields of interests include signal processing, modal analysis, identification of dynamic models and aircraft flight dynamics. He is strongly involved in the development of new methods permitting a real time processing of flutter flight tests to be achieved.