



HAL
open science

SENSOR OPERATING PRINCIPLES

Piet Bergveld, Daniel R. Thévenot

► **To cite this version:**

Piet Bergveld, Daniel R. Thévenot. SENSOR OPERATING PRINCIPLES. Chemical sensors for in vivo monitoring, Chap.2, Jai Press, pp.31-94, 1993, 1-55938-630-4. hal-01179726

HAL Id: hal-01179726

<https://hal.science/hal-01179726>

Submitted on 23 Jul 2015

HAL is a multi-disciplinary open access archive for the deposit and dissemination of scientific research documents, whether they are published or not. The documents may come from teaching and research institutions in France or abroad, or from public or private research centers.

L'archive ouverte pluridisciplinaire **HAL**, est destinée au dépôt et à la diffusion de documents scientifiques de niveau recherche, publiés ou non, émanant des établissements d'enseignement et de recherche français ou étrangers, des laboratoires publics ou privés.

SENSOR OPERATING PRINCIPLES

Piet Bergveld and Daniel R. Thévenot

OUTLINE

1. Introduction	32
2. Receptor: The Molecular Recognition Element	35
2.1 Immobilization of biological receptors	36
2.2 Inner and outer membranes	37
2.3 Biological receptor operating principles	39
2.4 Performance criteria	42
3. Electrochemical Sensing Principles	44
3.1 Theory of electrochemical equilibria	45
3.2 Ion-selective membrane electrode	49
3.3 Metal-metal oxide electrode	51
3.4 Reference electrode	52
3.5 Amperometric sensors	55
3.6 Mediated electron transfer	57
3.7 Voltammetric sensors	59
3.8 Conductimetric sensors	60

Advances in Biosensors

Supplement 1, pages 31-94

Copyright © 1993 JAI Press Ltd

All rights of reproduction in any form reserved.

ISBN: 1-55938-630-4

4. Ion Selective Field Effect Transistors	62
4.1 Introduction	62
4.2 ISFET transducer	62
4.3 ISFET recognition system	63
4.4 ISFET application	65
4.5 ISFET integrated reference electrode	66
4.6 ISFET calibration	68
4.7 Other ISFET-based biosensors	70
5. Optical Biosensors	72
5.1 Introduction	72
5.2 Optical fibres	73
5.3 Optical absorption	74
5.4 Optical reflection	76
5.5 Scattering	76
5.6 Fluorescence	77
5.7 Luminescence	78
5.8 Refractive index sensing	79
5.9 Other constructions	79
6. Mechanical Transducers: Piezo-electric Crystals and Surface Acoustic Wave Transducers	80
6.1 Introduction	80
6.2 Piezo-electric transducers	81
6.3 Surface acoustic wave transducers	84
7. Enthalpic or Calorimetric Transducers	85
8. Conclusion	87
References	89

1. INTRODUCTION

Most chemical sensors and especially those which are developed for *in vivo* monitoring, consist principally of two basic components, connected in series : a **molecular recognition system** and a **physico-chemical transducer**, as schematically given in Figure 1.

The molecular recognition system transfers information from the biochemical domain into a chemical or physical signal with a certain sensitivity. The main purpose of the recognition system is however to provide the sensor with a high degree of **selectivity** for the analyte to be measured.

CHEMICAL SENSOR

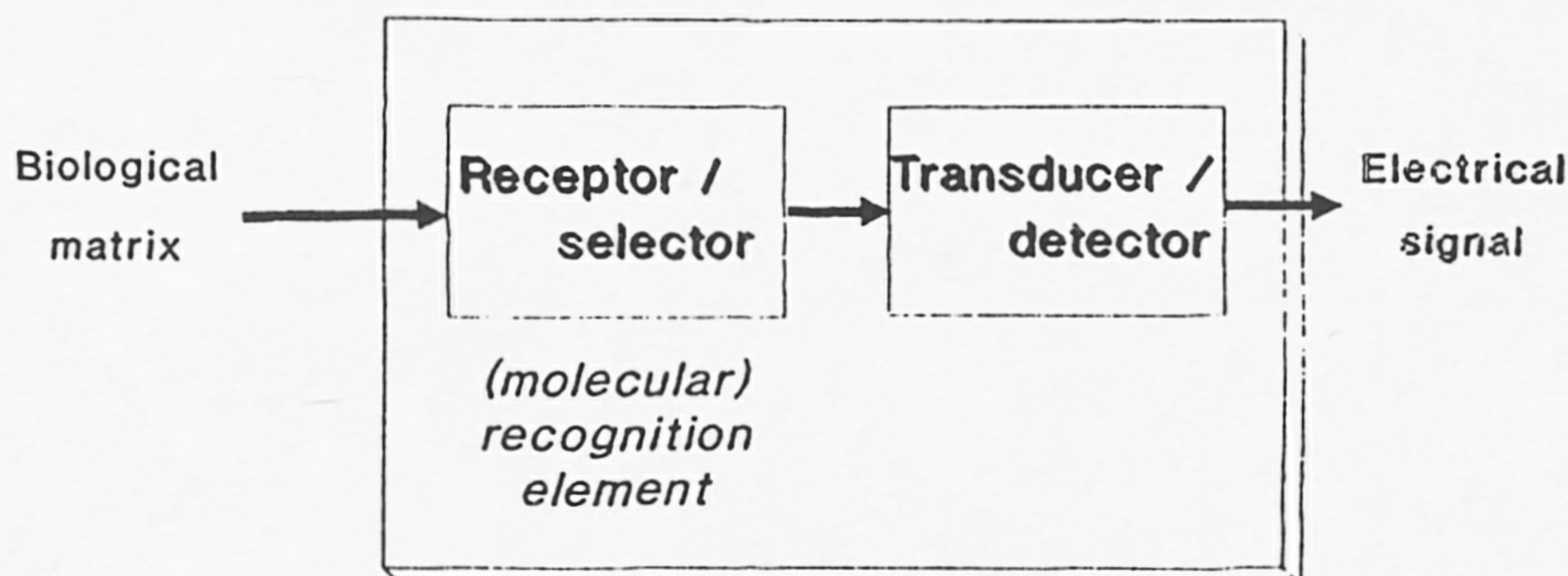

Figure 1. Schematic diagram of a chemical sensor.

Because in the natural chemical senses, such as olfaction, taste and neural biochemical pathways, the actual recognition is performed by chemoreceptor cells, the word **receptor** is also often used for the recognition system of a chemical sensor. In the more technical approach of a chemical analysis system, the notation **selector** is more appropriate and this is sometimes also used in relation to the recognition system of a chemical sensor.

The molecular recognition system may either be based on non-biological properties or on biological ones.

Non-biological receptors use generally metal electrodes, ion conducting inorganic or organic materials, or gas-permeable membranes covering metal or ion-conducting materials. In fact they are also electrochemical transducers.

Alternatively, biological receptors use biological macromolecules isolated from their original cells or tissues (enzyme, antibody/antigen or receptors), whole cells (bacteria, yeast) or tissue cultures. Section 2 describes standard immobilization procedures for their biological receptor parts, the role of possible additional inner or outer membranes and their biological receptor operating properties.

In many chemical sensors several recognition systems are being put in series, resulting in multiple signal transfer. Examples of single and multiple signal transfer are listed in Table 1, limited to the most common sensor principles and excluding existing laboratory instrumentation systems. The given types of measurement will be the guideline for the further subdivision of this chapter.

Table 1. Specific species recognized by different types of receptors and the corresponding types of measurement.

Recognition of measurement	Receptor/selector	Type of measurement
(1) Ions	Metal oxides	Potentiometric
	Inorganic crystals	Potentiometric
	Immobilized ionophores	Potentiometric
	Doped glasses	Potentiometric
(2) Dissolved gases	Hydrophobic membrane	In series with (1)
	Metal Electrode	Amperometric
(3) Neutral molecules	Enzyme	Amperometric or potentiometric; in series with (1) or (2), or metal electrode, piezoelectric, calorimetric, conductimetric
		Whole cells
(4) Antibody/antigen	Membrane receptors	as above
	Living tissue	as above
	Antigen/antibody	Potentiometric Piezoelectric Optical
	Enzyme labeled	In series with (3)
(5) Various proteins	Flourescent labeled	Optical
(6) Microorganism	Specific ligands	as (4)
	Bacteria	as (2) or (3)

The **transducer** part of the sensor serves the signal transfer from the output domain of the recognition system to, mostly, the electrical domain. In case of optical sensors this is the optical domain, but the optical signal will always be transferred to an electrical signal, due to the fact that data handling, such as amplification, storage and processing, has up to now always been performed in the electrical domain.

Electrochemical transducers are described in terms of their operating properties in Section 3, with Section 4 being devoted specifically to ion selective field effect transistors (ISFETs). Section 5 is devoted to optical biosensors, whereas Section 6 introduces mechanical transducers (piezo-electric crystals and surface acoustic waves) and Section 7 enthalpic or calorimetric transducers.

Beyond the general significance of the word, a transducer is defined as a bidirectional signal transfer device (non-electrical to electrical and vice versa); the transducer part of a sensor is also called **detector**, or simply, sensor. A transducer which transfers a signal from the electrical to the non-electrical domain is called an actuator. Examples of transducer types, which are typically used for the types of measurement listed in Table 1, are given in Table 2, together with examples of analytes which have been measured with them.

2. RECEPTOR: THE MOLECULAR RECOGNITION ELEMENT

As presented in Table 1, the molecular recognition system may either be based on non-biological properties or on biological ones. According to generally accepted definitions, sensors of the former type are called **chemical sensors** whereas the latter are chemical biosensors, or **biosensors** for short.

Non-biological receptors use generally metal electrodes, ion-conducting inorganic or organic materials, or gas permeable membranes covering metal or ion-conducting materials. In fact they

Table 2. Types of transducer for classified types of measurement, with typical corresponding analytes measured by them.

Measurement type	Transducer/detector type	Analyte
Potentiometric	Ion-selective electrode (ISE) Glass electrode	K ⁺ , Cl ⁻ , Ca ⁺⁺ H ⁺ , K ⁺ ... CO ₂ , NH ₃
	Ion-selective field effect transistor (ISFET) EnzymeFET (ENFET)	H ⁺ , K ⁺ ... urea
Amperometric	Metal electrodes Mediated systems	O ₂ , glucose glucose
	Interdigitated electrodes	urea
Conductimetric	Crystal	immuno
	SAW	immuno
Calorimetric	Thermistor	urea, glucose
Optical	Planar waveguide	immuno
	Fibre optic	H ⁺ , CO ₂ , glucose
	Surface plasmon resonance (SPR)	immuno

are also **electrochemical transducers** and are described in Section 3 in terms of their operating properties, with Section 4 being devoted specifically to ISFETs.

Biological receptors include biological macromolecules isolated from cells or tissues (enzyme, antibody/antigen or receptors), whole cells (bacteria, yeast) and tissue cultures. For such analytical devices to be called biosensors, their biological receptor part should be immobilized on the surface of the transducer and they should not include additional separation or reaction steps as encountered in HPLC or FIA set-ups. On the other hand, such integrated devices may include some separation or amplification steps achieved by outer membranes or layers.

In the case of *in vivo* sensors, where continuous measurement is generally required, detectors should be reversible, that is return to their base line without hysteresis after substrate step-up and step-down: this excludes one-time devices such as those developed for *in vitro* clinical determinations (e.g. MediSense Exactech or various reacting strip devices for glucose monitoring in capillary blood) that self-destruct or become insensitive after a single measurement.

As chemical sensors using non-biological receptors are described in later sections of this chapter, we will now focus on biosensors and describe standard immobilization procedures for the biological receptor, the role of possible additional inner or outer membranes and the biological receptor operating properties. This discussion is illustrated by schematic diagrams of three types of biosensors which either detect, on the transducer, a co-substrate, a reaction product or a mediator (Figure 2).

2.1 Immobilization of Biological Receptors

Since the development of the enzyme-based sensor for glucose, first described by Clark in 1962, where glucose oxidase was entrapped between two membranes, there has been an impressive amount of literature on methods of immobilization and related biosensor development. These methods have been extensively reviewed elsewhere (Guilbault, 1984; Turner et al., 1987; Mosbach, 1988; Cass, 1990; Göpel et al., 1991; Blum and Coulet, 1991). Physical localization of the biological receptors (i.e. macromolecules, cells or

tissues) with high activity in a thin layer over the transducer surface can be achieved by a variety of procedures. The following procedures are the preferred ones:

- (a) **Entrapment behind a membrane**, where a solution of enzyme, a suspension of cells or a slice of tissue is simply retained as a thin film over the electrochemical or optical detector;
- (b) **Entrapment of microbial cells within a polyacrylonitrile or agar gel**;
- (c) **Reticulation or cross-linking of the enzyme with bifunctional reagent such as glutaraldehyde**, either alone or mixed with other proteins such as bovine serum albumin;
- (d) **Covalent attachment of the enzyme, antibody/antigen or membrane receptor/transport protein**, either directly on the transducer surface, or on an organic membrane maintained over it; in the latter case, preactivated membranes, such as Pall Biodyne, can be used directly for enzyme or antibody immobilization without further chemical modification of the membrane or macromolecule (Assolant-Vinet and Coulet, 1986).

Apart from this last example, reticulation and covalent attachment procedures are more complicated than entrapment ones, but are especially useful in cases where the sensor is so small that the appropriate membrane must be fabricated directly on the transducer (Bindra et al., 1991; Wilson et al., 1992). Under such conditions more stable and reproducible activities can be obtained.

2.2 Inner and Outer Membranes

Besides this reacting layer or membrane, many biosensors, especially those designed for *in vivo* applications, present one or several inner or outer layers (Figure 2). These membranes serve three important functions (Wilson and Thévenot, 1990, Wilson et al., 1992)

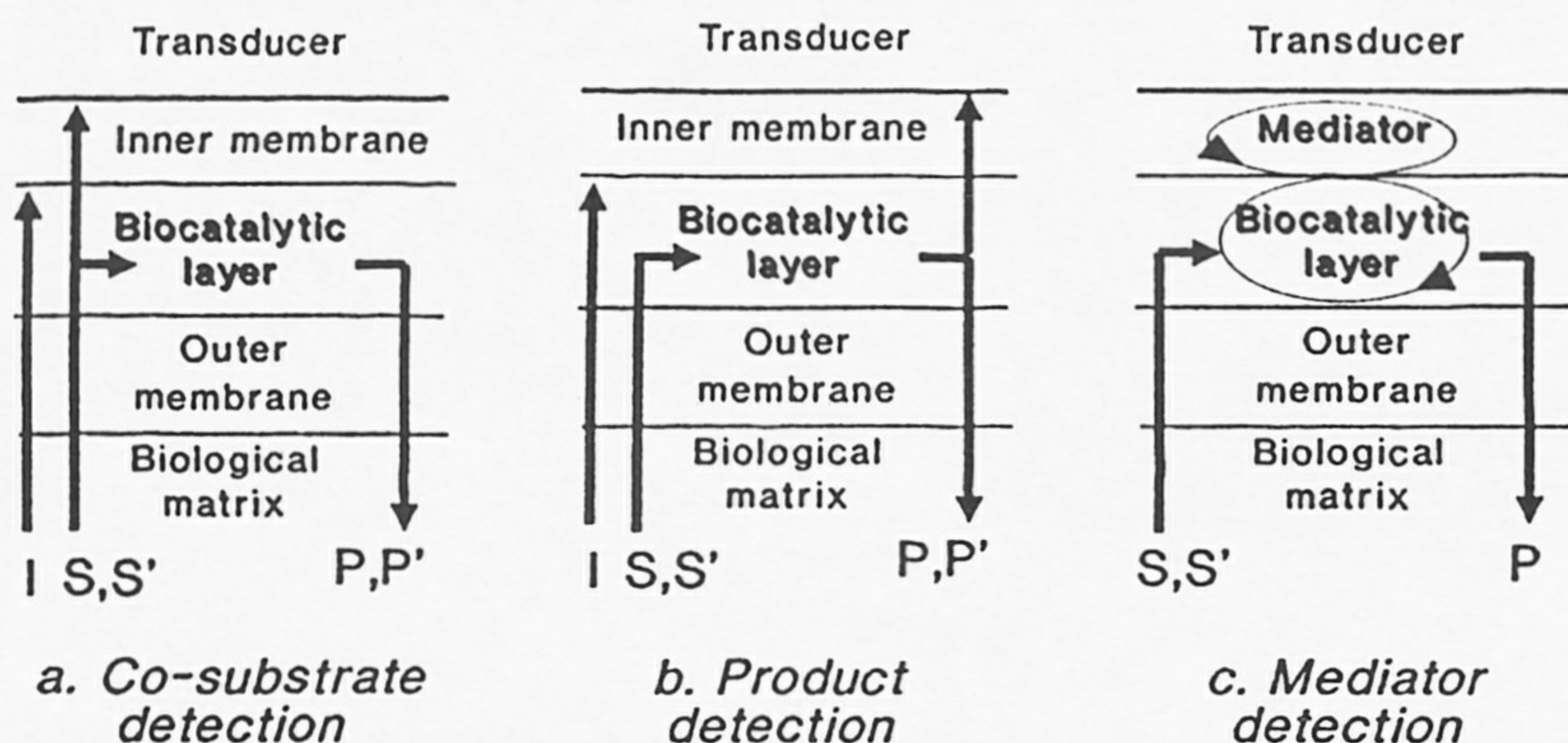

Figure 2. Schematic diagram of different types of biocatalytic chemical sensors: (a) reaction co-substrate S' , (b) product P and (c) mediator monitoring by transducer. Control of transducer interferent I with a permselective inner membrane. Control of analyte S and co-substrate S' levels in the biocatalytic layer with a permselective outer membrane.

2.2.1 Protective Barrier

The outer membrane prevents large molecules, such as proteins or cells of biological samples, from entering the reaction layer and interfering with it. In return, it prevents leakage of reacting layer components into the sample solution: this is, for example, important for implanted glucose sensors, since its glucose oxidase is of fungal origin. Furthermore, a properly chosen membrane exhibits permselective properties which may be additionally beneficial to the sensor function: it may decrease the influence of possible interferent species I' detected by the transducer (Figure 2). As shown in Chapter 8, devoted to European achievements, most *in vivo* or *ex vivo* glucose sensors present a negatively charged inner or outer cellulose acetate membrane in order to decrease the interfering effect of ascorbate or urate which is electrochemically detected together with enzymatically generated hydrogen peroxide.

2.2.2 Diffusional Barrier for the Substrate

As most enzymes follow some form of Michaelis–Menten kinetics,

enzymatic reaction rates are largely non-linear with concentration. Nevertheless, large linear dynamic ranges may be achieved if the sensor response is controlled by substrate diffusion through the membrane and not by enzyme kinetics. This condition is obtained by placing a thin outer membrane over a highly active enzyme layer.

2.2.3 Biocompatible and Biostable Surfaces

As described in Chapter 5, biosensors are subject to two sets of modifications when they are in direct contact with tissue or body fluids, i.e. implanted *in vivo*:

- modification of the tissue by various inflammation reactions caused by sensor implantation and toxicity of its elements;
- modification of sensor operating properties by tissue components or structure.

Apart from molecular recognition systems or transducers which necessitate direct contact between sample and biological receptor, the choice of such an outer layer is essential for the stability of the response after implantation. Depending upon sensor diameter (i.e. in the centimetre or submillimetre range), pre-cast membranes such as collagen, polycarbonate or cellulose acetate dialysis ones may be used, or alternatively polymeric materials deposited by dip- or spin-coating (cellulose acetate, Nafion or polyurethane). There have been numerous reports in the literature (Folkes, 1985) involving the use of polyurethane (PU) as a biocompatible material: as shown in Chapter 8, half of the reported *in vivo* glucose sensors present a PU outer layer. Unfortunately, commercially available PU is produced in widely varying weight-average molecular weights which possess different functional groups. Thus the transport properties of this material as a film will differ considerably from source to source (Wilson and Thévenot, 1990).

2.3 Biological Receptor Operating Principles

Biosensors may be classified according to the specificity-conferring mechanism of their biological receptor part.

2.3.1 Biocatalytic Receptor

The biocatalytic-based biosensors are the best known and most often studied and applied to biological matrices since the pioneering work of Clark (1962). One or several substrates S and S' react in the presence of enzyme(s), whole cells or living tissue cultures and yield one or several products P and P':

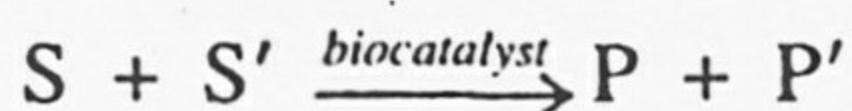

which is essentially an irreversible reaction.

Three strategies are possible for monitoring this biocatalyzed reaction with adjacent transducers (Figure 2):

- detection of co-substrate S' consumption (e.g. oxygen depleted by oxidase, bacteria or yeast reacting layers) and corresponding signal decrease from its background value;
- detection of P, one of the reaction products (e.g. hydrogen peroxide, H⁺, NH₃,...) and corresponding signal increase;
- detection of the biocatalyst turnover in the presence of substrate S, using an immobilized mediator which reacts rapidly enough with the biocatalyst and is easily detected by the transducer; various ferrocene derivatives (Pickup et al., 1989) as well as TTF⁺ TCNQ⁻ organic salts (Boutelle et al., 1986; Albery et al., 1990) have been used, for example, in implantable glucose sensors (see Chapter 8).

The last strategy attempts to eliminate sensor response dependence on co-substrate concentration and to decrease the influence of possible interfering species. The first goal is only reached when reaction rates are much more rapid for immobilized mediator with biocatalyst than for co-substrate with biocatalyst (Löffler et al., 1991). An alternative to the use of such mediators involves restricting analyte concentration within the reaction layer through an appropriate outer membrane, the permeability of which is strongly in favour of co-substrate transport (Bindra et al., 1991).

2.3.2 Biochelating Receptor

The most developed examples of biosensors using biochelating receptors are based on immunological reactions, such as binding of

an antigen (Ag) to a specific antibody (Ab). Production of such Ab–Ag chelates has to be distinguished from non-specific interaction by using an appropriate surface treatment step. Each Ag determination requires a special Ab production and its purification-isolation. Some attempts have been described to monitor directly the Ag–Ab chelate formation on field effect transistors (IMFETs) (see Section 4.7.2), silver surfaces by plasmon resonance (SPR) (see Section 5.8) or on piezo-electric crystals (see Section 6). In order to increase the sensitivity of such immunosensors, enzyme or fluorescent labels are frequently coupled to antibodies, thus requiring additional chemical activation steps. Even in the case of enzyme-labelled Ab, such biosensors will essentially operate at equilibrium, the enzymatic activity being there only to quantify the amount of chelate produced. As the chelation reaction constant is usually very large, such systems are either irreversible (one-time devices) or placed within a FIA environment where Ab may be regenerated by dissociation of chelates in acid conditions, such as glycine–HCl buffer at pH 2.5 (Guilbault et al., 1992). This procedure makes them inapplicable for *in vivo* implantation. Their main application is at present for *in vitro* monitoring.

An alternative to this immunological approach is the reversible affinity binding of glucose to concavalin A detected with a fluorescent-labelled dextran, leading to a fluorescent-based implantable glucose sensor (Mansouri and Schultz, 1984) (see Section 5.6).

Very recently, attempts have been made to use ion channels or membrane receptors as molecular recognition systems in conductimetric, ISFET or optical sensors. For example, the transport protein lactose permease (LP) may be incorporated into liposome vesicles allowing a coupling of the sugar transport to proton transport with a stoichiometric ratio of 1:1, as demonstrated with the fluorescent pH-probe pyranine entrapped in these liposomes (Kiefer et al., 1991). Such LP containing liposomes have been incorporated within planar lipid bilayer coatings of an ISFET gate sensitive to pH: preliminary results have shown that such modified ISFETs enable a rapid and reversible detection of lactose in a FIA setup (Ottenbacher et al., 1992).

In conclusion, biochelating-based biosensors present promising possibilities but have not yet reached the stage of development of

biocatalytic sensors, especially for *in vivo* or *ex vivo* usage of biosensors. Being based on equilibrium reactions, they offer a very narrow linear range of calibration curves and are often irreversible. Furthermore, some types of these biosensors may find difficulties for *in vivo* applications since their active layer has to be in direct contact with the sample and thus no outer membrane can be used for clearly separating the sensor from the biological matrix.

2.4 Performance Criteria

As for any sensor based on molecular recognition, it is important to characterize biosensor responses: it is even more important here since such operating parameters may reveal the nature of the rate-limiting steps (transport or reaction) and help biosensor optimization in a given biological matrix. Chapter 3 describes performance assessment methods of chemical sensors for *in vivo* monitoring, together with related clinical specifications. This section will thus briefly list main performance criteria, usually determined both *in vitro* and *in vivo*, and discuss their relation with properties of the receptor and transducer parts of the biosensor.

2.4.1 Sensitivity, Linearity and Detection Limits

Sensor calibration is performed, in general, by adding standard solutions of the analyte and by plotting steady-state responses R_{ss} , possibly corrected for a background signal R_{bg} , versus the analyte concentration C or its logarithm. Transient, often called dynamic, responses are of major importance for clinical instruments used *in vitro* but are less significant for *in vivo* measurements.

The sensitivity and linear range of calibration curves is determined by plotting the ratio $[R_{ss} - R_{bg}]/C$ or $[R_{ss} - R_{bg}]/\log C$ versus $\log C$. This method is much more definitive than plotting the usual calibration curves $[R_{ss} - R_{bg}]$ versus C or $\log C$ since it gives the same weight to low and high analyte concentration results.

The limit of detection can be determined by comparison of background signal fluctuations and signal response. A signal/noise ratio of 2 is usually chosen as the limit definition. *In vitro* experiments usually generate much less noise, including interference disturbances, than *ex vivo* flow-through and especially *in vivo* experiments.

2.4.2 Selectivity

Selectivity depends upon the choice both of the biological receptor and the transducer.

Most enzymes, except alcohol or amino-acid oxidases, are very specific. In contrast, bacteria, yeast or tissue cultures are by essence non-specific.

Whereas oxygen electrodes, pH-specific electrodes, ISFETs or optrodes are very selective, metal electrodes are often sensitive to numerous interferences. This direct selectivity may be modified when these transducers are associated with receptors. For example, responses of enzyme-based field effect transistors (ENFETs) are influenced by the buffering capacity of the sample, since part of the released protons are consumed by the buffer and only the residual protons are sensed by the transducer. In this case, it is in fact the sensitivity of the sensor which is modified and not its selectivity.

When transducer interferences are well identified, such as ascorbate or urate in hydrogen-peroxide detecting glucose sensors, their influence may be restricted by the application of appropriate inner or outer membranes (Figure 2). Alternatively, a compensating sensor may be introduced in the set-up, with no biological receptor present on its surface (Thévenot et al., 1979). Such a differential set-up is currently used with ISFET or ENFET-based sensors (see Sections 4.5 and 4.7).

Finally the reliability of chemical sensors has to be estimated under physiological conditions, that is in the presence of possible interferences. In order to be reliable for a clinician, sensor response should be directly related to the monitored species and not vary with physiological fluctuations of interferences.

2.4.3 Response Time

Response times are easily determined *in vitro* for each analyte pulse into the cell and are measured to 90 or 95% of the steady-state response. They depend upon analyte, co-substrate and product transport through different layers or membranes: their thickness and permeability are critical. They depend also upon the activity of the molecular recognition system: the higher this activity, the smaller is this response time. Finally, when sensors are implanted *in vivo* their global response time also incorporates the analyte and co-substrate

transport towards the sensor site (see Chapter 4).

Theoretical modelling of biosensor operation enables a better understanding of the respective importance of these numerous factors on response time (Eddowes, 1990). Their practical use is somewhat limited by the necessity for knowledge of a large number of sensor parameters (thickness, partition and diffusion coefficients of each membrane or layer for each species, distribution of biocatalytic or biochelating activity within the sensor layers, transducer operating properties, etc.). Often such modelling is restricted to steady-state operation and is unable to evaluate response times (Albery and Craston 1987).

2.4.4 *Stability and Life Time*

The stability of a biosensor response may vary considerably depending on the sensor geometry and preparation method, as well as the receptor and transducer used. Although some biosensors have been reported as usable *in vitro* for periods of more than one year (Thévenot et al., 1982), their practical life time when implanted *in vivo* is either unknown or limited to a few hours or days (see Chapter 5). If it is relatively easy to determine *in vitro* stability of biosensors both during storage and operation in the presence of analyte (Bindra et al., 1991), procedures for assessing their behaviour during several days of implantation is much more complex and difficult to interpret (Moatti et al., 1992).

3. ELECTROCHEMICAL SENSING PRINCIPLES

The first three types of measurements, as listed in Table 2 at the beginning of this chapter, are all based on electrochemical phenomena, occurring at an interface between an electrolyte and a solid-state electrode (potentiometry, amperometry, voltammetry), or in a layer of an electrolyte (conductimetry), as function of a chemical or biochemical parameter. In order to understand the operational mechanisms of the related electrodes and, in relation to this, the possible applications of these types of biosensor, a short introduction will be given to the theoretical background. Because an electrode consists of an electronic part and an ionic part, the theory will be

divided to describe these separately, before combining these to form a description of a complete electrode.

3.1 Theory of Electrochemical Equilibria

3.1.1 Solid-State Junction

If we consider the thermal equilibrium condition of a solid-state junction, for instance a p-n junction, the zero net electron and hole currents require that the Fermi level E_F must be constant throughout the sample. This results in a diffusion potential $\Delta\phi$, which follows simply from:

$$E_F = E_{F1} + q\phi_1 = E_{F2} + q\phi_2 \quad (1)$$

where E_{F1} and ϕ_1 are respectively the Fermi energy and the electrical potential of phase 1 while E_{F2} and ϕ_2 are the same for phase 2, resulting in:

$$\Delta\phi = \phi_2 - \phi_1 = \frac{1}{q} (E_{F1} - E_{F2}) \quad (2)$$

So the contact potential between two electronic conductors is completely determined by their Fermi levels, which can be approximated in the case of semiconductors with Boltzmann's distribution as:

$$E_F = E + kT \ln F(E) \quad (3)$$

where E is the kinetic and potential energy of the charge carriers, k the Boltzmann constant, T the absolute temperature and $F(E)$ the Fermi-Dirac distribution function.

The contact potential is thus the result of a redistribution of charge carriers over the junction, maintaining the state of equilibrium, and can therefore not be measured. The system can not deliver energy. Only if energy is applied to the system a measurable contact potential will be available, for example a thermo voltage due to heating (ΔT) or a chemically sensitive voltage due to a specific chemical reaction (ΔE). Contact potentials are stable and reversible because the concentrations of charge carriers, electrons and/or holes, are well defined and are exclusively the only movable species across the junction.

3.1.2 Liquid-Liquid Interface

In studying physical chemistry or electrochemistry it is remarkable that principally the same laws are applied as those in solid-state physics, but with completely different symbols and easily misunderstood interpretations. The reason is that the two scientific fields have developed independently of each other. While the physicist counts per charge carrier with a charge q (Eqs. (1) and (2)), the chemist counts per gram molecule or mole, containing N ions, each having a charge q , resulting in the Faraday constant $F=Nq$. Also the factor kT (Eq. (3)) is multiplied by N , resulting in the gas constant $R=Nk$. Therefore the physical factor kT/q will be described by a chemist as RT/F , both being 26 mV at room temperature (300 K).

Furthermore, the definition of Fermi energy E_F is for a chemist the same as the electrochemical potential $\bar{\mu}_i$, a slightly misleading notation for electrically oriented people, because it refers to the energy level of an electron or an ion i in a solution or solid:

$$\bar{\mu}_i = \mu_i + zF\phi \quad (4)$$

where μ_i is the chemical potential, z is the valence of the particular ion i and ϕ is the electrical potential.

If two solutions 1 and 2 with different concentrations of a particular ion i are separated by a membrane which is permeable for that ion, a voltage can be measured over the membrane, from which the value can be calculated according to Eq. (1):

$$\bar{\mu}_i = \mu_{i1} + zF\phi_1 = \mu_{i2} + zF\phi_2 \quad (5)$$

Therefore, according to Eq. (2) for the solid-state case, a similar expression for the liquid-liquid junction yields:

$$Df = \phi_2 - \phi_1 = \frac{1}{zF} (\mu_{i1} - \mu_{i2}) \quad (6)$$

The chemical potential μ_i can be written as

$$\mu_i = \mu_o + RT \ln a_i \quad (7)$$

where μ_o is the standard chemical potential and a_i is defined as the ion activity, related to the concentration c_i by $a_i = \gamma_i c_i$. The factor γ_i is the so-called activity coefficient which depends on the overall concentration of the liquid and equals 1 when the solution is

infinitely dilute. For not very concentrated solutions (i.e. lower than 0.1 mM) $\gamma_i = 1$ is often used and a_i can be interpreted as the concentration c_i . Because in this case $\mu_{o1} = \mu_{o2}$ it follows from Eqs. (6) and (7) that

$$\Delta\phi = \frac{RT}{zF} \ln a_{i1}/a_{i2} \tag{8}$$

$\Delta\phi$ is a measurable voltage because the diffusing ions can be delivered by chemical reactions at the measuring electrodes. This voltage will be constant as long as a_{i1} and a_{i2} are constant. If only one of the ion activities is constant, $\Delta\phi$ will be a function of the other ion activity with a sensitivity of RT/zF . A liquid membrane and a glass membrane electrode operate according to this principle.

The analogy between solid-state physics and physical chemistry regarding the interfacial equilibria is summarized in Figure 3.

The difference between the two types of interface is not only the difference in symbols; the availability of chemical energy in the liquid–liquid type, as well as the possibility that then also the diffusing charge carriers can have a charge larger than unity ($|z| > 1$), but that there are also as many different ions as there are chemical elements and molecules which can be involved in the process. In practice this will lead to undesired interferences, which means that special materials have to be chosen for the electrodes which have a large selectivity for only one type of ion.

3.1.3 Solid–Liquid Interface

Starting with the definition given above, the expressions which

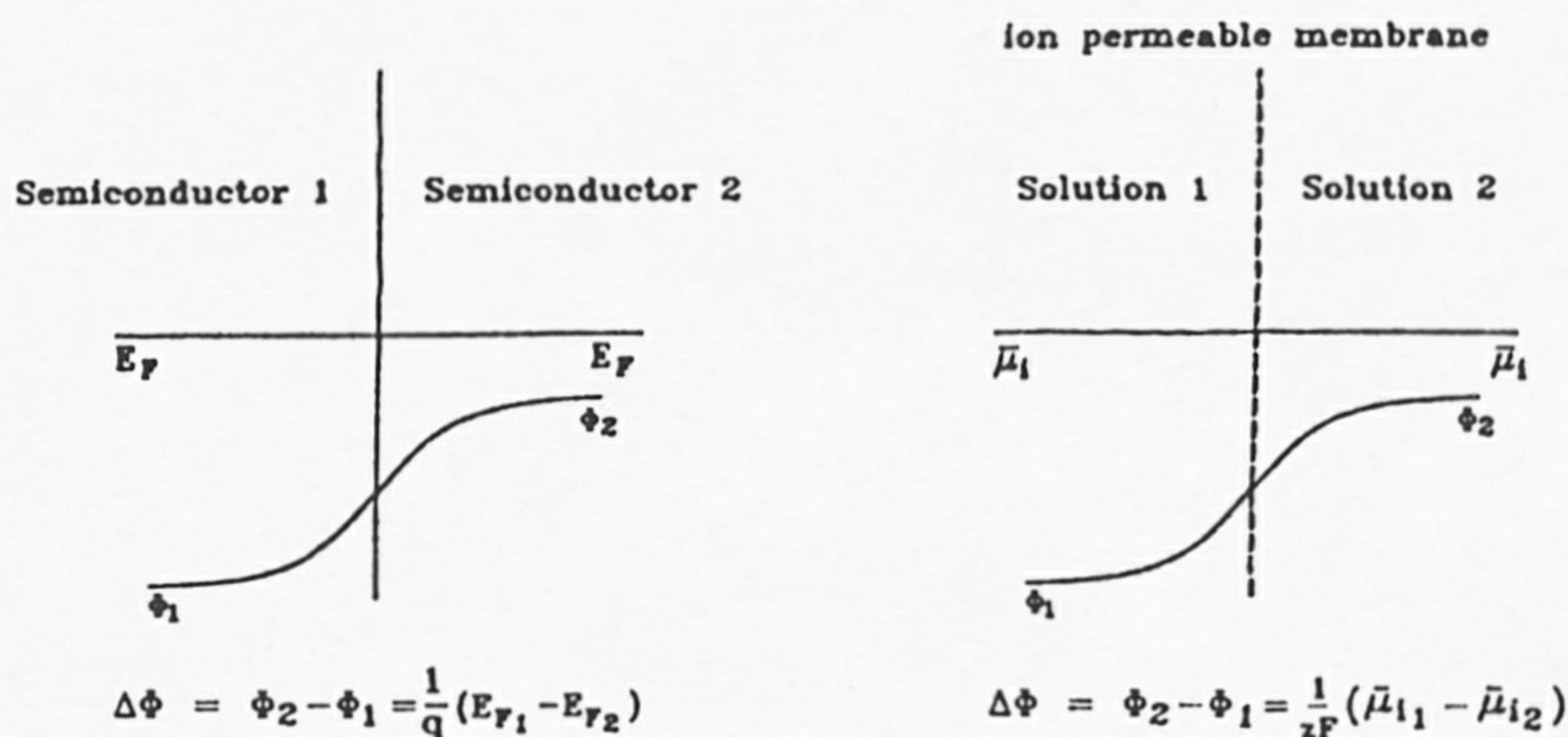

Figure 3. Comparison between an interfacial equilibrium at a semiconductor–semiconductor and a liquid–liquid interface.

describe the contact potential between a solid and a liquid can now be determined.

If an electrode of a certain metal M is immersed in an aqueous solution with contains M^+ ions, the conditions as given in Eq. (6) will also be valid. Because the standard chemical potentials are, however, not equal in this case ($\mu_{o1} \neq \mu_{o2}$), Eq. (8) will contain now an additional term $(1/zF)(\mu_{o1} - \mu_{o2}) = E^{\circ}$, resulting in an electrode potential:

$$\Delta\phi = E^{\circ} + \frac{RT}{zF} \ln \frac{a_{i1}}{a_{i2}} \quad (9)$$

It will be clear that the electrode potential will be constant as in both phases the concentration of the potential determining ions is constant. Because in the particular case $a_{i2} = 1$ by definition (the metal phase), $\Delta\phi = E^{\circ}$ for the condition that also $a_{i1} = 1$ (metal ions in the liquid phase). E° is called the standard electrode potential, from which the value can be found in the IUPAC table for half-reactions, defined with respect to the hydrogen electrode (NHE). For example:

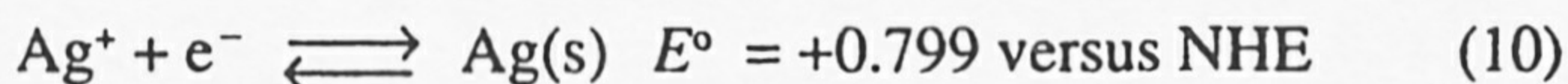

With this redox reaction the electrochemical potential μ_{Ag^+} of Ag^+ ions in the solution is related to the Fermi level of the electrons in the solid Ag(s) . Hence in the case of a silver electrode in a diluted silver nitrate solution the electrode potential is:

$$\Delta\phi = 0.799 + 0.059 \log c_{\text{Ag}^+} \quad (11)$$

which means that the electrode acts as a Ag^+ ion sensitive electrode, giving 59 mV per decade $[\text{Ag}^+]$. Unfortunately a metal electrode will seldom only be used in pure solutions of its own ions. Many other ions will exist as well as dissolved gases such as O_2 . This means that other redox reactions may also occur at the electrodes, interfering with the original reaction such as those given by Eq. (10). For example, the reduction of dissolved oxygen according to:

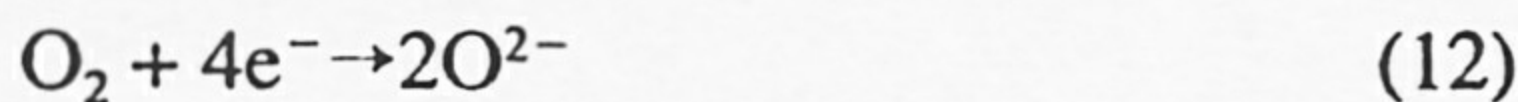

may change the value of $\Delta\phi$ as given in Eq. (11) tremendously. Therefore metal electrodes are, in general, not applicable for ion sensing in liquids. A solution to this problem is the introduction of an intermediate layer between the metal and the liquid, of which the Ag-AgCl electrode is the most well-known example.

An Ag–AgCl electrode consists of a silver disk or wire, on which a hardly solvable layer of silver chloride is electrolytically deposited in a sodium chloride solution. Two interfaces can now be distinguished, which can both be in perfect equilibrium, because one and only one charge carrier will be responsible for determining the interfacial potential. At the Ag/AgCl interface it is the Ag^+ ion and at the AgCl/liquid interface the Cl^- ion, which ensures that the electrode is only stable in solutions which contain a fixed concentration of Cl^- ions. The overall potential is:

$$\Delta\phi = 0.2224 - 0.059 \log a_{\text{Cl}} \quad (13)$$

which shows that the Ag/AgCl electrode is a perfect Cl^- ion sensitive electrode and it is also applied as such. The introduction of the intermediate layer results in this case in a well-defined coupling mechanism between an electronic and an ionic conductor and is generally applicable for all silver-salt membranes.

If the Ag/AgCl electrode is immersed in a solution with a constant Cl^- ion concentration, Eq. (13) predicts a constant electrode potential $\Delta\phi$. It means that in this way membrane potentials as given in Eq. (8) can be measured in a stable way by contacting the liquids on both sides of the membrane by Ag/AgCl electrodes, provided that the Cl^- ion concentrations are kept constant. Therefore membrane electrodes are filled with a KCl solution, while for contacting the sample solution a KCl saltbridge is applied as an intermediate. This will be explained in more detail in the section reference electrodes.

3.2 The Ion-Selective Membrane Electrode

All ion-sensitive membranes have in common the combination of a certain ionic conducting property with specific ion sensitivity at the interface. The most logical application is therefore to mount such a membrane between two liquids, from one of which the ion concentration has to be measured and the other with a constant ion concentration. As stated before, both liquids can be contacted by means of Ag/AgCl electrodes to provide a connection with an electronic measuring device. The classical glass membrane electrode is the most well-known example of an ion-selective membrane electrode (ISE). The operational mechanism is very obvious: the glass

hydrates to a certain extent and the electrochemical potentials will balance according to Eq. (5)

$$\bar{\mu}_{\text{H}^+}^{\text{sol}} = \bar{\mu}_{\text{H}^+}^{\text{glass}} \quad (14)$$

resulting in very stable interfacial potentials, linearly related to the pH of the solution. As the inner solution has a constant pH, the inner interfacial potential delivers a constant contribution to the output voltage of the electrode, as is the case with the contributions of the Ag/AgCl contact electrodes. Hence, a glass electrode at 300 K delivers an output voltage of:

$$V_{\text{out}} = V_{\text{const}} + 59 \text{ mV/pH unit} \quad (15)$$

This approach is generally applicable for all ion-conducting membranes, in whatever form or construction is chosen, such as sintered pellets, polymers in which electroactive compounds are embedded, etc. This type of electrode is usually called a solid-state electrode (Buck, R.P. et al. 1980) of which various performances are illustrated in Figure 4.

Miniaturization of this type of electrode for application in *in vivo* monitoring is difficult, because the impedance rises and the stability drops due to the dimensions, which makes the electrodes less reliable. Also the internal solution makes the electrodes less suitable for biomedical applications. Therefore many attempts have been made to

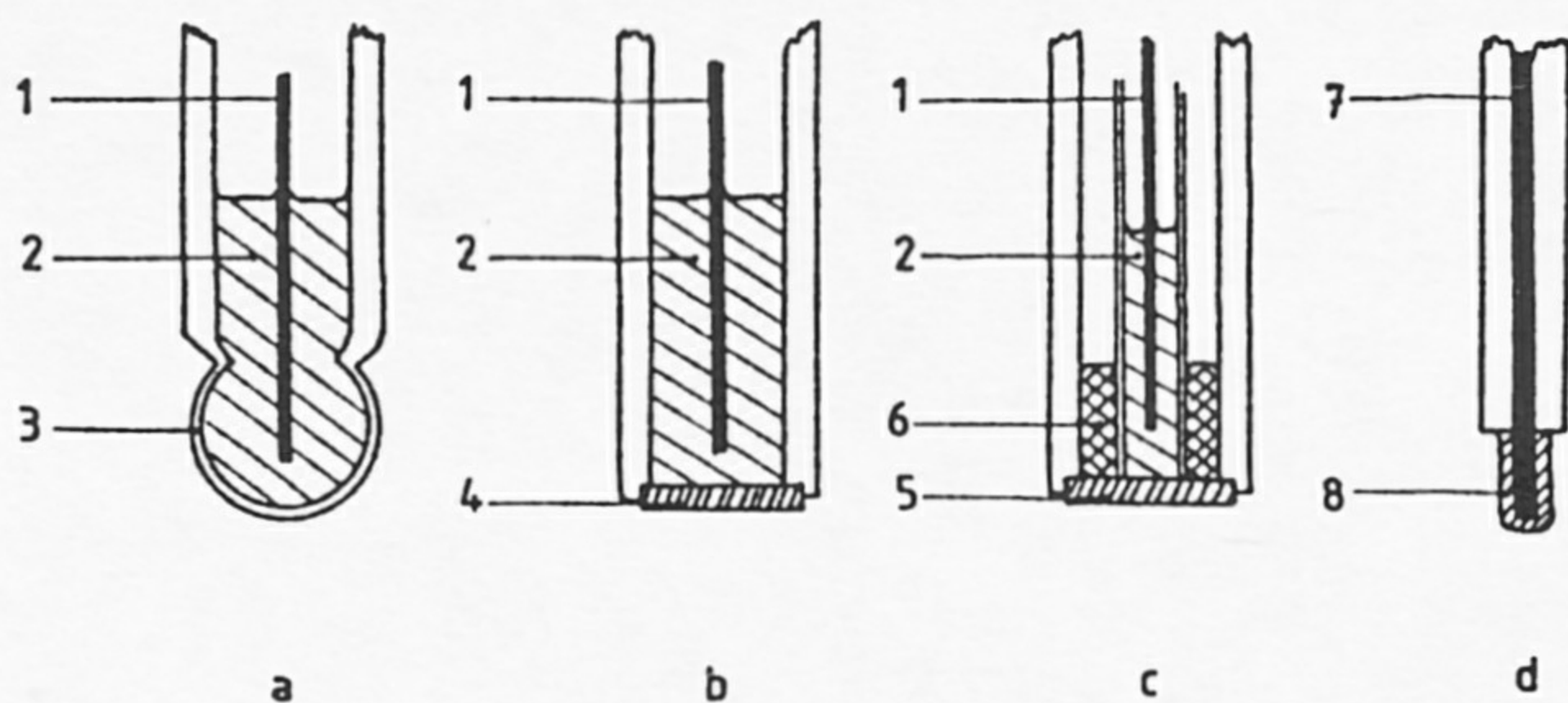

Figure 4. Various models of ion-sensitive electrodes. (a) glass membrane electrode; (b) solid-state membrane electrode; (c) liquid membrane electrode; (d) coated wire electrode. 1, Ag/AgCl electrode; 2, internal electrolyte; 3, glass membrane; 4, solid-state membrane; 5, porous substrate containing liquid membrane; 6, supply of liquid for liquid membrane; 7, metal wire; 8, membrane coating.

replace it by a solid-state contact. The result may be a coated wire electrode (Figure 3d). Le Blanc et al. (1976) as well as Cobbe and Poole-Wilson (1980) used a pH-sensitive polymer membrane, dip-coated over a pregelled Ag/AgCl electrode for continuous intravascular monitoring of blood pH. In fact they still make use of an internal wet contact although with miniscule dimensions.

A completely dry internal contact was realized by Afromowitz and Lee (1976), who deposited pH glass by means of the thick-film screening techniques (see Chapter 6) directly on top of a layer of silver, resulting in a very rugged sensor construction but unfortunately with rather poor characteristics. The reason is that no thermodynamic equilibrium is present at the inner contact which is a general drawback of most coated wire electrodes.

A better solid-state contact with a pH glass-membrane is reported by Fjeldly & Nagy 1985. The inner contact of the glass bulb of a commercial glass electrode was established by the reaction of silver fluoride while heating in a gas flame. Auger depth profiling analysis indicates that in this way a suitable, gradual junction is established, resulting in a stable electrical contact. This process is, however, not generally applicable for all types of membranes which often consist of a polymer with incorporated ionophore.

A more promising approach is the application of a metal-oxide on a metal electrode, because these operate due to an intrinsic thermodynamic equilibrium of the whole system.

3.3 The Metal–Metal Oxide Electrode

A special class of ion-sensitive electrodes is formed by the metal–metal oxide electrodes such as PtO_2 , IrO_2 , Sb_2O_3 , etc. (Glab et al., 1989). The oxides appear to behave as electronic conductors, which means that the metal–metal oxide interface is determined by the equilibration of the Fermi level of the electrons. The interface is in fact a normal ohmic contact and the oxides can also be deposited on other substrate metals than their own metal ions.

The pH sensitivity of the metal oxides does not depend on only one simple surface reaction at its liquid/oxide interface, as is the case with a glass membrane. In the whole material, including the bulk, the ionic and the electronic world are in thermodynamic equilibrium, controlled

by the solution pH. This mechanism can be represented by:

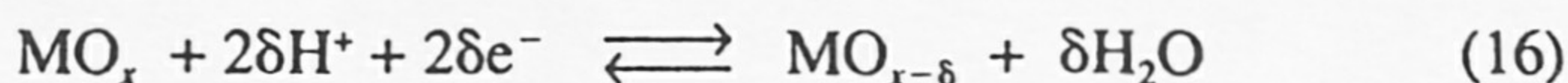

where MO_x and $\text{MO}_{x-\delta}$ are different oxide states.

Assuming the activity of water to be constant, the electrode potential can be calculated from Eq. (16):

$$\Delta\phi = E^0 + 2.3 \frac{RT}{F} \log a_{\text{H}^+} \quad (17)$$

which is 59 mV/pH unit at 25°C.

In the metal-metal oxide group of pH sensors, the antimony oxide electrode is the most intensively investigated solid-state pH electrode, especially for application as a *in vivo* sensor. The first biomedical use was reported as early as 1927! (Buytendijk, 1927). Originally use was made of polycrystalline antimony, but these electrodes were irreproducible, especially with respect to the stability of the electrode potential. The stability is greatly improved by using monocrystalline material. Although the exact operational mechanism is still under investigation, antimony oxide electrodes are already used in many practical *in vivo* investigations of pH monitoring (Edwall, 1979).

Beside antimony oxide electrodes, iridium oxide electrodes appear also to behave very well and are therefore interesting candidates for *in vivo* monitoring. Metal oxides which are insulators instead of conductors, such as SiO_2 , Al_2O_3 and Ta_2O_5 , cannot be used in a simple electrode construction like the Sb_2O_3 and IrO_2 electrodes. The insulating properties prevent a surface potential being measured. A way round of this problem is the application of these materials as gate dielectric layers of ion sensitive field effect transistors (ISFETs). This will be explained in more detail in Section 4. Regardless which type of ion selective electrode is used, a glass or polymeric membrane electrode, a coated wire or a metal oxide electrode, they are all used in an aqueous solution which has to be contacted by a stable reference electrode. Therefore the reference electrode will be treated in more detail in the next section.

3.4 The Reference Electrode

As has already been mentioned, potentiometry is the field of

measurement where an ion selective electrode is part of an electrochemical cell. An electrochemical cell consists by definition of two electrodes, separated by at least one electrolyte phase. Between the electrodes a voltage exists, which is measured by a kind of voltmeter. The voltage is in fact resulting from the series connection of the electrode potentials and the contribution of the separate electrode potentials cannot be distinguished. This means that, if one of the electrodes is an ion selective one, the other one should supply a potential which is independent of the ion concentration to be measured, and any interfering ion. Such an electrode is called the reference electrode, of which the stability should be better than the desired resolution of the ion selective electrode. For instance, if a pH should be measured with a resolution of 0.01 pH-unit, a requirement for pH determination of blood, the stability of the reference electrode should be within 0.59 mV, assuming a sensitivity of 59 mV/decade for the pH electrode. This is a rather stringent requirement, especially for *in vivo* measurements.

The original approach to this problem was the application of a saltbridge between an Ag/AgCl electrode and the sample solution. The construction of such a salt bridge is rather simple: a glass tube which contains a saturated KCl solution in which the Ag/AgCl electrode is sealed and which makes contact with the sample solution by a sintered glass pellet at the end of the tube. A typical construction is drawn in Figure 5.

As already described in a previous section, the Ag/AgCl electrode develops a very constant potential in a chloride salt solution (Eq. (11)). In the sintered glass pellet the internal salt solution makes contact with the sample solution and because at this place a very large concentration gradient exists, a diffusion potential may arise, the so-called liquid/liquid junction potential (Eq. (8)). Because the mobilities of K^+ and Cl^- ions are, however, approximately equal and the transport of ions is forced to be exclusively K^+ and Cl^- , the liquid/liquid junction potential is theoretically zero. This is the reason that KCl is chosen as the saltbridge solution while furthermore the tube contains a hole at the upper end to provide a certain pressure on the liquid column, due to gravity. The stability of the reference electrode potential can be guaranteed only under these conditions. A further improvement of the system may be the application of an additional liquid barrier, a so-called double junction electrode.

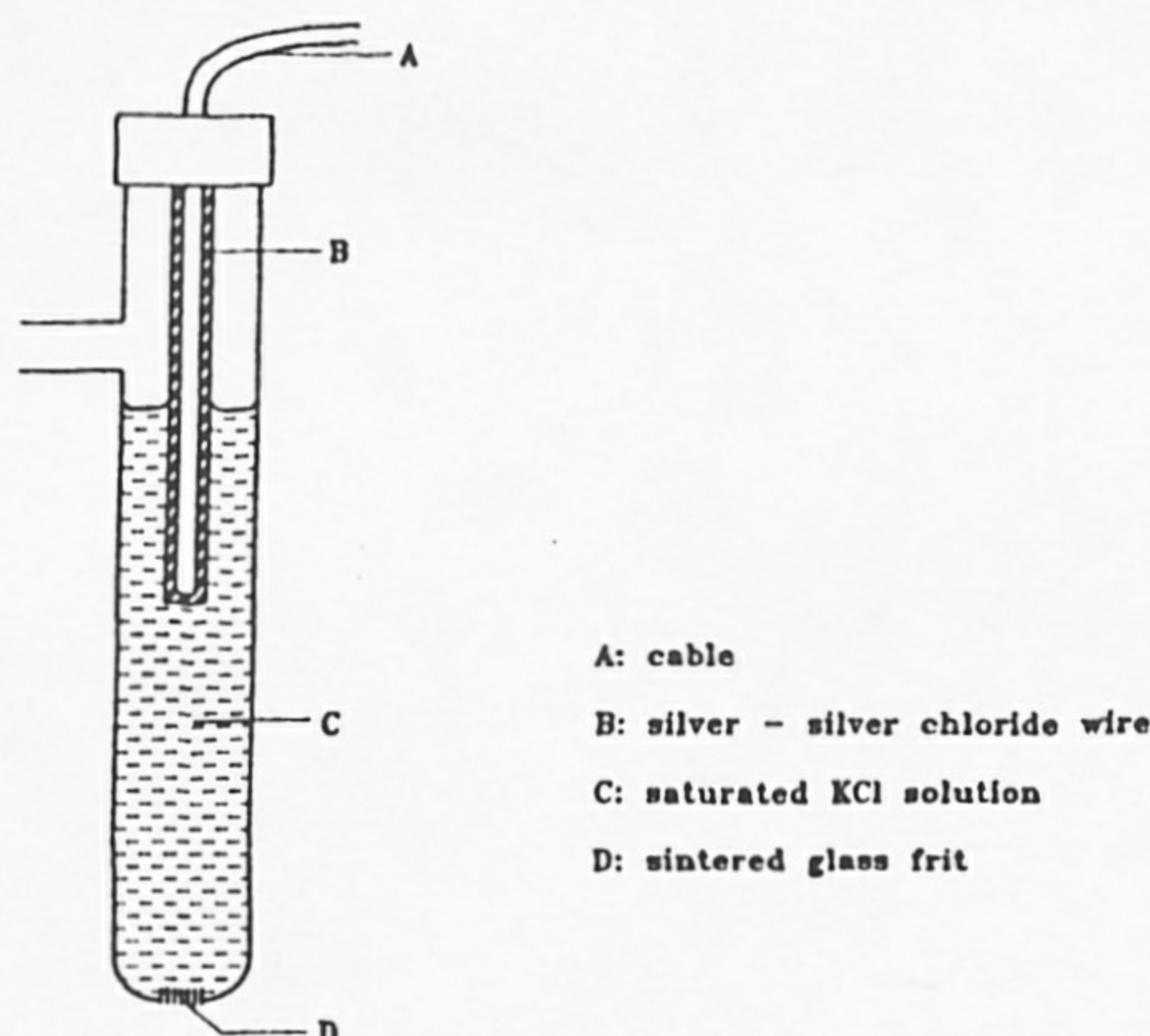

Figure 5. Schematic representation of Ag/AgCl reference electrode. A, cable; B, silver-silver chloride wire; C, saturated KCl solution; and D, sintered glass frit.

Instead of the application of the internal Ag/AgCl electrode, a Hg/Hg₂Cl₂ electrode, the so-called saturated calomel electrode (SCE), may be used. This is the reason that in many registrations of ion selective electrode potentials the notation versus SCE is used.

It will be obvious that the type of reference electrode as described above and in general use in chemical analysis potentiometric instrumentation systems, is in no way applicable for *in vivo* monitoring as a reference electrode for an ion selective electrode. In miniature, the system is very fragile and sterilization is problematic. The largest problem is, however, the contamination of the sintered glass pellet, which will influence the liquid/liquid potential, which actually determines the stability of the whole system. A solution to this problem might be the application of quite different materials. Margules et al. (1983) developed a polyurethane catheter type reference electrode with a poly-HEMA plug for the contact with blood and containing a gelled Ringer's solution as the saltbridge and a Ag/AgCl electrode. This approach appeared to be a usable alternative for the glass type electrodes, having a stability of 0.9 mV over a period of 8 hours in blood. Up to now no alternatives have been found with respect to the conventional construction of a reference electrode as described above. In Section 4 some attempts will be described to construct reference electrodes in a modern chip technology, to be

applied as integral parts of new chip sensors. Nevertheless, it may be stated here that the success of any development in the field of ion selective electrodes for *in vivo* monitoring will depend to a great extent on the availability of a suitable reference electrode. In that respect it should be recommended to extend the research efforts with respect to reference systems.

With respect to all potentiometric sensors as treated in the previous section it should be stated that potentiometry deals principally with the measurement of electrode potentials in an equilibrium state. Mass transport is therefore unimportant and the method is insensitive to movements of the sample solution, such as in streaming blood. However, the electrode kinetics must be fast to ensure a stable electrode potential. Because the output is an exponential function of concentration (Eqs. (15) and (17)), the dynamic range is large but on the other hand very sensitive to small errors in the total cell voltage. An error of only 1 mV corresponds to a 4% error in monocation or anion concentration. This imposes an extra requirement for the stability of the reference electrode.

3.5 Amperometric Sensors

In the previous sections potentiometric sensors have been treated as part of an electrochemical cell, of which the operational mechanisms relies on an equilibrium state at an ionic/electronic interface. It means that no electrical current flows through the cell.

Amperometric sensors are also part of an electrochemical cell, but now an external voltage is applied to the cell, resulting in an electrical current through the ionic/electronic interfaces of both electrodes. In this case the electrode potentials will deviate from the equilibrium state. Besides the fact that the current will cause a voltage drop over the electrolyte between the two electrodes, the cell potential will deviate from the value calculated from the standard potentials due to electrode polarization. This can occur at one or both electrodes, depending, among other things, on the electrode material and surface and on the composition of the solution. Because one is interested in the electrochemical behaviour of only one of the electrodes (the so-called working electrode), the other (counter) electrode is designed in such a way that its potential is not influenced by the current. Usually

this is provided by using a relatively large surface area, while the working electrode has a small area (Hall, 1990).

Electroactive species will now explicitly react at the working electrode and their concentration near the electrode surface will diminish and subsequently be replenished by diffusion from the bulk of the solution. As diffusion occurs at limited speed, concentration gradients will develop. Ultimately, the concentration of the reacting species will diminish to zero and the electrode current will completely be determined by diffusion. This value is called the limiting current.

In order to describe the behaviour of a current carrying electrode, a simple electrode reaction can be considered, in which a particle Ox is reduced to Red, according to the equilibrium reaction:

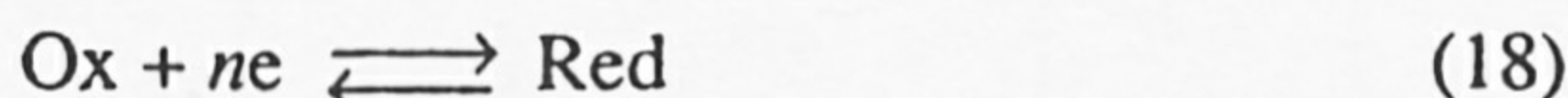

When no activation polarization occurs at the working electrode surface the potential on the working electrode is given by:

$$E_{\text{work}} = E^{\circ} - (RT/zF) \ln ([\text{Red}]_s / [\text{Ox}]_s) \quad (19)$$

where the subscript *s* denotes the concentration at the electrode surface. Using the equation for the applied cell voltage $E_{\text{appl}} = E_{\text{work}} - E_{\text{ref}}$ one obtains:

$$z(E_{\text{appl}} + E_{\text{ref}} - E^{\circ})/0.059 = \log([\text{Ox}]_s / [\text{Red}]_s) \quad (20)$$

E_{appl} thus controls the proportion between $[\text{Ox}]_s$ and $[\text{Red}]_s$ (formed at the electrode surface). When $[\text{Ox}]_s$ diminishes it is replenished by diffusion from the bulk solution with a speed proportional to the concentration difference of Ox between the bulk ($[\text{Ox}]$) and the electrode surface ($[\text{Ox}]_s$). The current flowing to maintain equilibrium is given by:

$$i = k([\text{Ox}] - [\text{Ox}]_s) \quad (21)$$

At a sufficiently low value of E_{appl} , $[\text{Ox}]_s$ becomes zero, making *i* proportional to $[\text{Ox}]$. The relation between the current and the applied voltage is shown in Figure 6. From this figure it can be seen that a wide region exists where the limiting current is independent of the applied voltage. Hence the requirements for stability of the potential of the reference electrode are less strict than the requirements occurring with a potentiometric measurement. Furthermore, the electrode current depends linearly on concentration, so that an

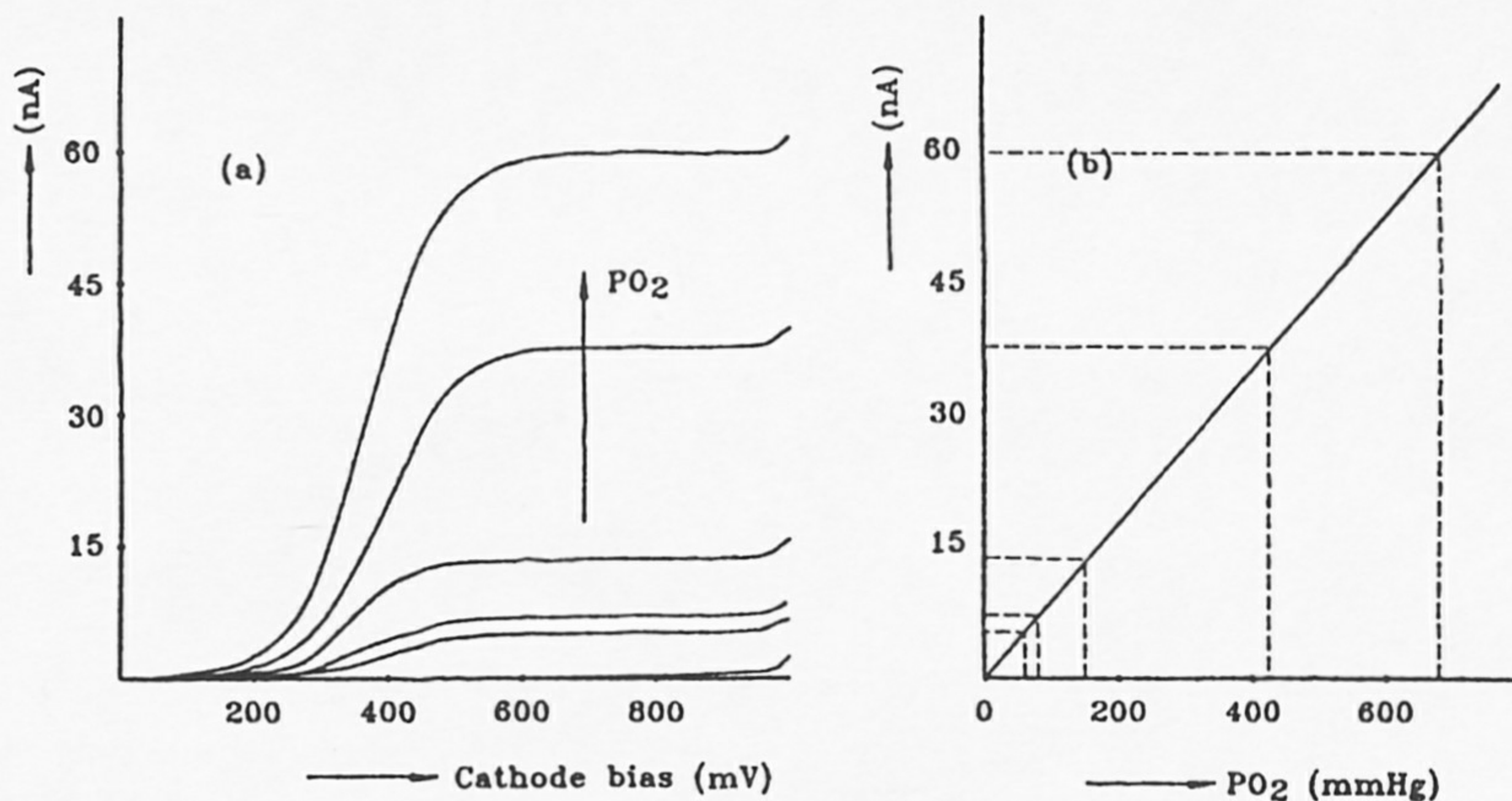
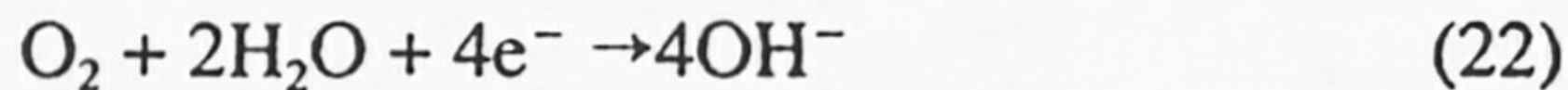

Figure 6. Current-voltage relationship for a simple reduction reaction.

eventual error in the current measurement results in a proportional error in concentration.

Because amperometric sensors rely principally on a transport limited current, this mass transport must occur in a controlled way. Therefore bare metal electrodes are seldom used for *in vivo* amperometric sensors, and a membrane is used to cover the actual electrode. This membrane also serves as a selector for those species which have to be monitored. A well-known example is the Clark-electrode for the measurement of p_{O_2} . O_2 which diffuses through the membrane reduces at the working electrode (the cathode) according to:



resulting in a current i proportional to p_{O_2} .

The membrane prevents the reduction of proteins at the cathode and furthermore makes the p_{O_2} measurement insensitive to bloodflow. More details concerning *in vivo* p_{O_2} measurements will be presented in Chapter 4, while in Chapter 1 other examples of amperometric sensors have been dealt with, such as glucose sensors.

3.6 Mediated Electron Transfer

To enhance the current resulting from redox reactions at the

electrode surface of an amperometric sensor several technologies have been developed. One of the methods to improve the electron transfer to the electrode is to modify the electrode. This is in a way the art of tailoring the electrode to the requirements of the biological redox system.

Much of the pioneering work on modified electrodes involved the adsorption of organic functional groups. This adsorption can be reversible or irreversible. These electron promoters enhance the electron transfer. An example is a modified carbon electrode, where a dicobalt co-facial porphyrin is adsorbed on the surface, thus catalyzing the four-electron reduction of oxygen at a considerably reduced potential.

An alternative approach to modified electrodes is to use a modifier that is specifically electro-active at the redox potential of a protein (e.g. glucose oxidase). The reactions occurring when a mediator is used are given by:

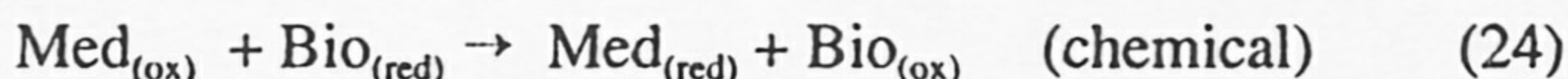
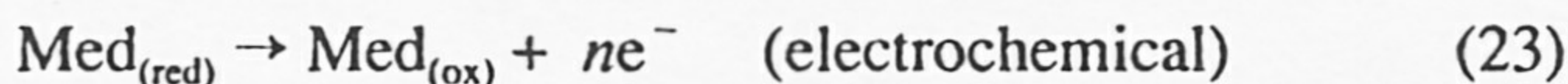

where Med denotes the mediator and Bio denotes the bio-redox system.

The mediator is a low-molecular weight redox couple with fast electrode kinetics. It can undergo homogeneous electron transfer reactions with any solution species (it can act as an electron donor or as an electron acceptor). In the case of Eq. (24) a homogeneous electron transfer with a bio-redox macromolecule occurs. The most successful redox mediator molecules are quinones, ferricyanide, organic dyes and ferrocene derivatives. These mediators do not need to be adsorbed to the electrode surface but for practical use the mediator must be suitable for immobilization with the enzyme on the electrode surface (Cardosi and Turner, 1991).

Summarizing the effect of mediators, it can be said that mediators provide an indirect path for electron transfer from an enzyme to the electrode. Another advantage of the use of mediators is the fact that by using a mediator with a low redox potential a lower applied operating potential than required by the original redox pair is possible and that accordingly less electrochemically active interferences may interfere with the sensor response.

The application of a ferrocene mediator for a glucose sensor is treated in detail in Chapter 6.

3.7 Voltammetric Sensors

Closely related to amperometry is the technology of voltammetry, which is especially frequently applied in analytical chemistry. In this technology voltage-current relationships are observed to study the electrochemical charge transfer reactions that take place at the electrode surface. In cyclic voltammetry (Hall, 1990) a voltage with a triangular waveform is applied to the cell and the current is measured.

Because the potential gradient has to be applied in a well defined way to the working electrode by means of the counter electrode, independent of the resulting current, a third electrode is used to measure the potential of the sample solution with respect to the working electrode. An electronic feedback system now controls the desired potential gradient. Voltammetric sensors consist therefore of a three electrode configuration.

The resulting i versus E curve shows current peaks at certain values of the applied voltage E . Each redox reaction occurs at a certain known value of the applied voltage (these values can be found in redox tables). At this point the reaction is completely controlled by diffusion. The magnitude of the peak is directly proportional to the concentration of the species taking part in the reaction occurring at the applied voltage where the current peak occurs. An example is given in Figure 7.

Here a reversible redox reaction like the reaction given in Eq. (18) takes place. Reduction of Ox (in the figure denoted by M) gives rise to a peak current i_p occurring at the applied voltage E_1 . Likewise a peak current occurs when re-oxidation of Red (in the figure denoted by M^-) takes place at the applied voltage E_2 . The maximum current of the two peaks should be equal for planar diffusion given by the Randles-Sevcik equation:

$$i_p = -0.4463nF (nF/RT)^{1/2}C_0D^{1/2}\nu^{1/2} \quad (25)$$

which at room temperature (26°C) reduces to:

$$i_p = -2.69 \times 10^5 n^{3/2}C_0D^{1/2}\nu^{1/2} \quad (26)$$

In these equation n denotes the number of electrons exchanged in the

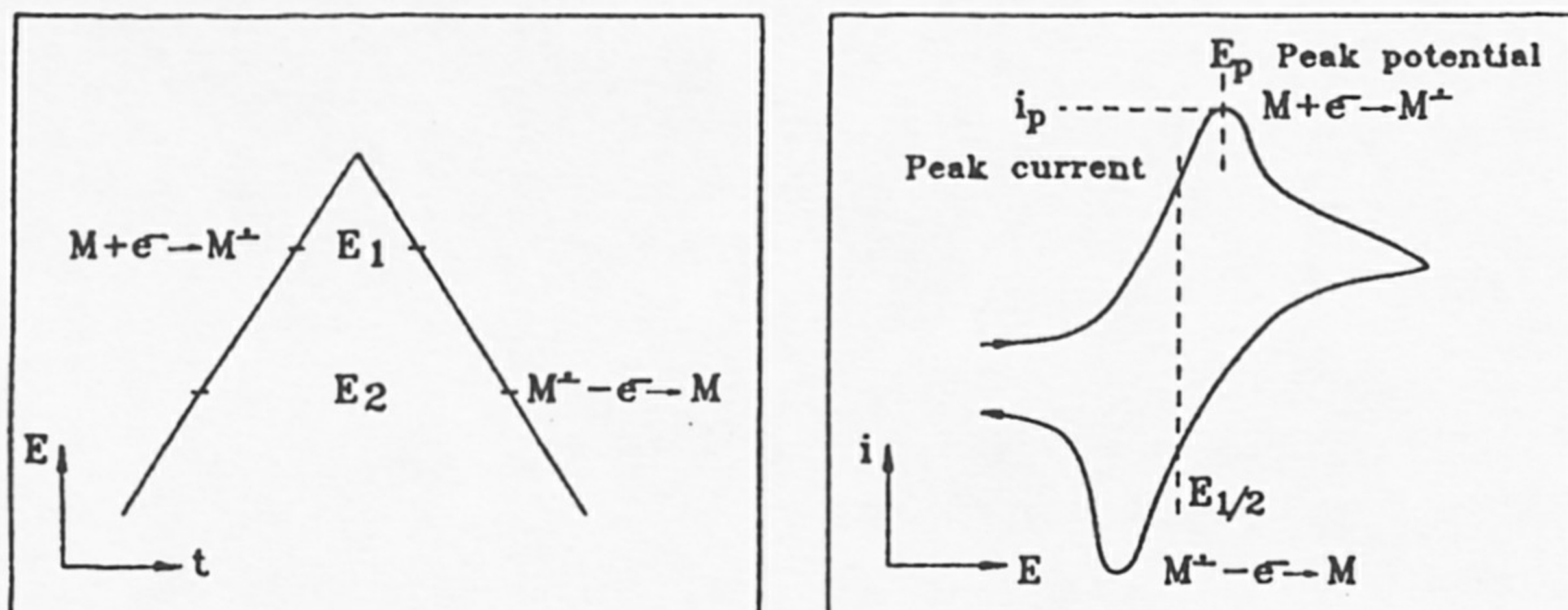

Figure 7. E versus t and E versus i profiles for cyclic voltammetry (Hall, 1990, p.100).

redox reactions, F denotes Faradays constant, R denotes the gas constant, T denotes temperature, C_0 denotes the bulk concentration, D denotes the diffusion coefficient and v denotes the potential scan speed.

The peak separation for a totally reversible redox couple is $57/n$ mV.

To make voltammetry applicable for the simultaneous determination of various oxidizing and reducing species in blood, the research group of Professor Sansen in Leuven reduced the size of the electrodes and the necessary electronic circuitry by means of thick film and IC technology applied on a 0.75×5 mm ceramic substrate, including a layer of immobilized enzymes (Sansen et al., 1990).

3.8 Conductimetric Sensors

Chemical reactions usually involve a change in ionic species, thus affecting a net change in conductivity of the reaction solution. Because solution conductance measurements are not specific, widespread analytical use is restricted. However, when specificity is not important, conductance measurements can be used and offer a high sensitivity.

Conductance (S) is the reciprocal of resistance (R), expressed in reciprocal ohms (mhos or Siemens). The conductance of an electrolyte between two electrodes is given by:

$$S = 1/R = AK/d \quad (27)$$

where A is the area of the electrodes, separated from each other by a distance d . K denotes the specific conductance, which is the conductance of a 1-cm³ unit of the electrolyte at a given temperature. Conductivity measurements are usually carried out in a.c. operation to avoid double-layer charging, Faradaic processes and other phenomenon associated with d.c. current flow.

The origin of a change in conductance can in general not be withdrawn from the measurement of S . For application in biosensors, therefore, a biorecognition molecule (for instance an enzyme or biological membrane receptor) must be immobilized between two parallel electrodes in a suitable matrix.

A well-known application of conductivity measurement in an enzyme-linked assay is the determination of urea by means of a conductance cell consisting of two interdigitated electrodes, covered with a membrane containing the enzyme urease, aimed to monitor hemodialysis continuously (Cullen et al., 1990).

An other example of an indirect biosensor based on a conductivity measurement is the glucose sensor using a glucose sensitive doped polyacetylene film (Malmros et al., 1987/88). When chemically doped with a small amount of iodine the conductivity of polyacetylene can be modified to span a large range. These films also show a change in conductivity due to the presence of hydrogen peroxide. This response can be directly applied for a glucose sensor, using the enzyme glucose oxidase, according to:

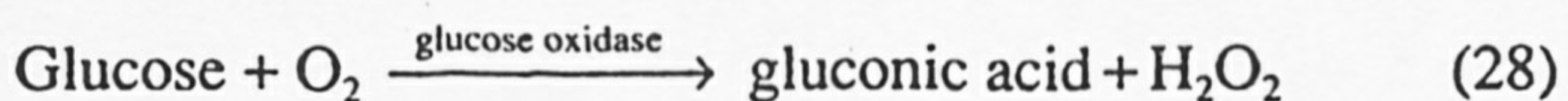

The response can be considerably enhanced by including the enzyme lactoperoxidase (LPO)/KI in the assay buffer. This enzyme catalyzes the peroxide oxidation of I⁻ according to:

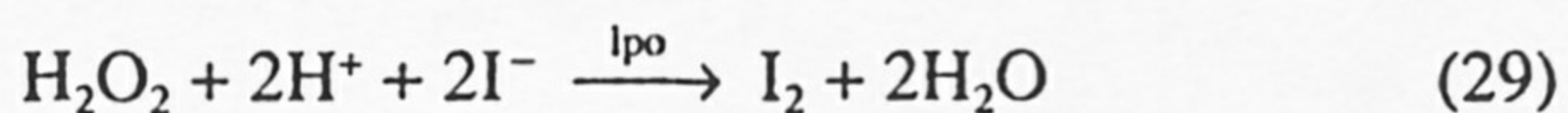

The molecular iodine produced contributes significantly to the enhanced conductivity change.

Because the sensitivity of the measurement is hindered by the parallel conductance of the sample solution, usually a differential measurement is performed between the cell with enzyme and an identical cell without enzyme.

4. ION SELECTIVE FIELD EFFECT TRANSISTORS

4.1 Introduction

Among the class of electrochemical transducers as described in Section 3, the ion selective field effect transistors (ISFETs) occupy a specific place (Bergveld and Sibbald, 1988). They are the only sensors which do not have a galvanic contact with the sample solution. Instead of this the operational mechanism is based on a capacitive coupling, provided by a specific insulating layer. Furthermore, ISFET ion sensors are the only sensors which also apply the insulating material to sense ionic activity in an electrolyte. In addition ISFETs combine the sensing properties with an *in situ* impedance transformation, which is favourable for the signal to noise ratio.

The description of the ISFET operation can be divided into two distinguishable parts in accordance with the general description as given in Section 1: the recognition system (the selector) and the transducer part; this division will be used in the following subsections.

4.2 ISFET Transducer

The operation of an ISFET as a solid state transducer should be compared with that of the pure electronic analog, the MOSFET. Figure 8 illustrates the similarities as well as the differences between the well-known MOSFET and the ISFET. The metal gate of the MOSFET in Figure 8(a) is replaced by the metal of a reference electrode, while the liquid in which this electrode is present makes contact with the original gate insulator (Figure 8(b)). Both devices have the same electrical equivalent circuit, which is symbolized in Figure 8(c) in which V_{gs} is the applied gate-source voltage and V_{ds} the applied drain-source voltage. The following equation is valid for the non-saturated region of both devices (below pinch-off):

$$I_d = \beta(V_{gs} - V_T - \frac{1}{2}V_{ds})V_{ds} \quad (30)$$

in which β is a parameter, determined by the mobility μ of the electrons in the inversion layer, the gate insulator capacitance per unit

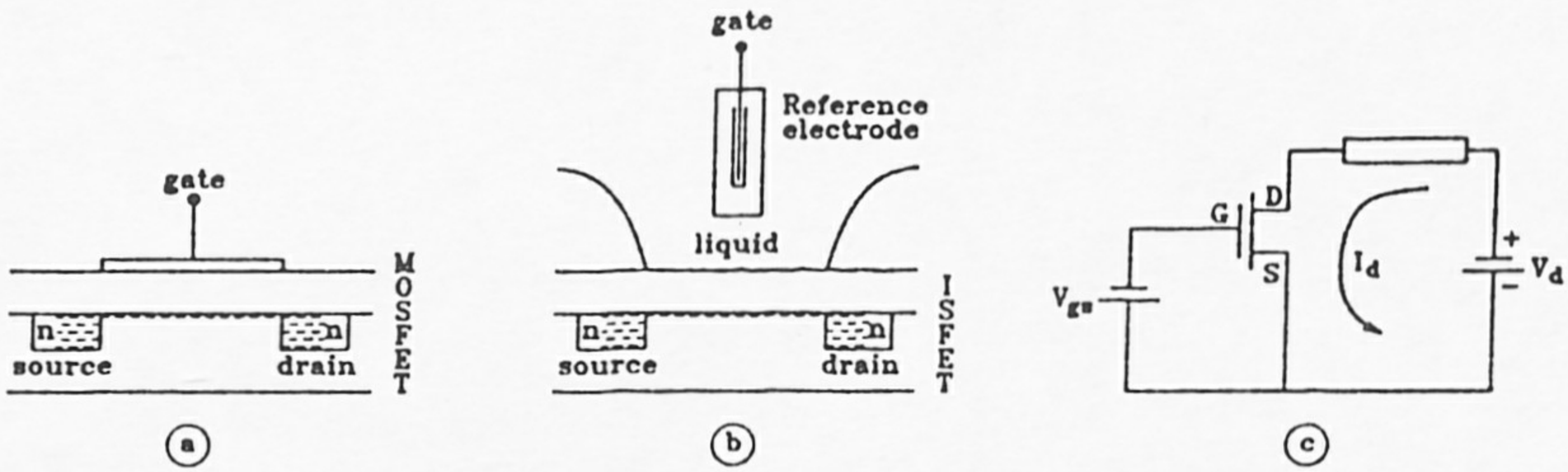

Figure 8. Schematic diagram of (a) a MOSFET, (b) an ISFET and (c) corresponding electrical diagram.

area C_{ox} , and the width-to-length ratio of the channel between the source and the drain, W/L .

$$\beta = \mu C_{ox} W/L \tag{31}$$

Besides differences in the performance of the two devices, there is a difference in the value of the threshold voltage V_T which is constant in the case of a MOSFET, but is a function of the pH of the liquid for the ISFET due to the pH-dependent oxide surface potential ψ_o , according to Eqs. (32) and (33):

$$V_T = V_{FB} - Q_B/C_{ox} + 2\phi_F \tag{32}$$

with

$$V_{FB} = E_{REF} - \psi_o \pm \kappa_{sol} - \Phi_{Si}/q - (Q_{it} + Q_f)/C_{ox} \tag{33}$$

Here V_{FB} is the so-called flat-band voltage, Q_B is the depletion charge in the silicon, ϕ_F the Fermi potential, E_{REF} the reference electrode potential relative to vacuum, ψ_{sol} the surface dipole potential of the solution, Φ_{Si} the silicon work function, Q_{it} the surface-state density at the silicon surface and Q_f the fixed oxide charge. The surface potential at the oxide–electrolyte interface, ψ_o , is the parameter which makes the flat-band voltage and thus the threshold voltage a function of the pH, resulting in the pH sensitivity of I_d . Therefore it is this parameter that forms the recognition system of the device.

4.3 ISFET Recognition System

Insulators which are widely used for the ISFET process technology

are SiO_2 , Si_3N_4 , Al_2O_3 and Ta_2O_5 . The surface of these oxides contains hydroxyl groups which act as discrete sites for chemical reactions of the surface, when it is brought into contact with an electrolyte solution. It is usually considered that only one type of site is present, having an amphoteric character. This means that each surface site can be neutral, act as a proton donor (acidic reaction) or as a proton acceptor (basic reaction). This surface property is schematically represented in Figure 9. The corresponding acidic and basic reactions are characterized by their equilibrium constant K_a and K_b .

The resulting surface potential ψ_o can be calculated from the total number of surface sites N_s which will be partly charged to a surface charge σ_o , depending on the pH as determined by the equilibrium constants K_a and K_b .

$$\psi_o = 2.3 \frac{kT}{q} \frac{\beta}{\beta + 1} (\text{pH}_{\text{pzc}} - \text{pH}) \quad (34)$$

where the zero-charge pH, pH_{pzc} , is given by

$$\text{pH}_{\text{pzc}} = -\log \left(\frac{K_a}{K_b} \right)^{1/2} \quad (35)$$

is the pH for which $\psi_o = 0$ and $\sigma_o = 0$, and

$$\beta = 2q^2 N_s (K_a K_b)^{1/2} / kTC_{\text{DL}} \quad (36)$$

is a surface reactivity parameter in which $C_{\text{DL}} = \psi_o / \sigma_o$, is the double layer capacitance.

Substitution of Eq. (34) into Eqs. (33), (32) and (30) results in a fixed relation between the drain current of an ISFET and the pH of the

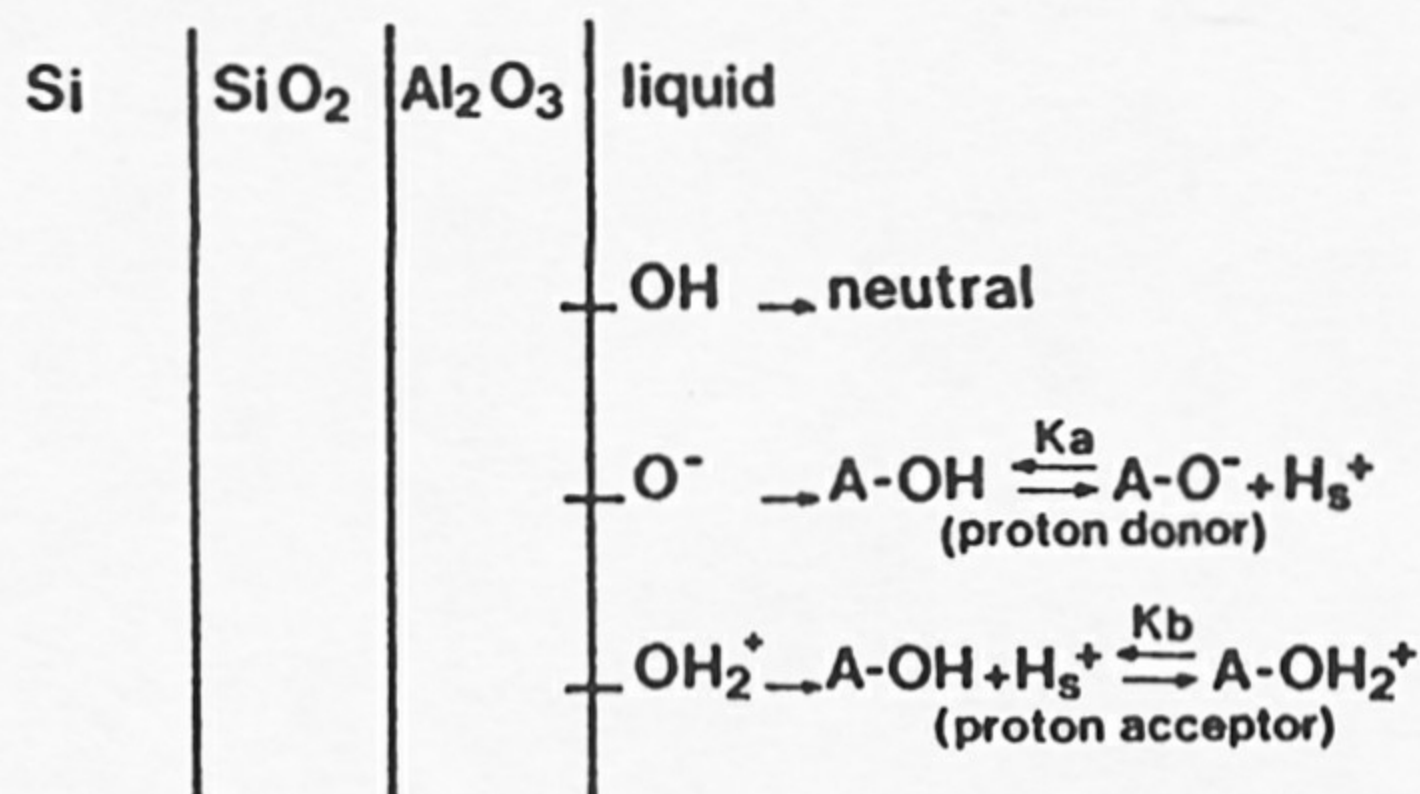

Figure 9. Schematic representation of inorganic oxide–electrolyte interface with corresponding chemical reactions.

measuring solution (Bousse et al., 1983). The selectivity for H^+ ions with respect to other small cations is very high, especially for Al_2O_3 and Ta_2O_5 .

4.4 ISFET Application

From the previous sections it may be concluded that the ISFET is in fact an integration of a solid-state transducer and a recognition system which can be produced by one and the same process, resulting in a tiny silicon chip, typically a few mm^2 in area and $200\ \mu m$ thick. It should be mentioned that hundreds or thousands of these chips can be produced simultaneously on one silicon wafer (see Chapter 6). The chips are extremely suitable for incorporation into a catheter or hypodermic needle.

In order to obtain a stable ISFET operation, the ISFET is always applied in a feedback circuit (Bergveld, 1981). This will result in an operation mode where the drain-source voltage has a constant preset value and the feedback control also ensures a constant drain current. This results in a gate-source voltage that is adapted to the value of ψ_0 . As the gate voltage is actually the voltage of the reference electrode which is usually the ground connection of the feedback amplifier, it means that the source voltage with respect to ground exactly follows the pH dependent surface potential ψ_0 as given in Eq. (34). Because the source connection is low-ohmic, the signal transfer to a remote data acquisition system is hardly sensitive to electromagnetic interferences. This means that no shielded cables are necessary, which is a great advantage as compared with the application of conventional ISEs as described in Section 3. It also makes the incorporation into small catheters much easier to realize.

It will be clear that, based on the original pH-sensitive ISFETs, many other FET-based ion-sensitive sensors can be and, in fact, have been constructed (Bergveld, 1985). The concept is generally applicable for all kinds of ion-sensitive materials, such as polymers with added ionophoric substances (e.g. crown ethers) which are attached to the original inorganic gate material. In fact the problem of a stable contact for the inner side of the membrane with the 'electronic world', as mentioned in Section 3, is now solved. The galvanic contact is replaced by a capacitive one, which is stable due

to the stable $\text{SiO}_2\text{-Si}$ interface, a positive contribution of microelectronic research.

4.5 ISFET Integrated Reference Electrode

Up to now it was assumed that the ISFET will be applied in an aqueous solution which also contains a stable reference electrode. Considering the stability of the ISFET it was assumed that the stability of the reference electrode was much better (E_{REF} in Eq. (33) is constant). This is also the case with the use of the conventional saturated calomel electrode as described in Section 3. However, the application of this liquid-filled system is not very elegant in conjunction with the modern solid-state ISFET ion sensor. Nevertheless the construction of a solid-state reference electrode has not kept up with modern sensor concepts. Only a few new approaches have been suggested at the present time.

An approach that uses thin-film technology, which is also compatible with the IC technology in use for ISFETs, is Prohaska's micro-electrode design (Hochmair and Prohaska, 1985), as shown in Figure 10(A). Although developed for the measurement of low-frequency EEG signals in the brain, the electrode design is essentially a very small and flat reference electrode, comparable with the conventional reference electrodes. However, a salt bridge is still necessary to make the internal Ag/AgCl electrode insensitive to variations in the Cl^- concentration of the measuring solution. No data are available for the lifetime of this electrode, but it will be obvious that this design is not suitable for definite implantable use, due to the limited volume of KCl.

A reference electrode construction as an integral part of the ISFET chip and as such making use explicitly of IC technology and micromachining was developed by Smith and Scott (1984). They etched a cavity in the silicon chip, in which they evaporated a Ag/AgCl electrode and covered it with a layer of porous silicon, with pores varying from 1.0 nm to 1.0 μm . The cavity can then be filled with KCl. This example of IC compatible processing of a reference electrode as shown in Figures 10(B) still retains the disadvantages of a very small liquid-filled internal cavity, which will certainly present problems for long-term measurements.

The catheter type ISFET sensors, as introduced by Cordis 1985, contained a miniaturized conventional type of reference electrode, made in the tip of the catheter, as shown in Figure 10(C). The polyurethane catheter body contained a Ag/AgCl electrode and a gelled Ringer's solution, while its end was closed with a poly-HEMA plug to replace the usual sintered glass pellet of conventional glassy reference electrodes. Although this construction could be used with satisfaction for the desired period of about 10 hours, it will be clear

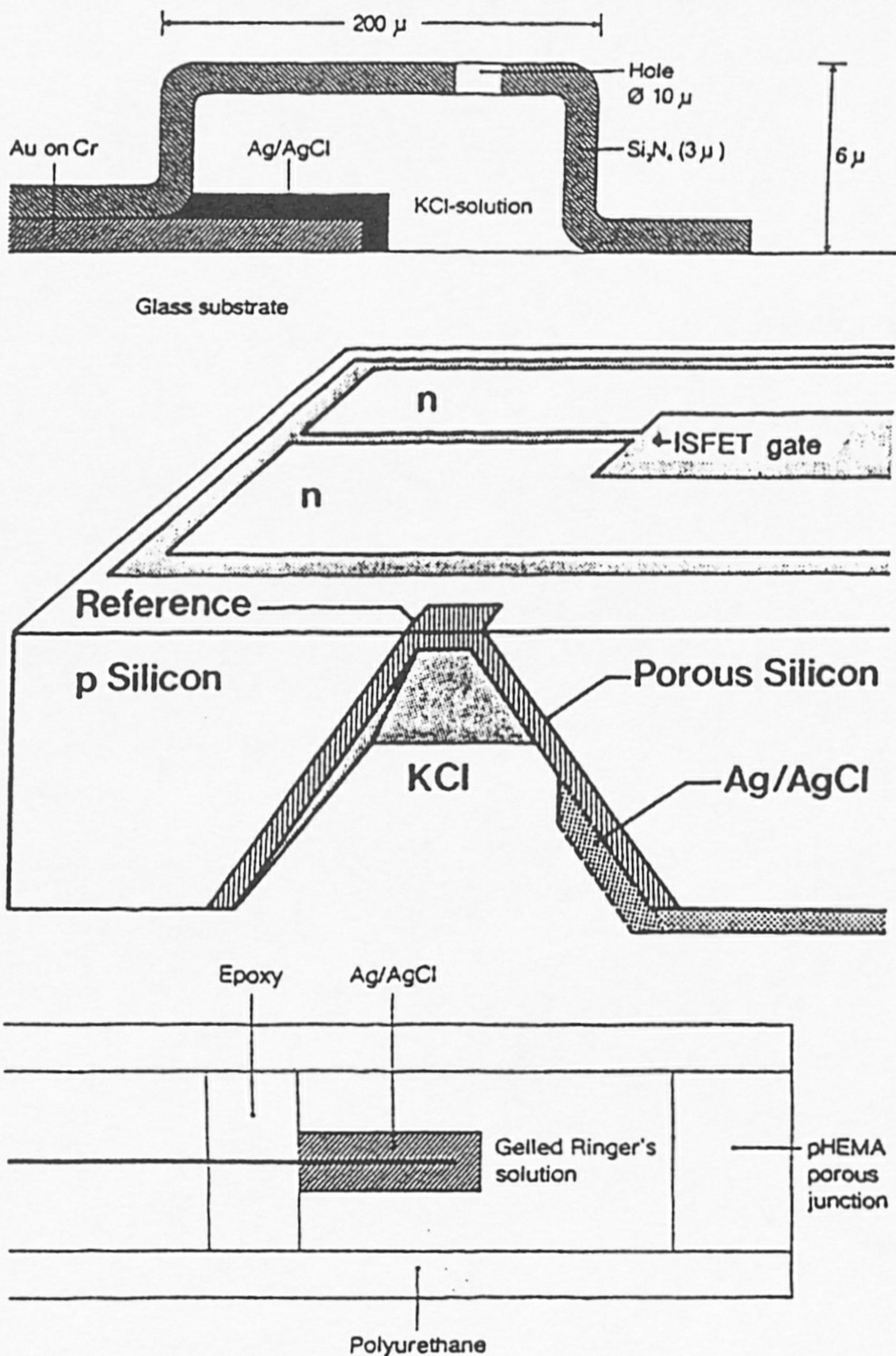

Figure 10. Various types of micro reference electrodes: (a) Prohaska type; (b) Smith type; and (c) Cordis type.

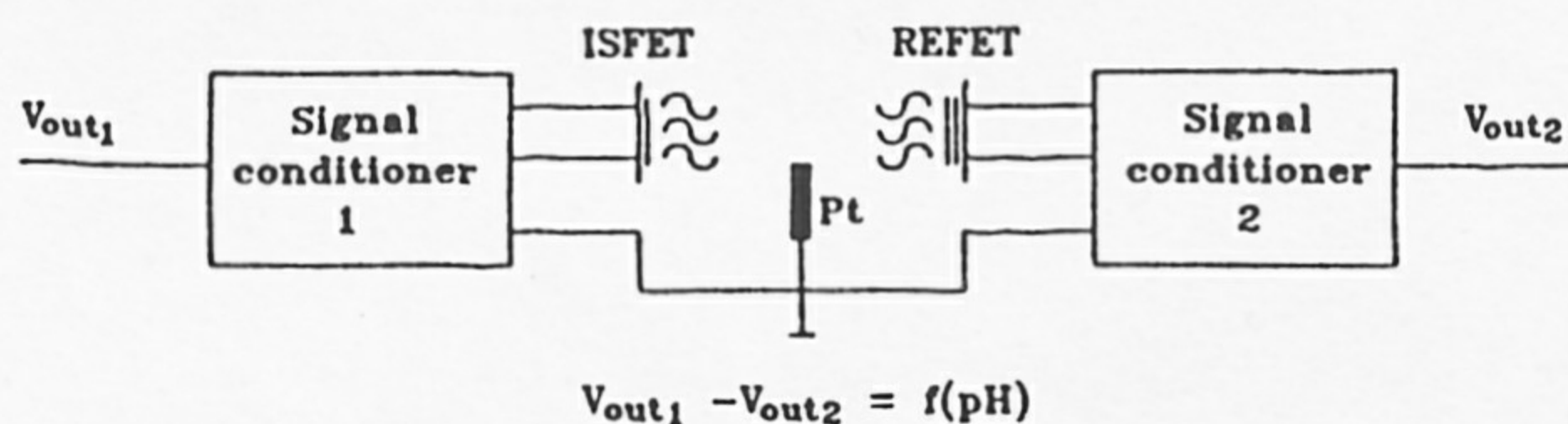

Figure 11. Schematic representation of ISFET/REFET measuring set-up with common platinum (pseudo) reference electrode.

that a liquid free all solid-state reference electrode is still the best option for integration with an ISFET, especially for long term *in vivo* monitoring.

A promising solution is the development of a so-called REFET (Bergveld et al., 1989). The REFET is originally an ISFET, but covered with a fully inert membrane. The development of REFETs is still under investigation, but if it is possible to produce a chemically stable REFET with identical electrical properties as an ISFET, and the two can be integrated in one chip, a simple evaporated noble metal can act as a pseudo-reference. Such a system is schematically given in Figure 11. Although the interface metal/solution will never be in thermal equilibrium as argued in Section 3, the resulting instable electrode potential is nevertheless not measured by the differential circuit of the ISFET and the REFET because it is a common signal. The system will, however, fully measure the pH-sensitive surface potential of the ISFET. Therefore most probably the all solid-state combined electrode in the future will consist of FET-based sensor pairs, which again underlines the impact of the ISFET approach.

4.6 ISFET Calibration

A serious problem for all ion sensors described in this chapter is the necessity for calibration and recalibration after a certain period of time. The time lag between the initial calibration and the second one depends on experience with the particular sensor in use, especially concerning the occurrence of drift and loss of sensitivity. In the catheter tip ISFET-based pH sensor of Cordis a compensation technique was used. The predetermined drift and temperature

behaviour of the ISFET was stored in a PROM which was an integral part of the catheter connector. With these stored data the drift could be compensated for as well as the temperature dependence. Compensation techniques can, however, only be used for a limited time span of measurement and only if the sensor behaviour can be predicted exactly. A better approach would be the incorporation of an *in vivo* calibration facility. The validity of this approach has been demonstrated for a pH-sensitive ISFET by means of the integration of a pH actuator electrode, closely surrounding the gate of the ISFET, as schematically drawn in Figure 12 (Olthuis et al., 1989). When a current (pulse) is applied to the actuator electrode with respect to a remote counter electrode, the hydrolysis of water will result in a ΔpH in the direct vicinity of the gate. In this way a coulometrically induced titration can be performed *in situ*. Therefore the device is called a dipstick titrator.

A similar system is possibly the solution for sensor application where *in situ* calibration is an absolute necessity, such as in the case of implanted sensors in the human body. In that case the use of an electro active actuator, such as IrO_x , may be a better approach than the use of a noble metal actuator electrode (Olthuis et al., 1992).

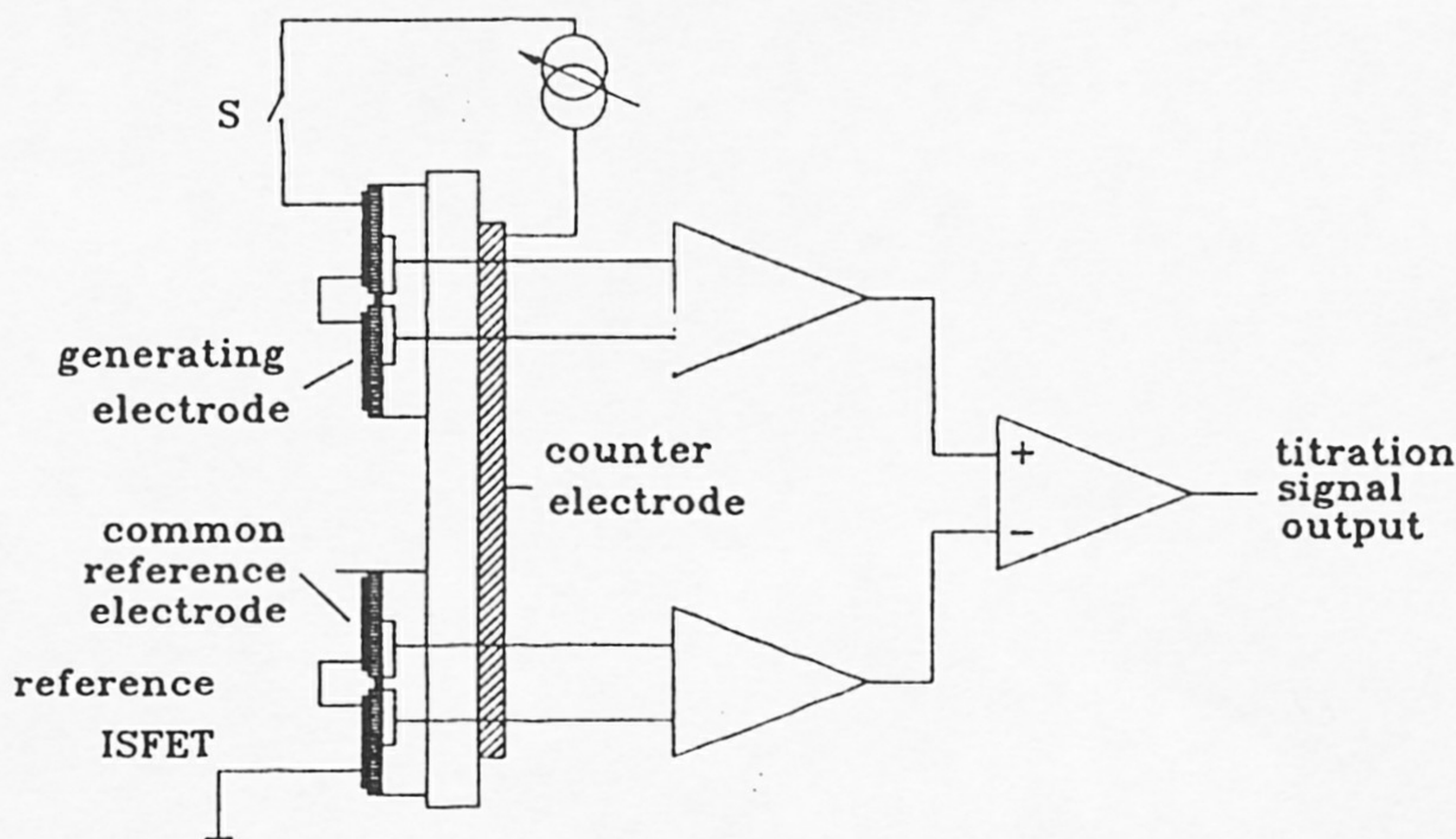

Figure 12. Schematic representation of a solid-state dipstick titrator.

4.7 Other ISFET-based Biosensors

Beside the modulation of the original pH-ISFET to ISFETs which are sensitive to other cations as well as anions by depositing specific membranes with incorporated ionophores on top of the gate (Reinhoudt and Sudhölter, 1990), ISFETs have also been used as a body for enzyme sensors (ENFETs) and immuno sensors (IMFETs).

4.7.1 The ENFET

With a pH sensor, such as an ISFET, urea can be measured in an indirect way by depositing a membrane on the gate, in which the enzyme urease is immobilized. In the membrane, urea will locally change the pH according to the following reaction:



An increase of the urea concentration will cause an increase of the membrane pH, which is measured by the ISFET.

The ENFET response is, however, very non-linear (Bergveld, 1991). This is caused by the fact that an increase of the membrane pH results in a decrease of the enzyme activity. Furthermore, the ENFET response greatly depends on the buffer capacity of the sample solution. The stronger the buffer, the lower the response to urea.

A solution to the undesired effects mentioned above is the incorporation of a facility to keep the pH in the membrane at a constant value. Keeping in mind the possibility of local coulometric control of the pH, as described in the previous paragraph, it will not be surprising that a device could be developed, consisting of the dipstick titrator on which a membrane is deposited with immobilized urease on one of the ISFETs. This system is schematically presented in Figure 13. Here the actuator current is now continuously controlled by a comparator and a programmable current source, resulting in a coulometric compensation of the enzymatically induced pH change. The system is called a pH-static enzyme sensor.

The output of the system is now the value of the controlled actuator current, which depends in a linear way on the urea concentration. Moreover, the buffer dependency is now cancelled, which is another advantage of the application of feedback.

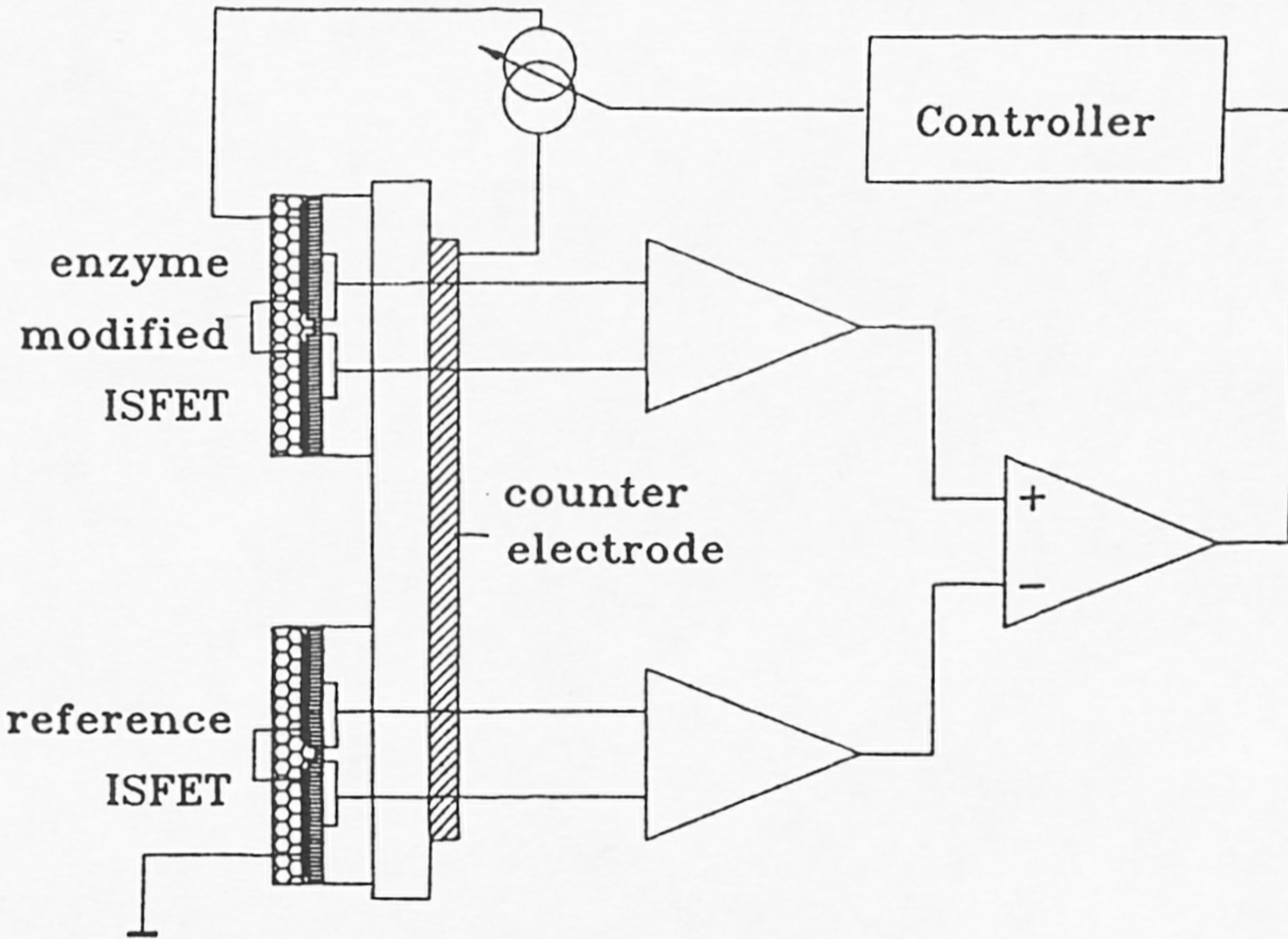

Figure 13. Schematic representation of an ENFET in closed-loop configuration.

4.7.2 The IMFET

It has long been debated whether it would be possible to distinguish between the characteristic charge of an antibody/antigen complex covering an ISFET and the charge of one of the separate constituents. This appears not to be possible using the immuno-modified FET (IMFET) in a static way. This problem is not caused directly by the ISFET drift behaviour, but is due to the porous structure of the membrane, including the proteins, which, moreover, are surrounded by neutralizing counter ions, thus shielding any electric dipole that may exist and be modulated by a specific immunoreaction.

The existence of a porous membrane containing immobilized proteins with fixed charges and mobile counter charges can, however, be exploited using dynamic measurements (Schasfoort et al., 1990). If, at a certain pH differing from the isoelectric point of the protein (complex) immobilized in a membrane which covers the ISFET, a sudden change in the ionic concentration of the electrolyte is created, a temporary disturbance of the Donnan potential will occur. In the ISFET

registration, this means that the static output voltage of the ISFET amplifier, determined by the pH of the electrolyte, shows a temporary disturbance with an amplitude which is related to the fixed charge density in the membrane. Because this charge density is a function of the pH of the electrolyte, the isoelectric point of the proteins can also be determined by gradually changing the electrolyte pH, as shown in Figure 14. Similarly, the difference in isoelectric points of an antibody (or antigen) immobilised in the ISFET membrane and the antibody/antigen complex after an immunoreaction can be determined.

Although the measuring procedure should be evaluated to achieve a practically usable IMFET for the direct monitoring of an immunological reaction, it will be clear at this point that the method is based on a non-equilibrium phenomenon. The ISFET is used to measure induced transient membrane potentials, which occur within seconds, preventing any problem with ISFET drift. The necessary ion-step makes the system less usable for *in vivo* measurements, but bedside determination of blood sample proteins may be possible.

5. OPTICAL BIOSENSORS

5.1 Introduction

Photometry is an optical technique already used for a hundred years for chemical analysis, based on phenomena like emission and

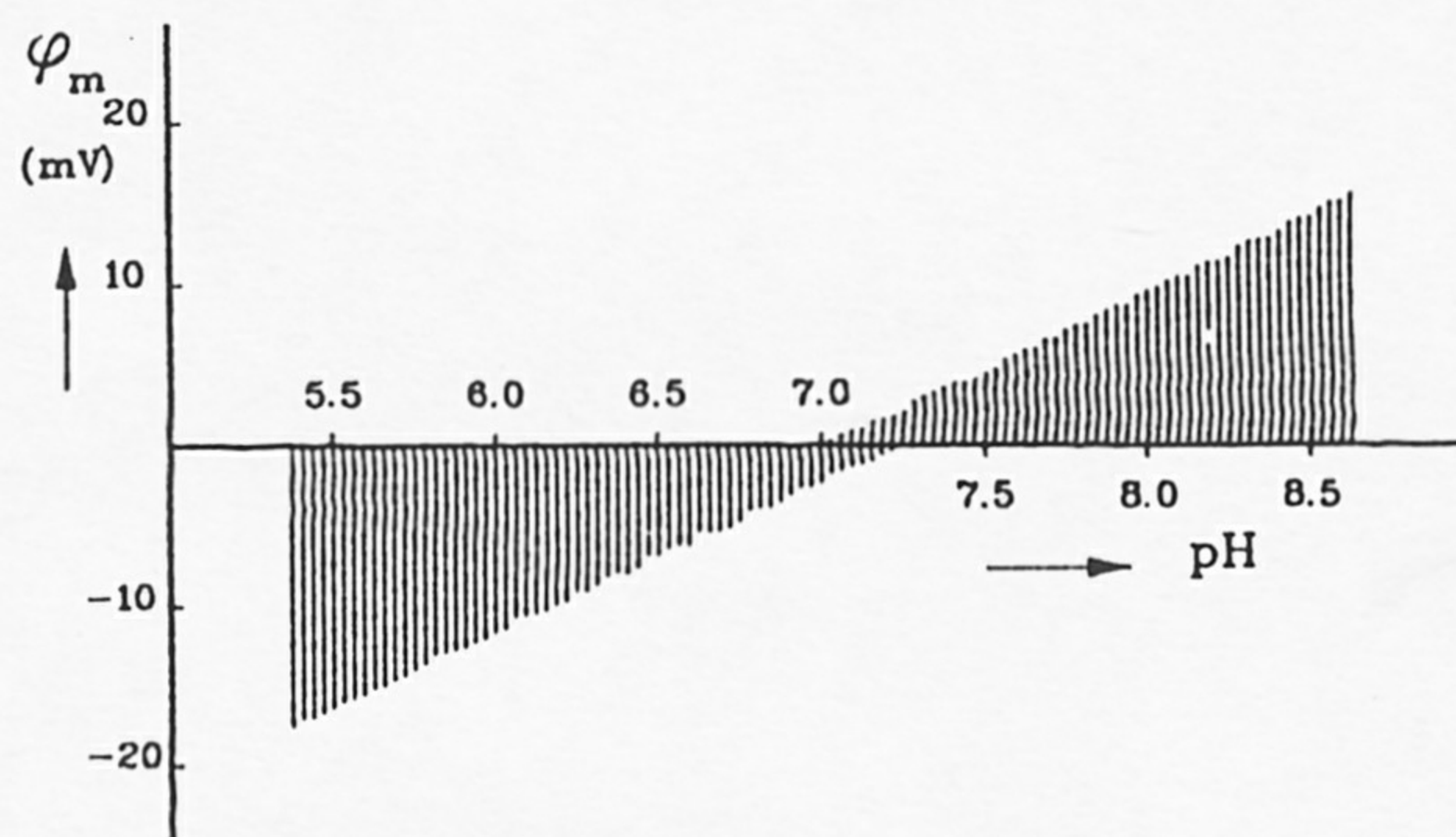

Figure 14. Sequence of recorded transient potentials as a function of pH for a lysozyme-loaded membrane of cross-linked polystyrene beads.

absorption of electromagnetic radiation by specific constituents of a sample solution. Examples include emission spectroscopy, atomic absorption and Raman scattering. These basic principles have been developed into rather sophisticated instruments, usually non-portable and relatively expensive. Although these types of instruments are presently frequently used in clinical chemistry laboratories for the analysis of blood samples and of other body liquids, they are as such, even in minituarized form, not directly of use for *in vivo* monitoring. These techniques will therefore not be dealt with in this section. Due to the introduction of optical fibres, which are cheap and can easily be inserted into the human body, combined with inventions of new principles and the renaissance of some of the older ones, optical measuring techniques now offer very serious possibilities for *in vivo* monitoring. Therefore this section will focus on optical fibre sensors and their peripheral equipment.

5.2 Optical Fibres

Optical fibres are developed in the telecommunication industry to act as waveguides for continuous or pulsed light. The incident light is trapped at one end of the fibre and is transmitted within the structure to the other end with minimal loss of optical energy, due to total internal reflection. To achieve this the fibre consists of a core of for instance quartz, having a refractive index N_1 , which is surrounded by a cladding of usually a certain polymer with a refractive index N_2 . When $N_1 > N_2$, total internal reflection is possible. The measure of the light-gathering capacity of the fibre is known as the 'numerical aperture' NA , which depends exclusively on the refractive indices of the core and the cladding as given by

$$NA = (N_1^2 - N_2^2)^{1/2} = N_0 \sin \theta_i \quad (38)$$

where N_0 is the refractive index of the outside medium and θ_i the input angle of an optical ray.

An intrinsic property of light, guided through an optical waveguide, is the presence of a non-radiating evanescent field on the immediate outside of the waveguide. In practice various additional parameters may influence or modulate the actual transmission of light, such as absorption of light by the fibre material or (local) reflection losses, as

well as the conditions at the end of the fibre. These effects are not desirable in telecommunication applications, but are more or less exploited in the case of fibre optic sensors. In addition, for sensor applications parts of the cladding can be removed, resulting in the possibility of interaction between the evanescent field and the surrounding medium. The optical sensing principles which can be used in principle for *in vivo* detection are in fact numerous. Usually a measuring volume is present which is separated from the surrounding system by a semi-permeable membrane which is permeable for the particular molecule or ion that has to be determined. Inside the measuring volume the analyte molecule usually affects an optical property of a 'reporter' molecule, either directly or after being converted by an (immobilized) enzyme with release of an ion (e.g. H⁺) which affects the reporter's optical properties. Some of the principles can be used both in 'evanescent' sensing as well as in 'bulk' sensing, where the latter refers to the situation where the waveguide is used for light transport only. A general advantage of evanescent sensing is that no light beams have to travel through the sample volume, thus making measurements in all kinds of environments easy.

The most commonly applied optical principles are optical absorption, reflectance, scattering, fluorescence, luminescence and refractive index sensing; these principles will be dealt with in the following sub-sections.

5.3 Optical Absorption

Light absorbing species in the measuring volume which is part of the optical pathway, will change the light intensity according to the Beer-Lambert relationship

$$A(\lambda) = \log I_0/I = C\varepsilon(\lambda)L \quad (39)$$

where A is the actual absorbance, L is the pathlength of the light, $\varepsilon(\lambda)$ is the molar extinction coefficient, I_0 and I are the incident and the transmitted light respectively and C is the concentration of absorbing species. The optical absorption is measured at one or more wavelengths. Measurements at one wavelength are liable to uncertainties in optical pathlength and scattering effects. It is therefore usually necessary to make a calibration curve for the determination of

the activity of the sensor. In practical applications one can distinguish between one optical fibre for transportation of the light to and from the detector volume or a bifurcated fibre of which one fibre serves the input light path and the second the output. Special purposes may require the use of polarization retaining fibres. A well-known example is the optical pH sensor (Peterson et al., 1980), in which case the ends of two optical fibres are inserted into a hollow cellulose tube of 0.3-mm diameter as illustrated in Figure 15.

The measuring volume thus created contains polystyrene spheres and polyacrylamide spheres with phenol red, a well-known pH indicator dye. The incoming light is scattered by the polystyrene beads and certain wavelengths are partially adsorbed by the phenol red. The output light is analysed by an optical analyser. Because only green light is affected by the pH and red light not, the red light can be used as a reference. The device operates in the pH range of 7.4 to 7.0 with a resolution of 0.01-pH unit; very suitable for *in vivo* pH monitoring, although the lifetime should be extended for long term measurements.

Although the sensor itself can be produced very cheaply, the necessary optical equipment makes the system, as is the case with most other optical sensors, still too expensive to be sold in large quantities. Therefore low cost light sources (LEDs) and detectors (light sensitive diodes) have to be used and optimized for this specific purpose (Grattan et al., 1987/1988).

Just as in the case of electrochemical sensors (Section 3), the optical fibre pH sensor is also applied in an indirect way for the measurement of gases such as carbon dioxide and ammonia. In this case the

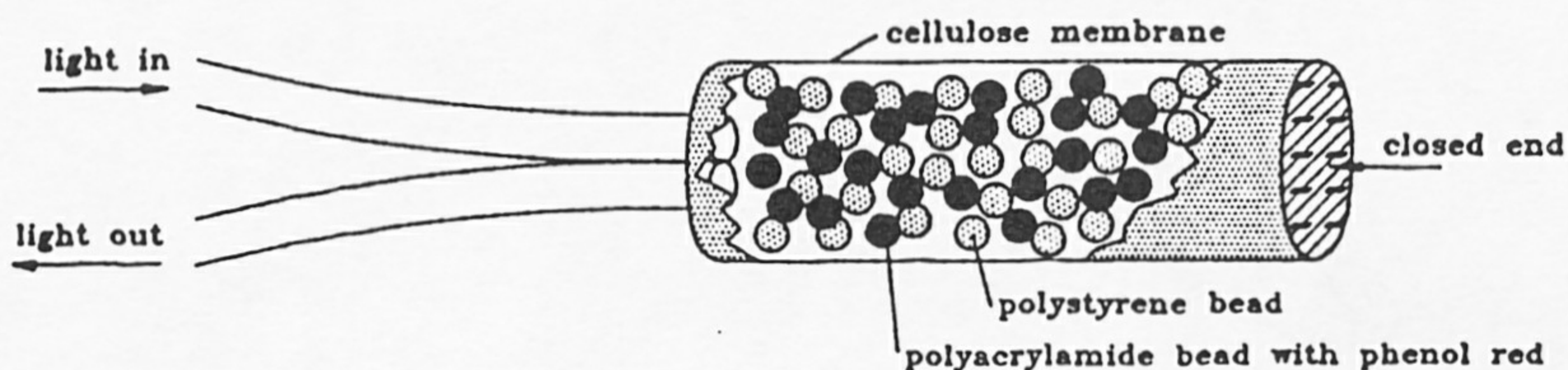

Figure 15. Typical performance of many optical fibres, in this case for pH measurements. In general the medium inside the measuring volume may contain particles which either absorb, reflect or emit fluorescent light.

measuring volume is filled with a certain electrolyte and closed with a membrane.

Gases diffusing through the membrane will change the pH of the measuring chamber, which also contains an indicator molecule adapted to the expected range of pH modulation (Arnold and Ostler, 1986).

5.4 Optical Reflection

If the medium where the light 'sees' the sample is opaque and absorption as well as multiple scattering occurs in this sample, then the intensity of the reflected light can be used as the measurand. Diffuse reflection is of specified importance, and this phenomenon has been described with several models. If the scattering layer can be assumed to be infinitely thick, the Kubelka–Munk theory appears to be a proper description. In this theory the reflectance R is related to the absorption coefficient K and the scattering coefficient S by

$$K/S = (1 - R)^2/2R = f(R) \quad (40)$$

The absorption coefficient K is related to the molar extinction coefficient and the concentration C of the absorbing species, as $K = \epsilon C$. This allows the Kubelka–Munk function $f(R)$ to be described as

$$f(R) = \epsilon C/S = kC \quad (41)$$

if S is constant. In this case the reflectance equation is analogous with the absorption equation (39). Comparing both equations it cannot a priori be concluded which of the measurement principles is the most sensitive. However, because light on its way through a fibre undergoes a very large number of reflections, the sensitivity to reflectance is very large. If this fibre is partly stripped of its cladding and this site is provided with the absorbing and scattering particles, a very sensitive sensor is constructed for chemically induced reflectance changes. An example of this type of chemical sensor is an ammonia sensor (Giuliani et al., 1983).

5.5 Scattering

Besides absorption and reflection of light, back scattering (caused by all atoms and molecules in the measuring volume) may be used as

the output signal of an optical fibre. Small particles with respect to the wavelength cause Rayleigh scattering, while larger particles cause Mie scattering. For small particles the intensity of the scattered light is proportional to the square of the molecular weight of the particles. So at an appropriate wavelength a reaction between an analyte and a receptor molecule, resulting in a dimensional change of the particles, will change the scattering intensity. Incident radiation may also cause vibrational changes in the molecule. The resulting scattered light will therefore have a different frequency. This phenomenon is called Raman scattering, which can however only be observed using very intense light sources, such as lasers. Of all principle possibilities mentioned up to now no real *in vivo* sensors have been constructed.

5.6 Fluorescence

A total different optical phenomenon than those mentioned in the previous sections occurs if, due to illumination, a transition occurs between quantized energy levels in atoms or molecules. Applying this phenomenon in biosensors, a fluorescent molecule has to be introduced on the measuring side, comparable with the introduction of specific ligands in electrochemical sensors. Direct chemical sensing can be achieved using molecules of which the fluorescence intensity is an inherent function of the chemical surroundings, as is the case for fluoresceinamine with respect to pH (Saari and Seitz, 1982). In other cases a fluorescent label can be used, attached to a non-fluorescent molecule, the selective reaction of which can thus optically be monitored. A well-known example is the fluorescent-based glucose sensor as schematically represented in Figure 16 (Mansouri and Schultz, 1984). The authors labelled dextran with fluorescein. The F1-dextran binds to ConA, which is immobilized at the inner side of a hollow dialysis tube, which is mounted to the end of an optical fibre. Glucose, which will diffuse from the surrounding medium (for example blood) through the dialysis membrane, will compete with F1-dextran with respect to the reaction with ConA. The result will be a certain concentration of free F1-dextran in the optical pathway of the fibre. The intensity of the measured fluorescence is therefore related to the glucose concentration. The response is linear in the range of 0.5–4 mg/ml glucose, reversible and stable for at least 2 days. The response time is 5–7 mins.

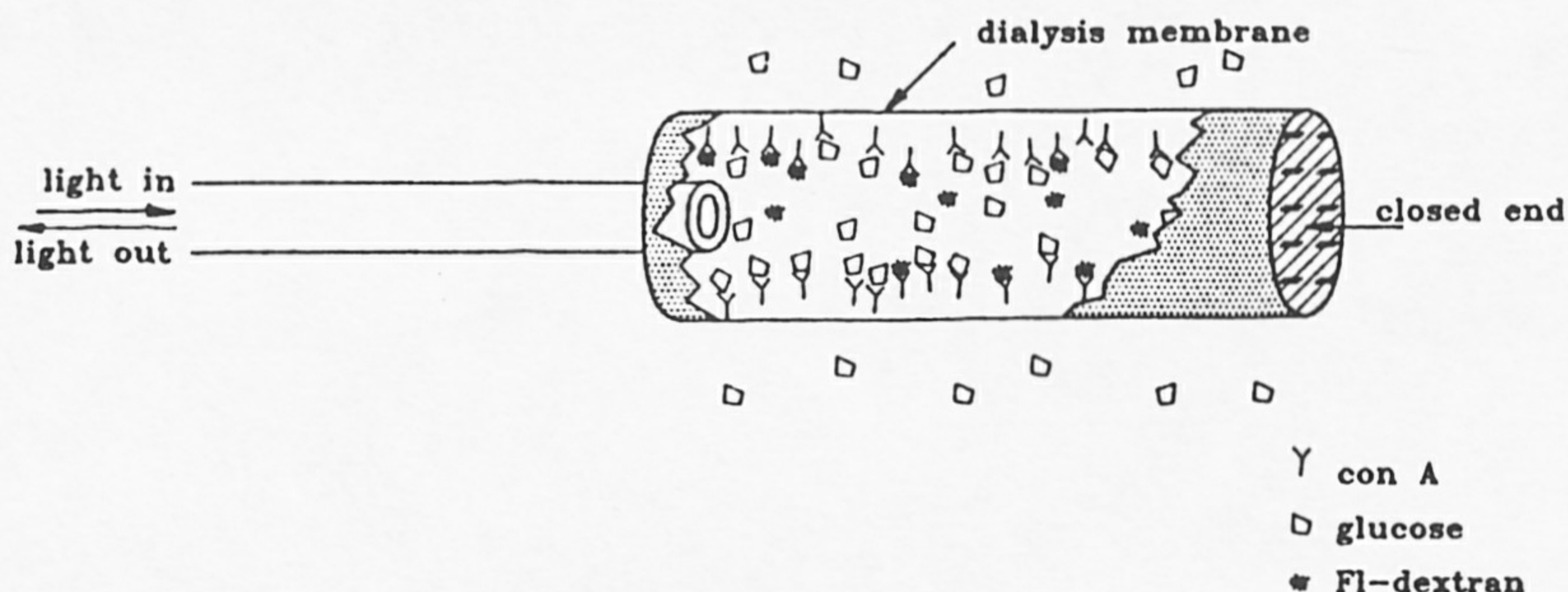

Figure 16. Schematical representation of fibre optic glucose sensor, based on competition reaction between immobilized con A at the dialysis membrane and Fl-dextran or glucose, which can freely diffuse in and out the measuring chamber.

A general advantage of using the fluorescence phenomenon is the intrinsic high signal to noise ratio, which is obtainable if proper separation of exciting and emitted wavelengths can be achieved. For fluorescence molecules with a life time which is long as compared to an exciting light pulse, time resolved detection techniques can moreover yield a very high sensitivity, with detection limits far beyond the possibilities of electrochemical sensors. A serious drawback of fluorescence-based sensors is the bleaching effect, due to the fact that each fluorescent molecule—on average—can emit only a certain number of photons, before photodegradation of the molecules takes place. This limits its application for long term *in vivo* measurements.

5.7 Luminescence

Using the fluorescent phenomenon, an external light source is necessary, which might be seen as a disadvantage. Using bio- or chemiluminescence, this external light source is no longer necessary. The light is directly emitted as a result of a specific reaction between molecules in a measuring volume. Any reaction which forms molecules in an excited state is suitable. Well-known bioluminescent molecules are luciferin and its derivatives; various assays have been constructed based on these molecules (DeLuca, 1978). Because no exciting light is needed and thus no background is present, very high

sensitivities can be obtained. On the other hand the output energy is taken from the reaction, which thus definitely 'consumes the sensor'. This makes the system less suitable for long term *in vivo* monitoring.

5.8 Refractive Index Sensing

A change in refractive index in the measuring volume can be detected in several ways. Usually the refractive index change is measured at the surface of a waveguide which means that the sensing takes place via the evanescent field (Heideman et al., 1991). A potential advantage is that no 'reporter' molecules have to be introduced, as is necessary in fluorescence based sensing, for example. The selectivity which is required for the analyte is obtained by a molecule (crown-ether, antibody) which is covalently bound or adsorbed to the waveguide and which reacts specifically and reversibly with the analyte. The refractive index at the surface can be determined interferometrically since the refractive index on the outside determines the propagation constant of the light in the waveguide. By letting this light interfere with a reference beam a very sensitive refractive index sensor is obtained. A second technique which can be used for refractive index sensing is total internal reflection. Here the amount of light reflected from the surface of a prism or—in more elaborate sensors—the inside walls of a waveguide is determined. A third possibility for refractive index sensing is using the surface plasmon resonance effect (Kooyman et al., 1990). Here the change in reflection coefficient is determined when a change in refractive index occurs at the sample side of a 50-nm silver layer deposited on the base of a prism or the outside of a waveguide. The light hits the Ag surface from the side of a prism, or waveguide, and does not travel through the sample.

5.9 Other Constructions

In the previous sub-sections the optical fibre or similar waveguide was chosen as the basic element of the described sensors, because of its optimal performance with respect to indwelling properties in the human body. Measuring principles which exclusively need prisms or other optical parts have been left unmentioned, because of the difficulties associated with *in vivo* application. Using optical fibre

sensors, the light sources and receivers have been assumed to be outside the body. Light emitting, or sensitive chips are, however, so small that these devices can also be incorporated in a catheter and brought directly to the (*in vivo*) place of measurement, making fibres for the transport of light superfluous.

An example of such an arrangement is the optical oximeter for the measurement of oxygen saturation (S_{O_2}) in the human blood (Heinze et al., 1984). The sensor principle is based on the fact that fully oxygenated and fully reduced haemoglobin have very different optical reflectance when plotted against wavelength. The crossing point between the two curves, the so-called isosbestic point, is used as a reference signal (at 850 nm), while the signal measured at about 650 nm is at the maximum difference between the two reflectance curves. Therefore a reference as well as a measuring LED is incorporated in a hybrid circuit (also containing the corresponding phototransistors) which is mounted behind an optical side window in a catheter. The system is shown in Figure 17. The electronic circuitry is designed in such a way that only two connection leads are necessary, of which one is a pacemaker stimulation lead. This is because the S_{O_2} sensor is meant to deliver the input signal of a closed-loop pacemaker controller, in which case the sensor is placed in the right ventricle by means of the already necessary pacemaker lead. Note that in the case of the S_{O_2} sensor described above the reporter molecule is the natural available haemoglobin, while the transducer is the optical reflectance sensor. It is one of the scarce examples in which the reporter molecules do not degrade, because they are not immobilized in a technological way as an integral part of the sensor. Maybe this approach is the only right one for the development of long term usable *in vivo* biosensors.

6. MECHANICAL TRANSDUCERS: PIEZO-ELECTRIC CRYSTALS AND SURFACE ACOUSTIC WAVE TRANSDUCERS

6.1 Introduction

Acoustical methods have been originally developed for audioengineering and naval instrumentation (e.g. echo sounding and acoustic signature of vessels). Recently these techniques have also

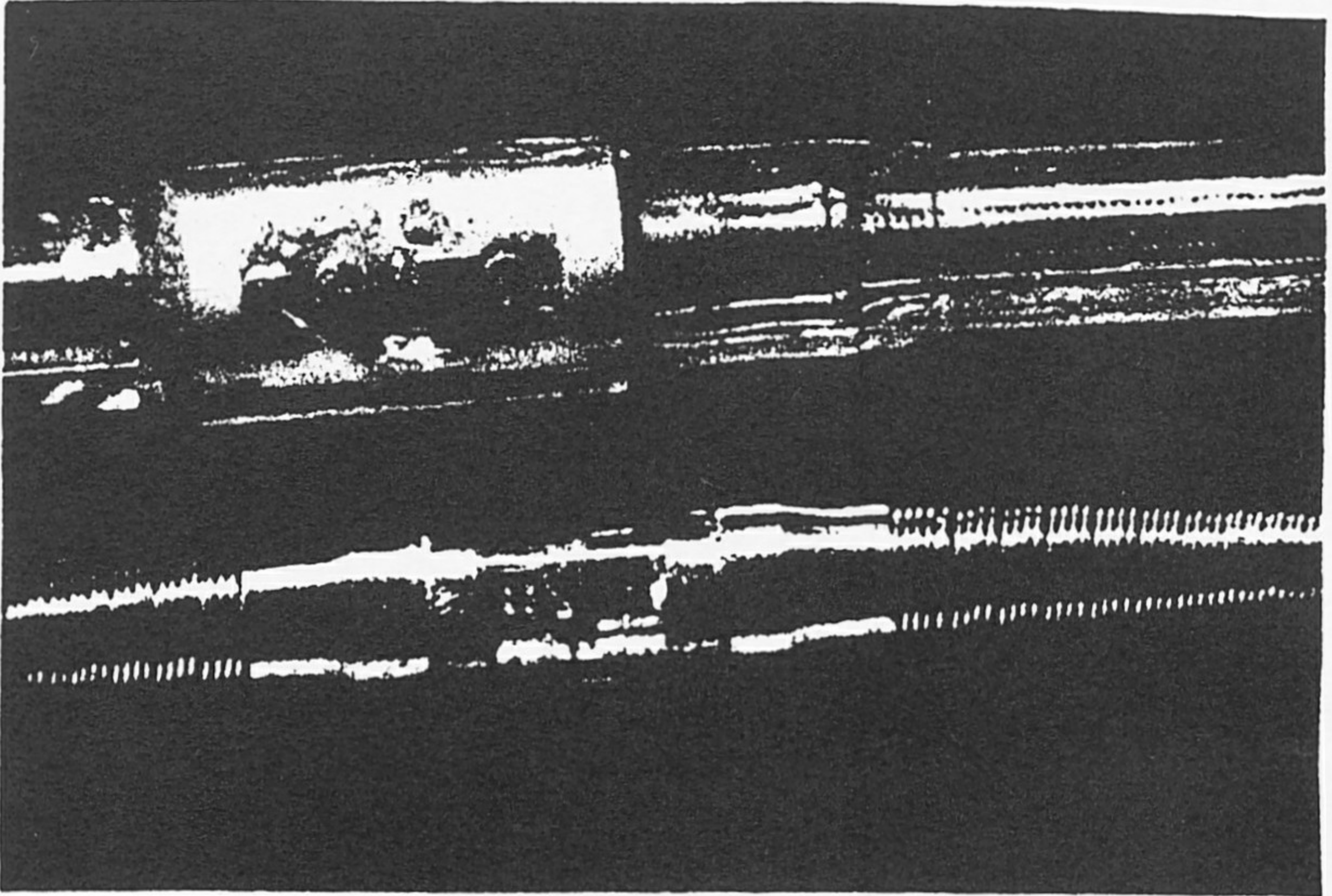

Figure 17. Photograph of pacemaker lead with incorporated S_{O_2} sensor.

penetrated into the biological sciences and surface mass detecting sensors have been proposed (Clarke et al., 1987).

6.2 Piezo-electric Transducers

The possibility of quartz crystals to vibrate, if activated by an electrical charge, was discovered in the last century. Used in a positive feedback loop, the crystals can vibrate with a very stable and rather high frequency in the 10MHz range: such oscillators are commonly used in modern electronic systems to create clock frequencies. Since the oscillating frequency not only depends on the crystals properties and dimensions but also on the thickness of connecting electrodes, such devices allow the determination of surface mass variations (gravimetric sensors) (Lu and Czanderna, 1984). This principle has been widely used in volatile and gas phase analysis (Guilbault, 1980; Alder and McCallam, 1983). The resonance frequency of the electronic circuit which contains the crystal will decrease as a result of mass increase of the coating, as a function of the concentration of the

adsorbed gas. The quantitative relationship between the frequency shift and adsorbed mass enables the piezo-electric crystals to be used as sensitive sensors. The mechanical signal domain therefore acts as an intermediate between the chemical and electronic signal domain (Bergveld, 1986).

A typical bulk wave (BW) piezo-electric crystal sensor consists of an AT-cut quartz crystal plate (mm to cm diameter range) with two metal electrodes on both sides (Figure 18). When a sinusoidal voltage is applied to the electrodes, the quartz plate will vibrate in its thickness-shear mode. The quantitative relationship between the frequency shift $df(\text{Hz})$ and an added mass $dm(\text{g})$ is as follows (Sauerbrey, 1959)

$$df = -2.3 \times 10^{-6} f_0^2 dm/A \quad (42)$$

where f_0 is the resonant frequency of the crystal (Hz) and A the electrode sensing area (cm^2). Extremely high sensitivity dfA/dm can be obtained (e.g. $230 \text{ Hz cm}^2/\mu\text{g}$ for $f_0 = 10 \text{ MHz}$) with pg detection limits for commercially available quartz crystals (Guilbault, 1980; Alder and McCallum, 1983).

A schematic diagram of the experimental setup is shown in Figure 19 where two identical crystals are used, one serving as reference and

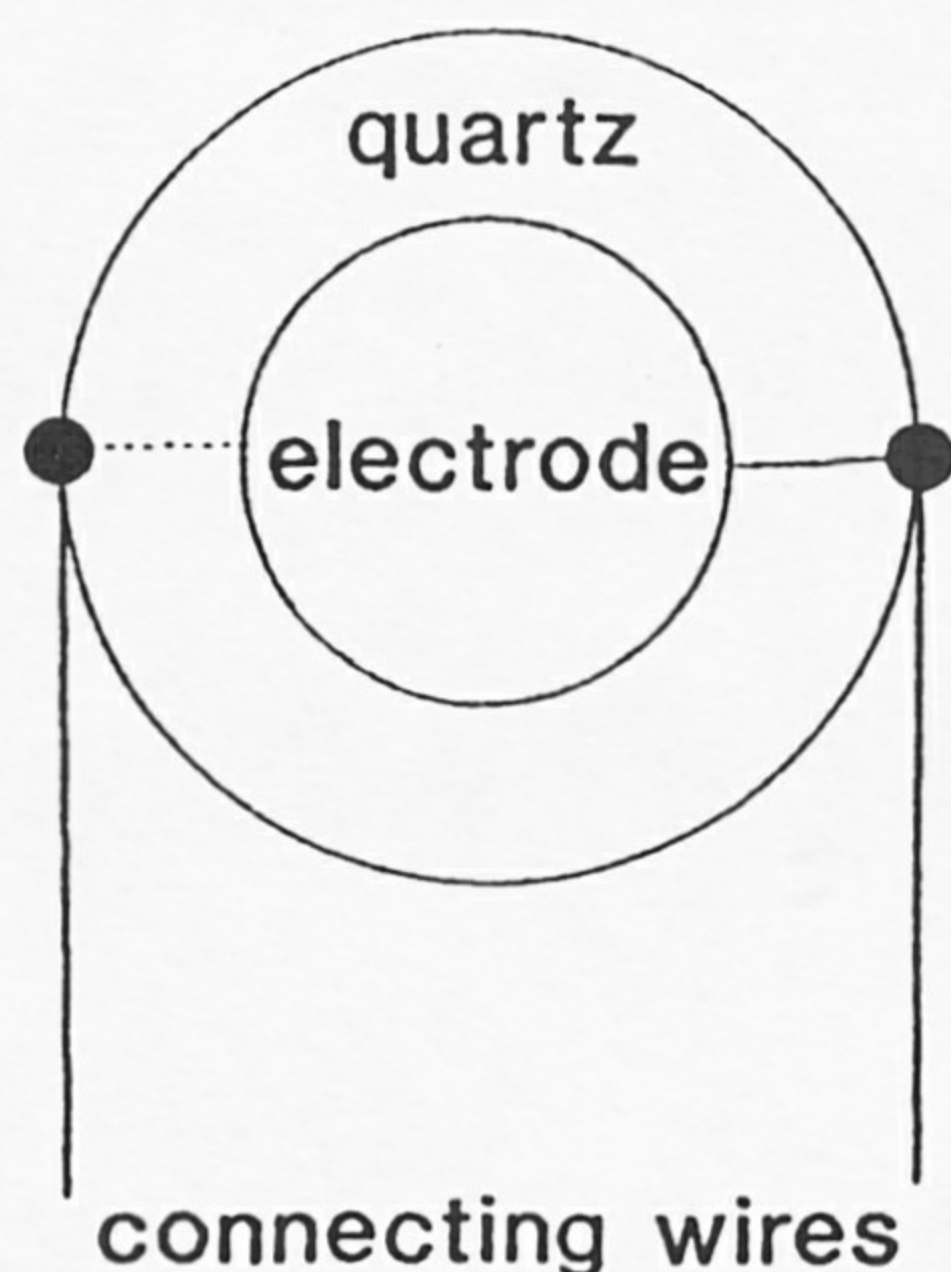

Figure 18. Schematic diagram of a bulk wave (BW) piezo-electric sensor. The sensing layer is deposited on one or both sides of the sensor and placed in contact with gaseous or liquid samples.

the other as a sensor (Ho, 1986). The frequency outputs from these oscillators are combined in a mixer and the frequency difference passed to a digital readout frequency meter. The signal can also be passed through a frequency-to-voltage converter and the resulting voltage change can be recorded as a signal proportional to the difference of mass between the sensing and reference crystal.

Since the piezo-electric crystal is entirely a non-specific transducer, its selectivity is achieved by covering the mass sensitive surface of the device (usually both sides of the crystal) with a coating layer on which the target analyte is selectively adsorbed or bound. Piezo-electric sensors may be either cumulative or reversible, depending on the nature of the coating-analyte interaction.

The majority of work concerns detection of gases (e.g. SO_2 , CO , HCl , H_2) or volatile species (aromatic or aliphatic hydrocarbons, Hg) and, in so much, does not have significant biological applications. Most require relative humidity to be low and held constant.

Besides these chemical recognition layers, piezo-electric crystals have been coated with enzymatic or immunological layers. For example, pesticides (e.g. malathion and parathion) have been determined in a carrier gas flow (Ngeh-Ngwainbi et al., 1986).

A major advance in the application of piezo-electric sensors occurred when it was shown that bulk shear wave crystal oscillators could be used as mass detectors while having at least one crystal face exposed to bulk liquid (Konash and Bastiaans, 1980). Recently,

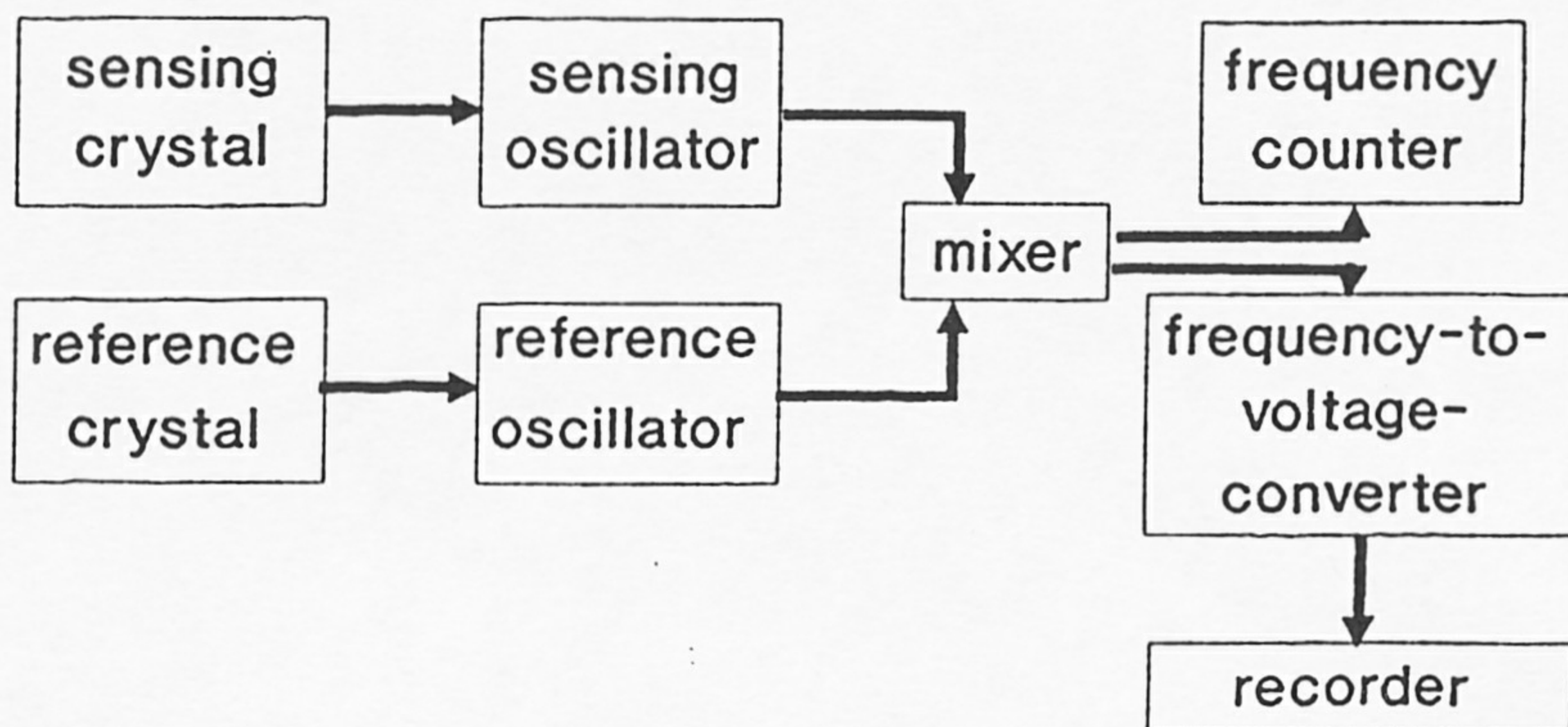

Figure 19. Experimental setup for frequency measurements with bulk wave (BW) piezo-electric sensor (Ho, 1986).

atrazine (Guilbault et al., 1992) and anti-human immunodeficiency virus (HIV) detection (Kösslinger et al., 1992) were demonstrated in liquids using antibody coated piezo-electric crystals.

6.3 Surface Acoustic Wave Transducers

The strong piezo-electricity and low acoustic losses of lithium niobate (LiNbO_3), as well as its excellent properties as a substrate for the deposition of fine metal interdigitated electrodes have led to the basis for the development of surface acoustic wave (SAW) sensors (Ghijsen and Venema, 1983). SAW piezo-electric crystals consist of a rectangular quartz plate and two sets of interdigitated electrodes that are micro-fabricated at both ends of the plate (mm^2 to cm^2 area range) (Figure 20). When a radiofrequency voltage is applied, a mechanical Rayleigh wave is generated by one set of electrodes and then propagated across the quartz crystal. This propagating surface wave is received by the other set of electrodes. With proper selection of the crystal orientation (e.g. ST crystal), an acoustic wave propagation, constrained to the surface of the crystal, can be obtained. Both set of electrodes may be connected, in a positive feedback loop, to a radio-

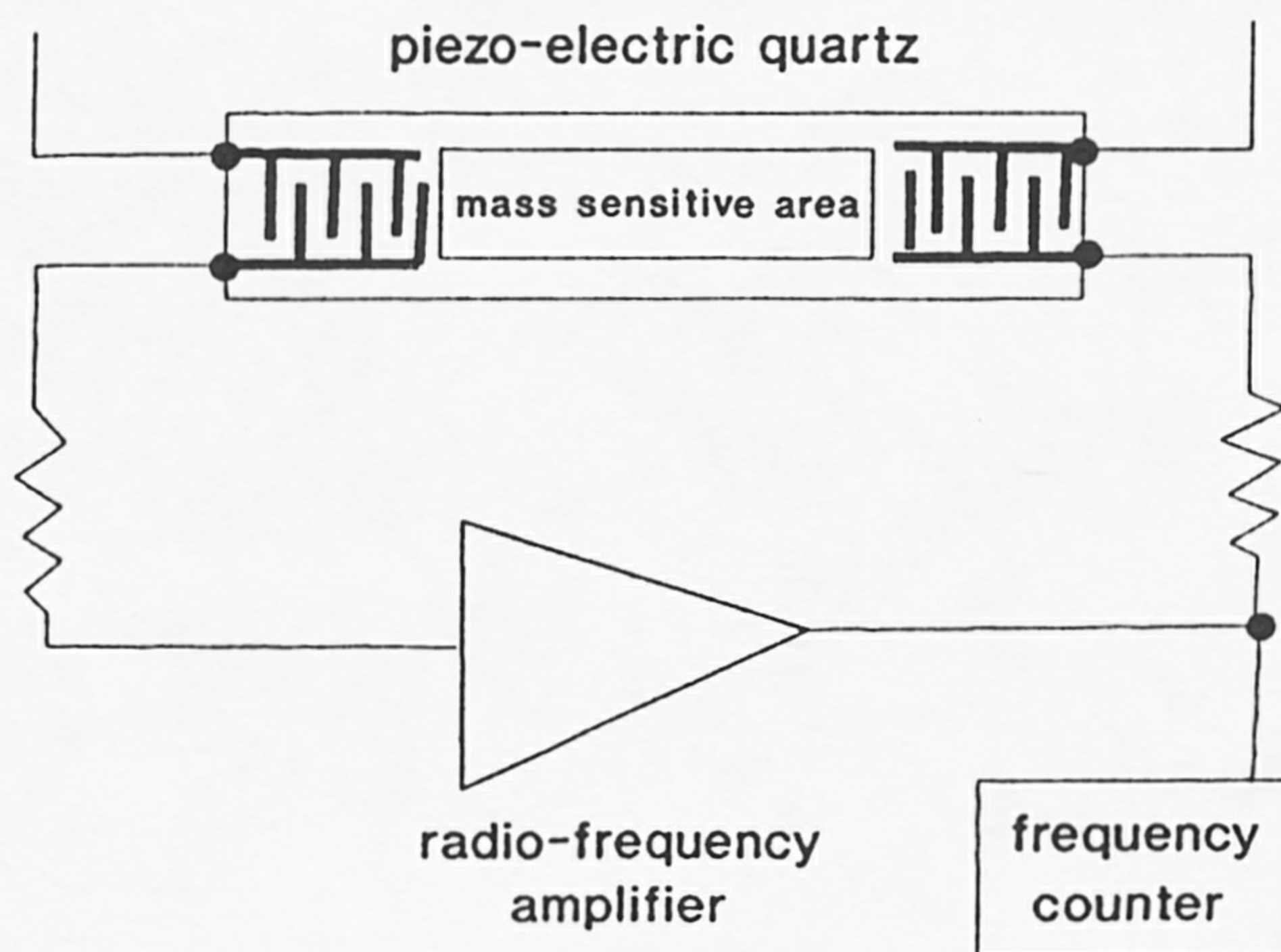

Figure 20. Schematic diagram of surface-acoustic wave (SAW) piezo-electric sensor and experimental setup for frequency measurements (Ho, 1986).

frequency amplifier, causing the device to oscillate at a resonance frequency determined by the spacing between the interdigitated electrodes. The adsorption or binding of the target analyte on to the coated or chemically modified surface of the SAW piezo-electric device affects the surface wave characteristics and therefore decreases its resonance frequency (Ho, 1986). As for the previously described bulkwave piezo-electric sensors (Figure 19), the SAW sensor consists of two SAW delay lines, only one being coated with the molecular recognition layer (D'Amico et al., 1982). The greatest advance of SAW sensors is the fact that they can be operated at much higher oscillation frequencies (ca. 20 to 30 MHz) and, as a consequence, achieve much higher detection sensitivities.

Most applications of SAW sensors relate to gas detection (Wohltjen and Dessy, 1979). For example, hydrogen sensitivity is created by depositing a thin Pd layer on the acoustic pathway of a SAW delay line: hydrogen absorption and desorption by the Pd film can be detected as phase shifts at the output of the delay-line (D'Amico et al., 1982).

Similarly to bulk shear wave crystal oscillators, SAW devices were shown to be usable in a liquid (Roederer and Bastiaans, 1983): immunological chelation with antigens present in the solution result in a decrease in the resonance frequency, the magnitude of the frequency shift being proportional to Ag concentration in the bulk solution. For example, human chorioic gonadotropin (HCG) was determined in human serum as a mean frequency shift, relative to the presence of buffer, observed over a 4-min period: the df versus [HCG] calibration curve was linear in the 5–100 mIU/ml range (Bastiaans and Good, 1986).

7. ENTHALPIC OR CALORIMETRIC TRANSDUCERS

Since biological reactions are usually more or less exothermic, calorimetry offers a general detection method for bioanalysis. Enzymatic reactions are associated with rather high molar enthalpy changes in the range 20–100 kJ/mol and it is often possible to base measurement on only one enzymatic step.

The enzyme thermistor (ET) is a simple flow calorimeter which has

been developed at Lund University (Danielsson et al., 1981). It is primarily intended for substrate assays and the reaction heat in a small column (less than 1 ml), containing large excess of immobilized enzyme, is measured as temperature change of the effluent of the column (Figure 21). Temperature is measured with highly sensitive thermistors (0.01 mK detection limit), temperature changes being proportional to substrate concentration above a 0.002 to 0.1-mM detection limit range, depending upon immobilized enzyme (Danielsson et al., 1986).

The ET-calorimeter consists of a carefully thermostated aluminium cylinder (80 × 250 mm) containing an aluminium block with heat exchangers and columns ports for two columns which can be used with different enzymes or with one column acting as a reference column (Figure 21). The columns are attached at the end of the thermistor probes by which they are readily exchangeable. The thermistors are connected to a Wheatstone bridge producing 100 mV at a 1 mK temperature change at its most sensitive setting (Danielsson et al., 1986). Commonly used full scale temperature change is in the 10–50 mK range, permitting metabolite concentration determinations in the 0.01–100 mM range. Since flow calorimeters are, like piezo-electric devices (see Section 5.2) entirely non-specific transducers, their selectivity is achieved by binding, on controlled pore glass, large

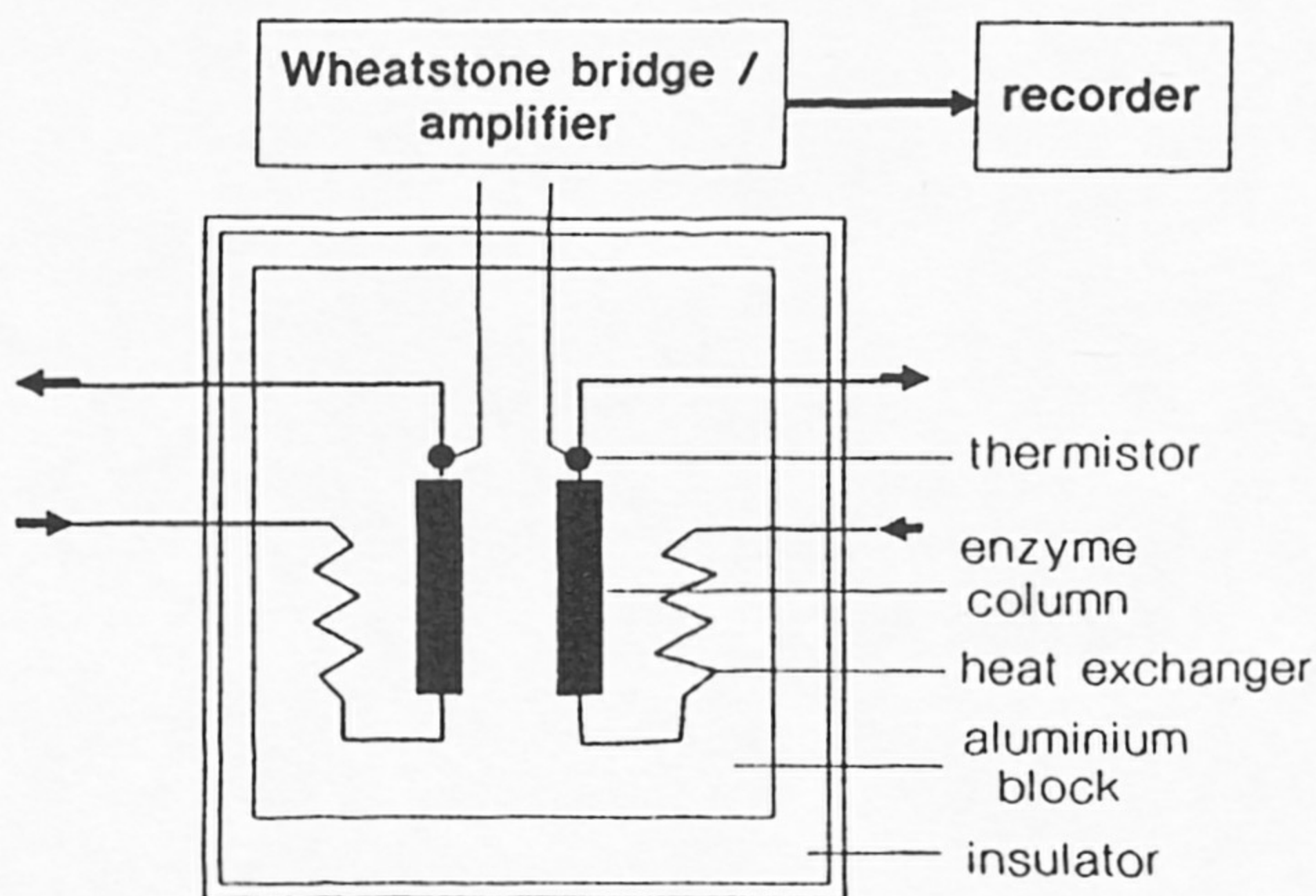

Figure 21. Schematic diagram of an enzyme thermistor based sensor (Danielsson et al., 1986).

excess of biocatalyst (enzyme or whole cells) or biochelating (antibody): in the latter case the antibody–antigen complex amount is determined by addition of enzyme activated antigen, and an extension of the ELISA method (called thermometric enzyme-linked immunosorbent assay (TELISA)), is achieved (Mattiasson et al., 1977).

In order to develop a miniaturized thermal biosensor which could eventually be implanted *in vivo*, very small flow injection analysers and enzyme microreactors have been very recently constructed ($0.4 \times 6 \times 14$ mm) (Danielsson et al., 1990; Xie et al., 1992). Promising preliminary results have been obtained with such a small thermal device for the assay of glucose, lactate, urea and penicillin, using immobilized glucose oxidase, lactate oxidase, urease and β -lactamase. For example, a miniaturized enzyme thermistor has been used to measure the glucose concentration in 10-fold diluted whole blood. Glucose oxidase and catalase were co-immobilized on superporous agarose beads. The linear range of the device was 0.1–1.6 mM, corresponding to 1–16 mM in blood. At least 100 blood samples could be measured using the same enzyme column. The obtained concentration glucose correlated well with the Boehringer Mannheim Reflolux, used as reference method. The ultimate goal is to construct a complete flow analyser small enough to be placed on a semiconductor chip and to be produced by micro-mechanical construction methods.

8. CONCLUSION

As seen in the seven sections of this chapter, the diversity of the molecular recognition systems and of the physico-chemical transducers incorporated in each chemical sensor appears very wide. Nevertheless common features, related to their operating principles, are significant. They mainly depend upon the type of molecular receptor used:

- **Amperometric** as well as **biocatalytic based sensors**, since they consume the analyte to be measured, may reach a steady-state but never an equilibrium; knowledge of the rate-limiting

step of their response, i.e. **transport** or **reaction** is very important for the understanding of their operational properties, especially when they are implanted *in vivo* where transport kinetics are not clearly defined and may vary with implantation time, protein adsorption, etc.,

- **Potentiometric** as well as **biochelating based sensors** operate at equilibrium and are not subject to such transport limitations; on the other hand, the value of their apparent equilibrium constant, under experimental conditions, will define reversibility of sensor response, an especially important feature for *in vivo* implanted chemical sensors.

Thus some operating properties are common to different types of chemical sensors. For example, a glucose oxidase based sensor will present similar characteristics, whatever its incorporated transducer, e.g. oxygen, hydrogen peroxide or mediator electrochemical detection, oxygen optrode or flow calorimeter. In all cases glucose response may be controlled by enzyme or, alternatively, substrate diffusion kinetics, depending on the respective values of immobilized glucose oxidase activity and outer membrane semi-permeability.

Amperometric transducers respond linearly to concentration, thus giving a 20–30 dynamic range and a proportional response to errors in the measurement of current. On the contrary **potentiometric transducers** respond logarithmically to concentration, giving a much larger dynamic range, but are sensitive to small errors in the measurement of the cell voltage: for example, an error of 1 mV corresponds to at least a 4–8% error in concentration, depending on the charge of the measured species.

As discussed in Chapter 8, not all the previously described chemical sensors and biosensors have been studied *in vivo* or even *ex vivo*. A large fraction of them are still at an *in vitro* stage of development: knowledge of their operating principles and possibilities is nevertheless important for future developments. Fortunately in numerous European research groups, a high level of activity is devoted to both chemical sensor and biosensor development, design and fabrication as well as their *in vivo* exploitation. This is demonstrated by the high number of European contributions to international sensor and biomedical conferences.

REFERENCES

- Afromowitz, M.A. and Yee, S.S. (1976) Fabrication of pH sensitive implantable electrode by thick film hybrid technology. *J. Bioeng.*, 55–60.
- Albery, W.J., Boutelle, M.G., Durrant, S.L.T., Fillenz, M., Hopkins, A.R. and Mangold, B.P. (1990) Sensitive enzyme electrodes. *Phil. Trans. R. Soc. Lond. A*, 333, 49–61.
- Albery, W.J. and Craston, D.H. (1987) Amperometric enzyme electrodes: theory and experiment. In Turner, A.P.F., Karube, I. and Wilson, G.S. (eds.), *Biosensors, Fundamentals and Applications*. Oxford University Press, Oxford, 180–210.
- Alder, J.F. and McCallam, J.F. (1983) Piezo-electric crystals for mass and chemical measurements. *The Analyst*, 108 (1291) 1169–1189.
- Arnold, M.A. and Ostler, T.J. (1986) Fiber optic ammonia gas sensing probe. *Anal. Chem.*, 58, 1137–1143.
- Assolant-Vinet, C.H. and Coulet, P.R. (1986) New immobilized enzyme membranes for tailor-made biosensors. *Anal. Letters*, 19 (7 and 8) 875–885.
- Bastiaans, G.J. and Good, C.M. (1986) Immuno-assay utilizing a piezo-electric surface acoustic wave mass sensor. In: Aucouturier, J-L. et al. (eds.), *Proc. Second Int. Meeting on Chemical Sensors, Bordeaux*, pp. 49–58.
- Bergveld, P. (1981) The operation of an ISFET as an electronic device. *Sensors Actuators*, 1, 17–29.
- Bergveld, P. (1985) The impact of MOSFET based sensors. *Sensors Actuators*, 8, 109–127.
- Bergveld, P. (1986) Chemically sensitive electronic devices: the interface between microanalysis and microelectronics., In: Aucouturier, J-L. et al. (eds.), *Proc. Second Int. Meeting on chemical sensors, Bordeaux*, pp. 49–58.
- Bergveld, P. (1991) Sensors with feedback control. *Journal A*, 32 (3), 31–34.
- Bergveld, P. and Sibbald, A. (1988) *Analytical and Biomedical applications of Ion-Selective Field-effect Transistors*. *Comprehensive Analytical Chemistry*, Vol. 23. Elsevier, Amsterdam.
- Bergveld, P., Van den Berg, A., Van den Wal, P.D., Skowronska-Ptasinska, M., Sudhölter, E.J.R. and Reinhoudt, D.N. (1989) How electrical and chemical requirements for REFETs may coincide. *Sensors Actuators*, 18, 307–325.

- Bindra, D.S., Zhang, Y., Wilson, G.S., Sternberg, R., Thévenot, D.R., Moattti, D. and Reach, G. (1991) Design and in vitro studies of a needle-type glucose sensor for subcutaneous monitoring, *Anal. Chem.*, 63, 1692–1696.
- Blum, L.J. and Coulet, P.R. (ed.) (1991). *Biosensor Principles and Applications*. Marcel Dekker, New York, pp. 376.
- Bousse, L., de Rooy, N.F. and Bergveld, P. (1983) Operation of chemically sensitive field effect sensors as a function of the insulator-electrolyte interface. *IEEE Trans. Electron Dev.*, ED-30 (10), 1263–1270.
- Boutelle, M.G., Stanford, C., Fillenz, M., Albery, W.J., and Bartlett, P.M. (1986) An amperometric enzyme electrode for monitoring brain glucose in the freely moving rat. *Neurosci. Lett.*, 72, 283–288.
- Buck, R.P., Thompson, J.C., Melroy, O.R. (1980) A compilation of ion selective membrane electrode literature. In: Freiser, H., (ed.), *Ion-selective electrodes in Analytical Chemistry 2*, Plenum Press, New York, Chapter 4.
- Buytendijk, F.J.J. (1927) The use of antimony electrode in the determination of pH in vivo. *Arch. Ned. Physiol.*, 12 319–321.
- Cardosi, M.F. and Turner, A.P.F. (1991) In: Turner, A.P.F. (ed.), *Advances in Biosensors*, Volume 1. JAI Press, London, p. 1.
- Cass, A.E.G. (ed.) (1990). *Biosensors, A Practical Approach* IRL Press, Oxford, pp. 271.
- Clark, L.C. Jr and Lyons, C. (1962) Electrode systems for continuous monitoring in cardiovascular surgery. *Ann. N.Y. Acad. Sci.*, 102, 29–46.
- Clarke, D.J., Blake-Coleman, B.C. and Calder, M.R. (1987) Principles and potential of piezo-electric transducers and acoustic techniques. In: *Biosensors, Fundamentals and Applications*, Turner, A.P.F., Karube, I. and Wilson, G.S. (eds.) Oxford University Press, Oxford, pp. 551–571.
- Cobbe, S.M. and Poole-Wilson, P.A. (1980) Catheter tip pH electrodes for continuous intravascular recording. *J. Med. Eng. Technol.*, 4, 122–124.
- Cullen, D.C., Sethi, R.S. and Lowe, C.R. (1990) Multi-analyte miniature conductance biosensor. *Anal. Chim. Acta*, 231, 33–40.
- Danielsson, B. Mattiasson, B and Mosbach, K. (1981) Enzyme thermistor devices and their analytical applications. *Appl. Biochem. Bioeng.*, 3, 97–143.

- Danielsson, B., Winqvist, F., Mosbach, K. and Lundström, I. (1986) Biosensors based thermistors and semiconductors and their bioanalytical applications. Proc. Second Int. Meeting on Chemical Sensors. In: Aucouturier, J-L. (eds.), Bordeaux, pp. 599–602.
- Danielsson, B., Xie, B. and Hedberg, U. (1990) Developments in the construction of miniaturized thermal biosensors intended for *in vivo* monitoring. Fourth Workshop of the Biomedical Engineering Concerted Action on "Chemical Sensors for *In Vivo* Monitoring". In: Coughlan, M.P. (ed.), Dublin, p. 1.
- D'Amico, A., Palma, A. and Verona, E. (1982) Surface acoustic wave hydrogen sensor. *Sensors Actuators*, 3, 31–39.
- DeLuca, M. (ed.) (1978) Bioluminescence and chemiluminescence. *Methods in Enzymology*, Vol. 57. Academic Press, New York, pp. 00–000.
- Eddowes, M.J. (1990) Theoretical methods for analysing biosensor performance. In: Cass, A.E.G. (ed.), *Biosensors, A Practical Approach*. IRL Press, Oxford, pp. 211–263.
- Edwall, G. (1979) Influence of crystallographic properties of anatomy electrode potential. *Electrochim. Acta*, 24, 595–617.
- Fjeldly, T.A. and Nagy, K. (1985) Glass electrodes with solid-state membrane contacts and their application in differential potentiometric sensors. *Sensors Actuators*, 8, 261–269.
- Folkes, M.J. (1985). *Processing, Structure and Properties of Block Copolymers*. Elsevier Applied Science Publications.
- Ghijssen, W.J. and Venema, A. (1983) Optimal transducer design for the generation of SAW in silicon substrates. *Sensors Actuators*, 3, 51–62.
- Giuliani, J.F., Wohltjen, H. and Jarvis, N.L. (1983) Reversible optic wave-guide sensor for ammonia vapours. *Opt. Lett.*, 8, 54–56.
- Glab, S., Hulanicki, A., Edwall, G. and Ingman, F. (1989) Metal–metal oxide and metal oxide electrodes as pH sensors. *Anal. Chem.*, 21, 29–47.
- Göpel, W., Jones, T.A., Kleitz, M., Lundström, I. and Seyama, T. (ed.) (1991) Chemical and biochemical sensors. In: *Sensors, A Comprehensive Survey*, Göpel, W., Hesse, H and Zemel, J.N. (eds.) Vols. 2 & 3. VCH, New York pp. 703.
- Grattan, K.T.V., Mouaziz, Z. and Palmer, A.W. (1987/1988). *Biosensors* 3(1), 17–25.
- Guilbault, G.G. (1984). *Handbook of Immobilized Enzymes*. Marcel Dekker, New York.

- Guilbault, G.G., Hock, B. and Schmid, R. (1992) A piezoelectric immunobiosensor for atrazine in drinking water, *Biosensors Bioelectron.*, 7, 411–419.
- Guilbault, G.G. (1980) Use of piezo-electric crystal detector in analytical chemistry. *ISE Rev.*, 2 (1) 4–15.
- Guilbault, G.G., Hock, B. and Schmid, R. (1992) A piezoelectric immunobiosensor for atrazine in drinking water. *Biosensors Bioelectron.*, 7, 411–419.
- Hall, E.A.H. (1990) *Biosensors*. Open University Press, Buckingham, Chapter 5.
- Heideman, R.G., Kooyman, R.P.H., Greve, J. and Altenburg, B.S.F. (1991) Simple interferometer for evanescent field refractive index sensing as a feasibility study for an immunosensor. *Appl. Optics*, 30, 1474–1479.
- Heinze, R., Hoeksteen, K., Liess, H-D. and Wirtzfeld, A. (1984) Optical oxygen sensor for physiological control of heart-pacemaker. In: Bergveld, P (ed.), *Sensor Actuators, Research, Development and Application*. pp. 37–43
- Ho, M.H. (1986) Chemical and biochemical sensors using piezo-electric transducer. In: Aucouturier, J-L. et al. (eds.), *Proc. Second Int. Meeting on Chemical Sensors*, Bordeaux, pp. 639–643.
- Hochmair, E.S. and Prohaska, O. (1985) Implantable sensors for prostheses. In: Ko, W.H. (ed.), *Implantable Sensors for Closed-loop Prosthetic Systems*. Futura Publishing, Mountkisco, N.Y., Chapter 4.
- Kiefer, H., Klee, B., John, E., Stierhof, Y.D. and Jähnig, F. (1991) Biosensors based on membrane transport proteins, *Biosensors Bioelectron.*, 6, 233–237.
- Kooyman, R.P.H., Bruijn, H.E., de Eenink, R.G. and Greve, J. (1990) Surface plasmon resonance as a bioanalytical tool. *J. Molec. Struct.*, 218, 345–350.
- Konash, P.L. and Batiaans, G.J. (1980) Piezo-electric crystals as detectors in liquid chromatography. *Anal. Chem.*, 52, 1929.
- Kösslinger, C., Drost, S., Aberl, F., Wolf H., Koch, S. and Woias P. (1992) A quartz crystal biosensor for measurement in liquid. *Biosensors Bioelectron.*, 7, 397–404.
- LeBlanc, O.H., Brown, J.F and Kleve, J.F. (1976) Polymer membrane sensors for continuous intravascular monitoring of blood pH. *J. Appl. Physiol.*, 40, 644–647.
- Löffler, U., Wiemhöfer, H-D. and Göpel, W. (1991) Amperometric biosensors: characterization of dispersed mediator systems, *Biosensors Bioelectron.*, 6, 343–352.

- Lu, C. and Czanderna, A.W. (eds.) (1984) *Methods and Phenomena 7: Applications of Piezo-electric Quartz Crystals Microbalances*. Elsevier, Amsterdam.
- Malmros, M.K., Guilbinski, J., and Gibbs, W.B. (1987/88) Polymer film sensor for glucose. *Biosensors*, 3, 71–87.
- Mansouri, S. and Schultz, J.S. (1984) A miniature optical glucose sensor based on affinity binding. *Biotechnology*, 885–889.
- Margules, G.S., Hunter, C.M. and MacGregor, D.C. (1983) Hydrogel based in vivo reference electrode catheter. *Med. Biol. Eng. Comp.*, 21, 1–8.
- Mattiasson, B., Borrebaeck, C., Sanfridsson, B. and Mosbach, K. (1977) Thermometric enzyme linked immunosorbent assay: TELISA. *Biochem. Biophys. Acta*, 483, 221–227.
- Moatti, D., Capron, F., Poitout, V., Reach, G., Bindra, D.S., Wilson, G.S. and Thévenot, D.R. (1992) Towards continuous glucose monitoring: in vivo evaluation of a miniaturized glucose sensor implanted for several days in rat subcutaneous tissue, *Diabetologia*, 35, 224–230.
- Mosbach, K. (ed.) (1988) *Methods in Enzymology*, Vol. 137. Academic Press, New York.
- Ngeh-Ngwainbi, J., Foley, P.H., Jordan, J.M., Guilbault, G.G. and Palleschi, G. (1986) Protein coated piezo-electric crystal detectors. In: Aucouturier, Proc. Second Int. Meeting on Chemical Sensors, J. and Salardenne, J. (eds.), Bordeaux, pp. 515–518.
- Olthuis, W., Van der Schoot, B.H., Cahvez, F. and Bergveld, P. (1989) A dipstick sensor for coulometric acid-base titrations. *Sensors Actuators*, 17, 279–284.
- Olthuis, W., Bommer, J.G., Bergveld, P., Bos, M. and van der Linden, W.R. (1992) Iridium oxide as actuator material for the ISFET-based sensor-actuator system. *Sensors Actuators*, B5 (1-4), 47–52.
- Ottenbacher, D., Kindervater, R., Gimmel, P., Klee, B., Jähnig, F. and Göpel, W. (1992) Biosensor with capacitive- and pH-ISFET transducers utilizing lipid-bilayer membranes with transport proteins. *Sensors Actuators*, in press.
- Peterson, J.I., Goldstein, S.R., Fitzgerald, R.V. and Buckhold, D.K. (1980) Fiber optic pH probe for physiological use. *Anal. Chem.*, 52, 864–869.
- Pickup, J.C., Shaw, G.W. and Claremont, D.J. (1989) Potentially implantable amperometric glucose sensors with mediated electron transfer: Improving the operating stability. *Biosensors*, 4, 109–119.

- Reinhoudt, D.N. and Sudhölter, E.J.H. (1990) The transduction of hostguest interactions into electronic signals by molecular systems. *Adv. Mater.* 2, (1) 23–32.
- Roederer, J.E. and Bastiaans, G.J. (1983) Microgravimetric immunoassay with piezoelectric crystals. *Anal. Chem.*, 55, 2333–2336.
- Saari, L.A. and Seitz, W.R. (1982) pH sensor based on immobilized fluoresceinamine. *Anal. Chem.* 54, 821–823.
- Sansen, W., de Wachter, L., Callewaert, L., Lambrechts, M. and Claes, A. (1990) A smart sensor for the voltammetric measurement of oxygen or glucose concentrations. *Sensors Actuators*, B1, 298–302.
- Sauerbrey, G.Z. (1959) Use of a quartz vibrator for weighting thin layers on a microbalance. *Z. Physik.*, 155, 206–210.
- Schasfoort, R.B.M., Kooyman, R.P.H., Bergveld, P. and Greve, J. (1990) A new approach to Immuno FET operation. *Biosensors Bioelectron.*, 5, 103–124.
- Thévenot, D.R., Coulet, P.R., Sternberg, R., Laurent, J. and Gautheron, D.C. (1979) Enzyme collagen membrane for electrochemical determination of glucose traces. *Anal. Chem.*, 51, 96–100.
- Thévenot, D.R., Sternberg, R. and Coulet, P.C. (1982) A glucose electrode using high-stability glucose oxidase collagen membranes. *Diabetes Care*, 5 (3) 203–206.
- Turner, A.P.F., Karube, I. and Wilson G.S. (eds.) (1987) *Biosensors, Fundamentals and Applications*. Oxford University Press, Oxford, pp.770.
- Wilson, G.S. and Thévenot, D.R. (1990) Unmediated amperometric enzyme electrode. In: A.E.G. Cass (ed.), *Biosensors: A Practical Approach*. IRL Press, Oxford, pp. 1–15.
- Wilson, G.A., Zhang, Y., Reach, G., Moatti-Sirat, D., Poitout, V., Thévenot, D.R., Lemonnier, F. and Klein, J-C. (1992) Progress toward the development of an implantable sensor for glucose, *Am. A. Clin. Chem.* (in press).
- Wohltjen, H. and Dessy, R. (1979) Surface acoustic wave probe for chemical analysis. I. Introduction and instrument description. II. Gas chromatography detector, III. Thermomechanical polymer analyser. *Anal. Chem.*, 51, 1465–1470, 1470–1475.
- Xie, B., Danielsson, B., Norberg, P., Winquist, F. and Lundström, I. (1992) Development of a thermal micro-biosensor fabricated on a silicon chip. *Sensors Actuators*, 6, 127–130.