



HAL
open science

The use of microprocessors for the evaluation of the analytical performance of enzyme- based sensors

Daniel R. Thévenot, Thierry Tallagrand, Robert Sternberg

► **To cite this version:**

Daniel R. Thévenot, Thierry Tallagrand, Robert Sternberg. The use of microprocessors for the evaluation of the analytical performance of enzyme- based sensors. *Biosensors*, 1987, 35, pp.705-720. hal-01179639

HAL Id: hal-01179639

<https://hal.science/hal-01179639>

Submitted on 23 Jul 2015

HAL is a multi-disciplinary open access archive for the deposit and dissemination of scientific research documents, whether they are published or not. The documents may come from teaching and research institutions in France or abroad, or from public or private research centers.

L'archive ouverte pluridisciplinaire **HAL**, est destinée au dépôt et à la diffusion de documents scientifiques de niveau recherche, publiés ou non, émanant des établissements d'enseignement et de recherche français ou étrangers, des laboratoires publics ou privés.

The use of microprocessors for the evaluation of the analytical performance of enzyme-based sensors

DANIEL R. THÉVENOT, THIERRY TALLAGRAN, and
ROBERT STERNBERG

35.1 Introduction

Biosensors such as enzyme electrodes, using enzymatic membranes and electrochemical detectors, usually present a great specificity for a given metabolite such as sugar or amino acid (Thévenot *et al.* 1978, 1979; Sternberg *et al.* 1980). The operating properties and the analytical characteristics of these biosensors are dependent upon a large number of physical, chemical and enzymatic parameters (Sternberg 1983a) which are often difficult to discriminate. Programmable calculators and microcomputers have been used by several research groups for instrument development (Skogberg *et al.* 1979; Jaenchen *et al.* 1982; Kernevez *et al.* 1983; Wieck *et al.* 1984). Numerous Japanese patents on enzyme-based sensors refer to automation involving microcomputers or microprocessors (Kawana *et al.* 1979; Kyoto Daiichi Kagaku K. K. 1982; Tsuji *et al.* 1983; Mitsubishi Rayon Co. 1983). These instruments may alternatively be of great help in a more direct association with enzyme electrodes:

firstly, for the study and optimisation of their analytical properties, especially their precision, repeatability, and extension of measurable concentration domain (De Laforcade, 1980),

secondly, for the direct or indirect determination of some parameters which play an important role in the sensor response (Thévenot 1982; Dubois 1984).

This chapter presents attempts to use programmable calculators and microcomputers to evaluate the analytical performances of amperometric glucose electrodes (Tallagrand *et al.* 1983).

35.2 Material and methods

35.2.1 Enzyme electrodes

All the enzyme electrodes used in this study consisted of glucose oxidase

(GOD) membranes maintained in close contact with a platinum disk. Enzymatic membranes were either prepared by acyl-azide activation of reconstituted collagen films (Thévenot *et al.* 1979) or by entrapment of enzyme in cellulose acetate films (Sternberg *et al.* 1983b). The latter membrane was fabricated manually, in steps, from a solution consisting of 5% cellulose diacetate, 91.5% acetone, 1% polyvinylpyrrolidone, 2.5% water, and an enzyme solution of 5 mg glucose oxidase (EC 1.1.3.4 Boeringer grade II) in 3 ml of acetate buffer; 3 ml of cellulose acetate solution and 0.2 ml of enzyme solution were mixed for 5 min, then spread on a glass plate with the aid of a 5, 15, or 30 micron spreader to produce a thin film. After drying for 2–5 min, the membrane was rinsed with distilled water and then stored in acetate buffer, pH 5.6.

Electrochemical measurements were made using a Solea PRGDEL potentiostat and current amplifier connected to a strip chart recorder. When a differential set up was used i.e. when both an enzymatic and a non-enzymatic sensor were placed in contact with stirred or flowing samples, both working electrodes were connected to a Solea DELTAPOL differential current amplifier, linked to the potentiostat. This set up (Thévenot *et al.* 1979) permitted the measurement of the difference between the current corresponding to the enzymatic reaction (I_1) and of the background current (I_2) i.e. calculation of $I_1 - k.I_2$ with k ranging between 0.5 and 2. When the first and second derivative of current outputs were needed, an analogic derivative amplifier (Solea Derivol) and 1 second time base (Solea GCMR) were used.

Electrodes housings were either modified gas electrodes dipped into a thermostated stirred solution (Thévenot *et al.* 1979) or modified electrochemical cells for HPLC (Solea Tacussel type DEL-1). The latter consisted of two blocks of polyethylene separated by a Teflon spacer. One block contained the entry and exit holes for liquid, the other accommodated two platinum electrodes (working and auxiliary) and a reference electrode (Ag/AgCl, sat. KCl). The Teflon spacer was hollowed out in the middle in order to permit circulation of liquid and to define the volume of the reaction chamber (0.02 ml). A cellulose acetate membrane containing enzyme was placed in the cell between the sensing electrodes and the Teflon spacer. Solution was circulated to the cell using a Gilson Minipuls II peristaltic pump at a flow rate ranging between 0.1 and 2 ml/min.

35.2.2 Programmable table calculator for an enzyme electrode

In order to evaluate the linearity and repeatability of glucose sensors, we added to the previous equipment a Hewlett Packard 97 S programmable table calculator (De Laforcade 1980). Its binary coded decimal input and four outputs were interfaced to the potentiostat and to an electric buret through a Solea Ionomate 80 digital Millivoltmeter (range ± 2000 mV,

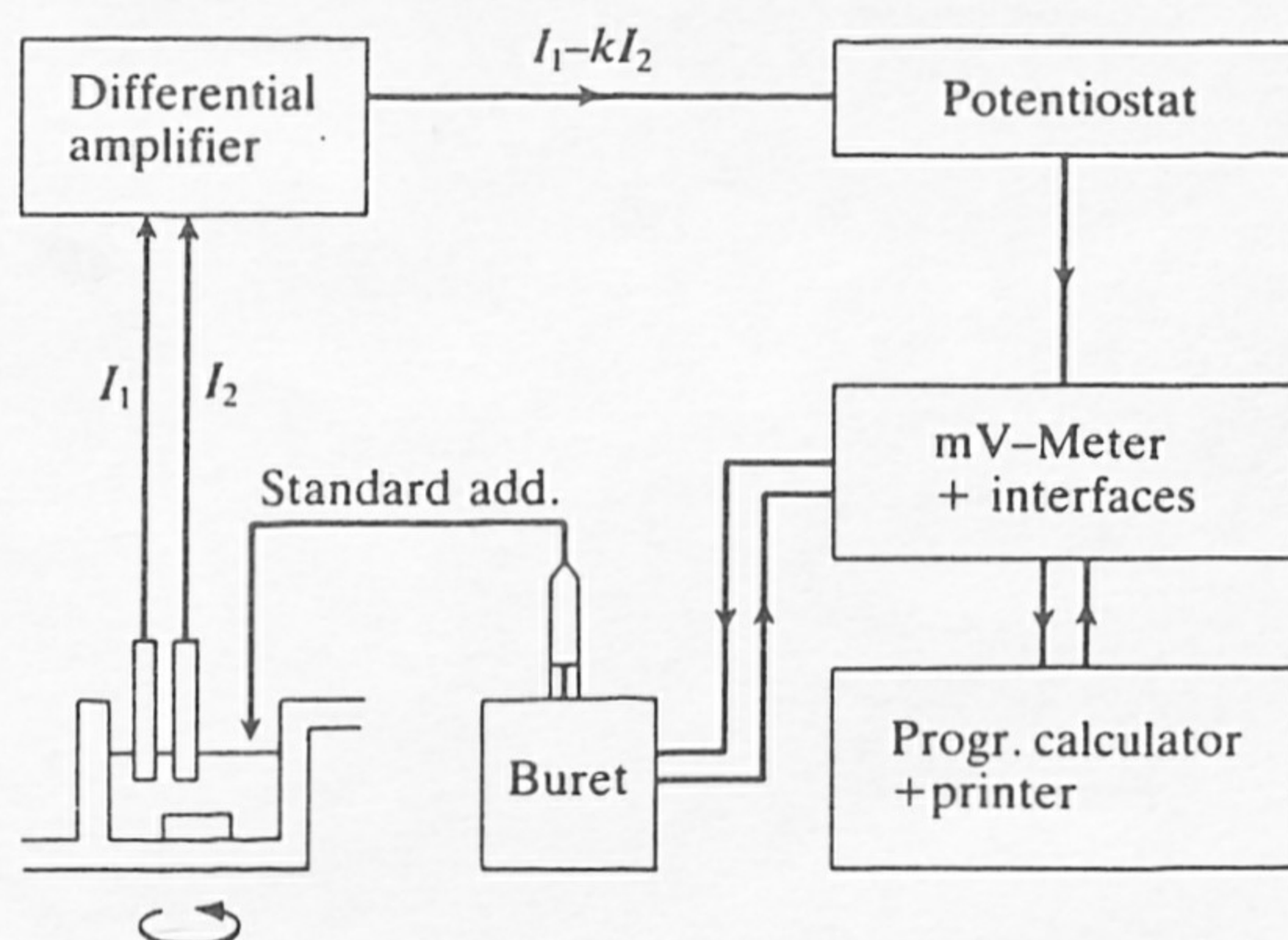

Fig. 35.1 Block diagram of electrodes and electronics using a programmable calculator for an automated enzyme-based electrode, (from Thévenot *et al.* 1982).

precision 0.1 mV) (Fig. 35.1). We have developed a program that perform two main functions:

- a) determination of steady-state response by detecting stable output currents before and after sample addition into the reaction vessel where electrodes are dipped in and print-out of steady-state current
- b) control of glucose standard additions by the electronic buret (Solea EBX with Solea EBX-INT interface) and statistical analysis of responses to several equal additions (1 to 50) with print-out of each response as well as mean, standard deviation and coefficient of variation.

For determination of unknown glucose concentrations, this program has been modified, replacing the second step by the automatic calibration of the glucose sensor with two successive standard glucose additions and calculation of glucose level, in unknown samples, using the response to the second glucose standard. In order to check for interferences, a post-calibration procedure has been developed: after several sample additions, another glucose standard is added into the vessel and the steady-state response variation is printed.

35.2.3 Microcomputer for an enzyme electrode

The above mentioned calculator does not allow storage of more than 26 variables and thus does not permit storage of the entire response curves, therefore an alternative set up was developed using an Apple II 64 K micro-computer (Fig. 35.2). The data acquisition interface connected to the potentiostat consisted of a 12 bit, 16 channel, 4 range A.D.C. (GD 16V 12B 4G) and a programmable offset 8 bit D.A.C. (GD Offset Prog). Data

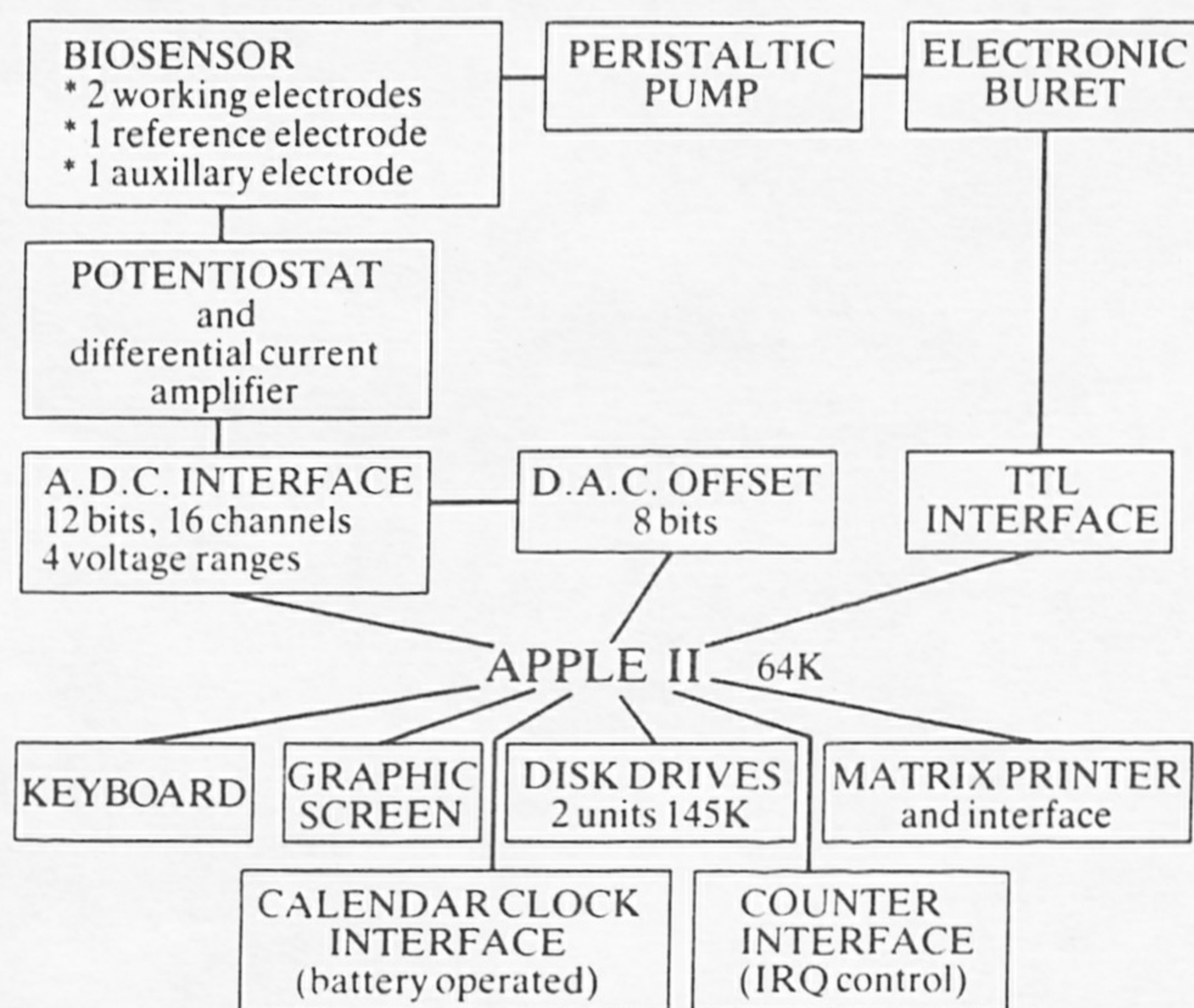

Fig. 35.2 Block diagram of electrodes and electronics using a microcomputer for an automated enzyme-based electrode.

acquisition was controlled by IRQ interrupts generated by a programmable timer module (CCS 7440A). A battery operated real-time calendar clock interface (Mountain Hardware Apple Clock) allowed identification of experiments by exact start time. The electronic buret Solea EBX was interfaced to the microcomputer by a 8 TTL input and 8 relay card (MID CR8C).

35.2.4 Electrode responses

When a glucose-containing sample is added to a solution of 0.2 M acetate buffer, 0.1 M KCl (pH 5.7) into which both electrodes are dipped or circulating through modified HPLC electrode, several different current vs. time curves may be recorded:

- a) I_2 is the output current of the non-enzymatic, compensating electrode E_2 . I_2 is the background response and is usually very low except if the sample contains electrochemical reducing species (ascorbate, urate, sulphites etc.) and if the GOD membrane presents no permselectivity (reconstituted collagen films).
- b) $(I_1 - k.I_2)$ where k is close to 1, and corresponds to the detection of enzymatically generated hydrogen peroxide; it reaches a steady-state value after 2–3 min (0.3–0.5 mm thick collagen films) or 0.5–3 min (0.005–0.025 mm thick cellulose acetate films); this is the steady-state response of the sensor.

c) $d(I_1 - k.I_2)/dt$ is maximum after 20–50 s (collagen) or 10–60 s (cellulose acetate); the height of the peak is the dynamic response of the sensor. Thus 3 different current vs. time curves are available and usually recorded on a 3-channel Linear 395 recorder. When non-enzyme compensating electrode E_2 is absent, only I_1 and dI_1/dt signals are recorded. The calculator or microcomputer are linked to either $I_1 - k.I_2$ or to I_1 and I_2 current outputs.

35.2.5 Analytical evaluation of sensors

Methods of analytical evaluation of glucose electrodes are different for dipped-in and flow-through sensors.

In the first case, glucose oxidase and compensating electrodes are dipped in a 20 ml thermostated stirred buffer solution or incorporated into the wall of a special 1–5 ml thermostated vessel capable of supporting horizontal glass rods. All assays are performed by small volume additions of samples or standard glucose solutions into the vessel. Prior to the experiment buffer solutions are saturated with air at the given experimental temperature, i.e. 30 or 37°C. Background current is measured in buffer solution after 0.5–2 h polarization of the platinum working electrodes. Calibration, linearity, and repeatability assays are performed simultaneously by 10 to 50 additions of equal amounts of glucose standard into the reaction vessel. These additions are usually made by electronic buret when stable output current is detected by the calculator, i.e. when previous response to glucose addition has reached a steady state. Responses are calculated either by comparing steady-state current to background current I_{bg} prior to any glucose addition or by subtracting the steady-state current corresponding to previous addition: thus either $I - I_{bg}$ vs. C or $\Delta I/\Delta C$ vs. C curves are plotted (C is the total glucose concentration in reaction vessel).

When the flow-through cell is used, either buffer solution or glucose containing buffer solution is pumped through the sensor. In both cases these solutions are carefully thermostated and saturated with air at the experimental temperature (37°C) prior to experiment. Calibration, linearity, and repeatability assays are performed, as mentioned above, by recirculating the output solution into the storage vessel.

35.3 Automation of glucose enzyme electrodes using programmable calculator

Determination of analytical patterns of enzyme in standard solutions is usually performed by accurate tests of electronic equipment alone as well as careful study of the whole instrument, including biosensor, electronic equipment, and recording or display devices. Although the potentiostat, the differential current amplifier, and the derivating current amplifier used in this

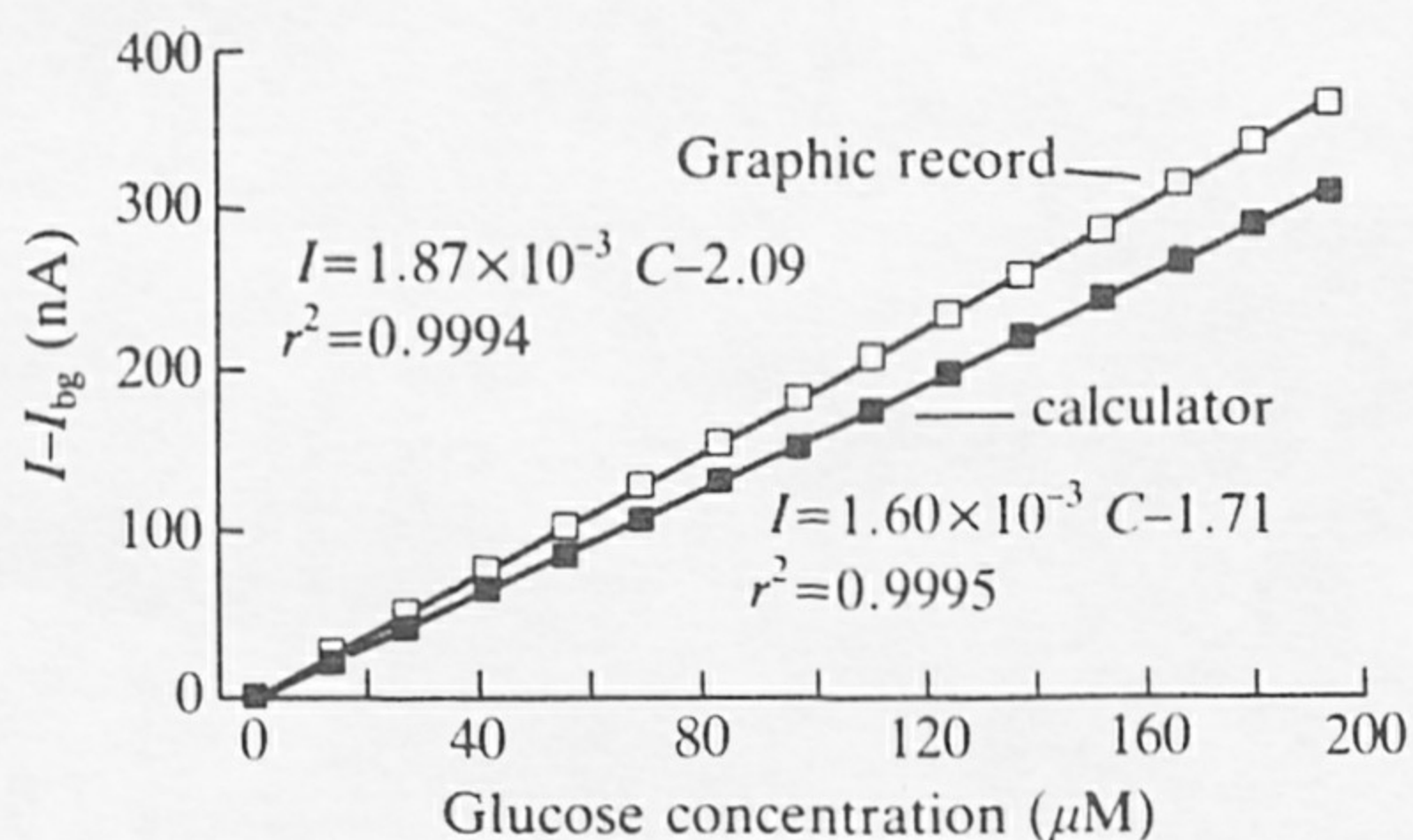

Fig. 35.3 Calibration curves of steady-state responses to 15 additions of a glucose standard: comparison of responses determined on chart recorder and with a programmable calculator. GOD collagen membrane, $30.0 \pm 0.1^\circ\text{C}$, $50 \mu\text{l}$ additions of 5.55 mM glucose into 20 ml of acetate buffer (from De Laforcade 1980).

study gives good accuracy, linearity, repeatability, and very low drift, the 3-channel recorder offers poor reproducibility yielding a coefficient of variation (CV) of 1.73% for 50 successive measurements on a dummy cell (De Laforcade 1980). On the contrary the programmable calculator, connected to the output signals by a BCD interface and a mV-meter presents a much better repeatability (CV = 0.64% for 50 assays). Thus, it seems important to use both the calculator and the graphic recorder during repeatability assays of the whole instrument.

In order to simultaneously determine the background current I_{bg} and the calibration curve of the instrument, successive additions of glucose standard may be made and the steady-state current measured before all additions and after each addition. These steady-state currents are either directly measured on recorded response curve or determined using the calculator when signal drift is lower than a threshold value (usually 0.2 nA/min). Besides this steady-state current determination, the calculator is also able to perform two other functions: it controls additions of glucose standards, by electronic buret into the vessel where sensor is dipped, and it calculates and prints mean values and coefficients of variation for several equal additions of standard. Thus the whole experiment may be performed without interruption in a very accurate and reproducible way (Fig. 35.1).

Printouts and graphics curve responses may be plotted as calibration curves, i.e. as $I - I_{bg}$ vs. C . Fig. 35.3 presents typical results obtained with 15 successive $50 \mu\text{l}$ additions of 5.55 mM glucose standard into 20 ml acetate buffer. Linear regression of these plots gives following equations:

for steady-state graphic responses:

$$I(\text{A}) = 1.87 \times 10^{-3} C - 2.09 \text{ with } r^2 = 0.99945,$$

for steady-state printed responses:

$$I(\text{A}) = 1.60 \times 10^{-3} C - 1.71 \text{ with } r^2 = 0.99949,$$

glucose concentration C being expressed in mole/l in reaction vessel. As such plots do not allow an accurate determination of linearity, we prefer to plot the increase of steady-state current vs. the increase of glucose concentration in the vessel, i.e. ΔI vs. ΔC . In all experiments such plots give a better linearity or repeatability if they are measured using the calculator: coefficients of variation equal, for example, 6.5 and 8.0% for 15 successive steady-state calculator and graphic responses, respectively. It appears on almost all such assays that response to the first glucose addition is significantly smaller than to the following ones: indeed, when unknown glucose solutions are determined by addition of samples into the same buffer, we prefer to use the response to the second glucose standard as the reference for calculation of the calibration curve equation. When the derivative current amplifier is used, it is also possible to measure the maximum of the first derivative dI/dt . This dynamic response is proportional to the glucose concentration increase and usually presents a better reproducibility than the graphic steady-state response ($CV = 5.7\%$ for 15 assays).

The use of this automated glucose electrode enables rapid characterization of sensors prepared with various enzymatic membranes electrode housings and reaction vessels, avoiding time-consuming production and interpretation of graphs. For example, it appears that better stirring of buffer solution gives better reproducibility of steady-state responses (Fig. 35.4): an increase of the 1 cm stirring bar rotation rate from 320 to 530 rpm slightly decreases the steady-state calibration curve slope from 1.7 to 1.6 mA/M and significantly decreases the steady-state coefficient of variation from 9.4 to 2.0% ($n = 8$). Thus a better definition of hydrodynamic conditions in the enzymatic membrane vicinity is necessary: a flow-through cell derived from an electrochemical detector for HPLC has been tested. An alternative to such hydrodynamic cell is a rotating membrane electrode in which diffusion layer thickness may be defined with great accuracy: such a set-up is especially suitable for permeability and diffusion coefficients determination of the enzymatic membrane (Dubois 1984).

Since the noise level increases with total concentration and current levels, the absolute precision on $\Delta I/\Delta C$ is better for the first standard additions than for the following ones: for example $CV = 2.0\%$ for the first eight glucose standard additions, whether $CV = 10.9\%$ for the following seven standard additions (Fig. 35.4 bottom, steady-state response on calculator). Thus, when the enzyme-based sensor is used in a stirred reaction vessel where both standard and samples are added, one should change the buffer solution and rinse the sensor often enough to keep the precision at a suitable level.

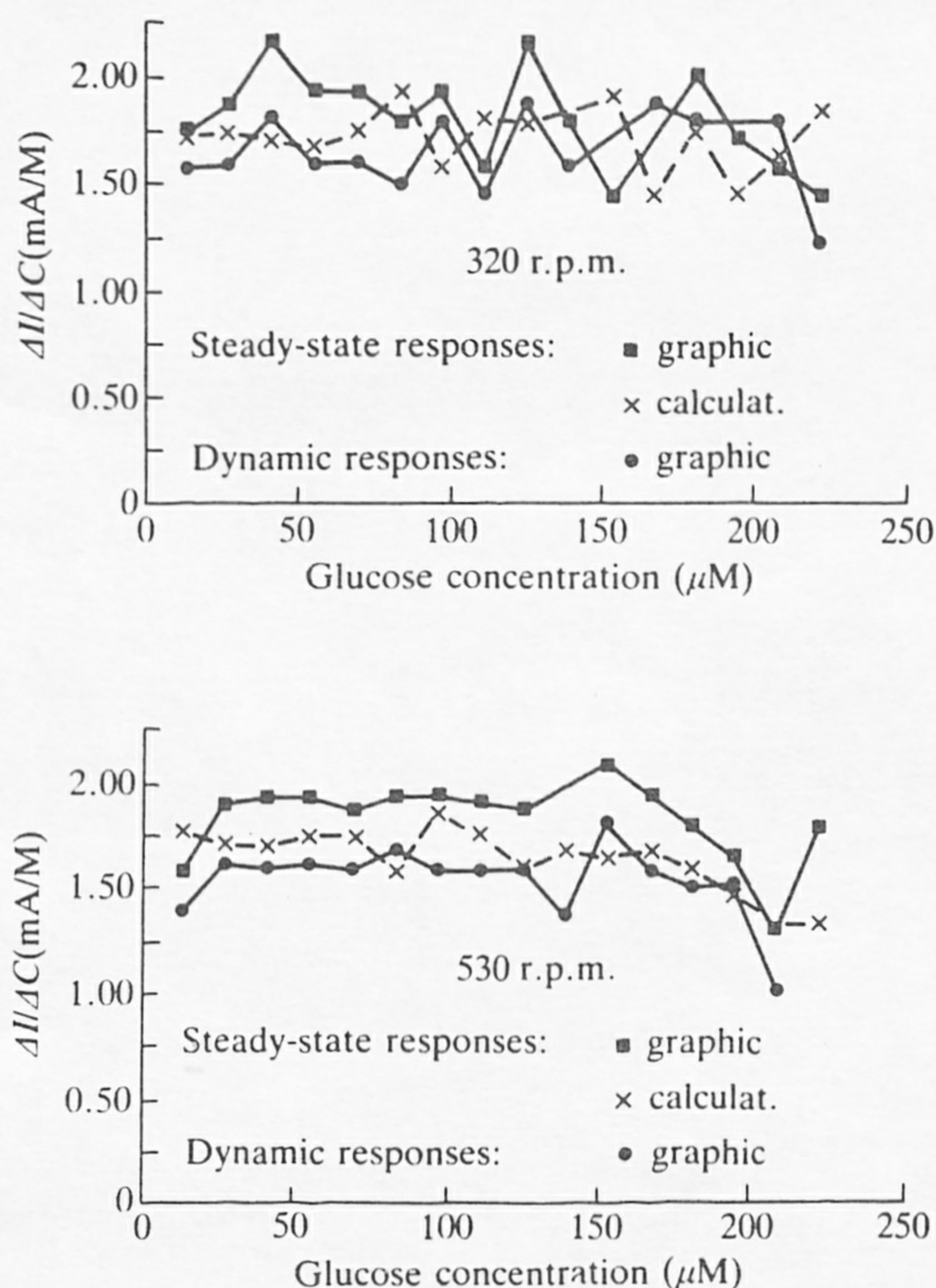

Fig. 35.4 Comparison of the reproducibility of response to 16 additions of glucose under different stirring conditions: (top) 320 and (bottom) 530 rpm of a 1 cm stirring bar in 20 ml buffer solution. (+) Graphic and (●) calculator steady-state, and (×) dynamic responses; same conditions as Fig. 35.3.

Such a set-up is able to evaluate analytical performances of steady state responses, but it is unable to characterize transient responses and to store a whole response curve for a more detailed study. Thus we developed a more powerful device which uses a microcomputer for data storage and treatment.

35.4 Microcomputer for automation of glucose enzyme electrodes

35.4.1 Development of an automated device for enzyme electrode evaluation

The use of personal microcomputers enables much wider possibilities for data storage and versatility than any table calculator. The previously

described calculator and mV-meter interface can be replaced by a commercially available 12 bit A.D.C. interface connected to a stable 8 bit D.A.C. used as programmable offset for increasing precision of analogue to digital conversion (Fig. 35.2). Whereas in the previous set-up the acquisition rate was fixed to the maximum possible value at *ca.* 0.5 Hz, this device allows a much more accurate and versatile control of acquisition rate: this is achieved with IRQ interrupts generated by a time counter card containing three 16 bit chained counters. The buret is controlled by a TTL input, relay output card and may add given amounts of glucose standard to the reaction vessel.

Software has been developed for this application using two input channels respectively connected to the enzymatic E_1 and compensating E_2 electrodes. As shown in Fig. 35.5, this software is organized around a branching 'menu' and contains several programs linked together by a parameter file. Depending upon the speed necessary for each of these programs, either 6502 machine or compiled basic language is used. For example, the installation procedure during which all experimental parameters such as (a) identification numbers, (b) potential range (± 20 , ± 100 , ± 500 , or ± 2500 mV), (c) signal units (nA or mA), (d) actual ranges (ex: 200 nA for 5000 mV), (e) acquisition frequency, and (f) number of data (lower than 2000) is stored in a random access file during a conversational compiled basic program.

The actual experimental program consists of several linked compiled basic programs during which:

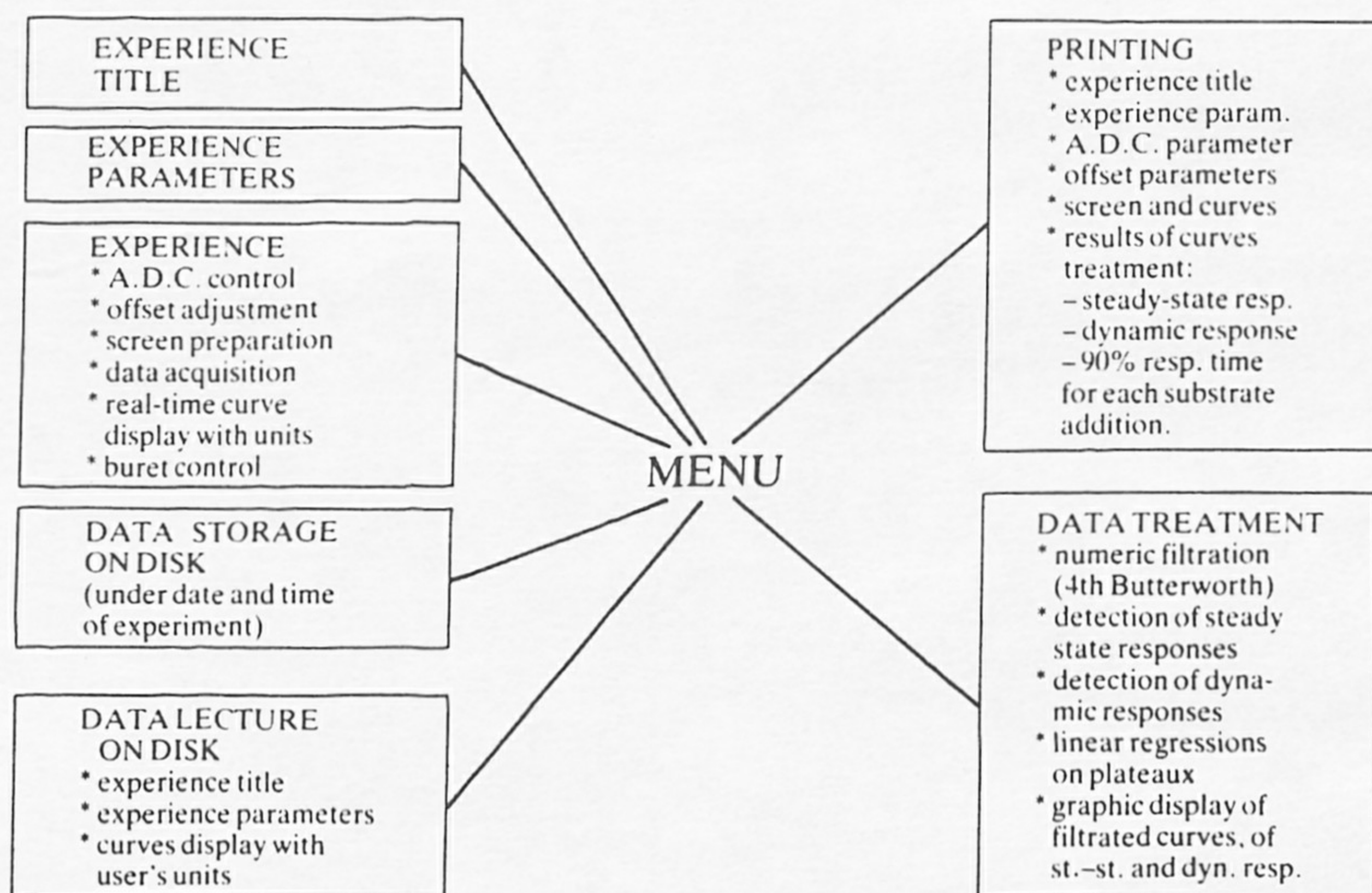

Fig. 35.5 Block diagram of software developed for the automated enzyme-based electrodes using an Apple II + microcomputer.

- a) the A.D.C. card is tested for zero drift,
- b) the offsets for both channels are optimized for decreasing background signals prior to the experiment,
- c) the high resolution screen is prepared and axes are graduated in user defined units,
- d) the actual starting date and time is measured and stored on the parameter file,
- e) the time counters are initiated for IRQ interrupts at the controlled frequency,
- f) and the acquisition procedure is started under a manually operated switch.

Then several machine language programs

- a) control data acquisition on both channels,
- b) store numerical values as most significant and less significant bytes,
- c) and display points corresponding to both channels on the high resolution screen.

Such a procedure of acquisition and real-time curve display is not limited by execution time of these programs but by response times of A.D.C. and D.A.C. With these commercially available devices a period of 30 ms is necessary when potential ranges and offset values are different for each channel. If the system is used with a single channel, the acquisition frequency reaches 2.5 kHz; it may ultimately reach 15 kHz when curve display on the screen is performed at the end of the experiment. Finally, addition of given volumes of standard at a given periodicity may be achieved using a machine language program which controls the step motor of the buret and counts delivered volume as TTL signals.

Results may be stored on the user's disk as parameter and data files named under starting date and time. Alternatively, a previous experiment may be completely recalled by reading corresponding experimental parameters and data files and by displaying curves on the high-resolution screen in the user's unit.

In order to keep track of each experiment all parameters including A.D.C. zeros and offset values, actual screen displays, and untreated or treated curves and results of data treatment may be hard-copied on a dot-matrix printer (Fig. 35.6 top).

The last component of this automated device is a data treatment unit which is a set of linked compiled basic programs. These programs, placed on the second side of the program disk, perform several treatments on previously stored data:

- a) a 4th order Butterworth numeric filter attenuates the signal at a frequency larger than a threshold value, chosen by user,

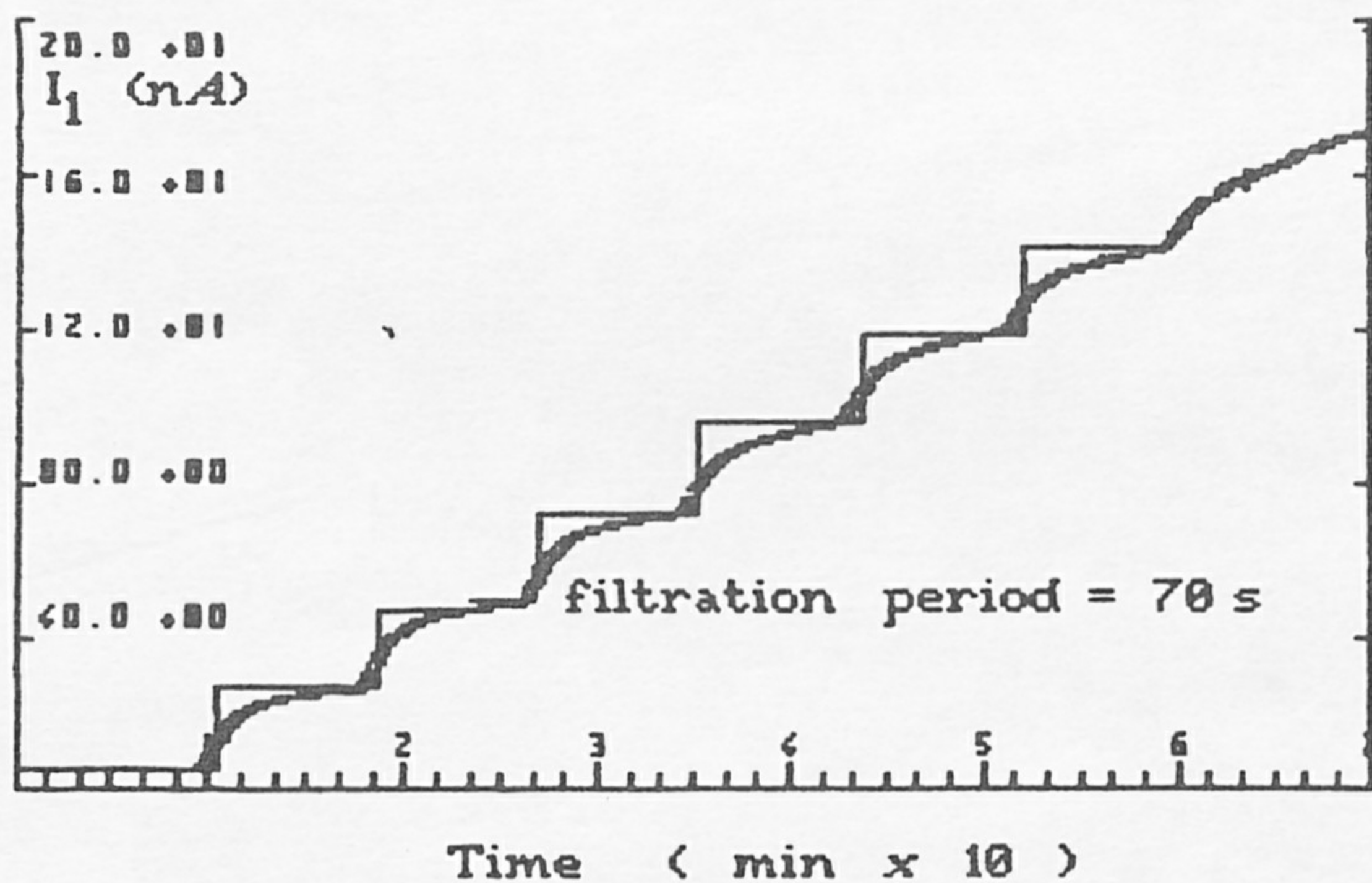
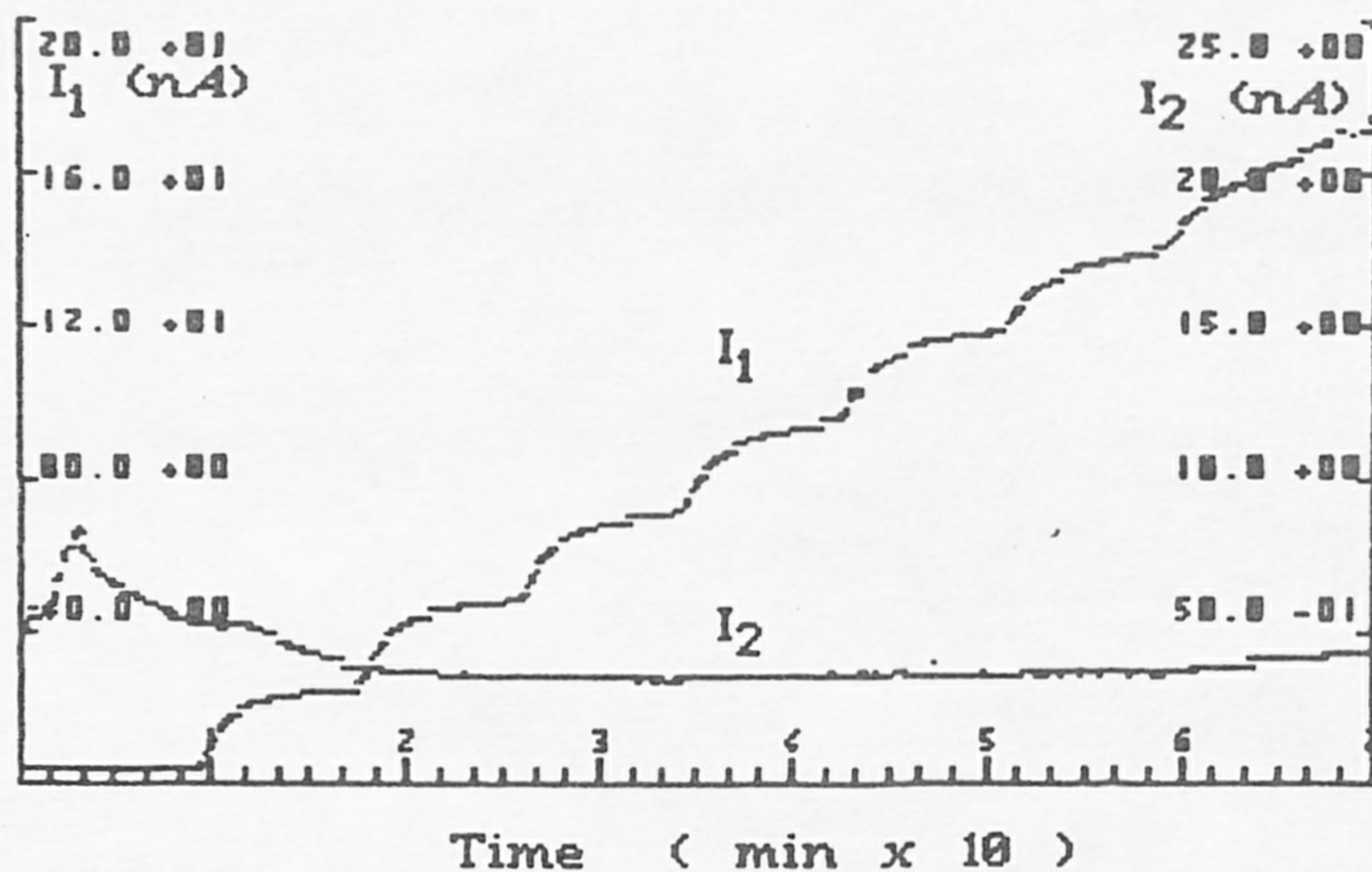

Fig. 35.6 Hard copy of high resolution screen during linearity assays of a flow-through glucose electrode at high concentration: (top) experimental and (bottom) treated response curves to seven increases of glucose concentration by 5 mM steps. GOD cellulose acetate membrane, $37.0 \pm 0.1^\circ\text{C}$, seven $30 \mu\text{l}$ additions of 0.50 M glucose into 3 ml of acetate buffer placed in a closed loop (additions every 500 s).

- b) steady-state signals are detected on filtered data when their slopes are smaller than a user chosen value, the equations of these almost horizontal parts of curves are calculated by linear regression and the corresponding steady-state response, i.e. ΔI are determined,
- c) when the first derivative of the filtered data reaches a maximum, the corresponding dynamic responses $(dI/dT)_{\max}$ are determined,
- d) all these operations are controlled by the user, since filtrated curves, plateaux and inflexion points are displayed on screen (Fig. 35.6 bottom).

Simultaneously a file is created with all steady-state and dynamic responses, in users units, and all dynamic and steady-state response times: the user may either validate these data and store them on the corresponding parameter file, or discriminate undesirable values, or even resume the whole treatment procedure.

Finally, software has been created for reading all parameters and data on previously mentioned files and for storing both channels and time coordinates, in user's units, under the data-interchange format (D.I.F.) used by most commercial software such as worksheets: thus any systematic calculation may be performed on either all data or on a selection of them made by experimenter.

35.4.2 Use of the automated device for glucose electrode evaluation

This set-up and software allows large number of repetitive experiments designed for comparison of various GOD membranes and glucose sensors to be performed. Figure 35.6 presents typical results of repeatability and linearity assays at high glucose concentration using a cellulose acetate enzyme membrane placed in a flow-through cell: seven increases of glucose concentration by 5 mM steps give steady-state responses (upper curve); the value of these responses may be determined using the data treatment programs (lower curve) as ranging between 21.9 and 23.7 nA using a filtration period of 70 s; corresponding dynamic response range between 21.7 and 24.4 nA/s demonstrating a good linearity of this glucose sensor response up to 30 mM glucose.

During similar evaluation of glucose sensors we have tested their response to an artificial glucose concentration vs. time profile. Figure 35.7 presents such a profile (upper curve) for simulated intravenous glucose tolerance tests (IVGTT) of various kinetic patterns. It appears that such a device responds to increasing and decreasing glucose level but that its steady-state response time may be somewhat too large for such an application.

Such membranes are suitable for some *in vivo* glucose determination, as tested on an external blood shunt of conscious rats (Thévenot *et al.* 1985) but present relatively low response values (1 to $10 \mu\text{A} \times \text{M}^{-1} \times \text{mm}^{-2}$) and sometimes excessive response values (0.4 to 3 min). Further experiments are

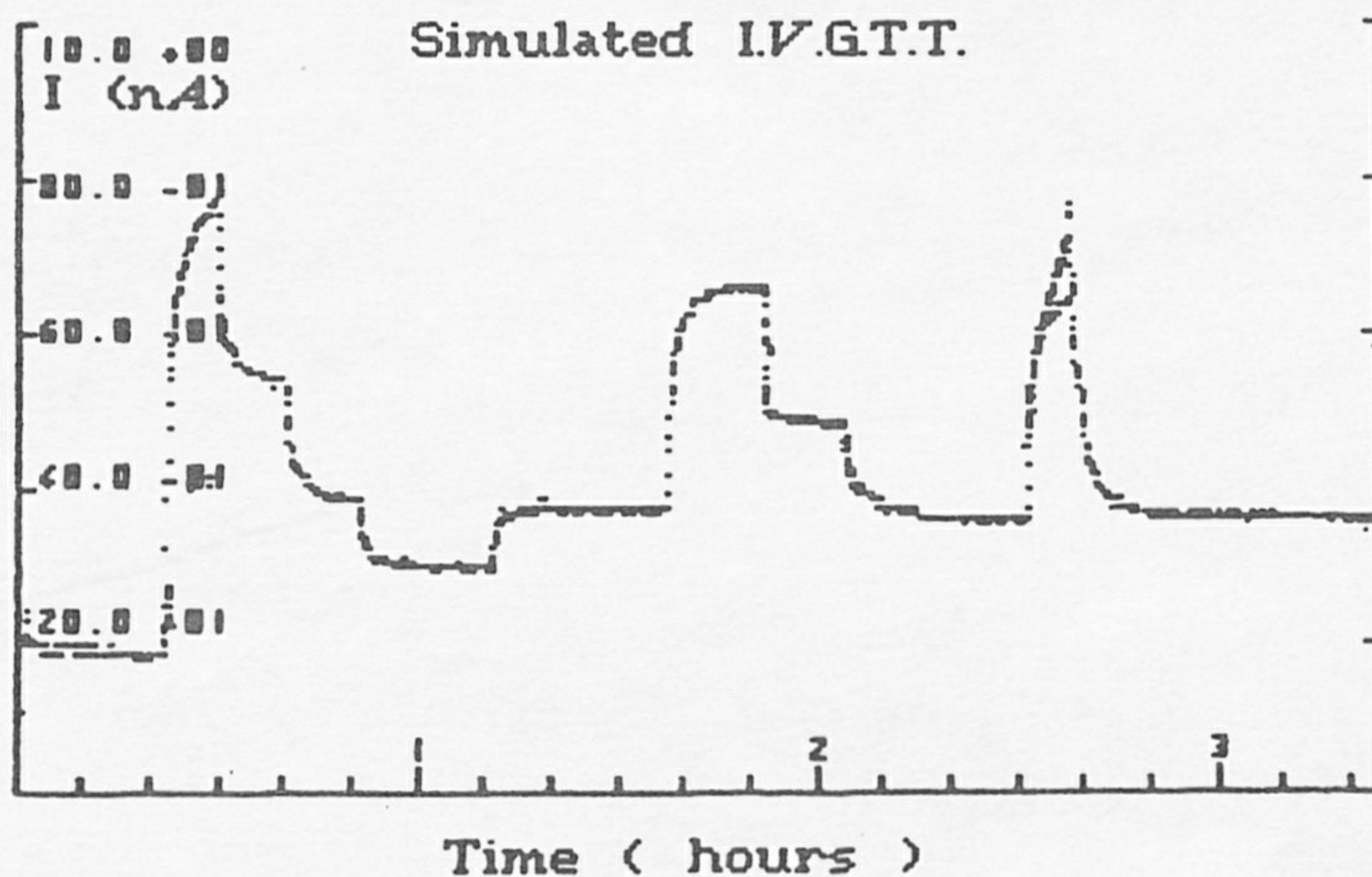
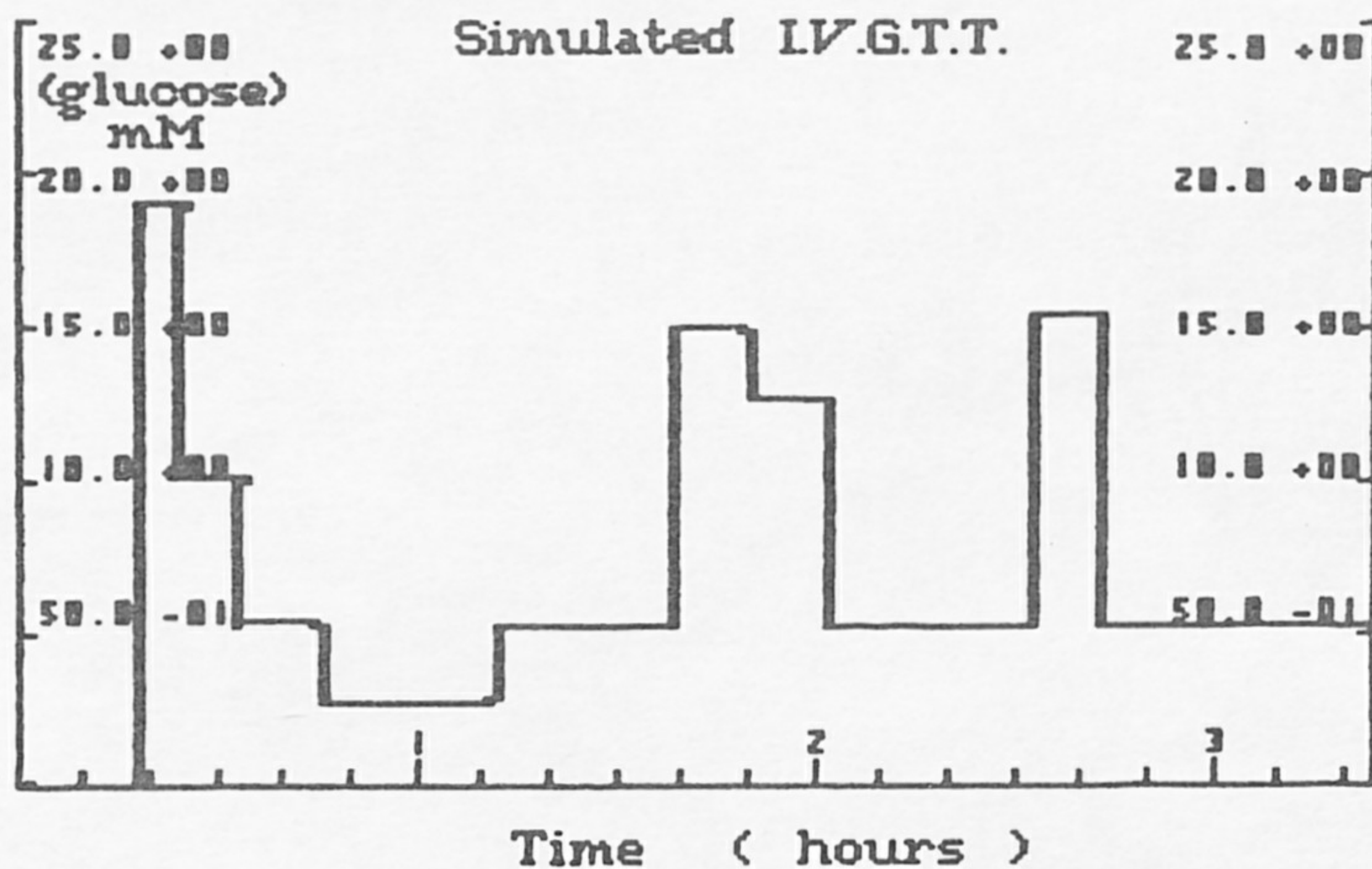

Fig. 35.7 Hard copy of high resolution screen during assays of a flow-through electrode to simulated intravenous glucose tolerance tests: (top) variations of glucose level simulating IVGTT under different physiological conditions and (bottom) response of the glucose electrode to this concentration profile. GOD cellulose acetate membrane, $37.0 \pm 0.1^\circ\text{C}$, 0.2 to 19 mM glucose concentration profiles performed by addition of either glucose standard or buffer in acetate buffer placed in a closed loop.

in progress to prepare glucose sensors with similar linearity for highly concentrations of glucose but with larger response amplitudes and shorter response times.

35.5 Conclusions

Good characterization of any sensor and especially biosensors such as enzyme-based electrodes implies a large number of linear and repeatable assays, and the treatment of corresponding steady-state or dynamic responses. As a matter of fact, several thousands of such glucose assays have been performed using the same reconstituted collagen membrane for periods of up to four successive months of operation at 30°C and storage at room temperature (Thévenot *et al.* 1982). Such numerous assays would not have been possible without using automation of both the addition of 10 to 50 glucose standards in the reaction vessel and the detection of steady-state responses and their statistical treatment. This chapter presents two different set-ups for such automation: on the one hand, a simple programmable calculator carries out all these operations with a precision often better than a manual experiment, using a chart recorder; on the other hand, it may be of considerable interest to store the whole response curve and to analyse carefully its shape: such a situation is encountered when the substrate follows the non step-like increase of concentration common in industrial or clinical processes. This second set-up, which exploits microcomputers and commercially available interface cards, enables both acquisition and real-time display on a high resolution screen, and various types of data treatments. It is currently used in our laboratory for comparing the principal analytical parameters of various enzyme membranes and reaction vessels, and also for recording and treatment of *in vivo* assays of flow-through glucose sensors under different physiological conditions of conscious animals (Thévenot *et al.* 1985).

Acknowledgements

The support of the Caisse Nationale de l'Assurance Maladie des Travailleurs salariés (France) Grant CNAMTS-INSERM 85.3.54.8.E, of National Institute of Health (US) Grant AM30718, and of Association des Jeunes Diabétiques (Paris, France) is gratefully acknowledged.

References

- Dubois, C. (1984). Electrochemical characterization of membranes used in enzyme electrodes. Research report, Université Paris-Val de Marne, 42 pp.
- De Laforcade, V. (1980). Study of a table set-up for glucose determination with an enzyme-based electrode. Research report, Université Paris-Val de Marne, 106 pp.
- Jaenchen, M., Scheller, F., Pfeiffer, D., Pittelkow, R., Wiegand, P. and Nentwig, J. (1982). GKM 01: a new measuring instrument for glucose using enzyme electrodes. *Z. Med. Laboratoriumsdiagn.* **23**(1), 39-42.

- Kawana, S., Nihira, K., Miyashiro, H. and Takada, Y. (1980). Analyzer using immobilized enzymes. Jpn. Kokai Tokyo Koho JP 55/10523 (80/10523), 25 Jan 1980, 3 p. Appl. or Pr. 78/83098, 10 Jul 1978.
- Kernevez, J. P., Konate, L. and Romette, J. L. (1983). Determination of substrate concentrations by a computerised enzyme electrode. *Biotechnology and Bioengineering* **25**, 845-55.
- Kyoto Daiichi Kagaku, K. K. (1982). Apparatus for automatic and continuous analysis of blood. Patent Belg. BE 892964 A1, 16 g 1982, 50 p. Appl. 2079, 26 Apr 1982; JP Appl. 81/63160, 24 Apr 1981; JP Appl. 81/150924, 9 Oct 1981.
- Mitsubishi Rayon Co. Ltd. (1983). Automatic electrode apparatus for determination of biological components. Jpn. Kokai Tokyo Koho JP 58/135950 A2 (83/135950), 12 g 1983, 4 p., Appl. 82/18477, 8 Feb 1982.
- Skogberg, D., Richardson, T. and Blasczyk, T. (1979). Automatic sampling and monitoring of potentiometric electrodes: steady-state response by first and second derivative techniques. *Analytical Chemistry* **51**(12), 2054-7.
- Sternberg, R., Apoteker, A. and Thévenot, D. R. (1980). Trace glucose electrode for clinical, food and environmental determinations. In *Analytical chemistry symposia Series Vol. 2* (ed. W. F. Smith) pp. 461-473. Elsevier, Amsterdam.
- Tallagrand, T. and Thévenot, D. R. (1983a). Experimental and theoretical studies of enzymatic membranes used in enzyme electrodes. Communication to the Electroanalysis International Symposium, Cardiff (Great Britain) abstract no. 82.
- Tallagrand, T. and Thévenot, D. R. (1983b). Enzymatic membranes used in enzyme-based electrodes. Communication to 1st National colloquium of the French Bioelectrochemistry Group, Port-Leucate (France) abstract n. 24, pp. 93-96.
- Tallagrand, T., Grunberg, M. and Thévenot, D. R. (1983). Microcomputers for specific electrodes using immobilised enzyme. Communication to 1st National Colloquium of the French Bioelectrochemistry Group, Port Leucate (France) abstract no. 25, pp. 97-101.
- Thévenot, D. R. (1982). Use of electrochemical methods in the characterization of enzymatic membranes. Communication to the 33rd congress of the International Society of Electrochemistry, Lyon (France), abstract p. 784.
- Sternberg, R. and Coulet, P. (1982). A glucose electrode using high-stability glucose-oxidase collagen membranes. *Diabetes Care* **3**, 203-6.
- Coulet, P. R., Sternberg, R. and Gautheron, D. C. (1978). A highly sensitive glucose electrode using glucose oxidase collagen film. *Bioelectrochemistry and Bioenergetics* **5**, 548-53.
- Sternberg, R., Coulet, P. R., Laurent, J. and Gautheron, D. C. (1979). Enzyme collagen membrane for electrochemical determination of glucose. *Analytical Chemistry* **51**, 96-100.
- Tallagrand, T., Velho, G. and Reach, G. (1985). Enzyme electrodes for use *in vivo*. 30th I.U.P.A.C. Meeting, Manchester, UK.
- Tsuji, N., Nakamura, K., Endoh, K., Hamada, T. and Ishida, K. (1983). Blood sugar analyzing apparatus. US Patent 4407959 A, 4 Oct 1983, 11 p. Appl. 313666, 21 Oct 1981; JP Appl. 80/150756, 29 Oct 1980; JP Appl., 80/172665, 9 Dec 1980; JP Appl. 80/172666, 9 Dec 1980.
- Wieck, H. J., Heider, G. H. and Yacynych, A. M. (1984). Simple approach to micro-computer-controlled electrochemistry. *Anal. Chim. Acta* **166**, 315-19.