



HAL
open science

Walking Gait of a Biped with a Wearable Walking Assist Device

Yannick Aoustin

► **To cite this version:**

Yannick Aoustin. Walking Gait of a Biped with a Wearable Walking Assist Device. International Journal of Humanoid Robotics, 2015, Vol. 12, No. 2 1550018 (20 p.). <10.1142/S0219843615500188>. <hal-01178922>

HAL Id: hal-01178922

<https://hal.science/hal-01178922v1>

Submitted on 21 Jul 2015

HAL is a multi-disciplinary open access archive for the deposit and dissemination of scientific research documents, whether they are published or not. The documents may come from teaching and research institutions in France or abroad, or from public or private research centers.

L'archive ouverte pluridisciplinaire **HAL**, est destinée au dépôt et à la diffusion de documents scientifiques de niveau recherche, publiés ou non, émanant des établissements d'enseignement et de recherche français ou étrangers, des laboratoires publics ou privés.



HAL Authorization

WALKING GAIT OF A BIPED WITH A WEARABLE WALKING ASSIST DEVICE.

YANNICK Aoustin

*L'UNAM, Institut de Recherche en Communications et Cybernétique de Nantes, UMR 6597,
CNRS, École Centrale de Nantes, Université de Nantes,
1, rue de la Noë, BP 92101. 44321 Nantes, France.
(e-mail: Yannick.Aoustin@ircyn.ec-nantes.fr)*

Received 02 November 2014

Revised 27 January 2015

Accepted 19 March 2015

A ballistic walking gait is designed for a planar biped equipped with a wearable walking assist device. The biped is a seven-link planar biped with two legs, two feet, and a trunk. The wearable walking assist device is composed of a bodyweight support, two upper legs, two lower legs, and two shoes. The dynamic model of the biped with its walking assist device, containing two closed kinematic chains, is calculated by virtually cutting each of both loops at one of their point. In the single support phase, the biped with its assist device moves due to the existence of a momentum, produced mechanically, without applying active torques in the inter-link joints. The biped and this assist device are controlled with impulsive torques at the instantaneous double support to obtain a cyclic gait. The impulsive torques are applied in the six inter-link joints of the biped and in several inter-link joints of the wearable walking assist device. The following distributions of impulsive torques, in the knees or the ankles, hips and knees, hips and ankles, or knees and ankles and the fully assist device, are compared with the case of no assistance for the biped. Each time, an infinity of solutions exists to find the impulsive torques. An energy cost functional defined from these impulsive torques is minimized to determine a unique solution. Numerical results show that for a given time period and a given length of the walking gait step, the assistance of the hips is a good compromise to help the biped.

Keywords: Walking gait; Kinematic closure loop; Impulsive torque; Optimization; Instantaneous double support; Walking assist device.

1. Introduction

Research in powered human exoskeleton devices began in the late 1960s for military purposes.¹ Currently the assistive robotics is still an active research field because there are many needs for industrial applications to avoid the musculoskeletal disorders as well as for patients and elderly people with mobility impairments.² As a consequence during the last few years, several biomechanical studies and realizations of walking assist devices are carried out. To name a few, Priebe and Kram³ compare the metabolic power consumption for ten young, healthy adults walking without assist and using two-wheeled, four-wheeled and four-footed walker devices.

At the same speed, 0.30 m/s , using a four-footed walker devices is energetically more expensive than walking unassisted, with a four-wheeled walker and a two-wheeled walker respectively. Zhang and Hashimoto⁴ propose a trajectory generation method for a robotic suit to assist walking by supporting the hip joints. This robotic suit consists of two links and two actuators. Krut *et al*⁵ propose a lower limb exoskeleton, MoonWalker, able to sustain part of a user's bodyweight based on gravity compensation. Through a passive force balancer MoonWalker requires low energy to work on flat terrains. A motor can provide also a part of the energy to climb stairs or slopes. Ikeuchi *et al*⁶ propose a wearable walking assist device. This device, with a seat, two upper legs, two lower legs, and two shoes is disposed along the inner side of the user's legs. It can always maintain the assist force vector in the direction from the center of pressure of floor reaction to the center of mass of the user's body by using two actuators. Renquan *et al*⁷ describes a novel development of a lower limber exoskeleton for physical assistance and rehabilitation. The experiments illustrate the ability of the exoskeleton to enable the leg shank to track trajectories with different periods and ranges of motion. Alonso *et al*⁸ quantify the contributions of muscles and active orthosis to the net joint torques, so as to assist the design of active orthoses for spinal cord injuries. The orthosis is included as a set of external torques added to the ankles, knees, and hips to obtain net joint patterns similar to those of normal unassisted walking. Kazerooni proposes a description of the Berkeley exoskeleton BLEEX in,⁹ which is devoted to military applications. Rosen and Perry,¹⁰ through a profound understanding of the kinematics and dynamics of the human arm, designe a seven degree of freedom exoskeleton arm. Caldwell and *et al*,¹¹ with the use of a new range of pneumatic muscle actuators, develop an ultra low-mass, full-body exoskeleton system. With the objective to increase the load-carrying capacity and to preserve autonomy, Walsh *et al*¹² propose a very interesting quasi-passive leg exoskeleton.

Despite this great activity the design of a wearable walking assist device with an optimal structure from point of view of small moving mass and low energetic dispense is still an open problem. The human walking without or with an assist device is a very complex coordination of muscle forces, actuator torques, joint motions, and closed kinematic chains. The place and the number of actuators of a wearable walking assist device and its autonomy remain a difficult challenge. This paper aims to respond to the question of the best distribution of the impulsive torques and their number for a given wearable walking device to assist a seven-link planar biped. The study of ballistic walking of biped with assist device may provide insight in human walking with an assist device. Human motions comprise alternating periods of muscle activity and relaxation, and the double support phase is relatively short with respect to the single support phase. Then it is logical to consider the problem of purely ballistic swing phases and double support phases with impulsive interlink torques. Similar statement of the problem is proposed by Formal'skii,^{13,14,15} Mochon and McMahan,¹⁶ McGeer,¹⁷ Asano¹⁸ and Aoustin and Formalskii.¹⁹

The aim of this paper is to determine an optimal distribution of the actuators of a given assist device with respect to the locomotor system of an anthropomorphic biped. This biped has a torso, two identical legs with feet. The walking assist device is composed of a seat, two upper legs, two lower legs, and two shoes. Therefore a boundary value problem is solved for this biped with its walking assist device to find a walking ballistic gait, which is cyclic, with instantaneous double supports and impulsive torques, and to study the optimal distribution and the minimum number of the torques provided by the walking assist device. The impulsive control torques, which are applied in the inter-link joints between the neighboring single support phases are described by delta-functions of Dirac. Of course this approach cannot be considered as a realistic control method but as a design tool, because it is not possible to realize these impulsive control torques. However when the number of the degrees of freedom of a mechanical system is equal to the number of its actuators, the ballistic trajectory can be modified around the impact with the ground in order to have a feasible motion with finite torques; see.²⁰

The rest of the paper is organized as follows. Section 2 is devoted to the modeling of the biped with its walking assist device. Problem definition of the ballistic walking is given in Sect. 3. In the same Sect. 3, the algebraic equations for the instantaneous double support are designed. An energy cost functionals for the impulsive control is presented in Sect. 4. The results of simulation are shown in Sect. 5. Our conclusion and perspectives are offered in Sect. 6.

2. Modeling of the biped with its wearable walking assist advice

2.1. *Physical parameters of the biped*

For the seven-link biped, depicted in fine line Fig. 1 (a), we use the physical parameters from.¹⁴ The wearable walking device assist, in thick line Fig. 1 (a), is composed of a seat, attached to the base of the trunk, two upper legs, two lower legs, and two shoes. Figure 2(a), the distances are $S_s = 0.324 m$ between the knee joint and the center of mass for the shin, $S_t = 0.18 m$ between the hip joint and the center of mass for the thigh, $S_T = 0.386 m$ between the hip joint and the center of mass for the trunk. The distance between the center of mass of the upper leg and the joint with the seat is: $S_1 = 0.1127 m$, the distance between the center of mass of the lower leg and the joint with the upper leg is: $S_2 = 0.169 m$, the distance between the center of mass of the seat and the joint with the upper leg is: $S_3 = 0.05 m$, the distance between the base of the seat and the hip joint is: $l_3 = 0.1 m$. The head mass is included in the trunk that its length is l_T . Table 1 gathers the masses, the lengths and the inertia moments for each link of the biped and the walking assist device.

4 *Y. Aoustin*

Fig. 1. The kinematic model with its degrees of freedom and link frames of the biped and its walking assist device.

2.2. Modeling including the seven-link biped and the walking assist device, in single support phase

Several methods have been proposed in the literature to compute the dynamic models of robots containing closed kinematic chains; see²¹ for a survey. The dynamic model developed is based on firstly computing the dynamic model of an equivalent tree structure. This equivalent tree structure is constructed by virtually cutting each of both loops at one of their point. Let us choose the middle point of the upper link of each leg link, which composes the walking assist device. The computation of dynamic model of the biped equipped with the walking assist device is calculated using the equivalent tree structure in which the generalized variables satisfy the constraints of both loops and after adding external forces and moments between the cut links as external forces and moments. The closed-loop geometric constraints for each loop, their first and second time derivatives are detailed in Appendix 6. Through the virtual work principle, these constraint equations can be expressed in the dynamic model by adding terms $\mathbf{J}_i^T \lambda_i$, $i = 1, 2$. Here \mathbf{J}_i is the 3×15 Jacobian matrix such as equations (22), (23), (24), and (25) can be rewritten under the compact forms:

$$\begin{bmatrix} \mathbf{J}_1 \\ \mathbf{J}_2 \end{bmatrix} \dot{\mathbf{x}} = \mathbf{0}_{6 \times 1} \quad (1)$$

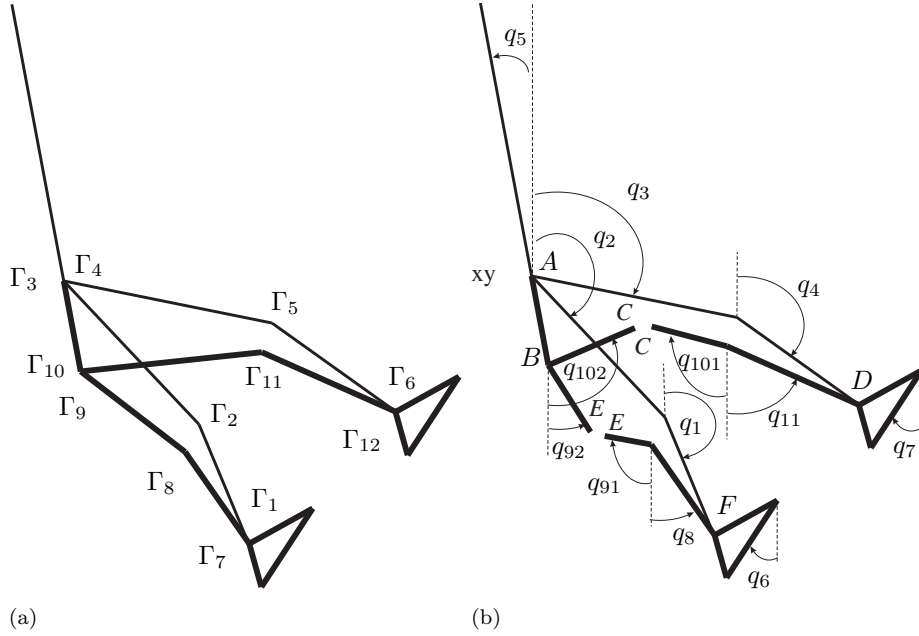
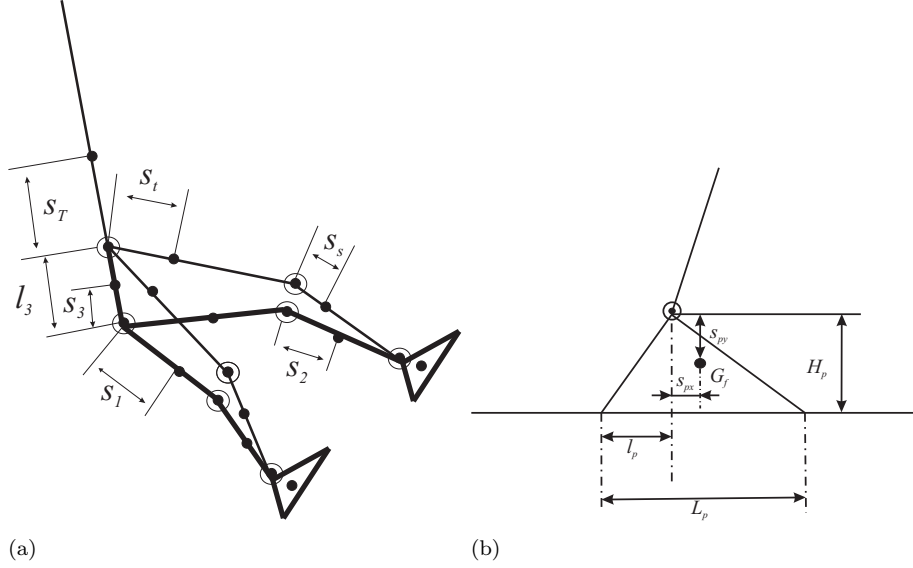

Fig. 2. Position of the center of mass of each link of the planar biped and its walking assist device and detail parameters of both, foot and shoe.

and

$$\begin{bmatrix} \mathbf{J}_1 \\ \mathbf{J}_2 \end{bmatrix} \ddot{\mathbf{x}} + \begin{bmatrix} \dot{\mathbf{J}}_1 \\ \dot{\mathbf{J}}_2 \end{bmatrix} \dot{\mathbf{x}} = \mathbf{0}_{6 \times 1}. \quad (2)$$

and vector $\boldsymbol{\lambda}_i = \mathbf{f}_{c_i} = [f_{x_i}, f_{y_i}, m_{z_i}]^\top$ defines the wrench, which is composed of the external forces and moments for each loop closure (see Figure 1(a)). The generalized vector \mathbf{x} is such as

$$\mathbf{x} = [q_1, q_2, q_3, q_4, q_5, q_6, q_7, q_8, q_{91}, q_{92}, q_{101}, q_{102}, q_{11}, x, y]^\top.$$

Here x and y are the hip coordinates; see Fig. 1 (b). Angles q_1, q_2, q_3 , and q_4 define the absolute orientation of the shin and thigh for both legs. The absolute orientation of the trunk and seat is defined through q_5 . Angles q_6 and q_7 describe the absolute orientation of feet. The absolute orientations of the two branches of the upper legs and the lower legs are respectively described with $q_8, q_{91}, q_{92}, q_{101}, q_{102}$, and q_{11} . The biped modeling with its walking assist device is:

$$\mathbf{A}(\mathbf{x})\ddot{\mathbf{x}} + \mathbf{h}(\mathbf{x}, \dot{\mathbf{x}}) = [\mathbf{D} \mathbf{J}_1^\top \mathbf{J}_2^\top] \begin{bmatrix} \boldsymbol{\Gamma} \\ \mathbf{f}_c \end{bmatrix} + \mathbf{J}_{r_1}^\top \begin{bmatrix} \mathbf{r}_1 \\ \mathbf{m}_{1z} \end{bmatrix} + \mathbf{J}_{r_2}^\top \begin{bmatrix} \mathbf{r}_2 \\ \mathbf{m}_{2z} \end{bmatrix}, \quad (3)$$

with the constraint equations,

$$\begin{aligned} \mathbf{J}_{r_i} \ddot{\mathbf{x}} + \dot{\mathbf{J}}_{r_i} \dot{\mathbf{x}} &= \mathbf{0} \text{ for } i = 1 \text{ to } 2, \\ \begin{bmatrix} \mathbf{J}_1 \\ \mathbf{J}_2 \end{bmatrix} \ddot{\mathbf{x}} + \begin{bmatrix} \dot{\mathbf{J}}_1 \\ \dot{\mathbf{J}}_2 \end{bmatrix} \dot{\mathbf{x}} &= \mathbf{0}. \end{aligned} \quad (4)$$

	Mass (<i>kg</i>)	Length (<i>m</i>)	Inertia (<i>kg·m²</i>)	center of mass (<i>m</i>)
Foot and shoe	$m_f = 0.678$	$L_p = 0.207$ $l_p = 0.072$ $H_p = 0.064$	$I^f = 0.012$	$s_{px} = 0.0135$ $s_{py} = 0.0321$
Shin	$m_s = 4.6$	$l_s = 0.497$	$I^s = 0.0521$	$s_s = 0.324$
Thigh	$m_t = 8.6$	$l_t = 0.41$	$I^t = 0.7414$	$s_t = 0.18$
Trunk	$m_T = 17.5$	$l_T = 0.625$	$I^T = 11.3$	$s_T = 0.386$
Seat	$m_3 = 2.0$	$l_3 = 0.1$	$I^T = 0.3$	$s_3 = 0.05$
Upper leg	$m_1 = 3.0$	$l_1 = 0.392$	$I^1 = 0.04$	$s_1 = 0.1127$
Lower leg	$m_2 = 2.0$	$l_2 = 0.3645$	$I^2 = 0.02$	$s_2 = 0.169$

Table 1. Physical parameters of the seven-link biped and of the walking assist device.

Γ is the 12×1 vector of the applied joint torques, $[\mathbf{r}_i \ \mathbf{m}_{i_z}]^\top$, with $i = 1$ to 2 , are the resultant wrenches of the contact efforts with the ground reaction in both feet, and $\mathbf{f}_c = [\mathbf{f}_{c_1}^\top, \mathbf{f}_{c_2}^\top]^\top$. \mathbf{J}_{r_1} and \mathbf{J}_{r_2} are the 3×15 Jacobian matrices for the constraint equations in position and orientation for both feet, respectively. $\mathbf{A}(\mathbf{x})$ is the 15×15 symmetric positive definite inertia matrix, $\mathbf{h}(\mathbf{x}, \dot{\mathbf{x}})$ is the 15×1 vector, which groups the centrifugal, Coriolis effects, and the gravity forces. Because the generalized vector is composed of absolute angle variables instead of joint variables we applied the principle of virtual work to calculate \mathbf{D} ; see.²² Let us detail this calculation. The virtual work δW_i ($i = 1, \dots, 12$) of each torque Γ_i , applied to the corresponding joint variable $\delta\theta_i$, is as follows

$$\begin{aligned}
 \delta W_i &= \delta\theta_i \Gamma_i \\
 &= \mathbf{D}_i^\top \delta \mathbf{x} \Gamma_i
 \end{aligned} \tag{5}$$

Then the matrix of torques is $\mathbf{D} = [\mathbf{D}_1, \dots, \mathbf{D}_i, \dots, \mathbf{D}_{12}]$ with:

$$\mathbf{D}_i = \frac{\partial}{\partial \Gamma_i} \left(\frac{\partial \delta W}{\partial \delta \mathbf{x}} \right). \quad (6)$$

The principle of virtual work can be also used to obtain both matrices $\mathbf{J}_{\mathbf{r}_1}^\top$ and $\mathbf{J}_{\mathbf{r}_2}^\top$.

Considering several distributions of torques for the walking assist device. The number of nonzero torques n_a is such as $6 \leq n_a \leq 12$. In the single support, with a stance foot with a flat contact on the ground the number of degrees of freedom is six and there are $n_a \geq 6$ nonzero torques. With unlimited torque amplitudes, it means that the biped is a over actuated or a fully actuated mechanism during the single support phase. With a limited torque at the ankle of the supporting leg, a rotation of the stance foot is possible and this mechanism becomes under-actuated; see for example.²³

2.3. Modeling including the biped and the walking assist device, in double support phase

During the biped's gait, an impact occurs at the end of a single support phase, when the swing leg tip touches the ground. At the instant of impact, denoted by T , the double support phase is assumed instantaneous. At the instant of the passive inelastic impact, the biped loses energy. Therefore, the velocity vector after the impact will not be the desired one, if the bearing surface is horizontal. Then for the next ballistic step the desired initial velocity vector will not be reached. As a consequence, a complete walking cyclic gait of the biped with its assist device cannot be realized on a horizontal surface without active torques. However, theoretically, around the instantaneous double support it is possible to define impulsive torques in order to ensure the desired velocity jump; see Formalskii,^{14, 15} Hurmuzlu, and Chang.²⁴ In the next Section, it is shown how to calculate these impulsive torques.

3. Ballistic motion and impulsive control: Problem definition

3.1. Single support

In the single support phase, the stance leg foot (let it be foot 1) is assumed to have a flat foot contact on the ground, no sliding motion, no take-off, and no rotation.

Let $\mathbf{x}(0)$ be the initial configuration of the biped with its wearable assist device at time $t = 0$; see Fig 3. We assume, the front and hind legs are the stance and swing legs respectively. The final configuration of the biped in the single support phase at the given time $t = T$ is noted $\mathbf{x}(T)$. Let this given configuration be similar to the initial configuration with the swapped legs. Let L be the length of the step corresponding to a single support. We consider a ballistic motion during the single support phase with $\mathbf{\Gamma} = \mathbf{0}_{n_a \times 1}$. As a consequence, the matrix equations (3) for the ballistic motion become:

$$\mathbf{A}(\mathbf{x})\ddot{\mathbf{x}} + \mathbf{h}(\mathbf{x}, \dot{\mathbf{x}}) = [\mathbf{D} \mathbf{J}_1^\top \mathbf{J}_2^\top] \begin{bmatrix} \mathbf{0}_{n_a \times 1} \\ \mathbf{f}_c \end{bmatrix} + \mathbf{J}_{\mathbf{r}_1}^\top \begin{bmatrix} \mathbf{r}_1 \\ \mathbf{m}_{1z} \end{bmatrix}, \quad (7)$$

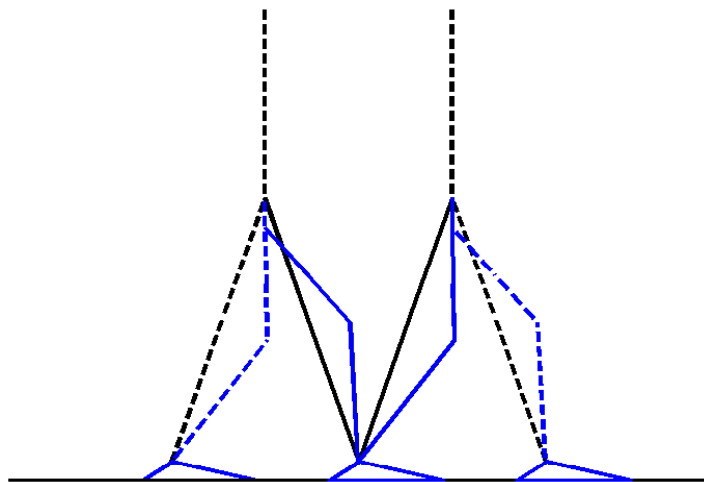

Fig. 3. Starting from the left side to the right side, initial and final configurations of the biped (side view), of the wearable assist device (blue line), assisted biped (black line). The stance leg with its assistance is drawn in solid line

with the constraint equations,

$$\begin{aligned} \mathbf{J}_{r_1} \ddot{\mathbf{x}} + \dot{\mathbf{J}}_{r_1} \dot{\mathbf{x}} &= \mathbf{0} \\ \begin{bmatrix} \mathbf{J}_1 \\ \mathbf{J}_2 \end{bmatrix} \ddot{\mathbf{x}} + \begin{bmatrix} \dot{\mathbf{J}}_1 \\ \dot{\mathbf{J}}_2 \end{bmatrix} \dot{\mathbf{x}} &= \mathbf{0}. \end{aligned} \quad (8)$$

To design the ballistic walking, it is necessary to find the solution $\mathbf{x}(t)$ of the matrix equations (7) and (8) with the given boundary conditions $\mathbf{x}(0)$ and $\mathbf{x}(T)$. We have to find the initial velocity vector $\dot{\mathbf{x}}(0)$ such that solution $\mathbf{x}(t)$, starting from the given initial configuration $\mathbf{x}(0)$ with the velocity vector $\dot{\mathbf{x}}(0)$, reaches the given final configuration $\mathbf{x}(T)$ at the given time T . The given boundary conditions $\mathbf{x}(0)$ and $\mathbf{x}(T)$ are chosen such that the positions of the locomotor system with its assist device and the trunk of the biped are similar to human configurations. This boundary value problem can be numerically solved using a Newton method with unknown vector $\dot{\mathbf{x}}(0)$. The motion of the biped is admissible, if the vertical component of the ground reaction in the stance leg is positive (directed upwards), and if the swing leg moves over the ground for $0 < t < T$. We check these constraints after solving the boundary value problem - *a posteriori*. The wrench of the ground reaction is calculated from (7) and (8).

After solving the boundary value problem, the vector of the initial velocities $\dot{\mathbf{x}}(0)$ is known. We denote it by $\dot{\mathbf{x}}^a$. If the initial conditions $\mathbf{x}(0)$, $\dot{\mathbf{x}}^a$ are known, then by integration of the system (7) – (8) the vector of the terminal velocities $\dot{\mathbf{x}}(T)$ can also be found. We denote it by $\dot{\mathbf{x}}^b$. This problem is numerically solved with the *fsolve* function based on the Newton-Raphson Algorithm of Matlab [®].

3.2. Structure of double support phase

Similarly to^{25,15} or¹⁹ let us consider the current ballistic motion on the stance leg 1 and the following ballistic motion on the stance leg 2. Let the final velocity vector $\dot{\mathbf{x}}^b$ of the current ballistic swing motion and the initial velocity vector $\dot{\mathbf{x}}^a$ of the next ballistic swing motion be known from the solution of the boundary value problem^a and the numerical integration of the matrix equations (7) – (8). Let us apply the impulsive torques in the joints with the intensity vectors \mathbf{I}^- and \mathbf{I}^+ , respectively just before and just after the passive impact with the ground to create a complete cyclic motion. Then we divide the instantaneous double support phase into *three* sub-phases and detail these sub-phases, which are presented in Figure 4.

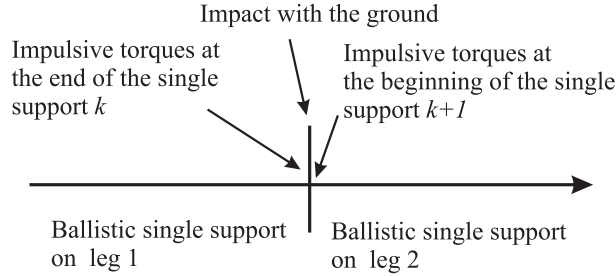

Fig. 4. Decomposition of the impulsive impact; see^{25,15} or¹⁹

- The swing leg 2 touches the ground at the end of the ballistic single support motion on leg 1, and an impact occurs. Just before contact with the ground, in the *first* sub-phase at time T^- , impulsive torques $\mathbf{\Gamma}^-(t) = \mathbf{I}^- \delta(t - T^-)$ are applied at the n_a inter-link joints. Here $\delta(t - T^-)$ is the Dirac delta-function. At the same instant T^- , the impulsive ground reaction $\mathbf{r}_1^- = \mathbf{I}_{\mathbf{r}_1}^- \delta(t - T^-)$ is applied in the hind leg tip. Here $\mathbf{I}_{\mathbf{r}_1}^- (I_{\mathbf{r}_{1x}}^-, I_{\mathbf{r}_{1y}}^-, I_{\mathbf{m}_{1z}}^-)$ is the vector of the magnitudes of the impulsive reaction in leg 1. Furthermore $\mathbf{f}_{c_i}^- = \mathbf{I}_{\mathbf{f}_{c_i}}^- \delta(t - T^-)$, with $I_{\mathbf{f}_{c_i}}^- = [I_{f_{x_i}}^-, I_{f_{y_i}}^-, I_{m_{z_i}}^-]^\top$ defines the impulsive wrench for each loop closure. Under the impulsive torques, the velocity vector $\dot{\mathbf{x}}$ of the biped changes instantaneously from the value $\dot{\mathbf{x}}^b$ to some value $\dot{\mathbf{x}}^-$. The

^aTherefore there is a permutation operation between $\dot{\mathbf{x}}^a$ and the solution of the boundary value problem to take into account the exchange of the role of both legs.

corresponding equations for the velocity jump can be obtained through the integration of equations of motion (3) for the infinitesimal time from T^- to T . The torques provided by the Coriolis and gravity forces have finite values. Thus, they do not influence the velocity jump:

$$\mathbf{A}[\mathbf{x}(T)](\dot{\mathbf{x}}^- - \dot{\mathbf{x}}^b) = [\mathbf{D} \mathbf{J}_1^\top \mathbf{J}_2^\top] \begin{bmatrix} \mathbf{I}^- \\ \mathbf{I}_f^- \end{bmatrix} + \mathbf{J}_{\mathbf{r}_1}^\top \mathbf{I}_{\mathbf{r}_1}^-. \quad (9)$$

The associated constraint equations are:

$$\begin{aligned} \mathbf{J}_{\mathbf{r}_1} \dot{\mathbf{x}}^- &= \mathbf{0}_{3 \times 1} \\ \begin{bmatrix} \mathbf{J}_1 \\ \mathbf{J}_2 \end{bmatrix} \dot{\mathbf{x}}^- &= \mathbf{0}_{6 \times 1}. \end{aligned} \quad (10)$$

Here $\mathbf{x}(T)$ denotes the configuration of the biped at the instant of impulsive actions (at the double support). This configuration does not change at the instants of the first, second, and third sub-phases. The velocity of the hind leg foot with flat contact on the ground remains zero after the first sub-phase.

Then the biped has the velocity vector $\dot{\mathbf{x}}^-$ just before the next (second) sub-phase, which is a passive impact with the ground.

- The *second* sub-phase is assumed to be a passive impact, *i.e.* without torques applied in the inter-link joints, absolutely inelastic, and such that the legs do not slip. Given these conditions, the ground reactions at the instant of an impact can be considered as impulsive forces and defined by the delta-functions $\mathbf{r}_2 = \mathbf{I}_{\mathbf{r}_2} \delta(t - T)$. Here $\mathbf{I}_{\mathbf{r}_2} (I_{\mathbf{r}_{2x}}, I_{\mathbf{r}_{2y}}, I_{\mathbf{m}_{2z}})$ is the vector of the magnitudes of the impulsive reaction in leg 2; see.¹⁴ The corresponding equations for the velocity jump can be obtained through the integration of the matrix equation (3) for the infinitesimal time. The velocity of the stance leg tip 1 before an impact is equal to zero.

Generally speaking, two results are possible after the passive impact, if we assume that there is no slipping of the leg tips. The stance leg lifts off the ground or both legs remain on the ground. Numerical investigations were carried out after impact to check the ground reaction in the stance leg tip and the linear velocity of this leg tip. We considered numerically both cases. From these numerical investigations we concluded that the first case (stance leg lifts off the ground) takes place in all our variants. In this case, the vertical component of the velocity of the taking-off leg tip just after the impact is directed upwards. Also there is no interaction (no friction, no sticking) between the taking-off leg tip and the ground. The ground reaction in this taking-off leg tip is null. If we assume that after the impact the stance leg remains on the ground (second case), the vertical component of the ground reaction in this leg must be null or directed upwards. But our calculations show that this component is directed downwards. It means

that both legs cannot remain on the ground. For the first case, the impact equations can be written in the following matrix form:

$$\mathbf{A} (\dot{\mathbf{x}}^+ - \dot{\mathbf{x}}^-) = [\mathbf{D} \mathbf{J}_1^\top \mathbf{J}_2^\top] \begin{bmatrix} \mathbf{0}_{n_a \times 1} \\ \mathbf{I}_{\mathbf{f}_e} \end{bmatrix} + \mathbf{J}_{r_2}^\top \mathbf{I}_{r_2} \quad (11)$$

Here $\dot{\mathbf{x}}^+$ is the velocity vector just after an inelastic passive impact. To take into account of the closure loop, we have to complete (11) with:

$$\begin{bmatrix} \mathbf{J}_1 \\ \mathbf{J}_2 \end{bmatrix} \dot{\mathbf{x}}^+ = \mathbf{0}_{6 \times 1}. \quad (12)$$

The swing leg 2 after the impact becomes a stance leg. Therefore, its tip velocity becomes zero after the impact,

$$\mathbf{J}_{r_2} \dot{\mathbf{x}}^+ = \mathbf{0}_{3 \times 1} \quad (13)$$

- The swing leg 1 takes off the ground at the *second* sub-phase, which is the passive impact. Then, the next ballistic single support motion on leg 2 starts. However, before the next ballistic swing motion (just after the take off), in the *third* sub-phase at time T^+ , impulsive torques $\mathbf{\Gamma}^+(t) = \mathbf{I}^+ \delta(t - T^+)$ are applied in the inter-link joints to change the velocity of the biped instantaneously from the velocity vector just after passive impact $\dot{\mathbf{X}}^+$ to the known velocity vector $\dot{\mathbf{x}}^a$. Integrating the differential equations (3) we come to the following matrix relation:

$$\mathbf{A} (\dot{\mathbf{x}}^a - \dot{\mathbf{x}}^+) = [\mathbf{D} \mathbf{J}_1^\top \mathbf{J}_2^\top] \begin{bmatrix} \mathbf{I}^+ \\ \mathbf{I}_{\mathbf{f}_e}^+ \end{bmatrix} + \mathbf{J}_{r_2}^\top \mathbf{I}_{r_2}^+ \quad (14)$$

System (9)-(14) is composed of 63 scalar equations to find $69 + n_a$ unknown variables, which are the components of the vectors: $\dot{\mathbf{x}}^-$ (15×1), \mathbf{I}^- ($n_a \times 1$), $\mathbf{I}_{\mathbf{f}_e}^-$ (6×1), $\mathbf{I}_{r_1}^-$ (3×1) (for the *first* sub-phase), $\dot{\mathbf{x}}^+$ (15×1), $\mathbf{I}_{\mathbf{f}_e}$ (6×1), \mathbf{I}_{r_2} (3×1) (for the *second* sub-phase), \mathbf{I}^+ ($n_a \times 1$), $\mathbf{I}_{\mathbf{f}_e}^+$ (6×1), and $\mathbf{I}_{r_2}^+$ (3×1) (for the *third* sub-phase). Then the problem of impulsive control has an infinite number of solutions. But if the number of equations is less than the number of unknown variables, it is possible to extract a unique solution minimizing some cost functional. The components of the above-mentioned vectors are the subjects of the minimization. Among this set of components, $(69 + n_a) - 63 = 6 + n_a$ can be defined as parameters to minimize a cost functional.

4. Criteria

The choice of a cost functional is complex. We do not know even if a cost functional is optimized during a human walking, equipped or not with an assist device. In this section, an energy Criterion, which was proposed by Formal'skii,¹³ is presented for a comparison for all the studied cases.

This criterion is based on the principle that the actuators of the biped with its assist device are not regenerative (energy cannot be restored in the drives). Then the motion energy cost functional is defined as in^{26, 14, 20}:

12 *Y. Aoustin*

- for the biped

$$\mathcal{W}_1^b = \sum_{i=1}^6 \left[\int_{T^-}^T |\Gamma_i^-(t) \dot{\theta}_i(t)| dt + \int_T^{T^+} |\Gamma_i^+(t) \dot{\theta}_i(t)| dt \right] \quad (15)$$

- for the assist device

$$\mathcal{W}_1^{ad} = \sum_{i=7}^{12} \left[\int_{T^-}^T |\Gamma_i^-(t) \dot{\theta}_i(t)| dt + \int_T^{T^+} |\Gamma_i^+(t) \dot{\theta}_i(t)| dt \right] \quad (16)$$

where the joint variables θ_i for $i = 1, \dots, 12$ are such as:

$$\begin{aligned} \theta_1 &= q_1 - q_6, & \theta_2 &= q_2 - q_1, & \theta_3 &= q_5 - q_2, \\ \theta_4 &= q_3 - q_5, & \theta_5 &= q_4 - q_3, & \theta_6 &= q_7 - q_4, \\ \theta_7 &= q_8 - q_6, & \theta_8 &= q_{91} - q_8, & \theta_9 &= q_5 - q_{92}, \\ \theta_{10} &= q_3 - q_5, & \theta_{11} &= q_4 - q_3, & \theta_{12} &= q_7 - q_4. \end{aligned}$$

The calculation of the integrals in the expressions (15) and (16) leads¹⁴ to the following formulas:

$$\mathcal{W}^b = \sum_{i=1}^6 (W_i^- + W_i^+), \quad (17)$$

$$\mathcal{W}^{ad} = \sum_{i=7}^{12} (W_i^- + W_i^+). \quad (18)$$

with

$$\begin{aligned} W_i^- &= \left| I_i^- \frac{\dot{\theta}_i(T^-) + \dot{\theta}_i(T)}{2} \right| \quad \text{if } \dot{\theta}_i(T^-) \dot{\theta}_i(T) \geq 0 \\ W_i^- &= \left| I_i^- \frac{\dot{\theta}_i^2(T^-) + \dot{\theta}_i^2(T)}{2 [\dot{\theta}_i(T^-) - \dot{\theta}_i(T)]} \right| \quad \text{if } \dot{\theta}_i(T^-) \dot{\theta}_i(T) < 0 \\ W_i^+ &= \left| I_i^+ \frac{\dot{\theta}_i(T) + \dot{\theta}_i(T^+)}{2} \right| \quad \text{if } \dot{\theta}_i(T) \dot{\theta}_i(T^+) \geq 0 \\ W_i^+ &= \left| I_i^+ \frac{\dot{\theta}_i^2(T) + \dot{\theta}_i^2(T^+)}{2 [\dot{\theta}_i(T) - \dot{\theta}_i(T^+)]} \right| \quad \text{if } \dot{\theta}_i(T) \dot{\theta}_i(T^+) < 0 \end{aligned}$$

In simulation, with given length L and time period T of the step, we choose a unique solution of the system (9) - (14) by minimizing this criterion (17). We take into account the following constraints: $I_{r_{1x}}^- > 0$, $I_{r_{2x}} > 0$, and $I_{r_{2x}}^+ > 0$. Furthermore, we ensure that the linear vector of the swing leg tip just before the passive impact

is directed to the ground and just after the passive impact is directed to the top. Therefore, our minimization problem is the problem of parametric minimization with constraints. We used the *SQP* method (Sequential Quadratic Programming); see²⁷ and²⁸ with the *fmincon* function of Matlab (®) to solve this optimization problem numerically.

We consider the quantity (17) corresponding to this solution as the energy cost functional for the biped walking with the given data L and T for several actuation modes of assistance. We will details these modes of assistance in the next section.

5. Simulation

5.1. Ballistic motion

The simulation results about the designed ballistic motion is presented in this subsection to see the evolutions of the angular variables, the zero moment point (*ZMP*) and the external forces and moments for each loop closure.

The ballistic motion is defined with the following parameters $L = 0.45$ m and $T = 0.5$ s. Figures 5 and 6 describe the joint variables of the biped. The amplitude of oscillation for θ_2 is very small, less than 0.5° . We can consider the stance leg as a straight leg. It is possible to observe a symmetry with the joint variables θ_1 , θ_3 , and θ_4 . In first approximation they can be assimilated as odd functions with respect to $T/2$. Variable θ_5 shows a slight flexion of the swing leg. Figures 7 and

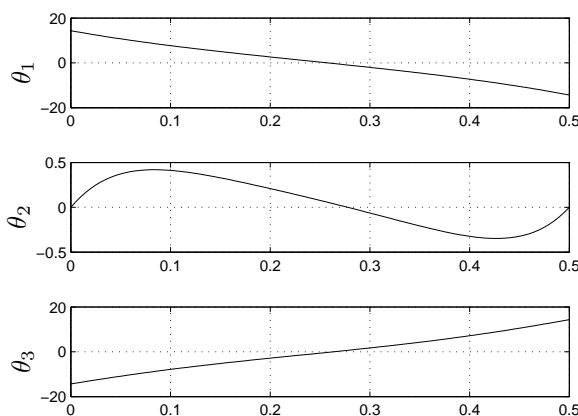

Fig. 5. Joints variables θ_1 , θ_2 , and θ_3 ($^\circ$) as a function of time (s), respectively of the ankle, the knee, and the hip for the stance leg of the biped.

8 present the joint variables of the walking assist device. Variables θ_9 and θ_{10} can

14 *Y. Aoustin*

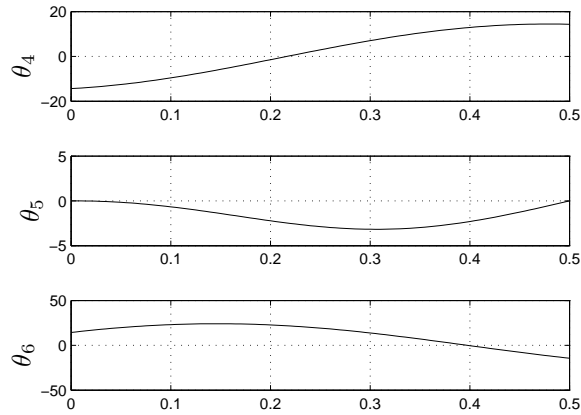

Fig. 6. Joints variables θ_4 , θ_5 , and θ_6 as a function of time (s), respectively of the ankle, the knee, and the hip for the swing leg of the biped.

be also assimilated as odd functions with respect to $T/2$. Variables θ_8 and θ_{11} show that the amplitude of the flexion between the upper leg and lower leg is relatively small.

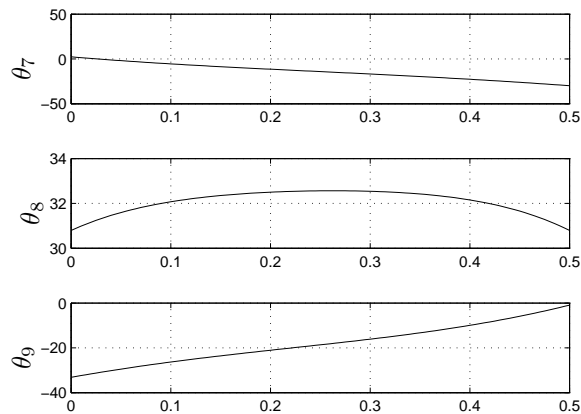

Fig. 7. Joints variables θ_7 , θ_8 , and θ_9 ($^\circ$) as a function of time (s), respectively for the upper leg, the lower leg and the shoe, connected with the stance leg of the biped.

In Fig. 9, the center of pressure (CoP) of the stance foot belongs to the convex

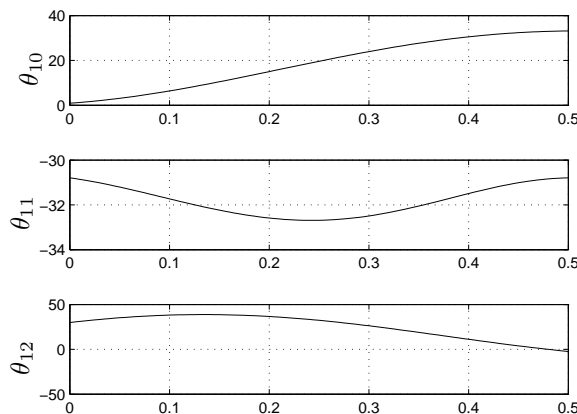

Fig. 8. Joints variables θ_{10} , θ_{11} , and θ_{12} ($^{\circ}$) as a function of time (s), respectively for the upper leg, the lower leg and the shoe, connected with the swing leg of the biped.

hull of the supporting area. In this case this *CoP* is merged with the zero moment point (*ZMP*); see.²⁹ It means that the stance foot stays with flat contact on the ground. Then the walking ballistic motion is valid. This feature has not been prescribed in the statement of the problem previously. However, the displacement magnitude of this *CoP* is less important than for human; see³⁰ and.³¹ This displacement magnitude around zero of the *CoP* can be explained because there is no torque applied in the ankle of the stance leg. For the human walking gait in single support, a rotation of the foot is observed with a partial contact of the sole with the ground, located between the heel and the toe. In Fig. 10, for the biped and the assist device, during the walking gait, the interaction between the biped and the assist device is such that the external forces and moments for each closure are realistic to preserve the mechanical structure.

5.2. Instantaneous double support

For the instantaneous double support, different distributions for the impulsive torques have been compared. The impulsive torques are applied in hips, knees, or ankles only, in both hips and knees, knees and ankles, or hips and ankles only. The case, where the walking assist device is fully actuated, is also considered. In case of the industrial applications, to compensate the gravity effects, it is important to minimize the human's efforts with respect to the assist device. For stroke patients robot-assisted therapy could be useful in first time to assist their motion intention. Following the progress of the rehabilitation, the user's motion could be more active. In this case it is importante to minimize the efforts of human and of the assistive device. Then results are primarily devoted to the minimization of the criterion (17)

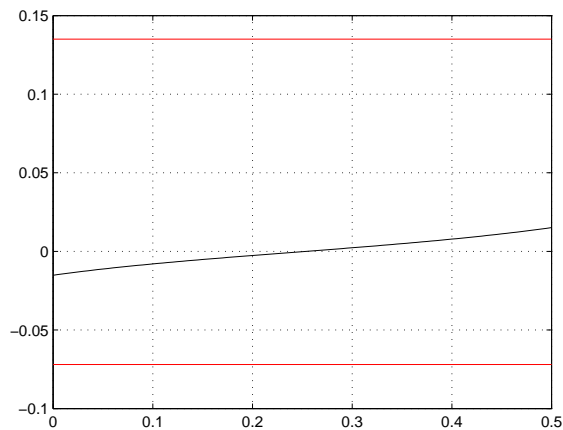

Fig. 9. Profile of the Zero moment point, ZMP , in black line, for the stance flat foot. The red line represents the heel and toe.

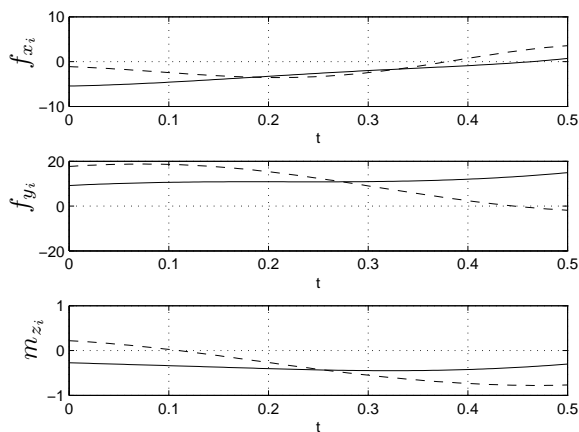

Fig. 10. Profile of the wrench for each loop closure as function of time (s), for the stance leg 1 (dashed line) and the swing leg 2 (solid line). The forces are in (N) and the moment in (N.m)

and secondly to the minimization of global energy criterion:

$$\mathcal{W} = \mathcal{W}^b + \mathcal{W}^{ad} \quad (19)$$

minimization of (17): From Fig. 11, we observe that for all cases, excepted for the assisted ankles, it is possible to preserve the energy consumption of the

biped. To increase the autonomy of the assist device, which is a critical problem, it is better to assist the hips only. Furthermore, to have actuators to assist the hips only means an assist device lighter.

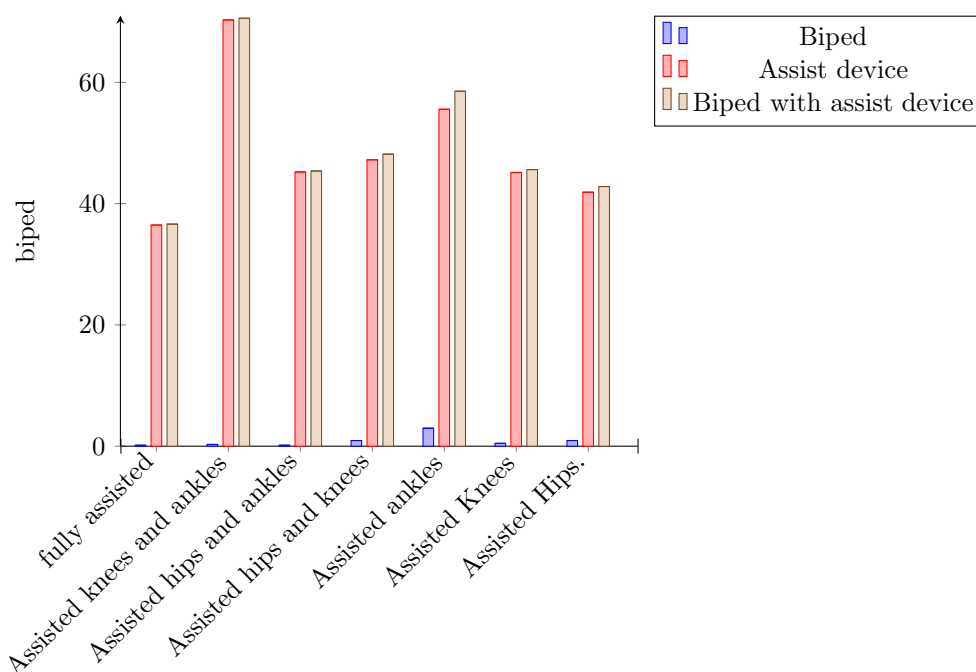

Fig. 11. Cost functional of the biped: Histogram as a function of different distributions for the impulsive torques.

minimization of (19): When the criterion (19) is minimized, the energy cost, provided through the assist device, is logically less than with the minimization of (19) for all the cases. When only the knees are assisted, the energy cost of the biped is important, $25.1012 N.m.rad/s$ while the energy provided through the assistive device is small, $3.6554 N.m.rad/s$. To assist the hips and the knees, the hips and the ankles, the hips and ankles, the knees and ankles, or the hips, the knees, and the ankles does not provide an evident advantage from the point of view of the energy costs of the biped and the assist device. The best compromise is still to assist the hips only.

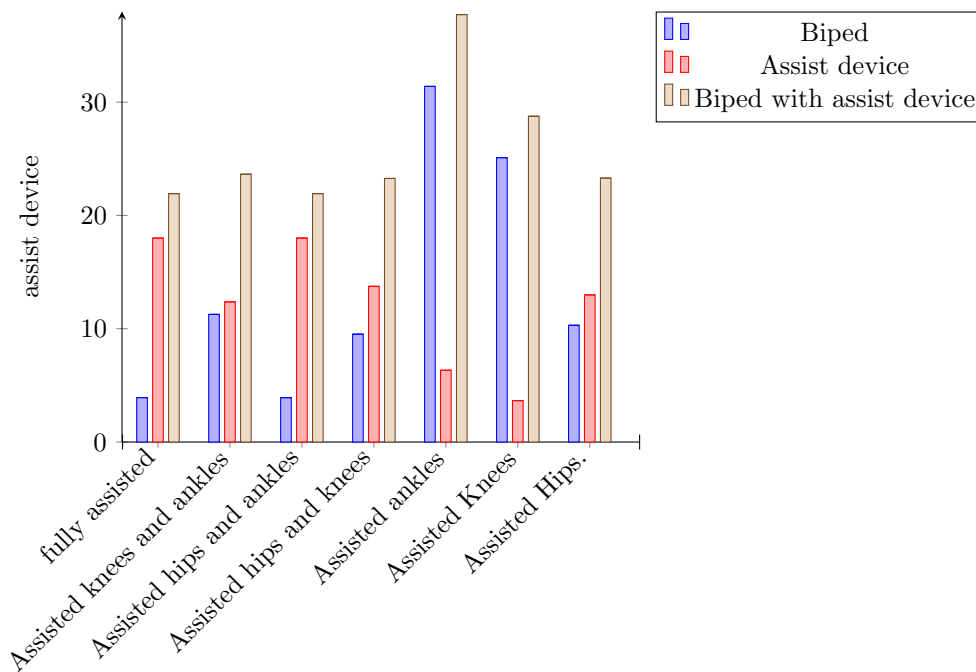

Fig. 12. Global cost functional of the biped and the assist device: Histogram as a function of different distributions for the impulsive torques.

6. Conclusion

A wearable walking assist device with bodyweight support to assist a planar seven-link biped is studied through a ballistic walking motion ended by an impact of the sole of the swing foot, while the rear foot is taking off. This impact is modeled with an instantaneous double support phase. During this instantaneous double support phase several solutions are possible to assist the biped: impulsive torques to assist the hips, knees, or ankles, the hips and knees, knees and ankles, or the hips and ankles, or to assist all the inter-link joints of the locomotor system of the biped. Numerical results show that for a given time period T and a given length L of the walking gait step the fully actuated assist device is the most efficient to help the biped. To preserve energy the impulsive control of hips only is a good compromise. These numerical results are preliminary to develop a new wearable walking assist device designed for uses including industrial applications and for the general public. We consider here a rigid interaction only. For future some elastic links can be considered in the conception to permit a soft contact between the device and the human; their stiffness can be fixed or controlled.

References

1. A. Dollar and H. Herr, "Lower extremity exoskeletons and active orthoses: Challenges and state-of-the-art," *IEEE Trans. on Robotics*, vol. 24, no. 1, pp. 144–158, 2008.
2. D. P. Ferris, G. S. Sawicki, and M. A. Daley, "A physiologist's perspective on robotic exoskeletons for human locomotion," *Int. J. of Humanoid Robotics*, vol. 4, no. 3, pp. 507–528, 2007.
3. J. R. Priebe and R. Kram, "Why is walker-assisted gait metabolically expensive?" *Gait & Posture*, vol. 34, pp. 265–269, 2011.
4. X. Zhang and M. Hashimoto, "Synchronization-based trajectory generation method for a robotic suit using neural oscillators for hip joint support in walking," *Mechatronics*, vol. 22, pp. 33–44, 2012.
5. S. Krut, M. Benoit, E. Dombre, and F. Pierrot, "Moonwalker, a lower limb exoskeleton able to sustain bodyweight using a passive force balancer," in *Proc. IEEE Conf. on Robotics and Automation*, Anchorage, USA, 2010, pp. 2215–2220.
6. Y. Ikeuchi, J. Ashihara, Y. Hiki, H. Kudoh, and T. Noda, "Walking assist device with bodyweight support system," in *Proc. IEEE/RSJ Int. Conf on Intelligent Robots and Systems*, St Louis, USA, 2010, pp. 4073–4079.
7. L. Renquan, Z. Li, C. Su., and A. Xue, "Development and learning control of a human limb with a rehabilitation exoskeleton," *IEEE Trans. on Industrial Electronics*, vol. 61, no. 7, doi 10.1109/TIE.2013.2275903, pp. 3776–3785, 2013.
8. J. Alonso, F. Romero, R. Pàmies-Vilà, U. Lúgrís, and J. M. Font-Llagunes, "A simple approach to estimate muscle forces and or thesis actuation in powered assisted walking of spinal cord-injured subjects," *Multibody System Dynamics*, vol. 28, no. 1-2, pp. 109–124, 2012.
9. H. Kazerooni, "Human augmentation and exoskeleton systems in berkeley," *Int. J. of Humanoid Robotics*, vol. 4, no. 3, pp. 575–605, 2007.
10. J. Rosen and J. C. Perry, "Upper limb powered exoskeleton," *Int. J. of Humanoid Robotics*, vol. 4, no. 3, pp. 529–548, 2007.
11. D. G. Caldwell, N. G. Tsagarakis, S. Kousidou, N. Costa, and I. Sarakoglou, "'soft' exoskeletons for upper and lower body rehabilitation-design, control and testing," *Int. J. of Humanoid Robotics*, vol. 4, no. 3, pp. 549–573, 2007.
12. C. J. Walsh, K. Endo, and H. Herr, "A quasi-passive leg exoskeleton for load-carrying augmentation," *Int. J. of Humanoid Robotics*, vol. 4, no. 3, pp. 487–506, 2007.
13. A. M. Formal'skii, "Motion of anthropomorphic biped under impulsive control," in *Proc. of Institute of Mechanics, Moscow State Lomonosov University: "Some Questions of Robot's Mechanics and Biomechanics"*, 1978, (In Russian), pp. 17–34.
14. A. M. Formalskii, *Locomotion of Anthropomorphic Mechanisms*. [In Russian], Nauka, Moscow, Russia, 1982.
15. A. M. Formal'skii, "Ballistic walking design via impulsive control," *ASCE, Journal of Aerospace Engineering*, vol. 23, no. 2, pp. 129–138, 2010.
16. S. Mochon and T. McMahon, "Ballistic walking: An improved model," *Mathematical Bio-sciences*, vol. 52, pp. 241–260, 1981.
17. T. McGeer, "Passive dynamic walking," *International Journal of Robotics Research*, vol. 9, no. 2, pp. 62–82, 1990.
18. F. Asano and Z. W. Luo, "Efficiency and symmetry of ballistic gait," in *IEEE/RSJ. Int. Conf. on Intelligent Robots and Systems*, Nice, France, 2008, pp. 2928–2933.
19. Y. Aoustin and A. M. Formalskii, "3d walking biped: optimal swing swing of the arms," *Multibody System Dynamics*, vol. 32, no. 1, pp. 55–66, 2013.
20. C. Chevallereau, A. Formal'skii, and B. Perrin, "Low energy cost reference trajectories for a biped robot," in *Proc. of the IEEE Conf. on Robotics and Automation*, vol. 2,

20 Y. Aoustin

- 1998, pp. 1088–1094.
21. W. Khalil and E. Dombre, *Modeling, identification and control of robots*. Butterworth Heinemann, 2002.
 22. P. Appell, *Dynamique des Systèmes - Mécanique Analytique*. Paris, P. Gauthiers-Villars, 1931.
 23. Y. Aoustin and A. Hamon, “Human like trajectory generation for a biped robot with a four-bar linkage for the knees,” *Robotics and Autonomous Systems*, vol. 61, no. 12, pp. 1717–1725, 2013.
 24. Y. Hurmuzlu and T.-H. Chang, “Rigid body collisions of a special class of planar kinematic chains,” *IEEE Transactions on systems, man and cybernetics*, vol. 22, no. 5, pp. 964–971, 1992.
 25. A. Formal’skii, C. Chevallereau, and B. Perrin, “On ballistic walking locomotion of a quadruped,” *Int. J. of Robotics Research*, vol. 19, no. 8, pp. 743–761, 2000.
 26. P. H. Channon, S. H. Hopkins, and D. T. Pham, “Derivation of optimal walking motions for a bipedal walking robot,” *Robotica*, vol. 10, no. 3, pp. 165–172, 1992.
 27. P. Gill, W. Murray, and M. Wright, *Practical optimization*. London: Academic Press, 1981.
 28. M. Powell, *Variable metric methods for constrained optimization*, ser. Lecture Notes in Mathematics. Springer Berlin / Heidelberg, 1977, pp. 62–72.
 29. M. Vukobratovic and B. Borovac, “Zero-moment point—thirty five years of its life,” *Int. J. of Humanoid Robotics*, vol. 1, no. 1, pp. 157–173, 2004.
 30. D. H. Sutherland, K. R. Kaufman, and J. R. Moitza, *Kinematics of normal human gait*. Human Walking, Eds. Jessica Rose and James G. Gamble, Williams and Wilkins, 349p, 1994.
 31. C. L. Vaughan, B. L. Davis, and J. C. O’Connor, *Dynamic of humain gait*. Kiboho Publishers, Cape Town, South Africa, 1999.

Appendix: Expressions of the closed-loop geometric constraints, their first and second time derivatives

Let us write both vectorial equations $\mathbf{AB} + \mathbf{BC}' = \mathbf{AD} + \mathbf{DC}''$ and $\mathbf{AB} + \mathbf{BE}' = \mathbf{AF} + \mathbf{FE}''$ from Figure 1(b). With this vectorial equality, three scalar equations of the closed-loop geometric constraints for each loop are respectively defined as follows:

$$\begin{aligned}
 -l_s \sin q_1 - l_t \sin q_2 + l_3 \sin q_5 + \frac{l_1}{2} \sin q_{92} + l_2 \sin q_8 + \frac{l_1}{2} \sin q_{91} &= 0, \\
 l_s \cos q_1 + l_t \cos q_2 - l_3 \cos q_5 - \frac{l_1}{2} \cos q_{92} - l_2 \cos q_8 - \frac{l_1}{2} \cos q_{91} &= 0, \quad (20)
 \end{aligned}$$

$$q_{91} = q_{92},$$

$$\begin{aligned}
 -l_s \sin q_4 - l_t \sin q_3 + l_3 \sin q_5 + \frac{l_1}{2} \sin q_{102} + l_2 \sin q_{11} + \frac{l_1}{2} \sin q_{101} &= 0, \\
 l_s \cos q_4 + l_t \cos q_3 - l_3 \cos q_5 - \frac{l_1}{2} \cos q_{102} - l_2 \cos q_{11} - \frac{l_1}{2} \cos q_{101} &= 0, \quad (21)
 \end{aligned}$$

$$q_{101} = q_{102}.$$

Their first time derivatives for each loop are respectively:

$$\begin{aligned}
 -l_s \dot{q}_1 \cos q_1 - l_t \dot{q}_2 \cos q_2 + l_3 \dot{q}_5 \cos q_5 + \frac{l_1}{2} \dot{q}_{92} \cos q_{92} + l_2 \dot{q}_8 \cos q_8 + \frac{l_1}{2} \dot{q}_{91} \cos q_{91} &= 0, \\
 -l_s \dot{q}_1 \sin q_1 - l_t \dot{q}_2 \sin q_2 + l_3 \dot{q}_5 \sin q_5 + \frac{l_1}{2} \dot{q}_{92} \sin q_{92} + l_2 \dot{q}_8 \sin q_8 + \frac{l_1}{2} \dot{q}_{91} \sin q_{91} &= 0, \\
 \dot{q}_{91} &= \dot{q}_{92},
 \end{aligned} \tag{22}$$

$$\begin{aligned}
 -l_s \dot{q}_4 \cos q_4 - l_t \dot{q}_3 \cos q_3 + l_3 \dot{q}_5 \cos q_5 + \frac{l_1}{2} \dot{q}_{102} \cos q_{102} + l_2 \dot{q}_{11} \cos q_{11} + \frac{l_1}{2} \dot{q}_{101} \cos q_{101} &= 0, \\
 -l_s \dot{q}_4 \sin q_4 - l_t \dot{q}_3 \sin q_3 + l_3 \dot{q}_5 \sin q_5 + \frac{l_1}{2} \dot{q}_{102} \sin q_{102} + l_2 \dot{q}_{11} \sin q_{11} + \frac{l_1}{2} \dot{q}_{101} \sin q_{101} &= 0, \\
 \dot{q}_{101} &= \dot{q}_{102}.
 \end{aligned} \tag{23}$$

Finally, their second time derivatives for each loop are respectively:

$$\begin{aligned}
 -l_s \ddot{q}_1 \cos q_1 - l_t \ddot{q}_2 \cos q_2 + l_3 \ddot{q}_5 \cos q_5 + \frac{l_1}{2} \ddot{q}_{92} \cos q_{92} + l_2 \ddot{q}_8 \cos q_8 + \frac{l_1}{2} \ddot{q}_{91} \cos q_{91} \\
 + l_s \dot{q}_1^2 \sin q_1 + l_t \dot{q}_2^2 \sin q_2 - l_3 \dot{q}_5^2 \sin q_5 - \frac{l_1}{2} \dot{q}_{92}^2 \sin q_{92} - l_2 \dot{q}_8^2 \sin q_8 - \frac{l_1}{2} \dot{q}_{91}^2 \sin q_{91} &= 0, \\
 -l_s \ddot{q}_1 \sin q_1 - l_t \ddot{q}_2 \sin q_2 + l_3 \ddot{q}_5 \sin q_5 + \frac{l_1}{2} \ddot{q}_{92} \sin q_{92} + l_2 \ddot{q}_8 \sin q_8 + \frac{l_1}{2} \ddot{q}_{91} \sin q_{91} \\
 -l_s \dot{q}_1^2 \cos q_1 - l_t \dot{q}_2^2 \cos q_2 + l_3 \dot{q}_5^2 \cos q_5 + \frac{l_1}{2} \dot{q}_{92}^2 \cos q_{92} + l_2 \dot{q}_8^2 \cos q_8 + \frac{l_1}{2} \dot{q}_{91}^2 \cos q_{91} &= 0, \\
 \ddot{q}_{91} &= \ddot{q}_{92},
 \end{aligned} \tag{24}$$

$$\begin{aligned}
 -l_s \ddot{q}_4 \cos q_4 - l_t \ddot{q}_3 \cos q_3 + l_3 \ddot{q}_5 \cos q_5 + \frac{l_1}{2} \ddot{q}_{102} \cos q_{102} + \\
 l_2 \ddot{q}_{11} \cos q_{11} + \frac{l_1}{2} \ddot{q}_{91} \cos q_{91} + l_s \dot{q}_4^2 \sin q_4 + l_t \dot{q}_3^2 \sin q_3 - \\
 l_3 \dot{q}_5^2 \sin q_5 - \frac{l_1}{2} \dot{q}_{102}^2 \sin q_{102} - l_2 \dot{q}_{11}^2 \sin q_{11} - \frac{l_1}{2} \dot{q}_{91}^2 \sin q_{91} &= 0, \\
 -l_s \ddot{q}_4 \sin q_4 - l_t \ddot{q}_3 \sin q_3 + l_3 \ddot{q}_5 \sin q_5 + \frac{l_1}{2} \ddot{q}_{102} \sin q_{102} + \\
 l_2 \ddot{q}_{11} \sin q_{11} + \frac{l_1}{2} \ddot{q}_{91} \sin q_{91} - l_s \dot{q}_4^2 \cos q_4 - l_t \dot{q}_3^2 \cos q_3 + \\
 l_3 \dot{q}_5^2 \cos q_5 + \frac{l_1}{2} \dot{q}_{102}^2 \cos q_{102} + l_2 \dot{q}_{11}^2 \cos q_{11} + \frac{l_1}{2} \dot{q}_{91}^2 \cos q_{91} &= 0, \\
 \ddot{q}_{101} &= \ddot{q}_{102}.
 \end{aligned} \tag{25}$$